

LOW IMPEDANCE WITH W FILTER
MODEL 120C 500V

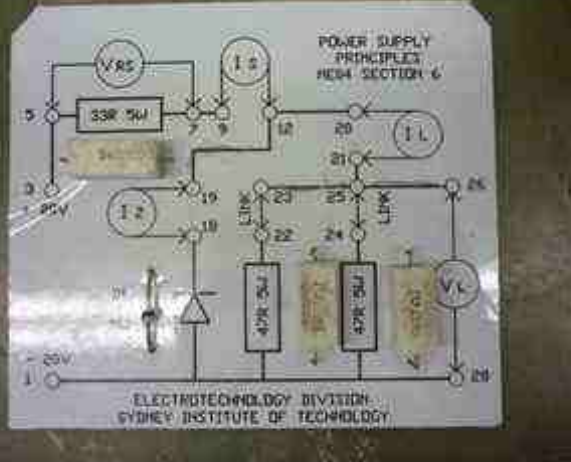

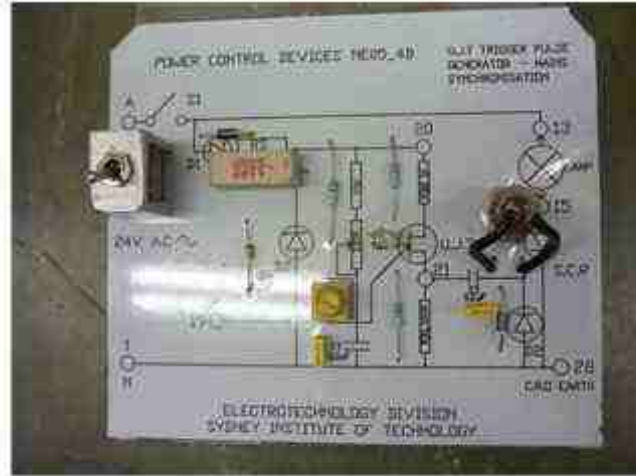

Page 145 Power supply principle



Page 146 Trigger pulse generator main synchronization

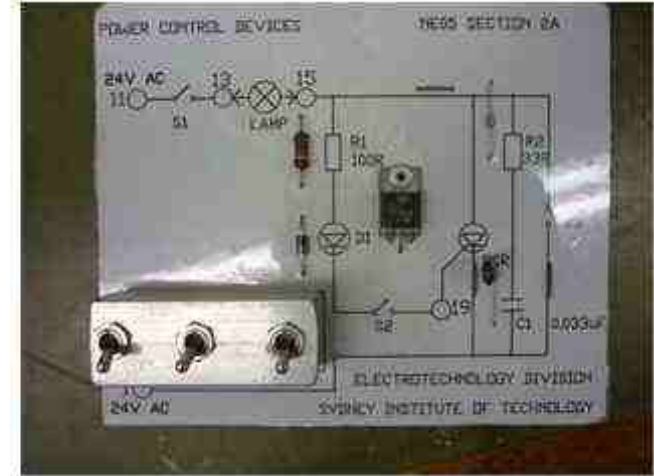

Page 147 SCR



Page 149 Operational unit



Page 150 AC compensation unit



Page 151 Modulator de-modulator unit

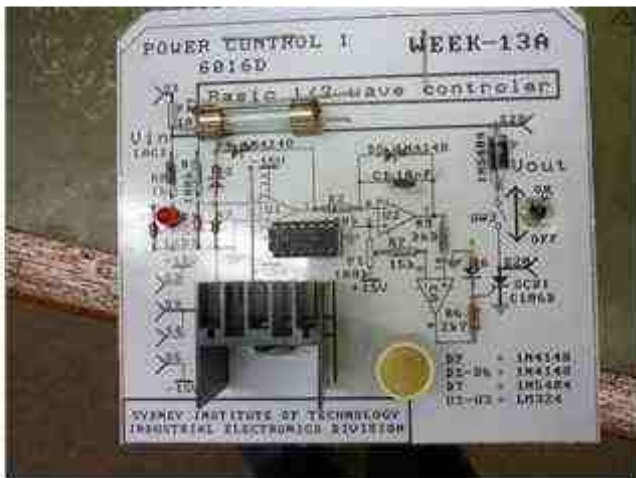

Page 152 1/2 wave regulator



Page 154 AC compensation unit

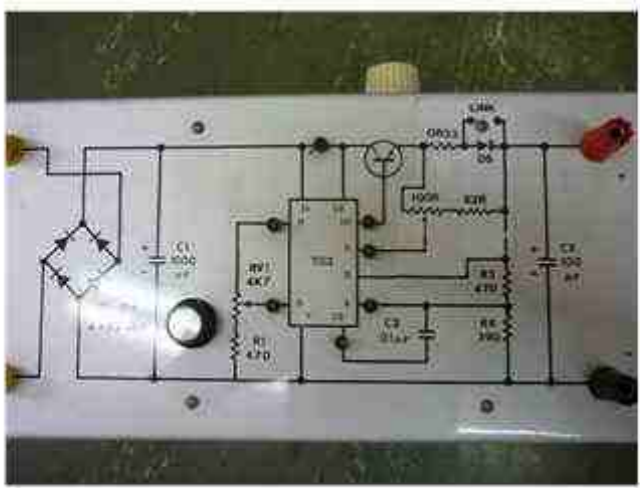

Page 155 Power supply



Page 157 Switches



Page 158 Lamp load



Page 159 Capacitor Resistor Diode

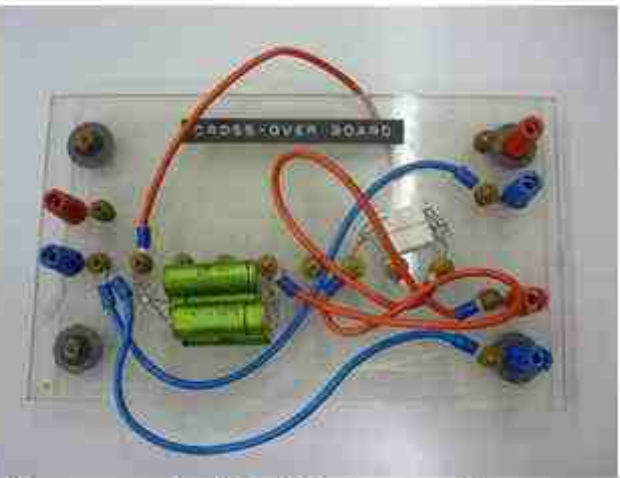

Page 160 Capacitor

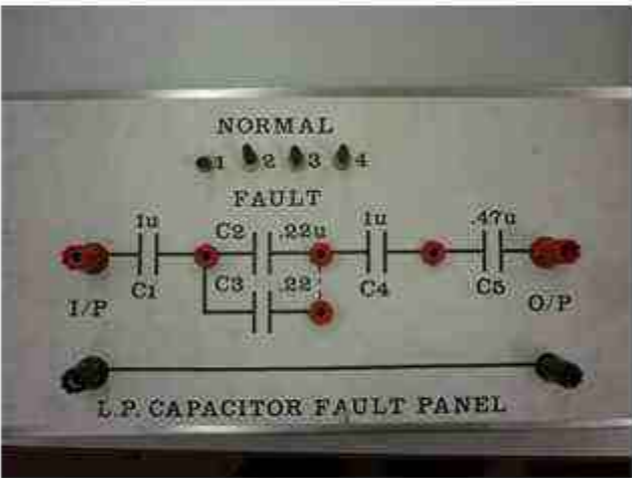

Page 161 Capacitor



Page 161 Lamp

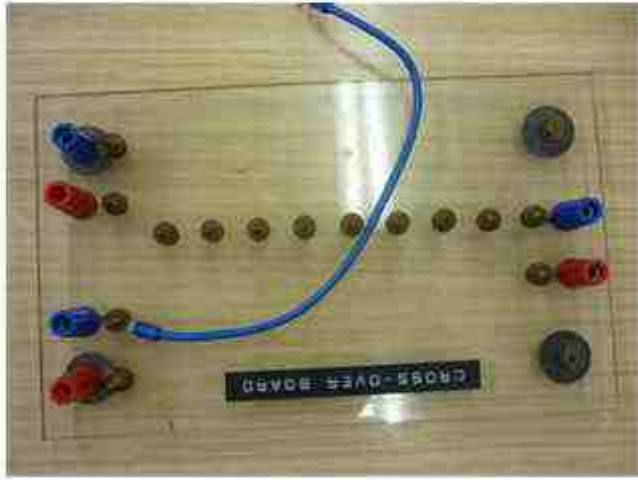

Page 163 Neutral link connection



Page 164 Tee, Pi line model



Page 165 Resistor 0.1 ohm, 100 ohm 5000 ohm



Page 166 One ohm resistor



Page 171 Combination Instrument

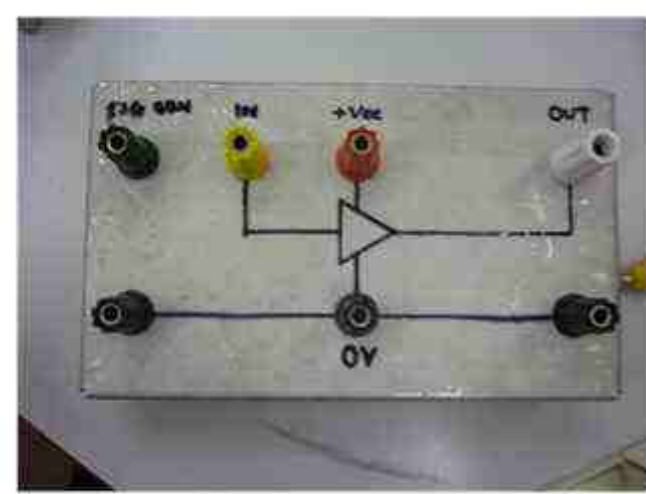

Page 177 Operational amplifier

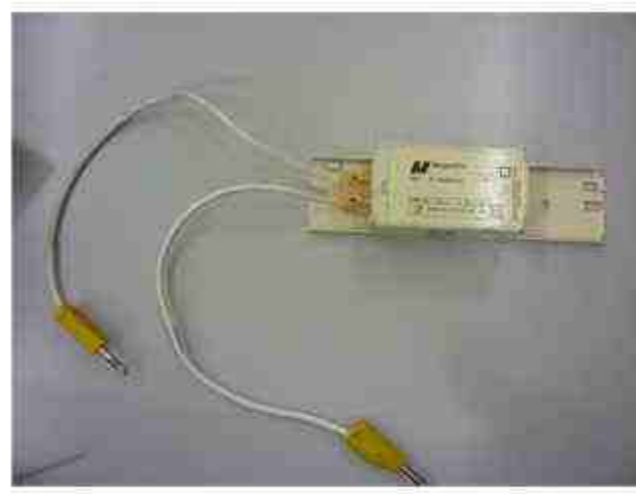

Page 178 Choke

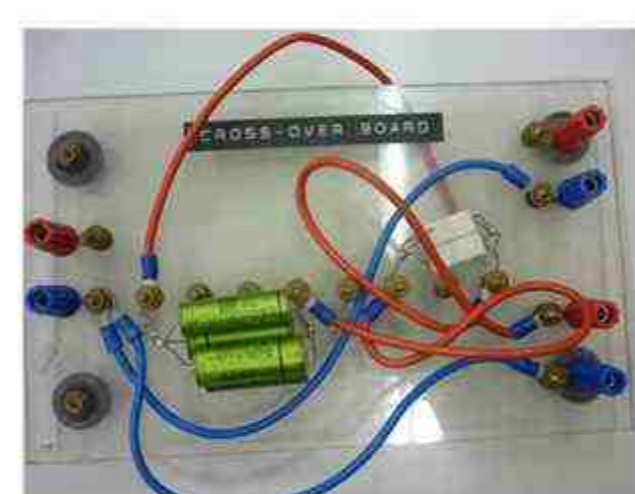

Page 179 Cross over board



Page 184 AC Syn Motor



Page 189 Mini lab



Page 193 Coil



Page 195 DC motor

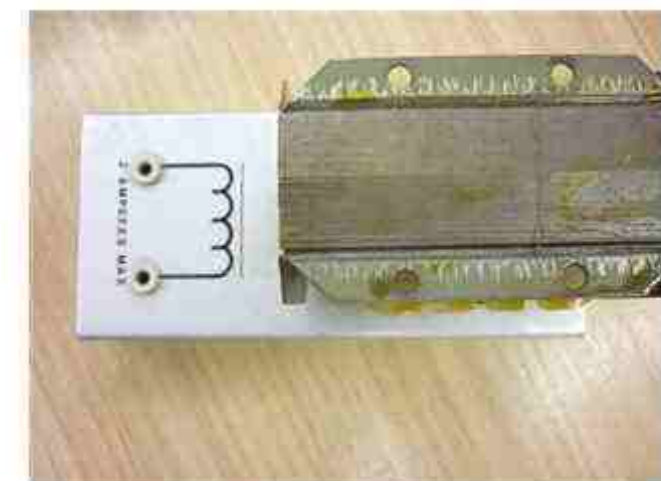

Page 196 Coil

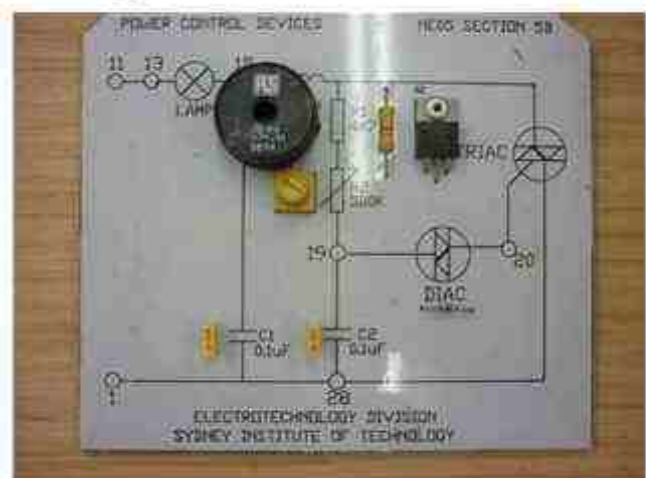

Page 222 Diac+Triac

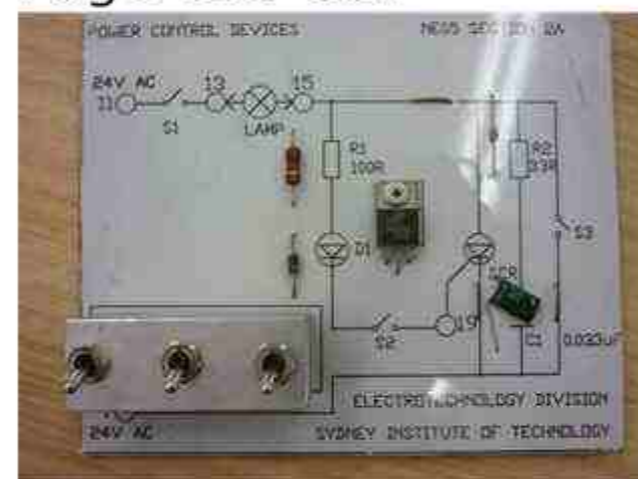

Page 224 SCR

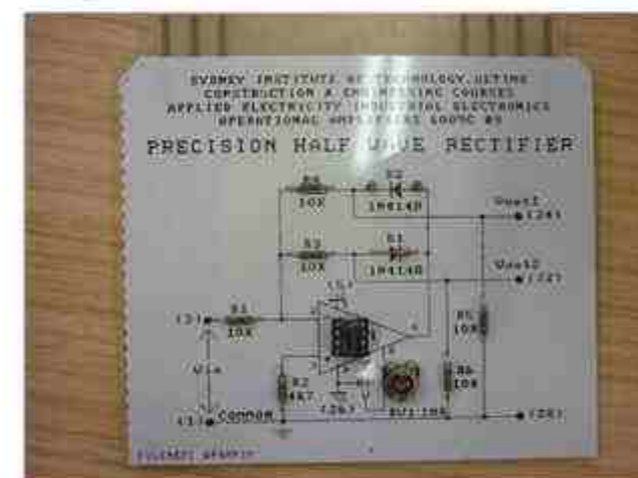

Page 229 Precision 1/2 wave rectifier



Page 238 VF Drive



Page 240 VF Drive



Page 241 Three Phase motor



Page 251 Resistor 390Ω



Page 253 Resistor 560Ω



Page 254 Lamp 12V



Page 255 Resistor panel



Page 257 Ammeter



Page 260 Regulated power supply



Page 256 Voltmeter



Page 265 Isolation transformer



Page 261 Dual function generator



Page 266 Decade capacitor



Page 269 Variable resistor +test panel

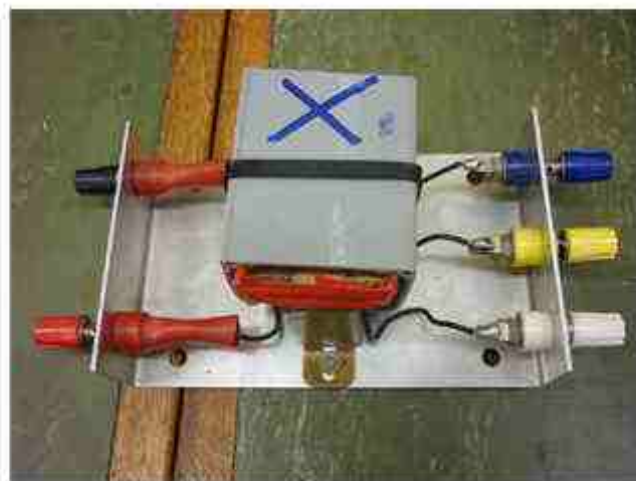

Page 270 Single phase transformer 240/24V

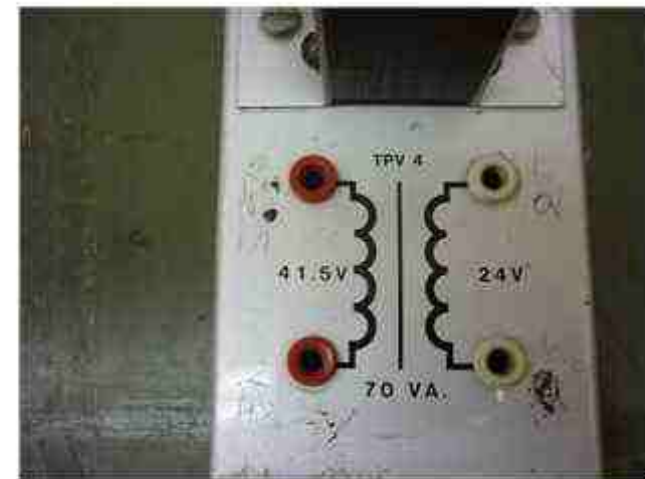

Page 275 Single phase transformer 41.5/24V



Page 278 Coil



Page 284 UG cable



Page 285 Line insulator



Page 289 Pin insulator

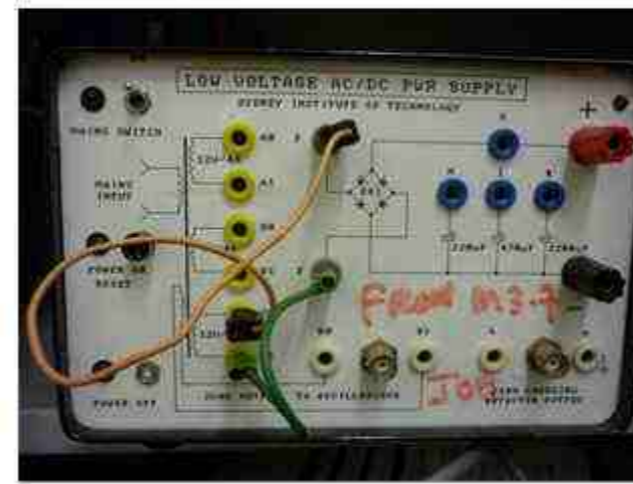

Page 292 AC-DC Rectifier



Page 295 Digital Trainer



Page 295 to 305 Digital trainer



Page 318 CT

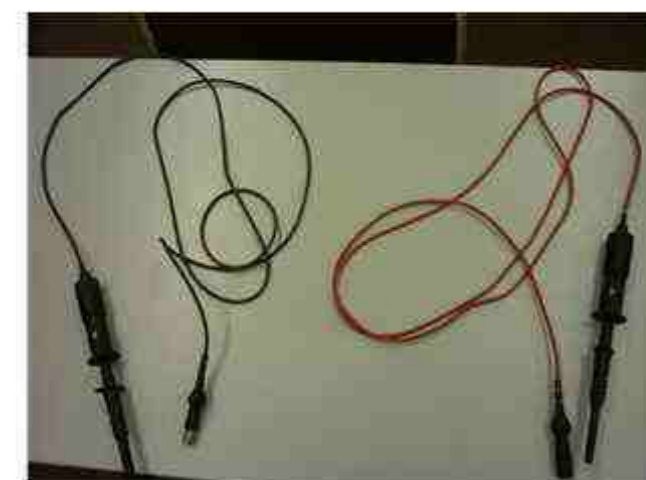

Page 314 Test probe

Page 328 Overcurrent Relay

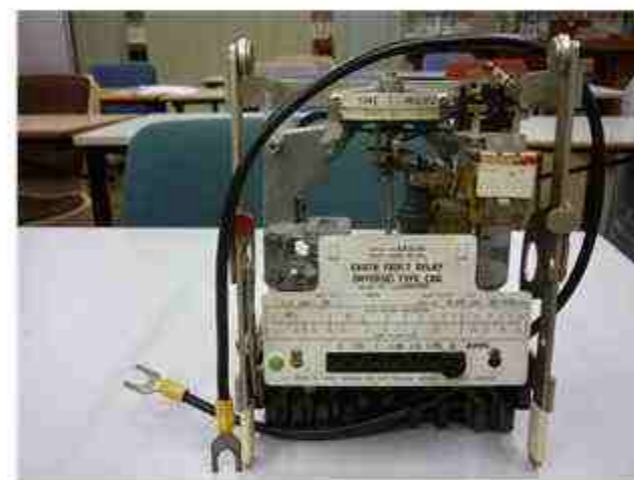

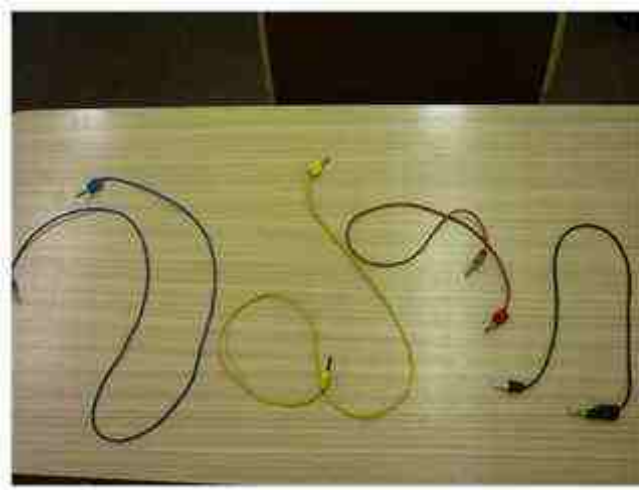

Page 315 Connector

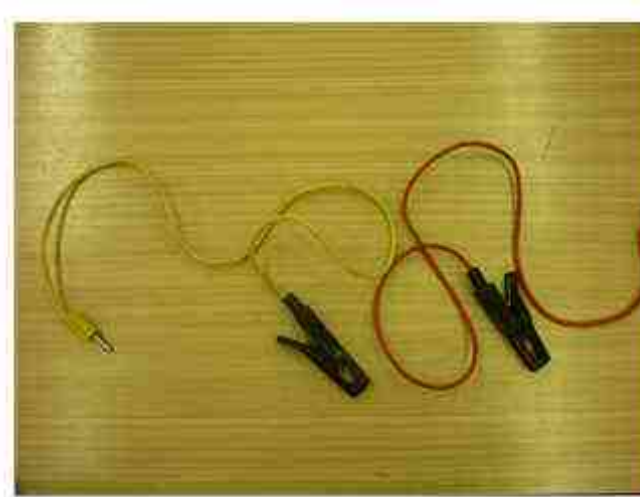

Page 341 Grip



Page 355 Electronic relay



Page 355 Electronic relay



Switch panel



Supply



Three phase transformer terminal

Meter panel





Page 1 DC Power Supply



Page 2 Digital multimeter

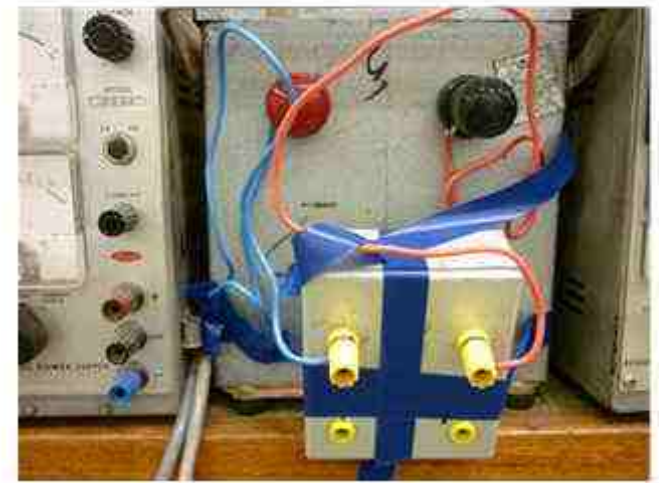

Page 3-AC 12V supply



Page 4-Oscilloscope



Page 6 Isolation transformer



Page 8-Regulated DC supply



Page 9 Three phase 41.5/24V supply



Page 11 Varic 0 to 300V



Page 13 Power Scope



Page 15 Function generator



Page 16 DC Power Supply 30V



Page 17 Variable resistor



Page 18 Fault finding+Resistors



Page 19 Rheostat



Page 23 Step Resistors



Page 30 Parallel resistors



Page 33 Series resistors



Page 35 Transformer panel



Page 37 Decade resistor



Page 39 Inductor box



Page 40 Resistor



Page 42 Rectifier diode



Page 43 Sequence meter



Page 44 Variable resistor

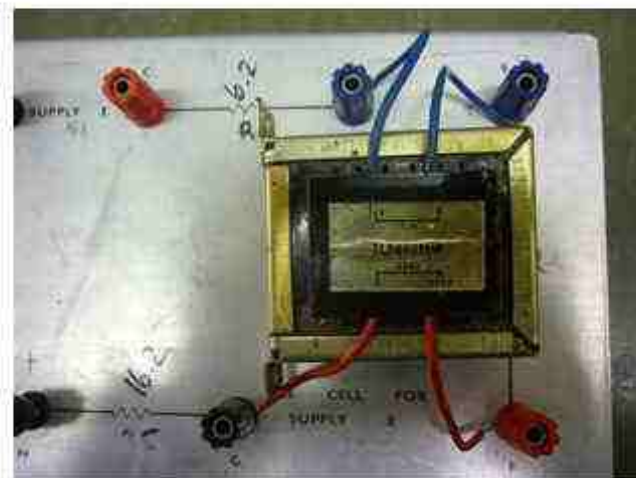

Page 47 Coil



Page 49 UG Cable



Page 50 Load resistor



Page 52 Decade inductor

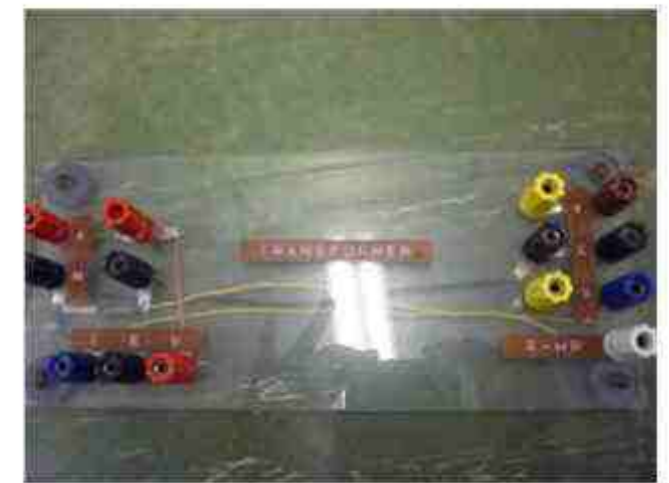

Page 53 Connection



Page 55 Over current relay

Page 59 Voltage regulator

Page 60 Ammeter

Page 61 Volt meter

Page 63 Three Phase Transformer

Page 64 Mutual inductance

Page 66 Generator model

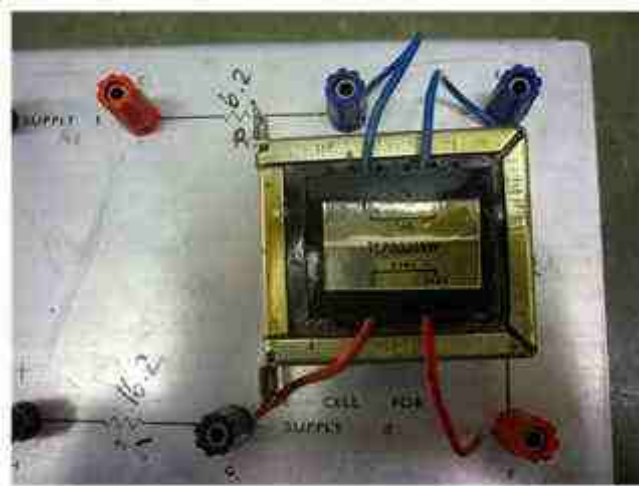

Page 45 Transformer 200/16V



Page 49 UG cable



Page 50 Load resistor



Page 52 Decade inductor



Page 53 Connection



Page 55 Over current relay



Page 55 Over current relay



Page 57 Varic



Page 60 Ammeter

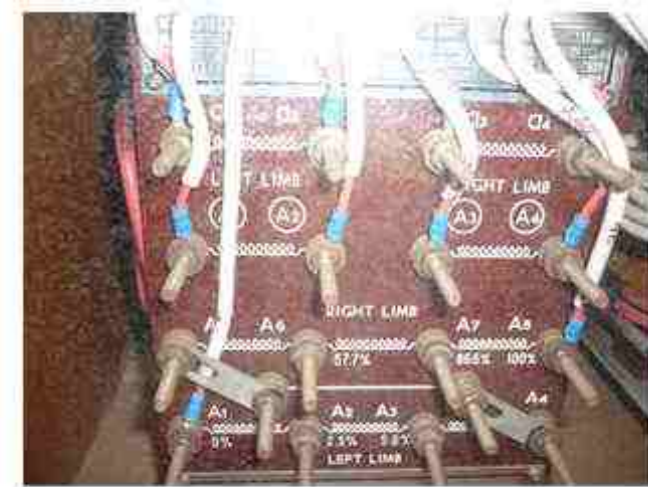

Page 64 Mutual Inductance



Page 66 Generator model

Page 67 Main switch



Page 68 Main switch



Page 70 Multi meter



Page 71 Current Transformer



Page 76 DC Ammeter



Page 78 Resistor plug



Page 81 SCR

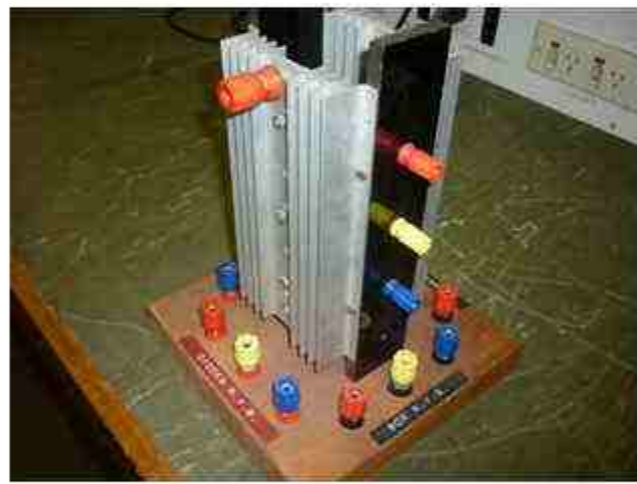

Page 91 Power Diode



Page 101 Connector

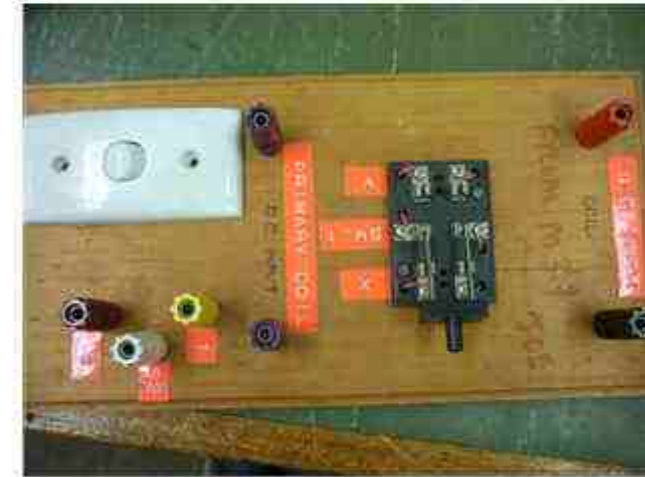

Page 103 Knife switch



Page 106 Power resistor



Page 108 Small transformer



Page 110 Watt meter



Page 117 Wheatstone bridge



Page 121 Function Generator Feedback



Page 124 Multimeter



Page 126 Current probe



Page 130 Power analyzer



Page 176 Electronic Test board

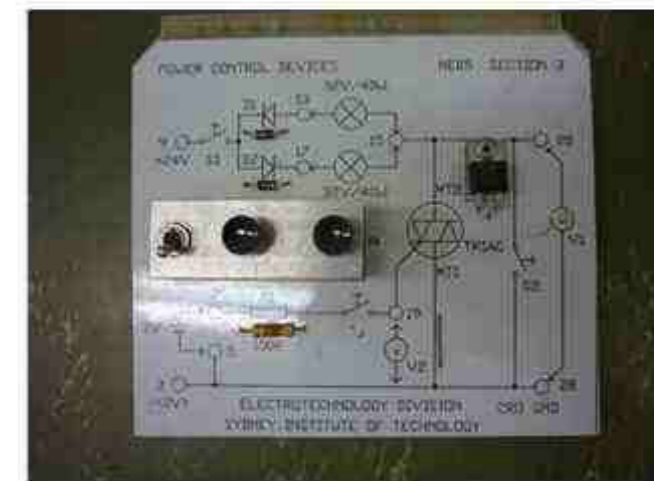

Page 134 SCR Power Control device

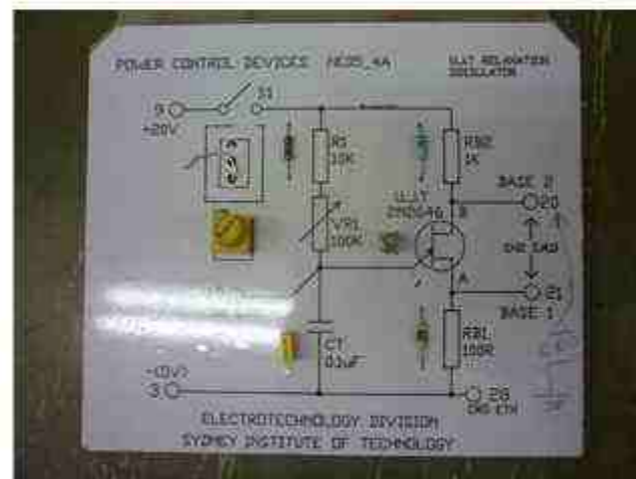

Page 131 UJT Relaxation Oscillator

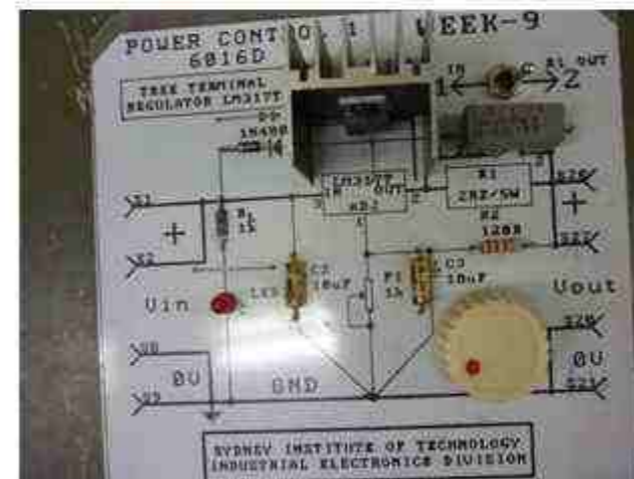

Page 137 Three terminals regulator



Page 138 Test lamp

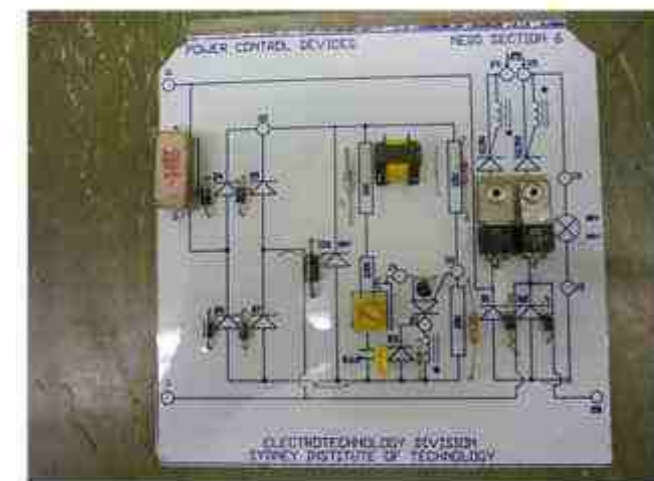

Page 139 Power control device

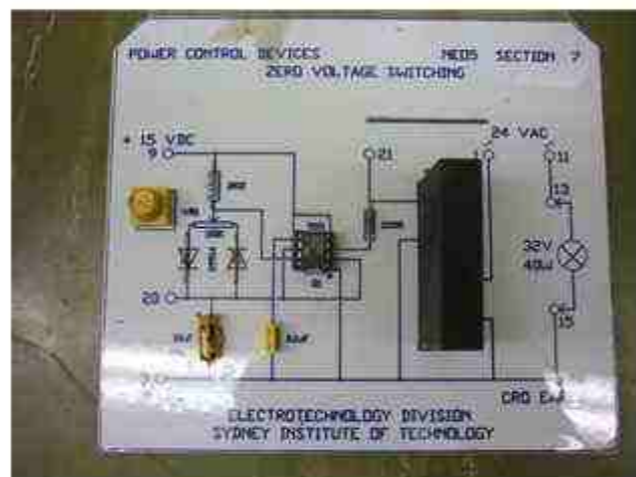

Page 140 Zero voltage switching

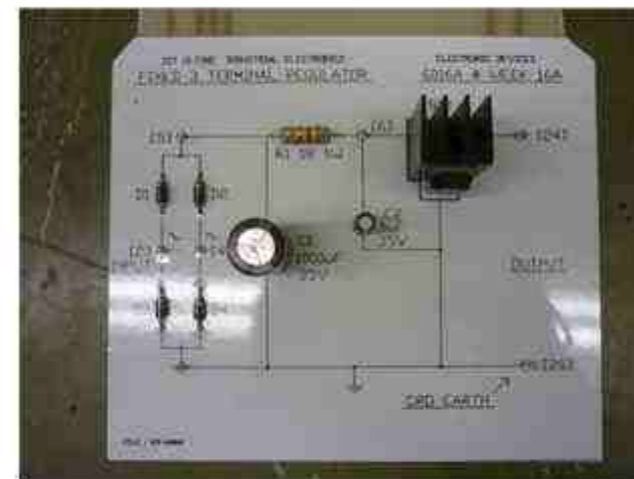

Page 141 Three terminals regulator

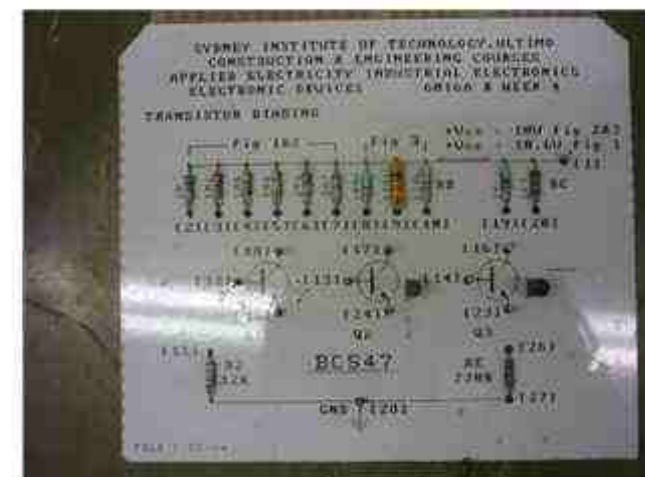

Page 143 Transistor biasing