

Engineering Fluid Mechanics

T. Al-Shemmeri



Download free books at

bookboon.com

T. Al-Shemmeri

Engineering Fluid Mechanics

Engineering Fluid Mechanics
© 2012 T. Al-Shemmeri & Ventus Publishing ApS
ISBN 978-87-403-0114-4

Contents

	Notation	7
1	Fluid Statics	14
1.1	Fluid Properties	14
1.2	Pascal's Law	21
1.3	Fluid-Static Law	21
1.4	Pressure Measurement	24
1.5	Centre of pressure & the Metacentre	29
1.6	Resultant Force and Centre of Pressure on a Curved Surface in a Static Fluid	34
1.7	Buoyancy	37
1.8	Stability of floating bodies	40
1.9	Tutorial problems	45
2	Internal Fluid Flow	47
2.1	Definitions	47
2.2	Conservation of Mass	50
2.3	Conservation of Energy	52
2.4	Flow Measurement	54
2.5	Flow Regimes	58

Please click the advert



 **OLIVER WYMAN**



Oliver Wyman is a leading global management consulting firm that combines deep industry knowledge with specialized expertise in strategy, operations, risk management, organizational transformation, and leadership development. With offices in 50+ cities across 25 countries, Oliver Wyman works with the CEOs and executive teams of Global 1000 companies.
An equal opportunity employer.

GET THERE FASTER

Some people know precisely where they want to go. Others seek the adventure of discovering uncharted territory. Whatever you want your professional journey to be, you'll find what you're looking for at Oliver Wyman.

Discover the world of Oliver Wyman at oliverwyman.com/careers



2.6	Darcy Formula	59
2.7	The Friction factor and Moody diagram	60
2.8	Flow Obstruction Losses	64
2.9	Fluid Power	65
2.10	Fluid Momentum	67
2.11	Tutorial Problems	75
3	External Fluid Flow	77
3.1	Regimes of External Flow	77
3.2	Drag Coefficient	78
3.3	The Boundary Layer	79
3.4	Worked Examples	81
3.5	Tutorial Problems	91
4	Compressible Fluid Dynamics	93
4.1	Compressible flow definitions	93
4.2	Derivation of the Speed of sound in fluids	94
4.3	The Mach number	96
4.4	Compressibility Factor	99
4.5	Energy equation for frictionless adiabatic gas processes	102
4.6	Stagnation properties of compressible flow	106
4.7	Worked Examples	109
4.8	Tutorial Problems - Compressible Flow	114

Please click the advert

Day one
and you're ready

Day one. It's the moment you've been waiting for. When you prove your worth, meet new challenges, and go looking for the next one. It's when your dreams take shape. And your expectations can be exceeded. From the day you join us, we're committed to helping you achieve your potential. So, whether your career lies in assurance, tax, transaction, advisory or core business services, shouldn't your day one be at Ernst & Young?

What's next for your future?
ey.com/careers

ERNST & YOUNG
Quality In Everything We Do

© 2010 EYGM Limited. All Rights Reserved.

5	Hydroelectric Power	116
5.1	Introduction	117
5.2	Types of hydraulic turbines	117
5.3	Performance evaluation of Hydraulic Turbines	121
5.4	Pumped storage hydroelectricity	123
5.5	Worked Examples	127
5.7	Tutorial Problems	130
	Sample Examination paper	131
	Formulae Sheet	140

Please click the advert



Hellmann's is one of Unilever's oldest brands having been popular for over 100 years. If you too share a passion for discovery and innovation we will give you the tools and opportunities to provide you with a challenging career. Are you a great scientist who would like to be at the forefront of scientific innovations and developments? Then you will enjoy a career within Unilever Research & Development. For challenging job opportunities, please visit www.unilever.com/rdjobs.

Could it be 
Unilever



Notation

Symbol	definition	units
A	area	m^2
D	diameter	m
F	force	N
g	gravitational acceleration	m/s^2
h	head or height	m
L	length	m
m	mass	kg
P	pressure	Pa or N/m^2
ΔP	pressure difference	Pa or N/m^2
Q	volume flow rate	m^3/s
r	radius	m
t	time	s
V	velocity	m/s
z	height above arbitrary datum	m

Subscripts

a	atmospheric
c	cross-sectional
f	pipe friction
o	obstruction
p	pump
r	relative
s	surface
t	turbine
x	x-direction
y	y-direction
z	elevation

Dimensionless numbers

C_d	discharge coefficient
f	friction factor (pipes)
K	obstruction loss factor
k	friction coefficient (blades)
Re	Reynolds number

Greek symbols

θ, α, ϕ	angle	degrees
μ	dynamic viscosity	kg/ms
ν	kinematics viscosity	m ² /s
ρ	density	kg/m ³
τ	shear stress	N/m ²
η	efficiency	%

Dimensions and Units

Any physical situation, whether it involves a single object or a complete system, can be described in terms of a number of recognisable properties which the object or system possesses. For example, a moving object could be described in terms of its mass, length, area or volume, velocity and acceleration. Its temperature or electrical properties might also be of interest, while other properties - such as density and viscosity of the medium through which it moves - would also be of importance, since they would affect its motion. These measurable properties used to describe the physical state of the body or system are known as its variables, some of which are basic such as length and time, others are derived such as velocity. Each variable has units to describe the magnitude of that quantity. Lengths in SI units are described in units of meters. The "Meter" is the unit of the dimension of length (L); hence the area will have dimension of L², and volume L³. Time will have units of seconds (T), hence velocity is a derived quantity with dimensions of (LT⁻¹) and units of meter per second. A list of some variables is given in Table 1 with their units and dimensions.

Definitions of Some Basic SI Units

Mass: The kilogram is the mass of a platinum-iridium cylinder kept at Sevres in France.

Length: The metre is now defined as being equal to 1 650 763.73 wavelengths in vacuum of the orange line emitted by the Krypton-86 atom.

Time: The second is defined as the fraction 1/31 556 925.975 of the tropical year for 1900. The second is also declared to be the interval occupied by 9 192 631 770 cycles of the radiation of the caesium atom corresponding to the transition between two closely spaced ground state energy levels.

Temperature: The Kelvin is the degree interval on the thermodynamic scale on which the temperature of the triple point of water is 273.16 K exactly. (The temperature of the ice point is 273.15 K).

Definitions of Some Derived SI Units**Force:**

The Newton is that force which, when acting on a mass of one kilogram gives it an acceleration of one metre per second per second.

Work Energy, and Heat:

The joule is the work done by a force of one Newton when its point of application is moved through a distance of one metre in the direction of the force. The same unit is used for the measurement of every kind of energy including quantity of heat. The Newton metre, the joule and the watt second are identical in value. It is recommended that the Newton is kept for the measurement of torque or moment and the joule or watt second is used for quantities of work or energy.

Quantity	Unit	Symbol
Length [L]	Metre	m
Mass [m]	Kilogram	kg
Time [t]	Second	s
Electric current [I]	Ampere	A
Temperature [T]	degree Kelvin	K
Luminous intensity [Iv]	Candela	cd

Table 1: Basic SI Units

Quantity	Unit	Symbol	Derivation
Force [F]	Newton	N	kg-m/s ²
Work, energy [E]	joule	J	N-m
Power [P]	watt	W	J/s
Pressure [p]	Pascal	Pa	N/m ²

Table 2: Derived Units with Special Names

Quantity	Symbol
Area	m ²
Volume	m ³
Density	kg/m ³
Angular acceleration	rad/s ²
Velocity	m/s
Pressure, stress	N/m ²
Kinematic viscosity	m ² /s
Dynamic viscosity	N-s/m ²
Momentum	kg-m/s
Kinetic energy	kg-m ² /s ²
Specific enthalpy	J/kg
Specific entropy	J/kg K

Table 3: Some Examples of Other Derived SI Units

Quantity	Unit	Symbol	Derivation
Time	minute	min	60 s
Time	hour	h	3.6 ks
Temperature	degree Celsius	°C	K - 273.15
Angle	degree	°	$\pi/180$ rad
Volume	litre	l	10^{-3} m^3 or dm^3
Speed	kilometre per hour	km/h	-
Angular speed	revolution per minute	rev/min	-
Frequency	hertz	Hz	cycle/s
Pressure	bar	b	10^2 kN/m^2
Kinematic viscosity	stoke	St	$100 \text{ mm}^2/\text{s}$
Dynamic viscosity	poise	P	$100 \text{ mN}\cdot\text{s}/\text{m}^2$

Table 4: Non-SI Units

Please click the advert



360°
thinking.

Deloitte.

Discover the truth at www.deloitte.ca/careers

© Deloitte & Touche LLP and affiliated entities.

Name	Symbol	Factor	Number
exa	E	10^{18}	1,000,000,000,000,000,000
Peta	P	10^{15}	1,000,000,000,000,000
tera	T	10^{12}	1,000,000,000,000
giga	G	10^9	1,000,000,000
mega	M	10^6	1,000,000
kilo	k	10^3	1,000
hecto	h	10^2	100
deca	da	10	10
deci	d	10^{-1}	0.1
centi	c	10^{-2}	0.01
milli	m	10^{-3}	0.001
micro	μ	10^{-6}	0.000001
nano	n	10^{-9}	0.000000001
pico	p	10^{-12}	0.000000000001
fempto	f	10^{-15}	0.000000000000001
atto	a	10^{-18}	0.000000000000000001

Table 5: Multiples of Units

item	conversion
Length	1 in = 25.4 mm 1 ft = 0.3048 m 1 yd = 0.9144 m 1 mile = 1.609 km
Mass	1 lb. = 0.4536 kg (0.453 592 37 exactly)
Area	1 in ² = 645.2 mm ² 1 ft ² = 0.092 90 m ² 1 yd ² = 0.8361 m ² 1 acre = 4047 m ²
Volume	1 in ³ = 16.39 cm ³ 1 ft ³ = 0.028 32 m ³ = 28.32 litre 1 yd ³ = 0.7646 m ³ = 764.6 litre 1 UK gallon = 4.546 litre 1 US gallon = 3.785 litre
Force, Weight	1 lbf = 4.448 N
Density	1 lb/ft ³ = 16.02 kg/m ³

Velocity	1 km/h = 0.2778 m/s 1 ft/s = 0.3048 m/s 1 mile/h = 0.4470 m/s = 1.609 km/h
Pressure, Stress	1000 Pa = 1000 N/m ² = 0.01 bar 1 in H ₂ O = 2.491 mb 1 lbf/in ² (Psi) = 68.95 mb or 1 bar = 14.7 Psi
Power	1 horsepower = 745.7 W
Moment, Torque	1 ft-pdl = 42.14 mN-m
Rates of Flow	1 gal/h = 1.263 ml/s = 4.546 l/h 1 ft ³ /s = 28.32 l/s
Fuel Consumption	1 mile/gal = 0.3540 km/l
Kinematic Viscosity	1 ft ² /s = 929.0 cm ² /s = 929.0 St
Dynamic Viscosity	1 lbf-s/ft ² = 47.88 N-s/m ² = 478.8 P 1 pdl-s/ft ² = 1.488 N-s/m ² = 14.88 P 1cP = 1 mN-s/m ²
Energy	1 horsepower-h = 2.685 MJ 1 kW-h = 3.6 MJ 1 Btu = 1.055 kJ 1 therm = 105.5 MJ

Table 6: Conversion Factors

	Unit	X Factor	= Unit	x Factor	= Unit
Length (L)	ins	25.4	mm	0.0394	ins
	ft	0.305	m	3.281	ft
Area (A)	in ²	645.16	mm ²	0.0016	in ²
	ft ²	0.093	m ²	10.76	ft ²
Volume (V)	in ³	16.387	mm ³	0.000061	in ³
	ft ³	0.0283	m ³	35.31	ft ³
	ft ³	28.32	litre	0.0353	ft ³
	pints	0.5682	litre	1.7598	pints
	Imp. gal	4.546	litre	0.22	Imp gal
	Imp. gal	0.0045	m ³	220	Imp gal
Mass (M)	lb.	0.4536	kg	2.2046	lb.
	tonne	1000	kg		
Force (F)	lb.	4.448	N	0.2248	lb.
Velocity (V)	ft/min	0.0051	m/sec	196.85	ft/min
Volume Flow	Imp gal/min	0.0758	litres/s	13.2	Imp gal/min
	Imp gal/h	0.00013	m ³ /s	7,936.5	Imp gal/h
	ft ³ /min	0.00047	m ³ /s	2,118.6	ft ³ /min

Pressure (P)	lb/in ²	0.0689	bar	14.5	lb/in ²
	kg/cm ²	0.9807	bar	1.02	kg/cm ²
Density (ρ)	lb/ft ³	16.019	kg/m ³	0.0624	lb/ft ³
	Btu/h kcal/h	0.2931 1.163	W W	3.412 0.8598	Btu/h kcal/h
Thermal Conductivity (k)	Btu/ft h R	1.731	W/m K	0.5777	Btu/ft h R
	kcal/m h K	1.163	W/m K	0.8598	kcal/m h K
Thermal Conductance (U)	Btu/h ft ² R	5.678	W/m ² K	0.1761	Btu/h ft ² R
	kcal/h m ² K	1.163	W/m ² K	0.8598	kcal/h m ² K
Enthalpy (h)	Btu/lb.	2,326	J/kg	0.00043	Btu/lb.
	kcal/kg	4,187	J/kg	0.00024	kcal/kg

Table 7: Conversion Factors

Simply multiply the imperial by a constant factor to convert into Metric or the other way around.

Please click the advert

Grant Thornton—^{REALLY} a great place to work.

We're proud to have been recognized as one of Canada's Best Workplaces by the Great Place to Work Institute™ for the last four years. In 2011 Grant Thornton LLP was ranked as the fifth Best Workplace in Canada, for companies with more than 1,000 employees. We are also very proud to be recognized as one of Canada's top 25 Best Workplaces for Women and as one of Canada's Top Campus Employers.



Priyanka Sawant
Manager





Audit • Tax • Advisory
www.GrantThornton.ca/Careers



Grant Thornton
An instinct for growth™

© Grant Thornton LLP. A Canadian Member of Grant Thornton International Ltd

1 Fluid Statics

Contents

- 1.1 Fluid Properties
- 1.2 Pascal's Law.
- 1.3 Fluid Static Equation
- 1.4 Pressure measurement:
- 1.5 Resultant force on plane surfaces
- 1.6 Resultant force on curved surfaces
- 1.7 Buoyancy
- 1.8 Stability criteria for floating objects.
- 1.9 Tutorial problems



1.1 Fluid Properties

Fluid

A fluid is a substance, which deforms when subjected to a force. A fluid can offer no permanent resistance to any force causing change of shape. Fluid flow under their own weight and take the shape of any solid body with which they are in contact. Fluids may be divided into liquids and gases. *Liquids* occupy definite volumes. *Gases* will expand to occupy any containing vessel.

S.I Units in Fluids

The dimensional unit convention adopted in this course is the System International or S.I system. In this convention, there are 9 basic dimensions. The three applicable to this unit are: mass, length and time. The corresponding units are kilogrammes (mass), metres (length), and seconds (time). All other fluid units may be derived from these.

Density

The density of a fluid is its mass per unit volume and the SI unit is kg/m^3 . Fluid density is temperature dependent and to a lesser extent it is pressure dependent. For example the density of water at sea-level and 4°C is 1000 kg/m^3 , whilst at 50°C it is 988 kg/m^3 .

The relative density (or *specific gravity*) is the ratio of a fluid density to the density of a standard reference fluid maintained at the same temperature and pressure:

$$\text{For gases: } RD_{\text{gas}} = \frac{\rho_{\text{gas}}}{\rho_{\text{air}}} = \frac{\rho_{\text{gas}}}{1.205 \text{ kg / m}^3}$$

$$\text{For liquids: } RD_{\text{liquid}} = \frac{\rho_{\text{liquid}}}{\rho_{\text{water}}} = \frac{\rho_{\text{liquid}}}{1000 \text{ kg / m}^3}$$

Viscosity

Viscosity is a measure of a fluid's resistance to flow. The viscosity of a liquid is related to the ease with which the molecules can move with respect to one another. Thus the viscosity of a liquid depends on the:

- Strength of attractive forces between molecules, which depend on their composition, size, and shape.
- The kinetic energy of the molecules, which depend on the temperature.

Viscosity is not a strong function of pressure; hence the effects of pressure on viscosity can be neglected. However, viscosity depends greatly on temperature. For liquids, the viscosity decreases with temperature, whereas for gases, the viscosity increases with temperature. For example, crude oil is often heated to a higher temperature to reduce the viscosity for transport.

Consider the situation below, where the top plate is moved by a force F moving at a constant rate of V (m/s).

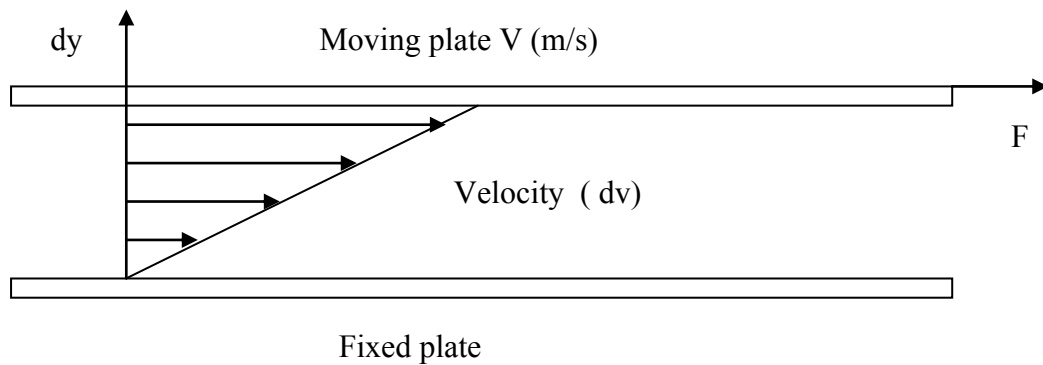

The shear stress τ is given by:

$$\tau = F/A$$

The rate of deformation dv (or the magnitude of the velocity component) will increase with distance above the fixed plate. Hence:

$$\tau = \text{constant} \times (dv / dy)$$

where the constant of proportionality is known as the **Dynamic viscosity** (μ) of the particular fluid separating the two plates.

$$\tau = \mu \times (V / y)$$

Where V is the velocity of the moving plate, and y is the distance separating the two plates. The units of dynamic viscosity are kg/ms or Pa s. A non-SI unit in common usage is the poise where 1 poise = 10^{-1} kg/ms

Kinematic viscosity (ν) is defined as the ratio of dynamic viscosity to density.

$$\text{i.e. } \nu = \mu / \rho \quad (1.1)$$

The units of kinematic viscosity are m^2/s .

Another non-SI unit commonly encountered is the “stoke” where 1 stoke = 10^{-4} m^2/s .

Please click the advert

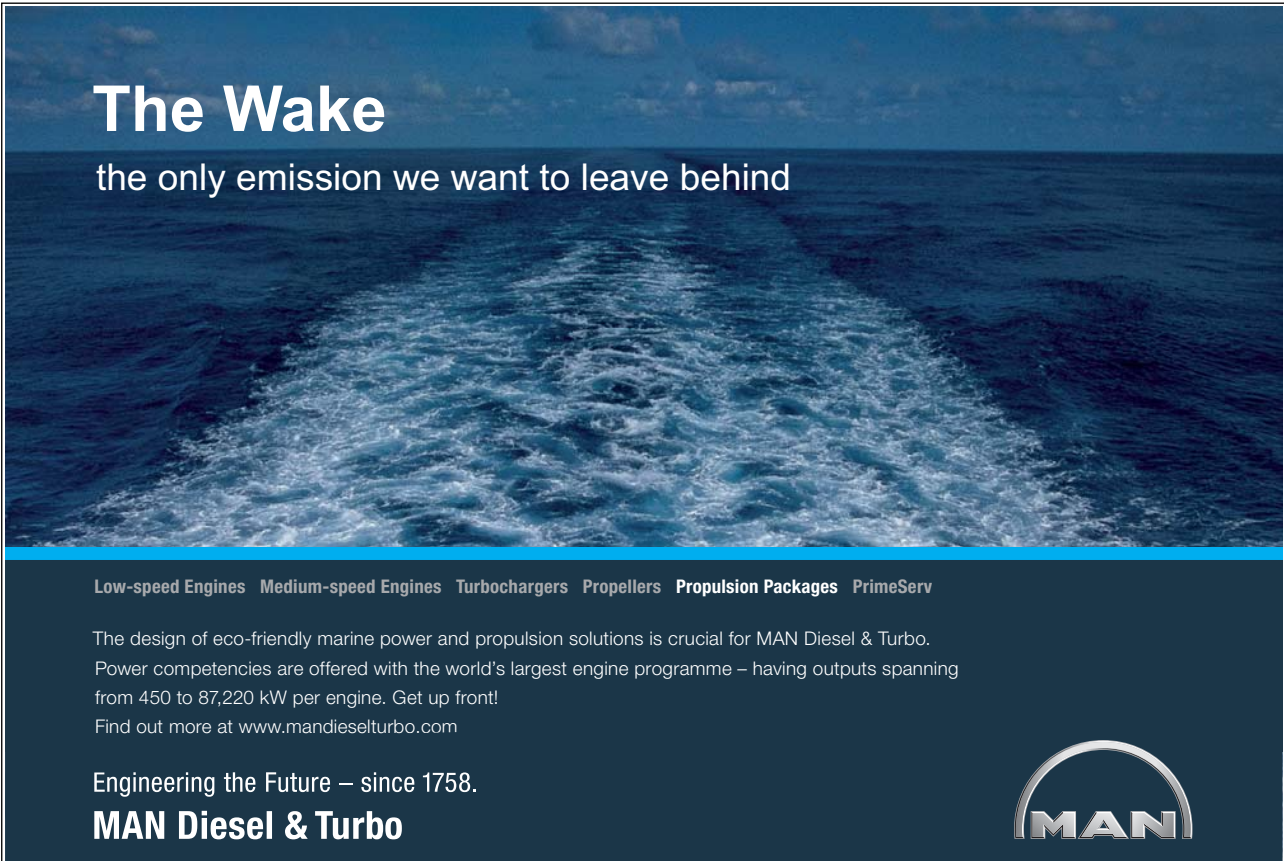

The Wake
the only emission we want to leave behind

Low-speed Engines Medium-speed Engines Turbochargers Propellers Propulsion Packages PrimeServ

The design of eco-friendly marine power and propulsion solutions is crucial for MAN Diesel & Turbo. Power competencies are offered with the world's largest engine programme – having outputs spanning from 450 to 87,220 kW per engine. Get up front! Find out more at www.mandieselturbo.com

Engineering the Future – since 1758.
MAN Diesel & Turbo



Download free ebooks at bookboon.com

Typical liquid	Dynamic Viscosity Centipoise* (cp)	Kinematic Viscosity Centistokes (cSt)
Water	1	1
Vegetable oil	34.6	43.2
SAE 10 oil	88	110
SAE 30 oil	352	440
Glycerine	880	1100
SAE 50 oil	1561	1735
SAE 70 oil	17,640	19,600

Table 1.1 Viscosity of selected fluids at standard temperature and pressure

Note: 1 cp = 10⁻³kg/ms and 1cSt = 10⁻⁶ m²/s

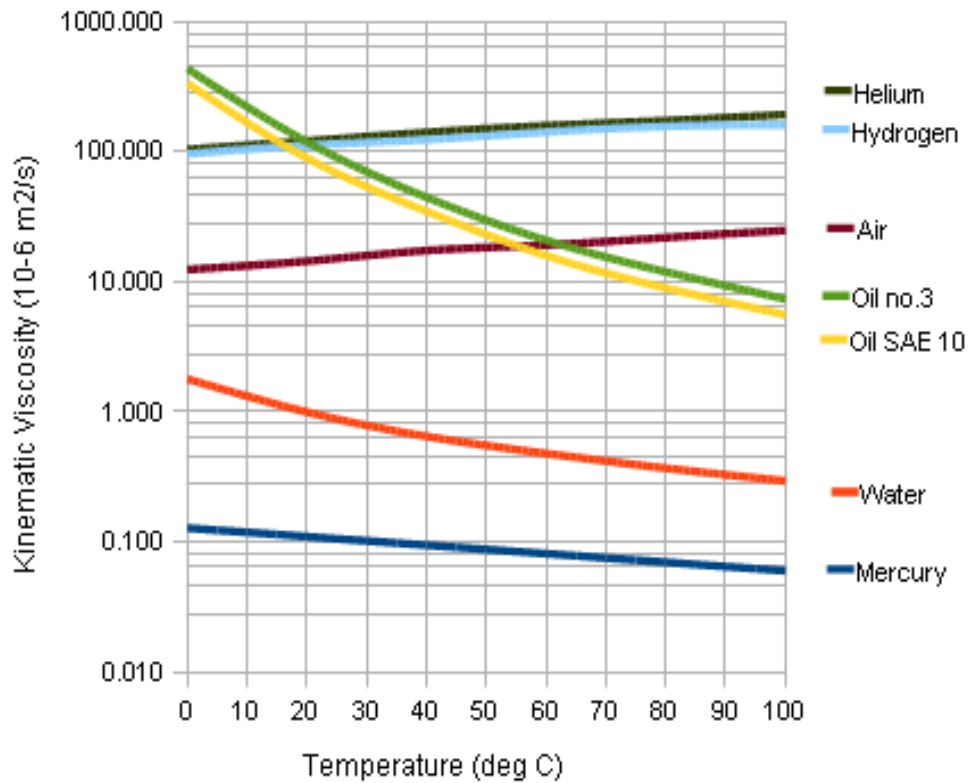

Figure 1.1 Variation of the Viscosity of some common fluids with temperature

Worked Example 1.1

The temperature dependence of liquid viscosity is the phenomenon by which liquid viscosity tends to decrease as its temperature increases. Viscosity of water can be predicted with accuracy to within 2.5% from 0 °C to 370 °C by the following expression:

$$\mu \text{ (kg/ms)} = 2.414 \times 10^{-5} * 10^{(247.8 \text{ K}/(\text{Temp} - 140 \text{ K}))}$$

Calculate the dynamic viscosity and kinematic viscosity of water at 20 °C respectively. You may assume that water is incompressible, and its density is 1000 kg/m³.

Compare the result with that you find from the viscosity chart and comment on the difference.

Solution

- a) Using the expression given:

$$\begin{aligned} \mu \text{ (kg/ms)} &= 2.414 \times 10^{-5} * 10^{(247.8 \text{ K}/(\text{Temp} - 140 \text{ K}))} \\ &= 2.414 \times 10^{-5} \times 10^{(247.8/(20+273-140))} \\ &= 1.005 \times 10^{-3} \text{ kg/ms} \end{aligned}$$

$$\begin{aligned} \text{Kinematic viscosity} &= \text{dynamic viscosity} / \text{density} \\ &= 1.005 \times 10^{-3} / 1000 = 1.005 \times 10^{-6} \text{ m}^2/\text{s} \end{aligned}$$

- b) From the kinematic viscosity chart, for water at 20 is 1.0x10⁻⁶ m²/s.

The difference is small, and observation errors may be part of it.

Worked Example 1.2

A shaft 100 mm diameter (D) runs in a bearing 200 mm long (L). The two surfaces are separated by an oil film 2.5 mm thick (c). Take the oil viscosity (μ) as 0.25 kg/ms. if the shaft rotates at a speed of (N) revolutions per minute.

- a) Show that the torque exerted on the bearing is given as:

$$\text{Torque} = \frac{\mu \times \pi^2 \times N \times L}{120 \times c} \times D^3$$

- b) Calculate the torque necessary to rotate the shaft at 600 rpm.

Solution:

- a) The viscous shear stress is the ratio of viscous force divided by area of contact

$$\tau = \frac{F}{A}$$

$$F = \mu \cdot (V/c) \times A$$

$$A = \pi \cdot D \cdot L$$

$$V = \pi D N / 60$$

$$\text{Torque} = F \times r = \frac{\mu \cdot \pi \times D \times N}{60 \times c} \times (\pi \cdot D \cdot L) \times D / 2$$

$$\text{Torque} = \frac{\mu \cdot \pi^2 \times N \times L}{120 \times c} \times D^3$$

b) the torque at the given condition is calculated using the above equation:

$$\text{Torque} = \frac{\mu \cdot \pi^2 \times N \times L}{120 \times c} \times D^3 = \frac{0.25 \times \pi^2 \times 600 \times 0.2}{120 \times 0.0025} \times 0.1^3 = 0.987 \text{ Nm}$$

Please click the advert

GOT-THE-ENERGY-TO-LEAD.COM

We believe that energy suppliers should be renewable, too. We are therefore looking for enthusiastic new colleagues with plenty of ideas who want to join RWE in changing the world. Visit us online to find out what we are offering and how we are working together to ensure the energy of the future.

RWE
The energy to lead

Download free ebooks at bookboon.com

Fluid Pressure

Fluid pressure is the force exerted by the fluid per unit area. Fluid pressure is transmitted with equal intensity in all directions and acts normal to any plane. In the same horizontal plane the pressure intensities in a liquid are equal. In the SI system the units of fluid pressure are Newtons/m² or Pascals, where 1 N/m² = 1 Pa.

$$\text{i.e.} \quad P = \frac{F}{A} \quad (1.2)$$

Many other pressure units are commonly encountered and their conversions are detailed below:-

1 bar	=10 ⁵ N/m ²
1 atmosphere	= 101325 N/m ²
1 psi (1bf/in ² - not SI unit)	= 6895 N/m ²
1 Torr	= 133.3 N/m ²

Terms commonly used in static pressure analysis include:

Pressure Head. The pressure intensity at the base of a column of homogenous fluid of a given height in metres.

Vacuum. A perfect vacuum is a completely empty space in which, therefore the pressure is zero.

Atmospheric Pressure. The pressure at the surface of the earth due to the head of air above the surface. At sea level the atmospheric pressure is about 101.325 kN/m² (i.e. one atmosphere = 101.325 kN/m² is used as units of pressure).

Gauge Pressure. The pressure measured above or below atmospheric pressure.

Absolute Pressure. The pressure measured above absolute zero or vacuum.

$$\text{Absolute Pressure} = \text{Gauge Pressure} + \text{Atmospheric Pressure} \quad (1.3)$$

Vapour Pressure

When evaporation of a liquid having a free surface takes place within an enclosed space, the partial pressure created by the vapour molecules is called the vapour pressure. Vapour pressure increases with temperature.

Compressibility

A parameter describing the relationship between pressure and change in volume for a fluid.

A compressible fluid is one which changes its volume appreciably under the application of pressure. Therefore, liquids are virtually incompressible whereas gases are easily compressed.

The compressibility of a fluid is expressed by the *bulk modulus of elasticity* (E), which is the ratio of the change in unit pressure to the corresponding volume change per unit volume.

1.2 Pascal's Law

Pascal's law states that the pressure intensity at a point in a fluid at rest is the same in all directions. Consider a small prism of fluid of unit thickness in the z-direction contained in the bulk of the fluid as shown below. Since the cross-section of the prism is equilateral triangle, P_3 is at an angle of 45° with the x-axis. If the pressure intensities normal to the three surfaces are P_1 , P_2 , P_3 as shown then since:-

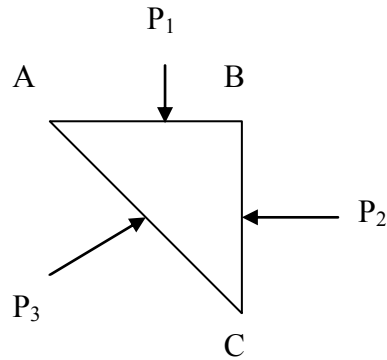

Force = Pressure x Area

$$\text{Force on face AB} = P_1 \times (\text{AB} \times 1)$$

$$\text{BC} = P_2 \times (\text{BC} \times 1)$$

$$\text{AC} = P_3 \times (\text{AC} \times 1)$$

Resolving forces vertically:

$$P_1 \times \text{AB} = P_3 \times \text{AC} \cos \theta$$

$$\text{But } \text{AC} \cos \theta = \text{AB} \quad \text{Therefore } P_1 = P_3$$

Resolving forces horizontally:

$$P_2 \times \text{BC} = P_3 \times \text{AC} \sin \theta$$

$$\text{But } \text{AC} \sin \theta = \text{BC} \quad \text{Therefore } P_2 = P_3$$

$$\text{Hence } P_1 = P_2 = P_3 \quad (1.4)$$

In words: the pressure at any point is equal in all directions.

1.3 Fluid-Static Law

The fluid-static law states that the pressure in a fluid increases with increasing depth. In the case of water this is termed the hydrostatic law.

Consider a vertical column, height h (m), of fluid of constant cross-sectional area A (m^2) totally surrounded by the same

fluid of density ρ (kg/m³)

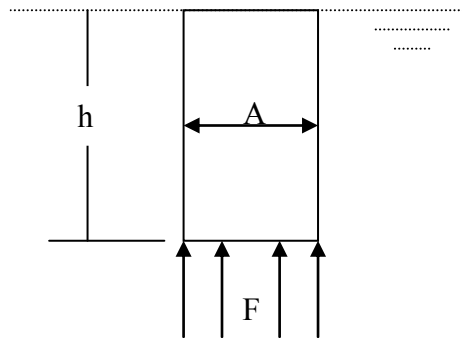

For vertical equilibrium of forces:

Force on base = Weight of Column of Fluid

Weight of column = mass x acceleration due to gravity $W = m.g$

the mass of the fluid column = its density x volume,

the volume of the column = Area (A) of the base x height of the column (h);



You're full of *energy*
and *ideas*. And that's
just what we are looking for.

Looking for a career where your ideas could really make a difference? UBS's Graduate Programme and internships are a chance for you to experience for yourself what it's like to be part of a global team that rewards your input and believes in succeeding together.

Wherever you are in your academic career, make your future a part of ours by visiting www.ubs.com/graduates.

www.ubs.com/graduates



© UBS 2010. All rights reserved.

Please click the advert

the weight of the column = $\rho \times A \times h \times g$

Force = Pressure \times Area = $P \times A$

Hence: $P \times A = \rho \times A \times h \times g$

Divide both sides by the area A , $P = \rho g h$ (1.5)

Worked Example 1.3

A dead-weight tester is a device commonly used for calibrating pressure gauges. Weights loaded onto the piston carrier generate a known pressure in the piston cylinder, which in turn is applied to the gauge. The tester shown below generates a pressure of 35 MPa when loaded with a 100 kg weight.

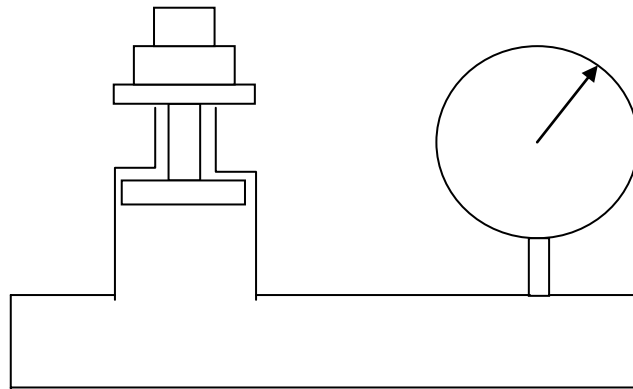

Determine:

- a) The diameter of the piston cylinder (mm)
- b) The load (kg) necessary to produce a pressure of 150kPa

Solution:

a) $P = F/A$

The Force $F = \text{mass} \times \text{acceleration} = 100 \times 9.81 = 981 \text{ N}$

Hence $A = F / P = 981 / 35 \times 10^6 = 2.8 \times 10^{-5} \text{ m}^2$

The area of cross-section of the piston is circular, hence the diameter is found as follows:

$$A = \frac{\pi \cdot D^2}{4}$$

$$\therefore D = \sqrt{\frac{4 \cdot A}{\pi}} = \sqrt{\frac{4 \times 2.8 \times 10^{-5}}{\pi}} = 5.97 \text{ mm}$$

$$\text{b) } F = P \times A = 150 \times 10^3 \times 2.8 \times 10^{-5} = 42 \text{ N}$$

$$\text{But } F = mg \quad \text{Therefore } m = 42/9.81 = 4.28 \text{ kg.}$$

Worked Example 1.4

- a) If the air pressure at sea level is 101.325 kPa and the density of air is 1.2 kg/m³, calculate the thickness of the atmosphere (m) above the earth.
- b) What gauge pressure is experienced by a diver at a depth of 10m in seawater of relative density 1.025?

Assume $g = 9.81 \text{ m/s}^2$.

Solution:

- a) Given: $P = 101.325 \text{ kPa} = 101325 \text{ Pa}$
 $\rho_{\text{air}} = 1.2 \text{ kg/m}^3$
 Then using $P = \rho_{\text{air}} g h$

The depth of the atmospheric air layer is calculated:

$$h = \frac{P}{\rho \cdot g} = \frac{101325}{1.2 \times 9.81} = 8607 \text{ m}$$

- b) since the relative density is $RD = 1.025$

Therefore

$$\rho_{\text{seawater}} = 1.025 \times 1000 = 1025 \text{ kg/m}^3$$

$$\begin{aligned} \text{Then } P &= \rho_{\text{seawater}} g h \\ &= 1025 \times 9.81 \times 10 \\ &= 100.552 \text{ kPa} \end{aligned}$$

1.4 Pressure Measurement

In general, sensors used to measure the pressure of a fluid are called pressure transducers. A Transducer is a device that, being activated by energy from the fluid system, in itself responds in a manner related to the magnitude of the applied pressure. There are essentially two different ways of measuring the pressure at a point in a fluid whether static or in motion.

The essential feature of a pressure transducer is the elastic element which converts the signal from the pressure source into mechanical displacement (e.g. the Bourdon gauge). The second category has an electric element which converts the signal into an electrical output. The popularity of electric pressure transducers is due to their adaptability to be amplified, transmitted, controlled and stored.

The Bourdon gauge is a mechanical pressure measurement device that relies on a circular arc of elliptical cross-section tube (the Bourdon tube) closed at one end, changing shape to a circular cross-section under the action of fluid pressure. The resulting motion at the closed end is amplified by a gear arrangement to produce the movement of a pointer around a scale. The scale is normally calibrated to indicate pressure readings proportional to the deflection of the pointer.

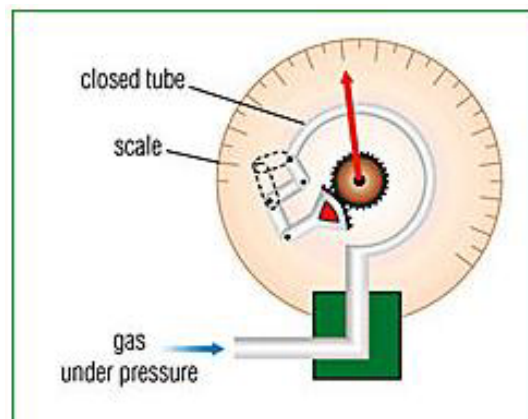

Figure 1.2 Bourdon pressure gauge

 RBS Group

CAREER KICKSTART

An app to keep you in the know

Whether you're a graduate, school leaver or student, it's a difficult time to start your career. So here at RBS, we're providing a helping hand with our new Facebook app. Bringing together the most relevant and useful careers information, we've created a one-stop shop designed to help you get on the career ladder – whatever your level of education, degree subject or work experience.

And it's not just finance-focused either. That's because it's not about us. It's about you. So download the app and you'll get everything you need to know to kickstart your career.

So what are you waiting for?

Click [here](#) to get started.

Please click the advert

Manometers:

The pressure is indicated by the displacement of the manometric fluid as high will be given the symbol P_1 and on the low side will be P_2 . By balancing the forces on each side, a relationship between pressures and manometer displacement can be established.

A. U-tube manometer

$$P_1 - P_2 = \rho g h \quad (1.6)$$

B. Well-type manometer

$$P_1 - P_2 = \rho g (h_1 + h_2)$$

But since $h_2 \times d = h_1 \times D$ the equation can be rewritten as

$$P_1 - P_2 = \rho g h_1 (1 + d/D) \quad (1.7)$$

C. Inclined tube manometer

$$P_1 - P_2 = \rho g h$$

$L = h / \sin(\theta)$ with (θ) as the angle of the low limb with the horizontal axis.

Hence:

$$P_1 - P_2 = \rho g L \sin(\theta) \quad (1.8)$$

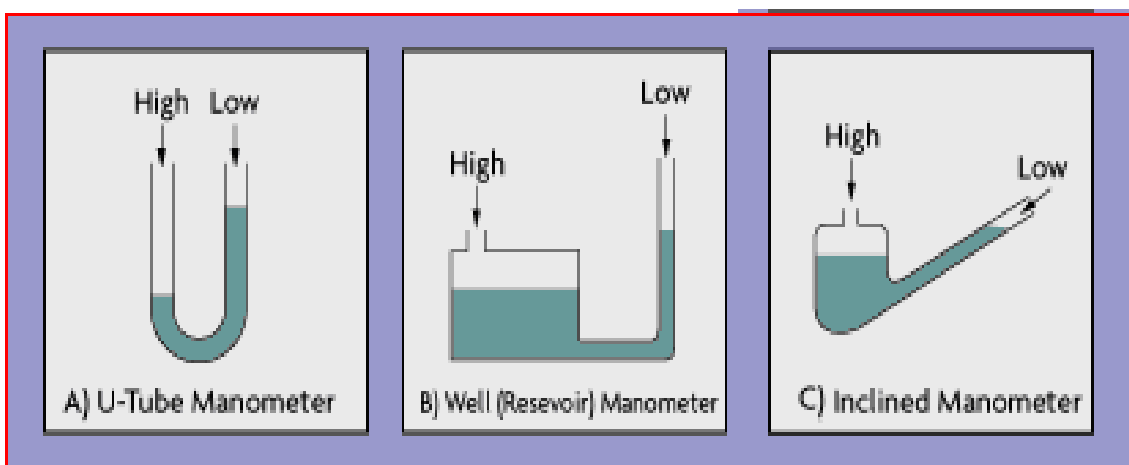
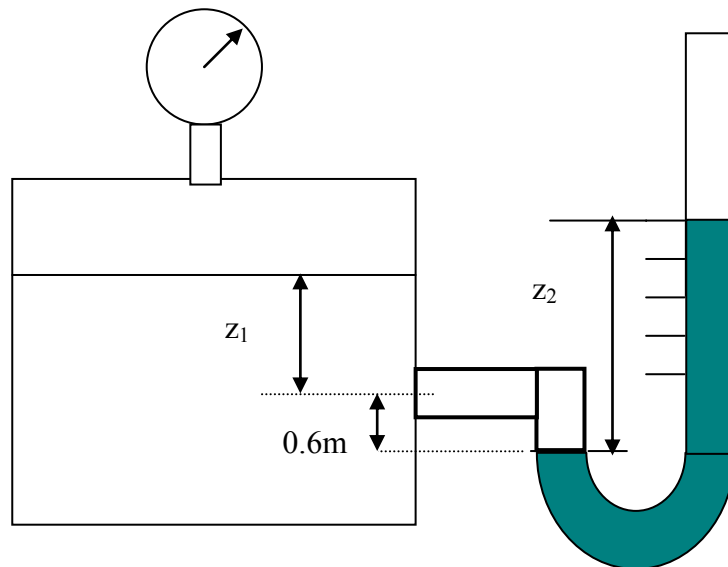

Figure 1.3 Manometers

Worked Example 1.5

A U-tube manometer is connected to a closed tank, shown below, containing oil having a density of 860 kg/m^3 , the pressure of the air above the oil being 3500 Pa . If the pressure at point A in the oil is 14000 Pa and the manometer fluid has a RD of 3, determine:

1. The depth of oil, z_1
2. The differential reading, z_2 on the manometer.

**Solution:**

1. At point A in the tank:

$$P_A = \rho_{\text{oil}} g z_1 + P_{\text{air}}$$

$$\text{i.e. } 14000 = (860 \times 9.81 \times z_1) + 3500$$

$$z_1 = 1.244 \text{ m.}$$

2. At datum : equilibrium of pressure on both sides

$$P_{\text{LHS}} = P_{\text{RHS}}$$

$$P_A + \rho_{\text{oil}} \times g \times z_1 = \rho_{\text{m}} \times g \times z_2$$

$$14000 + (860 \times 9.81 \times 0.6) = 3000 \times 9.81 \times z_2$$

$$z_2 = 0.647 \text{ m}$$

Applications of Pascal's law

Two very useful devices based on Pascal's law are hydraulic brakes and hydraulic lift shown below. The pressure applied by the foot on the break pedal is transmitted to the brake fluid contained in the master cylinder. This pressure is transmitted undiminished in all directions and acts through the brake pads on the wheel reducing the rotary motion to a halt. Sliding friction between the tyres and the road surface opposes the tendency of forward motion reducing the linear momentum to zero.

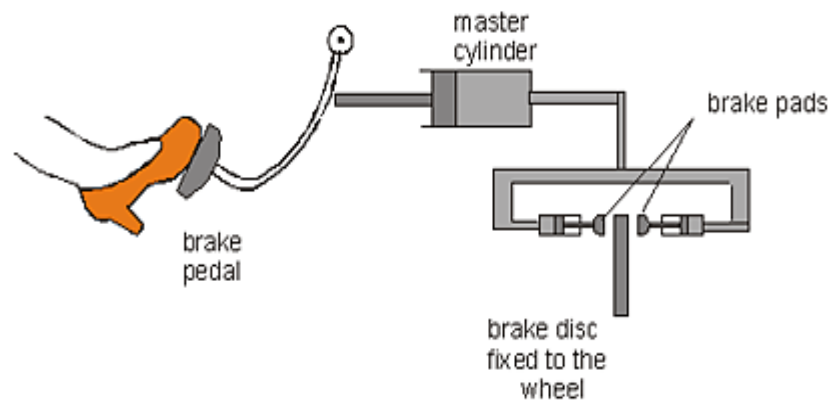

Figure 1.4 Hydraulic brakes

ORACLE®

Be BRAVE
enough to reach for the sky

Oracle's business is information - how to manage it, use it, share it, protect it. Oracle is the name behind most of today's most innovative and successful organisations.

Oracle continuously offers international opportunities to top-level graduates, mainly in our Sales, Consulting and Support teams.

If you want to join a company that will invest in your future, Oracle is the company for you to drive your career!

<https://campus.oracle.com>

ORACLE®

ORACLE IS THE INFORMATION COMPANY



Please click the advert

By means of hydraulic lifts, vehicles are lifted high on ramps for repairs and servicing. A force F applied on the cylinder of small area A , creates a pressure $P=F/A$ which acts upwards on the ramp in the large cylinder of cross sectional area A' . The upward force acting on the ramp (being equal to $F'=FA'/A$) is much larger than the applied force F .

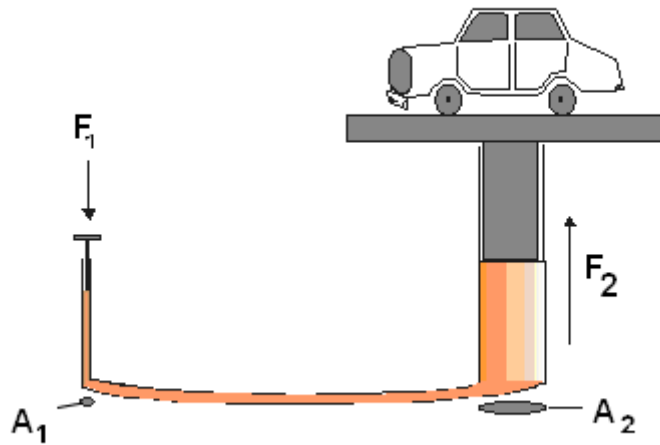
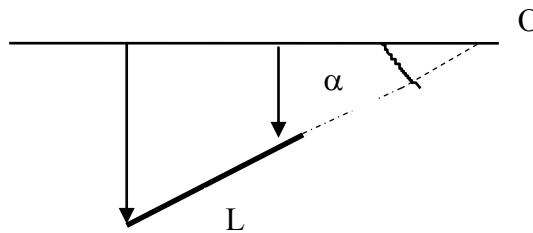

Figure 1.5 Hydraulic lift

1.5 Centre of pressure & the Metacentre

Consider a submerged plane surface making an angle α when extended to a horizontal liquid surface.



To find the point at which F acts, take moments about O

$$\begin{aligned}
 F \cdot l_p &= \text{Sum of moments of forces on elementary strips} \\
 &= \int \rho g l \sin \alpha \cdot b \cdot d l \cdot l \\
 &= \rho g \sin \alpha \int (bdl) \cdot l^2
 \end{aligned}$$

Now $\int (bdl) \cdot l^2 = 2\text{nd moment of area about line through } O (I_o)$

Therefore,

$$\rho \cdot g \cdot h_c \cdot A \cdot \frac{h_p}{\sin \alpha} = \rho \cdot g \cdot \sin \alpha \cdot I_o \tag{1.9}$$

Rearranging

$$h_p = \frac{I_o}{Ah_c} \sin^2 \alpha \quad (1.10)$$

Since I_c which is the 2nd moment of area about the centre of gravity, is generally known for some geometry's, (see table overleaf) I_o can be found from the parallel axis theorem:

$$I_o = I_c + A.\ell_c^2 \quad (1.11)$$

Substituting for I_o in equation (1.10) and since $\ell_c = h_c/\sin \alpha$:

Then

$$h_p = \frac{I_c + \left(\frac{h_c}{\sin}\right)^2 .A}{A.h_c \alpha} .\sin^2 \alpha$$

$$h_p = \frac{I_c}{Ah_c} \sin^2 \alpha + h_c \quad (1.12)$$

Hence, $h_p > h_c$

i.e., the position of the centre of pressure is always below the centre of gravity since I_c is always positive.

The term $\frac{I_c}{Ah_c} \sin^2 \alpha$ is known as the **metacentre**, which is the distance between the centre of pressure and the centre of gravity.

SPECIAL CASE:

For the commonly encountered case of a vertical rectangular lamina, height d , width b , with one edge lying in the free surface, the centre of pressure may be found as follows:

Given:

$$\alpha = 90^\circ, \sin \alpha = 1.0$$

$$A = bd, h_c = \frac{d}{2}$$

Then

$$I_o = I_c + A h_c^2$$

$$= \frac{bd^3}{12} + \frac{bd \times d^2}{4} = \frac{bd^3}{3}$$

And

$$h_p = \frac{I_o}{A h_c} \sin^2 \alpha$$

$$= \frac{bd^3}{3bd} \cdot \frac{2}{d} = \frac{2d}{3}$$

Other cross-sections can be treated in a similar manner as above.

Please click the advert

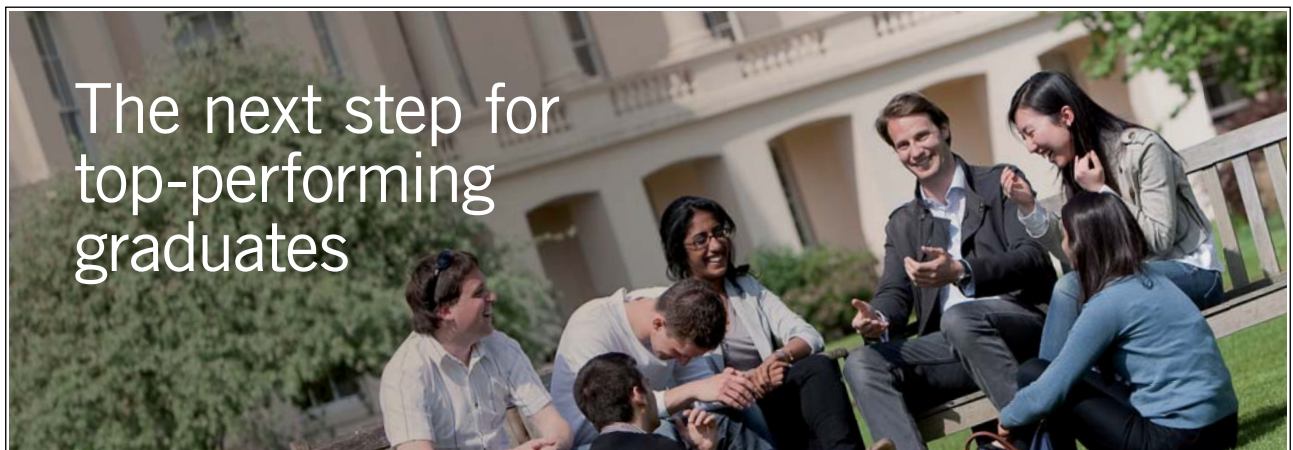

Masters in Management

Designed for high-achieving graduates across all disciplines, London Business School's Masters in Management provides specific and tangible foundations for a successful career in business.

This 12-month, full-time programme is a business qualification with impact. In 2010, our MiM employment rate was 95% within 3 months of graduation*; the majority of graduates choosing to work in consulting or financial services.

As well as a renowned qualification from a world-class business school, you also gain access to the School's network of more than 34,000 global alumni – a community that offers support and opportunities throughout your career.

For more information visit www.london.edu/mm, email mim@london.edu or give us a call on **+44 (0)20 7000 7573**.

* Figures taken from London Business School's Masters in Management 2010 employment report



	SHAPE	AREA	Centre of Gravity CG	2 nd Moment of area I _c about CG
Rectangle		bd	$d/2$	$\frac{bd^3}{12}$
Triangle		$\frac{bh}{2}$	$h/3$	$\frac{bh^3}{36}$
Circle		πR^2	At centre	$\frac{\pi R^4}{4}$
Semicircle		$\frac{\pi R^2}{2}$	$\frac{4R}{3\pi}$	$0.1102R^4$

Table 1.10 Second Moment of Area for some common cross-sections

Worked Example 1.6

A dock gate 10 m wide has sea depths of 6 m and 15 m on its two sides respectively. The relative density of seawater is 1.03.

1. Calculate the resultant force acting on the gate due to the water pressure.
2. Find the position of the centre of pressure relative to the bottom of the gate.

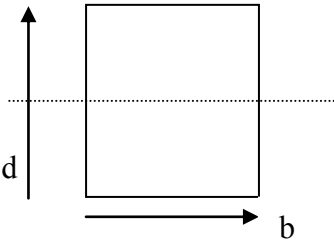
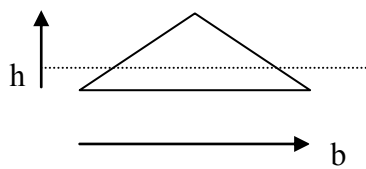
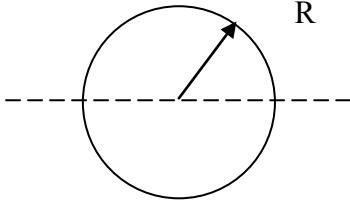
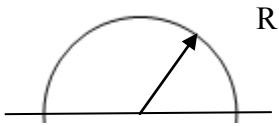
Solution:

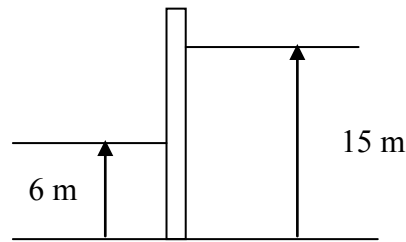

L.H.S

$$F_1 = \rho g h_c A = 1.03 \times 1000 \times 9.81 \times \frac{6}{2} \times 6 \times 10$$

$$= 1.819 \text{ MN}$$

R.H.S

$$F_2 = \rho g h_c A = 1.03 \times 1000 \times 9.81 \times \frac{15}{2} \times 15 \times 10$$

$$= 11.37 \text{ MN}$$

Resultant Force $F = F_2 - F_1 = 11.37 - 1.819 = 9.55 \text{ MN}$ acts to the left.

Only the wetted portions of the gate are relevant. Hence we have two vertical rectangles with their top edges in the free surface. Hence, $h_p = \frac{2d}{3}$

$$h_1 = 2 \times 6/3 = 4 \text{ m}$$

$$h_2 = 2 \times 15/3 = 10 \text{ m}$$

If y is the distance from the bottom to position of the resultant force F then taking moments anti-clockwise about the base of the gate:-

$$F \cdot y = F_2 \times (15 - h_2) - F_1 \times (6 - h_1)$$

$$9.55y = 11.37 (15 - 10) - 1.819 (6 - 4)$$

Therefore $y = 5.57 \text{ m}$ above the bottom of the gate.

Worked Example 1.7

A flat circular plate, 1.25 m diameter is immersed in water such that its greatest and least depths are 1.50 m and 0.60 m respectively. Determine:-

1. The force exerted on one face by the water pressure,
2. The position of the centre of pressure.

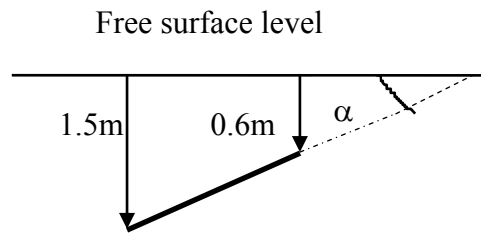

Solution:

$$\text{Area of lamina } A = \frac{1}{4} \pi (1.25)^2 = 1.228 \text{ m}^2$$

$$\text{Depth to centroid } h_c = \frac{1}{2} (0.60 + 1.50) = 1.05 \text{ m}$$

$$\begin{aligned} \text{Resultant Force } F &= \rho g A h_c = 9.81 \times 1000 \times 1.228 \times 1.05 \\ &= 12650 \text{ N} \end{aligned}$$

$$\text{From table for circular plate } I_c = \frac{\pi r^4}{4}$$

$$\sin(\alpha) = \frac{1.50 - 0.60}{1.25} = 0.72$$

The centre of pressure

$$h_p = \frac{I_c}{A h_c} \sin^2 \alpha + h_c = \frac{\pi \cdot (r^4 / 4)}{\pi \cdot r^2 \cdot h_c} \cdot \sin^2(\alpha) + h_c$$

$$h_p = \frac{0.625^2}{4 \times 1.05} \cdot (0.72)^2 + 1.05 = 1.098 \text{ m}$$

1.6 Resultant Force and Centre of Pressure on a Curved Surface in a Static Fluid

Systems involving curved submerged surfaces are analysed by considering the horizontal and vertical components of the resultant force.

1. The vertical component of the force is due to the weight of the fluid supported and acts through the centre of gravity of the fluid volume.

$$\text{i.e. } F_v = \rho g \text{ Vol} \quad (1.13)$$

2. The horizontal component of the force is equal to the normal force on the vertical projection of the surface.

The force acts through the centre of gravity of the vertical projection.

i.e. $F_H = \rho g h_c A$ (1.14)

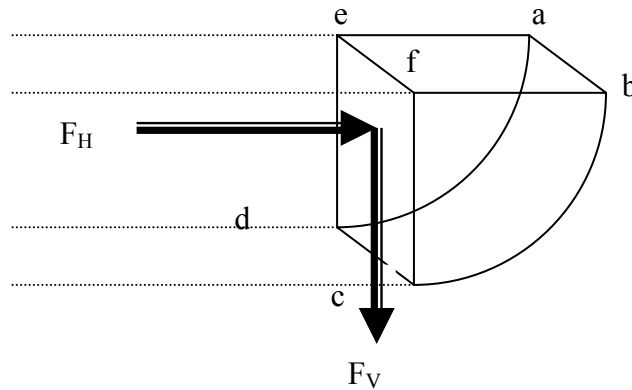

Curved surface = Area bounded by abcd

Vertical projection of abcd = cdef (Area A)

Fluid volume = volume bounded by abcdef

Destination MMU



Manchester Metropolitan University

MMU is proud to be one of the most popular universities in the UK. Some 34,000 students from all parts of the globe select from its curricula of over 1,000 courses and qualifications.

We are based in the dynamic yet conveniently compact city of Manchester, located at the heart of a sophisticated transport network including a major international airport on the outskirts. Parts of the campus are acclaimed for their architectural style and date back over 150 years, in direct contrast to our teaching style which is thoroughly modern, innovative and forward-thinking.

MMU offers undergraduate and postgraduate courses in the following subject areas:

- Art, Design & Performance
- Computing, Engineering & Technology
- Business & Management
- Science, Environmental Studies & Geography
- Law, Education & Psychology
- Food, Hospitality, Tourism & Leisure Studies
- Humanities & Social Science



For more details or an application form please contact MMU International.
 email: international@mmu.ac.uk
 telephone: +44 (0)161 247 1022
www.mmu.ac.uk/international

Please click the advert

The resultant force F_R is given by:

$$F_R = \sqrt{F_H^2 + F_V^2} \quad (1.15)$$

And the angle of inclination (α) to the horizontal:

$$\tan \alpha = F_V/F_H \quad (1.16)$$

Worked Example 1.8

The sluice gate shown below consists of a quadrant of a circle of radius 1.5 m. If the gate is 3m wide and has a mass of 6000 kg acting 0.6 m to the right of the pivot (e-f), calculate:-

1. Magnitude and direction of the force exerted on the gate by the water pressure,
2. The turning moment required to open the gate.

Solution:

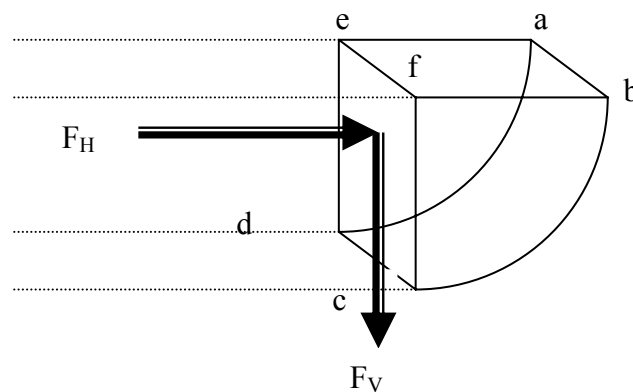

Horizontal component = Force on horizontal projected area.

$$F_H = \rho g h_c A = 1000 \times 9.81 \times 0.75 \times (3 \times 1.5) = 33.1 \times 10^3 \text{ N}$$

Vertical component = weight of fluid which would occupy

$$F_V = \rho g \times \text{vol of cylindrical sector} = (1000 \times 9.81) \times \left(3 \times \frac{\pi}{4} \times 1.5^2\right) = 52 \times 10^3 \text{ N}$$

$$\text{Resultant force } F_R = \sqrt{F_H^2 + F_V^2} = \sqrt{(33.1 \times 10^3)^2 + (52 \times 10^3)^2} = 61.6 \text{ kN}$$

If α is the angle of inclination of R to the horizontal then

$$\tan \alpha = F_V/F_H = 52 \times 10^3 / 33.1 \times 10^3 \quad \text{i.e. } \alpha = 57.28^\circ$$

Since static pressure acts normal to the surface, it can be deduced that the line of action of F_R passes through the centre of curvature.

So the only force providing a moment is the weight of the gate.

Hence;

$$\text{Moment} = \text{Force} \times \text{distance} = 6000 \times 9.81 \times 0.6 = 35300 \text{ Nm}$$

1.7 Buoyancy

The buoyancy of a body immersed in a fluid is that property which will determine whether the body will sink, rise or float. Archimedes established the analysis over 2000 years ago. Archimedes reasoned that the volume of an irregular solid could be found by determining the apparent loss of weight when the body is totally immersed in a liquid of known density.

Archimedes principle states:-

1. "The upthrust (vertical force) experienced by a body immersed in a fluid equals the weight of the displaced fluid"
2. "A floating body displaces its own weight in the fluid in which it floats".

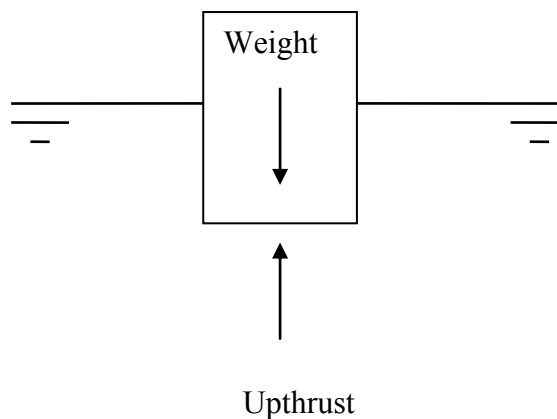

Upthrust

$$F = \text{Pressure} \times \text{Area}$$

$$= P \times A$$

But $P = \rho \cdot g \cdot h$

Therefore, $F = \rho \cdot g \cdot h \cdot A$

But the volume $V_L = h \cdot A$

Therefore, $F = \rho \cdot g \cdot V_L$ (1.17)

Buoyant force can be expressed as:

$$F(b) = W(\text{air}) - W(\text{liquid}) = d \times g \times V_L$$

where d is the density of the liquid, g is the acceleration of gravity and v is the volume of the immersed object (or the immersed part of the body if it floats). Since $W=mg$, the apparent change in mass when submerged is

$$m - m(\text{apparent}) = d(\text{liquid}) \times v_L$$

Worked Example 1.9

A hydrogen filled balloon has a total weight force of 9.5 kN. If the tension in the mooring cable anchoring the balloon to the ground is 15.75 kN, determine the upthrust experienced by the balloon and its volume.

Take the density of air as 1.23 kg/m^3 .

Solution:

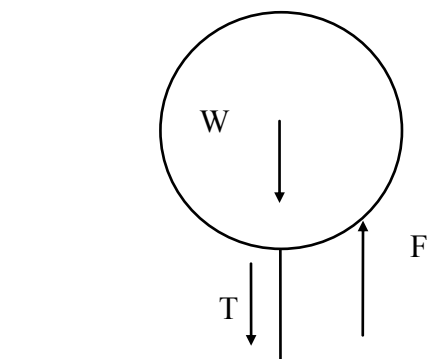

Since the system is stable: Upthrust = Weight force + Tension in cable

$$\begin{aligned} F &= W + T \\ &= 9.5 + 15.75 \\ &= 25.25 \text{ kN} \end{aligned}$$

The Upthrust is $F = \rho \times V_L \times g$

Since the upthrust = the weight of displaced fluid, Therefore Balloon Volume

$$V_L = \frac{F}{\rho \cdot g} = \frac{25.25 \times 10^3}{1.23 \cdot 9.81} = 2092 \text{ m}^3$$

Worked Example 1.10

A model boat consists of open topped rectangular metal can containing sand as a ballast. If the can has a width of 100 mm, a length of 500 mm, and a mass of 1 kg, determine the mass of sand (kg) required for the can to be immersed to a depth of 250 mm in sea water (RD = 1.03).

Please click the advert



Get Internationally Connected at the University of Surrey

MA Intercultural Communication with International Business
MA Communication and International Marketing



MA Intercultural Communication with International Business

Provides you with a critical understanding of communication in contemporary socio-cultural contexts by combining linguistic, cultural/media studies and international business and will prepare you for a wide range of careers.

MA Communication and International Marketing

Equips you with a detailed understanding of communication in contemporary international marketing contexts to enable you to address the market needs of the international business environment.

For further information contact:

T: +44 (0)1483 681681

E: pg-enquiries@surrey.ac.uk

www.surrey.ac.uk/downloads

Solution:

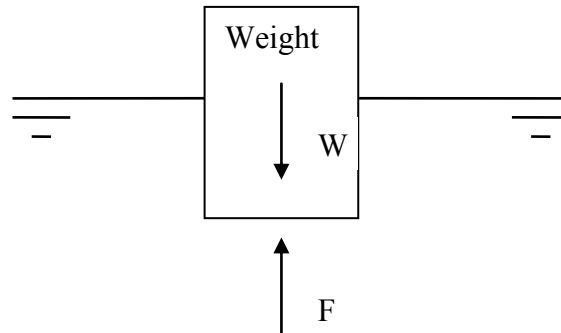

Displaced volume $V_L = W \times D \times L = 0.1 \times 0.25 \times 0.5 = 0.0125 \text{ m}^3$

For stable condition - Upthrust = weight force or $F = W$

The Upthrust due to Buoyancy = $\rho_{\text{seawater}} g V_L$

The total weight = $(m_{\text{can}} + m_{\text{sand}}) \times 9.81$

Therefore: $\rho_{\text{seawater}} g V_L = (m_{\text{can}} + m_{\text{sand}}) \times 9.81$

$1030 \times 9.81 \times 0.0125 = (1.0 + m_{\text{sand}}) \times 9.81$

Solving $m_{\text{sand}} = 11.87 \text{ kg}$

Note: The sand will need to be levelled off or the can will not float vertically and may even be unstable.

1.8 Stability of floating bodies

A body is in a **stable** equilibrium if it returns to its original position after being slightly displaced. Neutral position if the object remains in the new position after being slightly displaced. A body is in an **unstable** equilibrium if it continues to move in the direction of the displacement.

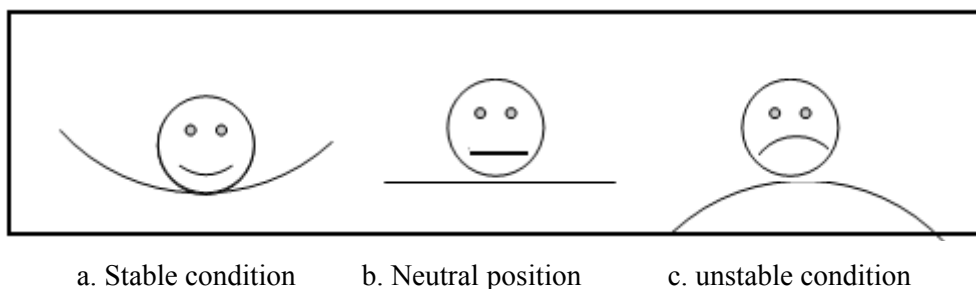

Figure 1.6 Stability of floating objects

If the **Centre of Buoyancy (B)** is defined as the centre of gravity of the displaced fluid then the stability of a floating object will depend on whether a righting or overturning moment is developed when the centre of gravity (G) and the centre of buoyancy move out of vertical alignment due to the shifting of the position of the latter. The centre of buoyancy moves because if a floating body tips, the shape of the displaced liquid changes.

Position (a) Figure 1.7, illustrates a stable condition, where the forces of Buoyancy thrust and the weight are equal and in line; while in Figure 1.7 (b) the body has been tipped over and the buoyancy has a new position B, with G unchanged. The vertical through the new centre of buoyancy cuts the original line, which is still passing through G at M, a point known as the **Metacentre**. In this case M lies above G, and stability exists.

If M lies below G (c), it can be shown that once the body is tipped the couple introduced will aggravate the rolling, causing it to tip further away from its stable position. The body is said to be unstable. Therefore, for stability the metacentre must be above the centre of gravity, i.e. M above G.

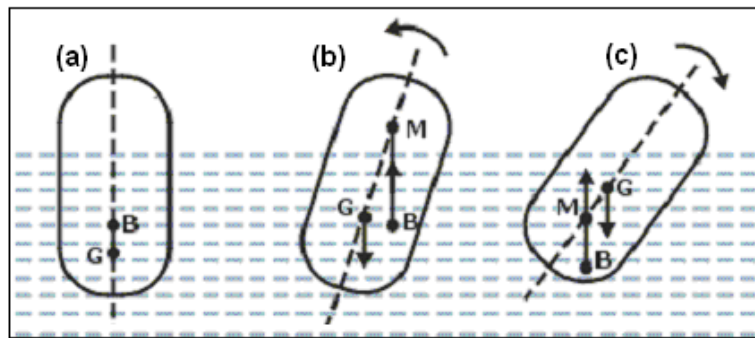

Figure 1.7 Buoyancy and the metacentre

Worked Example 1.11

A raft floating in a river, supported by two drums, each 1m in diameter and 5m long.

If the raft is to stay afloat by 0.25m clear above water. What is the maximum weight that is allowed on it?

Assume density of water 1000 kg/m³.

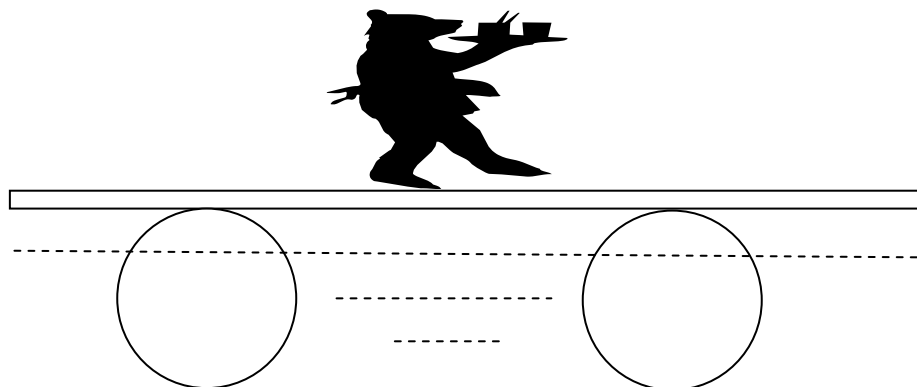

Solution:

The above case can be solved by first, calculating the displaced volume, converts it into a weight, and then apply Archimedes' principle

$$F_b = \rho g V_L$$

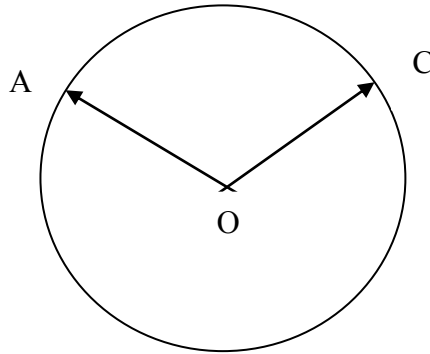

The angle AOC is calculated

$$\cos(\text{AOC}) = 0.25/0.5$$

Hence angle AOC = 1.047 rad.

Please click the advert

STEP INTO A WORLD
OF OPPORTUNITY

www.ecco.com/trainees
trainees@ecco.com





$$\begin{aligned} \text{Area of sector} &= OC^2 \times \text{angle} = 0.5^2 \times 1.047 \\ &= 0.262 \text{ m}^2 \end{aligned}$$

$$\text{Area of triangle AOC} \quad A = 0.25 \times \sqrt{0.5^2 - 0.25^2} = 0.108 \text{ m}^2$$

$$\text{Area submerged} = 2 (0.262 - 0.108) = 0.308 \text{ m}^2$$

$$\text{Volume displaced} = 0.308 \times 5 = 1.54 \text{ m}^3$$

$$\text{Weight} = \text{Density} \times \text{Volume displaced} = 1000 \times 1.54 = 1540 \text{ kg}$$

Worked Example 1.12

King Hero ordered a new crown to be made from pure gold (density = 19200 kg/m³). When he received the crown he suspected that other metals may have been used in the construction. Archimedes discovered that the crown needed a force of 20.91 N to suspend when submersed in water and that it displaced 3.1x10⁻⁴ m³ of water. He concluded that the crown could not be pure gold. Do you agree or disagree?

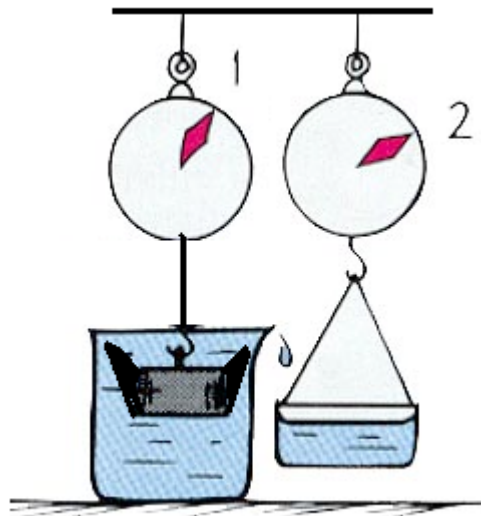

Solution:

$$\sum F = m.a$$

$$F_t = F_g - F_B$$

$$20.91 = \rho_s \cdot g \cdot V - \rho_w \cdot g \cdot V$$

hence

$$\rho_s = \rho_w + \frac{20.91}{3.1 \times 10^{-4} \times 9.81} = 7876 \text{ kg/m}^3$$

The density of pure gold (19200 kg/m^3) is more than twice this, so some other metal have been used, such metal as steel. So agreed with Archimedes

Worked Example 1.13

The hydraulic jack shown, the piston weighs 1000 N , determine the weight of the car which is supported by the jack when the gauge reading is 1.2 bar . Assume that the jack cylinder has a diameter of 0.4 m .

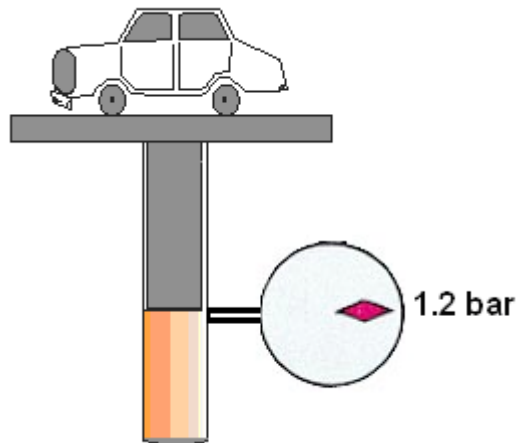

Solution:

$$\sum F = 0$$

$$P_a \cdot A = F_{car} + F_{piston}$$

$$1.2 \times 10^5 \times (\pi / 4) \times 0.4^2 = F_{car} + 1000$$

hence

$$F_{car} = 14080 \text{ N} = 1435 \text{ kg}$$

$$\text{weight} = 1.4 \text{ tonne}$$

1.9 Tutorial problems

- 1.1 Show that the kinematic viscosity has the primary dimensions of L^2T^{-1} .
- 1.2 In a fluid the velocity measured at a distance of 75mm from the boundary is 1.125m/s. The fluid has absolute viscosity 0.048 Pa s and relative density 0.913. What is the velocity gradient and shear stress at the boundary assuming a linear velocity distribution? Determine its kinematic viscosity.

[Ans: 15 s^{-1} , $0.72 \text{ Pa}\cdot\text{s}$; $5.257 \times 10^{-5} \text{ m}^2/\text{s}$]

- 1.3 A dead-weight tester is used to calibrate a pressure transducer by the use of known weights placed on a piston hence pressurizing the hydraulic oil contained. If the diameter of the piston is 10 mm, determine the required weight to create a pressure of 2 bars.

[Ans: 1.6 kg]

- 1.4 How deep can a diver descend in ocean water without damaging his watch, which will withstand an absolute pressure of 5.5 bar?

Take the density of ocean water, = 1025 kg/m^3 .

[Ans: 44.75 m]

1.5 The U-tube manometer shown below, prove that the difference in pressure is given by:

$$P_1 - P_2 = \rho \cdot g \cdot z_2 \left[1 + \left(\frac{d}{D} \right)^2 \right]$$

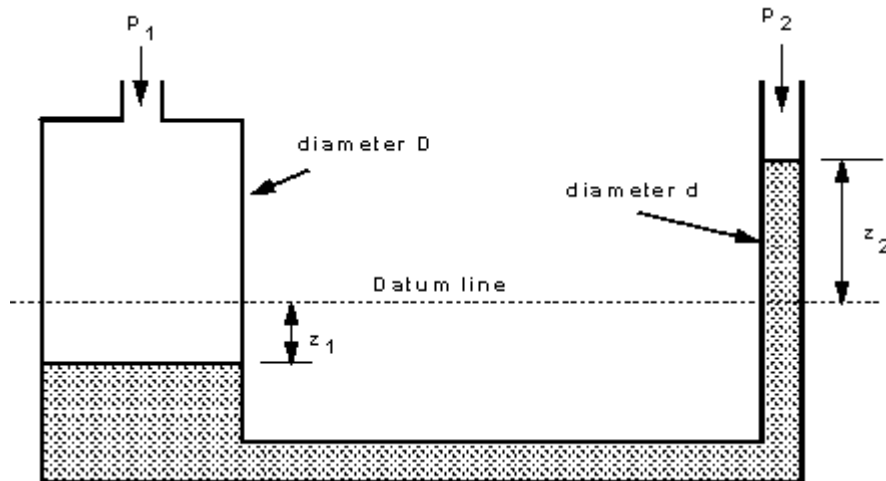

1.6 A flat circular plate, 1.25 m diameter is immersed in sewage water (density 1200 kg/m³) such that its greatest and least depths are 1.50 m and 0.60 m respectively. Determine the force exerted on one face by the water pressure,

[Ans: (15180 N)]

1.7 A rectangular block of wood, floats with one face horizontal in a fluid (RD = 0.9). The wood's density is 750 kg/m³. Determine the percentage of the wood, which is not submerged.

[Ans: 17%]

1.8 An empty balloon and its equipment weight 50 kg, is inflated to a diameter of 6m, with a gas of density 0.6 kg/m³. What is the maximum weight of cargo that can be lifted on this balloon, if air density is assumed constant at 1.2 kg/m³?

[Ans: 17.86 kg]

2 Internal Fluid Flow

Contents

- 2.1 Definitions.
- 2.2 Mass Conservation.
- 2.3 Energy Conservation.
- 2.4 Flow Measurement.
- 2.5 Flow Phenomena.
- 2.6 Darcy Formula.
- 2.7 The Friction Factor and Moody diagram.
- 2.8 Flow Obstruction Losses.
- 2.9 Fluid Power.
- 2.10 Fluid Momentum
- 2.11 Tutorial Problems

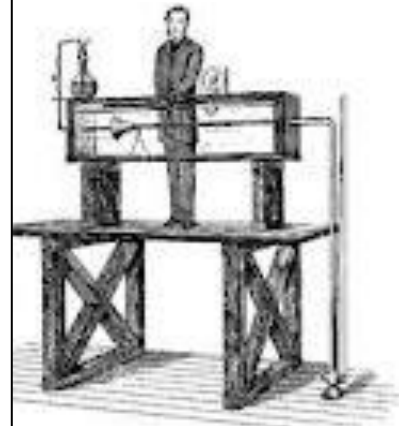

2.1 Definitions

Fluid Dynamics

The study of fluids in motion.

Static Pressure

The pressure at a given point exerted by the static head of the fluid present directly above that point. Static pressure is related to motion on a molecular scale.

Dynamic or Velocity Pressure

Dynamic pressure is related to fluid motion on a large scale i.e. fluid velocity.

Stagnation Pressure Total Pressure

The sum of the static pressure plus the dynamic pressure of a fluid at a point.

Streamline

An imaginary line in a moving fluid across which, at any instant, no fluid is flowing. ie it indicates the instantaneous direction of the flow.

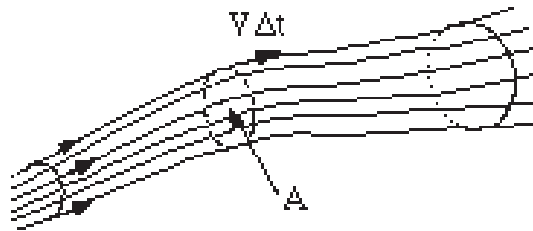

Figure 2.1 the stream tube

Stream tube

A ‘bundle’ of neighbouring streamlines may be imagined to form a stream tube (not necessarily circular) through which the fluid flows.

The banner features six small images in a row: blue pipes, a helicopter, a server room, a topographic map, a man in a suit, and a ship. Below the images, the words 'efficiency', 'reliability', and 'delivery' are written in white, with white arrows pointing down from the first three images to these words.

Please click the advert

As a leading technology company in the field of geophysical science, PGS can offer exciting opportunities in offshore seismic exploration.

We are looking for new BSc, MSc and PhD graduates with Geoscience, engineering and other numerate backgrounds to join us.

To learn more our career opportunities, please visit www.pgs.com/careers

A Clearer Image
www.pgs.com



Control volume

A fixed volume in space through which a fluid is continuously flowing. The boundary of a control volume is termed the **control surface**. The size and shape is entirely arbitrary and normally chosen such that it encloses part of the flow of particular interest.

Classification of Fluid behaviour

a) Steady or unsteady

A flow is termed steady if its properties do not vary with time.

A flow is termed unsteady if properties at a given point vary with time.

Quasi-steady flow is essentially unsteady but its properties change sufficiently slowly with respect to time, at a given point, that a series of steady state solutions will approximately represent the flow.

b) Uniform or Non-uniform

A uniform flow is one in which properties do not vary from point to point over a given cross-section.

Non-uniform flow has its properties changing with respect to space in a given cross-section.

c) One-dimensional or Multi-dimensional

One-dimensional flow, is one in which the direction and magnitude of the velocity at all points are identical. Variation of velocity in other directions is so small that they can be neglected. eg. flow of water in small bore pipe at low flow rates.

Two-dimensional flow is one in which the velocity has two main components.

Three-dimensional flow is one in which the flow velocity has significant components in all three directions.

d) Viscid or Inviscid

This some time distinguished as Viscid and inviscid flow in relation to the viscous forces whether they are neglected or taken into account

e) Compressible or Incompressible

If the changes in density are relatively small, the fluid is said to be incompressible. If the changes in density are appreciable, in case of the fluid being subjected to relatively high pressures, the fluid has to be treated as Compressible.

f) Ideal or Real

An ideal fluid is both inviscid and incompressible. This definition is useful in forming analytical solution to fluid flow problems.

Fluids in reality are viscous and compressible. Thus, the effect of compressibility and viscosity must be considered for accurate analysis. It must be stressed that in most common engineering applications at standard pressure and temperature, water can be assumed incompressible and inviscid. The assumption of ideal fluid can help to formulate a solution, an approximate solution, still better than no solution.

2.2 Conservation of Mass

The **continuity equation** applies the principle of conservation of mass to fluid flow. Consider a fluid flowing through a fixed volume tank having one inlet and one outlet as shown below.

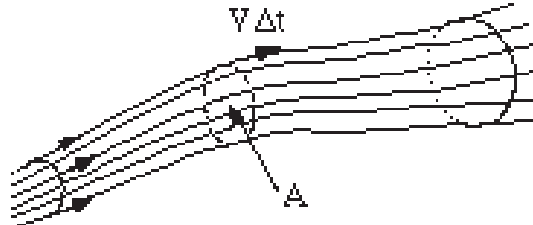

Figure 2.2 conservation of mass

If the flow is **steady** i.e. no accumulation of fluid within the tank, then the rate of fluid flow at entry must be equal to the rate of fluid flow at exit for mass conservation. If, at entry (or exit) having a cross-sectional area A (m^2), a fluid parcel travels a distance dL in time dt , then the volume flow rate (V , m^3/s) is given by: $V = (A \cdot dL)/\Delta t$

but since $dL/\Delta t$ is the fluid velocity (v , m/s) we can write: $Q = V \times A$

The mass flow rate (m , kg/s) is given by the product of density and volume flow rate

i.e. $m = \rho \cdot Q = \rho \cdot V \cdot A$

Between two points in flowing fluid for mass conservation we can write: $m_1 = m_2$

or $\rho_1 V_1 A_1 = \rho_2 V_2 A_2$ (2.1)

If the fluid is **incompressible** i.e. $\rho_1 = \rho_2$ then:

$V_1 A_1 = V_2 A_2$ (2.2)

Hence an incompressible flow in a constant cross-section will have a constant velocity. For branched systems the continuity equation implies that the *sum* of the incoming fluid mass (or volume) flow rates must equal the *sum* of the outgoing mass (or volume) flow rates.

Worked Example 2.1

Air enters a compressor with a density of 1.2 kg/m^3 at a mean velocity of 4 m/s in the $6 \text{ cm} \times 6 \text{ cm}$ square inlet duct. Air is discharged from the compressor with a mean velocity of 3 m/s in a 5 cm diameter circular pipe. Determine the mass flow rate and the density at outlet.

Solution:

Given: $\rho_1 = 1.2 \text{ kg/m}^3$, $V_1 = 4 \text{ m/s}$, $V_2 = 3 \text{ m/s}$

$$A_1 = 0.06 \times 0.06 = 0.0036 \text{ m}^2$$

$$A_2 = \frac{\pi D^2}{4} = \frac{3.142 \times 0.05^2}{4} = 0.00196 \text{ m}^2$$

The mass flow rate is:

$$m = \rho_1 A_1 V_1$$

$$= 1.2 \times 0.0036 \times 4$$

$$= 17.28 \times 10^{-3} \text{ kg/s}$$

Conservation of mass between sections 1 and 2 implies that:

$$\rho_1 A_1 V_1 = \rho_2 A_2 V_2$$

Please click the advert



5365/07/09

Going up in the world...

You'll be going up in the world after graduating from Nottingham Trent University. We are one of the best universities in England for graduate employment with over 97% of our students employed or in further study within six months of graduating.*

- Consistently ranked as one of the leading modern universities in *The Independent Good University Guide*.
- Courses informed by businesses and industry – strong commercial partnerships with over 6,000 companies globally.
- Many courses include professional accreditation and / or the opportunity to undertake a work placement. This gives our graduates a competitive edge when entering the job market.
- An exciting student city in the middle of England. Ideally located for travel across the UK and with direct flights to destinations across Europe from East Midlands Airport.
- Investing £130 million across our three campuses to create an inspiring learning environment.
- In the most recent QAA institutional review, the University received the highest commendation for its consistent commitment to supporting students and their learning.

If you would like any guidance on applying to Nottingham Trent University please contact Laura Vella, our International Officer for Europe, on

Tel: +44 (0)115 848 8180

Email: laura.vella@ntu.ac.uk

www.ntu.ac.uk/book

NOTTINGHAM
TRENT UNIVERSITY

* HESA DHLE 2006-07

Hence the density at section 2 is calculated:

$$\rho_2 = \frac{m}{A_2 x V_2} = \frac{17.28 \times 10^{-3}}{0.00196 \times 3} = 2.933 \text{ kg/m}^3$$

2.3 Conservation of Energy

There are three forms of non-thermal energy for a fluid at any given point:-

The **kinetic energy** due to the motion of the fluid.

The **potential energy** due to the positional elevation above a datum.

The **pressure energy**, due to the absolute pressure of the fluid at that point.

Conservation of energy necessitates that the total energy of the fluid remains constant, however, there can be transformation from one form to another.

If all energy terms are written in the form of the **head** (potential energy), ie in metres of the fluid, then:

$$\frac{p}{\rho g} \text{ represents the pressure head (sometimes known as 'flow work')}$$

$$\frac{V^2}{2g} \text{ represents the velocity head (also known as kinetic energy)}$$

The energy conservation, thus, implies that between any two points in a fluid

$$\left(\frac{p}{\rho g} + \frac{V^2}{2g} + z \right)_1 = \left(\frac{p}{\rho g} + \frac{V^2}{2g} + z \right)_2 \quad (2.3a)$$

This equation is known as the **Bernoulli equation** and is valid if the two points of interest 1 & 2 are very close to each other and there is no loss of energy.

In a real situation, the flow will suffer a loss of energy due to friction and obstruction between stations 1 & 2, hence

$$\left(\frac{p}{\rho g} + \frac{V^2}{2g} + z \right)_1 = \left(\frac{p}{\rho g} + \frac{V^2}{2g} + z \right)_2 + h_L \quad (2.3b)$$

where h_L is the loss of energy between the two stations.

When the flow between stations 1 & 2 is caused by a pump situated between the two stations, the energy equation becomes:

$$\left(\frac{p}{\rho g} + \frac{V^2}{2g} + z \right)_1 + h_p = \left(\frac{p}{\rho g} + \frac{V^2}{2g} + z \right)_2 + h_L \quad (2.3c)$$

Where h_p is the head gain due to the pump.

Worked Example 2.2

A jet of water of 20 mm in diameter exits a nozzle directed vertically upwards at a velocity of 10 m/s. Assuming the jet retains a circular cross-section, determine the diameter (m) of the jet at a point 4.5 m above the nozzle exit. Take $\rho_{\text{water}} = 1000 \text{ kg/m}^3$.

Solution:

Bernoulli equation:
$$\frac{p_1}{\rho g} + \frac{v_1^2}{2g} + z_1 = \frac{p_2}{\rho g} + \frac{v_2^2}{2g} + z_2$$

Given: $v_1 = 10 \text{ m/s}$, $z_1 = 0$ (Datum) $z_2 = 4.5 \text{ m}$. $p_1 = p_2$ (both atmospheric). The energy equation reduces to:

$$\frac{v_2^2}{2g} = \frac{v_1^2}{2g} + z_1 - z_2$$

hence :

$$v_2 = \sqrt{v_1^2 - 2gh} = \sqrt{10^2 - 19.62 \times 4.5} = 3.42 \text{ m/s}$$

From continuity equation:
$$A_2 = \frac{A_1 v_1}{v_2} = \frac{\pi \times 0.01^2 \times 10}{3.42} = 9.18 \times 10^{-4} \text{ m}^2$$

Hence

$$A_2 = \frac{\pi \cdot D_2^2}{4}$$

$$D_2 = \sqrt{\frac{4 \times 9.18 \times 10^{-4}}{3.14}} = 0.034 \text{ m}$$

2.4 Flow Measurement

There are a large number of devices for measuring fluid flow rates to suit different applications. Three of the most commonly encountered *restriction* methods will be presented here.

Restriction methods of fluid flow are based on the acceleration or deceleration of the fluid through some kind of nozzle, throat or *vena contracta*.

The theoretical analysis applies the continuity and Bernoulli equations to an ideal fluid flow between points 1 and 2 thus:-

Start with Bernoulli equation:
$$\frac{p_1}{\rho g} + \frac{v_1^2}{2g} + z_1 = \frac{p_2}{\rho g} + \frac{v_2^2}{2g} + z_2$$

Rearranging
$$p_1 - p_2 = \frac{\rho \cdot V_2^2}{2} [1 - (V_1/V_2)^2]$$

Please click the advert

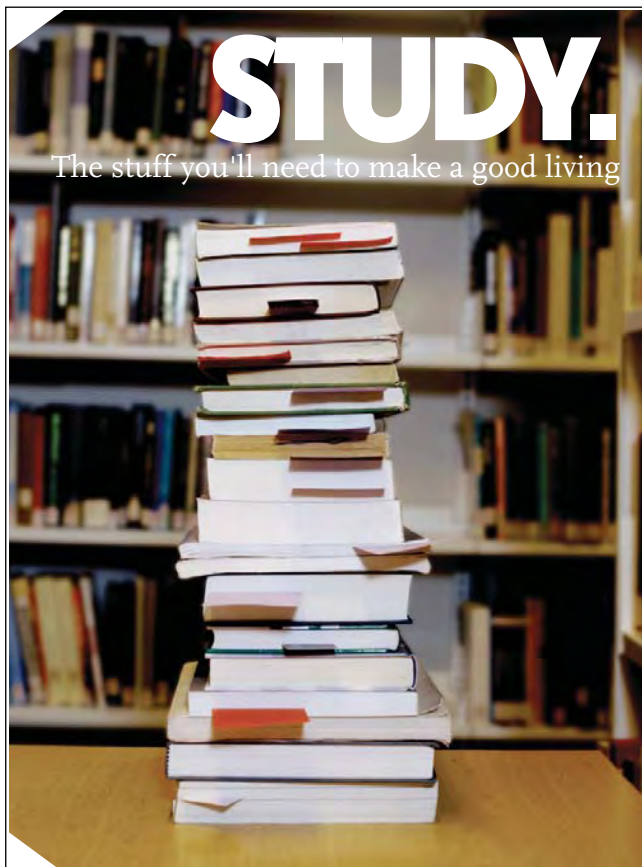

NORWAY.
YOUR IDEAL STUDY DESTINATION.

WWW.STUDYINNORWAY.NO
FACEBOOK.COM/STUDYINNORWAY

LOOK UP 
STUDY IN NORWAY.

Then use the continuity equation $V_1 A_1 = V_2 A_2$

Therefore $(V_1/V_2)^2 = (A_2/A_1)^2$

Substituting into the rearranged Bernoulli equation and solving for V_2 we have:-

$$V_2 = \sqrt{\frac{2(p_1 - p_2)}{\rho[1 - (A_2/A_1)^2]}} \quad (2.4)$$

The theoretical volume flow rate is $Q = A_2 V_2$

And the theoretical mass flow rate is $\dot{m} = \rho A_2 V_2$

The above values are theoretical because *ideal* fluid flow conditions were assumed. Actual flow rate values are obtained by multiplying the theoretical values by a meter discharge coefficient C_d to account for frictional and obstruction losses encountered by the fluid in its passage through the meter. The energy losses manifest themselves as a greater pressure drop ($P_1 - P_2$) than that predicted by the theory.

It can be shown that $V_a = C_d x \sqrt{\frac{2(P_1 - P_2)}{\rho[1 - (D_2 / D_1)^4]}}$ (2.5)

(a) The Venturi meter

The Venturi meter has a converging section from the initial pipe diameter down to a throat, followed by a diverging section back to the original pipe diameter. See figure.

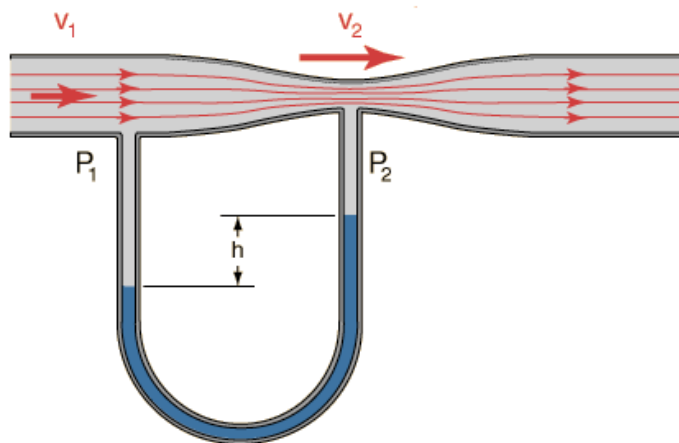

Figure 2.2 the Venturi tube

Differential pressure measurements are taken between the inlet (1) and throat (2) positions. The geometry of the meter is designed to minimize energy losses ($C_d > 0.95$).

(b) The Orifice meter

An orifice meter is a flat plate, with a hole which may be square edged or bevelled, inserted between two flanges in a pipe line. In this instance positions (1) and (2) are as shown below. Orifice plates have a simple construction and are therefore inexpensive but they suffer from high energy losses ($C_d = 0.6$).

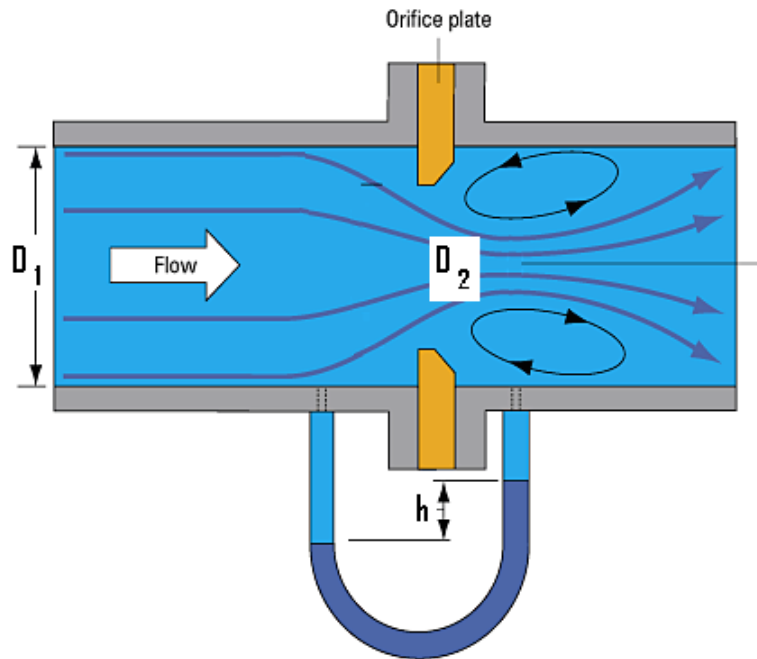

Figure 2.3 the Orifice meter

(c) The Pitot-static tube

A slender concentric tube arrangement, aligned with the flow, used to measure flow velocity by means of a pressure difference. See figure below. The outer tube is closed in the flow direction but has sidewall holes to enable the measurement of static pressure. The inner tube is open in the direction of the fluid flow and is thus experiencing the total (static + dynamic) pressure of the fluid flow. It is assumed that the fluid velocity is rapidly brought to zero upon entry to the inner tube with negligible friction ($C_d \sim 1$). The pressure difference between the tubes is applied to a U tube manometer which will therefore indicate the velocity pressure.

Start with Bernoulli equation:
$$\frac{p_1}{\rho g} + \frac{v_1^2}{2g} + z_1 = \frac{p_2}{\rho g} + \frac{v_2^2}{2g} + z_2$$

Since the Pitot-static tube is mounted horizontally, the z -terms will cancel out, and the static end is motionless, ie $V_2 = 0$. It can be shown that the duct velocity V_1 is given by:-

$$v_1 = \sqrt{\frac{2(P_t - P_s)}{\rho_f}} = \sqrt{\frac{2 \cdot \rho_m \cdot g \cdot h}{\rho_f}} \quad (2.6)$$

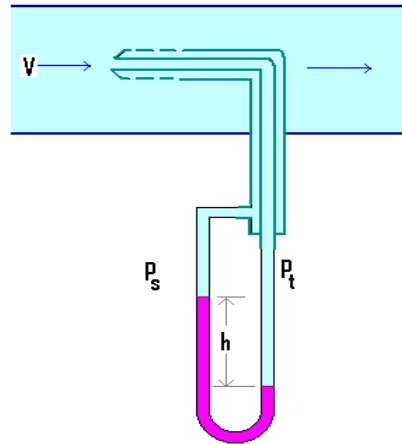

Figure 2.4 Pitot-static tube

Worked Example 2.3

A Venturi meter fitted in a 15 cm pipeline has a throat diameter of 7.5 cm. The pipe carries water, and a U-tube manometer mounted across the Venturi has a reading of 95.2 mm of mercury. Determine:

1. the pressure drop in **Pascal's**, indicated by the manometer
2. the **ideal** throat velocity (m/s)
3. the **actual** flow rate (l/s) if the meter C_D is 0.975.

Please click the advert

Are you considering a European business degree?

LEARN BUSINESS at university level. We mix cases with cutting edge research working individually or in teams and everyone speaks English. Bring back valuable knowledge and experience to boost your career.

MEET a culture of new foods, music and traditions and a new way of studying business in a safe, clean environment – in the middle of Copenhagen, Denmark.

ENGAGE in extra-curricular activities such as case competitions, sports, etc. – make new friends among CBS' 18,000 students from more than 80 countries.

Copenhagen Business School
HÅNDELSSHØJSKOLEN

See what we look like and how we work on cbs.dk

Solution:

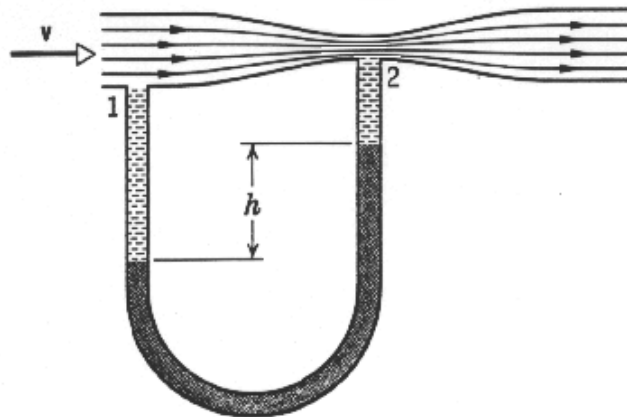

$$(i) \quad p_1 - p_2 = \rho_m \times g \times h$$

$$= 13600 \times 9.81 \times 0.0952 = 12701 \text{ Pa}$$

$$(ii) \quad v_2 = \sqrt{\frac{2(p_1 - p_2)}{\rho[1 - (A_2 / A_1)^2]}} = \sqrt{\frac{2(12701)}{1000[1 - (0.0629)^2]}} = 5.206 \text{ m / s}$$

$$(iii) \quad Q = C_d V_2 A_2$$

$$= 0.975 \times 5.206 \times 0.00441$$

$$= 0.0224 \text{ m}^3/\text{s} = 22.4 \text{ l/s}$$

2.5 Flow Regimes

Consider the variation in velocity across the cross-section of a pipe containing a fluid in motion. There is no motion of fluid in direct contact with the pipe wall, and the velocity of the fluid stream increases in a direction away from the walls of the pipe. In 1839, Hagen (USA) observed that the fluid moves in layers with a velocity gradient. He observed that the velocity gradient in a circular pipe follows a parabolic law, at low flow rates. This type of flow is termed **LAMINAR**.

When the flow rate of the fluid stream is high, the velocity distribution had a much flatter shape and this type of flow is known as **TURBULENT**.

The average velocity producing turbulent flow is greater than that for a laminar flow of a given fluid in a given duct.

For both flows, the build-up of velocity is along the radius of the pipe, and the maximum velocity occurs at the centre line.

Osborne Reynolds demonstrated experimentally in 1883 (Manchester) that under laminar flow, the fluid streamlines remain parallel. This was shown with the aid of a dye filament injected in the flow which remained intact at low flow velocities in the tube. As the flow velocity was increased (via a control valve), a point was reached at which the dye filament at first began to oscillate then broke up so that the colour was diffused over the whole cross-section indicating that particles of fluid no longer moved in an orderly manner but occupied different relative positions in successive cross-sections downstream.

Reynolds also found that it was not only the average pipe velocity V which determined whether the flow was laminar or turbulent, but that the density (ρ) and viscosity (μ) of the fluid and the pipe diameter (D), also determined the flow regime. He proposed that the criterion which determined the type of regime was the dimensionless group $(\rho v D / \mu)$. This group has been named the **Reynolds number** (Re) as a tribute to his contribution to Fluid Mechanics.

$$Re = \rho V D / \mu \quad (2.7)$$

Based on Reynolds number the flow can be distinguished into three regimes for pipe flow:

Laminar if $Re < 2000$

Transitional if $2000 < Re < 4000$

Turbulent if $Re > 4000$

$Re = 2000, 4000$ are the lower and upper critical values.

2.6 Darcy Formula

Consider a duct of length L , cross-sectional area A_c , surface area A_s , in which a fluid of density ρ , is flowing at mean velocity V . The forces acting on a segment of the duct are that due to pressure difference and that due to friction at the walls in contact with the fluid.

If the acceleration of the fluid is zero, the net forces acting on the element must be zero, hence

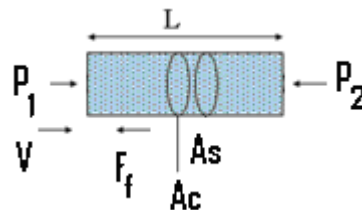

According to Newton's Second Law of Motion for a constant velocity flow:

$$\sum F = 0$$

The force due to pressure on either side of the section is equal to the friction force resisting the flow:

$$(P_1 - P_2) \cdot A_c - (f \rho V^2 / 2) \cdot A_s = 0$$

Where the pressures act normal to the flow direction on the area of cross-section A_c , and the frictional force acts on the circumferential wall area A_s , separating the fluid and the pipe's surface.

Let h_f denote the head lost (m) due to friction over a duct length L ,

$$\text{ie } p_1 - p_2 = \rho g h_f$$

Substituting we get

$$h_f = f \cdot (A_s/A_c) \cdot V^2/2g$$

For a pipe $A_s/A_c = \pi D L / \pi D^2/4 = 4L/D$

$$h_f = (4 fL/D) \cdot V^2/2g \quad (2.8)$$

This is known as Darcy formula.

2.7 The Friction factor and Moody diagram

The value of the friction factor (f) depends mainly on two parameters namely the value of the Reynolds number and the surface roughness.

Please click the advert

Technical training on *WHAT* you need, *WHEN* you need it

At IDC Technologies we can tailor our technical and engineering training workshops to suit your needs. We have extensive experience in training technical and engineering staff and have trained people in organisations such as General Motors, Shell, Siemens, BHP and Honeywell to name a few.

Our onsite training is cost effective, convenient and completely customisable to the technical and engineering areas you want covered. Our workshops are all comprehensive hands-on learning experiences with ample time given to practical sessions and demonstrations. We communicate well to ensure that workshop content and timing match the knowledge, skills, and abilities of the participants.

We run onsite training all year round and hold the workshops on your premises or a venue of your choice for your convenience.

For a no obligation proposal, contact us today at training@idc-online.com or visit our website for more information: www.idc-online.com/onsite/

Phone: **+61 8 9321 1702**
 Email: training@idc-online.com
 Website: www.idc-online.com



- OIL & GAS ENGINEERING**
- ELECTRONICS**
- AUTOMATION & PROCESS CONTROL**
- MECHANICAL ENGINEERING**
- INDUSTRIAL DATA COMMS**
- ELECTRICAL POWER**



For *laminar* flow (ie $Re < 2000$), the value of the friction factor is given by the following equation *irrespective of the nature of the surface*:

$$f = \frac{16}{Re^{0.25}} \quad (2.9)$$

While for a *smooth* pipe with *turbulent* (i.e. $Re > 4000$) flow, the friction factor is given by:

$$f = \frac{0.079}{Re} \quad (\text{Blasius equation}) \quad (2.10)$$

For $Re > 2000$ and $Re < 4000$, this region is known as the critical zone and the value of the friction factor is uncertain and not quoted on the Moody diagram (Figure 2.5).

In the turbulent zone, if the surface of the pipe is not perfectly smooth, then the value of the friction factor has to be determined from the **Moody diagram**.

The **relative roughness** (k/d) is the ratio of the average height of the surface projections on the inside of the pipe (k) to the pipe diameter (D). In common with Reynolds number and friction factor this parameter is dimensionless. Values of k are tabled on the Moody chart for a sample of materials.

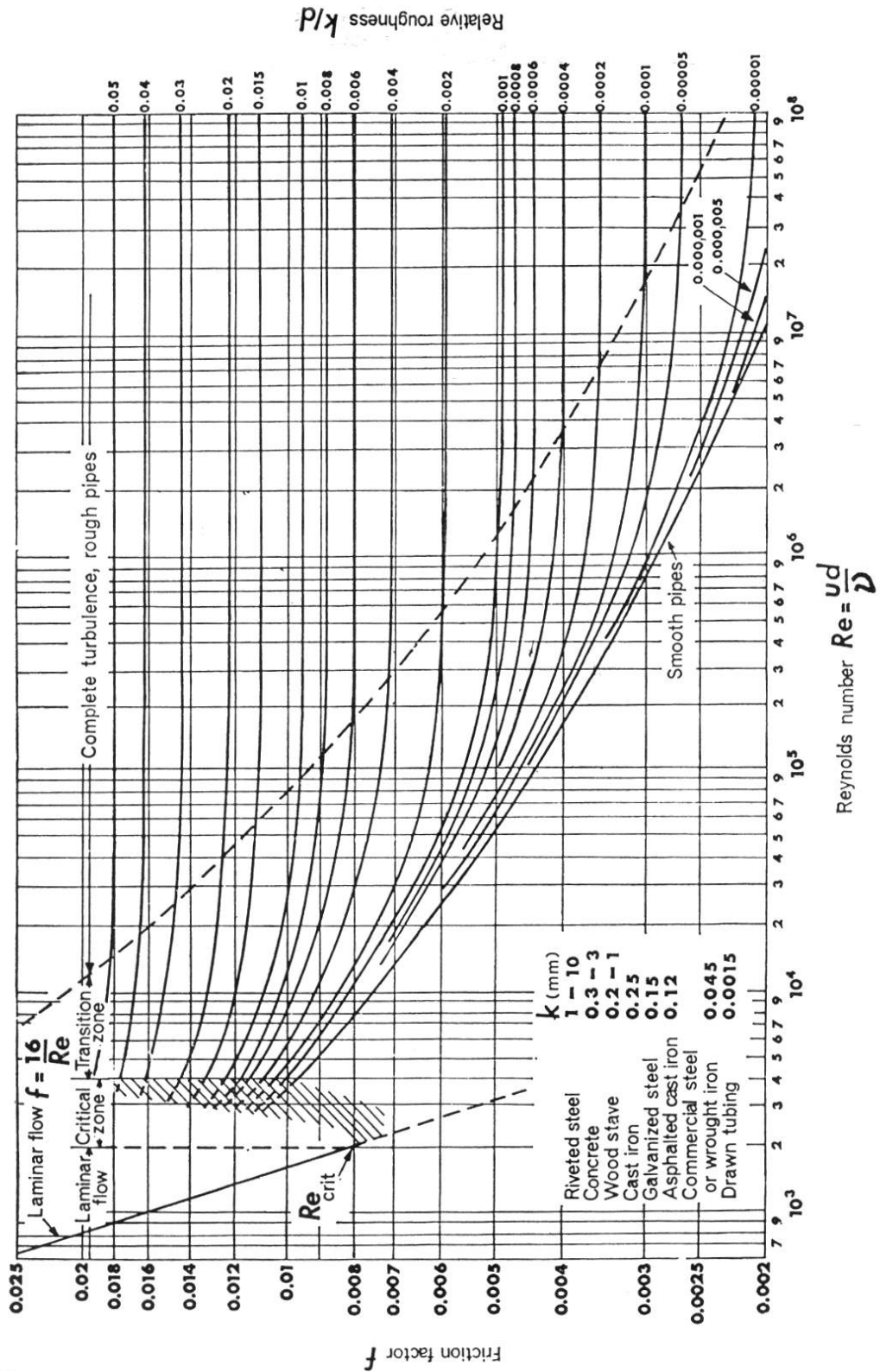

Figure 2.5 the Moody Chart/diagram

Worked Example 2.4

Water flows in a 40mm diameter commercial steel pipe ($k = 0.045 \times 10^{-3} \text{ m}$) at a rate of 1 litre/s. Determine the friction factor and head loss per metre length of pipe using:

1. The Moody diagram
2. Smooth pipe formulae. Compare the results.

Take: $\rho = 1000 \text{ kg/m}^3$, $\mu = 1 \times 10^{-3} \text{ kg/ms}$

Solution:

$$V = Q/A = 0.001 / (1.256 \times 10^{-3}) = 0.796 \text{ m}^2$$

$$\text{Re} = \rho V D / \mu$$

$$= 1000 \times 0.796 \times 0.04 / 1 \times 10^{-3} = 31840 \text{ i.e. turbulent}$$

1. Moody diagram

$$k/D = 0.045 \times 10^{-3} / 0.04 = 0.0011$$

From intersection of k/D and Re values on Moody diagram read off $f = 0.0065$

Please click the advert

www.studyat.tudelft.nl

- Ranked #15th in the world (THES Technology ranking 2009)
- Almost 170 years of problem solving experience
- Excellent Sports&Culture facilities
- Check out what and how we teach at www.ocw.tudelft.nl !

TU Delft Delft University of Technology
Challenge the future

Download free ebooks at bookboon.com

Therefore

$$\begin{aligned} h_f &= 4xfx \frac{L v^2}{D 2g} \\ &= 4 \times 0.0065 \times \frac{1}{0.04} \times \frac{0.796^2}{19.62} \\ &= 0.0209 \text{ m/m pipe} \end{aligned}$$

2. Using Blasius equation for smooth pipe:

$$\begin{aligned} f &= 0.079/\text{Re}^{0.25} \\ &= 0.079/(31840)^{0.25} = 0.0059 \\ h_f &= 4 \times 0.0059 \times \frac{1}{0.04} \times \frac{0.796^2}{19.62} \\ &= 0.02 \text{ m/m pipe} \end{aligned}$$

i.e. 9% less than Moody.

Note that if the pipe is assumed smooth, the friction factor from the Moody diagram would be $f = 0.0058$ which is closer to the Blasius value.

2.8 Flow Obstruction Losses

When a pipe changes direction, changes diameter or has a valve or other fittings there will be a loss of energy due to the disturbance in flow. This loss of energy (h_o) is usually expressed by:

$$h_o = K \cdot \frac{V^2}{2g} \quad (2.11)$$

Where V is the mean velocity at entry to the fitting and K is an empirically determined factor. Typical values of K for different fittings are given in the table below:

Obstruction	K
tank exit	0.5
tank entry	1.0
smooth bend	0.30
Mitre bend	1.1
Mitre bend with guide vanes	0.2
90 degree elbow	0.9
45 degree elbow	0.42
Standard T	1.8
Return bend	2.2
Strainer	2.0
Globe valve, wide open	10.0
Angle valve, wide open	5.0
Gate valve, wide open	0.19
$\frac{3}{4}$ open	1.15
$\frac{1}{2}$ open	5.6
$\frac{1}{4}$ open	24.0
Sudden enlargement	0.10
Conical enlargement: 6°	0.13
(total included angle) 10°	0.16
15°	0.30
25°	0.55
Sudden contractions:	
area ratio 0.2	0.41
(A_2/A_1) 0.4	0.30
0.6	0.18
0.8	0.06

Table 2.1: Obstruction Losses in Flow Systems

2.9 Fluid Power

The fluid power available at a given point for a fluid is defined as the product of mass, acceleration due to gravity and the fluid head, and since the mass flow rate is defined as the volume flow rate multiplied by the fluid density, the Fluid power therefore can be expressed as:

$$P = \rho \cdot g \cdot Q \cdot h_{\text{tot}} \quad (2.12a)$$

For a **pump**, h_{tot} represents the head required to overcome pipe friction (h_f), obstruction losses (h_o) and to raise the fluid to any elevation required (h_z).

$$\text{ie } h_{\text{tot}} = h_z + h_f + h_o \quad (2.13a)$$

Note: If the delivery tank operates at pressure in excess of the supply tank an additional term (h_p) must be added to the required head equation as this pressure rise must also be supplied by the pump.

If the pump efficiency η_p is introduced, the actual pump head requirement is:

$$P = \rho \cdot g \cdot Q \cdot h_{\text{tot}} / \eta_p \quad (2.12b)$$

For a **turbine** with efficiency η_t , the power output is given by:

$$P = \rho \cdot g \cdot Q \cdot h_{\text{tot}} \cdot \eta_t \quad (2.12c)$$

$$\text{Where } h_{\text{tot}} = h_z - (h_f + h_o) \quad (2.13b)$$

Worked Example 2.5

Determine the input power to an electric motor ($\eta_m = 90\%$) supplying a pump ($\eta_p = 80\%$) delivering 50 l/s of water ($\rho = 1000 \text{ kg/m}^3$, $\mu = 0.001 \text{ kg/ms}$) from tank1 to tank 2 as shown below if the pipeline length is 200m long, of 150 mm diameter galvanised steel (assumed surface roughness $k=0.15\text{mm}$).

Please click the advert

Study at one of Europe's leading universities



DTU, Technical University of Denmark, is ranked as one of the best technical universities in Europe, and offers internationally recognised Master of Science degrees in 39 English-taught programmes.

DTU offers a unique environment where students have hands-on access to cutting edge facilities and work

closely under the expert supervision of top international researchers.

DTU's central campus is located just north of Copenhagen and life at the University is engaging and vibrant. At DTU, we ensure that your goals and ambitions are met. Tuition is free for EU/EEA citizens.

Visit us at www.dtu.dk

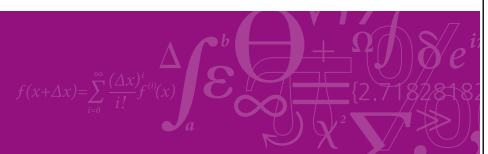

Download free ebooks at bookboon.com

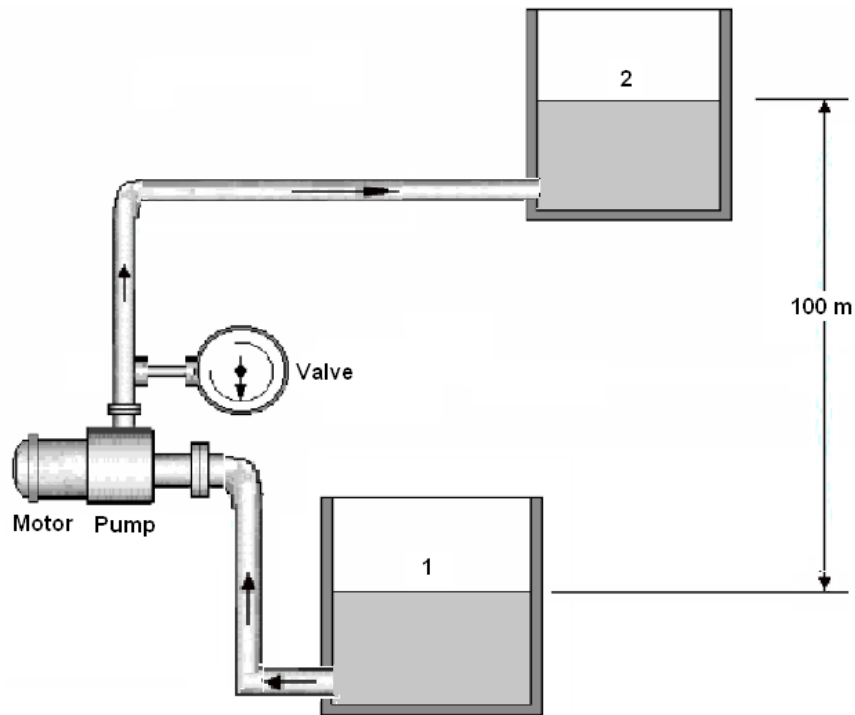
**Solution:**

$$V = Q/A = 0.05/(\pi \times 0.15^2/4) = 2.83 \text{ m/s}$$

$$Re = \rho V D / \mu = 1000 \times 2.83 \times 0.15 / 0.001 = 4.244 \times 10^5$$

$$k/D = 0.15/150 = 0.001; \text{ From Moody diagram } f = 0.0051$$

$$h_f = \frac{4 f L v^2}{D 2g} = \frac{4 \times 0.0051 \times 200}{0.15} \times \frac{2.83^2}{2 \times 9.81} = 11.1 \text{ m}$$

Three bends (each $K=0.9$), tank entry ($k=0.5$), exit loss ($k=1$) and one valve ($k=5$)

$$h_o = \sum K_i x \left[\frac{v^2}{2g} \right] = (3 \times 0.9 + 0.5 + 1 + 5) \times \frac{2.83^2}{2 \times 9.81} = 3.75 \text{ m}$$

$$h_{\text{sys}} = H_f + H_z + H_o = 11.1 + 3.75 + 100 = 114.85 \text{ m}$$

$$\text{Input power } P = \frac{\rho \cdot g \cdot Q \cdot H_{\text{sys}}}{\eta_m \eta_p} = \frac{1000 \times 9.81 \times 0.05 \times 114.85}{0.9 \times 0.8} = 78.3 \text{ kW}$$

2.10 Fluid Momentum

Knowledge of the forces exerted by moving fluids is important in the design of hydraulic machines and other constructions. The Continuity and Bernoulli relationships are not sufficient to solve forces acting on bodies in this case and the momentum principle derived from Newton's Laws of motion is also required.

Momentum is defined as the product of mass and velocity, and represents the energy of motion stored in the system. Momentum is a vector quantity and can only be defined by specifying its direction as well as magnitude.

Newton's Second Law of Motion

“The rate of change of momentum is proportional to the net force acting, and takes place in the direction of that force”.

$$\text{i.e. } \sum F = \frac{dM}{dt} \quad (2.14)$$

Since $M = m \cdot V$

$$\sum F = \frac{dV}{dt} + V \frac{dm}{dt}$$

Newton's Third Law of Motion

“To every action there is a reaction equal in magnitude and opposite in direction”.

Application of Momentum Equation

Consider horizontal jet impinging a surface tangentially at a steady state.

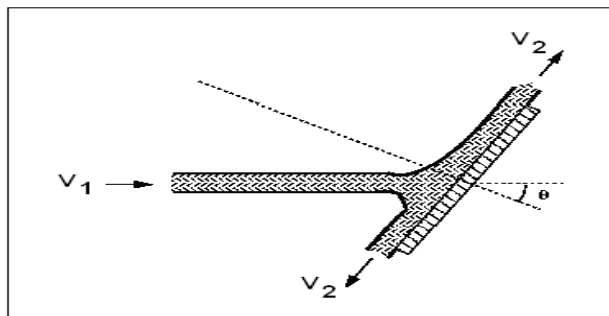

$$\sum F_x = m \frac{dV}{dt} + V \frac{dm}{dt} = \dot{m}dV + V \frac{dm}{dt}$$

Resolving horizontally we have for the x-component

$$-F_x = \dot{m}(V_2 \cos \theta - V_1) \text{ since } \frac{dm}{dt} = 0 \text{ (steady flow)}$$

Resolving vertically we have for the y-component

$$F_y = \dot{m}(V_2 \sin \theta - 0)$$

The resultant force acting on the solid surface due to the jet is given by

$$F_R = \sqrt{F_x^2 + F_y^2}$$

acting through

$$\theta_R = \tan^{-1}\left(\frac{F_y}{F_x}\right)$$

Let $V_2 = kV_1$ where k is 'Friction Coefficient' ($0 < k < 1$)

$$\therefore F_x = \rho A V_1^2 (1 - k \cos \theta) \quad \text{and} \quad F_y = \rho A V_1^2 k \sin \theta$$

If smooth, then $k = 1$ and

$$F_x = \rho A V_1^2 (1 - \cos \theta), \quad F_y = \rho A V_1^2 \sin \theta$$

Special cases:

The angle of the striking jet has a very important effect on the force, 3 different angles are illustrated below:



MSM

MAASTRICHT SCHOOL OF MANAGEMENT

Increase your impact with MSM Executive Education





For almost 60 years Maastricht School of Management has been enhancing the management capacity of professionals and organizations around the world through state-of-the-art management education.

Our broad range of Open Enrollment Executive Programs offers you a unique interactive, stimulating and multicultural learning experience.

Be prepared for tomorrow's management challenges and apply today.

For more information, visit www.msm.nl or contact us at +31 43 38 70 808 or via admissions@msm.nl

the globally networked management school

Please click the advert

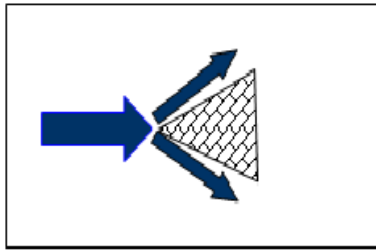
**Conical Wedge**

$$\theta = 60^\circ, \cos \theta = 0.5$$

$$F_x = -\frac{1}{2} \rho A V_1^2$$

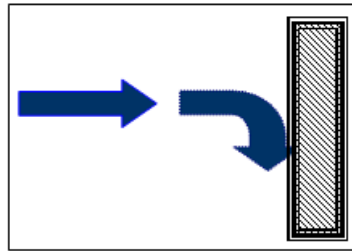
**Flat Plate**

$$\theta = 90^\circ, \cos \theta = 0$$

$$F_x = -\rho A V_1^2$$

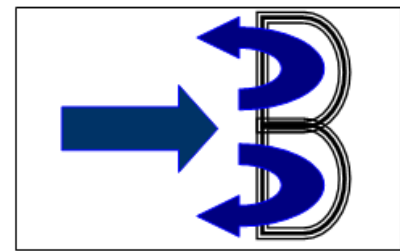
**Hemispherical Cup**

$$\theta = 180^\circ, \cos \theta = -1$$

$$F_x = -2 \rho A V_1^2$$

Worked Example 2.6

A jet of water having a diameter of 7.5 cm and a velocity of 30 m/s strikes a stationary flat plate at angle $\theta = 30^\circ$ as shown below.

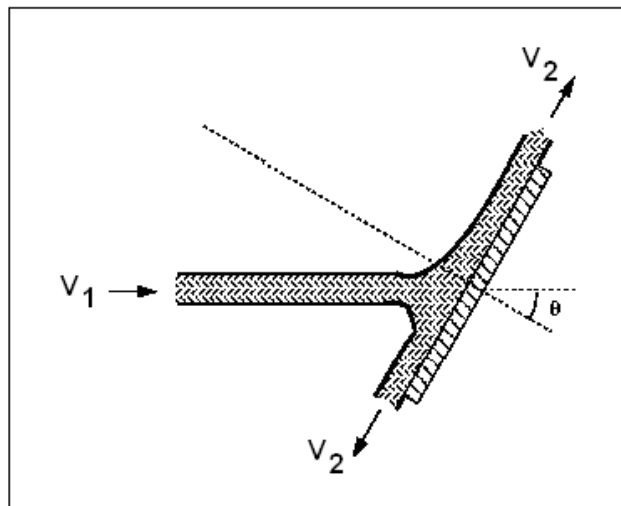

Determine the magnitude and direction of the resultant force on the plate assuming there is no friction between the jet and the plate. Take $\rho_{\text{water}} = 1000 \text{ kg/m}^3$.

Solution:

$$A = 0.00442 \text{ m}^2$$

$$\text{Smooth i.e. } k = 1, V_1 = V_2 = 30 \text{ m/s}$$

$$\begin{aligned} F_x &= \rho A V_1^2 (1 - \cos \theta) \\ &= 1000 \times 0.00442 \times 30^2 (1 - \cos 30) \\ &= 533 \text{ N} \end{aligned}$$

$$\begin{aligned}
 F_y &= \rho A V_1^2 \sin \theta \\
 &= 1000 \times 0.00442 \times 30^2 \times \sin 30 \\
 &= 1989 \text{ N}
 \end{aligned}$$

$$F_R = F_R = \sqrt{F_x^2 + F_y^2} = \sqrt{533^2 + 1989^2} = 2060 \text{ N}$$

$$\theta_R = \tan^{-1} \left\{ \frac{F_y}{F_x} \right\} = \tan^{-1} \left\{ \frac{1989}{533} \right\} = 75^\circ$$

Flow forces on a Reducer Bend

The change of momentum of a fluid flowing through a pipe bend induces a force on the pipe.

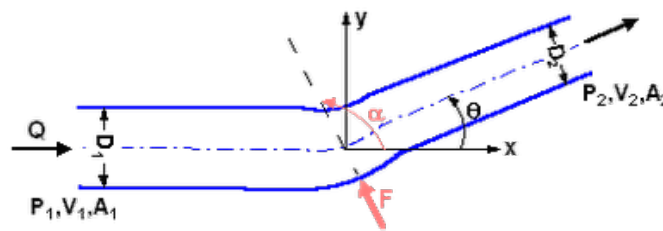

The pressures are to be considered in this case since the reducer bend is part of flowing system which is not subjected to atmospheric conditions.

x - Momentum

$$-F_x + p_1 A_1 - p_2 A_2 \cos \theta = \rho \dot{V} (V_2 \cos \theta - V_1)$$

y - Momentum

$$-F_y + p_2 A_2 \sin \theta = \rho Q (-V_2 \sin \theta - 0)$$

The total force

$$\begin{aligned}
 F &= \sqrt{F_x^2 + F_y^2} \\
 &= \left(\rho^2 Q^2 V_1^2 \left(1 - 2 \frac{A_1}{A_2} \cos \theta + \frac{A_1^2}{A_2^2} \right) + 2r \dot{V}^2 [p_1 + p_2 - (P_1 \frac{A_1}{A_2} + \dots \text{etc})] \right)^{1/2}
 \end{aligned}$$

From continuity equation: $V_2 = V_1 \times \frac{A_1}{A_2}$

For $A_1 = A_2$ and $\theta = 90^\circ$

$$F = (2 \rho Q^2 (\rho V_1^2 + p_1 + p_2) + p_1^2 A_1^2 [1 - \left(\frac{p_1}{p_2}\right)^2])^{1/2}$$

The force acting at an angle $\theta_R = \tan^{-1} \left(\frac{F_y}{F_x} \right)$ with the x - axis

Worked Example 2.7

A bend in a horizontal pipeline reduces from 600 mm to 300 mm whilst being deflected through 60°. If the pressure at the larger section is 250 kPa, for a water flow rate of 800 l/s determine the magnitude and direction of the resulting force on the pipe.

Take $\rho_{\text{water}} = 1000 \text{ kg/m}^3$

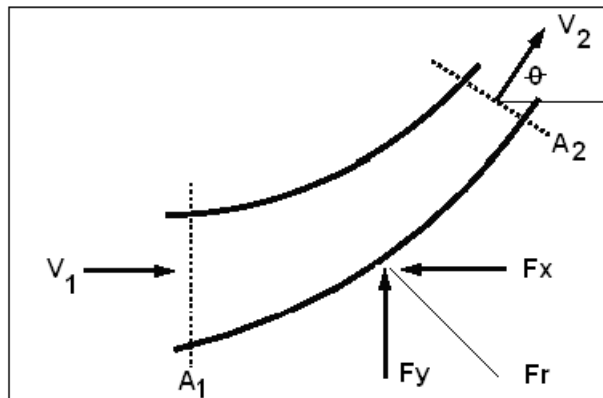

Please click the advert

What do the telephone handset and the refrigerator have in common with the pacemaker and the computer mouse?

They are all Swedish inventions used every day worldwide.

Challenge Yourself – Study in Sweden

www.studyinsweden.se

Solution:

From Continuity

$$Q = V_1 A_1 \quad V_1 = 0.8/0.282 = 2.83 \text{ m/s}$$

$$Q = V_2 A_2 \quad V_2 = 0.8/0.07 = 11.42 \text{ m/s}$$

From Bernoulli equation:

$$P_2 = \left[P_1 + \frac{1}{2} \rho (V_1^2 - V_2^2) \right] = 250 \times 10^3 + 0.5 \times 1000 \times (2.83^2 - 11.42^2) = 188.8 \text{ kPa}$$

From Momentum equation:

$$\begin{aligned} F_x &= p_1 A_1 - p_2 A_2 \cos \theta - \rho Q (V_2 \cos \theta - V_1) \\ &= [250 \times 10^3 \times 0.282] - [188.8 \times 10^3 \times 0.07 \times 0.5] - [1000 \times 0.8((11.42 \times 0.5) - 2.83)] \\ &= 61589.4 \text{ N} \end{aligned}$$

$$\begin{aligned} F_y &= p_2 A_2 \sin \theta - \rho Q (-V_2 \sin \theta - 0) \\ &= [188.796 \times 10^3 \times 0.07 \times 0.866] - [1000 \times 0.8(-9.889)] = 19356 \text{ N} \end{aligned}$$

$$F_R = \sqrt{F_x^2 + F_y^2} = \sqrt{61589.4^2 + 19356^2} = 64.559 \times 10^3 \text{ N}$$

$$\theta_R = \tan^{-1} \left(\frac{F_y}{F_x} \right) = \tan^{-1} \left(\frac{19356}{61589} \right) = 17.44^\circ$$

Worked Example 2.8

A siphon has a uniform circular bore of 75 mm diameter and consists of a bent pipe with its crest 1.4 m above water level and a discharge to the atmosphere at a level 2 m below water level. Find the velocity of flow, the discharge and the absolute pressure at crest level if the atmospheric pressure is 98.1 kN/m². Neglect losses due to friction.

Solution:

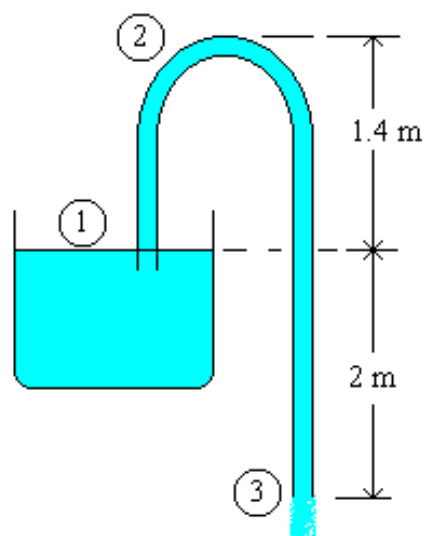

Bernoulli equation between 1-3: $\frac{p_1}{\rho g} + \frac{v_1^2}{2g} + z_1 = \frac{p_3}{\rho g} + \frac{v_3^2}{2g} + z_3$

$z_1 = 2, z_3 = 0$ (level 3 is assumed datum). $p_1 = p_3$ (both atmospheric). And $V_1 = 0$

The energy equation reduces to:

$$0 + 0 + 2 = 0 + \frac{v_3^2}{2g} + 0$$

hence $\rightarrow V_3 = \sqrt{2 \times 9.81 \times 2} = 6.264 \text{ m/s}$

The flow rate is calculated:

$$Q = AxV = \frac{\pi}{4} \times 0.075^2 \times 6.264 = 0.0277 \text{ m}^3 / \text{s}$$

Applying Bernoulli equation between 1 and 2 :

$$\frac{98.1 \times 10^3}{1000 \times 9.81} + 0 + 2 = \frac{p_2}{\rho g} + \frac{6.264^2}{19.61} + 3.4$$

hence $\rightarrow P_2 = 49.050 \text{ kPa}$

2.11 Tutorial Problems

2.1 A 20 mm diameter pipe forks, one branch being 10 mm in diameter and the other 15 mm in diameter. If the velocity in the 10 mm pipe is 0.3 m/s and that in the 15 mm pipe is 0.6 m/s, calculate the rate of flow in cm³/s and velocity in m/s in the 20 mm diameter pipe.

(129.6 cm³/s, 0.413 m/s)

2.2 Water at 36 m above sea level has a velocity of 18 m/s and a pressure of 350 kN/m². Determine the potential, kinetic and pressure energy of the water in metres of head. Also determine the total head.

Ans (35.68 m, 16.5 m, 36 m, 88.2 m)

2.3 The air supply to an engine on a test bed passes down a 180 mm diameter pipe fitted with an orifice plate 90 mm diameter. The pressure drop across the orifice is 80 mm of paraffin. The coefficient of discharge of the orifice is 0.62 and the densities of air and paraffin are 1.2 kg/m³ and 830 kg/m³ respectively. Calculate the mass flow rate of air to the engine.

Ans (0.16 kg/s)

Please click the advert



 OLIVER WYMAN



Oliver Wyman is a leading global management consulting firm that combines deep industry knowledge with specialized expertise in strategy, operations, risk management, organizational transformation, and leadership development. With offices in 50+ cities across 25 countries, Oliver Wyman works with the CEOs and executive teams of Global 1000 companies.
An equal opportunity employer.

GET THERE FASTER

Some people know precisely where they want to go. Others seek the adventure of discovering uncharted territory. Whatever you want your professional journey to be, you'll find what you're looking for at Oliver Wyman.

Discover the world of Oliver Wyman at oliverwyman.com/careers



2.4 Determine the pressure loss in a 100 m long, 10 mm diameter smooth pipe if the flow velocity is 1 m/s for:

- a) air whose density 1.0 kg/m^3 and dynamic viscosity $1 \times 10^{-5} \text{ Ns/m}^2$.
- b) water whose density 1000 kg/m^3 and dynamic viscosity $1 \times 10^{-3} \text{ Ns/m}^2$.

Ans: (320 N/m², 158 kN/m²).

2.5 Determine the input power to an electric motor ($\eta_m = 90\%$) supplying a pump ($\eta_p = 90\%$) delivering 50 l/s of water ($\rho = 1000 \text{ kg/m}^3$, $\mu = 0.001 \text{ kg/ms}$) between two tanks with a difference in elevation of 50m if the pipeline length is 100m long in total of 150 mm diameter, assume a friction factor of 0.008 and neglect minor losses.

Ans: (33.6 kW).

2.6 A jet of water strikes a stationary flat plate “perpendicularly”, if the jet diameter is 7.5 cm and its velocity upon impact is 30 m/s, determine the magnitude and direction of the resultant force on the plate, neglect frictional effect and take water density as 1000 kg.m^3 .

Ans (3970 N)

2.7 A horizontally laid pipe carrying water has a sudden contraction in diameter from 0.4m to 0.2m respectively. The pressure across the reducer reads 300 kPa and 200 kPa respectively when the flow rate is $0.5 \text{ m}^3/\text{s}$. Determine the force exerted on the section due to the flow, assuming that friction losses are negligible.

Ans: (25.5 kN).

2.8 A siphon has a uniform circular bore of 75 mm diameter and consists of a bent pipe with its crest 1.8 m above water level and a discharge to the atmosphere at a level 3.6 m below water level. Find the velocity of flow, the discharge and the absolute pressure at crest level if the atmospheric pressure is 98.1 kN/m^2 . Neglect losses due to friction.

Ans (0.0371 m³/s, 45.1 kN/m²)

3 External Fluid Flow

- | | |
|-----|--------------------------|
| 3.1 | Regimes of External Flow |
| 3.2 | Drag coefficient |
| 3.3 | The boundary layer |
| 3.4 | Worked examples |
| 3.5 | Tutorial problems |

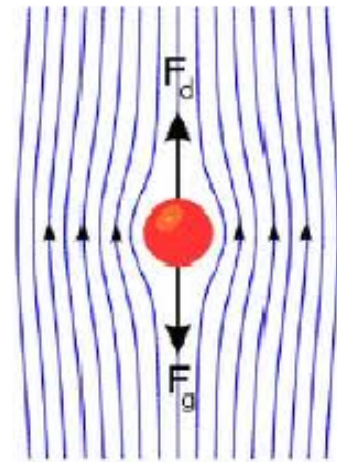

3.1 Regimes of External Flow

Consider the external flow of real fluids. The potential flow and boundary layer theory makes it possible to treat an external flow problem as consisting broadly of two distinct regimes, that immediately adjacent to the body's surface, where viscosity is predominant and where frictional forces are generated, and that outside the boundary layer, where viscosity is neglected but velocities and pressure are affected by the physical presence of the body together with its associated boundary layer. In addition there is the stagnation point at the frontal of the body and there is the flow region behind the body (known as the wake). The wake starts from the point at which the boundary layer separation occurs. Separation occurs due to adverse pressure gradient, which combined with the viscous forces on the surface produces flow reversal, thus causes the stream to detach itself from the surface. The same situation exists at the rear edge of a body as it represents a physical discontinuity of the solid surface.

The flow in the wake is thus highly turbulent and consist of large scale eddies. High rate energy description takes place there, with the result that the pressure in the wake is reduced.

A situation is created whereby the pressure acting on the body (stagnation pressure) is in excess of that acting on the rear of the body so that resultant force acting on the body in the direction of relative fluid motion exerts. The force acting on the body due to the pressure difference is called pressure drag.

A stream lined body is defined as that body whose surface coincides with the stream lines, when the body is placed in a flow. In that case the separation of flow will take place only at the trailing edge (or rearmost part of the body). Though the boundary layer will start at the leading edge, will become turbulent from laminar, yet it does not separate up to the rearmost part of the body in case of stream-lined body. Bluff body is defined as that body whose surface does not coincide with the streamlines, when placed in a flow, then the flow is separated from the surface of the body much ahead of its trailing edge with the result of a very large wake formation zone. Then the drag due to pressure will be very large as compared to the drag due to friction on the body. Thus, the bodies of such a shape in which the pressure drag is very large as compared to friction drag are called bluff bodies.

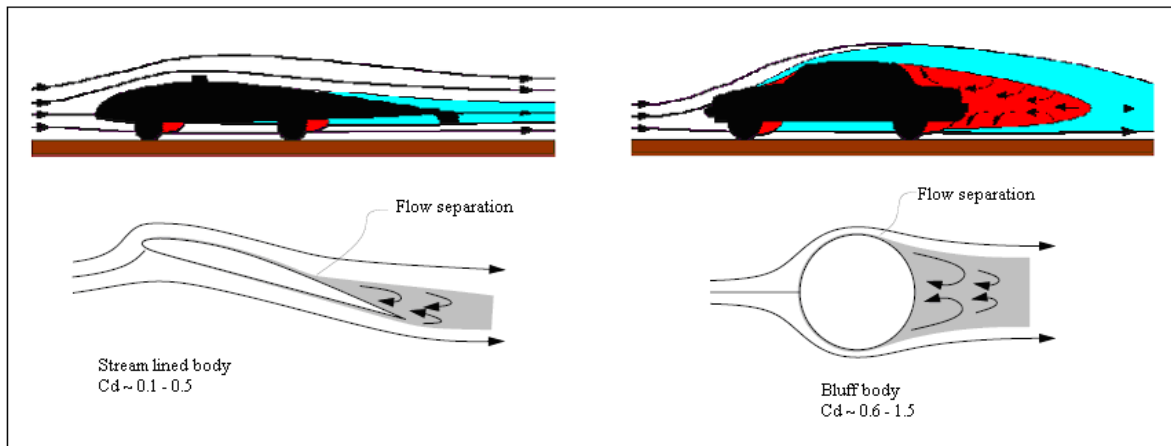

Fig. 3.1: Stream-lined Body and Bluff Body

3.2 Drag Coefficient

Any object moving through a fluid experiences drag - the net force in the direction of flow due to pressure and shear stress forces on the surface of the object.

Drag force can be expressed as:

$$F_D = C_d \times \left(\frac{1}{2}\right) \times \rho \cdot A \cdot V^2 \quad (3.1)$$

Where

F_d = drag force (N)

C_d = drag coefficient

ρ = density of fluid

V = flow velocity

A = characteristic frontal area of the body, normal to the flow direction.

The drag coefficient is a function of several parameters such as the shape of the body, its frontal area, velocity of flow or Reynolds Number, and Roughness of the Surface.

Objects drag coefficients are mostly results of experiments. Drag coefficients for some common bodies are listed in Table 3.2









Shape	C_d
	1.35
	1.17
	0.99
	0.60
	0.51
	0.41
	0.35
	0.34
	0.10
	0.05

Table 3.2 Drag coefficient of some common bodies

3.3 The Boundary Layer

Boundary layers appear on the surface of bodies in viscous flow because the fluid seems to “stick” to the surface. Right at the surface the flow has zero relative speed and this fluid transfers momentum to adjacent layers through the action of viscosity. Thus a thin layer of fluid with lower velocity than the outer flow develops. The requirement that the flow at the surface has no relative motion is the “no slip condition.”

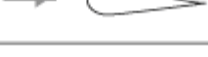
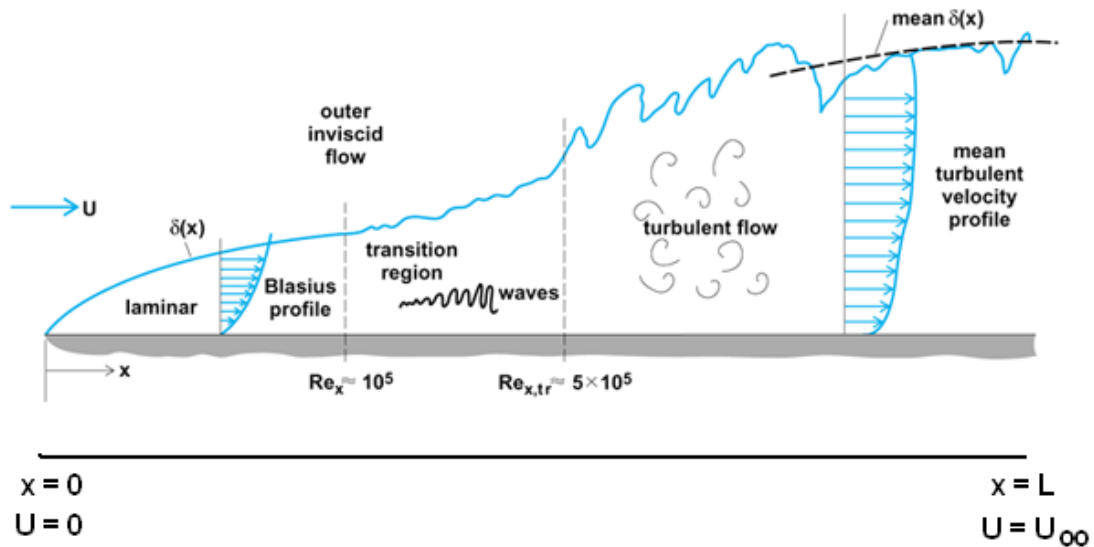

Figure 3.3: Development of the boundary layer on a flat plate

The boundary layer thickness, δ , is defined as the distance required for the flow to nearly reach U_{∞} . We might take an arbitrary number (say 99%) to define what we mean by “nearly”, but certain other definitions are used most frequently.

The concept of a boundary layer was introduced and formulated by Prandtl for steady, two-dimensional laminar flow past a flat plate using the Navier-Stokes equations. Prandtl’s student, Blasius, was able to solve these equations analytically for large Reynolds number flows. The details of the derivation are omitted for simplicity, and the results are summarized here.

Please click the advert

Day one

and you're ready

Day one. It's the moment you've been waiting for. When you prove your worth, meet new challenges, and go looking for the next one. It's when your dreams take shape. And your expectations can be exceeded. From the day you join us, we're committed to helping you achieve your potential. So, whether your career lies in assurance, tax, transaction, advisory or core business services, shouldn't your day one be at Ernst & Young?

What's next for your future?

ey.com/careers

ERNST & YOUNG

Quality In Everything We Do

© 2010 EYGM Limited. All Rights Reserved.

Boundary layers may be either **laminar** (layered), or **turbulent** (disordered) depending on the value of the Reynolds number. For lower Reynolds numbers, the boundary layer is laminar and the streamwise velocity changes uniformly as one move away from the wall, as shown on the left side of the figure. For higher Reynolds numbers, the boundary layer is turbulent and the streamwise velocity is characterized by unsteady (changing with time) swirling flows inside the boundary layer. The external flow reacts to the edge of the boundary layer just as it would to the physical surface of an object. So the boundary layer gives any object an “effective” shape which is usually slightly different from the physical shape. To make things more confusing, the boundary layer may lift off or “separate” from the body and create an effective shape much different from the physical shape. This happens because the flow in the boundary has very low energy (relative to the free stream) and is more easily driven by changes in pressure. Flow separation is the reason for wing stall at high angle of attack. The effects of the boundary layer on lift are contained in the lift coefficient and the effects on drag are contained in the drag coefficient.

Based on Blasius’ analytical solutions, the boundary layer thickness (δ) for the laminar region is given by

$$\frac{\delta}{x} = \frac{5}{\sqrt{Re_x}} \quad \text{laminar, } Re_x < 5 \times 10^5 \quad (3.2)$$

Where δ is defined as the boundary layer thickness in which the velocity is 99% of the free stream velocity (i.e., $y = \delta$, $u = 0.99U$).

The wall shear stress is determined by

$$\tau_w = 0.332 U^2 \sqrt{\frac{\rho \mu}{x}} \quad (3.3)$$

If this shear stress is integrated over the surface of the plate area, the drag coefficient for laminar flow can be obtained for the flat plate with finite length as

$$C_D = \frac{1.328}{\sqrt{Re_L}} \quad \text{laminar, } Re_L < 5 \times 10^5 \quad (3.4)$$

If the flow is turbulent, then the equations for boundary layer and drag coefficient is

$$\frac{\delta}{x} = \frac{0.38}{[Re_L]^{1/5}} \quad \text{turbulent, } 5 \times 10^5 \leq Re_L < 10^7 \quad (3.5)$$

$$C_D = \frac{0.074}{[Re_L]^{1/5}} \quad \text{turbulent, } 5 \times 10^5 \leq Re_L < 10^7 \quad (3.6)$$

3.4 Worked Examples

Worked Example 3.1

- a) If the vertical component of the landing velocity of a parachute is 6 m/s, find the diameter of the open parachute (hollow hemisphere) if the total weight of parachute and the person is 950N.

Assume for air at ambient conditions, Density = 1.2 kg/m^3 and $C_d = 1.4$

- b) How fast would the man fall if the parachute doesn't open? Assume for that condition, $C_d = 0.5$ and that the active area of the person's body is 0.5 m^2 .



Solution:

With the parachute, neglecting buoyancy force using Newton's second law of motion:

$$\begin{aligned}\sum F &= 0 \\ m.g - \frac{1}{2} \rho.V^2 .A_f \times C_d &= 0 \\ 950 - \frac{1}{2} \times 1.2 \times 6^2 .\left(\frac{\pi}{4}\right) D^2 \times 1.4 &= 0 \\ \text{solve} \rightarrow D &= 6.324 \text{ m}\end{aligned}$$

When the parachute don't open, again neglecting buoyancy force

$$\begin{aligned}\sum F &= 0 \\ m.g - \frac{1}{2} \rho.V^2 .A_f \times C_d &= 0 \\ 950 - \frac{1}{2} \times 1.2 \times V^2 \times 0.5 \times 0.5 &= 0 \\ \text{solve} \rightarrow V &= 79.6 \text{ m / s}\end{aligned}$$

Big increase, ouch when he hits the ground!

Worked Example 3.2

Calculate the terminal velocity of sphere of density 6000 kg/m^3 , diameter 0.1 m falling through water of density 1000 kg/m^3 , and its dynamic viscosity to be 0.001 kg/ms .

You may assume that the drag coefficient is given by $C_d = 0.4 (Re/10000)^{0.1}$

Solution:

The Free body Diagram shows the three forces acting on the sphere

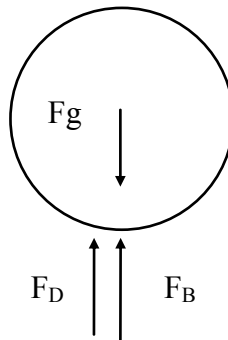

Since the system is stable, Newton's second law of motion applies:

Weight = Drag force + Upthrust (Buoyancy)

Please click the advert



Could you think of 101 new things to do with eggs and oil?

Hellmann's is one of Unilever's oldest brands having been popular for over 100 years. If you too share a passion for discovery and innovation we will give you the tools and opportunities to provide you with a challenging career. Are you a great scientist who would like to be at the forefront of scientific innovations and developments? Then you will enjoy a career within Unilever Research & Development. For challenging job opportunities, please visit www.unilever.com/rdjobs.







Could it be 

Unilever

$$\begin{aligned} \text{Volume of sphere} &= (4\pi/3) \times R^3 = 0.000524\text{m}^3 \\ \text{Area normal to the flow} &= (\pi) \times R^2 = 0.007854 \text{ m}^2 \\ \text{The Upthrust is } F_B &= \rho_{\text{fluid}} \times V_L \times g = 5.136 \text{ N} \\ \text{Weight } F_g &= \rho_{\text{sphere}} \times V_L \times g = 30.819 \text{ N} \\ \text{Hence Drag force } F_D &= F_g - F_B = 30.819 - 5.136 = 25.683 \text{ N} \end{aligned}$$

But

$$\begin{aligned} C_d &= 0.4 (\text{Re}/10000)^{0.1} \\ &= 0.4 (\rho \times V \times D / \mu / 10000)^{0.1} \\ &= 0.4 (1000 \times V \times 0.1 / 0.001 / 10000)^{0.1} \\ &= 0.5036 \times V^{0.1} \end{aligned}$$

$$\begin{aligned} F_D &= C_d \times (1/2) \rho \cdot A \cdot V^2 \\ &= 0.5036 \times V^{0.1} \times 0.5 \times 1000 \times 0.00785 \times V^2 \\ &= 1.9775 \times V^{2.1} \end{aligned}$$

Hence

$$V = \left[\frac{F_D}{1.9775} \right]^{1/2.1} = \left[\frac{25.683}{1.9775} \right]^{1/2.1} = 3.39 \text{ m/s}$$

Worked Example 3.3

An aeroplane weighing 100 kN has a wing area of 45 m² and a drag coefficient (based on wing area) $C_D = 0.03 + 0.04 \times C_L^2$.

Determine:

1. the optimum flight speed
2. the minimum power required to propel the craft.

Assume for air at ambient conditions, Density = 1.2 kg/m³



Solution:

$$C_L = \frac{F_L}{(1/2)\rho \cdot A \cdot V^2} = \frac{100 \times 10^3}{(1/2) \times 1.2 \times 45 \times V^2}$$

$$C_D = 0.03 + 0.04 \times C_L^2 = 0.03 + 0.04 \times \left[\frac{100 \times 10^3}{(1/2) \times 1.2 \times 45 \times V^2} \right]^2$$

hence

$$F_D = \frac{1}{2} \rho \cdot V^2 \cdot A_f \times C_D = \frac{1}{2} \times 1.2 \times V^2 \times 45 \times (0.03 + 5.48 \times 10^{-5} \times V^{-4})$$

Power

$$P = F_D \times V = 0.81V^3 + 1.48 \times 10^7 V^{-1}$$

$$\frac{\partial P}{\partial V} = 3 \times 0.81V^2 - 1.48 \times 10^7 V^{-2}$$

$$\frac{\partial^2 P}{\partial V^2} = 6 \times 0.81V + 2 \times 1.48 \times 10^7 V^{-3}$$

The second derivative is positive for all values of V, hence the first derivative represents the equation for minimum power, set that to zero, leads to $V = 49.7$ m/s

Power

$$P = F_D \times V = 0.81V^3 + 1.48 \times 10^7 V^{-1}$$

$$P = 0.81 \times 49.7^3 + 1.48 \times 10^7 \times 49.7^{-1} = 397 \text{ kW}$$

Worked example 3.4

A racing car shown below is fitted with an inverted aerofoil of length 1.2m and chord 0.85m at such angle that $C_d=0.3$ and $C_l=1.3$.

The car length is 4.6m, the body surface area is 11.5 m² and the skin friction coefficient is given by $0.0741 \text{ Re}_L^{-0.2}$ where Re is based on car length. The car weight is 12.75 kN and the rolling resistance is 40N per kN of normal force between the tyres and road surface. Assuming that the form drag on the car is 500 N when the car maintains a constant speed of 60 m/s, determine at this speed:

1. The total aerodynamic drag force on the car
2. The total rolling resistance, and
3. The power required to drive the car.

Assume for air assume: Density = 1.2 kg/m^3 , and the dynamic viscosity = $1.8 \times 10^{-5} \text{ kg/ms}$.

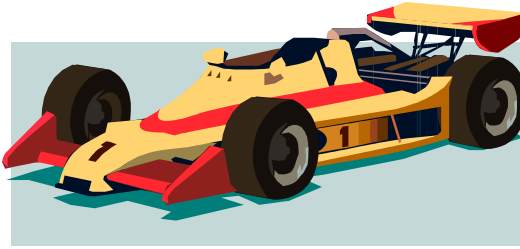

Solution:

1. let F_{D1} be the aerofoil drag force, F_{D2} the car body drag force and F_{D3} the form drag force.

Please click the advert



Discover the truth at www.deloitte.ca/careers

Deloitte.

© Deloitte & Touche LLP and affiliated entities.

Download free ebooks at bookboon.com

aerofoil

$$F_{D1} = \frac{1}{2} \rho V^2 A_f C_{d1} = \frac{1}{2} \times 1.2 \times 60^2 \times (1.2 \times 0.85) \times 0.3 = 655 \text{ N}$$

Car

$$Re_L = \frac{\rho V L}{\mu} = \frac{1.2 \times 60 \times 4.6}{1.8 \times 10^{-5}} = 1.8 \times 10^7$$

hence

$$F_{D2} = \frac{1}{2} \rho V^2 A_f (0.074 Re_L^{-0.2}) = \frac{1}{2} \times 1.2 \times 60^2 \times 11.5 \times 0.074 \times (1.8 \times 10^7)^{-0.2} = 64.5 \text{ N}$$

$$\text{Total drag} = F_{D1} + F_{D2} + F_{D3} = 655 + 64.5 + 500 = 1219.5 \text{ N}$$

2. to determine the total rolling resistance, first calculate the normal force

$$F_N = F_L + m \cdot g = 2840 + 12.75 \times 10^3 = 15.59 \text{ kN}$$

$$\text{Rolling resistance} = 40 \times F_N = 40 \times 15.59 = 623.6 \text{ N}$$

3. to determine the driving power, calculate the total force resisting the forward motion

$$F = 1219.5 + 623.6 = 1843 \text{ N}$$

$$\text{Power} = F \times V = 1843 \times 60 = 110.6 \text{ kW}$$

Worked Example 3.5

Calculate the friction drag on one side of a smooth flat plate on the first 10 mm, and for the entire length when it is towed in water at a relative speed of 10 m/s. The flat plate is 10m long and 1m wide. Assume water density = 1000 kg/m³ and its kinematic viscosity = 1.0x10⁻⁶ m²/s. Use the Boundary layer equations to calculate the drag coefficient.



$$C_D = \frac{1.328}{\sqrt{Re_L}} \quad \text{laminar, } Re_L < 5 \times 10^5$$

$$C_D = \frac{0.074}{[Re_L]^{1/5}} \quad \text{turbulent, } 5 \times 10^5 \leq Re_L < 10^7$$

Solution:

- a) for the first 10 mm

$$\text{Re}_l = \frac{V_\infty x L}{\nu} = \frac{10 \times 0.01}{1.0 \times 10^{-6}} = 1.0 \times 10^5 < 5 \times 10^7 \rightarrow \text{Laminar}$$

$$C_D = \frac{1.328}{(\text{Re})^{0.5}} = 0.0042$$

$$F_D = \frac{1}{2} \rho A V_\infty^2 C_D = \frac{1}{2} \times 1000 \times (0.01 \times 1) \times 10^2 \times 0.0042 = 2.1 \text{ N}$$

b) for the entire length

$$\text{Re}_l = \frac{V_\infty x L}{\nu} = \frac{10 \times 10}{1.0 \times 10^{-6}} = 1.0 \times 10^8 > 5 \times 10^7 \rightarrow \text{Turbulent}$$

$$C_D = \frac{0.074}{(\text{Re})^{0.2}} = 0.0019$$

$$F_D = \frac{1}{2} \rho A V_\infty^2 C_D = \frac{1}{2} \times 1000 \times (10 \times 1) \times 10^2 \times 0.0019 = 929.4 \text{ N}$$

Worked example 3.6

Air flows over a sharp edged flat plate, 1m long, and 1m wide at a velocity of 5 m /s. Determine the following:

1. the boundary layer thickness
2. the drag force
3. the drag force if the plate was mounted perpendicular to the flow direction. Take $C_d = 1.4$.

For air, take density as 1.23 kg/m^3 and the kinematic viscosity for air as $1.46 \times 10^{-5} \text{ m}^2/\text{s}$; Use the Boundary layer equations to calculate the drag coefficient.

Solution:

1.

$$\text{Re}_l = \frac{V_\infty x L}{\nu} = \frac{5 \times 1}{1.46 \times 10^{-5}} = 3.42 \times 10^5 < 5 \times 10^5 \rightarrow \text{Laminar}$$

$$\delta = \frac{5L}{\sqrt{\text{Re}_L}} = \frac{5 \times 1}{\sqrt{3.42 \times 10^5}} = 0.0085 \text{ m}$$

ii.

$$C_D = \frac{1.328}{(\text{Re})^{0.5}} = 0.0023$$

$$F_D = \frac{1}{2} \rho A V_\infty^2 C_D = \frac{1}{2} \times 1.23 \times (1 \times 1) \times 5^2 \times 0.0023 = 0.035 \text{ N}$$

2. when the plate is normal to the flow, $C_d = 1.4$ (table 3.1)

$$F_D = \frac{1}{2} \rho A V_\infty^2 C_D = \frac{1}{2} \times 1.23 \times (1 \times 1) \times 5^2 \times 1.4 = 21.525 \text{ N}$$

This is over 600 times higher than the horizontal mounting force!

Please click the advert

Grant Thornton—^{REALLY} a great place to work.

We're proud to have been recognized as one of Canada's Best Workplaces by the Great Place to Work Institute™ for the last four years. In 2011 Grant Thornton LLP was ranked as the fifth Best Workplace in Canada, for companies with more than 1,000 employees. We are also very proud to be recognized as one of Canada's top 25 Best Workplaces for Women and as one of Canada's Top Campus Employers.



Priyanka Sawant
Manager



Audit • Tax • Advisory
www.GrantThornton.ca/Careers



© Grant Thornton LLP. A Canadian Member of Grant Thornton International Ltd

Download free ebooks at bookboon.com

Worked example 3.7

Water flows over a sharp flat plate 3 m long, 3 m wide with an approach velocity of 10 m/s. Estimate the error in the drag force if the flow over the entire plate is assumed turbulent. Assume the mixed regions can be expressed by the following coefficient of drag relationship

$$C_D = \frac{0.074}{(\text{Re})^{0.2}} - \frac{1742}{\text{Re}_L}$$

For water, take density as 1000 kg/m³, and kinematic viscosity as 1.0x10⁻⁶ m²/s.

Solution:

- a) Assume turbulent

$$\text{Re}_l = \frac{V_\infty x L}{\nu} = \frac{10 \times 3}{1.0 \times 10^{-6}} = 3 \times 10^7 > 5 \times 10^5 \rightarrow \text{Turbulent}$$

$$C_D = \frac{0.074}{(\text{Re})^{0.2}} = 0.0024$$

$$F_D = \frac{1}{2} \rho \cdot A V_\infty^2 \cdot C_D = \frac{1}{2} \times 1000 \times (3 \times 3) \times 10^2 \times 0.0024 = 1064 \text{ N}$$

- b) treat the plate as two parts, laminar section, followed by a turbulent section

$$C_D = \frac{0.074}{(\text{Re})^{0.2}} - \frac{1742}{\text{Re}_L} = \frac{0.074}{(3 \times 10^7)^{0.2}} - \frac{1742}{3 \times 10^7} = 0.0023$$

$$F_D = \frac{1}{2} \rho \cdot A V_\infty^2 \cdot C_D = \frac{1}{2} \times 1000 \times (3 \times 3) \times 10^2 \times 0.0023 = 1038 \text{ N}$$

hence

$$\text{Error} = \frac{1064 - 1038}{1038} \times 100 = 2.5\% \text{ high}$$

3.5 Tutorial Problems

- 3.1 If the vertical component of the landing velocity of a parachute is equal to that acquired during a free fall of 2m, find the diameter of the open parachute (hollow hemisphere) if the total weight of parachute and the person is 950N. Assume for air at ambient conditions, Density = 1.2 kg/m^3 and $C_d = 1.35$

Ans (6.169m)

- 3.2 A buoy is attached to a weight resting on the seabed; the buoy is spherical with radius of 0.2m and the density of sea water is 1020 kg/m^3 . Determine the minimum weight required to keep the buoy afloat just above the water surface. Assume the buoy and the chain has a combined weight of 1.2 kg.

Ans (33 kg)

- 3.3 An aeroplane weighing 65 kN, has a wing area of 27.5 m^2 and a drag coefficient (based on wing area) $C_D = 0.02 + 0.061 \times C_L^2$. Assume for air at ambient conditions, Density = 0.96 kg/m^3 . Determine the following when the craft is cruising at 700 km/h:

1. the lift coefficient
2. the drag coefficient, and
3. the power to propel the craft.

Ans (0.13, 0.021, 2040 kW)

Please click the advert

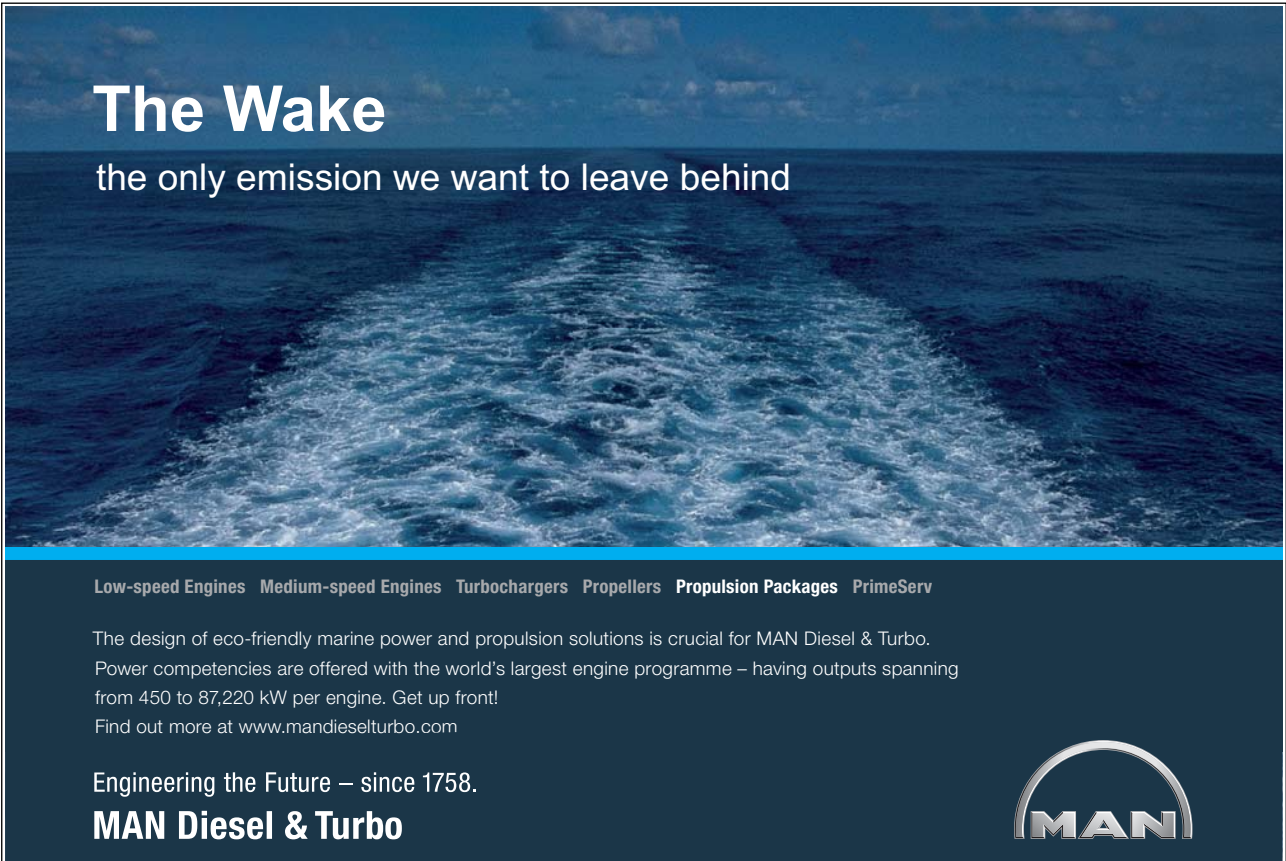

The Wake
the only emission we want to leave behind

Low-speed Engines Medium-speed Engines Turbochargers Propellers Propulsion Packages PrimeServ

The design of eco-friendly marine power and propulsion solutions is crucial for MAN Diesel & Turbo. Power competencies are offered with the world's largest engine programme – having outputs spanning from 450 to 87,220 kW per engine. Get up front!
Find out more at www.mandieselturbo.com

Engineering the Future – since 1758.
MAN Diesel & Turbo



Download free ebooks at bookboon.com

3.4 A racing car shown below is fitted with an inverted NACA2415 aerofoil with lift to drag given as:

$$C_d = 0.01 + 0.008 \times C_l^2$$

The aerofoil surface area is 1 m^2 and the car weight is 1 kN ; the car maintains a constant speed of 40 m/s , determine at this speed:

1. The aerodynamic drag force on the aerofoil
2. The power required to overcome this drag force

Assume for air at ambient conditions, take Density = 1.2 kg/m^3

Ans (18 N, 0.7 kW)

3.5 Air flows over a sharp edged flat plate, 3 m long, and 3 m wide at a velocity of 2 m/s .

1. Determine the drag force
2. Determine drag force if the plate was mounted perpendicular to the flow direction assume $C_d = 1.4$.

For air, take density as 1.23 kg/m^3 , and kinematic viscosity as $1.46 \times 10^{-5} \text{ m}^2/\text{s}$.

Ans (0.05N, 31N)

3.6 (a) An airplane wing has a 7.62 m span and 2.13 m chord. Estimate the drag on the wing (two sides) treating it as a flat plate and the flight speed of 89.4 m/s to be turbulent from the leading edge onward.

(b) Determine the reduction in power that can be saved if the boundary layer control device is installed on the wing to ensure laminar flow over the entire wing's surface.

For air, take density as 1.01 kg/m^3 , and kinematic viscosity as $1.3 \times 10^{-5} \text{ m}^2/\text{s}$.

Ans (24 N, 25 kW)

4 Compressible Fluid Dynamics

Contents

- 4.1 Compressible flow definitions
- 4.2 The speed of sound in fluids
- 4.3 Mach Number & Flow regimes for compressible fluids flow
- 4.4 Determination of the Compressibility factor
- 4.5 Energy equation for frictionless adiabatic gas processes
- 4.6 Stagnation properties
- 4.7 Worked examples
- 4.8 Tutorial problems

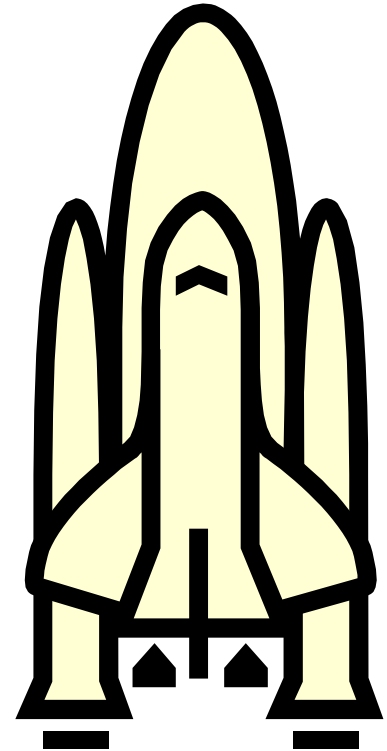

4.1 Compressible flow definitions

Compressible flow describes the behaviour of fluids that experience significant variations in density under the application of external pressures. For flows in which the density does not vary significantly, the analysis of the behaviour of such flows may be simplified greatly by assuming a constant density and the fluid is termed incompressible. This is an idealisation, which leads to the theory of incompressible flow. However, in the many cases dealing with gases (especially at higher velocities) and those cases dealing with liquids with large pressure changes, significant variations in density can occur, and the flow should be analysed as a compressible flow if accurate results are to be obtained.

Allowing for a change in density brings an additional variable into the analysis. In contrast to incompressible flows, which can usually be solved by considering only conservation of mass and conservation of momentum. Usually, the principle of conservation of energy is included. However, this introduces another variable (temperature), and so a fourth equation (such as the ideal gas equation) is required to relate the temperature to the other thermodynamic properties in order to fully describe the flow.

Fundamental assumptions

1. The gas is continuous.
2. The gas is perfect (obeys the perfect gas law)

3. Gravitational effects on the flow field are negligible.
4. Magnetic and electrical effects are negligible.
5. The effects of viscosity are negligible.

Applied principles

1. Conservation of mass (continuity equation)
2. Conservation of momentum (Newton's law)
3. Conservation of energy (first law of thermodynamics)
4. Equation of state

4.2 Derivation of the Speed of sound in fluids

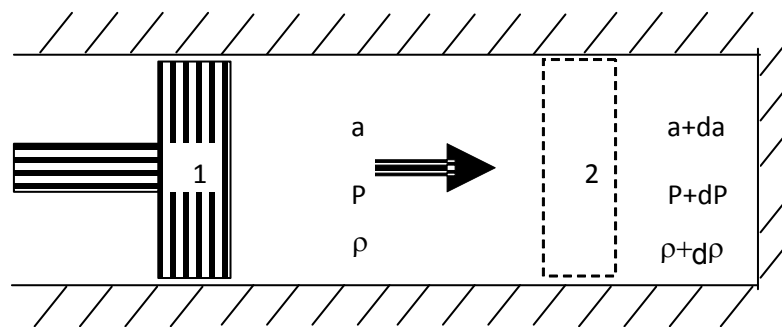

Figure 4.1 Propagation of sound waves through a fluid

Please click the advert

**I WANT TO CHANGE DIRECTION,
AND THE WORLD.**

GOT-THE-ENERGY-TO-LEAD.COM

We believe that energy suppliers should be renewable, too. We are therefore looking for enthusiastic new colleagues with plenty of ideas who want to join RWE in changing the world. Visit us online to find out what we are offering and how we are working together to ensure the energy of the future.

RWE
The energy to lead

Consider the control volume surrounding the cylinder and its content in Figure 4.1, conservation of mass between the sides of the piston at section 2 implies:

$$\rho.A.a = (\rho+\delta\rho).A.(a+da)$$

Since “A” is area of cross-section of the piston (constant); “ ρ ” is the density of the fluid and “a” is the speed of sound wave propagated through the fluid.

Expand the above to get

$$(\rho.da + a.d\rho) = 0 \quad (4.1)$$

Applying the Momentum Equation to the same section:

$$P.A - (P + dP).A = \rho.A.a (a+da-a)$$

$$\text{Hence } dP = - \rho.a.da$$

$$\text{but } \rho da = - a.d\rho$$

$$\text{ie } dP = - a.(- a.d\rho)$$

$$\text{Hence } a = \sqrt{\frac{dP}{d\rho}} \quad (4.2)$$

This is the expression for the speed of sound.

The Speed of sound for liquids

In order to evaluate the speed of sound for liquids, the bulk modulus of elasticity relating the changes in density of the fluid due to the applied pressure in equation 4.2:

$$K_s = \frac{dP}{d\rho / \rho}$$

rewrite

$$\frac{dP}{d\rho} = \frac{K_s}{\rho}$$

hence

$$a = \sqrt{\frac{dP}{d\rho}} = \sqrt{\frac{K_s}{\rho}} \quad (4.3)$$

The speed of sound for an ideal gas

Starting from equation 4.2

$$a = \sqrt{\frac{dP}{d\rho}}$$

$$a^2 = \frac{dP}{d\rho} = \frac{P \cdot dP / P}{d\rho} = \frac{P \cdot d(\ln P)}{d\rho}$$

Since for a perfect gas $P = C \cdot \rho^\gamma$

Then

$$a^2 = \frac{P \cdot d(\ln(C \cdot \rho^\gamma))}{d\rho} = \frac{P \cdot \gamma \cdot C \cdot \rho^{\gamma-1}}{C \cdot \rho^\gamma} = \frac{\gamma \cdot P}{\rho}$$

Hence $a = \sqrt{\gamma \cdot R \cdot T}$ (4.4)

Maxwell was the first to derive the speed of sound for gas.

Gas	Speed (m/s)
Air	331
Carbon Dioxide	259
Oxygen	316
Helium	965
Hydrogen	1290

Table 4.1 The speed of sound for various gases at 0° C

4.3 The Mach number

Mach number is the ratio of the velocity of a fluid to the velocity of sound in that fluid, named after Ernst Mach (1838-1916), an Austrian physicist and philosopher. In the case of an object moving through a fluid, such as an aircraft in flight, the Mach number is equal to the velocity of the airplane relative to the air divided by the velocity of sound in air at that altitude. Mach numbers less than one indicate subsonic flow; those greater than one, supersonic flow. The Mach number can be expressed as

$$M = V / a \quad (4.5)$$

Where

M = Mach number

V = fluid flow velocity (m/s)

a = speed of sound (m/s)

Alternatively the Mach number can be expressed with the density and the bulk modulus for elasticity as

$$M = V (\rho / K_s)^{1/2} \quad (4.6)$$

Where

ρ = density of fluid (kg/m³)

K_s = bulk modulus elasticity (N/m² (Pa))

The bulk modulus elasticity has the dimension pressure and is commonly used to characterize the fluid compressibility. The square of the Mach number is the Cauchy Number. (C)

$$M^2 = C \quad (4.7)$$

As the aircraft moves through the air it makes pressure waves. These pressure waves stream out away from the aircraft at the speed of sound. This wave acts just like the ripples through water after a stone is dropped in the middle of a still pond. At Mach 1 or during transonic speed (Mach 0.7 - 0.9), the aircraft actually catches up with its own pressure waves. These pressure waves turn into one big shock wave. It is this shock wave that buffets the airplane. The shock wave also creates high drag on the airplane and slows the airplane's speed. As the airplane passes through the shock wave it is moving faster than the sound it makes. The shock wave forms an invisible cone of sound that stretches out toward the ground. When the shock wave hits the ground it causes a sonic boom that sounds like a loud thunderclap.

Please click the advert



You're full of *energy*
and *ideas*. And that's
just what we are looking for.

Looking for a career where your ideas could really make a difference? UBS's Graduate Programme and internships are a chance for you to experience for yourself what it's like to be part of a global team that rewards your input and believes in succeeding together.

Wherever you are in your academic career, make your future a part of ours by visiting www.ubs.com/graduates.

www.ubs.com/graduates



© UBS 2010. All rights reserved.

The energy lost in the process of compressing the airflow through these shock waves is called wave drag. This reduces lift on the airplane.

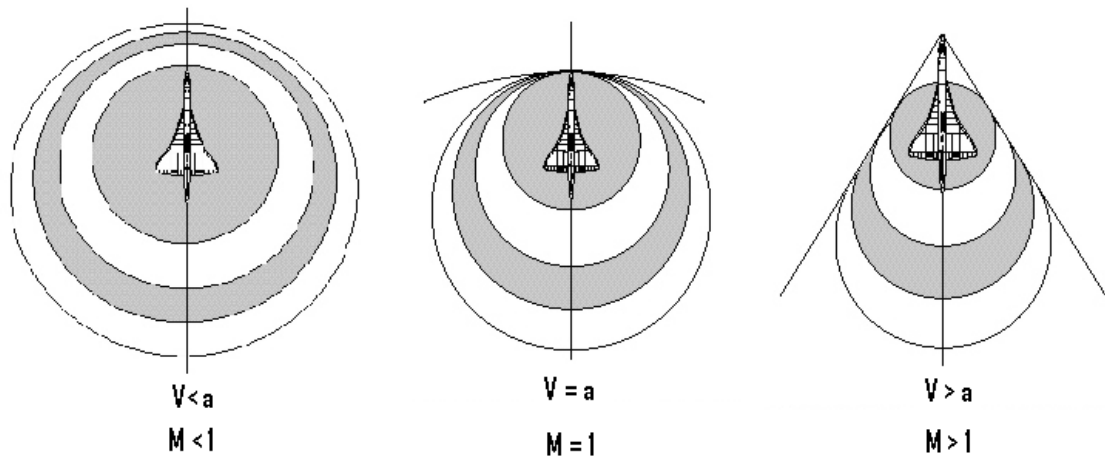

Figure 4.2 Propagation of sound waves through a fluid

Mach number and flow regimes:

Mach number represents the ratio of the speed of an object such as aeroplane in air, or the relative motion of air against the aeroplane. It is commonly agreed that for Mach numbers less than 0.3, the fluid is considered incompressible. The following zoning based on the value of Mach numbers are universally agreed.

$Ma < 0.3$; incompressible flow

$0.3 < Ma < 0.8$; subsonic flow, no shock waves

$0.8 < Ma < 1.2$; transonic flow, shock waves

$1.2 < Ma < 5.0$; supersonic flow

$5 < Ma$; hypersonic flow

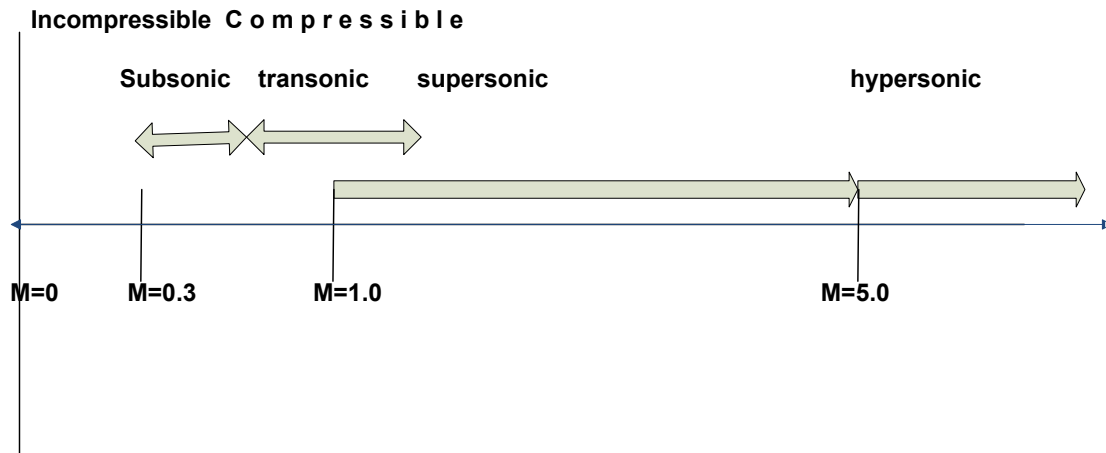

Figure 4.3 Compressible flow regimes

4.4 Compressibility Factor

For a compressible fluid the energy equation between two sections 1 and 2 is represented by Bernoulli’s theorem:

$$\int \frac{dP}{\rho g} + \frac{V^2}{2g} + z = C$$

gas equation: $P = k \cdot \rho^\gamma$

hence $\rho = (P/k)^{1/\gamma}$

$$\int \frac{1}{g} \frac{dP}{(P/k)^{1/\gamma}} + \frac{V^2}{2g} + z = C$$

$$\frac{\gamma}{\gamma-1} \left[\frac{P_2}{\rho_2} - \frac{P_1}{\rho_1} \right] + \frac{V_2^2}{2g} + z_2 - \frac{V_1^2}{2g} - z_1 = 0 \tag{4.8}$$

In cases where the fluid comes to rest, $V_2=0$, and if the stream line is horizontal, the z-terms cancel out, hence the above equation reduces to

$$\frac{\gamma}{\gamma-1} \left[\frac{P_2}{\rho_2} - \frac{P_1}{\rho_1} \right] - \frac{V_1^2}{2g} = 0 \tag{4.9}$$

Since $P = k \cdot \rho^\gamma$ hence

$$\frac{\rho_1}{\rho_2} = \left(\frac{P_1}{P_2} \right)^{1/\gamma}$$

and

$$\frac{P_1}{\rho_1} = R \cdot T_1 = \frac{\gamma \cdot R \cdot T_1}{\gamma} = \frac{a^2}{\gamma} = \frac{V_1^2}{\gamma \cdot M^2}$$

Hence equation 4.9 can be written in terms of the final pressure as

$$\frac{\gamma}{\gamma-1} \cdot \frac{P_1}{\rho_1} \left[\frac{P_2}{\rho_2} / \frac{P_1}{\rho_1} - 1 \right] - \frac{V_1^2}{2} = 0$$

$$\frac{\gamma}{\gamma-1} \cdot \frac{V_1^2}{\gamma \cdot M^2} \left[\frac{P_2}{P_1} \times \left(\frac{P_1}{P_2} \right)^{1/\gamma} - 1 \right] - \frac{V_1^2}{2} = 0$$

$$\frac{1}{\gamma-1} \cdot \frac{1}{M^2} \left[\left(\frac{P_2}{P_1} \right)^{1-1/\gamma} - 1 \right] - \frac{1}{2} = 0$$

Hence

$$\frac{P_2}{P_1} = \left(1 + \frac{\gamma-1}{2} M^2 \right)^{\frac{\gamma}{\gamma-1}} \quad (4.10)$$

Equation (4.10) can be expanded as follows:

$$\frac{P_2}{P_1} = 1 + \frac{\gamma}{2} M^2 + \frac{\gamma}{8} M^4 + \frac{\gamma(2-\gamma)}{48} M^6 + \dots \text{etc}$$

or

$$P_2 - P_1 = P_1 \left[\frac{\gamma}{2} M^2 + \frac{\gamma}{8} M^4 + \frac{\gamma(2-\gamma)}{48} M^6 + \dots \text{etc} \right]$$

but

$$M^2 = \frac{V_1^2}{a^2} = \frac{V_1^2}{\gamma \cdot P_1 / \rho_1}$$

$$P_1 = \frac{\rho_1 \cdot V_1^2}{\gamma \cdot M^2}$$

hence

$$P_2 - P_1 = \frac{\rho_1 \cdot V_1^2}{2} \left[1 + \frac{1}{4} M^2 + \frac{(2-\gamma)}{24} M^4 + \dots \text{etc} \right]$$

hence

$$CF = 1 + \frac{1}{4} M^2 + \frac{(2-\gamma)}{24} M^4 + \dots \quad (4.11)$$

CF is the compressibility factor.

Comparison between Incompressible and Compressible fluid flow of gases. In terms of the velocity of flow, the expression for a compressible fluid is given by equation 4.8

$$\frac{\gamma}{\gamma-1} \left[\frac{P_2}{\rho_2} - \frac{P_1}{\rho_1} \right] + \frac{V_2^2}{2} + gz_2 - \frac{V_1^2}{2} - gz_1 = 0$$

The incompressible situation, Bernoulli's equation is given by

$$\left[\frac{P_2}{\rho_2} - \frac{P_1}{\rho_1} \right] + \frac{V_2^2}{2} + gz_2 - \frac{V_1^2}{2} - gz_1 = 0$$

It is obvious that the term $(\gamma/\gamma-1)$ is the difference, for air the value of this term is 3.5, affecting the pressure head term, velocity term and elevation terms are not affected by this term.

Please click the advert



CAREER KICKSTART

An app to keep you in the know

Whether you're a graduate, school leaver or student, it's a difficult time to start your career. So here at RBS, we're providing a helping hand with our new Facebook app. Bringing together the most relevant and useful careers information, we've created a one-stop shop designed to help you get on the career ladder – whatever your level of education, degree subject or work experience.

And it's not just finance-focused either. That's because it's not about us. It's about you. So download the app and you'll get everything you need to know to kickstart your career.

So what are you waiting for?

Click [here](#) to get started.

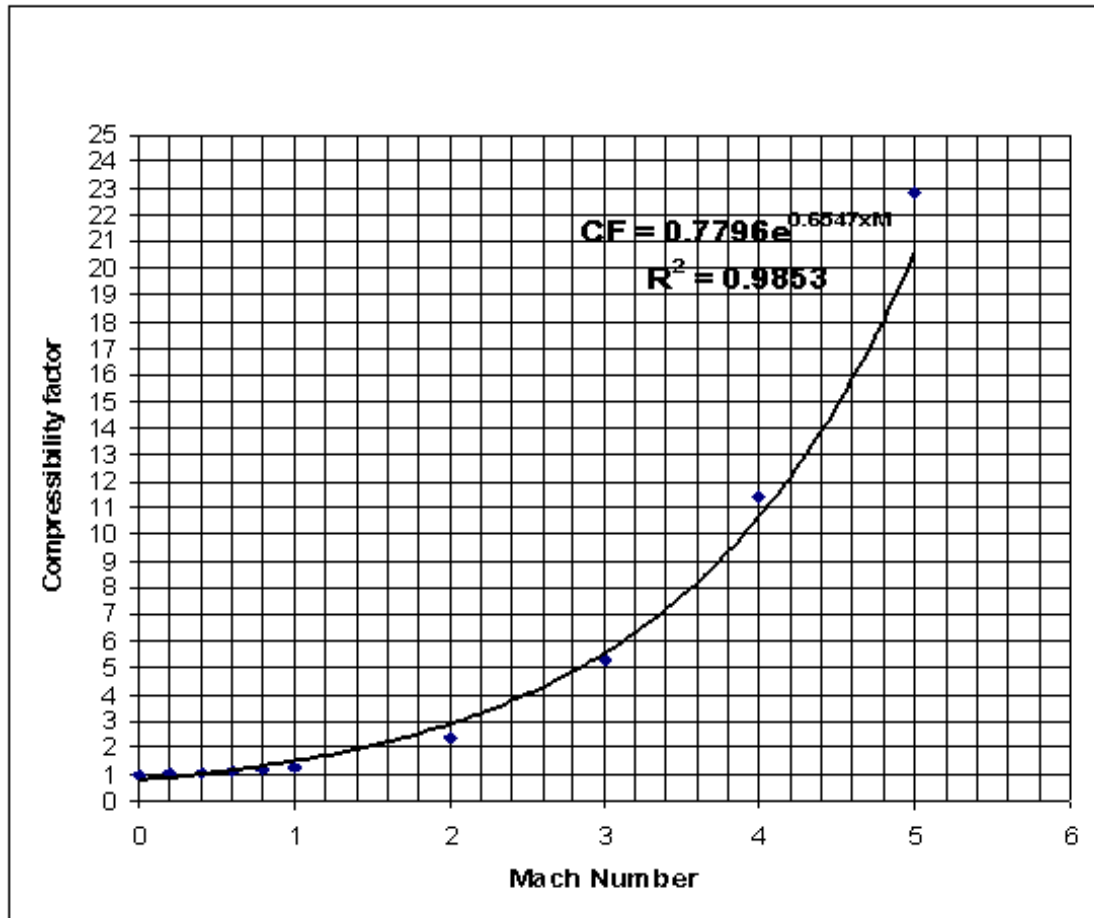

Figure 4.4 Compressibility Factor

4.5 Energy equation for frictionless adiabatic gas processes

Consider a one-dimensional flow through a duct of variable area, the Steady Flow energy Equation between two sections 1 and 2:

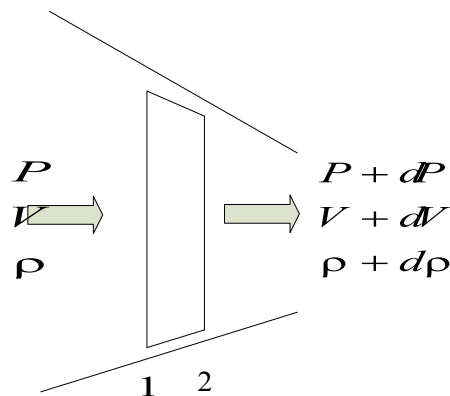

Figure 4.5 One dimensional compressible flow

$$Q - W = m [(h_2 - h_1) + (V_2^2 - V_1^2)/2 + g(z_2 - z_1)]$$

If the flow is adiabatic, and there is no shaft work and assume horizontal duct, the equation reduces to

$$(h_2 - h_1) + (V_2^2 - V_1^2)/2 = 0 \quad (4.12)$$

Or in general $h + V^2/2 = \text{constant}$

By differentiation $dh + v dv = 0$

But the first law of thermodynamics states that
 $dQ - dW = du$

The second law of thermodynamics states that $dQ = T.dS$

Also $dW = P. d(1/\rho)$

and $h = u + P/\rho$ or $du = dh - P. d(1/\rho) + (1/\rho).dP$

Hence the 1st law of thermodynamics is written as

$$T.dS = dh - P. d(1/\rho) - (1/\rho).dP + P. d(1/\rho)$$

$$T.dS = dh - dP/\rho$$

For isentropic process, $dS = 0$

Then $dh = dP/\rho$

but $dh = -v.dv$

hence $-v. dv = dP/\rho$

Therefore $dP/dv = -\rho v$ (4.13)

The continuity equation states that $\rho A v = \text{constant}$

So by differentiation

$$\frac{d\rho}{\rho} + \frac{dA}{A} + \frac{dV}{V} = 0$$

hence

$$\frac{dA}{A} = -\frac{dV}{V} - \frac{d\rho}{\rho}$$

but

$$\frac{dV}{V} = -\frac{dP}{\rho.V^2}$$

hence

$$\frac{dA}{A} = \frac{dP}{\rho.V^2} - \frac{d\rho}{\rho}$$

since $a^2 = dP/d\rho$

the

$$\frac{dA}{A} = \frac{dP}{\rho.V^2} \left(1 - \frac{V^2}{a^2}\right) = \frac{dP}{\rho.V^2} (1 - M^2)$$

finally

$$\frac{dA}{dP} = \frac{A}{\rho.V^2} (1 - M^2) \quad (4.14)$$

Similarly it is possible to show that

$$\frac{dA}{dV} = \frac{A}{V} (1 - M^2) \quad (4.15)$$

To illustrate the above relationships between changes in area of duct and the changes in velocity and pressure, figure 4.6 is drawn.

Please click the advert

ORACLE®

Be BRAVE
enough to reach for the sky

Oracle's business is information - how to manage it, use it, share it, protect it. Oracle is the name behind most of today's most innovative and successful organisations.

Oracle continuously offers international opportunities to top-level graduates, mainly in our Sales, Consulting and Support teams.

If you want to join a company that will invest in your future, Oracle is the company for you to drive your career!

<https://campus.oracle.com>

ORACLE®

ORACLE IS THE INFORMATION COMPANY



Case 1

$\frac{dA}{dV} > 0$
and
 $\frac{dA}{dV} < 0$

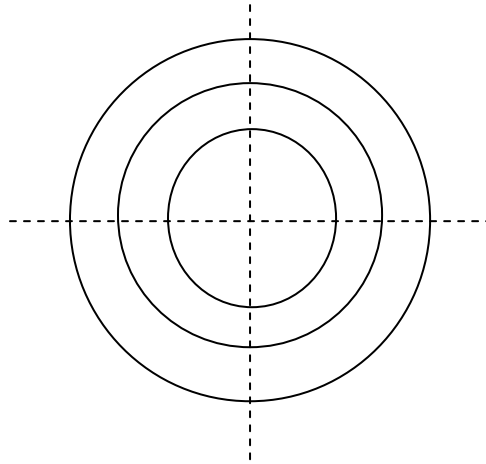

Case 2

$\frac{dA}{dV} = 0$
and
 $\frac{dA}{dV} = 0$

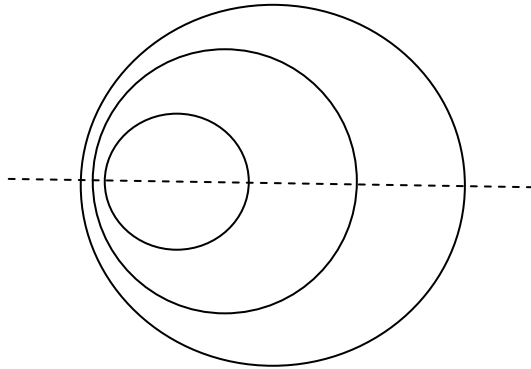

Case 3

$\frac{dA}{dV} < 0$
and
 $\frac{dA}{dV} > 0$

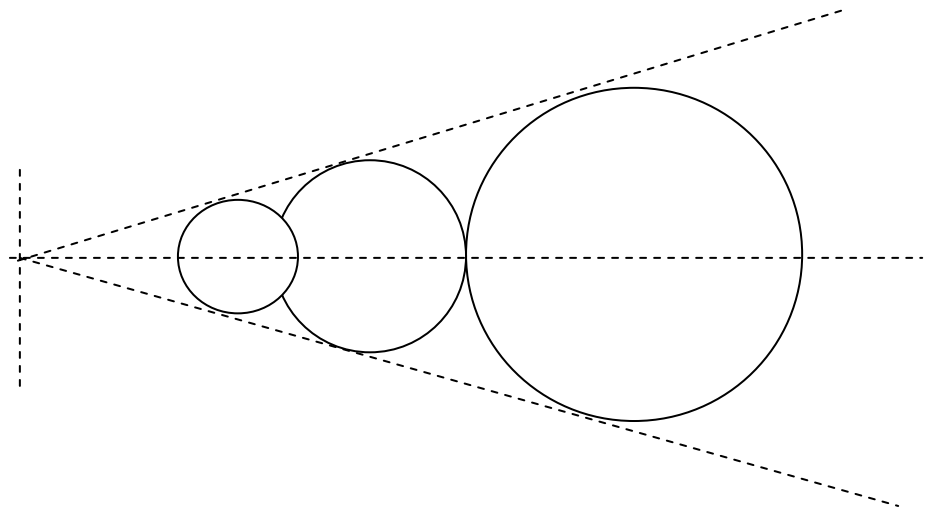

Figure 4.6 Changes of area and its effect on pressure and velocity of compressible flow

4.6 Stagnation properties of compressible flow

Stagnation condition refers to the situation or rather position in which the fluid becomes motionless. There are many examples of this in real applications; two are shown in figure 4.7

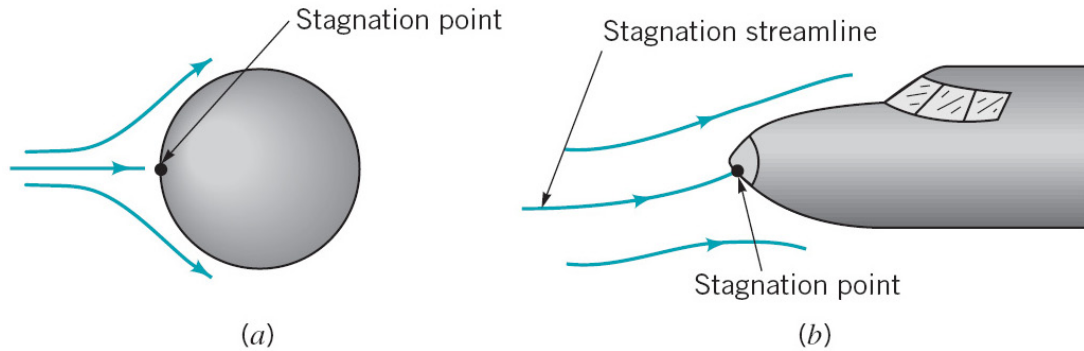

Figure 4.7 Stagnation situations in flow applications

When defining what is meant by a compressible flow, it is useful to compare the density to a reference value, such as the stagnation density, ρ_o , which is the density of the fluid if it were to be slowed down isentropically to stationary.

Recall the simplified energy equation for the duct in the previous section, between any section, and rest (stagnation).

$$h + V^2/2 = h_o$$

The enthalpy is defined as the product of the specific heat capacity C_p and the temperature of the fluid, T . also note that

$$C_p = \frac{\gamma \cdot R}{\gamma - 1}$$

Hence, the energy equation can be written as:

$$\frac{a^2}{\gamma - 1} + \frac{V^2}{2} = \frac{a_o^2}{\gamma - 1}$$

Since $M = V/a$ then

$$\frac{a^2}{\gamma - 1} + \frac{a^2 \cdot M^2}{2} = \frac{a_o^2}{\gamma - 1}$$

$$a^2 \left(1 + \frac{\gamma - 1}{2} M^2 \right) = a_o^2 \quad (4.16)$$

Plotting the speed of sound ratio (a/a_0) versus M , is shown in Figure 4.8

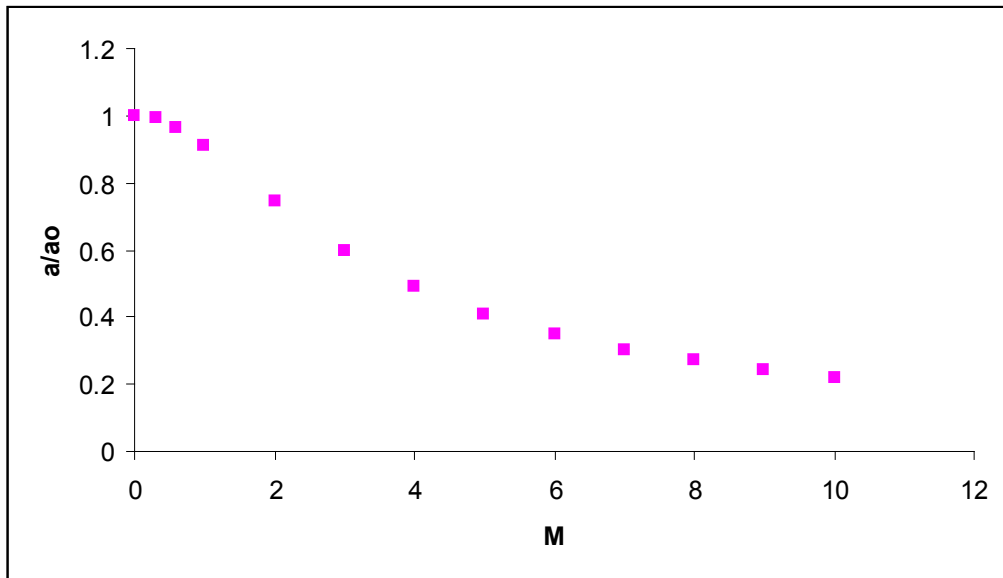
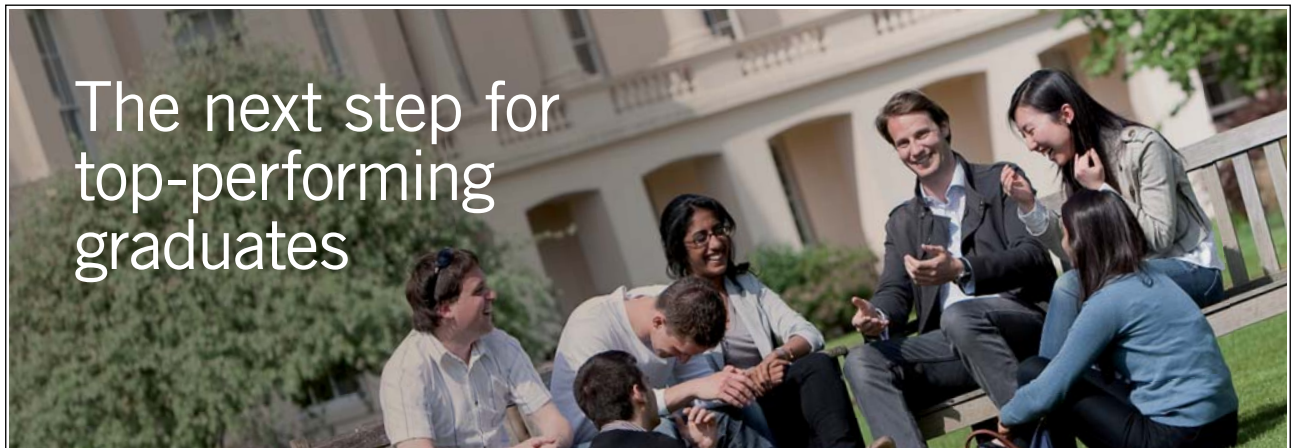

Figure 4.8 Variation of speed of sound ratio with Mach number

Recall the energy equation for a fluid with a stagnation state “o”

$$h + V^2/2 = h_0$$



Please click the advert

Masters in Management

Designed for high-achieving graduates across all disciplines, London Business School’s Masters in Management provides specific and tangible foundations for a successful career in business.

This 12-month, full-time programme is a business qualification with impact. In 2010, our MiM employment rate was 95% within 3 months of graduation*; the majority of graduates choosing to work in consulting or financial services.

As well as a renowned qualification from a world-class business school, you also gain access to the School’s network of more than 34,000 global alumni – a community that offers support and opportunities throughout your career.

For more information visit www.london.edu/mm, email mim@london.edu or give us a call on **+44 (0)20 7000 7573**.

* Figures taken from London Business School’s Masters in Management 2010 employment report



Use $h = C_p T$, the energy equation can be written as:

$$C_p T + \frac{V^2}{2} = C_p T_o$$

hence

$$\frac{T_o}{T} = 1 + \frac{V^2}{2 C_p T}$$

but

$$V^2 = a^2 M^2 \dots \text{and} \dots C_p = \frac{\gamma R}{\gamma - 1}$$

$$\therefore \frac{T_o}{T} = 1 + \frac{\gamma - 1}{2} M^2 \quad (4.17)$$

In order to find the maximum velocity for stagnation condition, the EE is used With velocity being maximum when T is taken down to absolute zero, ie

$$C_p (T = 0) + \frac{V^2}{2} = C_p T_o$$

hence

$$V_{\max} = \sqrt{2 C_p T_o} \quad (4.18)$$

Other Stagnation relationships

Starting with the stagnation temperature ratio, it is possible to derive a similar relationship for stagnation pressure ratio

$$\frac{T_o}{T} = 1 + \frac{\gamma - 1}{2} M^2$$

but

$$\frac{P_o}{P} = \left[\frac{T_o}{T} \right]^{\frac{\gamma}{\gamma - 1}}$$

hence

$$\frac{P_o}{P} = \left[1 + \frac{\gamma - 1}{2} M^2 \right]^{\frac{\gamma}{\gamma - 1}} \quad (4.19)$$

For the stagnation density ratio

$$\text{with } \frac{P}{\rho^\gamma} = c$$

$$\frac{\rho_o}{\rho} = \left[\frac{P_o}{P} \right]^{\frac{1}{\gamma}} = \left[1 + \frac{\gamma-1}{2} M^2 \right]^{\frac{1}{\gamma-1}} \quad (4.20)$$

4.7 Worked Examples

Worked Example 4.1

Calculate the speed of sound in air and in water at 0 °C and at 20 °C and absolute pressure 1 bar.

For air - $\gamma = 1.4$ and $R = 287$ (J/K kg)

For water $K_s = 2.06 \times 10^9$ (N/m²) and $\rho = 998$ (kg/m³) at 0 °C, and 1000 (kg/m³) at 20 °C

Solution:

For air at 0 °C

$$a = [\gamma R T]^{1/2} = (1.4 (287 \text{ J/K kg}) (273 \text{ K}))^{1/2} = 331.2 \text{ (m/s)}$$

Where $\gamma = 1.4$ and $R = 287$ (J/K kg)

The speed of sound in air at 20 °C and absolute pressure 1 bar can be calculated as

$$a = [\gamma R T]^{1/2} = (1.4 (287 \text{ J/K kg}) (293 \text{ K}))^{1/2} = 343.1 \text{ (m/s)}$$

The difference is = 3.6%

The speed of sound in water at 0 °C can be calculated as

$$a = \sqrt{\frac{K_s}{\rho}} = \sqrt{\frac{2.06 \times 10^9}{998}} = 1437 \text{ m/s}$$

Where $K_s = 2.06 \times 10^9$ (N/m²) and $\rho = 998$ (kg/m³)

The speed of sound in water at 20 °C can be calculated as

$$a = \sqrt{\frac{K_s}{\rho}} = \sqrt{\frac{2.06 \times 10^9}{1000}} = 1445 \text{ m/s}$$

Where $K_s = 2.06 \times 10^9$ (N/m²) and $\rho = 1000$ (kg/m³)

The difference is = 0.5%

It can be noted that the speed of sound in gases changes more than in liquids with changes in temperature.

Worked Example 4.2

An aircraft flies at an altitude of 10,000 m where the pressure and density are 0.265 bar and 0.41 kg/m³ respectively.

- Determine the aircraft speed if the Mach number is 1.5
- What is the speed of the plane at sea level if the Mach number is maintained?

Solution:

- The speed of sound in air is calculated first, then using the Mach definition, the speed of the aircraft is calculated as follows:

$$a = \sqrt{\gamma \cdot R \cdot T}$$

$$a = \sqrt{\gamma \cdot P / \rho} = \sqrt{1.4 \times 0.265 \times 10^5 / 0.41} = 300.8 \text{ m/s}$$

$$V = a \cdot M = 300.8 \times 1.5 = 451 \text{ m/s}$$

- when the Mach number is $M = 1.5$, similar method to that in (a) is used:

$$a = \sqrt{\gamma \cdot R \cdot T}$$

$$a = \sqrt{\gamma \cdot P / \rho} = \sqrt{1.4 \times 1.01325 \times 10^5 / 1.2} = 343.8 \text{ m/s}$$

$$V = a \cdot M = 343.8 \times 1.5 = 515.7 \text{ m/s}$$

Worked Example 4.3

A sealed tank filled with air which is maintained at 0.37 bar gauge and 18°C. The air discharges to the atmosphere (1.013 bar) through a small opening at the side of the tank.

- Calculate the velocity of air leaving the tank; assume the flow to be compressible and the process to be frictionless adiabatic.
- Compare the value if the flow is incompressible.
- comment on the result.

Take for air, $R=287 \text{ J/kgK}$, and $\gamma= 1.4$.

Solution:

- Bernoulli equation for a compressible case, Assume $z_2=z_1$ and $V_1 = 0$; The equation reduces to:

$$\frac{V_2^2}{2} = \frac{\gamma}{\gamma-1} \left[\frac{P_2}{\rho_2} - \frac{P_1}{\rho_1} \right]$$

$$\therefore V_2 = \left[\frac{2\gamma}{\gamma-1} \left[\frac{P_2}{\rho_2} - \frac{P_1}{\rho_1} \right] \right]^{0.5} = \left[\frac{2\gamma}{\gamma-1} \times \frac{P_1}{\rho_1} \left[1 - \left(\frac{P_2}{P_1} \right)^{\frac{\gamma-1}{\gamma}} \right] \right]^{0.5}$$

Since $\frac{P_1}{\rho_1} = R.T_1$ Then the discharge velocity is:

$$\therefore V_2 = \left[\frac{2\gamma}{\gamma-1} \times R.T_1 \left[1 - \left(\frac{P_2}{P_1} \right)^{\frac{\gamma-1}{\gamma}} \right] \right]^{0.5} = \left[\frac{2 \times 1.4}{1.4-1} \times 287 \times 291 \left[1 - \left(\frac{1.013}{1.013+0.37} \right)^{\frac{1.4-1}{1.4}} \right] \right]^{0.5} = 223 \text{ m/s}$$

b) For incompressible fluids $\left[\frac{P_2}{\rho_2} - \frac{P_1}{\rho_1} \right] + \frac{V_2^2}{2} + g z_2 - \frac{V_1^2}{2} - g z_1 = 0$

With $\rho_2 = \rho_1$ and again with $z_2 = z_1$ and $V_1 = 0$; The equation reduces to:

$$\therefore V_2 = \left[\frac{2(P_1 - P_2)}{\rho} \right]^{0.5} = \left[\frac{2 \times 0.37}{(0.37 + 1.013) \times 10^5} \right]^{0.5} = 211 \text{ m/s}$$

Destination MMU



Manchester
Metropolitan
University

MMU is proud to be one of the most popular universities in the UK. Some 34,000 students from all parts of the globe select from its curricula of over 1,000 courses and qualifications.

We are based in the dynamic yet conveniently compact city of Manchester, located at the heart of a sophisticated transport network including a major international airport on the outskirts. Parts of the campus are acclaimed for their architectural style and date back over 150 years, in direct contrast to our teaching style which is thoroughly modern, innovative and forward-thinking.

MMU offers undergraduate and postgraduate courses in the following subject areas:

- Art, Design & Performance
- Computing, Engineering & Technology
- Business & Management
- Science, Environmental Studies & Geography
- Law, Education & Psychology
- Food, Hospitality, Tourism & Leisure Studies
- Humanities & Social Science



For more details or an application form please contact MMU International.
email: international@mmu.ac.uk
telephone: +44 (0)161 247 1022
www.mmu.ac.uk/international

Please click the advert

c) The fluid velocity is different for the two assumptions,

$$a = \sqrt{\gamma \cdot R \cdot T} = \sqrt{1.4 \times 287 \times 291} = 342 \text{ m/s}$$

hence

$$M = \frac{v}{a} = \frac{223}{342} = 0.6$$

The fluid is clearly compressible, so the accurate velocity is 223 m/s

Worked Example 4.4

A low flying missile develops a nose temperature of 2500K where the temperature and pressure of the atmosphere at that elevation are 0.03bar and 220K respectively. Determine the missile velocity and the stagnation pressure. Assume for air $C_p=1000 \text{ J/kgK}$ and $\gamma=1.4$.

Solution:

Using the stagnation relations,

$$C_p = C_v + R$$

$$C_p = C_p / \gamma + R$$

hence

$$C_p = \frac{\gamma \cdot R}{\gamma - 1}$$

$$\frac{T_o}{T} = 1 + \frac{\gamma - 1}{2} M^2$$

$$M = V / a = V / \sqrt{\gamma \cdot R \cdot T}$$

hence

$$\frac{T_o}{T} = 1 + \frac{V^2}{2 \cdot C_p \cdot T}$$

$$V = \sqrt{2 \times C_p \times T \times \left(\frac{T_o}{T} - 1 \right)}$$

$$V = 2135 \text{ m/s}$$

Similarly the stagnation density ratio can be used to determine the stagnation pressure:

$$\frac{P_o}{P} = \left[1 + \frac{V^2}{2.C_p.T}\right]^{\frac{\gamma}{\gamma-1}}$$

hence

$$P_o = 0.03 \times \left[1 + \frac{2135^2}{2 \times 1000 \times 220}\right]^{\frac{1.4}{0.4}} = 148 \text{ bar}$$

Worked Example 4.5

An air stream at 1 bar, 400 K moving at a speed of 400 m/s is suddenly brought to rest. Determine the final pressure, temperature and density if the process is adiabatic.

Assume for air: $\gamma = 1.4$, $C_p = 1005 \text{ J/kgK}$ and density = 1.2 kg/m^3 .

Solution:

Using the stagnation relations,

Please click the advert

**UNIVERSITY OF
SURREY**

Get Internationally Connected at the University of Surrey

MA Intercultural Communication with International Business
MA Communication and International Marketing



MA Intercultural Communication with International Business
Provides you with a critical understanding of communication in contemporary socio-cultural contexts by combining linguistic, cultural/media studies and international business and will prepare you for a wide range of careers.

MA Communication and International Marketing
Equips you with a detailed understanding of communication in contemporary international marketing contexts to enable you to address the market needs of the international business environment.

For further information contact:
T: +44 (0)1483 681681
E: pg-enquiries@surrey.ac.uk
www.surrey.ac.uk/downloads

$$T_o = T + \frac{V^2}{2.C_p} = 400 + \frac{400^2}{2 \times 1005}$$

$$= 479.5 \text{ K}$$

$$\frac{P_o}{P} = \left[1 + \frac{V^2}{2.C_p.T}\right]^{\frac{\gamma}{\gamma-1}}$$

hence

$$P_o = 1 \times \left[1 + \frac{400^2}{2 \times 1005 \times 479.5}\right]^{0.4} = 1.711 \text{ bar}$$

$$\frac{\rho_o}{\rho} = \left[\frac{P_o}{P}\right]^{\frac{1}{\gamma}}$$

hence

$$\rho_o = 1.2 \times \left[\frac{1.711}{1}\right]^{\frac{1}{1.4}} = 1.761 \text{ kg/m}^3$$

4.8 Tutorial Problems - Compressible Flow

4.1 Assuming the ideal gas model holds, determine the velocity of sound in

- air (*mwt* 28.96) at 25°C, with $\gamma = 1.4$,
- argon (*mwt* 39.95) at 25°C, with $\gamma = 1.667$.

Ans[346 m/s, 321.5 m/s]

4.2 An airplane can fly at a speed of 800 km/h at sea-level where the temperature is 15°C. If the airplane flies at the same Mach number at an altitude where the temperature is -44°C, find the speed at which the airplane is flying at this altitude.

Ans[198 m/s]

4.3 A low flying missile develops a nose temperature of 2500 K when the ambient temperature and pressure are 250 K and 0.01 bar respectively. Determine the missile velocity and its stagnation pressure. Assume for air: $\gamma = 1.4$. $C_p = 1005 \text{ J/kgK}$

Ans[2126 m/s, 31.6 bar]

- 4.4 An airplane is flying at a relative speed of 200 m/s when the ambient air condition is 1.013 bar, 288 K. Determine the temperature, pressure and density at the nose of the airplane. Assume for air: $\gamma = 1.4$, density at ambient condition = 1.2 kg/m^3 and $C_p = 1005 \text{ J/kgK}$.

Ans [$T_o = 307.9\text{K}$, $P_o = 1.28 \text{ bar}$, $\rho = 1.42 \text{ kg/m}^3$]

5 Hydroelectric Power

Contents

5.1 Introduction

5.2 Types of Hydraulic Turbines

5.3 Performance evaluation of hydroelectric power plants

5.4 Case study – Dinorwig

5.5 Worked examples

5.6 Tutorial problems

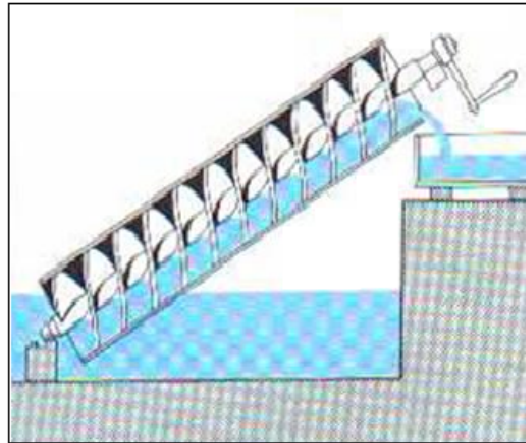

Archimedes was a mathematician and inventor from ancient Greece (born 280 BC). He invented a screw-shaped machine or hydraulic screw that raised water from a lower to a higher level.

Please click the advert

STEP INTO A WORLD OF OPPORTUNITY

www.ecco.com/trainees
trainees@ecco.com

eCCO[®]

An advertisement for ECCO shoes. It features a woman on the left and a man on the right, both smiling and looking upwards. A brown and white high-top sneaker is suspended in the air between them, with their hands positioned as if they are about to touch it. The background is a dark, gradient grey.

Download free ebooks at bookboon.com

5.1 Introduction

Hydraulic Turbines are used for converting the potential energy of water into useful Mechanical power to drive machines as in Mills or pumps or electrical energy using electrical generators.

- Hydroelectric power stations can be classified according to power output into micro hydro, mini hydro, small hydro and large hydro systems. The definitions according to the International Energy Association are as follows:
 - Micro hydro - hydroelectric station with installed capacity lower than 100 kW
 - Mini hydro - hydroelectric station in the range of 100kW to 1 MW
 - Small hydro - hydroelectric station in the range of 1 MW to 30 MW
 - Large hydro - hydroelectric station with installed capacity of over 30 MW

Hydropower is a clean and renewable source of energy that can contribute to fighting climate change. The following advantages make hydropower a much preferred option to any fossil fuel power scheme:

- No fuel needed - The chief advantage of hydro systems is elimination of the cost of fuel. Hydroelectric plants are immune to price increases for fossil fuels such as oil, natural gas or coal, and do not require imported fuel.
- Longevity - Hydroelectric plants tend to have longer lives than fuel-fired generation, with some plants now in service having been built 50 to 100 years ago.
- Pollution free - Hydroelectric plants generally have small to negligible emissions of carbon dioxide and methane due to reservoir emissions, and emit no sulphur dioxide, nitrogen oxides, dust, or other pollutants associated with combustion.
- Quick Response - Since the generating units can be started and stopped quickly, they can follow system loads efficiently, and may be able to reshape water flows to more closely match daily and seasonal system energy demands.
- Environmentally friendly - Reservoirs created by hydroelectric schemes often provide excellent leisure facilities for water sports, and become tourist attractions in themselves..
- Wildlife preserves can be created around reservoirs, which can provide stable habitats for endangered and threatened species(Eg. catch rates for game fish like walleye and small mouth bass are substantially higher on hydro power reservoirs than natural lakes.)
- Flood prevention – the surplus water can be stored behind the dam and hence reduce the risk of flood.

5.2 Types of hydraulic turbines

Depending on the method of interaction between the fluid and the machine, there are two main types of turbines, IMPULSE and REACTION.

A Impulse Turbine

This type of turbine is usually selected for high head and low flow rate conditions. The water is usually directed on to the turbine blades via a nozzle and the jet will impinge and leaves the turbine at atmospheric condition.

The high velocity jet leaves the nozzle at atmospheric pressure and impinges on to the wheel blades or buckets.

The tangential force exerted on the buckets is produced by a change in momentum of the jet, both in magnitude and direction.

The most important type of impulse turbine is the PELTON wheel.

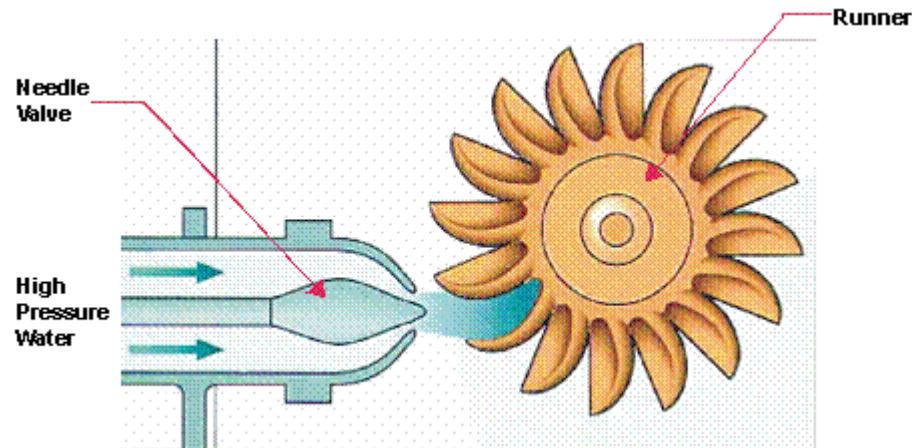

Figure 5.1: Pelton Turbine (Wheel)

Courtesy of: http://re.emsd.gov.hk/english/other/hydroelectric/hyd_tech.html#

B Reaction Turbine

This type of turbine is usually selected for low head conditions, but relatively higher flow rate than in impulse turbines. In reaction turbines part of the pressure energy is transformed into kinetic energy in the stationary guide vanes and the remainder is transferred in the runner wheel. This type of turbine does not run at atmospheric; in fact the pressure changes continuously while flowing through the machine. The chief turbines of this type are the FRANCIS and KAPLAN turbines.

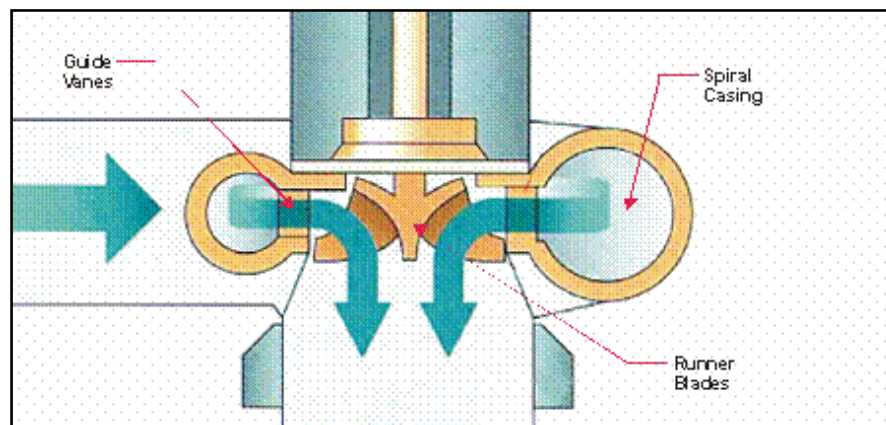

Figure 5.2: Francis Turbine

Courtesy of: http://re.emsd.gov.hk/english/other/hydroelectric/hyd_tech.html#

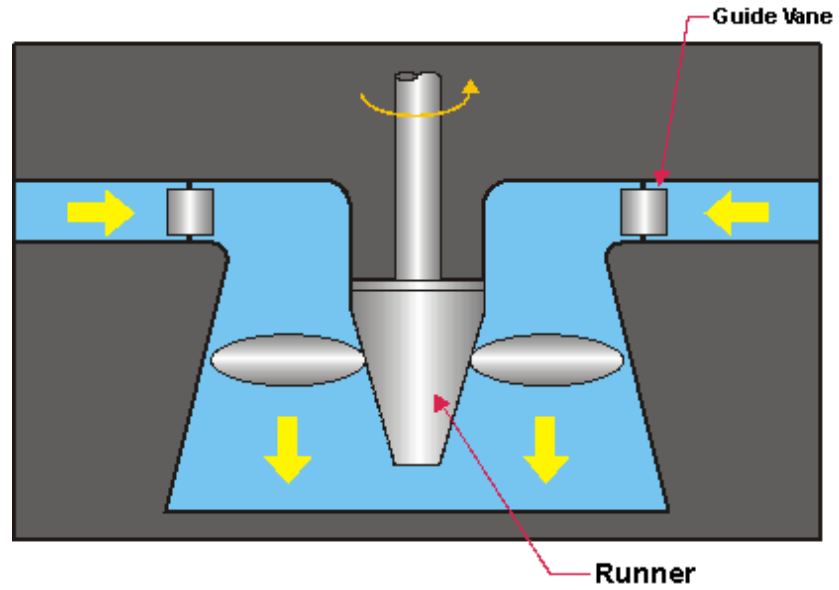
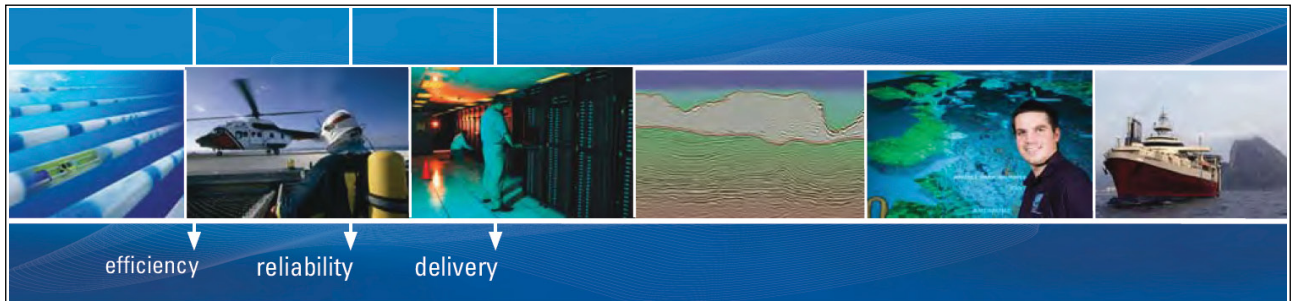

Figure 5.3: Kaplan Turbine

Courtesy of: http://re.emsd.gov.hk/english/other/hydroelectric/hyd_tech.html#



Please click the advert

As a leading technology company in the field of geophysical science, PGS can offer exciting opportunities in offshore seismic exploration.

We are looking for new BSc, MSc and PhD graduates with Geoscience, engineering and other numerate backgrounds to join us.

To learn more our career opportunities, please visit www.pgs.com/careers

A Clearer Image
www.pgs.com



C Reversible Pump/Turbine

Modern pumped storage units require the use of a reversible pump / turbine that can be run in one direction as pump and in the other direction as turbine. These are coupled to reversible electric motor/generator. The motor drives the pump during the storage portion of the cycle, while the generator produces electricity during discharge from the upper reservoir.

Most reversible-pump turbines are of the Francis type. The complexity of the unit, however, increases significantly as compared to a turbine alone. In spite of the higher costs for both hydraulic and electrical controls and support equipment, the total installed cost will be less than for completely separate pump-motor and turbine-generator assemblies with dual water passages.

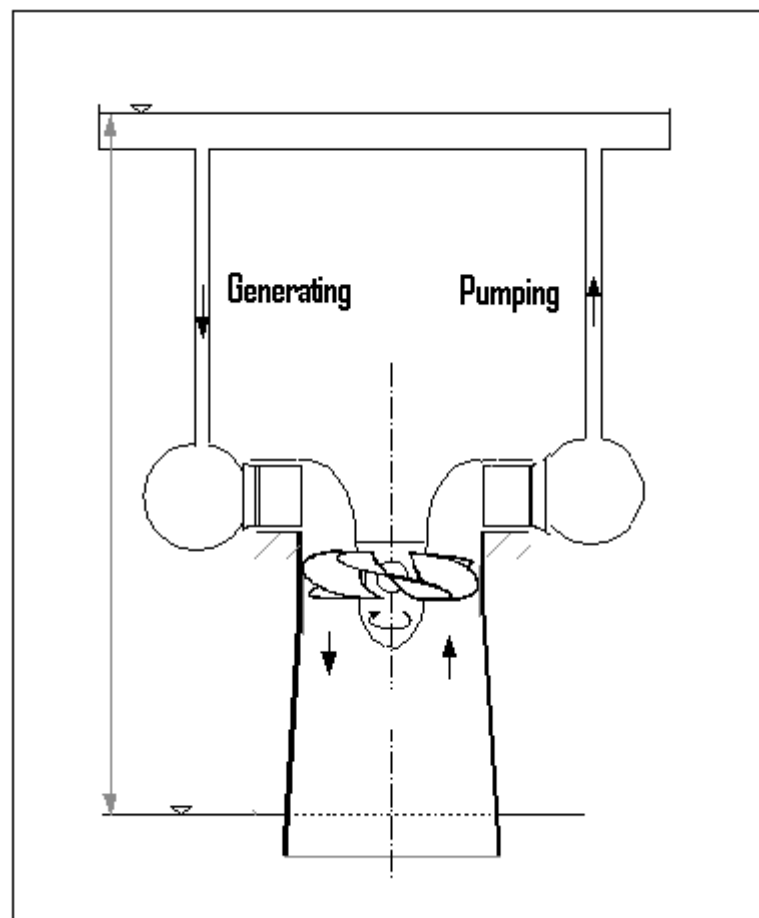

Figure 5.4: Reversible Francis Turbine/Pump system
Courtesy of: http://oei.fme.vutbr.cz/jskorpik/en_lopatkovy-stroj.html

5.3 Performance evaluation of Hydraulic Turbines

The power available from water can be expressed as

$$P = \rho Q g h \eta \quad (5.1)$$

Where

P = power available (W)

ρ = density (kg/m^3) ($\sim 1000 \text{ kg/m}^3$ for water)

Q = water flow (m^3/s)

g = acceleration of gravity (9.81 m/s^2)

h = falling height, head (m)

The hydraulic efficiency depends on many factors such as the type of turbine and the operational conditions. Typical values are between 50% and 75%.

The theoretical approach velocity of water is given by:

$$V = \sqrt{2.g.h} \quad (5.2)$$

However real hydropower stations have penstock of considerable length incorporating many pipe fittings, bends and valves, hence the effective head is reduced, and as such the real velocity of water approaching the turbine is less than that quoted in equation 5.2.

The volume flow rate of water is calculated by the continuity equation:

$$Q = V \times A \quad (5.3)$$

The different hydraulic turbines described in the previous section have different characteristics such as power rating, operating head and rotational speed, the term specific speed is introduced to group the three terms:

$$Ns = N \frac{P^{1/2}}{(h)^{5/4}} \quad (5.4)$$

The concept of specific speed helps to classify the different turbines according to the range in which they operate, see Table 5.5.

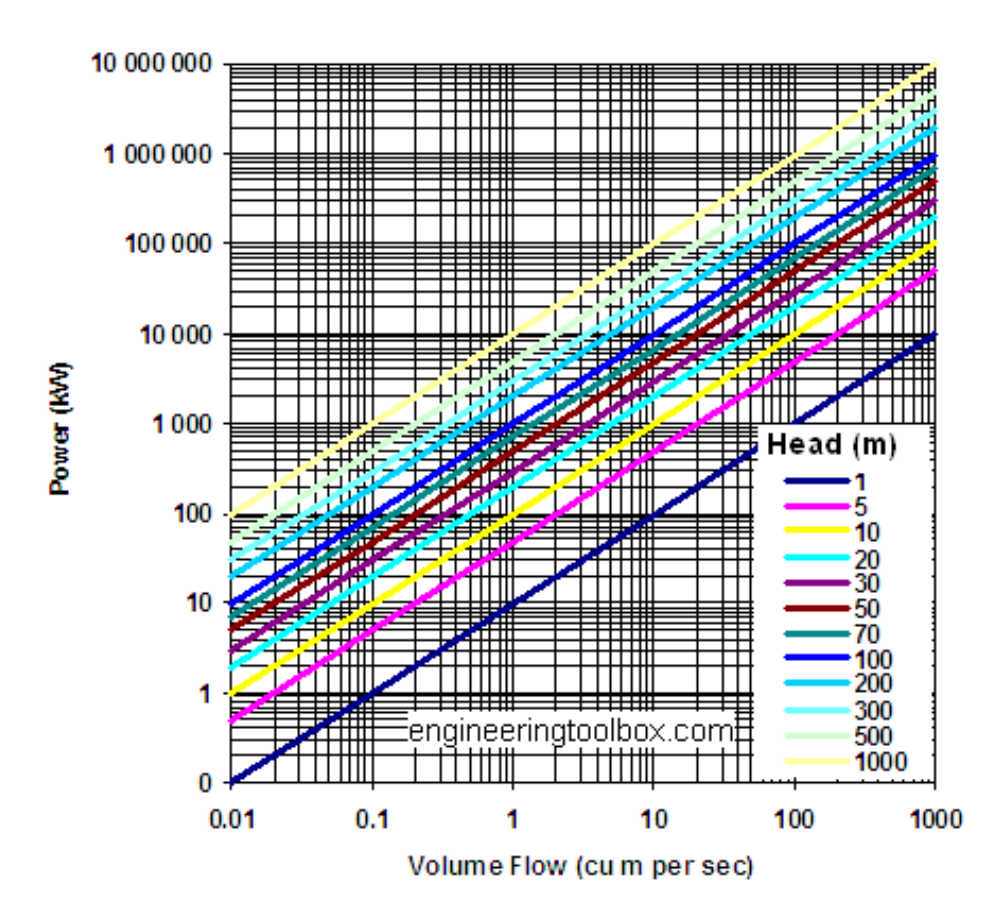

Figure 5.5 Typical Power – flow rate evaluation chart.
 Courtesy of: http://www.engineeringtoolbox.com/hydropower-d_1359.html

Type Of Turbine	Specific speed range
	$N_s = N \frac{P^{1/2}}{(h)^{5/4}}$
Francis	70 – 500
Propeller	600 – 900
Kaplan	350 – 1000
Cross-flow	20 – 90
Turgo	20 – 80
Pelton, 1-jet	10 – 35
Pelton, 2-jet	10 – 45

Table 5.1: Operating Range of Hydraulic Turbines

5.4 Pumped storage hydroelectricity

Some areas of the world have used geographic features to store large quantities of water in elevated reservoirs, using excess electricity at times of low demand to pump water up to the reservoirs, then letting the water fall through turbine generators to retrieve the energy when demand peaks.

Pumped storage hydroelectricity was first used in Italy and Switzerland in the 1890's. By 1933 reversible pump-turbines with motor-generators were available. Adjustable speed machines are now being used to improve efficiency.

Hydro-electric power plants are economically viable because of the difference between peak and off-peak electricity prices. Pumped-storage plants can respond to load changes within seconds.

Hydropower electricity is the product of transforming the potential energy stored in water in an elevated reservoir into the kinetic energy of the running water, then mechanical energy in a rotating turbine, and finally electrical energy in an alternator or generator. Hydropower is a mature renewable power generation technology that offers two very desirable characteristics in today's electricity systems: built-in storage that increases the system's flexibility and fast response time to meet rapid or unexpected fluctuations in supply or demand. Hydropower amounted to 65 % of the electricity generated from renewable energy sources in Europe in 2007 or 9 % of the total electricity production in the EU-27. Today's installed capacity in the EU-27 for hydropower is about 102 GW, without hydro-pumped storage. Approximately 90 % of this potential is covered by large hydropower plants. Over 21 000 small hydropower plants account for above 12 GW of installed capacity in the EU-27.

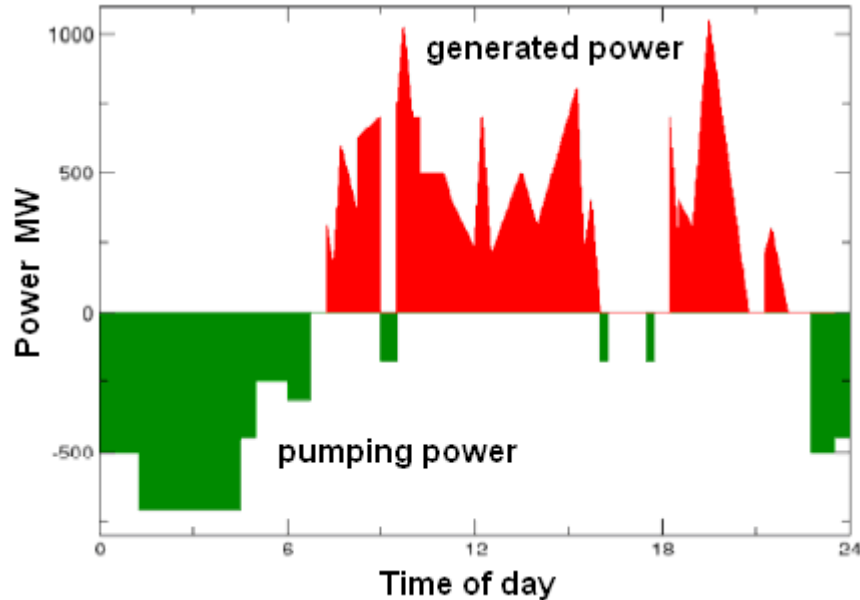

Figure 5.6 Typical daily cycle for a pumped storage hydro-electric power plant.

Case study – Dinorwig power station

Dinorwig is the largest scheme of its kind in Europe. The station's six powerful generating units ($6 \times 288 = 1728$ MW) stand in Europe's largest man-made cavern. Adjacent to this lies the main inlet valve chamber housing the plant that regulates the flow of water through the turbines.

Dinorwig's reversible pump/turbines are capable of reaching maximum generation in less than 16 seconds. Using off-peak electricity the six units are reversed as pumps to transport water from the lower reservoir Llyn Peris, back to Marchlyn Mawr.

Please click the advert



5365/07/09

Going up in the world...

You'll be going up in the world after graduating from Nottingham Trent University. We are one of the best universities in England for graduate employment with over 97% of our students employed or in further study within six months of graduating.*

- Consistently ranked as one of the leading modern universities in *The Independent Good University Guide*.
- Courses informed by businesses and industry – strong commercial partnerships with over 6,000 companies globally.
- Many courses include professional accreditation and / or the opportunity to undertake a work placement. This gives our graduates a competitive edge when entering the job market.
- An exciting student city in the middle of England. Ideally located for travel across the UK and with direct flights to destinations across Europe from East Midlands Airport.
- Investing £130 million across our three campuses to create an inspiring learning environment.
- In the most recent QAA institutional review, the University received the highest commendation for its consistent commitment to supporting students and their learning.

If you would like any guidance on applying to Nottingham Trent University please contact Laura Vella, our International Officer for Europe, on

Tel: +44 (0)115 848 8180

Email: laura.vella@ntu.ac.uk

www.ntu.ac.uk/book

**NOTTINGHAM
TRENT UNIVERSITY** 

* HESA DHLE 2006-07

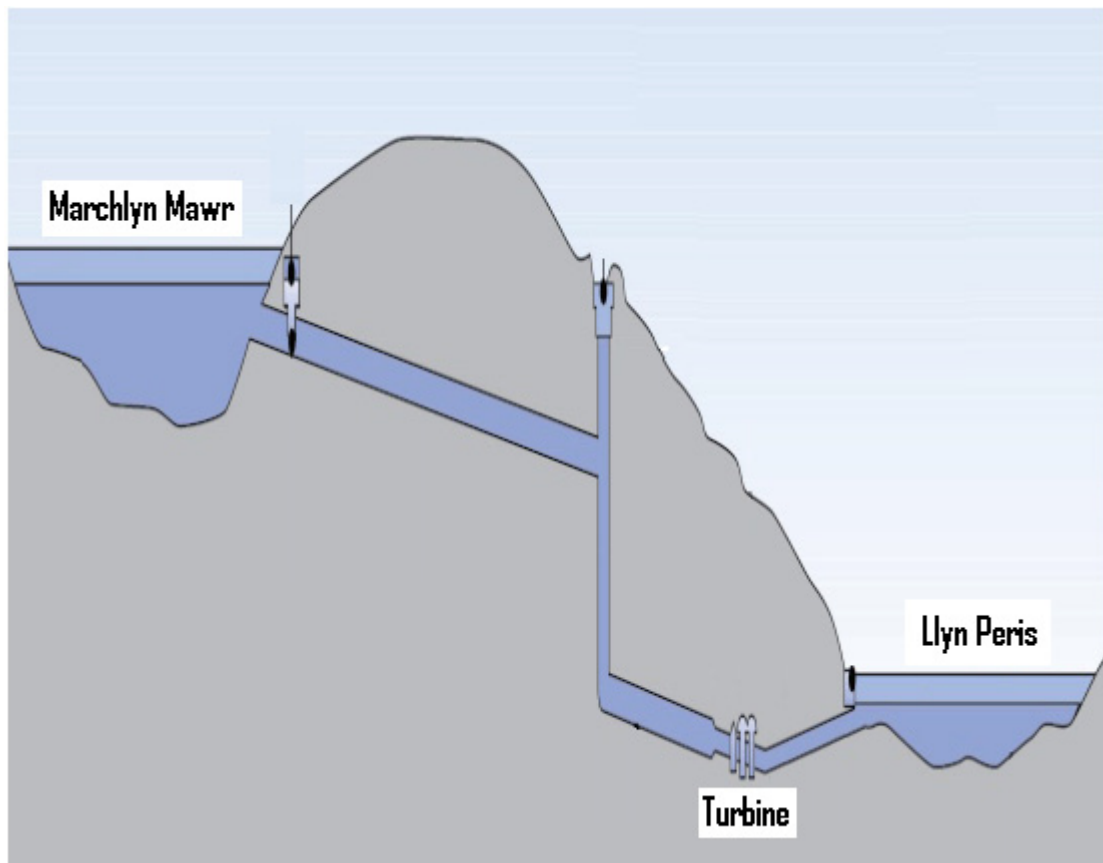

Figure 5.7 Dinorwig Power plant

Table 5.2 Dinorwig Facts & Figures

Surge Pond Data:	
Dimensions of surge pond	80x40x14 metres deep
Diameter of surge shaft	30 metres
Depth of surge shaft	65 metres
Generator/Motors:	
Type	Vertical shaft, salient pole, air cooled
Generator rating	330 MVA
Motor rating	312 MVA
Terminal voltage	18kV
Excitation	Thyristor rectifier
Starting equipment	Static variable frequency
Generator-Motor Transformer:	
Number	Six
Approximate rating	340 MVA

Voltage ratio	18 kV/420 kV
Underground Caverns:	
Distance of power station inside mountain	750 metres
Depth of turbine hall below top level of Llyn Peris	71 metres
Machine Hall:	
Length	180 metres
Width	23 metres
Height	51 metres max
Transformer Hall:	
Length	160 metres
Width	23 metres
Height	17 metres
Diversion tunnel length	2,208 metres
Width	6.5 metres
Height	5.5 metres
Maximum flow	60 cubic m/s
Normal flow	1-8 cubic m/s
Fall	1:1500
Pump/Turbines:	
Type	Reversible Francis
Number	6
Plant orientation	Vertical spindle
Average pump power input	275 MW
Pumping period (full volume)	7 hours
Synchronous speed	500 rpm
Average full unit over all heads (declared capacity)	288 MW Generation potential at full load
Output	5 hours
Station power requirements when generating	12 MW
Standby operational mode	
Synchronised and spinning-in-air emergency load pick-up rate from standby	0 to 1,320 MW in 12 seconds
Transmission Switchgear:	
Type	SF6 metal clad
Breaking capacity	35,000 MVA
Current rating	4,000 A
Voltage	420 kV

Excavations:	
Main underground excavation	1 million cubic metres (approx. 3 million tonnes)
Total scheme excavations	12 million tonnes

5.5 Worked Examples

Worked Example 5.1

Dinorwig power station has a head of 500m between the upper and the lower reservoir.

- a) determine the approach velocity of water as it enters the turbine
- b) if the volume flow rate is 60 m³/s what is the diameter of the penstock
- c) if the head loss due to friction represents 10% of the static head stated in (a), determine the actual velocity of approach and the corrected diameter of the penstock required.

Solution

- a) the approach velocity;

$$V = \sqrt{2 \cdot g \cdot h} = \sqrt{2 \times 9.81 \times 500} = 99 \text{ m/s}$$

- b) The flow rate of water $Q = V \times A$; Hence

Please click the advert



STUDY.
The stuff you'll need to make a good living



PLAY.
The stuff that makes life worth living

NORWAY.
YOUR IDEAL STUDY DESTINATION.

WWW.STUDYINNORWAY.NO
FACEBOOK.COM/STUDYINNORWAY



$$A = \frac{Q}{V} = \frac{60}{99} = 0.606 \text{ m}^2$$

$$D = \sqrt{4\pi / A} = \sqrt{4\pi / 0.606} = 4.553 \text{ m}$$

- c) The effective head is the actual head minus the friction head loss

$$h_f = 10\% \text{ of } h = (10/100) \times 500 = 50 \text{ m}$$

$$\text{Effective head} = h - h_f = 450 \text{ m}$$

Hence

$$V = \sqrt{2 \times 9.81 \times 450} = 93.96 \text{ m/s}$$

$$A = \frac{Q}{V} = \frac{60}{93.96} = 0.638 \text{ m}^2$$

$$D = \sqrt{4\pi / A} = \sqrt{4\pi / 0.638} = 4.436 \text{ m}$$

Worked Example 5.2

The average head of the water stored in the upper reservoir of the Dinorwig pumped storage system in Wales is 500 metres.

- Calculate the water flow rate through one of the turbo-generators when it is producing an output of 300 MW at 94% efficiency.
- The upper reservoir can store 7.2 million cubic metres of water. Show that this is enough to maintain the output from all six 300 MW generators, running simultaneously, for a little over five hours.

You may assume that there is no rain during these hours.

Solution

- a) The output power in kilowatts is given by

$$P = 9.81 Q H \eta$$

$$\text{So in this case we have } 300,000 = 9.81 \times Q \times 500 \times 0.94$$

$$\text{Which means that } Q = 65 \text{ m}^3 \text{ s}^{-1}$$

- b) The flow rate for 6 turbines is $6 \times 65 = 390 \text{ m}^3 \text{ s}^{-1}$

And the available supply will maintain this for

$$7,200,000/390 = 18,442 \text{ seconds,}$$

$$\text{Which is } 18442/3600 = 5.12 \text{ hours.}$$

Worked Example 5.3

Calculate the specific speeds for Dinorwig power station described in the table below and recommend an appropriate type of turbine.

Power station	(P) Turbine rating (kW)	(h) Average head (m)	(N) Revolutions per minute	(Ns) Specific speed	Turbine type used
Dinorwig	300 000	500	500		

Solution

The last two columns are the solution to this question; the specific speeds are calculated using the definition of specific speed and the type of turbine/s were chosen according to table1.

Type Of Turbine	Specific speed range $N_s = N \frac{P^{1/2}}{(h)^{5/4}}$
Francis	70 – 500
Propeller	600 – 900
Kaplan	350 – 1000
Cross-flow	20 – 90
Turgo	20 – 80
Pelton, 1-jet	10 – 35
Pelton, 2-jet	10 – 45

$$N_s = N \frac{P^{1/2}}{(h)^{5/4}} = 500 \times 300000^{0.5} / 500^{1.25} = 116$$

Checking the values in the table, this lies in the Francis turbine range

Power station	(P) Turbine rating (kW)	(h) Average head (m)	(N) Revolutions per minute	(Ns) Specific speed	Turbine type used
Dinorwig	300 000	500	500	<u>116</u>	<u>Francis</u>

5.7 Tutorial Problems

5.1 A small-scale hydraulic power system has an elevation difference between the reservoir water surface and the pond water surface downstream of the turbine is 10 m. The flow rate through the turbine is $1 \text{ m}^3/\text{s}$. The turbine/generator efficiency is 83%. Determine the power produced if:

- Flow losses are neglected.
- Assume friction loss equivalent to 1 m head.

Ans:(81 kW, 73 kW)

5.2 A hydro-electric power plant based on the Loch Sloy in Scotland has an effective head of 250 metres. If the flow rate of $16 \text{ m}^3/\text{s}$ can be maintained, determine the total power input to the turbine assuming a hydraulic efficiency of 98% ; and

- the pressure difference across the turbine.

Ans: (38 MW, 2.4 MPa)

5.3 A proposed hydropower plant to be built using a reservoir with a typical head of 18m and estimated power of 15 MW. You are given the task to select an appropriate type of turbine for this site if the generator requires the turbine to run at a fixed speed of 120 rpm.

Ans: (Ns=396, Francis or Kaplan)

Sample Examination paper



CLASS TEST - FLUID MECHANICS

Module Tutor T. Al-Shemmeri

This Paper contains TEN questions. Attempt all questions.

A formulae sheet is provided.

Place your Answers in the space provided. No detailed solution required.

Print your name on every page. Submit all together for marking.

MARKING GRID LEAVE BLANK PLEASE

question	1	2	3	4	5	6	7	8	9	10	total
1 st Marker											
2 nd marker											

Agreed percentage	
Recommended grade	

QUESTION ONE

List THREE types of instrument used to measure the pressure of a toxic fluid contained in a sealed tank. Complete the table below:

Type	Principle	marks
		/ 3 marks
		/ 3 marks
		/ 3 marks

Total (9 marks)

QUESTION TWO

a) Draw (not to scale) the pressure distribution of the water on the dam shown below:

(6 marks)

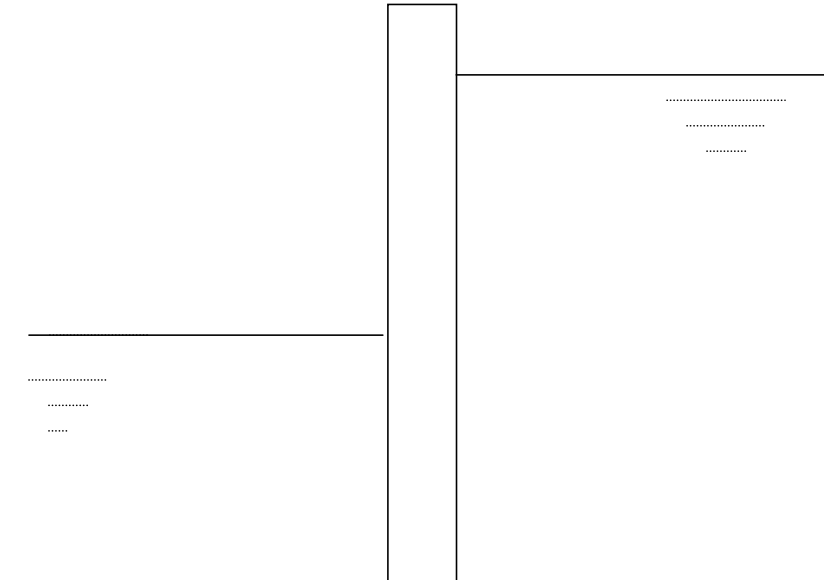

b) Indicate on the sketch, the direction of the resultant force on the dam?

(2 marks)

c) Approximately, indicate the position of the centre of pressure on both sides.

(2 marks)

Total (10 marks)

QUESTION THREE

List Three methods used to improve the resolution of detecting a small pressure reading in a manometer. Complete the table below:

Method	Principle	marks
		/ 3 marks
		/ 3 marks
		/ 3 marks

Total (9 marks)

Please click the advert

Are you considering a European business degree?

LEARN BUSINESS at university level. We mix cases with cutting edge research working individually or in teams and everyone speaks English. Bring back valuable knowledge and experience to boost your career.

MEET a culture of new foods, music and traditions and a new way of studying business in a safe, clean environment – in the middle of Copenhagen, Denmark.

ENGAGE in extra-curricular activities such as case competitions, sports, etc. – make new friends among CBS' 18,000 students from more than 80 countries.

Copenhagen Business School
HÅNDELSHØJSKOLEN

See what we look like and how we work on cbs.dk

QUESTION FOUR

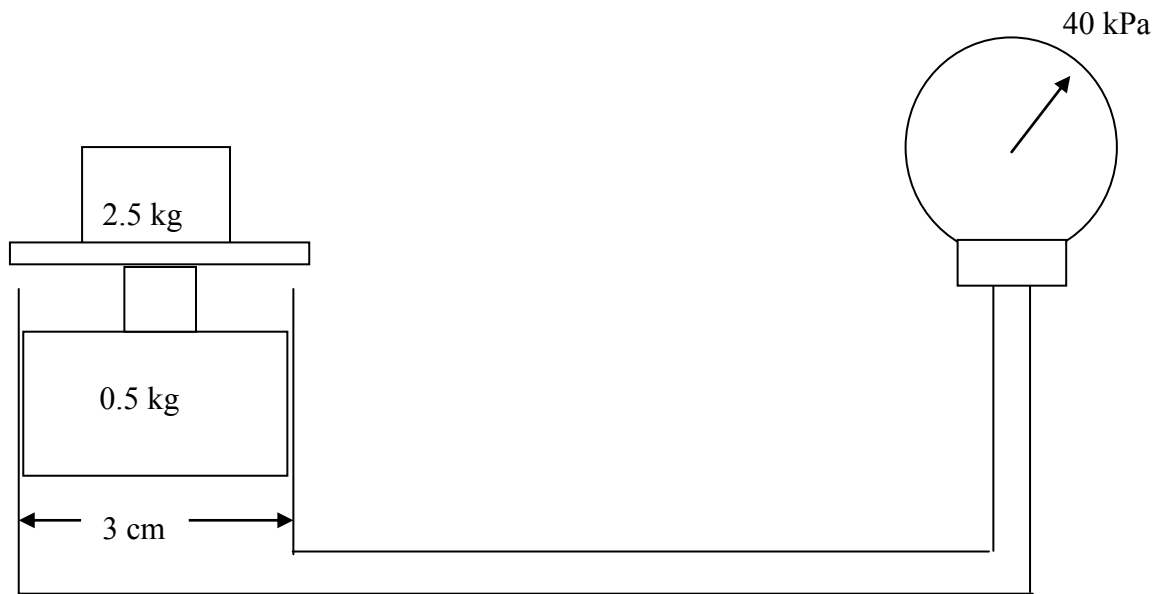

Complete the table below:

Theoretical reading of the pressure		/ 3 marks
% error		/ 3 marks
The maximum load if the gauge limit is 100 kPa		/ 3 marks

Total (9 marks)

QUESTION FIVE

If the fan, below, circulates air at the rate of $0.30 \text{ m}^3/\text{s}$, determine the velocity in each section. Complete the table below.

Section	dimensions m	Area m^2	Velocity m/s	Marks
1	0.25 square			/ 5 marks
2	0.20 diameter			/ 5 marks

Total (10 marks)

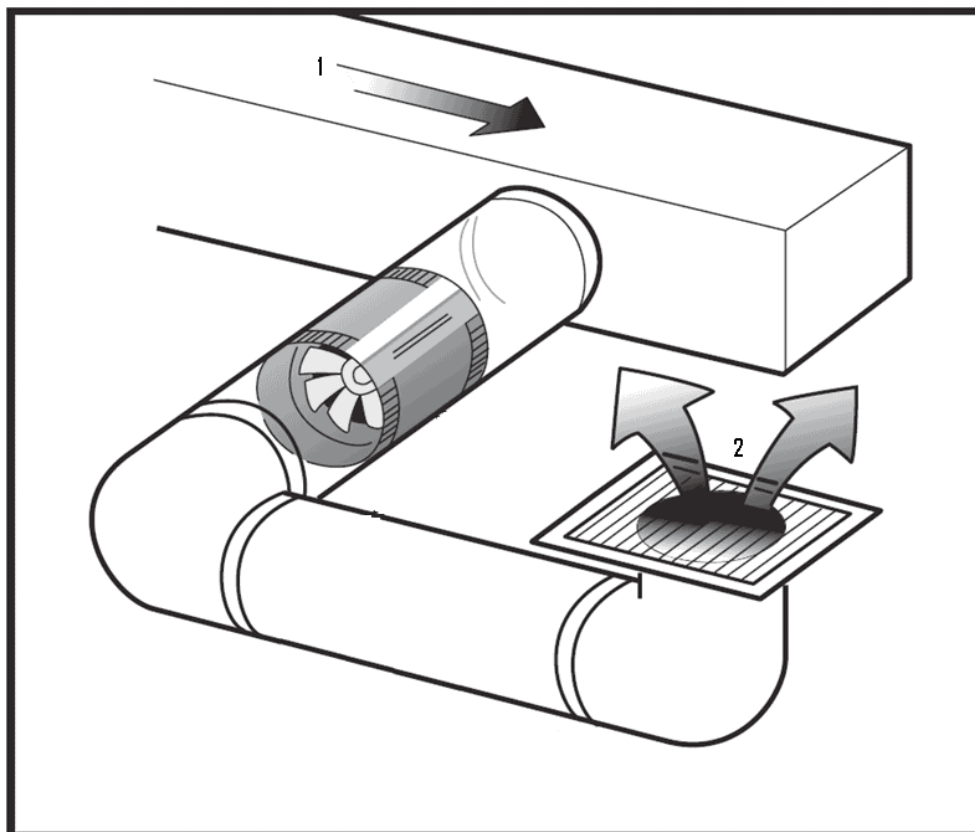

QUESTION SIX

Oil of relative density 0.90 flows at the rate of 100 kg/s in a horizontal pipe of 200 mm diameter, 1 km long. If the friction factor for the pipe is 0.006, complete the following table:

quantity	value	units	marks
flow velocity			/ 3 marks
frictional head loss			/ 3 marks
frictional pressure loss			/ 2 marks
energy to overcome friction			/ 2 marks

Total (10 marks)

QUESTION SEVEN

Show that Bernoulli's equation is dimensionally homogeneous

4 marks for the p-term,

4 marks for the v-term, and

2 marks for the z-term and for stating that all dimensions have/have not the same dimensions

Total (10 marks)

QUESTION EIGHT

Oil (relative density 0.85, kinematic viscosity 80cs) flows at the rate of 90 tonne per hour along a 100 mm bore smooth pipe. Determine for the flow:

Quantity	value	marks
flow velocity		/ 3 marks
frictional factor		/ 3 marks
Nature of the flow		/ 6 marks

Total (12 marks)

QUESTION NINE

List two instruments for measuring the flow rate of air through a rectangular duct.

Method	Principle	marks
		/ 4 marks
		/ 4 marks

Total (8 marks)

QUESTION TEN

Draw the body force diagram for a parachute jumper.

If the vertical component of the landing velocity of a parachute is 6 m/s, find the total weight of the parachutist and the parachute (hollow hemisphere Diameter 5m) Assume for air at ambient conditions, Density = 1.2 kg/m^3 and $C_d = 2.3$



For correct body force diagram

/3marks

For correct use of formula

/ 3 marks

For correct answer

/4 marks

Total (10 marks)

Please click the advert



Technical training on *WHAT* you need, *WHEN* you need it

At IDC Technologies we can tailor our technical and engineering training workshops to suit your needs. We have extensive experience in training technical and engineering staff and have trained people in organisations such as General Motors, Shell, Siemens, BHP and Honeywell to name a few.

Our onsite training is cost effective, convenient and completely customisable to the technical and engineering areas you want covered. Our workshops are all comprehensive hands-on learning experiences with ample time given to practical sessions and demonstrations. We communicate well to ensure that workshop content and timing match the knowledge, skills, and abilities of the participants.

We run onsite training all year round and hold the workshops on your premises or a venue of your choice for your convenience.

For a no obligation proposal, contact us today at training@idc-online.com or visit our website for more information: www.idc-online.com/onsite/

**OIL & GAS
ENGINEERING**

ELECTRONICS

**AUTOMATION &
PROCESS CONTROL**

**MECHANICAL
ENGINEERING**

**INDUSTRIAL
DATA COMMS**

**ELECTRICAL
POWER**

Phone: **+61 8 9321 1702**

Email: training@idc-online.com

Website: www.idc-online.com



Formulae Sheet

FLUID STATICS:

$$P = \rho g h$$

CONTINUITY EQUATION:

$$\text{mass flow rate } \dot{m} = \rho A V$$

$$\text{volume flow rate } Q = A V$$

ENERGY EQUATION

$$(P/\rho g) + (V^2/2g) + Z = \text{constant}$$

DARCY'S EQUATION

$$H_f = (4 f L / D) (V^2/2g)$$

FRICTION FACTOR FOR A SMOOTH PIPE

$$f = 16 / \text{Re} \quad \text{if } \text{Re} < 2000$$

$$f = 0.079 / \text{Re}^{0.25} \quad \text{if } \text{Re} > 4000$$

MOMENTUM EQUATION

$$F = \dot{m} (V_2 \cos\theta - V_1)$$

$$\text{DRAG FORCE} = C_d \times (1/2) \times \rho \cdot A \cdot V^2$$

FLUID POWER

$$E = \rho Q g h \times \eta \quad \text{for a turbine}$$

$$E = \rho Q g h / \eta \quad \text{for a pump}$$