

大学环境教育丛书

影印版

W. Wesley Eckenfelder, Jr.

# Industrial Water Pollution Control

(Third Edition)

# 工业水污染控制

(第3版)



清华大学出版社  
<http://www.tup.tsinghua.edu.cn>



麦格劳-希尔教育出版集团  
<http://www.mheducation.com>

Mc  
Graw  
Hill

# Industrial Water Pollution Control

(Third Edition)

## 工业水污染控制

(第3版)

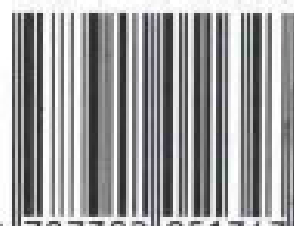
本书介绍了水污染控制的基本理论以及这些理论在处理实际工业废水中的应用，还讨论了一些可使用的替代工艺。书中提供的一系列工业废水处理例题及实际案例，来自纸浆及造纸、化工与制药、印染、食品与同类产品、金属抛光等各行业。书中提供了大量图表，以利于读者了解工业废水处理设施的设计和运行，书中还给出了许多详细的设计案例。

本书可作为高等院校与水污染控制相关课程的教材，并可供有关科技工作者参考。

### 大学环境教育丛书（影印版）

- Environmental Science  
A Study of Interrelationships (Seventh Edition)  
环境科学 —— 交叉关系学科（第7版）
- Air Pollution Control Engineering (Second Edition)  
大气污染控制工程（第2版）
- Integrated Solid Waste Management  
Engineering Principles and Management Issues  
固体废物的全过程管理 —— 工程原理及管理问题
- Chemistry for Environmental Engineering (Fourth Edition)  
环境工程化学（第4版）
- Industrial Water Pollution Control (Third Edition)  
工业水污染控制（第3版）
- Pollution Prevention: Fundamentals and Practice  
污染预防：理论与实践
- Introduction to Engineering and the Environment  
工程与环境引论

ISBN 7-302-05134-8



9 787302 051343 >

定价：48.00元

McGraw-Hill  
全球智慧中文化

大学环境教育丛书(影印版)

# **Industrial Water Pollution Control**

(Third Edition)

# **工业水污染控制**

(第3版)

W. Wesley Eckenfelder, Jr.

清华大学出版社

McGraw-Hill

(京)新登字 158 号

## Industrial Water Pollution Control(Third Edition)

W. Wesley Eckenfelder, Jr.

Copyright © 2000 by the McGraw-Hill Companies, Inc.

IESBN 0 07 116275-5

Original language published by the McGraw-Hill Companies, Inc. All rights reserved. No part of this publication may be reproduced or distributed in any means, or stored in a database or retrieval system, without the prior written permission of the publisher.

Authorized English language reprint edition jointly published by McGraw-Hill Education (Asia)Co. and Tsinghua University Press. This edition is authorized for sale in the People's Republic of China only, excluding Hong Kong, Macao SAR and Taiwan. Unauthorized export of this edition is a violation of the Copyright Act. Violation of this Law is subject to Civil and Criminal Penalties.

本书英文影印版由清华大学出版社和美国麦格劳-希尔教育出版(亚洲)公司合作出版。此版本仅限在中华人民共和国境内(不包括香港、澳门特别行政区及台湾)销售。未经许可之出口,视为违反著作权法,将受法律之制裁。

未经出版者预先书面许可,不得以任何方式复制或抄袭本书的任何部分。

本书封面贴有 McGraw-Hill 公司激光防伪标签,无标签者不得销售。

北京市版权局著作权合同登记号:图字:01-2002-0231

书 名:工业水污染控制(第3版)

作 者:W. Wesley Eckenfelder, Jr.

出版者:清华大学出版社(北京清华大学学研大厦,邮编 100084)

<http://www.tup.tsinghua.edu.cn>

印刷者:北京牛山世兴印刷厂

发行者:新华书店总店北京发行所

开 本:787×960 1/16 印张:37.25

版 次:2002年2月第1版 2002年2月第1次印刷

书 号:ISBN 7-302-05134-8/X·35

印 数:0001~3000

定 价:48.00 元

# 出版前言

在跨入 21 世纪之际,面临不断恶化的生存环境,人类清醒地认识到要走可持续发展之路。而发展环境教育是解决环境问题和实施可持续发展战略的根本。高等学校的环境教育,是提高新世纪建设者的环境意识,并向社会输送环境保护专门人才的重要途径。为了反映国外环境类教材的最新内容和编写风格,同时也为了提高学生阅读专业文献和获取信息的能力,我们精选了一些国外优秀的环境类教材,组成大学环境教育丛书(影印版),本书即为其中的一册。所选教材均在国外被广泛采用,多数已再版,书中不仅介绍了有关概念、原理及技术方法,给出了丰富的数据,还反映了作者不同的学术观点。

我们希望这套丛书能对高等院校师生和广大科技人员有所帮助,同时对我国环境教育的发展作出贡献。

清华大学出版社  
McGraw-Hill 出版公司  
2001 年 7 月

---

## ABOUT THE AUTHOR

---

W. WESLEY ECKENFELDER, JR., received degrees in civil engineering from Manhattan College and environmental engineering from Pennsylvania State University and New York University. In 1990 he received an honorary D.Sc. degree from Manhattan College. He was associate professor at Manhattan College, professor at the University of Texas, and is presently Emeritus Distinguished Professor of Environmental Engineering at Vanderbilt University. He was a founder of the consulting firm of Hydroscience, Inc., a partner in Weston Eckenfelder & Associates (now Roy F. Weston, Inc.) and has served as board chairman of AWARE Incorporated and Eckenfelder, Inc.

He has developed continuing education courses in water pollution control for Manhattan College, the University of Texas, Vanderbilt University, the University of Queensland, Australia, the American Institute of Chemical Engineers, and the Chemical Manufacturers Association. He has organized courses and workshops in 17 countries in Asia, Europe, Africa and Latin America.

He has served as consultant to over 150 industries, municipalities, consulting firms, and governmental agencies.

He is an author or editor of 31 books and over 200 technical papers in water pollution control including *Industrial Water Pollution Control*, McGraw-Hill, (1967 and 1989); *Principles of Water Quality Management*, CBI Publishing (1980); and *Water Pollution Control*, Jenkins Publishing Co. (1978). These books have been translated into Japanese and Chinese and one into French and Italian. Professor Eckenfelder is on numerous editorial boards including *Water Technology Letters* (U.K.) and *Hazardous Waste and Hazardous Materials*.

He is a member of numerous technical societies including the Water Pollution Control Federation (honorary member), the American Institute of Chemical Engineers, and the American Society of Civil Engineers. He is an honorary member of the International Association on Water Quality.

In 1974 he was awarded the Synthetic Organic Chemicals Manufacturers Association gold medal for excellence in environmental chemistry, in 1957 the Rudolfs Medal, and in 1981 the Thomas Camp Medal from the Water Pollution Control Federation. In 1998 he received the Lawrence Cecil Award from the American Institute of Chemical Engineers. In 1999 he received the Gordon Maskew Fair Award from the American Academy of Environmental Engineers.

He is a registered Professional Engineer in the State of Texas.

---

## PREFACE

---

It has been 30 years since this book was first published and 10 years since the second edition. During that period not only have regulations undergone a vast change, but conventional technologies have been further refined and new technologies have been developed to meet increasingly more stringent water quality criteria. Effluent limitation on specific priority pollutants and toxicity to aquatic organisms have rendered many of the older conventional treatment facilities obsolete. The challenge today is to meet these new requirements in a way that is both environmentally acceptable and cost-effective.

In order to address these new challenges, the present volume reviews the existing theory and addresses the application of state-of-the-art technology to the solution of today's problems in industrial water pollution control.

Of necessity, this book does not develop the detailed principles or the theory of processes applicable to specific areas of water pollution control. Rather it stresses the application of these theories to specific industrial problems. Publications and texts are referenced in the bibliography for the reader who wishes a more detailed development of the theory.

Where applicable, case histories are used to illustrate the application of technology to specific industrial applications. Problems are drawn from field experience.

This book is intended as a text for the student in courses related to industrial water pollution control and as a guide for the engineer in industry, governmental agencies, and consulting engineering firms involved in developing state-of-the-art solutions to industrial water pollution control problems.

While all specific problems cannot be answered in one text, it is hoped that this volume will provide guidance and direction to those faced with the increasingly more complex solutions of water pollution control.

Special thanks to Dr. Alan Bowers of Vanderbilt University for his contribution to the chapter on chemical oxidation.

I would like to express my thanks for many useful comments and suggestions provided by colleagues who reviewed this text during the course of its development, especially to Robert W. Okey, the University of Utah; Bruce DeVantier, Southern Illinois University at Carbondale; Peter Fox, Arizona State University; Clifford W. Randall, Virginia Polytechnic University; and Paul M. Berthouex, University of Wisconsin–Madison.

W. Wesley Eckenfelder



---

# CONTENTS

---

Preface	xi
<b>1 Source and Characteristics of Industrial Wastewaters</b>	<b>1</b>
1.1 Undesirable Wastewater Characteristics	1
1.2 Partial List of Regulations Which Affect Wastewater Treatment Requirements within the United States	4
1.3 Sources and Characteristics of Wastewaters	5
1.4 Industrial Waste Survey	5
1.5 Waste Characteristics—Estimating the Organic Content	14
1.6 Measuring Effluent Toxicity	25
1.7 In-plant Waste Control and Water Reuse	34
1.8 Stormwater Control	43
<b>2 Wastewater Treatment Processes</b>	<b>51</b>
<b>3 Pre- and Primary Treatment</b>	<b>64</b>
3.1 Equalization	65
3.2 Neutralization	75
3.3 Sedimentation	85
3.4 Oil Separation	103
3.5 Sour Water Strippers	108
3.6 Flotation	109
<b>4 Coagulation, Precipitation, and Metals Removal</b>	<b>124</b>
4.1 Coagulation	124
4.2 Heavy Metals Removal	138
<b>5 Aeration and Mass Transfer</b>	<b>158</b>
5.1 Mechanism of Oxygen Transfer	158
5.2 Aeration Equipment	171
5.3 Air Stripping of Volatile Organic Compounds	186

<b>6</b>	<b>Principles of Aerobic Biological Oxidation</b>	198
6.1	Organics Removal Mechanisms	198
6.2	The Mechanisms of Organic Removal by Biooxidation	203
6.3	Effect of temperature	240
6.4	Sludge Quality Considerations	250
6.5	Soluble Microbial Product Formation	262
6.6	Bioinhibition of the Activated Sludge Process	263
6.7	Stripping of Volatile Organics	271
6.8	Nitrification and Denitrification	276
6.9	Laboratory and Pilot Plant Procedures for Development of Process Design Criteria	301
<b>7</b>	<b>Biological Wastewater Treatment Processes</b>	313
7.1	Lagoons and Stabilization Basins	313
7.2	Aerated Lagoons	322
7.3	Activated Sludge Processes	340
7.4	Trickling Filtration	375
7.5	Rotating Biological Contactors	388
7.6	Anaerobic Decomposition	394
7.7	Laboratory Evaluation of Anaerobic Treatment	406
<b>8</b>	<b>Adsorption</b>	417
8.1	Theory of Adsorption	417
8.2	Properties of Activated Carbon	421
8.3	The PACT® Process	443
<b>9</b>	<b>Ion Exchange</b>	451
9.1	Theory of Ion Exchange	451
9.2	Plating Waste Treatment	457
<b>10</b>	<b>Chemical Oxidation</b>	462
10.1	Introduction	462
10.2	Stoichiometry	463
10.3	Applicability	465
10.4	Ozone	467
10.5	Hydrogen Peroxide	470
10.6	Chlorine	475
10.7	Potassium Permanganate	478
10.8	Oxidation Overview	479
10.9	Hydrothermal Processes	481
<b>11</b>	<b>Sludge Handling and Disposal</b>	484
11.1	Characteristics of Sludges for Disposal	484
11.2	Aerobic Digestion	486
11.3	Gravity Thickening	493

11.4	Flotation Thickening	498
11.5	Rotary Drum Screen	501
11.6	Gravity Belt Thickener	502
11.7	Disk Centrifuge	502
11.8	Basket Centrifuge	502
11.9	Specific Resistance	504
11.10	Centrifugation	509
11.11	Vacuum Filtration	514
11.12	Pressure Filtration	517
11.13	Belt Filter Press	520
11.14	Screw Press	523
11.15	Sand Bed Drying	523
11.16	Factors Affecting Dewatering Performance	525
11.17	Land Disposal of Sludges	525
11.18	Incineration	532
<b>12</b>	<b>Miscellaneous Treatment Processes</b>	<b>536</b>
12.1	Land Treatment	536
12.2	Deep-Well Disposal	544
12.3	Membrane Processes	547
12.4	Phosphorus Removal	561
12.5	Granular Media Filtration	567
12.6	Microscreen	573
	Bibliography	577
	Index	579

---

# SOURCE AND CHARACTERISTICS OF INDUSTRIAL WASTEWATERS

---

## 1.1

### UNDESIRABLE WASTEWATER CHARACTERISTICS

Depending on the nature of the industry and the projected uses of the waters of the receiving stream, various waste constituents may have to be removed before discharge. These may be summarized as follows:

1. Soluble organics causing depletion of dissolved oxygen. Since most receiving waters require maintenance of minimum dissolved oxygen, the quantity of soluble organics is correspondingly restricted to the capacity of the receiving waters for assimilation or by specified effluent limitations.
2. Suspended solids. Deposition of solids in quiescent stretches of a stream will impair the normal aquatic life of the stream. Sludge blankets containing organic solids will undergo progressive decomposition resulting in oxygen depletion and the production of noxious gases.
3. Priority pollutants such as phenol and other organics discharged in industrial wastes will cause tastes and odors in the water and in some cases are carcinogenic. If these contaminants are not removed before discharge, additional water treatment will be required.
4. Heavy metals, cyanide, and toxic organics. The EPA has defined a list of toxic organic and inorganic chemicals that now appear as specific limitations in most permits. The identified priority pollutants are listed in Table 1.1.
5. Color and turbidity. These present aesthetic problems even though they may not be particularly deleterious for most water uses. In some industries, such as pulp and paper, economic methods are not presently available for color removal.
6. Nitrogen and phosphorus. When effluents are discharged to lakes, ponds, and other recreational areas, the presence of nitrogen and phosphorus is particularly undesirable since it enhances eutrophication and stimulates undesirable algae growth.

**TABLE 1.1**  
**EPA list of organic priority pollutants**

Compound name	Compound name
1. Acenaphthene <sup>†</sup>	Dichlorobenzidine <sup>†</sup>
2. Acrolein <sup>†</sup>	28. 3,3'-Dichlorobenzidine
3. Acrylonitrile <sup>‡</sup>	
4. Benzene <sup>†</sup>	Dichloroethylenes <sup>†</sup> (1,1-dichloroethylene and 1,2-dichloroethylene)
5. Benzidine <sup>†</sup>	29. 1,1-Dichloroethylene
6. Carbon tetrachloride <sup>†</sup> (tetrachloromethane)	30. 1,2- <i>trans</i> -Dichloroethylene
	31. 2,4-Dichlorophenol <sup>†</sup>
Chlorinated benzenes (other than dichlorobenzenes)	Dichloropropane and dichloropropene <sup>†</sup>
7. Chlorobenzene	32. 1,2-Dichloropropane
8. 1,2,4-Trichlorobenzene	33. 1,2-Dichloropropylene (1,2- dichloropropene)
9. Hexachlorobenzene	
Chlorinated ethanes <sup>†</sup> (including 1,2- dichloroethane, 1,1,1-trichloroethane, and hexachloroethane)	34. 2,4-Dimethylphenol <sup>†</sup>
10. 1,2-Dichloroethane	Dinitrotoluene <sup>†</sup>
11. 1,1,1-Trichloroethane	35. 2,4-Dinitrotoluene
12. Hexachloroethane	36. 2,6-Dinitrotoluene
13. 1,1-Dichloroethane	37. 1,2-Diphenylhydrazine <sup>†</sup>
14. 1,1,2-Trichloroethane	38. Ethylbenzene <sup>†</sup>
15. 1, 1,2,2-Tetrachloroethane	39. Fluoranthene <sup>†</sup>
16. Chloroethane (ethyl chloride)	Haloethers <sup>†</sup> (other than those listed elsewhere)
Chloroalkyl ethers <sup>†</sup> (chloromethyl, chloroethyl, and mixed ethers)	40. 4-Chlorophenyl phenyl ether
17. Bis(chloromethyl) ether	41. 4-Bromophenyl phenyl ether
18. Bis(2-chloroethyl) ether	42. Bis(2-chloroisopropyl) ether
19. 2-Chloroethyl vinyl ether (mixed)	43. Bis(2-chloroethoxy) methane
Chlorinated naphthalene <sup>†</sup>	Halomethanes <sup>†</sup> (other than those listed elsewhere)
20. 2-Chloronaphthalene	44. Methylene chloride (dichloromethane)
Chlorinated phenols <sup>†</sup> (other than those listed elsewhere; includes trichlorophenols and chlorinated cresols)	45. Methyl chloride (chloromethane)
21. 2,4,6-Trichlorophenol	46. Methyl bromide (bromomethane)
22. <i>para</i> -Chloro- <i>meta</i> -cresol	47. Bromoform (tribromomethane)
23. Chloroform (trichloromethane) <sup>†</sup>	48. Dichlorobromomethane
24. 2-Chlorophenol <sup>†</sup>	49. Trichlorofluoromethane
Dichlorobenzenes <sup>†</sup>	50. Dichlorodifluoromethane
25. 1,2-Dichlorobenzene	51. Chlorodibromomethane
26. 1,3-Dichlorobenzene	52. Hexachlorobutadiene <sup>†</sup>
27. 1,4-Dichlorobenzene	53. Hexachlorocyclopentadiene <sup>†</sup>
	54. Isophorone <sup>†</sup>
	55. Naphthalene <sup>†</sup>
	56. Nitrobenzene <sup>†</sup>

TABLE 1.1 (continued)

Compound name	Compound name
Nitrophenols <sup>†</sup> (including 2,4-dinitrophenol and dinitrocresol)	87. Trichloroethylene <sup>†</sup>
57. 2-Nitrophenol	88. Vinyl chloride <sup>†</sup> (chloroethylene)
58. 4-Nitrophenol	Pesticides and metabolites
59. 2,4-Dinitrophenol <sup>†</sup>	89. Aldrin <sup>†</sup>
60. 4,6-Dinitro- <i>o</i> -cresol	90. Dieldrin <sup>†</sup>
Nitrosamines <sup>†</sup>	91. Chlordane <sup>†</sup> (technical mixture and metabolites)
61. <i>N</i> -Nitrosodimethylamine	DDT and metabolites <sup>†</sup>
62. <i>N</i> -Nitrosodiphenylamine	92. 4,4'-DDT
63. <i>N</i> -Nitrosodi- <i>n</i> -propylamine	93. 4,4'-DDE ( <i>p,p'</i> -DDX)
64. Pentachlorophenol <sup>†</sup>	94. 4,4'-DDD ( <i>p,p'</i> -TDE)
65. Phenol <sup>†</sup>	Endosulfan and metabolites <sup>†</sup>
Phthalate esters <sup>†</sup>	95. $\alpha$ -Endosulfan-alpha
66. Bis(2-ethylhexyl) phthalate	96. $\beta$ -Endosulfan-beta
67. Butyl benzyl phthalate	97. Endosulfan sulfate
68. Di- <i>n</i> -butyl phthalate	Endrin and metabolites <sup>†</sup>
69. Di- <i>n</i> -octyl phthalate	98. Endrin
70. Diethyl phthalate	99. Endrin aldehyde
71. Dimethyl phthalate	Heptachlor and metabolites <sup>†</sup>
Polynuclear aromatic hydrocarbons (PAH) <sup>†</sup>	100. Heptachlor
72. Benzo(a)anthracene (1,2-benzanthracene)	101. Heptachlor epoxide
73. Benzo(a)pyrene (3,4-benzopyrene)	Hexachlorocyclohexane (all isomers) <sup>†</sup>
74. 3,4-Benzofluoranthene	102. $\alpha$ -BHC-alpha
75. Benzo(k)fluoranthene (11,12-benzofluoranthene)	103. $\beta$ -BHC-beta
76. Chrysene	104. $\gamma$ -BHC (lindane)-gamma
77. Acenaphthylene	105. $\delta$ -BHC-delta
78. Anthracene	Polychlorinated biphenyls (PCB) <sup>†</sup>
79. Benzo(ghi)perylene (1,12-benzoperylene)	106. PCB-1242 (Arochlor 1242)
80. Fluorene	107. PCB-1254 (Arochlor 1254)
81. Phenanthrene	108. PCB-1221 (Arochlor 1221)
82. Dibenzo(a,h)anthracene (1,2,5,6-dibenzanthracene)	109. PCB-1232 (Arochlor 1232)
83. Indeno (1,2,3-cd) pyrene (2,3-phenylenepyrene)	110. PCB-1248 (Arochlor 1248)
84. Pyrene	111. PCB-1260 (Arochlor 1260)
85. Tetrachloroethylene <sup>†</sup>	112. PCB-1016 (Arochlor 1016)
86. Toluene <sup>†</sup>	113. Toxaphene <sup>†</sup>
	114. 2,3,7,8-Tetrachlorodibenzo- <i>p</i> -dioxin (TCDD) <sup>†</sup>

<sup>†</sup>Specific compounds and chemical classes as listed in the consent degree.

7. Refractory substances resistant to biodegradation. These may be undesirable for certain water-quality requirements. Refractory nitrogen compounds are found in the textile industry. Some refractory organics are toxic to aquatic life.
8. Oil and floating material. These produce unsightly conditions and in most cases are restricted by regulations.
9. Volatile materials. Hydrogen sulfide and volatile organics will create air-pollution problems and are usually restricted by regulation.
10. Aquatic toxicity. Substances present in the effluent that are toxic to aquatic species and are restricted by regulation.

## 1.2

### PARTIAL LIST OF REGULATIONS WHICH AFFECT WASTEWATER TREATMENT REQUIREMENTS WITHIN THE UNITED STATES

It is not the intent of this book to discuss federal and state regulations, but a brief summary of present regulatory requirements relative to industrial water pollution control will serve as guidance to the reader. Details of these regulations can be found in the cited Code of the Federal Register (CFR) as noted.

#### Air

##### NESHAP

- Regulates carcinogenic VOCs to mass loading and concentration limits. For example, in the case of benzene anything in excess of 10 mg/l concentration in the wastewater or 10 Mg/yr. Requires off-gas capture and treatment until such limits are achieved.

##### National Emission Standards for Hazardous Air Pollutants (40 CFR, part 61)

- Regulates 60 VOCs to mass loading and concentration limits. Requires off-gas capture and treatment until a required percent removal is achieved.

##### Occupational Safety and Health Administration Standards

- Regulates hydrogen sulfide and contaminants which pose exposure risks.

#### Liquid

##### Federal Industry Point Source Category Limits (40 CFR, part 405-471)

- Mass-based for raw material processing, e.g., pulp and paper, and concentration-based for synthetic chemicals and pharmaceuticals for conventional pollutants.
- Concentration-based limits for nonconventional pollutants (metals and priority pollutants).

##### Regional Initiatives (e.g., Great Lakes Initiative)

- For example, concentration-based limits for total phosphorus.

### State Water Quality Standards

- Limits for pollutants based on design receiving stream low flow (i.e., 7-Q10, the average 7-day low flow every ten years) for the use classification.

### Local Pretreatment Limits (USEPA, PB92-129188, December 1987)

- Those regulated under point source categories, plus those required to ensure POTW (publicly owned treatment works) effluent compliance.

## 1.3

### SOURCES AND CHARACTERISTICS OF WASTEWATERS

The volume and strength of industrial wastewaters are usually defined in terms of units of production (e.g., gallons per ton<sup>†</sup> of pulp or cubic meters per tonne<sup>‡</sup> of pulp and pounds of BOD per ton of pulp or kilograms of BOD per tonne of pulp for a pulp-and-paper-mill waste) and the variation in characteristic by a statistical distribution. In any one plant there will be a statistical variation in wasteflow characteristic. The magnitude of this variation will depend on the diversity of products manufactured and of process operations contributing waste, and on whether the operations are batch or continuous. Good housekeeping procedures to minimize dumps and spills will reduce the statistical variation. Plots showing the variation in flow resulting from a sequence of batch processes are shown in Fig. 1.1. Variation in waste flow and characteristics within a single plant are shown in Fig. 1.2.

Wide variation in waste flow and characteristics will also appear among similar industries, e.g., the paperboard industry. This is a result of differences in housekeeping and water reuse as well as of variations in the production processes. Very few industries are identical in their sequence of process operations; as a result, an industrial waste survey is usually required to establish waste loadings and their variations. Variations for several industries are shown in Table 1.2. The variation in suspended solids and BOD (biochemical oxygen demand) discharge from 11 paperboard mills is shown in Fig. 1.3.

## 1.4

### INDUSTRIAL WASTE SURVEY

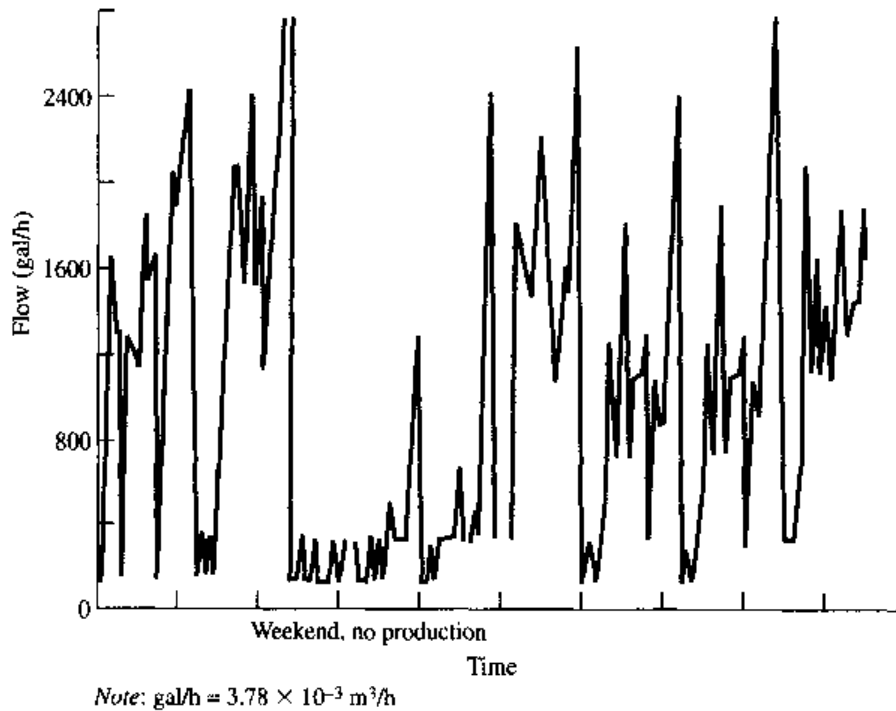
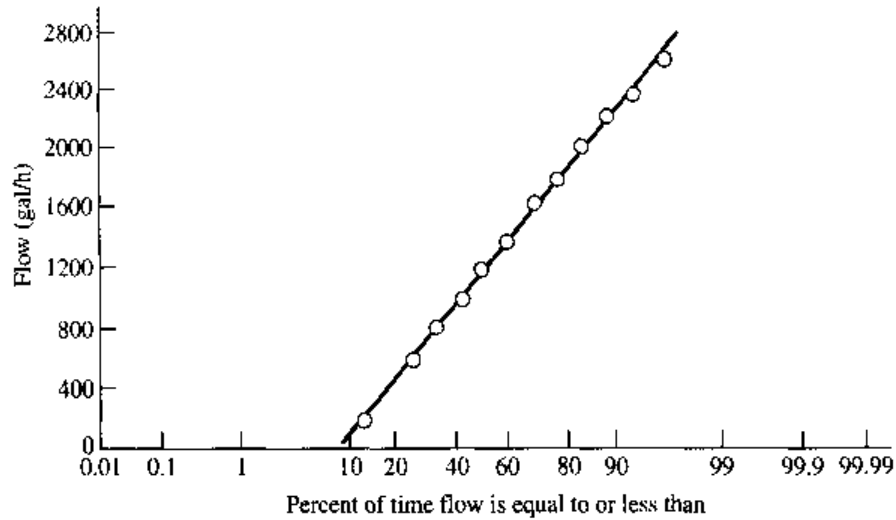
The industrial waste survey involves a procedure designed to develop a flow-and-material balance of all processes using water and producing wastes and to establish the variation in waste characteristics from specific process operations as well as from the plant as a whole. The results of the survey should establish possibilities for water conservation and reuse and finally the variation in flow and strength to undergo wastewater treatment.

---

<sup>†</sup>ton = 2000 lb.

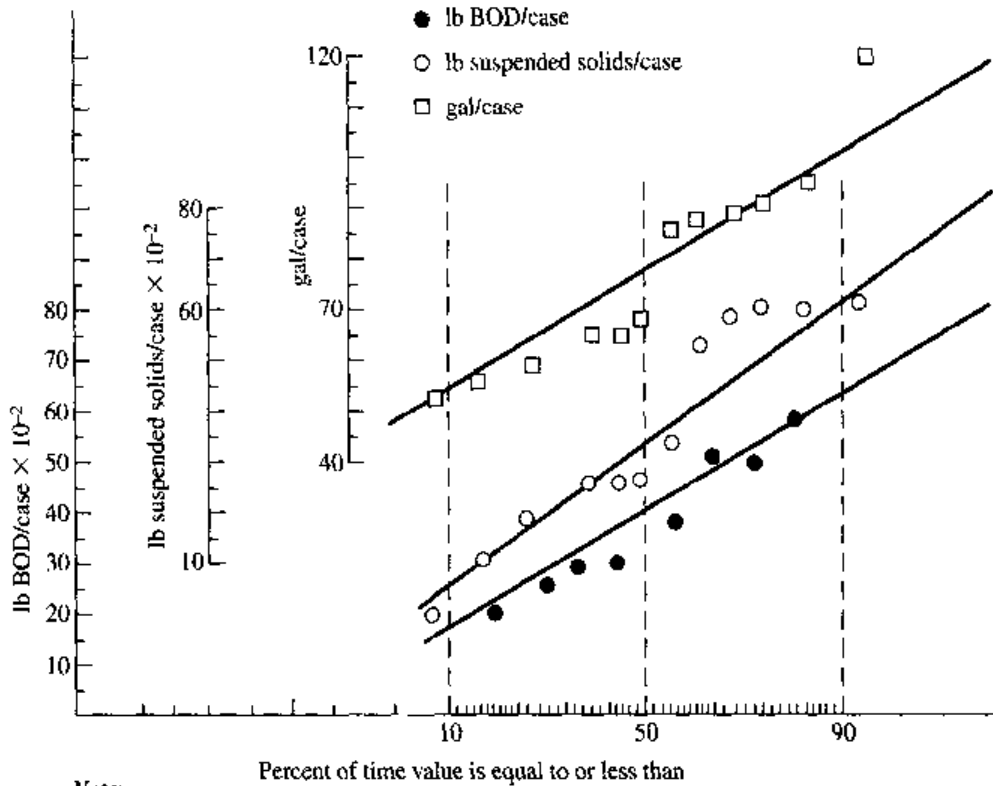
<sup>‡</sup>tonne = 1000 kg.





**FIGURE 1.1**  
Variation in flow from a batch operation.

The selected method of flow measurement will usually be contingent on the physical location to be sampled. When the waste flows through a sewer, it is frequently possible to measure the velocity of flow and the depth of water in the sewer and calculate the flow from the continuity equation. Since  $Q = AV$ , the area in a partially filled circular sewer can be determined given the depth from Fig. 1.4. This method applies only for partially filled sewers of constant cross section. The average velocity of flow can be estimated as 0.8 of the surface velocity timed from a floating object between manholes. More accurate measurements can be obtained by the use of a current meter. In gutters or channels, either a small weir can be constructed or



**FIGURE 1.2**  
Daily variation in flow and characteristics: tomato waste.

**TABLE 1.2**  
**Variation in flow and waste characteristics for some representative industrial wastes**

Waste	Flow, gal/production unit % frequency			BOD, lb/production unit % frequency			Suspended solids, lb/production unit % frequency		
	10	50	90	10	50	90	10	50	90
Pulp and paper <sup>†</sup>	11,000	43,000	74,000	17.0	58.0	110.0	26.0	105.0	400.0
Paperboard <sup>†</sup>	7,500	11,000	27,500	10	28	46	25	48	66
Slaughterhouse <sup>‡</sup>	165	800	4,300	3.8	13.0	44	3.0	9.8	31.0
Brewery <sup>§</sup>	130	370	600	0.8	2.0	44	0.25	1.2	2.45
Tannery <sup>¶</sup>	4.2	9.0	13.6	575 <sup>**</sup>	975	1400	600 <sup>**</sup>	1900	3200

<sup>†</sup> Tons paper production.

<sup>‡</sup> 1000 lb live weight kill.

<sup>§</sup> bbl beer.

<sup>¶</sup> Pounds of hides; sulfides as S vary from 260 mg/l (10%) to 1230 mg/l (90%).

<sup>\*\*</sup> As mg/l.

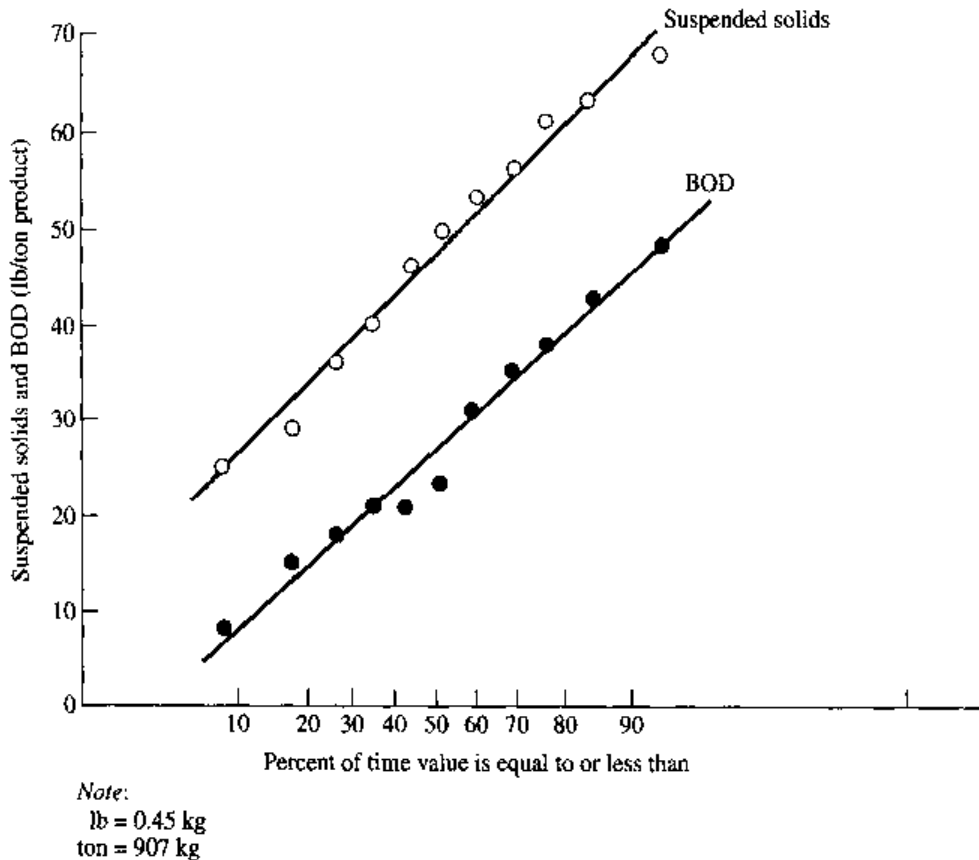
Note:

gal =  $3.78 \times 10^{-3} \text{ m}^3$

lb = 0.45 kg

ton = 907 kg

bbl beer = 0.164 m<sup>3</sup>



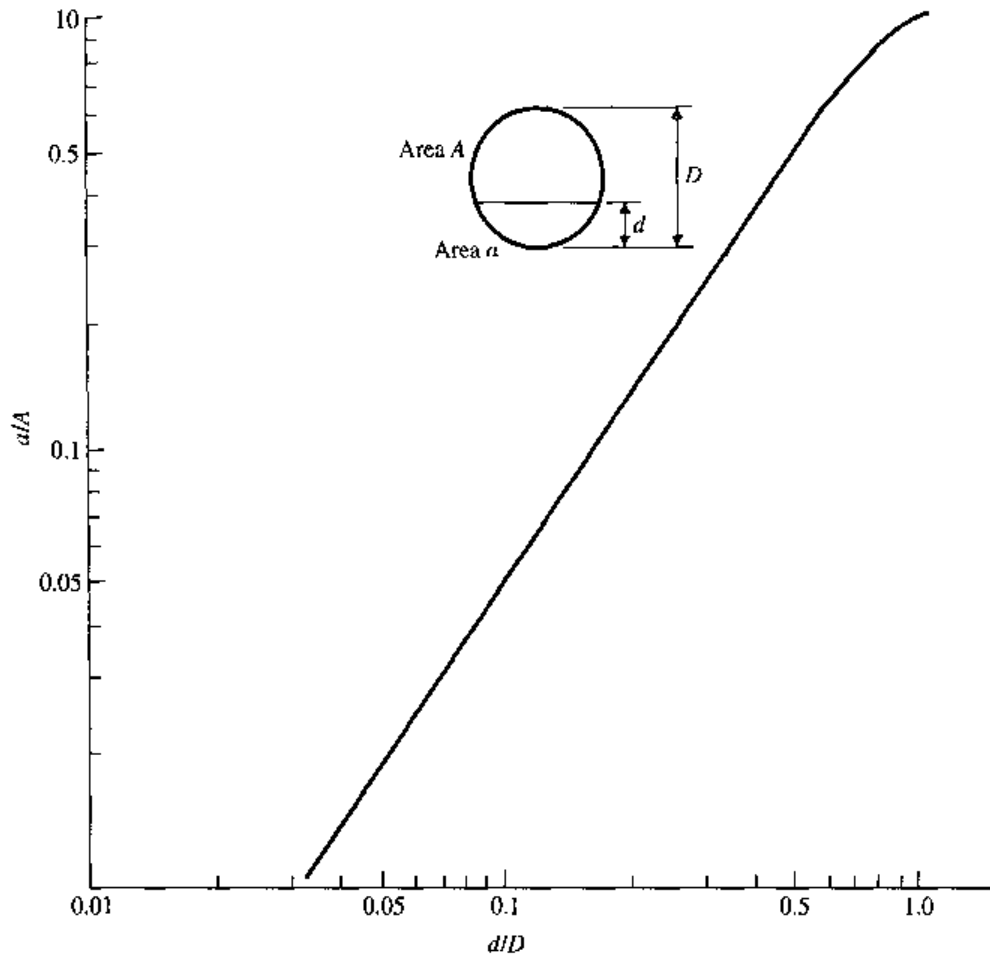
**FIGURE 1.3**

Variations in suspended solids and BOD from 11 paperboard mills.

the flow can be estimated as above by measuring the velocity and depth of flow in the channel. In some cases the flow can be obtained from the pumping rate and the duration of pumping of a wastestream. Total waste flow from an industrial plant can be measured by use of a weir or other suitable measuring device. In certain instances the daily waste flow can be estimated from water consumption records.

The general procedure to be followed in developing the necessary information with a minimum of effort can be summarized in four steps:

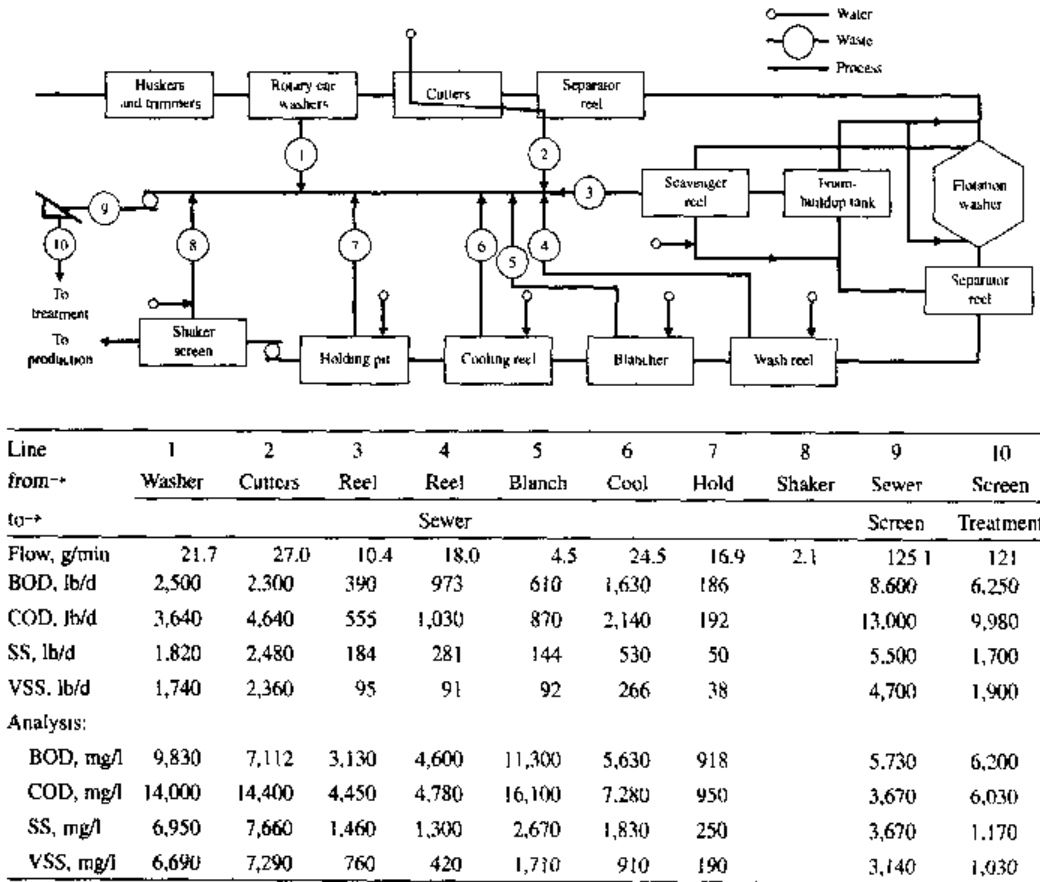
1. Develop a sewer map from consultation with the plant engineer and an inspection of the various process operations. This map should indicate possible sampling stations and a rough order of magnitude of the anticipated flow.
2. Establish sampling and analysis schedules. Continuous samples with composites weighted according to flow are the most desirable, but these either are not always possible or do not lend themselves to the physical sampling location. The period of sample composite and the frequency of sampling must be established according to the nature of the process being investigated. Some continuous processes can be sampled hourly and composited on an 8-, 12-, or even 24-h basis, but those that exhibit a high degree of fluctuation may require a 1- or 2-h composite and analysis. More frequent samples are rarely required, since most industrial waste-treatment processes have a degree of built-in equalization and storage capacity. Batch processes should be composited during the course of the batch dump.



**FIGURE 1.4**  
Determination of waste flow in partially filled sewers.

3. Develop a flow-and-material-balance diagram. After the survey data are collected and the samples analyzed, a flow-and-material balance diagram should be developed that considers all significant sources of waste discharge. How closely the summation of the individual sources checks the measured total effluent provides a check on the accuracy of the survey. A typical flow-and-material-balance diagram for a corn-processing plant is shown in Fig. 1.5.
4. Establish statistical variation in significant waste characteristics. As was previously shown, the variability of certain waste characteristics is significant for waste-treatment plant design. These data should be prepared as a probability plot showing frequency of occurrence.

The analyses to be run on the samples depend both on the characteristics of the samples and on the ultimate purpose of the analysis. For example, pH must be run on grab samples, since it is possible in some cases for compositing to result in neutralization of highly acidic and basic wastes, and this would yield highly misleading information for subsequent design. Variations in BOD loading may require 8-h or shorter composites for certain biological-treatment designs involving short detention periods, while 24-h composites will usually suffice for aerated lagoons with many days' retention under completely mixed conditions. Where constituents



Note:

gal/min =  $3.78 \times 10^{-3} \text{ m}^3/\text{min}$

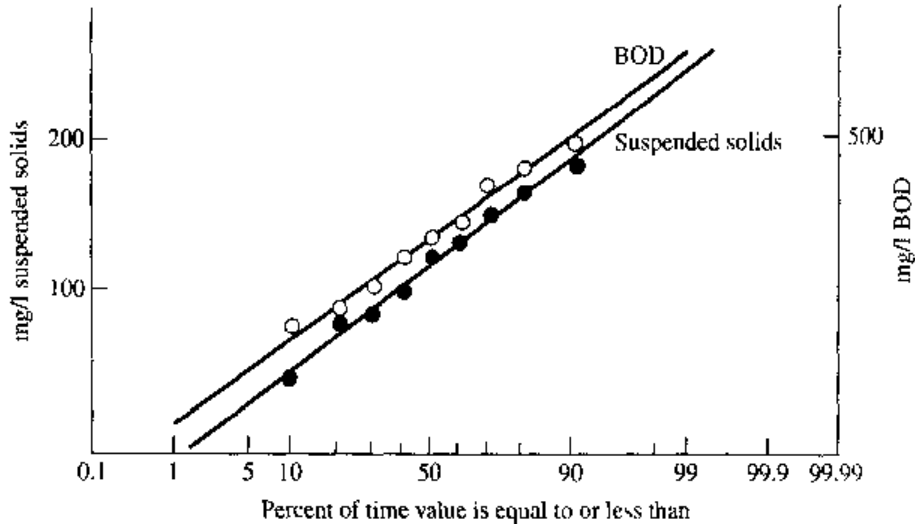
lb/d = 0.45 kg/d

**FIGURE 1.5**

Waste flow diagram and material balance at a corn plant.

such as nitrogen or phosphorus are to be measured to determine required nutrient addition for biological treatment, 24-h composites are sufficient since the biological system possesses a degree of buffer capacity. One exception is the presence of toxic discharges to a biological system. Since a one-shot dose of certain toxic materials can completely upset a biological-treatment process, continuous monitoring of such materials is required if they are known to exist. It is obvious that the presence of such materials would require separate consideration in the waste-treatment design. Other waste-treatment processes may require similar considerations in sampling schedules.

Data from industrial waste surveys are highly variable and are usually susceptible to statistical analysis. Statistical analysis of variable data provides the basis for process design. The data are reported in terms of frequency of occurrence of a particular characteristic, which is that value of the characteristic that may be expected to be equaled or not exceeded 10, 50, or 90 percent of the time. The 50 percent chance value is approximately equal to the median. Correlation in this manner will linearize variable data, as shown in Fig. 1.6. The probability of occurrence of any value, such as flow, BOD, or suspended solids, may be determined as shown in the probability plot. This can also be determined by a standard computer program.



**FIGURE 1.6**  
Probability of occurrence of BOD and suspended solids in raw waste.

The suspended solids and BOD values are each arranged in order of increasing magnitude.  $n$  is the total number of solids or BOD values and  $m$  is the assigned serial number from 1 to  $n$ . The plotting positions  $m/(n + 1)$  are equivalent to the percent occurrence of the value. The actual values are then plotted against the percent occurrences on probability paper, as indicated in Fig. 1.6. A smooth curve of best fit may usually be drawn by eye or, if desirable, it may be calculated by standard statistical procedures. The probability of occurrence of any values can be obtained. The statistical calculation is shown in Example 1.1. In order to extrapolate the results of an industrial waste survey to future production, it is desirable to relate waste flow and loading to production schedules. Since some effluent-producing operations do not vary directly with production increase or decrease, the scale-up is not always linear. This is true of the cannery operation shown in Fig. 1.7, in which six process operations were independent of the number of washing and cleaning rigs in operation.

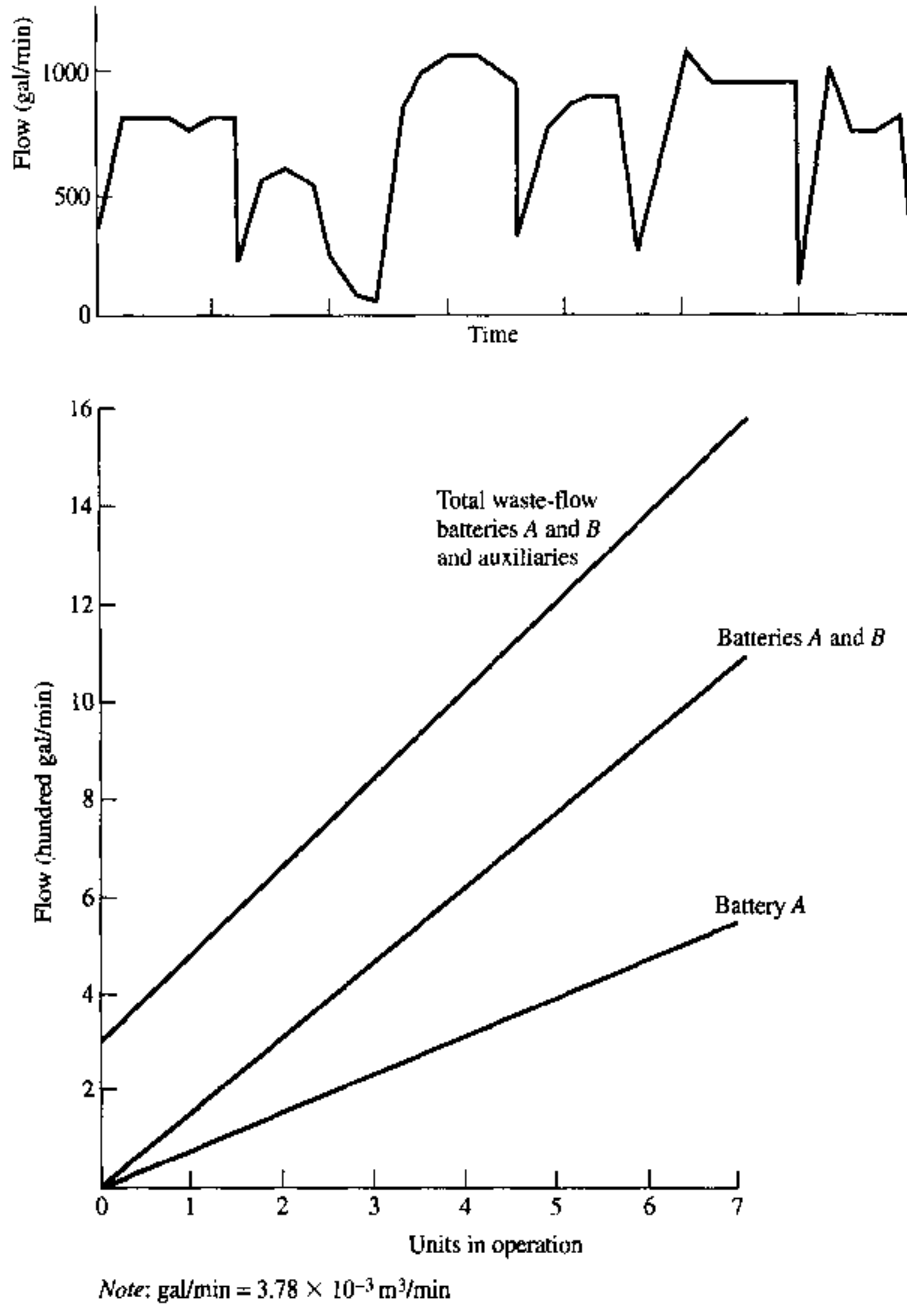
**EXAMPLE 1.1.** For small amounts of industrial waste survey data (i.e., less than 20 datum points), the statistical correlation procedure is as follows:

1. Arrange the data in increasing order of magnitude (first column of Table 1.3).
2. In the second column of Table 1.3,  $m$  is the assigned serial number from 1 to  $n$  where  $n$  is the total number of values.
3. The plotting position is determined by dividing the total number of samples into 100 and assigning the first value as one-half this number (third column of Table 1.3):

$$\text{Plotting position} = \frac{100}{n} + \text{previous probability}$$

For  $m = 5$ :

$$\begin{aligned} \text{Plotting position} &= \frac{100}{9} + 38.85 \\ &= 49.95 \end{aligned}$$



**FIGURE 1.7**  
Variation in plant waste flow from unit operations.

4. These data are illustrated in Fig. 1.8. The standard deviation of these data ( $S$ ) is calculated by

$$S = \frac{X_{84.1\%} - X_{15.9\%}}{2}$$

From Fig. 1.8:

$$\begin{aligned} S &= \frac{436 - 254}{2} \\ &= 91 \text{ mg/l} \end{aligned}$$

TABLE 1.3  
Statistical correlation of BOD data

BOD, mg/l	<i>m</i>	Plotting position
200	1	5.55
225	2	16.65
260	3	27.75
315	4	38.85
350	5	49.95
365	6	61.05
430	7	72.15
460	8	83.75
490	9	94.35

and mean:

$$\begin{aligned}\bar{X} &= X_{50.0\%} \\ &= 335 \text{ mg/l}\end{aligned}$$

When large numbers of data are to be analyzed it is convenient to group the data for plotting, for example, 0 to 50, 51 to 100, 101 to 150, etc. The plotting position is determined as  $m/(n + 1)$ , where  $m$  is the cumulative number of points and  $n$  is the total number of observations. The statistical distribution of data serves several important functions in developing the industrial waste management program.

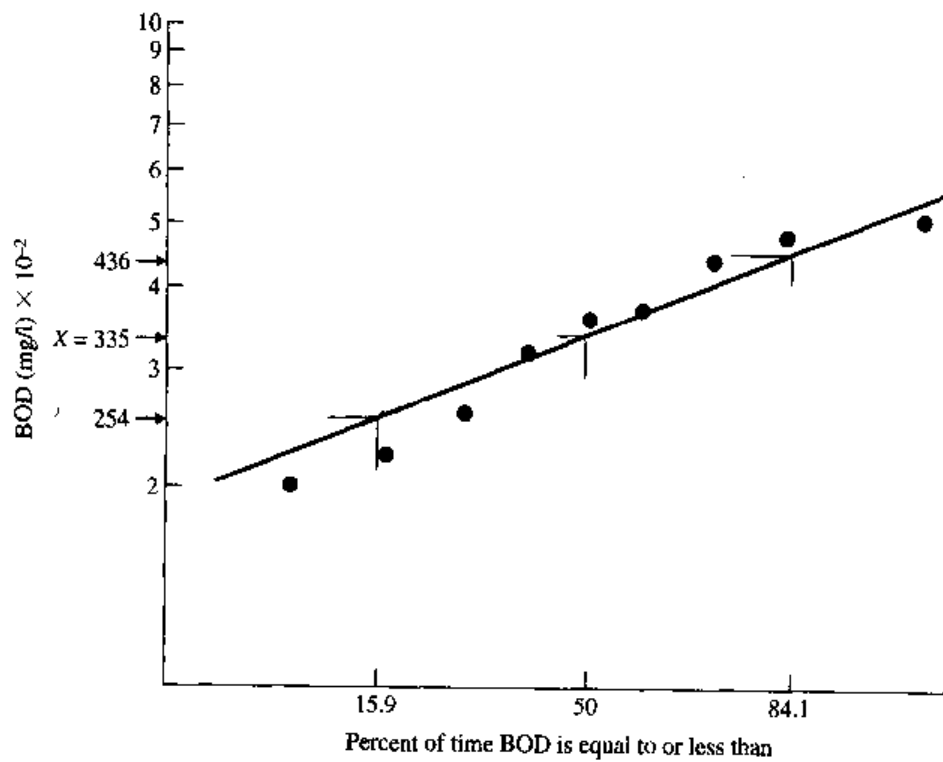


FIGURE 1.8



## 1.5 WASTE CHARACTERISTICS— ESTIMATING THE ORGANIC CONTENT

Although the interpretation of most of the waste characteristics is straightforward and definitive, special consideration must be given to the organic content. The organic content of the waste can be estimated by the BOD, COD (chemical oxygen demand), TOC (total organic carbon), or TOD (total oxygen demand). Considerable caution should be exercised in interpreting these results:

1. The BOD<sub>5</sub> test measures the biodegradable organic carbon and, under certain conditions, the oxidizable nitrogen present in the waste. Usual practice today suppresses nitrification so that only carbonaceous oxidation is recorded as CBOD<sub>5</sub>.
2. The COD test measures the total organic carbon with the exception of certain aromatics, such as benzene, which are not completely oxidized in the reaction. The COD test is an oxidation-reduction, so other reduced substances, such as sulfides, sulfites, and ferrous iron, will also be oxidized and reported as COD. NH<sub>3</sub>-N will not be oxidized in the COD test.
3. The TOC test measures all carbon as CO<sub>2</sub>, and hence the inorganic carbon (CO<sub>2</sub>, HCO<sub>3</sub><sup>-</sup>, and so on) present in the wastewater must be removed prior to the analysis or corrected for in the calculation.
4. The TOD test measures organic carbon and unoxidized nitrogen and sulfur.

Remember to exercise considerable caution in interpreting the test results and in correlating the results of one test with another. Correlations between BOD and COD or TOC should usually be made of filtered samples (soluble organics) to avoid the disproportionate relationship of volatile suspended solids in the respective tests.

The BOD by definition is the quantity of oxygen required for the stabilization of the oxidizable organic matter present over 5 days of incubation at 20°C. The BOD is conventionally formulated as a first-order reaction:

$$\frac{dL}{dt} = -kL \quad (1.1)$$

which integrates to

$$L = L_0 e^{-kt} \quad (1.2)$$

Since  $L$ , the amount of oxygen demand remaining at any time, is not known, Eq. (1.2) is re-expressed as

$$y = L_0(1 - e^{-kt})$$

where  $y$  is the amount of BOD exerted at time  $t$ :

$$y = L_0 - L$$

or

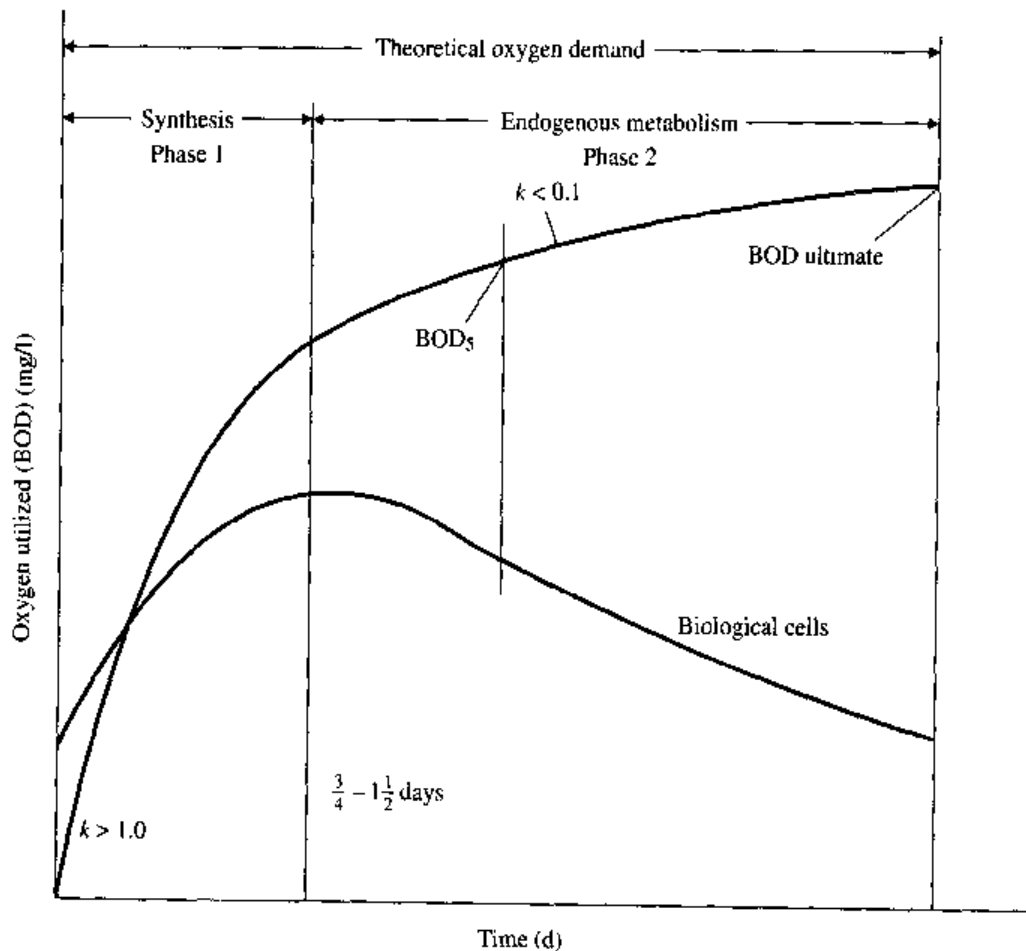
$$y = L_0(1 - 10^{-kt}) \quad (1.3)$$

By definition,  $L_0$  is the oxygen required to stabilize the total quantity of biologically oxidizable organic matter present; if  $k$  is known,  $L_5$  is a fixed percentage of

$L_o$ . In order to interpret the  $BOD_5$  obtained on industrial wastes, certain important factors must be considered.

It must be recognized that the oxygen consumed in the BOD test is the sum of (1) oxygen used for synthesis of new microbial cells using the organic matter present and (2) endogenous respiration of the microbial cells as shown in Fig. 1.9. (The basis for this is discussed in detail on p. 201). The rate of oxygen utilization during phase 1 is 10 to 20 times that during phase 2. In most readily degradable substrates, phase 1 is complete in 24 to 36 hours.

In wastes containing readily oxidizable substrates, e.g., sugars, there will be a high oxygen demand for the first day, as the substrate is rapidly utilized, followed by a slower endogenous rate over the subsequent days of incubation. When these data are fitted to a first-order curve over a 5-day period, a high  $k$  value will result because of the high initial slope of the curve. Conversely, a well-oxidized effluent will contain very little available substrate, and for the most part only endogenous respiration will occur over the 5-day incubation period. Since this rate of oxygen utilization is only a fraction of the rate obtained in the presence of available substrate, the resulting  $k$  rate will be correspondingly lower. Schroepfer<sup>1</sup> showed this by comparing the



**FIGURE 1.9**  
Reactions occurring in the BOD bottle.

$k_{10}$  rates of a well-treated sewage effluent and raw sewage containing a large quantity of available substrate. The average rate was 0.17 per day for the sewage and 0.10 per day for the effluent. It is obvious that under these conditions a direct comparison of 5-day BODs is not valid. Typical rate constants are shown in Table 1.4.

Many industrial wastes are difficult to oxidize; they require a bacterial seed acclimated to the specific waste, or a lag period may occur which yields an erroneous interpretation of the 5-day BOD values. Stack<sup>2</sup> showed that the 5-day BOD of synthetic organic chemicals varied markedly depending on the acclimation of the seed used. Some typical BOD curves are shown in Fig. 1.10. Curve *A* is normal exertion of BOD. Curve *B* is representative of what might be expected from sewage which slowly acclimated to the waste. Curves *C* and *D* are characteristic of nonacclimated seed or a toxic wastewater. Acclimation of microorganisms to organics is shown in Table 1.5 and discussed on p. 203.

In the pulp-and-paper industry, both 1-day and 5-day BODs have been run. The results are shown in Fig. 1.11. Note that in the untreated wastewater, 70 percent of

TABLE 1.4  
Average BOD rate constants at 20°C

Substance	$k_{10}$ , day <sup>-1</sup>
Untreated wastewater	0.15–0.28
High-rate filters and anaerobic contact	0.12–0.22
High-degree biotreatment effluent	0.06–0.10
Rivers with low pollution	0.04–0.08

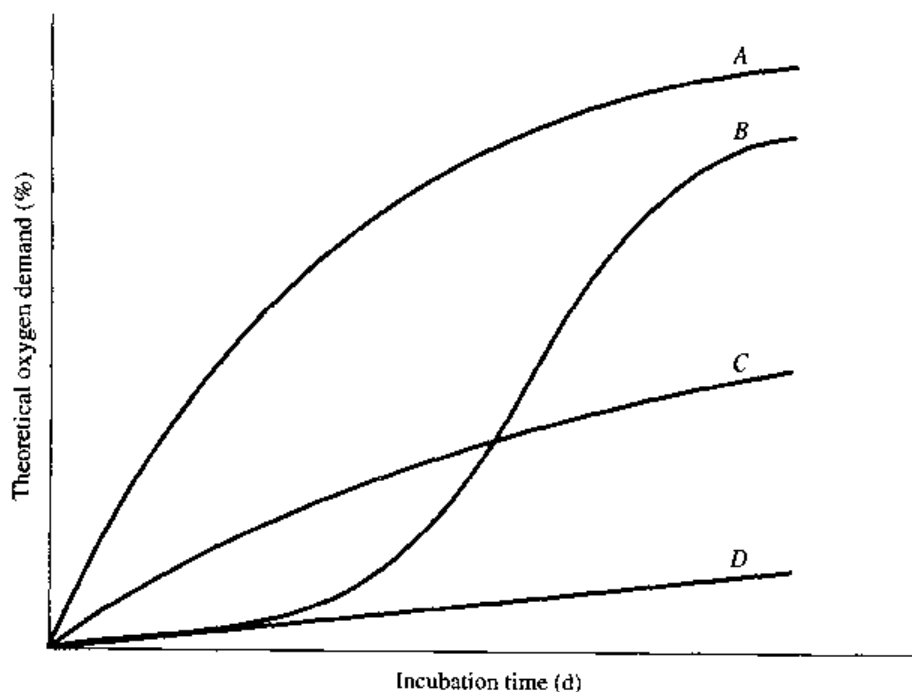
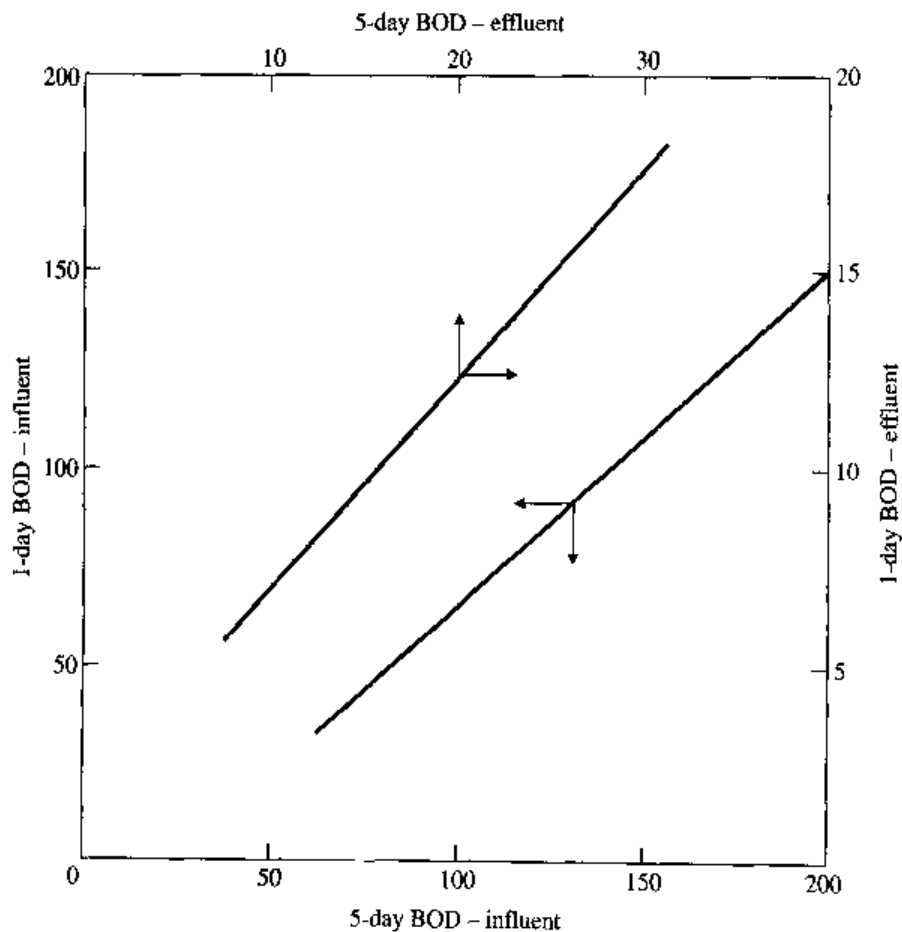


FIGURE 1.10  
Characteristic BOD curves.

the 5-day BOD is exerted in 1 day, while for the effluent, only 50 percent is exerted. Referring to the discussion on p. 15, it can be interpreted that the 1-day BOD reflects the soluble organics remaining in the sample. In many cases, the 1-day BOD may provide a good control test for treatment plant performance.

**TABLE 1.5**  
**Effect of structural characteristics on bio-acclimation**

1. Nontoxic aliphatic compounds containing carboxyl, ester, or hydroxyl groups readily acclimate (<4 days acclimation).
2. Toxic compounds with carbonyl groups or double bonds, 7–10 days acclimation; toxic to unacclimated acetate cultures.
3. Amino functional groups difficult to acclimate and slow degradation.
4. Seeds for dicarboxylic groups longer to acclimate compared to one for carboxylic group.
5. Position of functional group affects lag period for acclimation.
Primary butanol           4 days
Secondary butanol       14 days
Tertiary butanol         Not acclimated



**FIGURE 1.11**  
Relationship between 1-day and 5-day BOD for a pulp and paper-mill wastewater.

Although modifications of the BOD procedure such as the short-term test proposed by Busch<sup>3</sup> may eliminate some of the errors resulting from the first-order assumption and the variation in  $k_{10}$  due to substrate level, these procedures have not found broad application in industry. It is essential, therefore, that the following factors be considered in the interpretation of the BOD for an industrial waste:

1. That the seed is acclimated to the waste and all lag periods are eliminated.
2. That long-term BOD tests establish the magnitude of  $k_{10}$  on both the waste and treated effluent. In the case of acidic wastes, all samples should be neutralized before incubation.

Toxicity in a waste is usually evidenced by so-called sliding BOD values, i.e., an increasing calculated BOD with increasing dilution. If this situation exists, it is necessary to determine the dilution value below which the computed BODs are consistent.

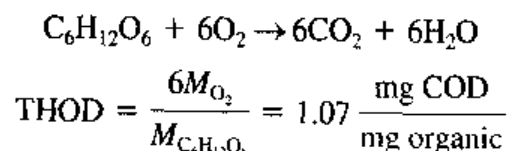
The COD test measures the total organic content of a waste which is oxidized by dichromate in acid solution. When a silver sulfate catalyst is used, the recovery for most organic compounds is greater than 92 percent. However, some aromatics such as toluene are only partially oxidized. Since the COD will report virtually all organic compounds, many of which are either partially biodegradable or non-biodegradable, it is proportional to the BOD only for readily assimilable substances, e.g., sugars. Such a case is shown in Fig. 1.12 for a readily assimilable pharmaceutical waste. Tables 1.6 and 1.8 show the BOD and COD characteristics for a variety of industrial effluents.

Because the 5-day BOD will represent a different proportion of the total oxygen demand for raw wastes than for effluents, the BOD/COD ratio will frequently vary for effluents as compared to untreated wastes. There will be no correlation between BOD and COD when organic suspended solids in the waste are only slowly biodegradable in the BOD bottle, and, therefore, filtered or soluble samples should always be used. Pulp and fiber in a paper mill waste are an example. There will also be no correlation between BOD and COD in complex waste effluents containing refractory substances such as ABS. For this reason, treated effluents may exert virtually no BOD and yet exhibit a substantial COD.

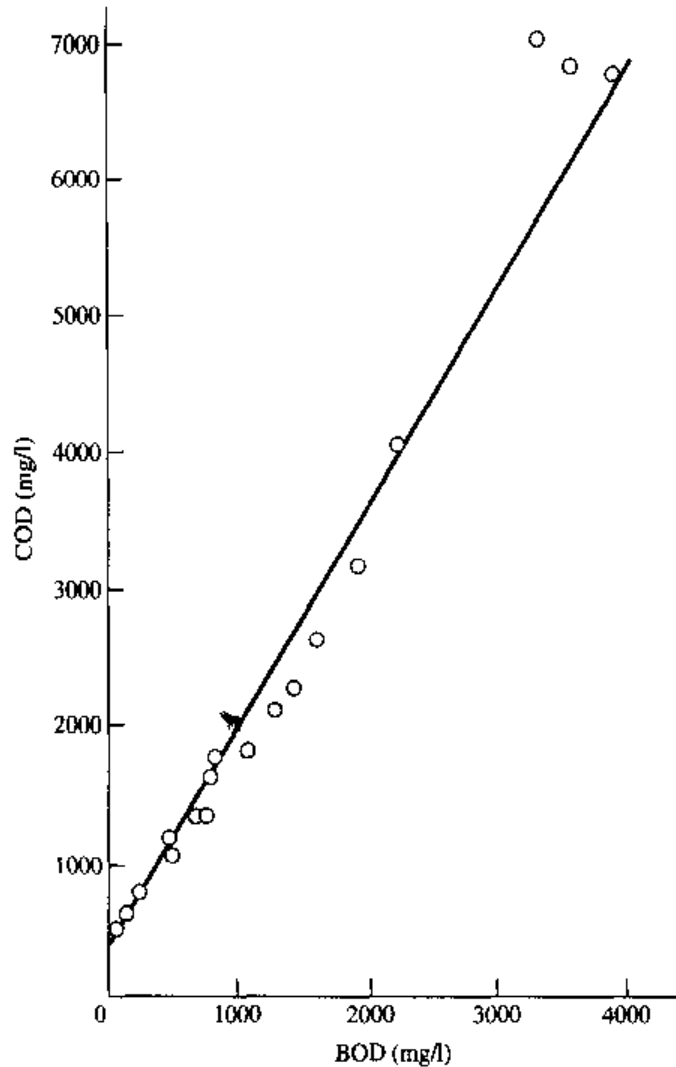
Total organic carbon (TOC) has become a common and popular method of analysis due to its simplicity of measurement. There are presently several carbon analyzers on the market.

When considering routine plant control or investigational programs, the BOD is not a useful test because of the long incubation time. It is therefore useful to develop correlations between BOD and COD or TOC.

The theoretical oxygen demand (THOD) of a wastewater containing identified organic compounds can be calculated as the oxygen required to oxidize the organics to end products; e.g., for glucose:



For most organics, with the exception of some aromatics and nitrogen-containing compounds, the COD will equal the THOD. For readily degradable wastewaters,

**FIGURE 1.12**

Relationship between BOD and COD for a pharmaceutical wastewater.

such as from a dairy, the COD will equal the  $BOD_{ult}/0.92$ . When the wastewater also contains nondegradable organics, the difference between the total COD and the  $BOD_{ult}/0.92$  will represent the nondegradable content.

It has been found that some nondegradable organics will accumulate during biooxidation by oxidation by-products of the organics in the wastewater and by-products of endogenous metabolism. These are defined as soluble microbial products (SMP). Hence the effluent COD through biological treatment will increase over the influent nondegradable COD. This is shown in Fig. 1.13.

When the compounds are identified, the TOC can be related to COD through a carbon-oxygen balance:

$$C_6H_{12}O_6 + 6O_2 \rightarrow 6CO_2 + 6H_2O$$

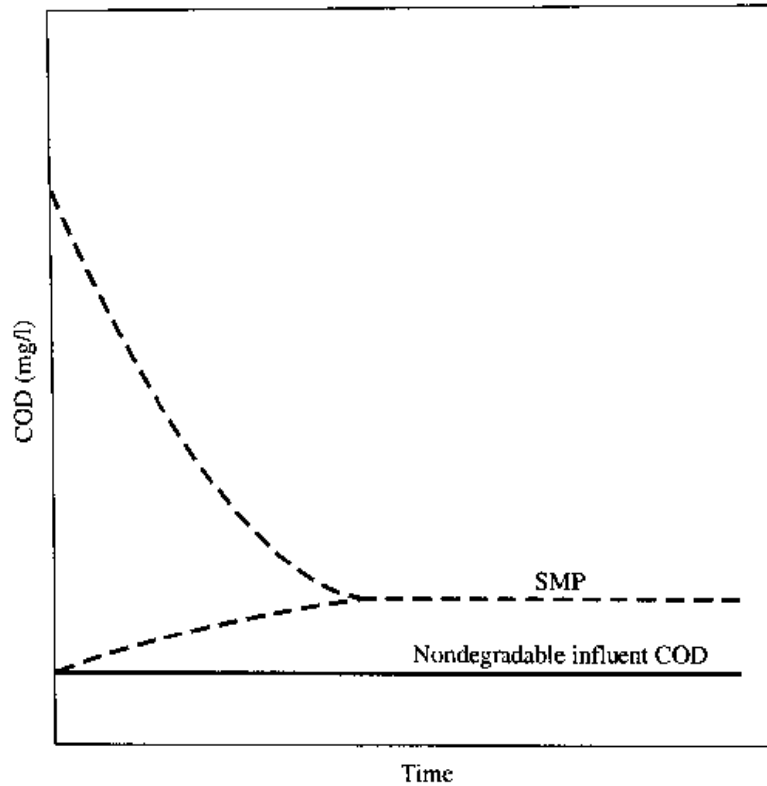
$$\frac{COD}{TOC} = \frac{6M_{O_2}}{6M_C} = 2.66 \frac{\text{mg COD}}{\text{mg organic carbon}}$$

TABLE 1.6  
Oxygen demand and organic carbon of industrial wastewaters<sup>4</sup>

Waste	BOD <sub>5</sub> , mg/l	COD, mg/l	TOC, mg/l	BOD/TOC	COD/TOC
Chemical <sup>†</sup>	—	4,260	640	—	6.65
Chemical <sup>†</sup>	—	2,410	370	—	6.60
Chemical <sup>†</sup>	—	2,690	420	—	6.40
Chemical	—	576	122	—	4.72
Chemical	24,000	41,300	9,500	2.53	4.35
Chemical—refinery	—	580	160	—	3.62
Petrochemical	—	3,340	900	—	3.32
Chemical	850	1,900	580	1.47	3.28
Chemical	700	1,400	450	1.55	3.12
Chemical	8,000	17,500	5,800	1.38	3.02
Chemical	60,700	78,000	26,000	2.34	3.00
Chemical	62,000	143,000	48,140	1.28	2.96
Chemical	—	165,000	58,000	—	2.84
Chemical	9,700	15,000	5,500	1.76	2.72
Nylon polymer	—	23,400	8,800	—	2.70
Petrochemical	—	—	—	—	2.70
Nylon polymer	—	112,600	44,000	—	2.50
Olefin processing	—	321	133	—	2.40
Butadiene processing	—	359	156	—	2.30
Chemical	—	350,000	160,000	—	2.19
Synthetic rubber	—	192	110	—	1.75

<sup>†</sup> High concentration of sulfides and thiosulfates.

Depending on the organic in question, the COD/TOC ratio may vary from zero when the organic material is resistant to dichromate oxidation to 5.33 for methane. Since the organic content changes during biological oxidation, it can be expected that the COD/TOC ratio will also change. This same rationale also applies to the BOD/TOC ratio. Values of BOD and COD for a variety of organics are shown in Table 1.7. Since only biodegradable organics are removed in the activated sludge process, the COD remaining in the effluent will consist of the nondegradable organics present in the influent wastewater [(SCOD<sub>nd</sub>)<sub>i</sub>] and residual degradable organics (as characterized by the soluble BOD) and soluble microbial products generated in the treatment process. The SMP are not biodegradable (designated as SMP<sub>nd</sub>) and, thus, exert a soluble COD (or TOC) but no BOD. Data indicate that the SMP<sub>nd</sub> is 2 to 10 percent of the influent degradable COD. The actual percentage depends on the type of wastewater and the operating solids retention time (SRT) of the biological process. COD, BOD, and SMP relationships for industrial wastewaters are presented in Table 1.8, where the SMP<sub>nd</sub> are assumed as 5 percent of the influent degradable SCOD.



**FIGURE 1.13**  
COD relationships during biooxidation.

The effluent total COD ( $\text{TCOD}_e$ ) can be calculated as the sum of the degradable plus nondegradable soluble COD ( $\text{SCOD}_d + \text{SCOD}_{nd}$ ) plus the “particulate” COD due to the effluent suspended solids ( $\text{TSS}_e$ ). If the effluent solids are primarily activated sludge floc carryover, their COD can be estimated as  $1.4 \text{ TSS}_e$ . This is expressed as follows:

$$\text{TCOD}_e = (\text{SCOD}_{nd})_e + (\text{SCOD}_d)_e + 1.4 \text{ TSS}_e \quad (1.4)$$

$$(\text{SCOD}_{nd})_e = \text{SMP}_{nd} + (\text{SCOD}_{nd})_i \quad (1.5)$$

$$(\text{SCOD}_{nd})_i = \text{SCOD}_i - (\text{SCOD}_d)_i \quad (1.6)$$

$$(\text{TCOD})_e = \text{SCOD}_i - (\text{SCOD}_d)_i + \text{SMP}_{nd} + (\text{SCOD}_d)_e + 1.4 \text{ TSS}_e \quad (1.7)$$

The degradable SCOD of the influent or effluent wastewater can be estimated from the ratio of  $\text{BOD}_5$  to ultimate BOD ( $\text{BOD}_u$ ) (designated as  $f_i$  or  $f_e$ ). Assuming that  $\text{BOD}_u = 0.92 \text{ SCOD}$ , the degradable SCOD in the influent ( $i$ ) or effluent ( $e$ ) can be estimated as:

$$(\text{SCOD}_d)_{i/e} = \frac{(\text{BOD}_5)_{i/e}}{f_{i/e} \cdot 0.92} \quad (1.8)$$



TABLE 1.7  
Evaluation of COD and BOD with respect to the theoretical  
oxygen demand of selected organic compounds<sup>3</sup>

Chemical group	THOD, mg/mg	Measured COD, mg/mg	$\frac{\text{COD}}{\text{THOD}}$ , %	Measured BOD <sub>5</sub> , mg/mg	$\frac{\text{BOD}_5}{\text{THOD}}$ , %
<b>Aliphatics</b>					
Methanol	1.50	1.05	70	1.12	75
Ethanol	2.08	2.11	100	1.58	76
Ethylene glycol	1.26	1.21	96	0.39	29
Isopropanol	2.39	2.12	89	0.16	7
Maleic acid	0.83	0.80	96	0.64	77
Acetone	2.20	2.07	94	0.81	37
Methyl ethyl ketone	2.44	2.20	90	1.81	74
Ethyl acetate	1.82	1.54	85	1.24	68
Oxalic acid	0.18	0.18	100	0.16	89
Group average			91		56
<b>Aromatics</b>					
Toluene	3.13	1.41	45	0.86	28
Benzaldehyde	2.42	1.98	80	1.62	67
Benzoic acid	1.96	1.95	100	1.45	74
Hydroquinone	1.89	1.83	100	1.00	53
O-Cresol	2.52	2.38	95	1.76	70
Group average			84		58
<b>Nitrogenous organics</b>					
Monoethanolamine	2.49	1.27	51	0.83	34
Acrylonitrile	3.17	1.39	44	nil	0
Aniline	3.18	2.34	74	1.42	44
Group average			58		26

The effluent TCOD can then be estimated by combining Eqs. (1.4) through (1.8).

$$(\text{TCOD})_e = \text{SCOD}_i - \left[ \frac{(\text{BOD}_5)_i}{f_i \cdot 0.92} \right] + \text{SMP}_{nd} + \left[ \frac{(\text{BOD}_5)_e}{f_e \cdot 0.92} \right] + 1.4 \text{TSS}_e \quad (1.9)$$

The calculations relative to BOD, COD, and TOC are illustrated in Example 1.2.

The BOD, COD, and TOC tests are gross measures of organic content and as such do not reflect the response of the wastewater to various types of biological treatment technologies. It is therefore desirable to partition the wastewater into several categories, as shown in Fig. 1.14. The distinction between sorbable and non-sorbable BOD is important in selecting the appropriate process configuration for the control of sludge quality, as discussed on p. 254.

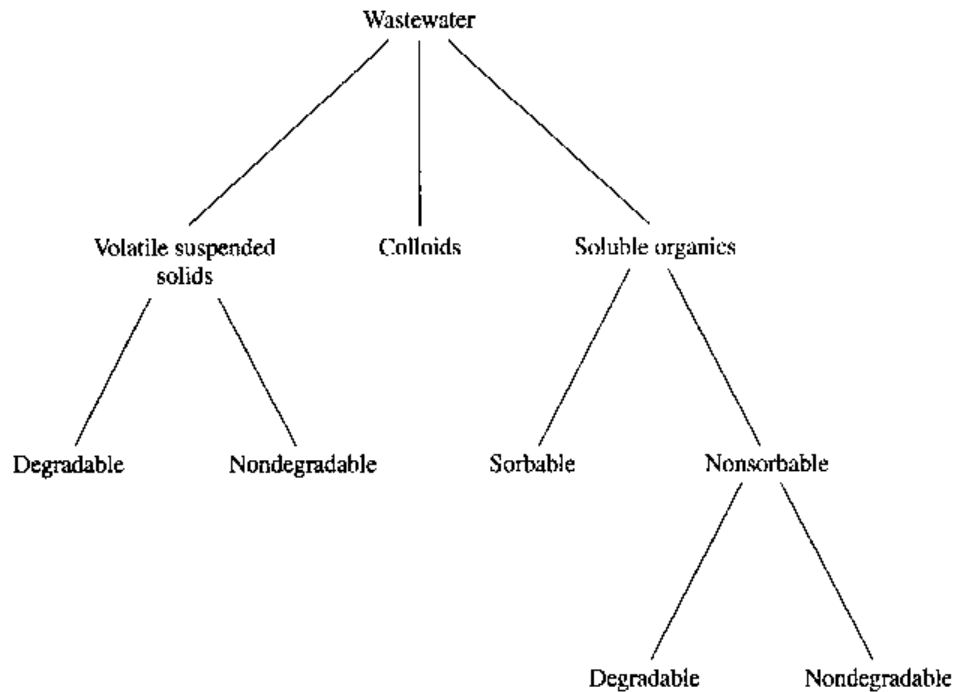
TABLE 1.8  
COD, BOD, and SMP relationships for industrial wastewaters

Wastewater	Influent		Effluent		SMP <sub>ind</sub> <sup>†</sup> mg/L	(COD <sub>ind</sub> ) <sub>e</sub> <sup>‡</sup> mg/L	BOD <sub>5</sub> /COD <sub>deg</sub> <sup>§</sup>
	BOD, mg/L	COD, mg/L	BOD, mg/L	COD, mg/L			
Pharmaceutical	3,290	5,780	23	561	261	526	0.60
Diversified chemical	725	1,487	6	257	62	248	0.56
Cellulose	1,250	3,455	58	1,015	122	926	0.47
Tannery	1,160	4,360	54	561	190	478	0.28
Alkylamine	893	1,289	12	47	62	29	0.69
Alkyl benzene sulfonate	1,070	4,560	68	510	202	405	0.25
Viscose rayon	478	904	36	215	35	160	0.61
Polyester fibers	208	559	4	71	24	65	0.40
Protein process	3,178	5,355	5	245	256	237	0.59
Tobacco	2,420	4,270	139	546	186	332	0.59
Propylene oxide	532	1,124	49	289	42	214	0.56
Paper mill	380	686	7	75	31	64	0.58
Vegetable oil	3,474	6,302	76	332	298	215	0.55
Vegetable tannery	2,396	11,663	92	1,578	504	1,436	0.22
Hardboard	3,725	5,827	58	643	259	554	0.67
Saline organic chemical	3,171	8,597	82	3,311	264	3,185	0.56
Coke	1,618	2,291	52	434	93	354	0.79
Coal liquid	2,070	3,160	12	378	139	360	0.70
Textile dye	393	951	20	261	35	230	0.53
Kraft paper mill	308	1,153	7	575	29	564	0.50

<sup>†</sup> 0.05 (COD<sub>deg</sub>);

<sup>‡</sup> (COD<sub>ind</sub>)<sub>e</sub> = SCOD<sub>e</sub> - [(BOD<sub>5</sub>)<sub>e</sub>/0.65]

<sup>§</sup> (COD<sub>2h</sub>) = COD<sub>e</sub> - (COD<sub>ind</sub>)<sub>e</sub> + SMP<sub>ind</sub>



**FIGURE 1.14**  
Partition of organic constituents of a wastewater.

**EXAMPLE 1.2.** A wastewater contains the following:

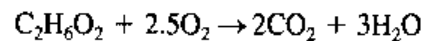
- 150 mg/l ethylene glycol
- 100 mg/l phenol
- 40 mg/l sulfide ( $S^{2-}$ )
- 125 mg/l ethylene diamine hydrate (ethylene diamine is essentially nonbiodegradable)

- (a) Compute the COD and TOC.
- (b) Compute the  $BOD_5$  if the  $k_{10}$  is 0.2/day.
- (c) After treatment, the  $BOD_5$  is 25 mg/l. Estimate the COD ( $k_{10} = 0.1/day$ ).

**Solution.**

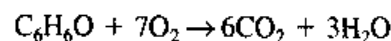
- (a) The COD is computed:

Ethylene glycol



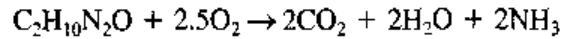
$$COD = \frac{2.5(32)}{62} \times 150 \text{ mg/l} = 194 \text{ mg/l}$$

Phenol



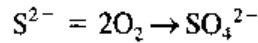
$$COD = \frac{7(32)}{94} \times 100 \text{ mg/l} = 238 \text{ mg/l}$$

Ethylene diamine hydrate



$$\text{COD} = \frac{2.5(32)}{78} \times 125 \text{ mg/l} = 128 \text{ mg/l}$$

Sulfide



$$\text{COD} = \frac{2(32)}{32} \times 40 \text{ mg/l} = 80 \text{ mg/l}$$

The total COD is 640 mg/l.

The TOC is computed:

Ethylene glycol

$$\frac{24}{62} \times 150 \text{ mg/l} = 58 \text{ mg/l}$$

Phenol

$$\frac{72}{94} \times 100 \text{ mg/l} = 77 \text{ mg/l}$$

Ethylene diamine

$$\frac{24}{78} \times 125 \text{ mg/l} = 39 \text{ mg/l}$$

The total TOC is 174 mg/l.

(b) The ultimate BOD can be estimated:

$$(194 \text{ mg/l} + 238 \text{ mg/l} + 80 \text{ mg/l}) \times 0.92 = 471 \text{ mg/l}$$

Thus

$$\frac{\text{BOD}_5}{\text{BOD}_{\text{ult}}} = (1 - 10^{-(5 \times 0.2)}) = 0.9$$

$\text{BOD}_5$  is  $471 \text{ mg/l} \times 0.9 = 424 \text{ mg/l}$ .

(c) The  $\text{BOD}_{\text{ult}}$  of the effluent is

$$\frac{25 \text{ mg/l}}{1 - 10^{-(5 \times 0.1)}} = \frac{25 \text{ mg/l}}{0.7} = 36 \text{ mg/l}$$

The COD is  $36/0.92 = 39 \text{ mg/l}$ . Therefore the COD will be  $128 \text{ mg/l} + 39 \text{ mg/l} +$  residual by-products.

## 1.6 MEASURING EFFLUENT TOXICITY

The standard technique for determining the toxicity of a wastewater is the bioassay, which estimates a substance's effect on a living organism. The two most common types of bioassay tests are the chronic and the acute. The chronic bioassay

estimates longer-term effects that influence the ability of an organism to reproduce, grow, or behave normally; the acute bioassay estimates short-term effects, including mortality.

The acute bioassay exposes a selected test organism, such as the fathead minnow or *Mysidopsis bahia* (mysid shrimp), to a known concentration of sample for a specified time (typically 48 or 96 h, but occasionally as short as 24 h). The acute toxicity of the sample is generally expressed as the concentration lethal to 50 percent of the organisms, denoted by the term  $LC_{50}$ . The chronic bioassay exposes a selected test organism to a known concentration of sample for longer periods of time than the acute bioassay, usually 7 days with daily renewal. The toxicity of the sample is currently expressed as the  $IC_{25}$  value, which represents the sample concentration that produces 25 percent inhibition to a chronic characteristic of the test species (e.g., growth weight or reproduction). NOEC is the concentration at which there was no observed effect.

The  $LC_{50}$  and  $IC_{25}$  values are determined through statistical analysis of mortality-time data or weight- or reproduction-time data, respectively. The lower the  $LC_{50}$  or  $IC_{25}$  values, the more toxic the wastewater. The bioassay data can be expressed as a concentration of a specific compound (e.g., mg/l), or in the case of whole-effluent (i.e., overall effluent) toxicity, as a dilution percentage or as toxic units. Toxic units can be calculated as 100 times the inverse of the dilution percentage expression of whole-effluent toxicity; a whole-effluent toxicity of 25% is equal to  $100/25$  or 4 toxic units. This results in a more logical measure where increasing values indicate increasing toxicity. The toxic unit expression of the data is applicable to acute or chronic tests using any organism. It is simply a mathematical expression.

Various organisms are used to measure toxicity. The organism and life stage (e.g., adult or juvenile) selected depends on the receiving stream salinity, the stability and nature of the expected contaminants, and the relative sensitivity of different species to the effluent. Different organisms exhibit different toxicity thresholds to the same compound (Table 1.9), and there is a relatively large variability in

TABLE 1.9  
Acute toxicity of selected compounds (96-h  $LC_{50}$ )

	Units	Fathead minnow	<i>Daphnia magna</i>	Rainbow trout
<b>Organics</b>				
Benzene	mg/l	42	35	38
1,4-Dichlorobenzene	mg/l	3.72	3.46	2.89
2,4-Dinitrophenol	mg/l	5.81	5.35	4.56
Methylene chloride	mg/l	326	249	325
Phenol	mg/l	39	33	35
2,4,6-Trichlorophenol	mg/l	5.91	5.45	4.62
<b>Metals</b>				
Cadmium	$\mu$ g/l	38	0.29	0.04
Copper	$\mu$ g/l	3.29	0.43	1.02
Nickel	$\mu$ g/l	440	54	—

toxicity for a single compound and any one test species as a result of biological factors. This is shown in Fig. 1.15 for a petroleum refinery effluent. It should also be noted that variability in a plant effluent will result in highly variable effluent toxicity as shown in Fig. 1.16. In addition, results for multiple tests vary because of factors such as the species of organism, test conditions, and the number of replicates (i.e., duplicates) and organisms used, as well as the laboratory conducting the test (with greater variability observed when more than one lab is involved).

The precision of toxicity test results decreases significantly as the actual toxicity decreases. For example, in one series of bioassays conducted with *Mysidopsis bahia*, for an  $LC_{50}$  of 10 percent (10 toxic units), the 95 percent confidence level was about 7 to 15 percent, whereas for an  $LC_{50}$  of 50 percent (2 toxic units), it was 33 to 73 percent. This variation is a result of the statistical nature of the test. At high  $LC_{50}$  values, there is a low mortality rate, which, if the test is done with only a few organisms, can result in a wide range of actual  $LC_{50}$  concentrations. If, conversely, there is a high mortality, the results are more precise, since a greater percentage of the organisms was affected by the sample, thus giving a more statistically precise estimate of actual toxicity. It must be kept in mind that any such test gives only estimates of the actual toxicity and should be accorded the precision of an estimate.

Because of the wide variability in bioassay test results, numerous confirmatory data points are needed to be confident that the true extent of the toxicity problem has been estimated. No single data point should be relied upon for any conclusion. This may require long-term operation of bench, pilot-scale, or full-scale systems to determine the effectiveness of treatment.

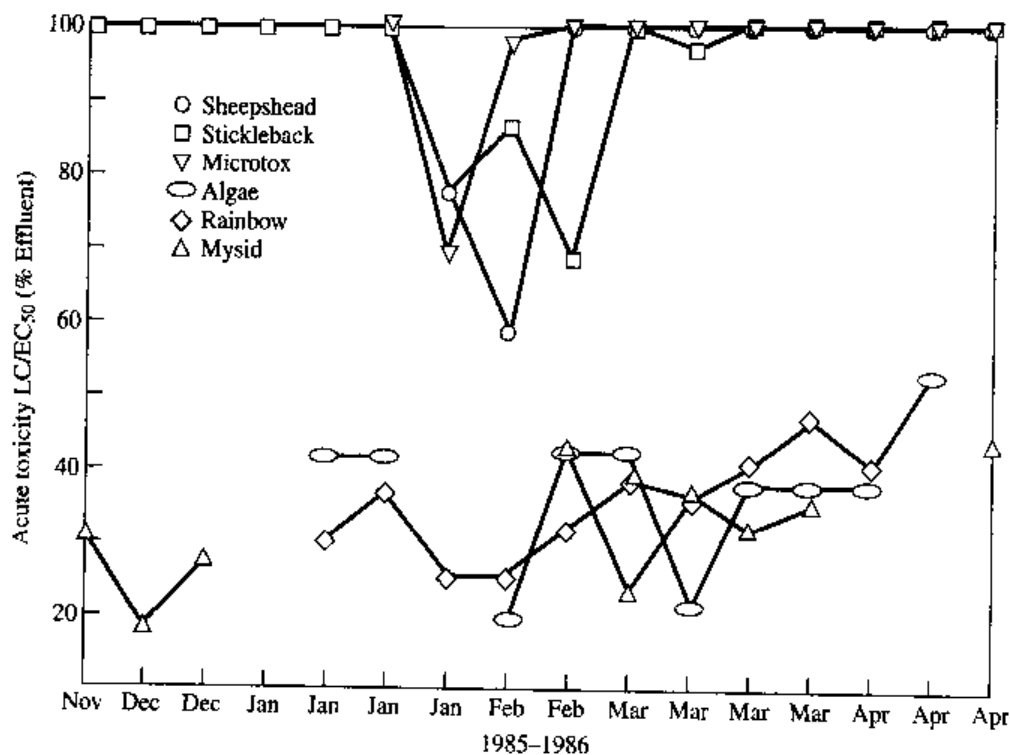
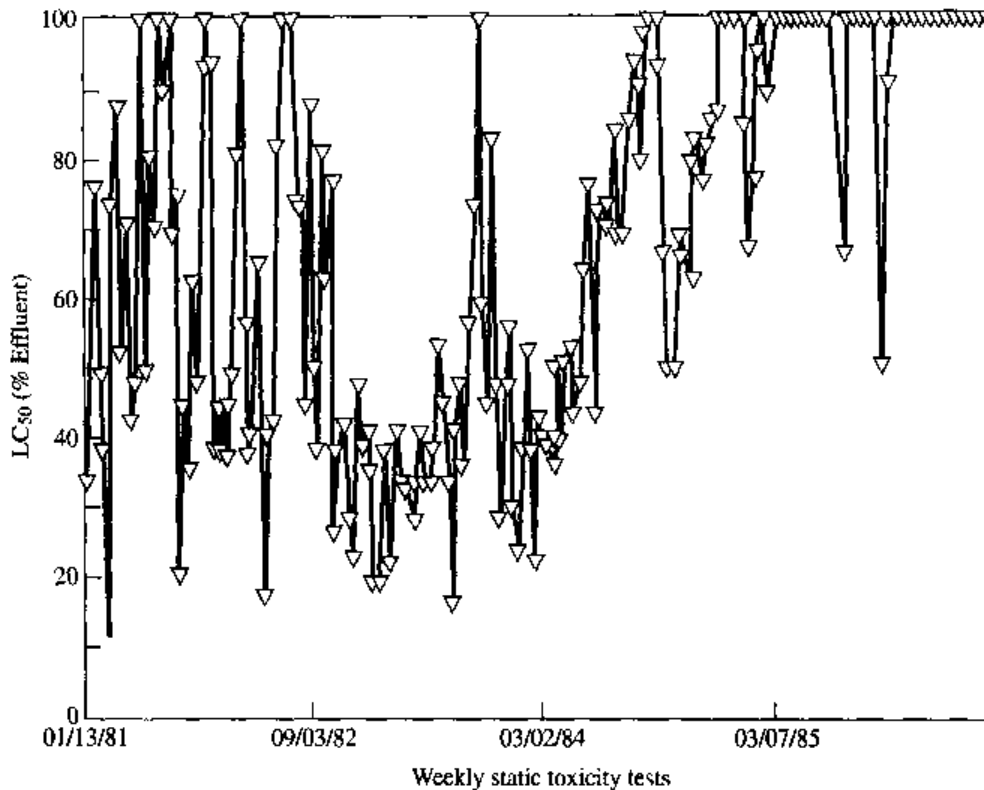


FIGURE 1.15

Acute toxicity of six species to refinery effluent.<sup>5</sup>



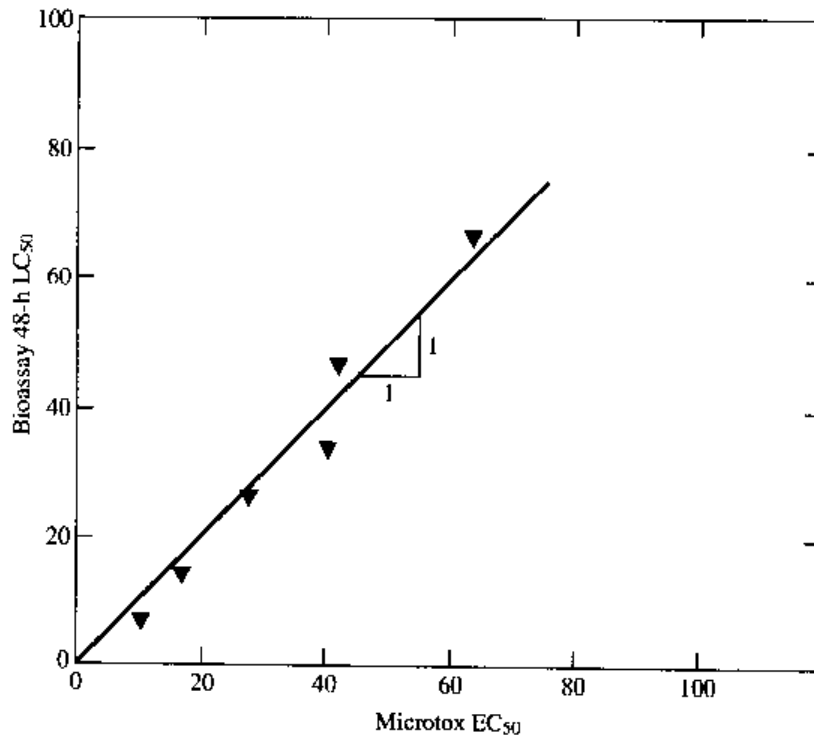
**FIGURE 1.16**

Acute toxicity of refinery effluent to stickleback.<sup>5</sup>

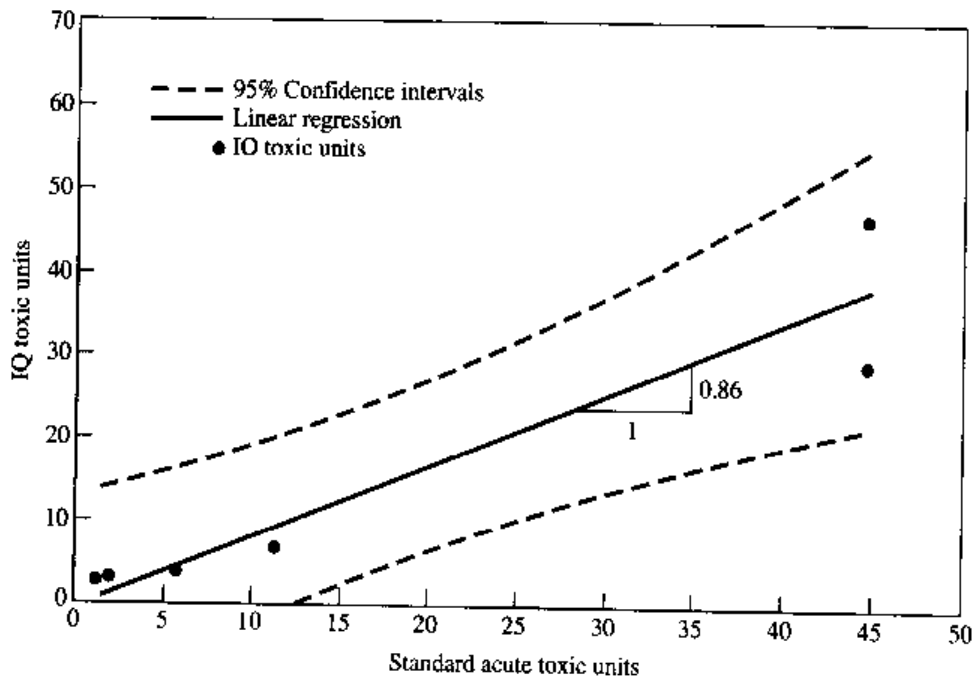
A thorough toxicity reduction program will involve a large number of tests on treated and untreated samples. For the initial screening stages, one should consider employing either a shortened, simplified bioassay technique (or surrogate test) such as a 24-h or 48-h version of the required test, or a rapid aquatic toxicity test such as Microtox<sup>®</sup>, IQ<sup>™</sup>, or Ceriofast<sup>™</sup> to determine whether there is a correlation between the surrogate test and the required test. If a reasonably strong correlation exists, the surrogate test allows much quicker data turnaround, usually at a much lower cost.

Microtox (Microbics Corporation, Carlsbad, California) uses a freeze-dried marine luminescent microorganism *Vibrio fischeri* incubated at constant temperature in a high-salt, low-nutrient growth medium. Light outputs are measured to determine the effect of the wastewater on the luminescence of the organisms. Microtox has been found to correlate reasonably well in many domestic wastewater cases and in some relatively simple industrial cases. Figure 1.17 shows a correlation for a carbon-treated chemical plant effluent.

IQ (Aqua Survey, Flemington, New Jersey) uses less than 24-h-old Cladoceran species (*Daphnia magna*, *Daphnia pulex*) hatched from the eggs provided with the test kit. The test organisms are exposed to serial dilutions of the samples for 1 h. Then, the organisms are fed a fluorometrically tagged sugar substrate for 15 min. The intensity of the fluorescence of the control organisms is compared with the fluorescence of the test organisms to determine the effect of the wastewater on the capacity of the organisms to digest the substrate. Figure 1.18 shows a correlation for a pharmaceutical plant effluent.



**FIGURE 1.17**  
Bioassay/Microtox comparison—carbon-treated effluent.



**FIGURE 1.18**  
IQ toxic units versus standard acute toxic units for a pharmaceutical effluent.



Ceriofast (Department of Environmental Engineering Sciences, University of Florida, Gainesville, Florida) uses an in-house culture of *Ceriodaphnia dubia*. The 24- to 48-h test organisms are exposed to dilutions of the samples for 40 min. Then, the test organisms and the controls are fed for 20 min with a yeast substrate that contains a nontoxic fluorescent stain. The presence of fluorescence in the intestinal tract of the control organisms is compared with the presence or absence of fluorescence in the test organisms to determine the effect of the wastewater on the feeding ability of the organisms.

### **Toxicity Identification of Effluent Fractionation**

Toxicity identification of effluent fractionation investigations determine, generically or specifically, the cause of effluent toxicity. Either the actual effluent is fractionated by chemical and/or physical means, or a sample that simulates the known toxic effect is synthesized. The goal is to measure the toxicity of each suspected key component in the absence of other toxic components, but with identical or equivalent nontoxic background components.

The procedure generally involves sample manipulation to eliminate toxicity associated with specific chemical groups. Results of toxicity tests on the treated samples are compared with tests on the unmanipulated effluent. Any difference found indicates that the constituent, or class of constituents, removed is likely to be responsible for the toxicity.

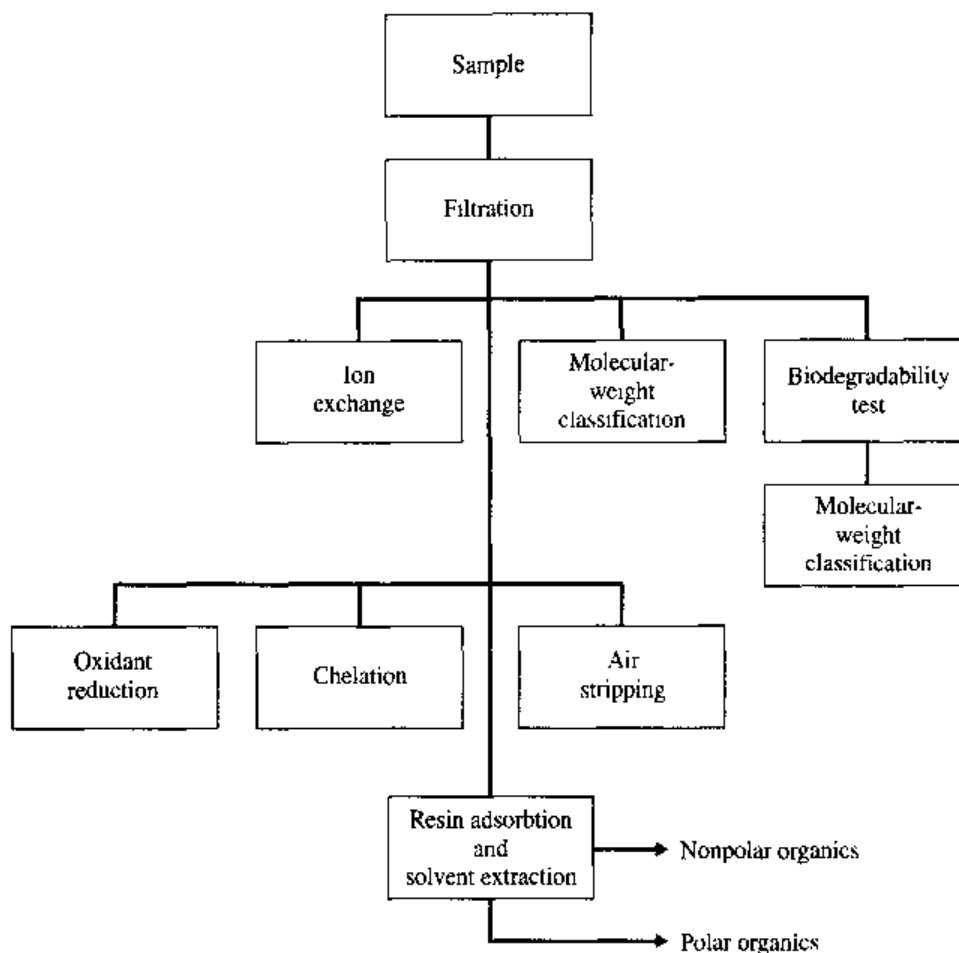
The specific components to be isolated, and the means for doing this, are quite varied and may require extensive investigation. Some techniques are now fairly standard and reliable, others may need to be further developed specifically for the subject wastewater. However, this evaluation can result in significant savings of time and money if properly executed.

Before beginning the fractionation, a thorough plan needs to be developed, one that must address the specific conditions encountered at the facility. Not all separation options (summarized in Fig. 1.19) are employed in every fractionation, and treatments vary from case to case.

The first step is to study the process flowsheet, as well as any long-term data on the chemical makeup of the discharge and plant production. This analysis may provide clues to the source of the toxicity. (However, these are just clues, since only the response of the organism in the actual sample is evidence of a toxic effect. In some cases, a compound whose concentration is above the reported toxic level is not harmful in the actual wastewater stream because it is unavailable to the organisms. For example, many heavy metals are toxic at very low levels in soft water but not in hard water.)

If nothing conclusive results from the process analysis (which will often be the case), a literature search should be performed to obtain information on toxicity of similar wastewaters and toxicity of the toxic compounds known to be present. These data will aid in later investigations.

The next step is to actually fractionate the discharge sample. In all cases, blanks (i.e., control samples) should be analyzed to make certain that toxicity is not

**FIGURE 1.19**

Various techniques can be employed to fractionate a wastewater sample.

being introduced by the fractionation or testing procedure. The following manipulations may be considered:

- **Filtration.** Filtration is generally performed first to determine whether the toxicity is related to the soluble or insoluble phase of the sample. Typically, 1- $\mu\text{m}$  glass fiber filters that have been prewashed with ultrapure water are used. The insoluble phase should be resuspended in control water to be sure that filtration, not adsorption on the filter medium, removed the toxicity. A 0.45- $\mu\text{m}$  filter should be used in order to determine if the colloidal fraction is responsible for the toxicity.
- **Ion exchange.** Inorganic toxicity can be studied by using cationic and anionic exchange resins to remove potentially toxic inorganic compounds or ions.
- **Molecular weight classification.** Evaluating the molecular weight distribution of the influent, and the toxicity of each molecular-weight range, can often narrow the list of suspected contaminants.
- **Biodegradability test.** Controlled biological treatment of effluent samples in the lab can result in almost complete oxidation of the biodegradable portion of

organics. Bioassay analysis can then quantify the toxicity associated with the nonbiodegradable components, as well as the reduction in toxicity attainable by biological treatment.

- *Oxidant reduction.* Residual chemical oxidants carried over from a process (e.g., chlorine and chloramines used for disinfection, or ozone and hydrogen peroxide used in sludge conditioning) can be toxic to most organisms. A simple batch reduction of these oxidants at various concentrations, using an agent such as sodium thiosulfate, will indicate the toxicity of any remaining oxidants.
- *Metal chelation.* The toxicity of the sum of all cationic metals (with the exception of mercury) can be determined by chelation of samples, using varying concentrations of ethylenediaminetetraacetic acid (EDTA) and evaluating the change in toxicity.
- *Air stripping.* Batch air stripping at acid, neutral, and basic pH can remove essentially all volatile organics. At a basic pH, ammonia is removed as well. Thus, if both volatile organics and ammonia are suspected toxicants, an alternative ammonia removal technique, such as a zeolite exchange, should be used. (Note that ammonia is toxic in the nonionized form, so ammonia toxicity is very pH dependent.)
- *Resin adsorption and solvent extraction.* Specific nonpolar organics can sometimes be identified as toxics, using a resin-adsorption/solvent-extraction process. A sample is adsorbed on a long-chain organic resin, the organics are reextracted from the resin with a solvent (e.g., methanol), and the sample's toxicity is determined via a bioassay.

### Source Analysis and Sorting

In a typical wastewater collection system, multiple streams from various sources throughout the plant combine into fewer and fewer streams, ultimately forming a single discharge stream or treatment plant influent. To identify exactly where in the process the toxicity originates, one performs source analysis and sorting. This procedure starts with the influent to the treatment plant and proceeds upstream to the various points of wastestream combination, until the sources of key toxicants have been identified.

Treatment characteristics for each source are evaluated to determine whether the stream can be detoxified by the existing end-of-pipe technology at the facility, usually a biological treatment system. During this evaluation, the relative contribution of each source to effluent toxicity can be defined. (Methods for reducing or eliminating contributions through source treatment at the individual processing unit will be addressed in a later phase of the program.)

Gathering and interpreting this information for a large number of sources requires a well-planned and organized program; a procedure such as the one outlined in Fig. 1.19 can be used. Sources are first classified (before treatment) according to the following criteria:

- Bioassay toxicity, in terms of mg/L of the key chemical component
- Flow, as a percentage of the total effluent

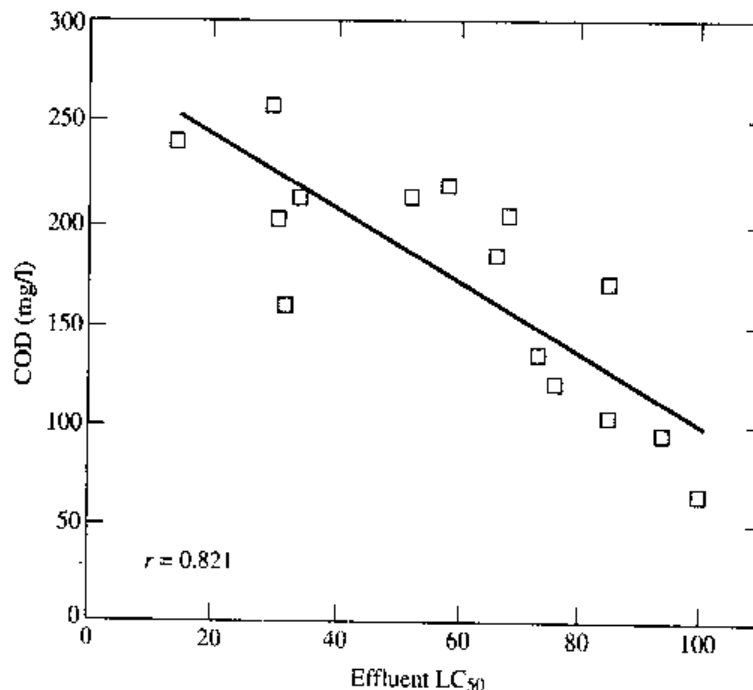
- Concentration of the key chemical component [e.g., organic material expressed as total organic carbon (TOC)]
- Biodegradability

Relatively nonbiodegradable wastestreams are the most likely to induce toxic effects in the discharge and should be evaluated carefully. Some may require physical or chemical treatment because they are relatively nonbiodegradable. Others may have relatively high biodegradation rates but result in high residual levels after biodegradation. These will require additional testing to assess whether they remain significantly toxic following biological treatment.

Wastestreams found to be highly biodegradable have low probabilities for inducing toxic effects. However, their actual impact on effluent toxicity must be confirmed. This can be done by feeding a composite wastestream, of all (or most of) the streams to a continuous-flow biological reactor, and then determining the reactor effluent's toxicity.

It is also necessary to determine whether interactions are occurring between streams. To do so, the individual wastestream toxicities are compared with the toxicity of a biological-reactor effluent after treating a blend of the streams. If the toxicity (expressed in toxic units) of a blend of several samples is exactly additive, then no synergistic or antagonist effects are taking place. If the measured value for the composite stream is lower than the calculated value (i.e., the composite sample is nontoxic), the streams are synergistic; if higher, they are antagonistic.

In many cases the cause of effluent toxicity cannot be isolated, and a correlation must be made on total effluent COD as shown in Fig. 1.20 for a petroleum refinery effluent.



**FIGURE 1.20**

Toxicity/COD correlation for wastewater treatment plant effluent.

## 1.7 IN-PLANT WASTE CONTROL AND WATER REUSE

### Waste Minimization

Before end-of-pipe wastewater treatment or modifications to existing wastewater treatment facilities to meet new effluent criteria are considered, a program of waste minimization should be initiated.

Reduction and recycling of waste are inevitably site- and plant-specific, but a number of generic approaches and techniques have been used successfully across the country to reduce many kinds of industrial wastes.

Generally, waste minimization techniques can be grouped into four major categories: inventory management and improved operations, modification of equipment, production process changes, and recycling and reuse. Such techniques can have applications across a range of industries and manufacturing processes, and can apply to hazardous as well as nonhazardous wastes.

Many of these techniques involve source reduction—the preferred option on EPA's hierarchy of waste management. Others deal with on- and off-site recycling. The best way to determine how these general approaches can fit a particular company's needs is to conduct a waste minimization assessment, as discussed below. In practice, waste minimization opportunities are limited only by the ingenuity of the generator. In the end, a company looking carefully at bottom-line returns may conclude that the most feasible strategy would be a combination of source reduction and recycling projects.

Waste minimization approaches as developed by the U.S. EPA are shown in Table 1.10. In order to implement the program, an audit needs to be made as described in Table 1.11. Case studies from three industries following rigorous source management and control are listed in Table 1.12. Pollution reduction can be directly achieved in several ways.

1. *Recirculation.* In the paperboard industry, white water from a paper machine can be put through a save-all to remove the pulp and fiber and recycled to various points in the paper making process.
2. *Segregation.* In a soap and detergent case, clean streams were separated for direct discharge. Concentrated or toxic streams may be separated for separate treatment.
3. *Disposal.* In many cases concentrated wastes can be removed in a semidry state. In the production of ketchup, after cooking and preparation of the product, residue in the kettle bottoms is usually flushed to the sewer. The total discharge BOD and suspended solids can be markedly reduced by removal of this residue in a semidry state for disposal. In breweries the secondary storage units have a sludge in the bottom of the vats which contain both BOD and suspended solids. Removal of this as a sludge rather than flushing to the sewer will reduce the organic and solids load to treatment.
4. *Reduction.* It is common practice in many industries, such as breweries and dairies, to have hoses continuously running for cleanup purposes. The use of automatic cutoffs can substantially reduce the wastewater volume. The use of drip pans to catch products, as in a dairy or ice cream manufacturing plant,

TABLE 1.10  
Waste minimization approaches and techniques

---

**Inventory management and improved operations**

- Inventory and trace all raw materials
- Purchase fewer toxic and more nontoxic production materials
- Implement employee training and management feedback
- Improve material receiving, storage, and handling practices

**Modification of equipment**

- Install equipment that produces minimal or no waste
- Modify equipment to enhance recovery or recycling options
- Redesign equipment or production lines to produce less waste
- Improve operating efficiency of equipment
- Maintain strict preventive maintenance program

**Production process changes**

- Substitute nonhazardous for hazardous raw materials
- Segregate wastes by type for recovery
- Eliminate sources of leaks and spills
- Separate hazardous from nonhazardous wastes
- Redesign or reformulate end products to be less hazardous
- Optimize reactions and raw material use

**Recycling and reuse**

- Install closed-loop systems
  - Recycle on site for reuse
  - Recycle off site for reuse
  - Exchange wastes
- 

instead of flushing this material to the sewer considerably reduces the organic load. A similar case exists in the plating industry where a drip pan placed between the plating bath and the rinse tanks will reduce the metal dragout.

5. *Substitution.* The substitution of chemical additives of a lower pollutional effect in processing operations, e.g., substitution of surfactants for soaps in the textile industry.

A summary of cost-effective pollution control is shown in Table 1.13.

Although it is theoretically possible to completely close up many industrial process systems through water reuse, an upper limit on reuse is imposed by product quality control. For example, a closed system in a paper mill will result in a continuous buildup of dissolved organic solids. This can increase the costs of slime control, cause more downtime on the paper machines, and under some conditions cause discoloration of the paper stock. Obviously, the maximum degree of reuse is reached before these problems occur.

TABLE 1.11  
Source management and control

---

**Phase I—Preassessment**

- Audit focus and preparation
- Identify unit operations and processes
- Prepare process flow diagrams

**Phase II—Mass balance**

- Determine raw material inputs
- Record water usage
- Assess present practice and procedures
- Quantify process outputs
- Account for emissions:
  - To atmosphere
  - To wastewater
  - To off-site disposal
- Assemble input and output information
- Derive a preliminary mass balance
- Evaluate and refine the mass balance

**Phase III—Synthesis**

- Identify options
    - Identify opportunities
    - Target problem areas
    - Confirm options
  - Evaluate options
    - Technical
    - Environmental
    - Economic
  - Prepare action plan
    - Waste reduction plan
    - Production efficiency plan
    - Training
- 

Water requirements are also significant when reuse is considered. Water makeup for hydropulpers in a paper mill need not be treated for removal of suspended solids; on the other hand, solids must be removed from shower water on the paper machines to avoid clogging of the shower nozzles. Wash water for produce such as tomatoes does not have to be pure but usually requires chlorination to ensure freedom from microbial contamination.

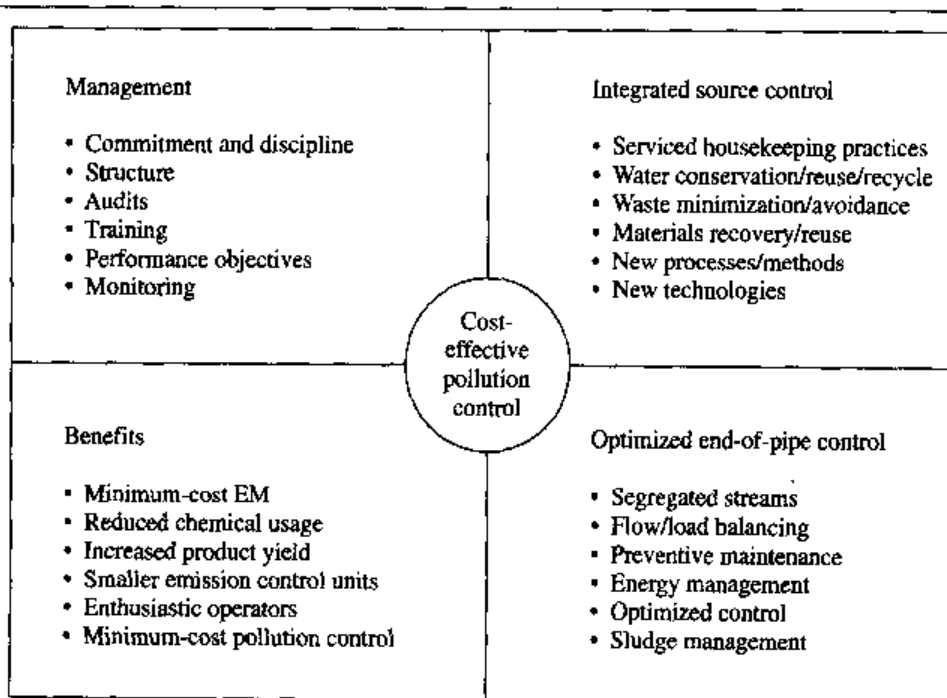
By-product recovery frequently accompanies water reuse. The installation of save-alls in paper mills to recover fiber permits the reuse of treated water on cylinder showers. The treatment of plating-plant rinsewater by ion exchange yields a

TABLE 1.12  
Source management and control

Case studies	Before	After
1. Chemical industry		
• Volume (m <sup>3</sup> /d)	5000	2700
• COD (t/d)	21	13
2. Hide and skin industry		
• Volume (m <sup>3</sup> /d)	2600	1800
• BOD (t/d)	3–6	2–6
• TDS (t/d)	20	10
• SS (t/d)	4–83	3–7
3. Metal preparation and finishing		
• Volume (m <sup>3</sup> /d)	450	270
• Chromium (kg/d)	50	5
• TTM (kg/d)	180	85

t = tonne = 1000 kg.

TABLE 1.13  
Summary of cost-effective pollution control

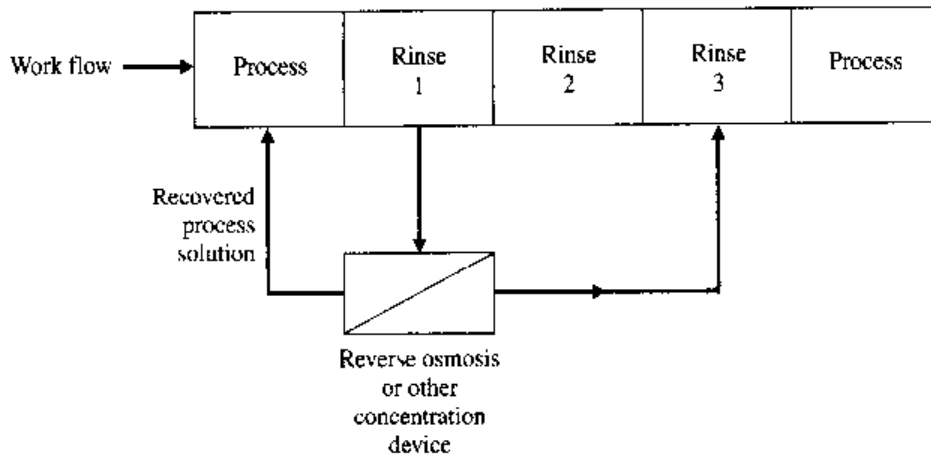


EM: environmental management

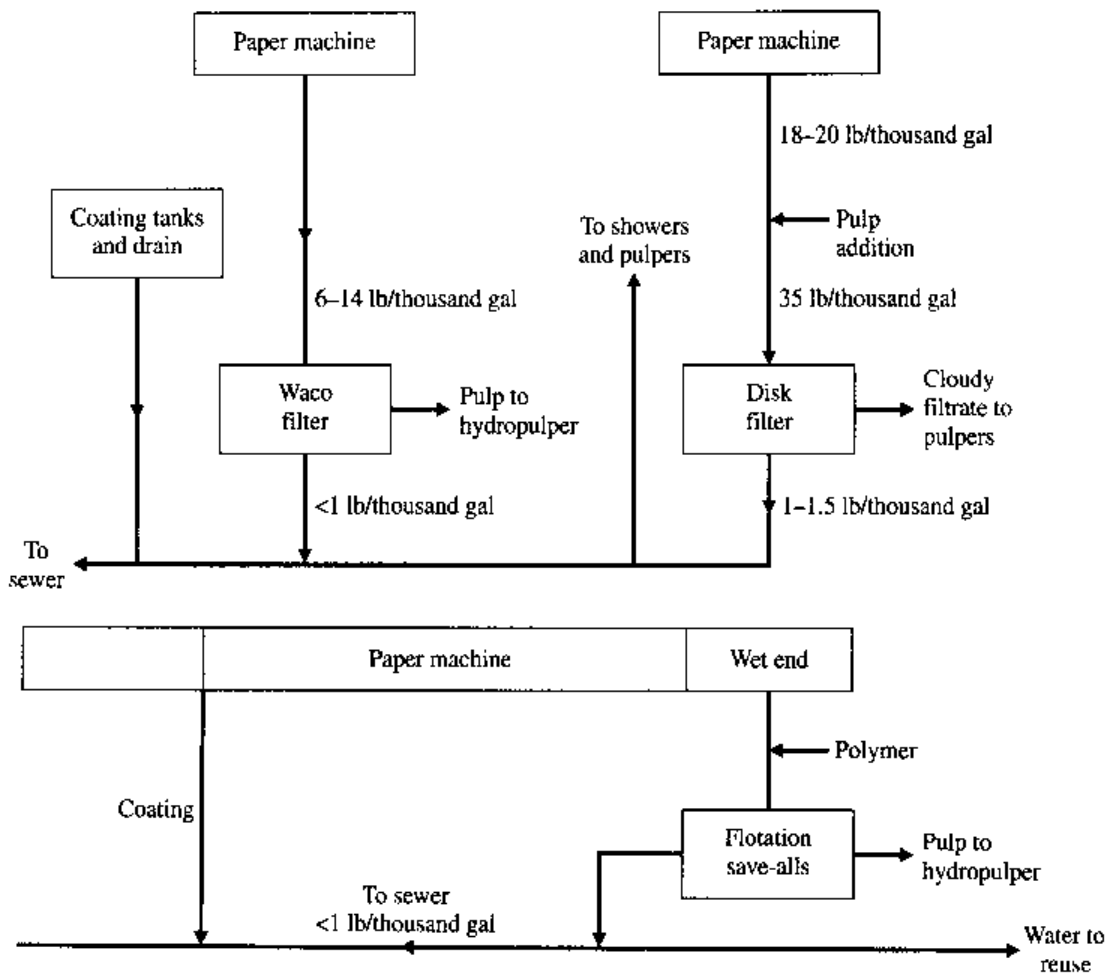
reusable chromic acid. Water conservation and materials recovery in nickel plating is shown in Fig. 1.21. There are many other similar instances in industry.

The best way to illustrate water reuse in industry is to cite several examples. Figure 1.22 shows simplified schematics of two water-reuse systems in a paperboard





**FIGURE 1.21**  
Water conservation and materials recovery (nickel plating).



Note: lb/thousand gal = 0.120 kg/m<sup>3</sup>

**FIGURE 1.22**  
Pulp and fiber recovery in a board mill.

mill. When a disk filter is employed, the cloudy filtrate is returned to the pulpers as makeup water and the clear filtrate is used for showers and other miscellaneous uses. The overflow is continuously discharged to the sewer. The use of a flotation save-all results in a similar operation. Waste from the clay-coating operations is usually discharged directly to the sewer.

Water conservation in brewery operations has been effected by reuse of the third rinse in kettle and vat cleaning for the next rinse, by reuse of cooling water for cleaning purposes, and by counterflow in pasteurizing and bottling operations. The total waste loading is reduced by removing the spent grains in a semidry state, by removing the yeast from the fermenters for filtration and drying, and by removing the sediment from the chill storage tanks as a slurry for separate disposal. In many cases these operations have yielded a salable by-product which has more than offset the increased costs of recovery.

Reuse at a pharmaceutical formulation plant has been effected by saving the first-rinse wastewaters from the cleaning of the formulation tank to make up the next batch of product. A significant reduction in wastewater volume and strength was achieved.

Reuse and makeup of sulfide dehairing solutions from tanning liquors have reduced both the volume and strength of wastes from this industry.

Data for water reuse in a corn-processing plant are shown in Table 1.14.

TABLE 1.14  
Unit waste flows for corn-processing operation and possible changes to reduce flow

Unit	Line	Flow, gal/min	Water use	Possible change	Estimated new flow
Rotary ear	1	21.7	Loosens and removes sand etc.	Screen 7 and reuse in washer	21.7
Cutting machines	2	27.0	Flumes kernels to flotation washer	Screen and recirculate	0.0
Scavenger reel	3	10.4	Flumes waste separated by flotation washer	Use smaller flow or remove as solid	5.2
Wash reel	4	18.0	Rewashes corn (not necessary)	Remove	8.0
Blancher	5	4.5	Overflow from makeup waste	No change	4.5
Cooling reel	6	24.5	Cool corn after blanching	Use smaller flow	10.0
Holding tank	7	16.9	Overflow from makeup water	Screen and reuse in rotary washer	0.0
Shaker screen	8	2.1	Flumes waste separated by reel	Remove as solid or reuse screen	0.0
Total		125.1			49.4

Note: gal/min =  $3.78 \times 10^{-3}$  m<sup>3</sup>/min

Spent caustic in a refinery is an alkaline waste, containing high concentrations of sulfides, mercaptans, and phenolates. Separate treatment of spent caustic may markedly reduce wastewater-treatment costs and can in some cases result in a marketable product.

In the organic chemicals industry, an example might be drawn from the Union Carbide plant at South Charleston, West Virginia. The plant is reasonably representative of what might be expected from a major multiproduct chemicals complex. A detailed study of waste load reduction by in-plant changes showed that the present plant flow of 11.1 million gal/d (42,000 m<sup>3</sup>/d) and 55,700 lb of BOD/d (25,300 kg/d) could be reduced to a flow of 8.3 million gal/d (31,400 m<sup>3</sup>/d) and 37,100 lb BOD/d (16,800 kg/d). The ways of achieving these reductions are shown in Table 1.15. Equipment revision and additions and unit shutdowns refer to those units that would be replaced. Incineration involves the option of taking the more concentrated wastewater streams and, instead of discharging to the main sewer, segregating them for incineration. Reprocessing refers to taking the tank bottoms that still have product present and reprocessing them for further product recovery.

Frequently, wastestreams can be eliminated or reduced by process modifications or improvements. A notable example of this is the use of save-rinse and spray-rinse tanks in plating lines. This measure will bring about a substantial reduction in wastewater flow and strength. In dairies, equipment modifications to collect drippings will usually substantially reduce the BOD loading to the sewer. Substitution of sizing agents in textile plants may result in a lower net pollutorial load for treatment.

TABLE 1.15  
General analysis of in-plant modifications

Type of modifications	Description	Total RWL reduction, %
Equipment revision and additions	Self-explanatory	25
Unit shutdown	Shutdowns due to the age of the unit or the product; these shutdowns are not a direct result of pollution considerations, but they are somewhat hastened by these considerations	10
Scrubber replacement	Replacement of scrubbers associated with amine production by burning of the off-vapors	3
Segregation, collection, and incineration	Of specific concentrated wastewater streams	35
Raw material substitutions	Self-explanatory	3
Reprocessing	Collecting tail streams from specific processes, then putting streams through an additional processing unit to recover more product and concentrate the final wastestream	
Miscellaneous small projects	A variety of modifications which individually do not represent a large reduction in RWL	21

There are many other examples from various industries. A critical evaluation of water reuse and by-product recovery possibilities should be undertaken before the development of waste-treatment needs.

Segregation of incompatible wastestreams should be considered before treatment process design criteria are developed. In some older plants, however, this may be economically unfeasible or in some cases impossible. Segregation becomes a necessity when combination of wastestreams will result in potential safety hazards. In a plating plant, for example, a mixture of acidic metal rinses with cyanide streams could produce toxic HCN.

It is not uncommon for a portion of a waste flow to contain the majority of the suspended solids loading. Only this part of the flow needs to receive treatment for solids removal. This is true, for instance, in a tannery where 90 percent of the suspended solids come from the beam house in approximately 60 percent of the flow.

Frequently, cooling water or other noncontaminated streams can be segregated and discharged directly to the receiving water.

Consideration of water reuse, by-product recovery, and waste segregation will make it possible to revise the material balance-and-flow diagram to establish the basis for process design of waste-treatment facilities. This is illustrated in Example 1.3.

Up to this point, reductions in wastewater volume and strength have been achieved by in-plant changes. The installation of wastewater treatment can be considered for the purpose of recycling rather than for disposal. This becomes particularly significant in the case of the high effluent discharge standards. From this figure a relationship may be developed for determining the daily cost for a water management system:

$$C = C_w(1 - f)Q + C_RfQ + C_D[Q(1 - f) - L]$$

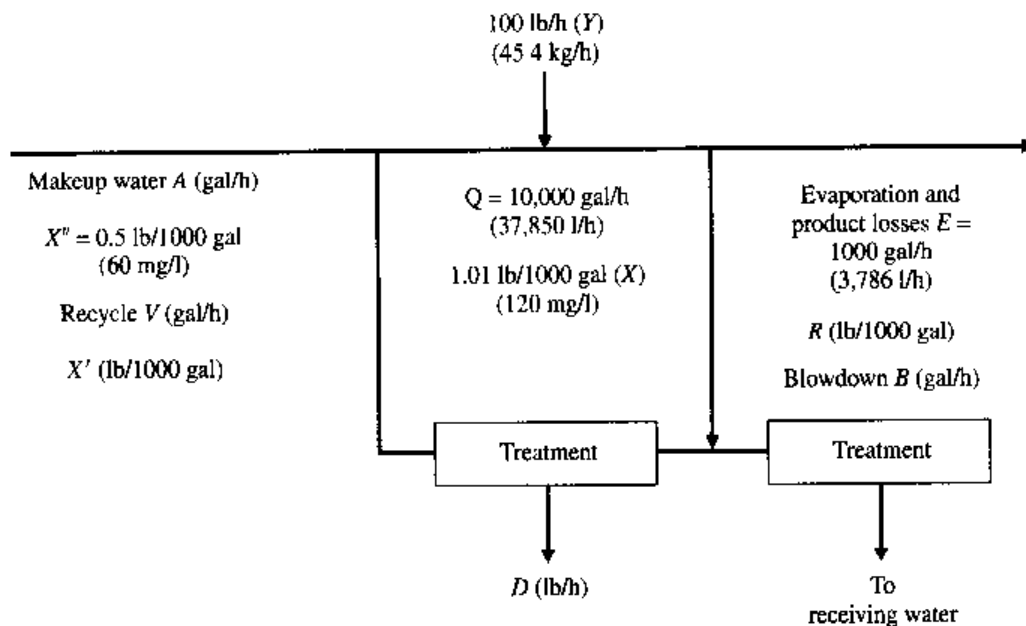
where  $C$  = daily cost  
 $Q$  = production water requirements  
 $C_w$  = freshwater cost  
 $C_R$  = recycled water costs  
 $C_D$  = effluent treatment costs  
 $f$  = fraction recycled  
 $L$  = total water losses

**EXAMPLE 1.3.** A plant uses 10,000 gal/h (37,850 l/h) of process water with a maximum contaminant concentration of 1 lb/1000 gal (120 mg/l). The raw water supply has a contaminant concentration of 0.5 lb/1000 gal (60 mg/l) (see Fig. 1.23). Optimize a water-reuse system for this plant based on a raw water cost of 20 cents/1000 gal (5.3 cents/1000 l). The following conditions apply:

Evaporation and product loss  $E = 1000$  gal/h (3785 l/h)  
 Contaminant addition  $Y = 100$  lb/h (45.4 kg/h)  
 Maximum discharge to receive water = 20 lb/h (9.1 kg/h)

**Example calculation**

Let  $A = 3000$  gal/h (11,355 l/h). Since  $A = E + B$ ,  $B = 3000 - 1000 = 2000$  gal/h (7570 l/h) and the recycle  $V$  is 7000 gal/h (26,495 l/h).

**FIGURE 1.23**

Water reuse and treatment balance.

By a material balance:

$$R = \frac{(A + V)X + Y}{(A + V) - E} = \frac{(10)(1.0) + 100}{10 - 1} = 12.2 \text{ lb/1000 gal (1464 mg/l)}$$

By a material balance:

$$QX = AX'' + VX'$$

$$X' = \frac{QX - AX''}{V} = \frac{(10)(1.0) - A(0.5)}{V} = \frac{10 - (3)(0.5)}{7} \\ = 1.21 \text{ lb/1000 gal (145 mg/l)}$$

The required efficiency of treatment for reuse is:

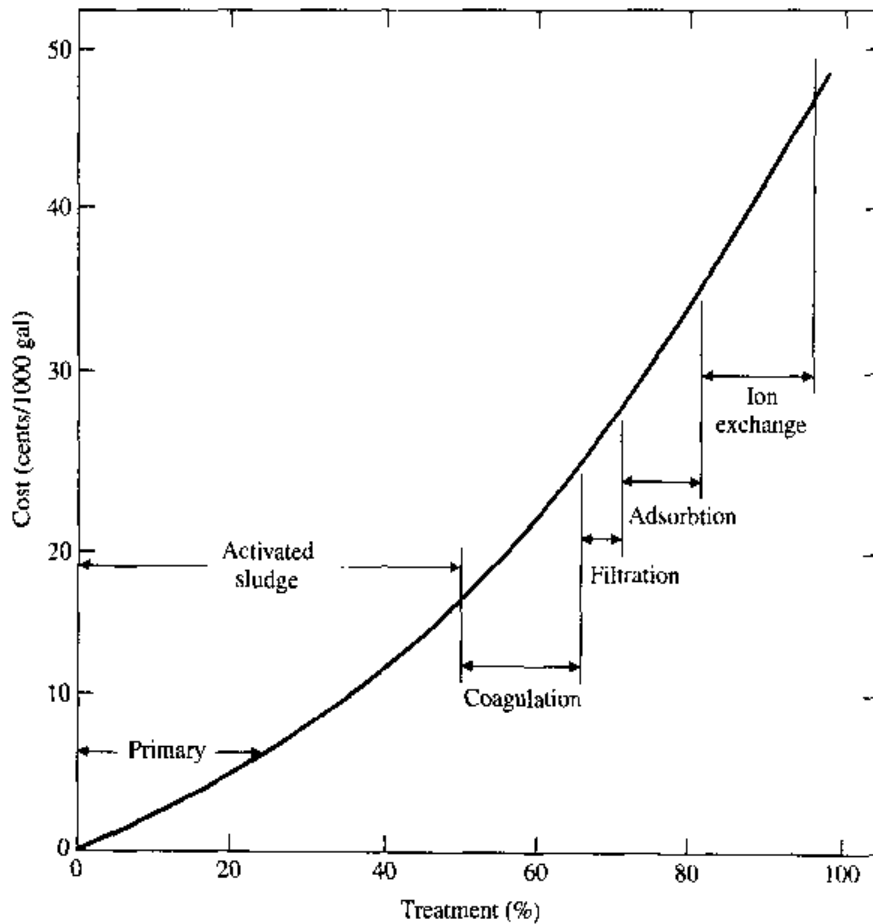
$$\% \text{ Removal} = \frac{R - X'}{R} \cdot 100 = \frac{12.2 - 1.21}{12.2} \cdot 100 = 90\%$$

The required treatment efficiency for discharge to the river is:

$$\frac{2(12.2) - 20}{2(12.2)} \cdot 100 = 18\%$$

The raw water cost for 3000 gal/h is  $(3)(24)(0.20) = \$14.40/\text{d}$ . The cost of effluent treatment for discharge to the river is 5 cents/1000 gallon for a total daily cost of  $(2)(0.05)(24)$ , or  $\$2.40/\text{d}$ . The cost of treatment for reuse (see Fig. 1.24) is  $(7)(0.42)(24) = \$70.60/\text{d}$ . The net total cost is  $\$87.40/\text{d}$ . A similar series of calculations is made for freshwater inputs varying from 2000 to 10,000 gal/h (no reuse). The total daily water cost can then be plotted versus percent recycle as shown in Fig. 1.25.

Another study in a bleached kraft mill is shown in Fig. 1.26. Effluent 1 requires a 75 percent removal of BOD and suspended solids with no limitation on

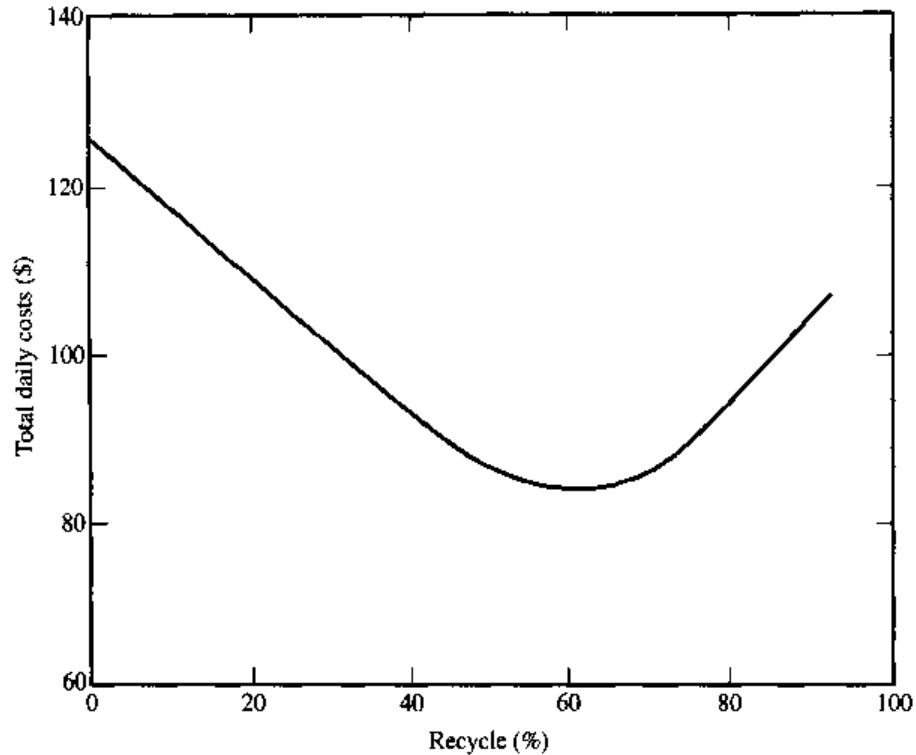


**FIGURE 1.24**  
Relationship between total water cost and treatment (1 cent/1000 gal = 0.26 cent/1000 l).

color. Effluent 2 requires 20 mg/l BOD<sub>5</sub> and suspended solids without color control. Effluent 3 requires 25 mg/l BOD<sub>5</sub> and 30 mg/l SS with 50 units of color. It is obvious from this figure that the optimal recycle will primarily be related to the effluent quality requirement and to the cost of fresh water.

## 1.8 STORMWATER CONTROL

In most industrial plants, it is now necessary to contain and control pollutional discharges from stormwater. Pollutional discharges can be minimized by providing adequate diking around process areas, storage tanks, and liquid transfer points with drainage into the process sewer. Contaminated stormwater is usually collected according to the storm frequency for the area in question (e.g., a 10-year storm) in a holding basin. The collected water is then passed through the wastewater treatment plant at a controlled rate. A total storm-runoff flow and contaminant loading of a refinery petrochemical installation is shown in Fig. 1.27. An example of stormwater control is shown in Example 1.4.



**FIGURE 1.25**

Relationship between total daily water cost and treated waste recycle for reuse.

**EXAMPLE 1.4.** If runoff is to be stored or surged prior to eventual treatment, anticipated rainfall volumes must be estimated. The probable rainfalls for periods of 1 day to 1 year are given in Table 1.16 and Fig. 1.28 for the 2-year storm.

The areas and runoff coefficients associated with a refinery complex are shown in Table 1.17. Determine:

- The cumulative runoff (million gal) as a function of time (days).
- The required minimum return rate for treatment (million gal/d or  $m^3/d$ ) for storage periods of 10, 30, 60, and 120 d.
- The required storage capacity (million gal or  $m^3$ ) for storage periods of 10, 30, 60, and 120 d.

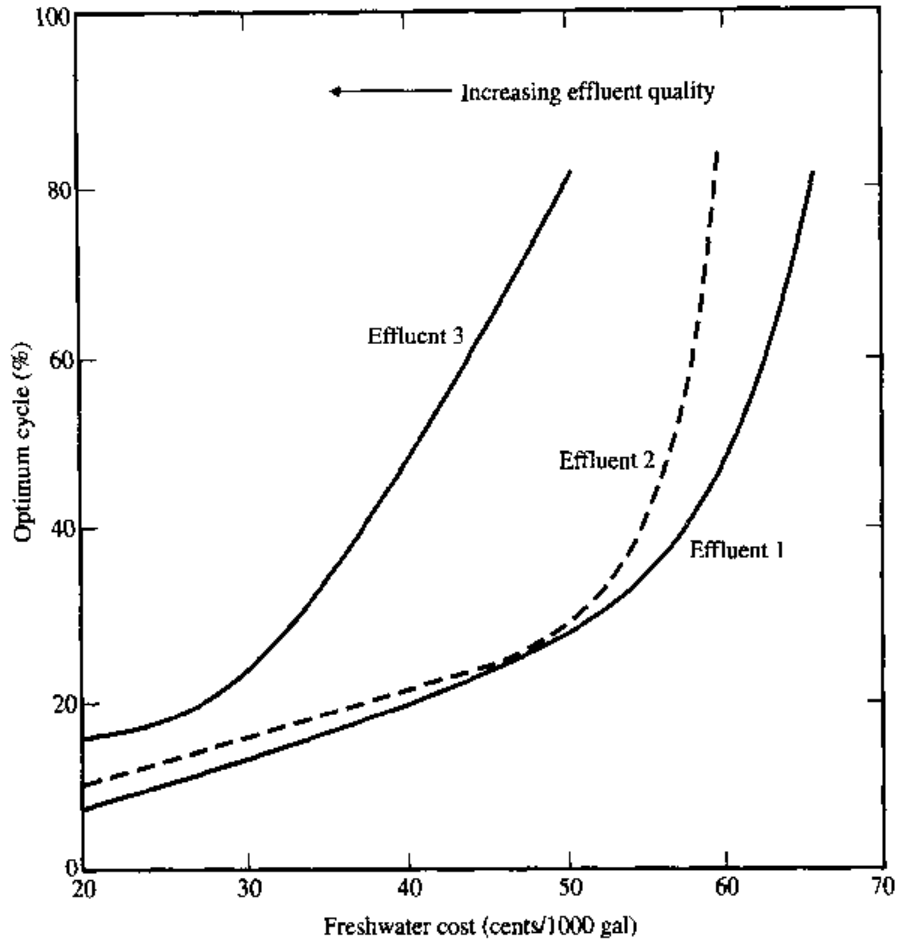
**Solution.**

- (a) Total effective areas

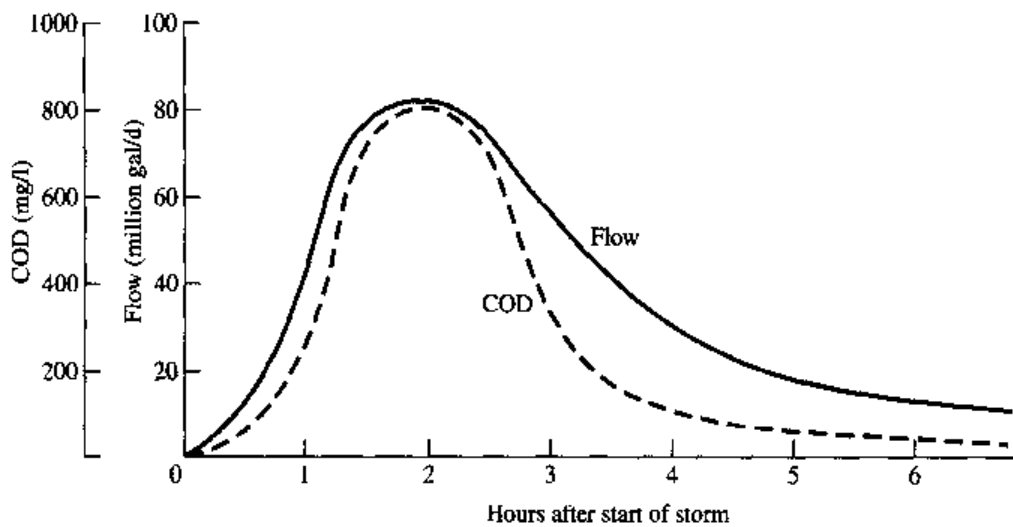
$$\begin{aligned}
 &= 21.8 \times 1.0 + 115.4 \times 0.5 + 166.9 \times 0.7 + 176.7 \times 0.5 + 55.6 \times 0.9 \\
 &= 334.7 \text{ acres} \quad (1.36 \times 10^6 \text{ m}^2)
 \end{aligned}$$

From the table of cumulative rainfall with various time periods, the cumulative runoff as a function of time can be estimated by

$$q = i(CA)$$



**FIGURE 1.26**  
Optimum recycle versus freshwater cost for varied effluent quality (1 cent/1000 gal = 0.26 cent/100 l).



Note: million gal/d =  $3.78 \times 10^3 \text{ m}^3/\text{d}$

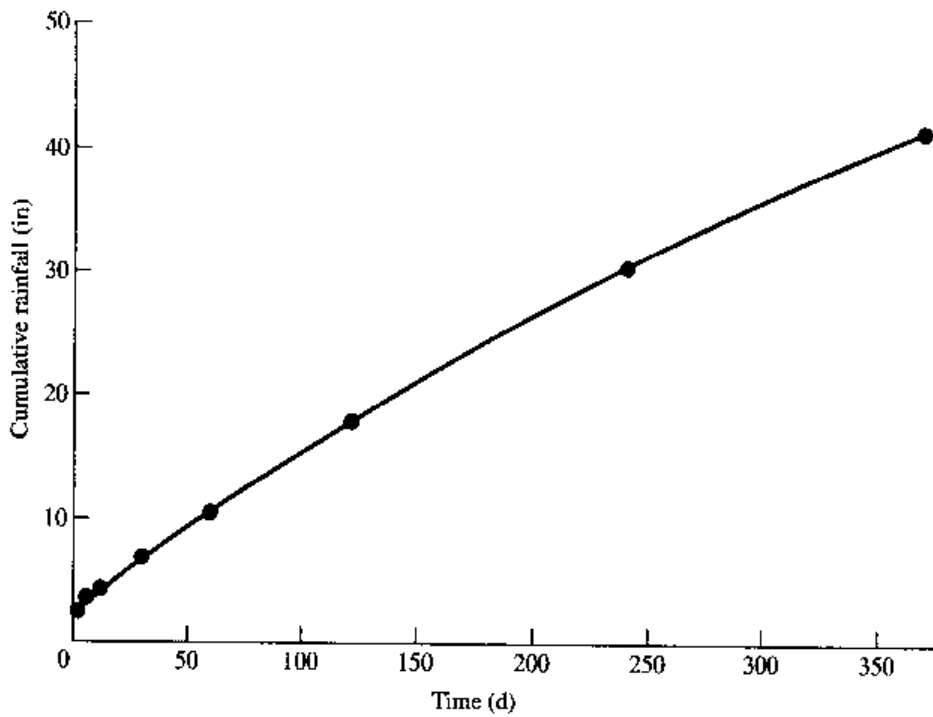
**FIGURE 1.27**  
Total storm runoff flow and contaminant loading for a refinery installation.



TABLE 1.16

Time period, d	Cumulative rainfall, in
1	2.5
5	3.7
10	4.5
30	6.6
60	10.7
120	18.0
240	30.0
360	41.0

Note: in = 0.0254 m = 2.54 cm



Note: in = 0.0254 m

FIGURE 1.28  
Two-year recurrence level probability rainfalls.

TABLE 1.17

Type of surface	Area, acres	Runoff coefficient, C
Water surface	21.8	1.0
Dirt or gravel	115.4	0.5
Bermed tank farm	166.9	0.7
Grass	176.7	0.5
Asphalt or concrete	55.6	0.9

Note: acre =  $4.05 \times 10^3 \text{ m}^2$

in which  $CA$  is the effective area and  $i$  is the rainfall intensity. An example calculation for a 10-d period at 4.5 in (0.114 m) rainfall is

$$q = 4.5 \text{ in} \times 334.7 \text{ acre} \times \frac{43,560 \text{ ft}^2}{\text{acre}} \times \frac{0.0833 \text{ ft}}{\text{in}} \times \frac{7.48 \text{ gal}}{\text{ft}^3}$$

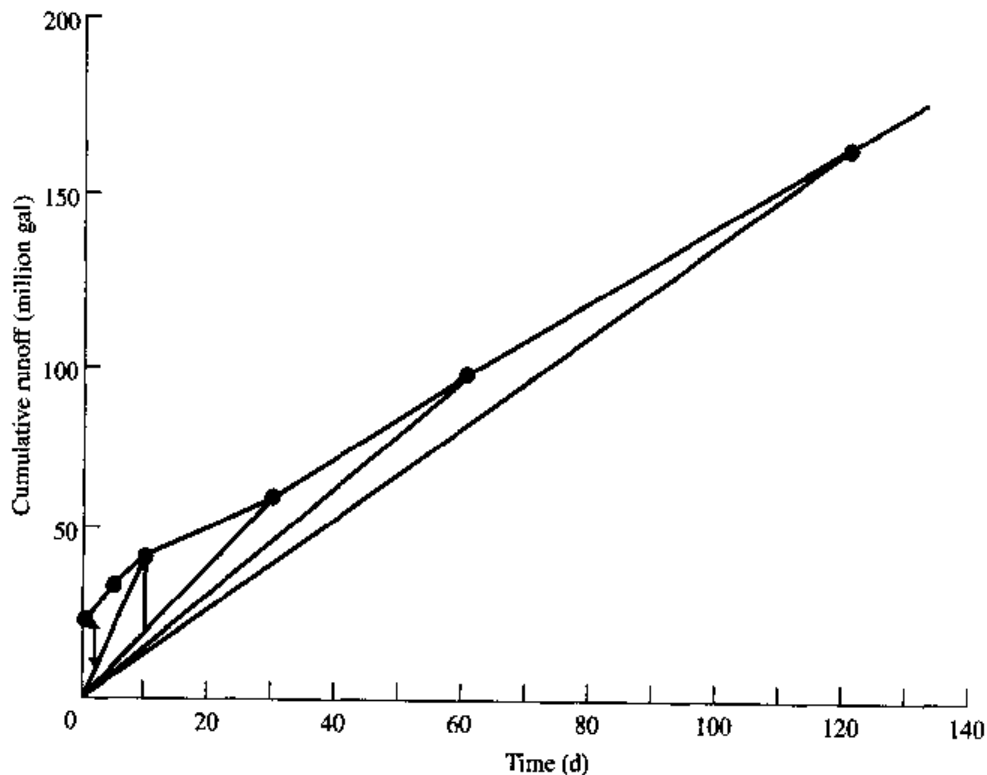
$$= 4.088 \times 10^7 \text{ gal or } 40.9 \text{ million gal} \quad (1.55 \times 10^5 \text{ m}^3)$$

The results are tabulated in Table 1.18 and plotted in Fig. 1.29.

TABLE 1.18

Time, d	Runoff, million gal
1	22.7
5	33.6
10	40.9
30	60.0
60	97.2
120	163.5
240	272.5
360	372.4

Note: million gal =  $3.78 \times 10^5 \text{ m}^3$



Note: million gal =  $3.78 \times 10^5$

FIGURE 1.29

Cumulative runoff curve.

- (b) The minimum allowable return rate for treatment from a storage basin, assuming the stored volume will be returned at a uniform flow rate, is defined by the slope of a straight line connecting the origin and a point on the cumulative runoff curve representing the maximum practical storage period. A sample calculation for 10 d is

$$\begin{aligned}\text{Return rate} &= \frac{40.9 - 0}{10 - 0} \text{ million gal/d} \\ &= 4.1 \text{ million gal/d } (1.55 \times 10^4 \text{ m}^3/\text{d})\end{aligned}$$

- (c) The volume of runoff stored is the difference between the cumulative output and the cumulative input. This is equal to the maximum vertical distance between the cumulative runoff curve and the straight line depicting the rate of removal. An example for 10 d is

$$\text{Required volume storage} = 18 \text{ million gal } (6.8 \times 10^4 \text{ m}^3)$$

The results are given in Table 1.19.

TABLE 1.19

Storage period, period d	Return rate, million gal/d	Required storage, million gal
10	4.09	18.0
30	2.00	20.9
60	1.62	24.0
120	1.36	28.0

Note: million gal/d =  $3.78 \times 10^3 \text{ m}^3/\text{d}$   
million gal =  $3.78 \times 10^3 \text{ m}^3$

## PROBLEMS

- 1.1. The 4-h composite COD data from a brewery effluent over a 7-d period is as follows:

980			
2800	3200	6933	3325
1380	3175	1240	6000
1250	3850	580	3100
720	2870	710	2500
8650	2600	3410	1830
7200	2743	2910	3225
2800	3600	8300	2370
2570	4066	2950	1380
1780	1550	2230	2600

Develop a statistical plot of these data in order to define the 50 and the 90 percent values.

1.2. A tomato-processing plant is shown in Fig. P1.2. The industrial waste survey data are shown in the table below. Develop a flow-and-material balance diagram for the plant sewer system. Show possible changes to reduce the flow and loading. The waste from the trimming tables is presently flumed to the sewer.

Sampling station	Process unit	Flow, gal/min	BOD, mg/l	SS, mg/l
1	Niagra washers	500	75	180
2	Rotary washers	—	90	340
3	Pasteurizer	300	30	20
4	Source cooker	10	3520	7575
5	Cook room	20	4410	8890
6	Source finisher	150	230	170
7	Trimming tables	100	450	540
8	Main outfall	1080	240	470

Note: gal/min =  $3.78 \times 10^{-3} \text{ m}^3/\text{min}$

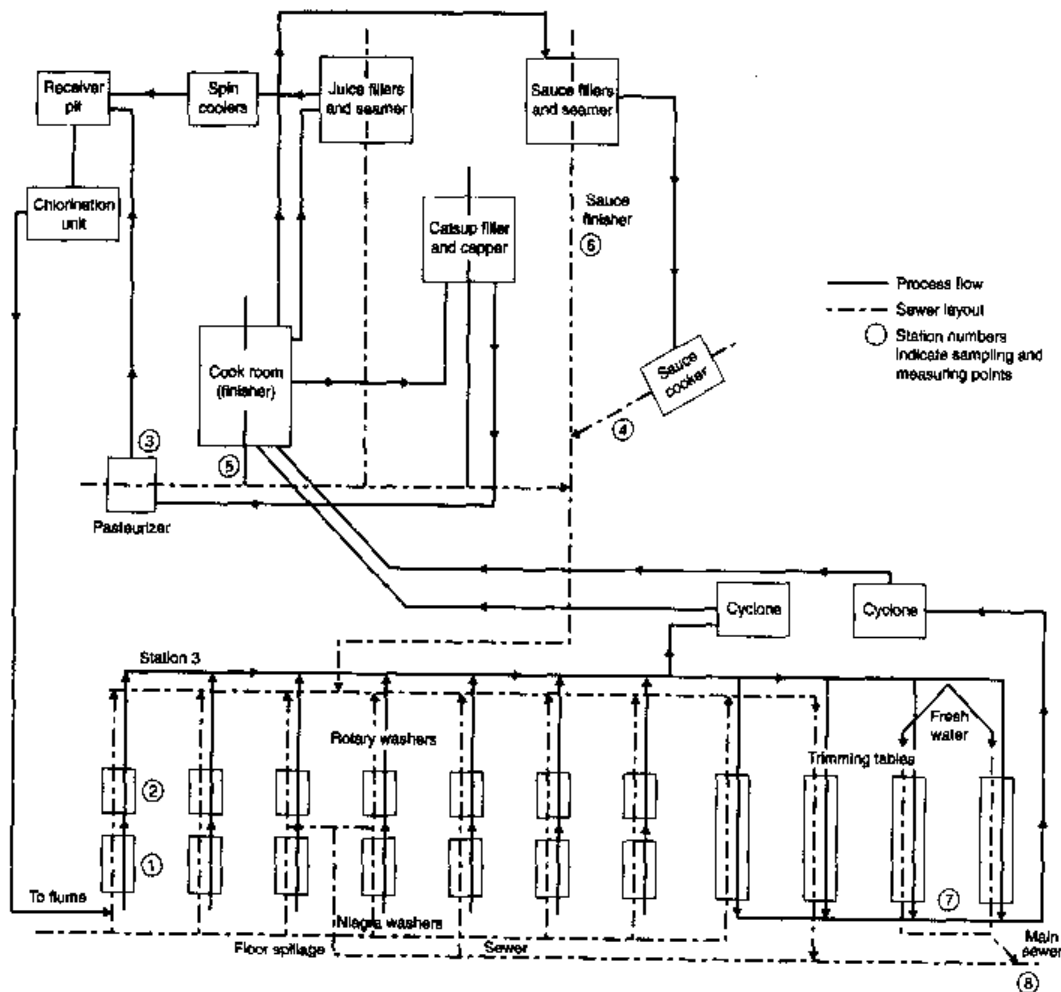


FIGURE P1.2  
Flow diagram of a tomato-processing plant.

1.3. A wastewater contains the following constituents:

- 40 mg/l phenol
- 350 mg/l glucose
- 3 mg/l  $S^{2-}$
- 50 mg/l methyl alcohol,  $CH_3OH$
- 100 mg/l isophorene,  $C_9H_{14}O$  (nondegradable)

- (a) Compute the THOD, the COD, the TOC, and the  $BOD_5$  assuming the  $k_{10}$  for the mixed wastewater is 0.25/d.
- (b) After treatment the soluble  $BOD_5$  is 10 mg/l with a  $k_{10}$  of 0.1/d. Compute the residual COD and TOC.

### REFERENCES

1. Schroeffer, G. J.: *Advances in Water Pollution Control*, vol. 1, Pergamon Press, New York, 1964.
2. Stack, V. T.: *Proc. 8th Ind. Waste Conf.*, 1953, p. 492, Purdue University.
3. Busch, A. W.: *Proc. 15th Ind. Waste Conf.*, 1961, p. 67, Purdue University.
4. Ford, D. L.: *Proc. 23rd Ind. Waste Conf.*, 1968, p. 94, Purdue University.
5. Dorn, P. B.: *Toxicity Reduction—Evaluation and Control*, Technomic Publishing Co., 1992.

---

## WASTEWATER TREATMENT PROCESSES

---

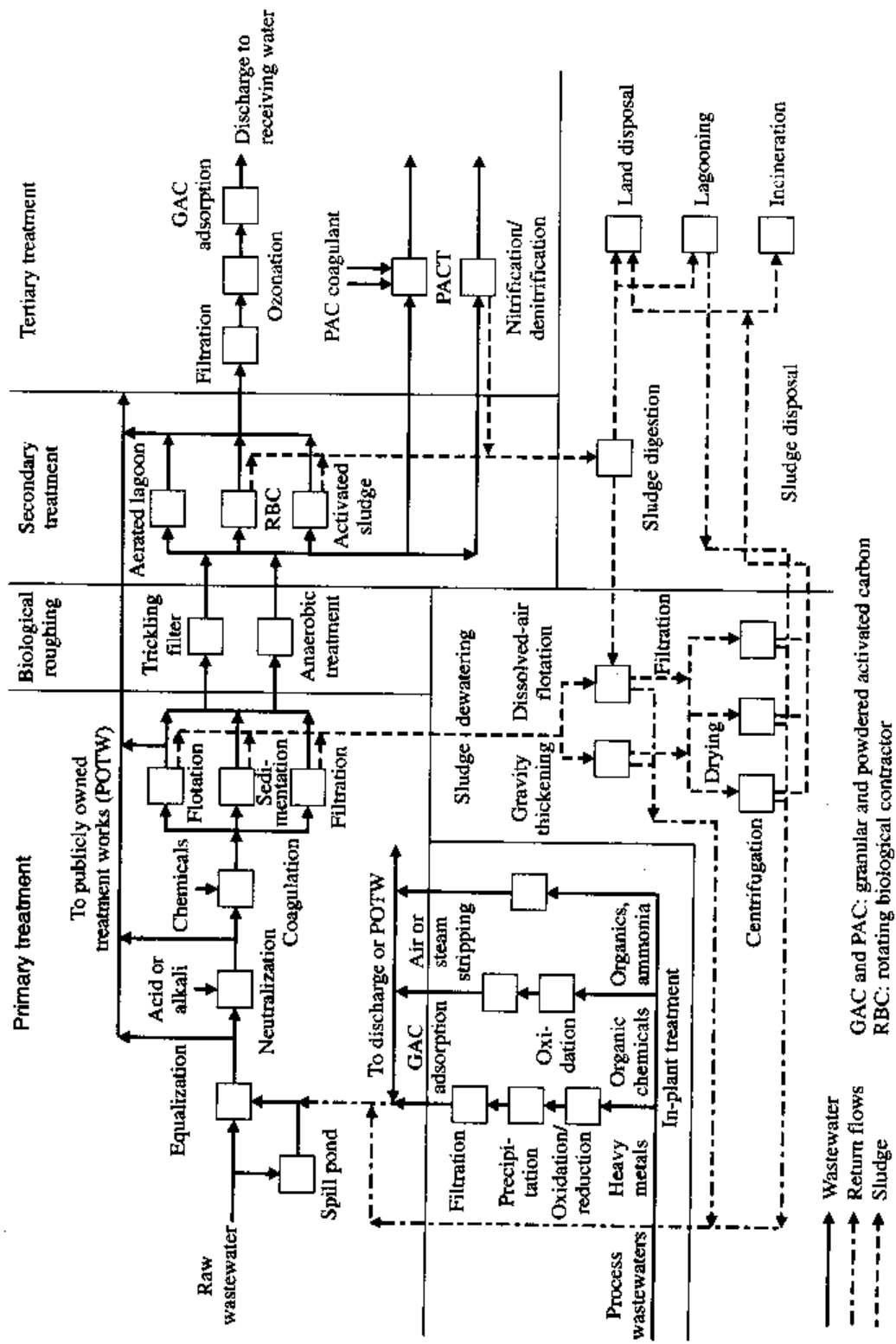
The schematic diagram in Fig. 2.1 illustrates an integrated system capable of treating a variety of plant wastewaters. The scheme centers on the conventional series of primary and secondary treatment processes, but also includes tertiary treatment and individual treatment of certain streams.

Primary and secondary treatment processes handle most of the nontoxic wastewaters; other waters have to be pretreated before being added to this flow. These processes are basically the same in an industrial plant as in a publicly owned treatment works (POTW).

Primary treatment prepares the wastewaters for biological treatment. Large solids are removed by screening, and grit, if present, is allowed to settle out. Equalization, in a mixing basin, levels out the hour-to-hour variations in flows and concentrations. There should be a spill pond, to retain slugs of concentrated wastes that could upset the downstream processes. Neutralization, where required, follows equalization because streams of different pH partly neutralize each other when mixed. Oils, greases, and suspended solids are removed by flotation, sedimentation, or filtration.

Secondary treatment is the biological degradation of soluble organic compounds—from input levels of 50 to 1000 mg/l BOD and even greater to effluent levels typically under 15 mg/l. This is usually done aerobically, in an open, aerated vessel or lagoon, but wastewaters may be pretreated anaerobically, in a pond or a closed vessel. After biotreatment, the microorganisms and other carried-over solids are allowed to settle. A fraction of this sludge is recycled in certain processes, but ultimately the excess sludge, along with the sedimented solids, has to be disposed of.

Many existing wastewater-treatment systems were built just for primary and secondary treatment, though a plant might also have systems for removing materials that would be toxic to microorganisms. Until recently, this was adequate, but now it is not, and so new facilities have to be designed and old facilities retrofitted to include additional capabilities to remove priority pollutants and residuals toxic to aquatic life.



**FIGURE 2.1**  
Alternative technologies for the treatment of industrial wastewaters.

Tertiary-treatment processes are added on after biological treatment in order to remove specific types of residuals. Filtration removes suspended or colloidal solids; adsorption by granular activated carbon (GAC) removes organics; and chemical oxidation also removes organics. Unfortunately, tertiary systems have to treat a large volume of wastewater, and so they are expensive. They can also be inefficient because the processes are not pollutant-specific. For example, dichlorophenol can be removed by ozonation or GAC adsorption, but those processes will remove most other organics as well, and this adds greatly to the treatment costs for removing the dichlorophenol.

In-plant treatment is necessary for streams rich in heavy metals, pesticides, and other substances that would pass through primary treatment and inhibit biological treatment. In-plant treatment also makes sense for low-volume streams rich in nondegradable materials, because it is easier and much less costly to remove a specific pollutant from a small, concentrated stream than from a large, dilute one. Processes used for in-plant treatment include precipitation, activated carbon adsorption, chemical oxidation, air or steam stripping, ion exchange, reverse osmosis, electro dialysis, and wet air oxidation.

Existing treatment systems can also be modified so as to broaden their capabilities and improve their performance; this is more widely practiced than the above options. One example is adding powdered activated carbon (PAC) to the biological-treatment process, to adsorb organics that the microorganisms cannot degrade or slowly degrade; this is marketed as the PACT process. Another example is adding coagulants at the end of the biological-treatment basin so as to remove phosphorus and residual suspended solids.

All these processes have their place in the overall wastewater-treatment scheme. The selection of a wastewater-treatment process or a combination of processes depends upon:

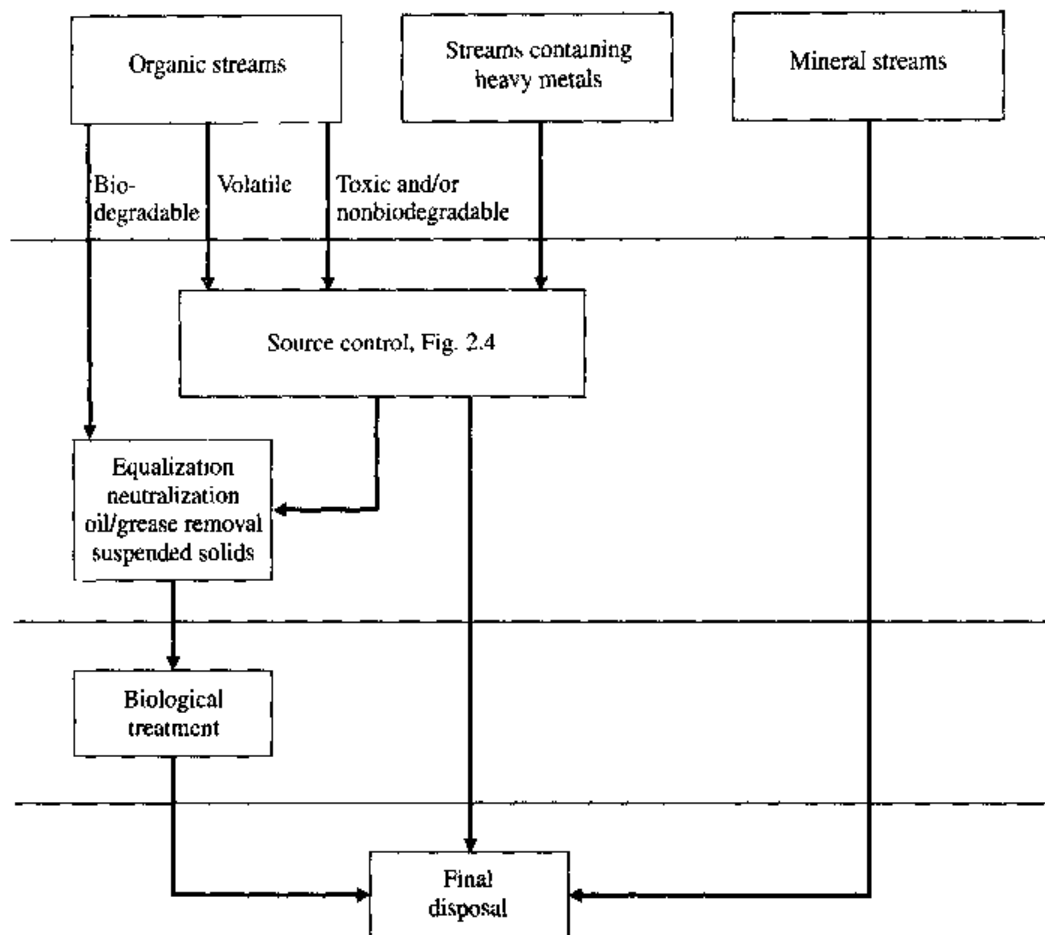
1. The characteristics of the wastewaters. This should consider the form of the pollutant, i.e., suspended, colloidal, or dissolved; the biodegradability; and the toxicity of the organic and inorganic components.
2. The required effluent quality. Consideration should also be given to possible future restrictions such as an effluent bioassay aquatic toxicity limitation.
3. The costs and availability of land for any given wastewater-treatment problem. One or more treatment combinations can produce the desired effluent. Only one of these alternatives, however, is the most cost-effective. A detailed cost analysis should therefore be made prior to final process design selection.

### Process Selection

A preliminary analysis should be carried out to define the wastewater treatment problems as shown in Fig. 2.2.

For wastewaters containing nontoxic organics, process design criteria can be obtained from available data or from a laboratory or pilot plant program. Examples are pulp and paper mill wastewaters and food processing wastewaters. In the case of complex chemical wastewaters containing toxic and nontoxic





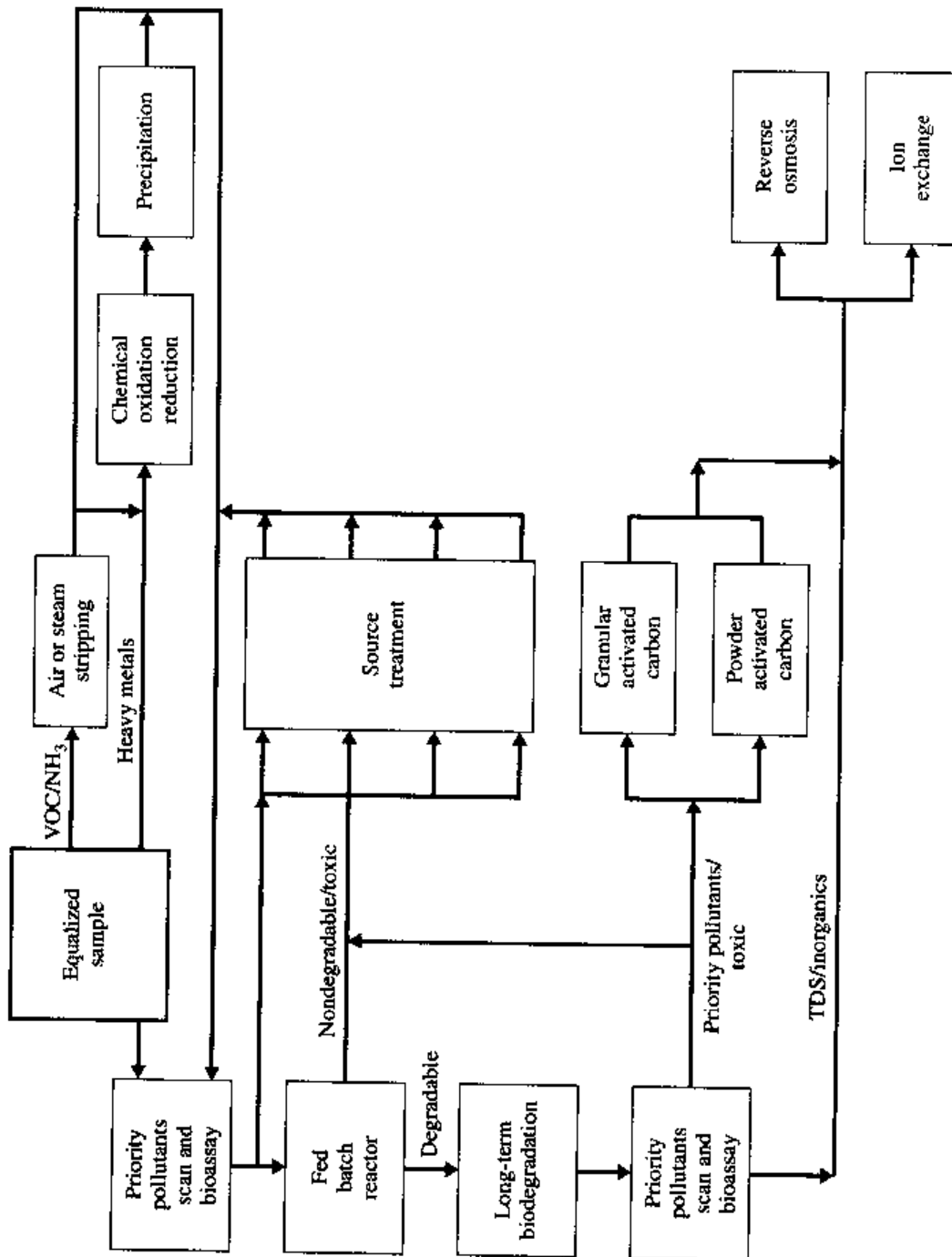
**FIGURE 2.2**

Conceptual approach of treatment/management program for a high (organic) strength and toxic industrial wastewater.

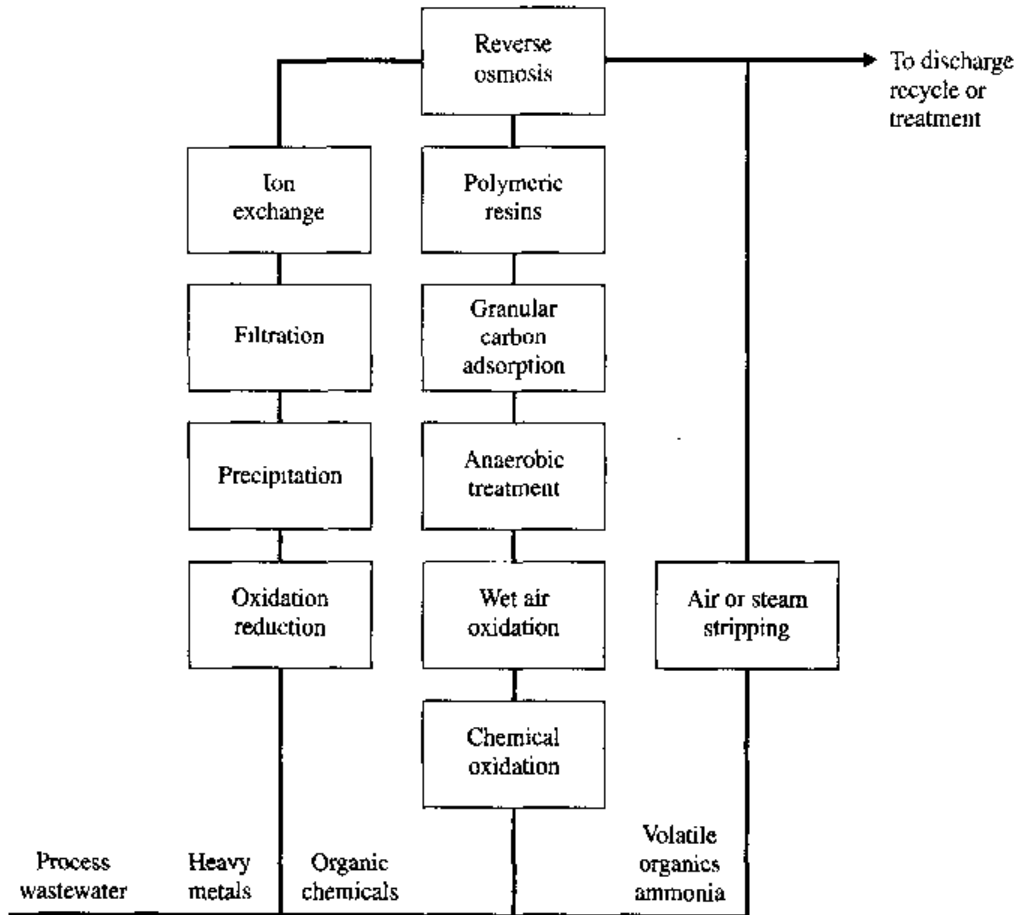
organics and inorganics, a more defined screening procedure is necessary to select candidate processes for treatment. A protocol has been established as shown in Fig. 2.3. If the wastewater contains heavy metals, they are removed by precipitation. Volatile organics are removed by air stripping.

Following laboratory screening, pretreatment-as-required analyses are conducted on an equalized sample as shown in Fig. 2.3. It should be noted that all significant wastewater streams in the industrial complex should be evaluated. The next step is to determine whether the wastewater is biodegradable and whether it will be toxic to the biological process at some level of concentration. The fed batch reactor (FBR) procedure is employed for this purpose. Details of this procedure are discussed on p. 268. Acclimated sludge as discussed on p. 203 should be used. If the wastewater is nonbiodegradable or toxic it should be considered for source treatment or in-plant modification. Source treatment technologies are shown in Fig. 2.4.

If the wastewater is biodegradable, it is subjected to a long-term biodegradation, usually 48 hours, in order to remove all degradable organics. It is then evaluated for aquatic toxicity and priority pollutants. If nitrification is required, a nitrification rate analysis is conducted as discussed on p. 290. If the effluent is toxic or



**FIGURE 2.3**  
Screening laboratory procedures.



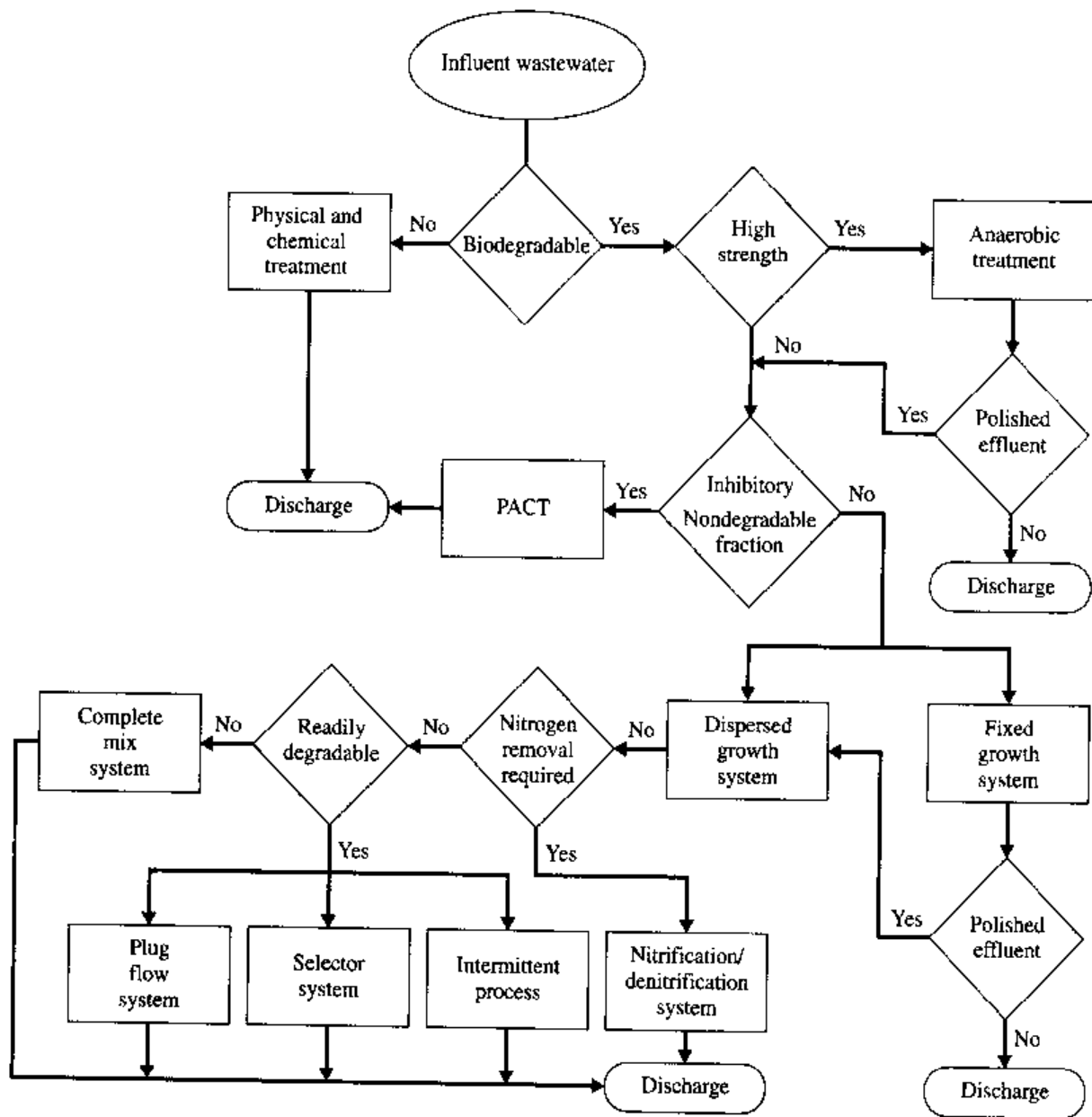
**FIGURE 2.4**

Applicable technologies for treatment of toxic wastewaters.

if priority pollutants have not been removed, it should be considered for source treatment or tertiary treatment using powdered or granular activated carbon. It should be noted that toxicity due to soluble microbial products (SMP) will require tertiary treatment for its removal.

When biological treatment is considered, several options exist. A screening procedure has been developed to determine the most cost-effective alternative, as shown in Fig. 2.5.

The alternatives for biological treatment are summarized in Table 2.1 and discussed in detail in Chap. 7. A screening and identification matrix for physical-chemical treatment is shown in Table 2.2. Table 2.2 should provide a guide to select applicable technologies for specific problems. A summary of physical-chemical technology applications is shown in Table 2.3. The maximum attainable effluent quality for conventional wastewater treatment processes is shown in Table 2.4.



**FIGURE 2.5**  
Simplified process selection flowsheet for biological treatment.

TABLE 2.1  
Biological waste treatment

Treatment method	Mode of operation	Degree of treatment	Land requirements	Equipment	Remarks
Lagoons	Intermittent or continuous discharge; facultative or anaerobic	Intermediate	Earth dug; 10-60 days' retention		Odor control frequently required
Aerated lagoons	Completely mixed or facultative continuous basins	High in summer; less in winter	Earth basin, 8-16 ft (2.44-4.88 m) deep, 8-16 acres/(million gal/d) [8.55-17.1 m <sup>2</sup> (m <sup>2</sup> /d)]	Pier-mounted or floating surface aerators or subsurface diffusers	Solids separation in lagoon; periodic dewatering and sludge removal
Activated sludge	Completely mixed or plug flow; sludge recycle	>90% removal of organics	Earth or concrete basin; 12-20 ft (3.66-6.10 m) deep; 75,000-350,000 ft <sup>3</sup> /(million gal/d) [0.561-2.262 m <sup>3</sup> /(m <sup>3</sup> /d)]	Diffused or mechanical aerators; clarifier for sludge separation and recycle	Excess sludge dewatered and disposed of
Trickling filter	Continuous application; may employ effluent recycle	Intermediate or high, depending on loading	225-1400 ft <sup>2</sup> /(million gal/d) (5.52-34.4 m <sup>2</sup> /10 <sup>3</sup> m <sup>3</sup> /d)	Plastic packing 20-40 ft deep (6.10-12.19 m)	Pretreatment before POTW or activated sludge plant
RBC	Multistage continuous	Intermediate or high		Plastic disks	Solids separation required
Anaerobic	Complete mix with recycle; upflow or downflow filter, fluidized bed; upflow sludge blanket	Intermediate		Gas collection required; pretreatment before POTW or activated sludge plant	
Spray irrigation	Intermittent application of waste	Complete; water percolation into ground-water and runoff to stream	40-300 gal/(min · acre) [6.24 × 10 <sup>-7</sup> - 4.68 × 10 <sup>-6</sup> m <sup>3</sup> /(s · m <sup>2</sup> )]	Aluminum irrigation pipe and spray nozzles; movable for relocation	Solids separation required; salt content in waste limited

Note:

- ft = 0.305 m
- acre/(million gal · d) = 1.07 m<sup>2</sup>/(m<sup>3</sup> · d)
- ft<sup>3</sup>/(million gal · d) = 7.48 × 10<sup>-3</sup> m<sup>3</sup>/(thousand m<sup>3</sup> · d)
- ft<sup>2</sup>/(million gal · d) = 2.45 × 10<sup>-2</sup> m<sup>2</sup>/(thousand m<sup>3</sup> · d)
- gal/(min · acre) = 1.56 × 10<sup>-8</sup> m<sup>3</sup>/(s · m<sup>2</sup>)

TABLE 2.2  
Screening and identification matrix for industrial wastewaters physical-chemical treatment

Stripping												
Process	Organic compounds	Non-condensibles	Parameter									
			Temperature	Pressure	pH	O&G, mg/l	SS, mg/l	TDS, mg/l	Fe, Mn	Sol	Comments	
Air	<100 mg/l	A	DP	DP	DP	R	R	R	DP	R	L	$H_c > 0.005$ is recommended.
Steam	<100 mg/l to 10%	R	DP	DP	NI	R	R	R	DP	NI	M	Relative volatility referred to water > 1.05 is recommended. Azeotrope formation is important.

Oxidation processes											
Process	Organic compounds	Temperature °F	Pressure, psig	pH	OD, g/l	O&G, mg/l	SS, mg/l	TDS, mg/l	Fe, Mn	MW	Comments
Wet air oxidation	A	350-650	300-3000	NI	20-200	NI	NI	DP	NI	NI	Not recommended for aromatic halogenated organics. Recommended for high COD/BOD ratio.
Supercritical water oxidation	A	750-1200	3675	NI	<10	NI	NI	L	NI	NI	
Chemical oxidation	O <sub>3</sub>	<10,000 mg/l	DP	DP	DP	R	R	DP	A	NI	Catalyst and additional source of energy, e.g., ultraviolet, are important factors.
	H <sub>2</sub> O <sub>2</sub>	A	DP	DP	DP	R	R	DP	A	H	

(continued)

**Adsorption and precipitation**

Process	Parameter										Comments	
	Organic compounds	Inorganic ionic species	Chemical oxidants	Temperature	pH	O&G, mg/l	SS, mg/l	TDS, mg/l	Fe, Mn	MW		Sol
Activated carbon adsorption	<10,000 mg/l	NA	NA	DP	DP	<10	<50	<10	NI	H	L	$K > 5$ mg/g, high $K_{ow}$ , inorganics <1000 mg/l are recommended. Heavy metals may poison the carbon.
Resin adsorption	A	NA	R	DP	DP	<10	<10	DP	NI	DP	M	High $K_{ow}$ and $C_o < 0.1$ (resin capacity/3 BV) are recommended. $K$ is a design parameter.
Chemical precipitation	NA	A	NI	DP	DP	R	NI	DP	A	NI	DP	Chelating and complexing agents interference may occur.

**Membrane processes and ion exchange**

Process	Parameter										Comments	
	Organic compounds	Inorganic ionic species	Chemical oxidants	Temperature	Pressure, psig	pH	O&G, mg/l	SS, mg/l	TDS, mg/l	Fe, Mn		MW, amu
Reverse osmosis	R	A	R	DP	<1500	DP	R	R	<10,000	R	>150	Differential osmotic pressure <400 psi, LSI <0, SDI <5, and turbidity <1 NTU are recommended.
Hyper-filtration	NA	A	NA	NI	DP	DP	R	R	NI	NI	100-500	Molecular size, shape, and flexibility are important factors.

(continued)

Organic compounds

Inorganic

Process	Volatile	Semi-volatile	Inorganic ionic species	Chemical oxidants	Temperature	Pressure, psig	pH	O&G mg/l	SS, mg/l	TDS mg/l	Fe, Mn	MW, amu	Comments
Ultrafiltration	NA	A	NA	NI	DP	10-100	DP	R	R	NI	NI	500-1,000,000	Molecular size, shape, and flexibility are important factors.
Electrodialysis/reverse	R	R	A	R	DP	40-60	DP	R	R	<5000	<0.3	NI	Applied voltage is one of the design parameters. Ca < 900 mg/l is recommended.
Ion exchange resin	R	R	A	R	DP	NI	DP	R	<50 (<35)	<20,000	NI	NI	Selectivity quotient is one of the design parameters. Ion charge and volume are important factors.

- A = applicable
- BV = bed volume
- DP = design parameter
- H = high
- H<sub>C</sub> = Henry's constant
- K = Freundlich isotherm coefficient
- K<sub>ow</sub> = octanol/water partition coefficient
- M = moderate
- MW = molecular weight
- NA = not applicable
- NTU = nephelometric turbidity units
- O&G = oil and grease
- R = must be removed
- SDI = silt density index
- Sol = solubility
- SS = suspended solids
- TDS = total dissolved solids

Note:  
 °C =  $\frac{1}{2} (^{\circ}\text{F} - 32)$   
 kPa = 6.894 psi



TABLE 2.3  
Physical-chemical waste treatment

Treatment method	Type of waste	Mode of operation	Degree of treatment	Remarks
Ion exchange	Plating, nuclear	Continuous filtration with resin regeneration	Demineralized water recovery; product recovery	May require neutralization and solids removal from spent regenerant
Reduction and precipitation	Plating, heavy metals	Batch or continuous treatment	Complete removal of chromium and heavy metals	One day's capacity for batch treatment; 3-h retention for continuous treatment; sludge disposal or dewatering required
Coagulation	Paperboard, refinery, rubber, paint, textile	Batch or continuous treatment	Complete removal of suspended and colloidal matter	Flocculation and settling tank or sludge blanket unit; pH control required
Adsorption	Toxic or organics, refractory	Granular columns of powdered carbon	Complete removal of most organics	Powdered activated carbon (PAC) used with activated sludge process
Chemical oxidation	Toxic and refractory organics	Batch or continuous ozone or catalyzed hydrogen peroxide	Partial or complete oxidation	Partial oxidation to render organics more biodegradable

TABLE 2.4  
Maximum quality attainable from waste treatment processes

Process	BOD	COD	SS	N	P	TDS
Sedimentation, % removal	10-30	—	59-90	—	—	—
Flotation, % removal <sup>†</sup>	10-50	—	70-95	—	—	—
Activated sludge, mg/l	< 25	‡	< 20	§	§	—
Aerated lagoons, mg/l	< 50	—	> 50	—	—	—
Anaerobic ponds, mg/l	> 100	—	< 100	—	—	—
Deep-well disposal	Total disposal of waste	—	—	—	—	—
Carbon adsorption, mg/l	< 2	< 10	< 1	—	—	—
Denitrification and nitrification, mg/l	< 10	—	—	< 5	—	—
Chemical precipitation, mg/l	—	—	< 10	—	< 1	—
Ion exchange, mg/l	—	—	< 1	¶	¶	¶

<sup>†</sup> Higher removals are attained when coagulating chemicals are used.

<sup>‡</sup>  $COD_{\text{ref}} - [BOD_{\text{ult}}(\text{removed})/0.9]$ .

<sup>§</sup>  $N_{\text{ref}} - 0.12$  (excess biological sludge), lb.;  $P_{\text{ref}} - 0.026$  (excess biological sludge), lb.

<sup>¶</sup> Depends on resin used, molecular state, and efficiency desired.

Note: lb = 0.45 kg.

---

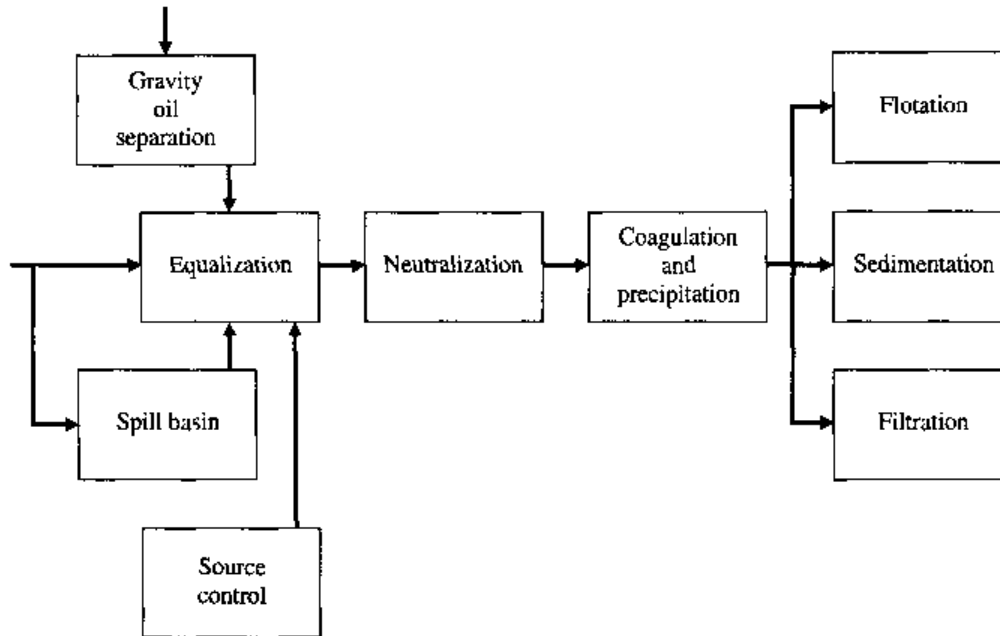
## PRE- AND PRIMARY TREATMENT

---

The objective of pre- and primary treatment is to render a wastewater suitable for discharge to a POTW (publicly owned treatment works) or subsequent biological treatment. The concentrations of pollutants that make prebiological treatment desirable are summarized in Table 3.1. Common pretreatment technologies are shown in Fig. 3.1.

**TABLE 3.1**  
**Concentrations of pollutants that make prebiological treatment desirable**

Pollutant or system condition	Limiting concentration	Kind of pretreatment
Suspended solids	> 125 mg/l	Sedimentation, flotation, lagooning
Oil or grease	> 35	Skimming tank or separator
Toxic ions		Precipitation or ion exchange
Pb	≤ 0.1 mg/l	
Cu + Ni + CN	≤ 1 mg/l	
Cr <sup>+6</sup> + Zn	≤ 3 mg/l	
Cr <sup>+3</sup>	≤ 10 mg/l	
pH	6 to 9	Neutralization
Alkalinity	0.5 lb alkalinity as CaCO <sub>3</sub> /lb BOD removed	Neutralization for excessive alkalinity
Acidity	Free mineral acidity	Neutralization
Organic load variation	> 2:1	Equalization
Sulfides	> 100 mg/l	Precipitation or stripping with recovery
Ammonia	> 500 mg/l (as N)	Dilution, ion exchange, pH adjustment, and stripping
Temperature	> 38°C in reactor	Cooling



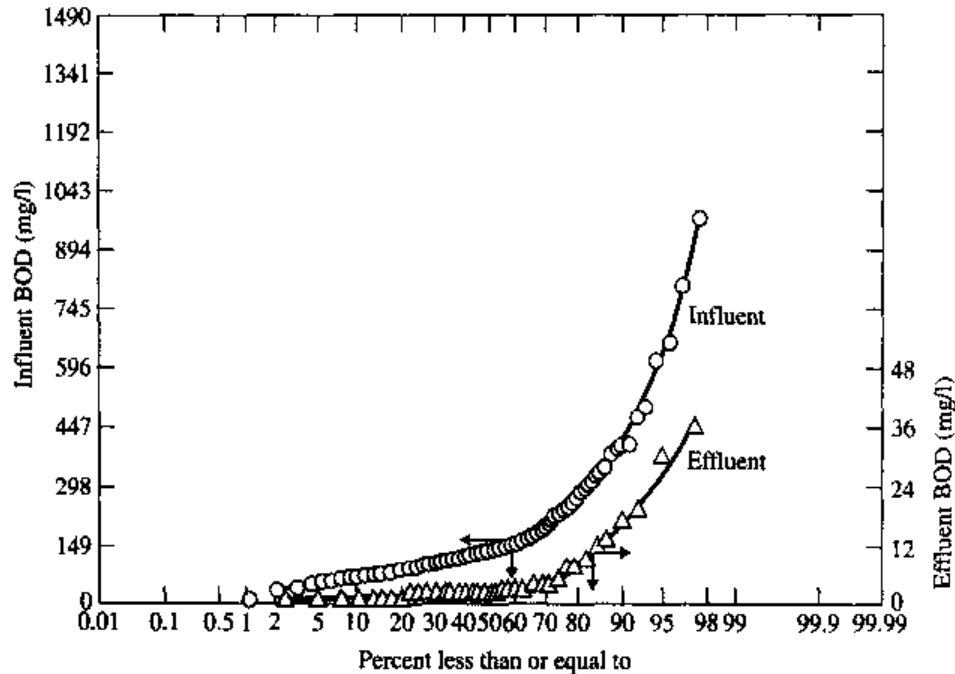
**FIGURE 3.1**  
Pretreatment technologies.

### 3.1 EQUALIZATION

The objective of equalization is to minimize or control fluctuations in wastewater characteristics in order to provide optimum conditions for subsequent treatment processes. The size and type of the equalization basin varies with the quantity of waste and the variability of the wastewater stream. The basin should be of a sufficient size to adequately absorb waste fluctuations caused by variations in plant-production scheduling and to dampen the concentrated batches periodically dumped or spilled to the sewer.

The purposes of equalization for industrial treatment facilities are:

1. To provide adequate dampening of organic fluctuations in order to prevent shock loading of biological systems. The effluent concentration from a biological treatment plant will be proportional to the influent concentration. This is shown in Fig. 3.2, which represents 24-h composited samples over a period of 3 years for a petroleum refinery. As can be seen from Fig. 3.2, the effluent variability tracks the influent variability. If the wastewater is readily degradable an increase in the influent will result in a lesser increase in the effluent due to an increase in biometabolism. By contrast, if the influent contains bioinhibitors, an increased effluent concentration will result.
2. To provide adequate pH control or to minimize the chemical requirements necessary for neutralization.
3. To minimize flow surges to physical-chemical treatment systems and permit chemical feed rates compatible with feeding equipment.



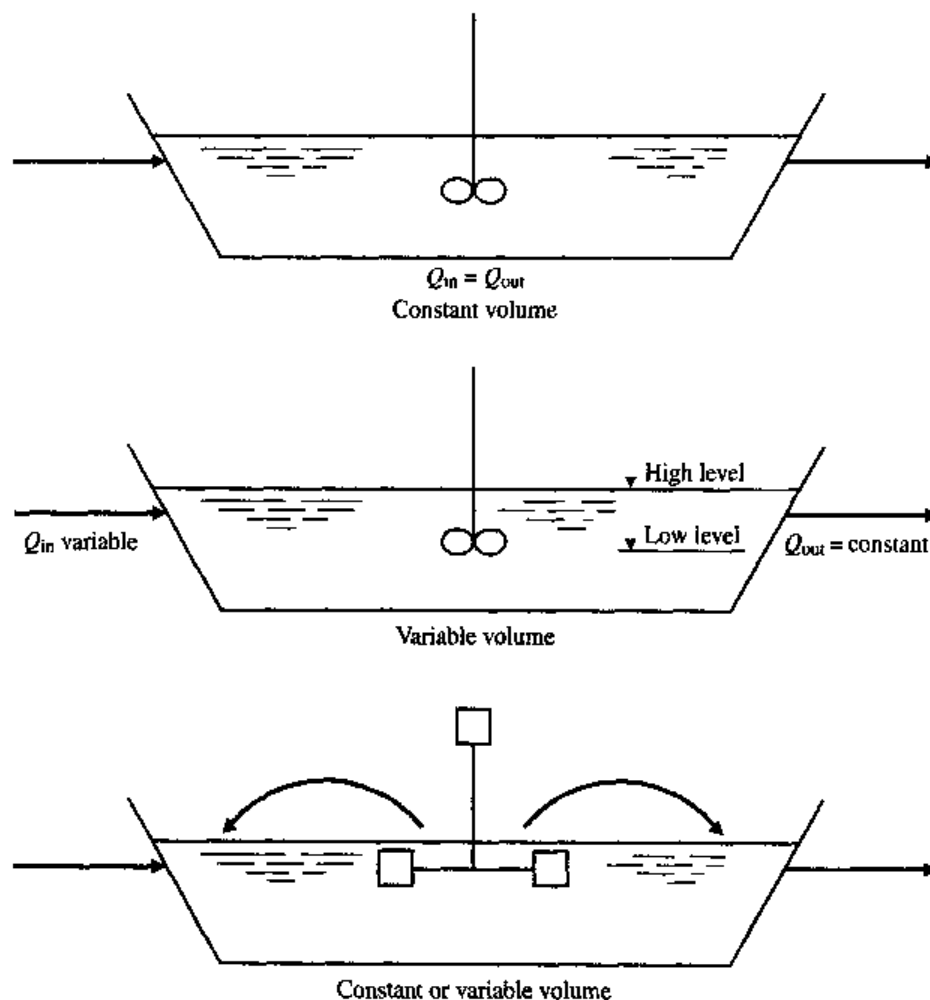
**FIGURE 3.2**  
Variability in influent and effluent BOD.

4. To provide continuous feed to biological systems over periods when the manufacturing plant is not operating.
5. To provide capacity for controlled discharge of wastes to municipal systems in order to distribute waste loads more evenly.
6. To prevent high concentrations of toxic materials from entering the biological treatment plant.

Mixing is usually provided to ensure adequate equalization and to prevent settleable solids from depositing in the basin. In addition, the oxidation of reduced compounds in the wastestream or the reduction of BOD by air stripping may be achieved through mixing and aeration. Methods that have been used for mixing include:

1. Distribution of inlet flow and baffling
2. Turbine mixing
3. Diffused air aeration
4. Mechanical aeration
5. Submerged mixers

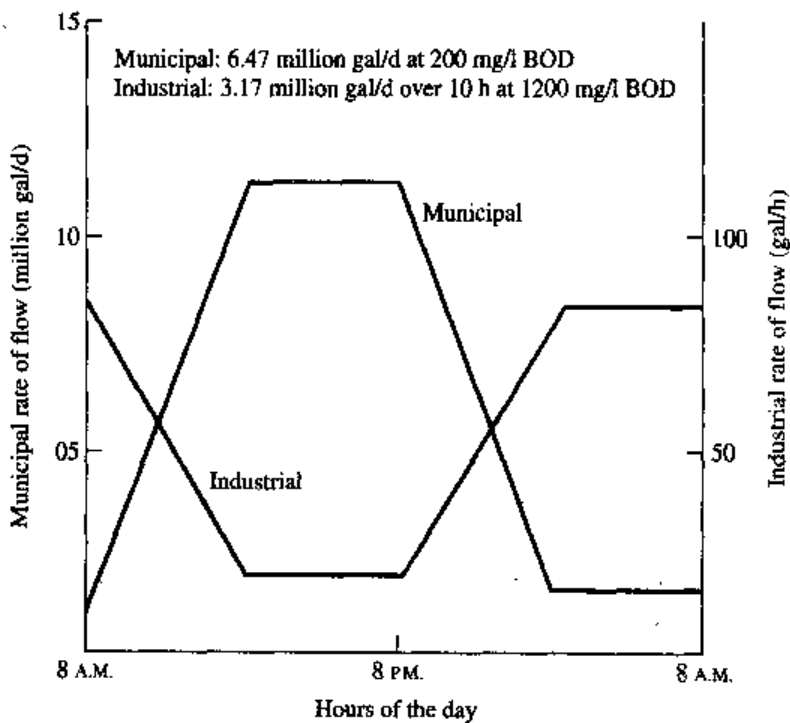
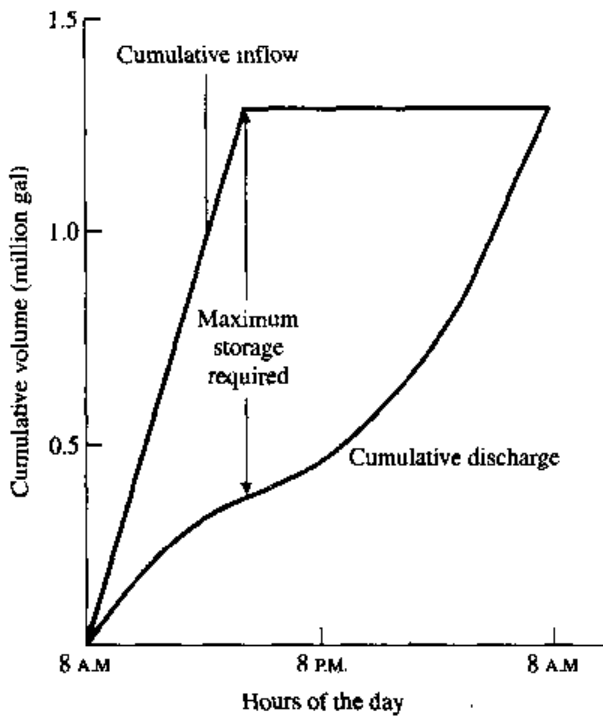
The most common method is to provide submerged mixers or, in the case of readily degradable wastewater, such as that from a brewery, to use surface aerators employing a power level of approximately 15 to 20 hp/million gal (0.003 to 0.0045 kW/m<sup>3</sup>). Air requirements for diffused air aeration are approximately 0.5 ft<sup>3</sup> air/gal waste (3.74 m<sup>3</sup>/m<sup>3</sup>). Equalization basin types are shown in Fig. 3.3.



**FIGURE 3.3**  
Constant-volume and variable-volume equalization basins.

The equalization basin may be designed with a variable volume to provide a constant effluent flow or with a constant volume and an effluent flow that varies with the influent. The variable-volume basin is particularly applicable to the chemical treatment of wastes having a low daily volume. This type of basin may also be used for discharge of wastes to municipal sewers. It may be desirable to program the effluent pumping rate to discharge the maximum quantity of waste during periods of normally low flow to the municipal treatment facility, as shown in Fig. 3.4. Ideally, the organic loading to the treatment plant is maintained constant over a 24-h period.

Equalization basins may be designed to equalize flow, concentration, or both. For flow equalization, the cumulative flow is plotted versus time over the equalization period (for example, 24 h). The maximum volume with respect to the constant-discharge line is the equalization volume required. The required calculations are shown in Example 3.1.



*Note:*  
million gal =  $3.78 \times 10^3 \text{ m}^3$   
million gal/d =  $3.78 \times 10^3 \text{ m}^3/\text{d}$   
gal/h =  $3.78 \times 10^{-3} \text{ m}^3/\text{h}$

**FIGURE 3.4**  
Controlled discharge of an industrial wastewater to a municipal plant.

TABLE 3.2

Time	gal/min	gal	$\Sigma \text{ gal} \times 10^{-3}$
8	50	3,000	3.0
9	92	5,520	8.5
10	230	13,800	22.3
11	310	18,600	40.9
12	270	16,200	57.1
1	140	8,400	65.5
2	90	5,400	70.9
3	110	6,600	77.5
4	80	4,800	82.3
5	150	9,000	91.3
6	230	13,800	105.1
7	305	18,300	123.4
8	380	22,800	146.2
9	200	12,000	158.2
10	80	4,800	163.0
11	60	3,600	166.6
12	70	4,200	170.8
1	55	3,300	174.1
2	40	2,400	176.5
3	70	4,200	180.7
4	75	4,500	185.2
5	45	2,700	187.9
6	55	3,300	191.2
7	35	2,100	193.3

Note:

gal/min =  $3.78 \times 10^{-3} \text{ m}^3/\text{min}$

gal =  $3.78 \times 10^{-3} \text{ m}^3$

**EXAMPLE 3.1.** Given the data in Table 3.2, design an equalization basin for a constant outflow from the basin. The data are plotted as the summation of inflow versus time as shown in Fig. 3.5. The treatment rate is  $(193,300 \text{ gal/day})/(1440 \text{ min/day}) = 134 \text{ gal/min}$  (507 l/min). The required storage volume is 41,000 gal + 8000 gal residual or 49,000 gal (186 m<sup>3</sup>).

The equalization basin may be sized to restrict the discharge to a maximum concentration commensurate with the maximum permissible discharge from subsequent treatment units. For example, if the maximum effluent from an activated sludge unit is 50 mg/l BOD<sub>5</sub>, the maximum effluent from the equalization basin may be computed and thereby provide a basis for sizing the unit.

For the case of near-constant wastewater flow and random input variations that have a normal statistical distribution of wastewater composite analyses, the required equalization retention time is<sup>1</sup>

$$t = \frac{\Delta t(S_i^2)}{2(S_e^2)} \quad (3.1)$$



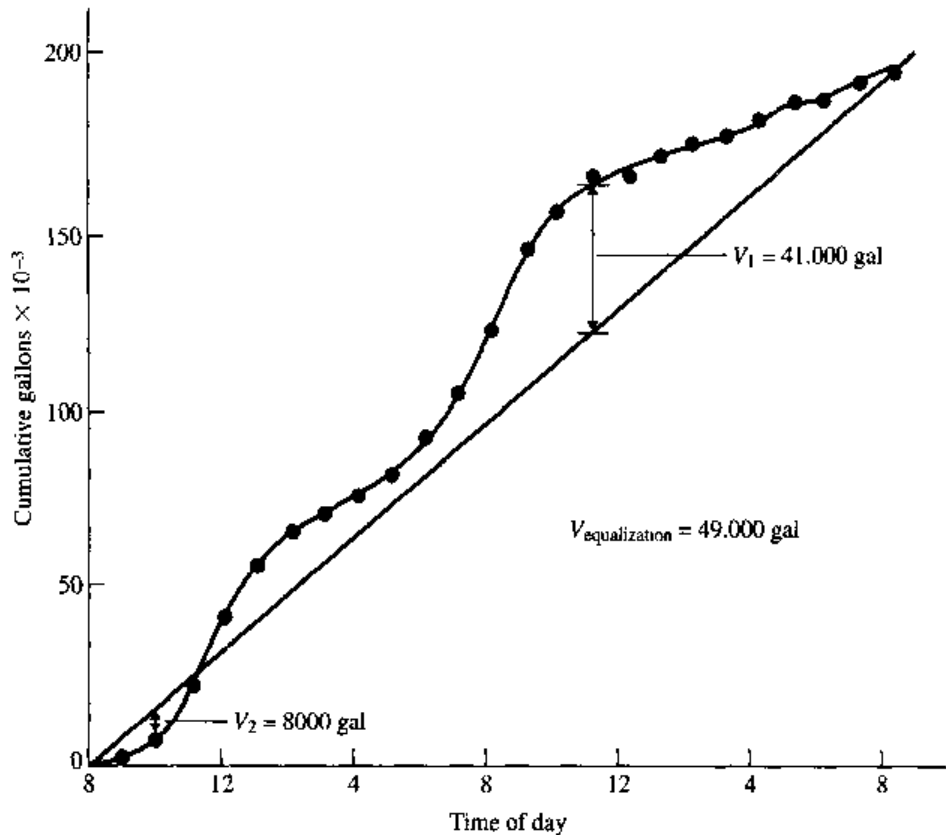


FIGURE 3.5

- where  $t$  = equalization detention time,  $h$   
 $\Delta t$  = time interval over which samples were composited,  $h$   
 $S_i^2$  = variance of the influent wastewater concentration (the square of the standard deviation)  
 $S_e^2$  = variance of the effluent concentration at a specified probability (for example, 99 percent)

Example 3.2 illustrates this calculation.

**EXAMPLE 3.2.** A waste with a total flow of 5 million gal/d (0.22 m<sup>3</sup>/s or 19,000 m<sup>3</sup>/d) was characterized as shown in Fig. 3.6. Extensive data were collected every 4 h for 17 d. The average BOD was 690 mg/l and the maximum value was 1185 mg/l.

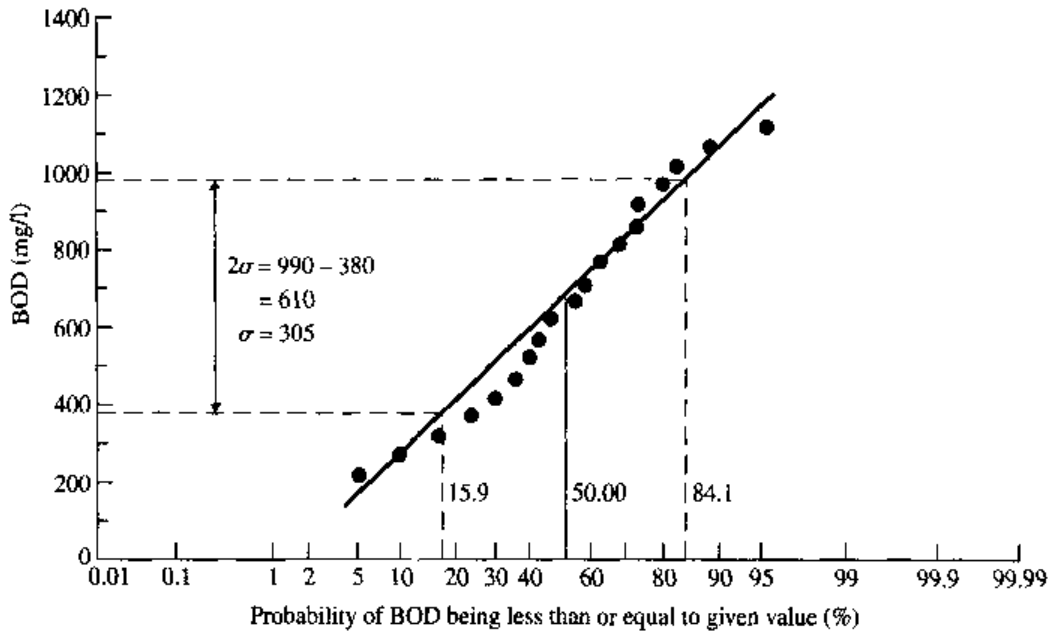
Design calculations with activated sludge systems have indicated that the effluent from the equalization basin must not exceed 896 mg/l in order to meet the effluent quality criteria of an average BOD of 15 mg/l and a maximum concentration of 25 mg/l from the activated sludge system.

Design an equalization basin to meet the desired effluent requirements. Base calculations on a 95 percent probability that the equalized effluent will be equal to or less than 896 mg/l.

**Solution.**

- Calculate the mean, standard deviation, and variance of the influent. These parameters may be calculated graphically from Fig. 3.6.
- From this plot obtain the 50 percent value:

$$50 \text{ percent value} \approx \bar{X} \approx 690 \text{ mg/l}$$



**FIGURE 3.6**

- (c) Calculate the standard deviation,  $S_i$ , as half the difference in the values that occur at the 15.9 (50.0 minus 34.1) and 84.1 (50.0 plus 34.1) percentile levels from Fig. 3.6:

$$\begin{aligned}
 S_i &= \frac{\text{value at 84.1\%} - \text{value at 15.9\%}}{2} \\
 &= \frac{990 - 380}{2} \\
 &= 305 \text{ mg/l}
 \end{aligned}$$

- (d) Calculate the variance as the square of the standard deviation:

$$\begin{aligned}
 S_i^2 &= (305)^2 \\
 &= 93,025 \text{ mg}^2/\text{l}^2
 \end{aligned}$$

- (e) Calculate the standard deviation of the effluent:

$$\begin{aligned}
 \bar{X} &= 690 \text{ mg/l} \\
 X_{\max} &= 896 \text{ mg/l}
 \end{aligned}$$

The necessary condition for 95 percent of effluent BOD values to be less than 896 mg/l is

$$\begin{aligned}
 S_e &= \frac{X_{\max} - \bar{X}}{Z} \\
 &= \frac{896 - 690}{1.65} \\
 &= 125 \text{ mg/l}
 \end{aligned}$$

where  $Z = 1.65$  is from the normal probability tables for a 95 percent confidence level.

(f) Calculate the allowed effluent variance:

$$\begin{aligned} S_e^2 &= (125)^2 \\ &= 15,625 \text{ mg}^2/\text{l}^2 \end{aligned}$$

(g) Calculate the required detention time:

$$\begin{aligned} t &= \frac{\Delta t(S_i^2)}{2(S_e^2)} \\ &= \frac{4(93,025)}{2(15,625)} \\ &= 11.9 \text{ h} \\ &\approx 0.5 \text{ d} \end{aligned}$$

Where a completely mixed basin is to be used for treatment, such as in an activated sludge basin or an aerated lagoon, this volume can be considered as part of the equalization volume. For example, if the completely mixed aeration basin retention time is 8 h and the total required equalization retention time is 16 h, then the equalization basin needs to have a retention time of only 8 h.

Patterson and Menez<sup>2</sup> have developed a method to define equalization requirements when both the flow and the strength vary randomly. A material balance can be established for the equalization basin:

$$C_iQT + C_0V = C_2QT + C_2V \quad (3.2)$$

where  $C_i$  = concentration entering the equalization basin over the sampling interval  $T$

$T$  = sampling interval, i.e., 1 h

$Q$  = average flow rate over the sampling interval

$C_0$  = concentration in the equalization basin at the start of the sampling interval

$V$  = volume of the equalized basin

$C_2$  = concentration leaving the equalization basin at the end of the sampling interval

It is assumed that the effluent concentration is almost constant during one time interval. This is valid, assuming the time intervals are appropriately spaced.

Equation (3.2) can be rearranged to compute the effluent concentration after each time interval:

$$C_2 = \frac{C_iT + C_0V/Q}{T + V/Q} \quad (3.2a)$$

The range of effluent concentrations can then be calculated for a range of equalization volumes  $V$ . A peaking factor PF is computed for the influent strength and flow. The effluent PF for design purposes is the ratio of the maximum concen-

tration to the average concentration. An equalization basin design is shown in Example 3.3.

**EXAMPLE 3.3.** A survey of the discharge from a chemical plant showed the following results:

Time period	Mean	
	Flow gal/min	TOC, mg/l
8 to 10 A.M.	450	920
10 to 12 noon	620	1130
12 to 2 P.M.	840	1475
2 to 4 P.M.	800	1525
4 to 6 P.M.	340	910
6 to 8 P.M.	270	512
8 to 10 P.M.	570	1210
10 to 12 midnight	1100	1520
0 to 2 A.M.	1200	1745
2 to 4 A.M.	800	820
4 to 6 A.M.	510	410
6 to 8 A.M.	570	490

Develop a plot of peaking factor versus basin volume for a variable-volume equalization system and determine the volume to yield a peaking factor of 1.2 based on mass discharge.

**Solution.**

Assuming the equalization basin is a completely mixed basin where no significant degradation or evaporation occurs, the differential equations that govern the constant effluent flow system for each time interval are:

$$\frac{dV_i}{dt} = Q_{0i} - Q_{ei} = Q_{0i} - Q_{0avg} \quad (1)$$

$$\frac{d(V_i C_i)}{dt} = V_i \frac{dC_i}{dt} + C_i \frac{dV_i}{dt} = V_i \frac{dC_i}{dt} + C_i (Q_{0i} - Q_{0avg}) = Q_{0i} C_{0i} - Q_{ei} C_i \quad (2)$$

where  $V_i$  = volume in the basin at time  $t$  for time interval  $i$ , gal  
 $Q_{0i}$  = influent flow rate at time interval  $i$ , gpm  
 $Q_{ei}$  = effluent flow rate at time interval  $i$ , gpm  
 $Q_{0avg}$  = daily average influent flow rate, gpm  
 $C_{0i}$  = influent concentration at time interval  $i$ , mg/l  
 $C_i$  = concentration in the basin and effluent concentration at time  $t$  for time interval  $i$ , mg/l

Assuming that  $Q_{0i}$ ,  $Q_{ei}$ , and  $C_{0i}$  are constant during each time interval, separation of variables, integration, and rearrangement of Eqs. (1) and (2) lead to the following

expressions for the volume  $V_i(f)$  and the TOC concentration  $C_i(f)$  in the basin at the end of each time interval, respectively.

$$V_i(f) = V_{(i-1)}(f) + (Q_{0i} - Q_{0avg})\Delta t_i \quad (3)$$

$$C_i(f) = C_{0i} - \frac{A}{(1 + B\Delta t_i)^D} \quad (4)$$

where

$$A = C_{0i} - C_{(i-1)}(f)$$

$$B = \frac{Q_{0i} - Q_{0avg}}{V_{(i-1)}(f)}$$

$$D = \frac{Q_{0i}}{Q_{0i} - Q_{0avg}}$$

$V_{(i-1)}(f)$  = volume in the basin at the end of time interval  $i - 1$ , gal

$\Delta t_i$  = time interval  $i$ , min

$C_{(i-1)}(f)$  = concentration in the basin and effluent concentration at the end of time interval  $i - 1$ , mg/l

The TOC mass  $M_{ei}(f)$  that left the equalization basin during each time interval can be calculated by

$$M_{ei}(f) = Q_{0avg} \int_0^{\Delta t_i} C_i dt = Q_{0avg} \left[ C_{0i} \Delta t_i - \frac{A[[1 + B\Delta t_i]^{1-D} - 1]}{B(1 - D)} \right] \quad (5)$$

The procedure to developing the spreadsheet to calculate the masses leaving the basin at each time interval for a given volume of basin is:

1. The values for the first time interval (first row in the table below) are calculated as follows:
  - With the mean influent flow and concentration, the influent volume and mass of TOC are calculated.
  - The effluent flow rate, which is the same for all time intervals, is calculated by dividing the total influent volume by the total time.
  - For an initial basin volume (guess), the final volume is calculated by using Eq. (3).
  - For an initial concentration (guess), the final concentration is calculated by using Eq. (4).
  - The mass of TOC that left the basin is calculated by using Eq. (5).
2. The values for the other time intervals are calculated in a similar fashion but the initial volume and concentration for each time interval are the final volume and concentration of the previous time interval.
3. The volume guessed for the first time interval is modified until the maximum initial or final volume in the basin is the selected volume.
4. The concentration guessed for the first time interval is modified until it matches the final concentration for the last time interval.
5. The maximum and average masses leaving the basin are determined and the peaking factor is calculated as the ratio of the maximum to average values.

The results of the calculations for a basin volume of 310,000 gal are presented in the following table. Repetition of the calculations for different volumes allows the plotting of the peaking factor as a function of the basin volume as presented in Fig. 3.7.

## Equalization basin design—Variable volume

Time period	Mean flow, gpm	Mean TOC, mg/l	Influent		Effluent		Basin			
			Volume, gal	TOC, lb	Flow, gpm	TOC, lb	Volume		Concentration	
							Initial gal	Final gal	Initial mg/l	Final mg/l
8 to 10	450	920	54,000	414	672.5	673	278,200	251,500	1009	993
10 to 12	620	1130	74,400	701	672.5	681	251,500	245,200	993	1028
12 to 14	840	1475	100,800	1240	672.5	745	245,200	265,300	1028	1174
14 to 16	800	1525	96,000	1221	672.5	828	265,300	280,600	1174	1278
16 to 18	340	910	40,800	310	612.5	842	280,600	240,700	1278	1225
18 to 20	270	512	32,400	138	672.5	791	240,700	192,400	1225	1125
20 to 22	570	1210	68,400	690	672.5	767	192,400	180,100	1125	1151
22 to 24	1100	1520	132,000	1673	672.5	843	180,100	231,400	1151	1327
0 to 2	1200	1745	144,000	2096	672.5	960	231,400	294,700	1327	1504
2 to 4	800	820	96,000	657	672.5	946	294,700	310,000	1504	1318
4 to 6	510	410	61,200	209	672.5	829	310,000	290,500	1318	1150
6 to 8	570	490	68,400	280	672.5	725	290,500	278,200	1150	1009

Mean = 802 lb

Maximum = 960 lb

Peaking factor 1.20

In most cases with a variable flow, a variable-volume basin will be most effective, as shown in Fig. 3.8. Load balancing for a pharmaceutical wastewater is shown in Fig. 3.9.

When occasional clumps or spills are anticipated, for example, 1 percent of the time, a spill basin with an automatic bypass activated by a monitor should be used, as shown in Fig. 3.10. The spill basin may be required for surges in organics (e.g., TOC), TDS, temperature, or specific toxic compounds.

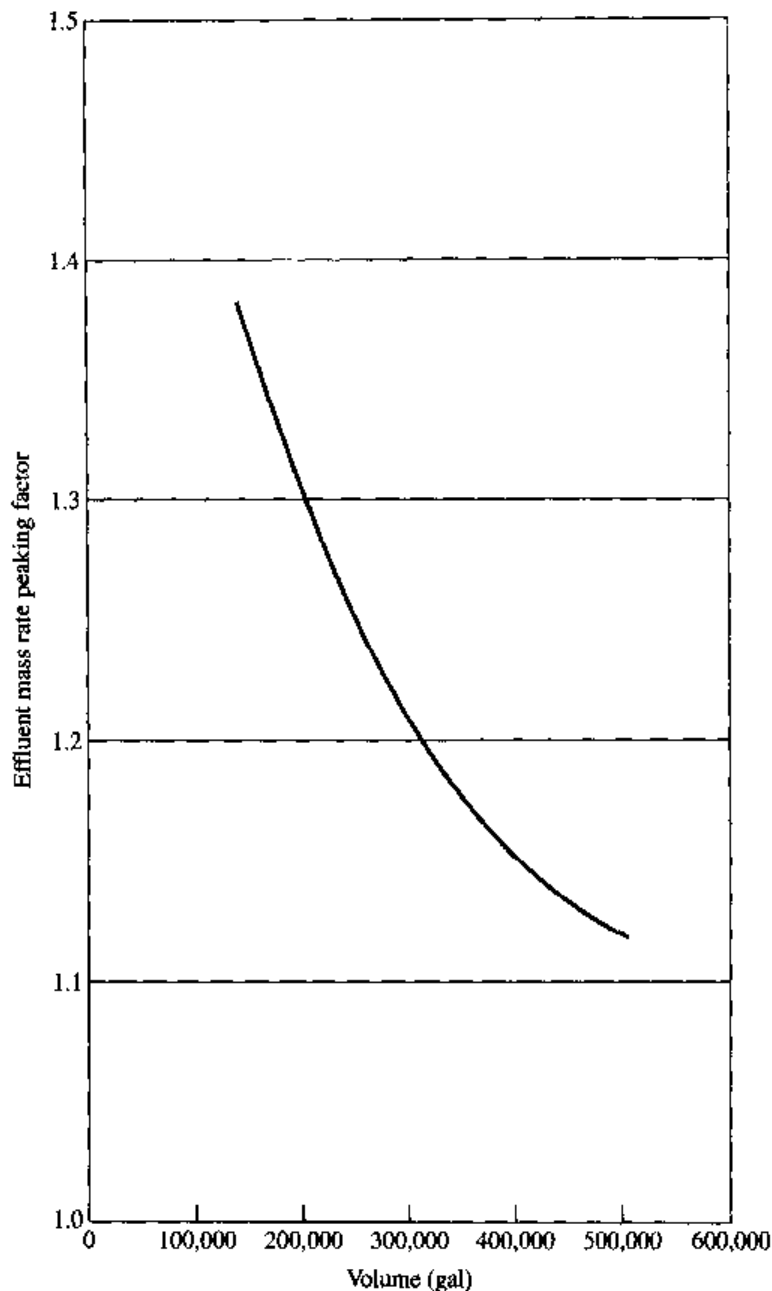
## 3.2 NEUTRALIZATION

Many industrial wastes contain acidic or alkaline materials that require neutralization prior to discharge to receiving waters or prior to chemical or biological treatment. For biological treatment, a pH in the biological system should be maintained between 6.5 and 8.5 to ensure optimum biological activity. The biological process itself provides a neutralization and a buffer capacity as a result of the production of CO<sub>2</sub>, which reacts with caustic and acidic materials. The degree of preneutralization required depends, therefore, on the ratio of BOD removed and the causticity or acidity present in the waste. These requirements are discussed in Chap. 6.

### Types of Processes

#### Mixing Acidic and Alkaline Wastestreams

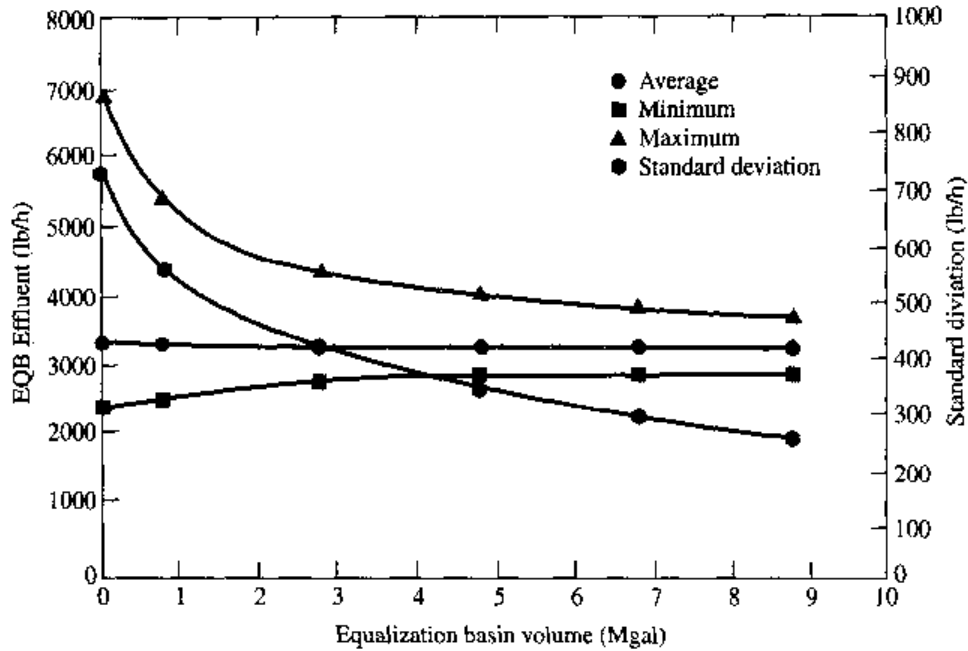
This process requires sufficient equalization capacity to effect the desired neutralization.

**FIGURE 3.7**

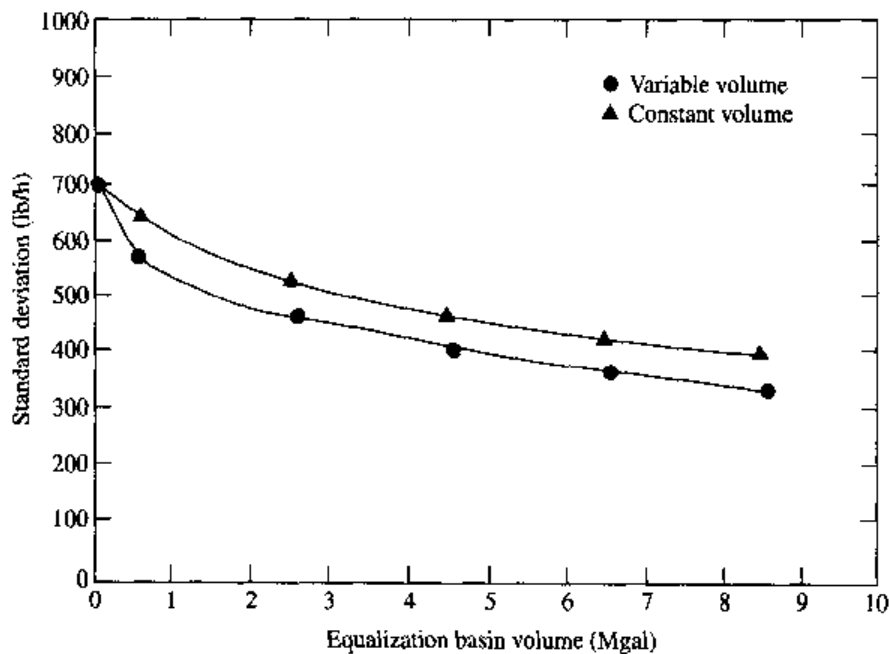
Variation in effluent mass rate peaking factor with basin volume for a variable-volume equalization basin.

### Acid Wastes Neutralization through Limestone Beds

These may be downflow or upflow systems. The maximum hydraulic rate for downflow systems is  $1 \text{ gal}/(\text{min} \cdot \text{ft}^2)$  [ $4.07 \times 10^{-2} \text{ m}^3/(\text{min} \cdot \text{m}^2)$ ] to ensure sufficient retention time. The acid concentration should be limited to 0.6 percent  $\text{H}_2\text{SO}_4$  if  $\text{H}_2\text{SO}_4$  is present to avoid coating of limestone with nonreactive  $\text{CaSO}_4$  and excessive  $\text{CO}_2$  evolution, which limits complete neutralization. High dilution or dolomitic limestone requires longer detention periods to effect neutralization. Hydraulic loading rates can be increased with upflow beds, because the products

**FIGURE 3.8a**

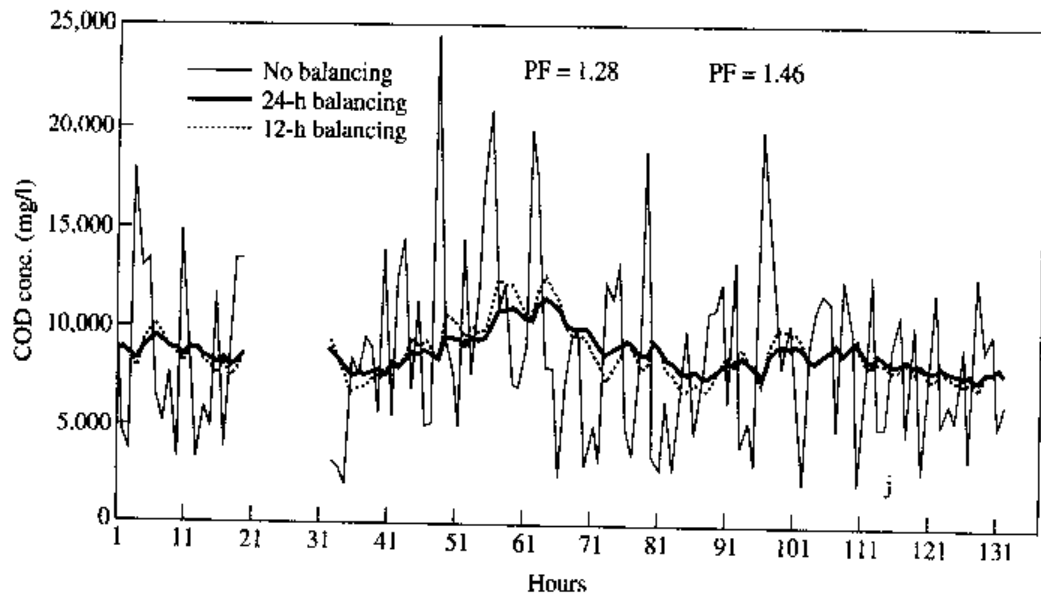
Effect of variable-volume equalization on EQB effluent BOD loading.

**FIGURE 3.8b**

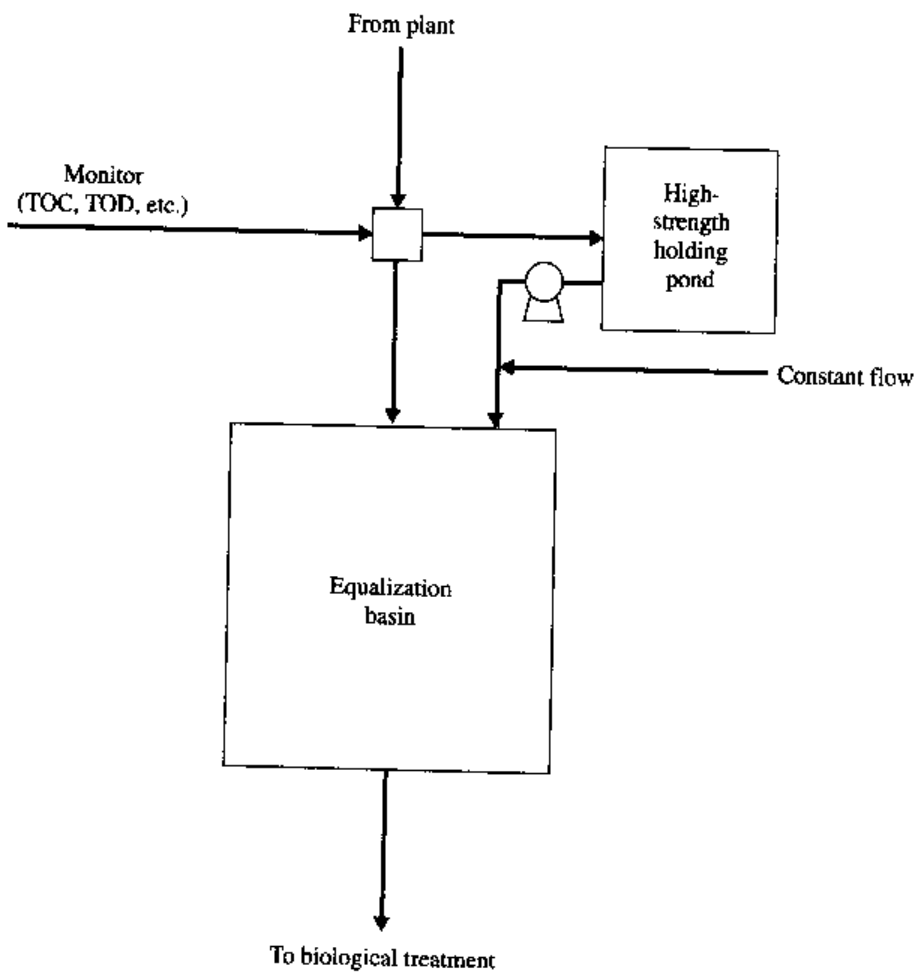
Comparison of variable-volume and constant-volume equalization on EQB effluent BOD loading.

of reaction are swept out before precipitation. Since pH control is related to the bed depth, limestone beds are applicable only to wastewaters in which the influent acidity is relatively constant with time. A limestone bed system is shown in Fig. 3.11. The design of a limestone bed is shown in Example 3.4.

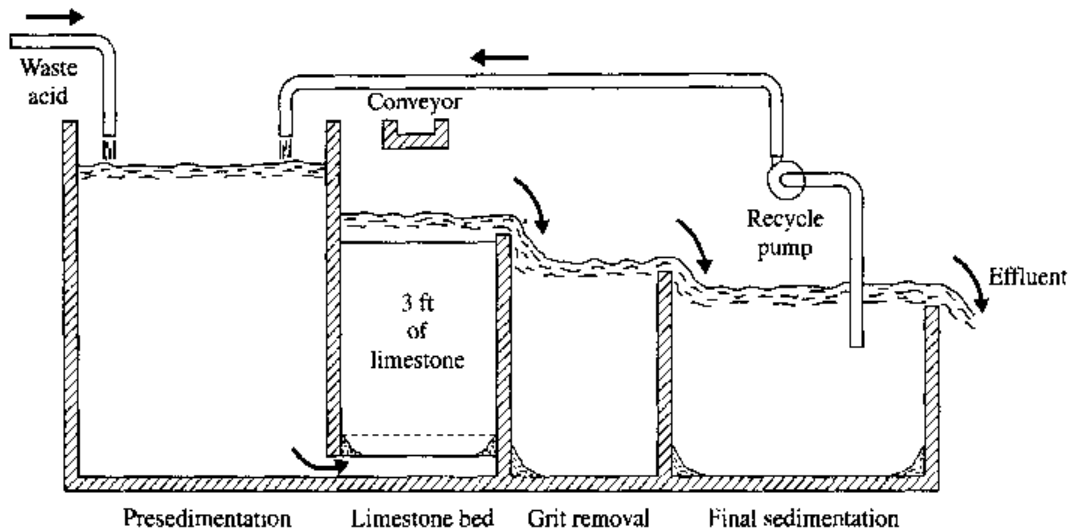




**FIGURE 3.9**  
Load balancing analysis.



**FIGURE 3.10**  
Use of a high-strength holding pond for spills.

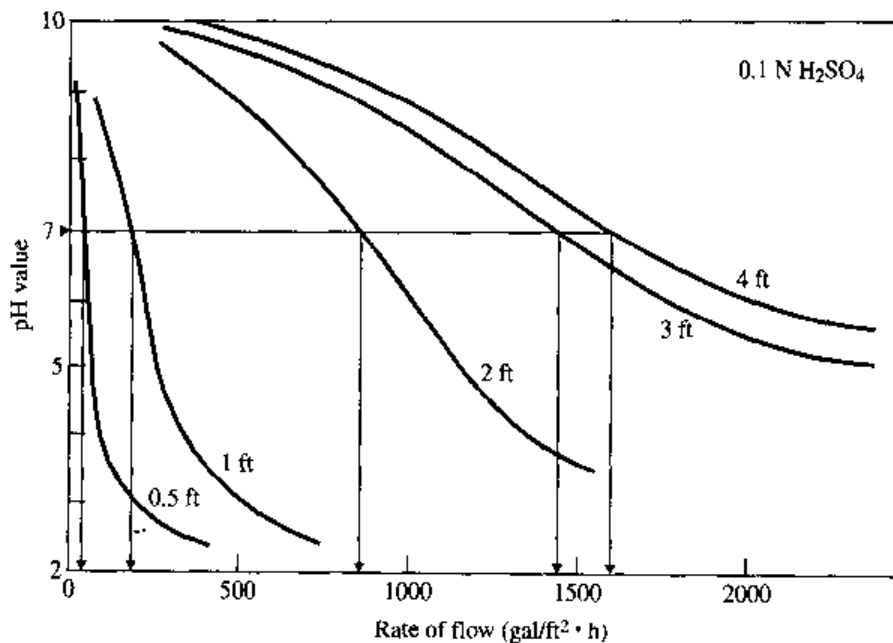


**FIGURE 3.11**  
Simplified flow diagram of limestone neutralization.<sup>3</sup>

**EXAMPLE 3.4.** A wastewater flow of 100 gpm ( $0.38 \text{ m}^3/\text{min}$ ) with  $0.1 \text{ N H}_2\text{SO}_4$  requires neutralization prior to secondary treatment. This flow is to be neutralized to a pH of 7.0 using a limestone bed. Figure 3.12 presents the results of a series of laboratory pilot tests using a 1-foot- (30.5-cm-) diameter limestone bed. These data are for upflow units, with the effluent being aerated to remove residual  $\text{CO}_2$ . Assume limestone is 60 percent reactive.

Design a neutralization system specifying:

- Most economical bed depth of limestone
- Weight of acid per day to be neutralized
- Limestone requirements on an annual basis



Note: ft = 30.5 cm

**FIGURE 3.12**

**Solution.**

- (a) *Most economical bed depth.* Hydraulic loadings to get pH 7.0 with various depths of limestone bed: From the figure the allowable hydraulic loadings are estimated to be:

Depth, ft	0.5	1.0	2.0	3.0	4.0
Hydraulic loading, gal/(ft <sup>2</sup> · h)	42	180	850	1440	1600

Note: ft = 30.5 cm  
gal/(ft<sup>2</sup> · h) = 4.07 × 10<sup>-2</sup> m<sup>3</sup>/(m<sup>2</sup> · h)

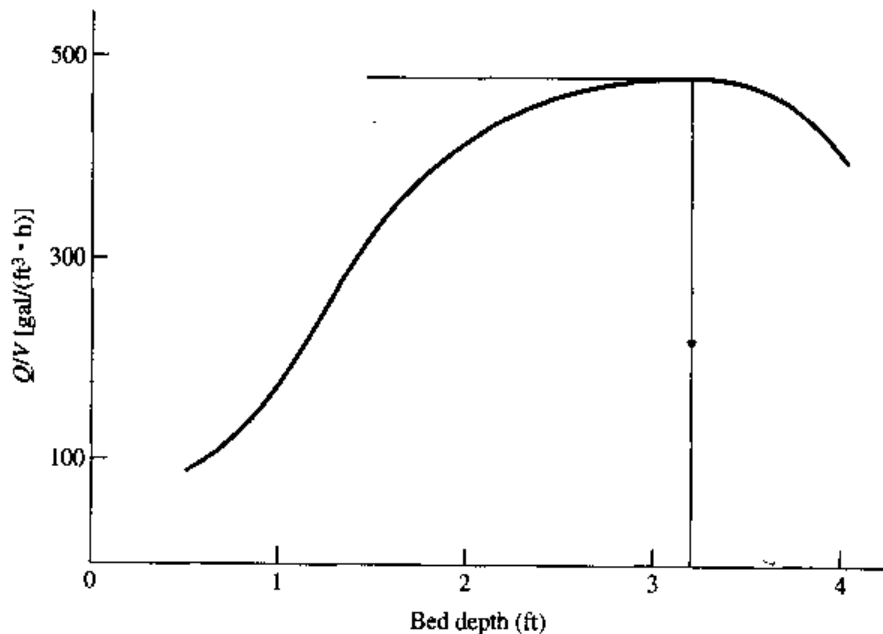
Flow rate per unit limestone volume: The required flow rate per unit volume of bed can be calculated by:

$$Q/V = \frac{\text{hydraulic loading}}{\text{bed depth}}$$

Depth, ft	0.5	1.0	2.0	3.0	4.0
Q/V, gal/(ft <sup>3</sup> · h)	84	180	425	480	400

Note: gal/(ft<sup>3</sup> · h) = 0.134 m<sup>3</sup>/(m<sup>3</sup> · h)

By plotting the flow rate per unit limestone volume against the limestone bed depth, the most economical bed depth of limestone is found to be ≈ 3 ft (0.91 m). This is the depth that gives the maximum flow per unit volume; see Fig. 3.13.



Note: ft = 30.5 cm  
gal/(ft<sup>3</sup> · h) = 0.134 m<sup>3</sup>/(m<sup>3</sup> · h)

**FIGURE 3.13**

(b) *Weight of acid per day to be neutralized.* The weight of acid can be calculated by

$$\frac{100 \text{ gal}}{\text{min}} \times \frac{4900 \text{ mg H}_2\text{SO}_4}{\text{l}} \times \frac{1440 \text{ min}}{\text{day}} \times \frac{8.34 \times 10^{-6} \text{ lb}}{(\text{mg/l}) \text{ gal}}$$

$$= 5890 \text{ lb/d} \quad (2670 \text{ kg/d})$$

(c) *Annual limestone requirements.* The limestone requirements can be calculated by:

$$\frac{5890 \text{ lb}}{\text{d}} \times \frac{50 \text{ g CaCO}_3}{49 \text{ g H}_2\text{SO}_4} \times \frac{365 \text{ d}}{\text{yr}} \times \frac{1 \text{ lb limestone}}{0.60 \text{ lb CaCO}_3}$$

$$= 3,660,000 \text{ lb/yr} \quad (1,660,000 \text{ kg/yr})$$

### Mixing Acid Wastes with Lime Slurries

This neutralization depends on the type of lime used. The magnesium fraction of lime is most reactive in strongly acid solutions and is useful below pH 4.2. Neutralization with lime can be defined by a basicity factor obtained by titration of a 1-g sample with an excess of HCl, boiling 15 min, followed by back titration with 0.5 N NaOH to the phenolphthalein endpoint.

In lime slaking, the reaction is accelerated by heat and physical agitation. For high reactivity, the lime reaction is complete in 10 min. Storage of lime slurry for a few hours before neutralization may be beneficial. Dolomitic quicklime (only the CaO portion) hydrates except at elevated temperature. Slaked quicklime is used as an 8 to 15 percent lime slurry. Neutralization can also be accomplished by using NaOH, Na<sub>2</sub>CO<sub>3</sub>, NH<sub>4</sub>OH, or Mg(OH)<sub>2</sub>.

### Basic (Alkaline) Wastes

Any strong acid can be used effectively to neutralize alkaline wastes, but cost considerations usually limit the choice to sulfuric or possibly hydrochloric acid. The reaction rates are practically instantaneous, as with strong bases.

Flue gases, which may contain 14 percent CO<sub>2</sub>, can be used for neutralization. When bubbled through the waste, the CO<sub>2</sub> forms carbonic acid, which then reacts with the base. The reaction rate is somewhat slower, but is sufficient if the pH need not be adjusted to below 7 to 8. Another approach is to use a spray tower in which the stack gases are passed countercurrent to the waste liquid droplets.

All of the above processes usually work better with the stepwise addition of reagents, i.e., a staged operation. Two stages, with possibly a third tank to even out any remaining fluctuations, are generally optimum.

There are a number of neutralizing agents available. Selection criteria should consider:

- Reaction rate
- Sludge production and disposal
- Safety and ease of handling for addition and storage
- Total cost including chemical feed and feed and storage equipment
- Side reactions, including dissolved salts, scale formation, and heat produced
- The effect of overdosage

The primary neutralizing agents are:

- *Basic agents—strong/weak*
- Lime in various forms—strong
- Caustic soda—strong
- Magnesium hydroxide—medium
- Sodium carbonate—weak
- Sodium bicarbonate—weak
  
- *Acidic agents—strong/weak*
- Sulfuric acid—strong
- Carbon dioxide—weak

The characteristics of typical neutralizing chemicals are shown in Tables 3.3 and 3.4.

### System

Batch treatment is used for waste flows to 100,000 gal/d (380 m<sup>3</sup>/d). Continuous treatment employs automated pH control. Where air is used for mixing, the minimum air rate is 1 to 3 ft<sup>3</sup>/(min · ft<sup>2</sup>) [0.3 to 0.9 m<sup>3</sup>/(min · m<sup>2</sup>)] at 9 ft (2.7 m) liquid depth. If mechanical mixers are used, 0.2 to 0.4 hp/thousand gal (0.04 to 0.08 kW/m<sup>3</sup>) is required.

### Control of Process

The automatic control of pH for wastestreams is one of the most troublesome, for the following reasons:

1. The relation between pH and concentration or reagent flow is highly nonlinear for strong acid–strong base neutralization, particularly when close to neutral (pH 7.0). The nature of the titration curve as shown in Fig. 3.14 favors multi-staging in order to ensure close control of the pH.
2. The influent pH can vary at a rate as fast as 1 pH unit per minute.
3. The wastestream flow rates can double in a few minutes.
4. A relatively small amount of reagent must be thoroughly mixed with a large liquid volume in a short time interval.

Advantage is usually gained by the stepwise addition of chemicals (see Fig. 3.15). In reaction tank 1, the pH may be raised to 3 to 4. Reaction tank 2 raises the pH to 5 to 6 (or any other desired endpoint). If the wastestream is subject to slugs or spills, a third reaction tank may be desirable to effect complete neutralization. Okey et al.<sup>4</sup> have shown an advantage to combining NaOH and NaHCO<sub>3</sub>. NaOH is employed in the first stage and NaHCO<sub>3</sub> in a second stage to provide a buffer and avoid pH swings due to a change in influent characteristics. Neutralization system design parameters are shown in Table 3.5. Acid waste neutralization is shown in Example 3.5.

TABLE 3.3  
Summary of properties for typical neutralization chemicals

Property	Calcium carbonate (CaCO <sub>3</sub> )	Calcium hydroxide (Ca(OH) <sub>2</sub> )	Calcium oxide (CaO)	Hydrochloric acid (HCl)	Sodium carbonate (Na <sub>2</sub> CO <sub>3</sub> )	Sodium hydroxide (NaOH)	Sulfuric acid (H <sub>2</sub> SO <sub>4</sub> )
Available form	Powder, crushed (various sizes)	Powder, granules	Lump, pebble, ground	Liquid	Powder	Solid flake, ground flake, liquid	Liquid
Shipping container	Bags, barrel, bulk	Bags (50 lb), <sup>†</sup> bulk	Bags (80 lb), barrels, bulk	Barrels, drums, bulk	Bags (100 lb), bulk	Drum (735, 100, 450 lb)	Carboys, drums (825 lb), bulk
Bulk weight, lb/ft <sup>3</sup>	Powder 48 to 71; crushed 70 to 100	25 to 50	40 to 70	27.9%, 0.53 lb/gal <sup>‡</sup> ; 31.45%, 9.65 lb/gal	34 to 62	Varies	106, 114
Commercial strength	—	Normally 13% Ca(OH) <sub>2</sub>	75 to 99%, normally 90% CaO	27.9, 31.45, 35.2%	99.2%	98%	60° Be, 77.7%; 66° Be, 93.2%
Water solubility, lb/gal	Nearly insoluble	Nearly insoluble	Nearly insoluble	Complete	0.58 @ 32°F; 1.04 @ 50°F; 1.79 @ 68°F; 3.33 @ 86°F	3.5 @ 32°F; 4.3 @ 50°F; 9.1 @ 68°F; 9.2 @ 86°F	Complete
Feeding form	Dry slurry used in fixed beds	Dry or slurry	Dry or slurry [must be slaked to Ca(OH) <sub>2</sub> ]	Liquid	Dry, liquid	Solution	Liquid
Feeding type	Volumetric pump	Volumetric metering pump	Dry-volumetric, wet slurry (centrifugal pump)	Metering pump	Volumetric feeder, metering pump	Metering pump	Metering pump
Accessory equipment	Slurry tank	Slurry tank	Slurry tank, slaker	Dilution tank	Dissolving tank	Solution tank	—
Suitable handling materials	Iron, steel	Iron, steel, plastic, rubber hose	Iron, steel, plastic, rubber hose	Hastelloy A, selected plastic and rubber types	Iron, steel	Iron, steel	—
Comments	—	—	Provide means for cleaning slurry transfer pipes	—	Can cake	Dissolving solid forms generate much heat	Provide for spill cleanup and neutralization

<sup>†</sup>lb × 0.4536 = kg  
<sup>‡</sup>lb/gal × 0.1198 = kg/l  
<sup>§</sup>0.555 (°F - 32) = °C

TABLE 3.4  
Neutralization factors for common alkaline and acid reagents

Chemical	Formula	Equivalent weight	To neutralize 1 mg/l acidity or alkalinity (expressed as CaCO <sub>3</sub> ) requires <i>n</i> mg/l	Neutralization factor, assuming 100% purity for all compounds
<b>Basicity</b>				
Calcium carbonate	CaCO <sub>3</sub>	50	1.000	1.000/0.56 = 1.786
Calcium oxide	CaO	28	0.560	0.560/0.56 = 1.000
Calcium hydroxide	Ca(OH) <sub>2</sub>	37	0.740	0.740/0.56 = 1.321
Magnesium oxide	MgO	20	0.403	0.403/0.56 = 0.720
Magnesium hydroxide	Mg(OH) <sub>2</sub>	29	0.583	0.583/0.56 = 1.041
Dolomitic quicklime	(CaO) <sub>0.6</sub> (MgO) <sub>0.4</sub>	24.8	0.497	0.497/0.56 = 0.888
Dolomitic hydrated lime	[Ca(OH) <sub>2</sub> ] <sub>0.6</sub> [Mg(OH) <sub>2</sub> ] <sub>0.4</sub>	33.8	0.677	0.677/0.56 = 1.209
Sodium hydroxide	NaOH	40	0.799	0.799/0.56 = 1.427
Sodium carbonate	Na <sub>2</sub> CO <sub>3</sub>	53	1.059	1.059/0.56 = 1.891
Sodium bicarbonate	NaHCO <sub>3</sub>	84	1.680	1.680/0.56 = 3.00
<b>Acidity</b>				
Sulfuric acid	H <sub>2</sub> SO <sub>4</sub>	49	0.980	0.980/0.56 = 1.750
Hydrochloric acid	HCl	36	0.720	0.720/0.56 = 1.285
Nitric acid	HNO <sub>3</sub>	62	1.260	1.260/0.56 = 2.250
Carbonic acid	H <sub>2</sub> CO <sub>3</sub>	31	0.620	0.620/0.56 = 1.107

**EXAMPLE 3.5.** A wastewater (100 gal/min) (0.38 m<sup>3</sup>/min) is highly acidic and requires neutralization prior to secondary treatment. This flow is to be neutralized to a pH of 7.0 by lime. The titration curve for the wastewater is shown in Fig. 3.14, from which a two-stage control neutralization system will be used with a total lime consumption of 2250 mg/l. The first stage requires 2000 mg/l and the second stage 250 mg/l.

The average lime dosage in the first stage is

$$(100 \text{ gal/min})(1440 \text{ min/d})(8.34 \text{ lb/million gal/mg/l})(2000 \text{ mg/l}) \\ \times 10^{-6} \text{ (million gal/gal)} = 2400 \text{ lb/d (1090 kg/d)}$$

The average lime dosage in the second stage is

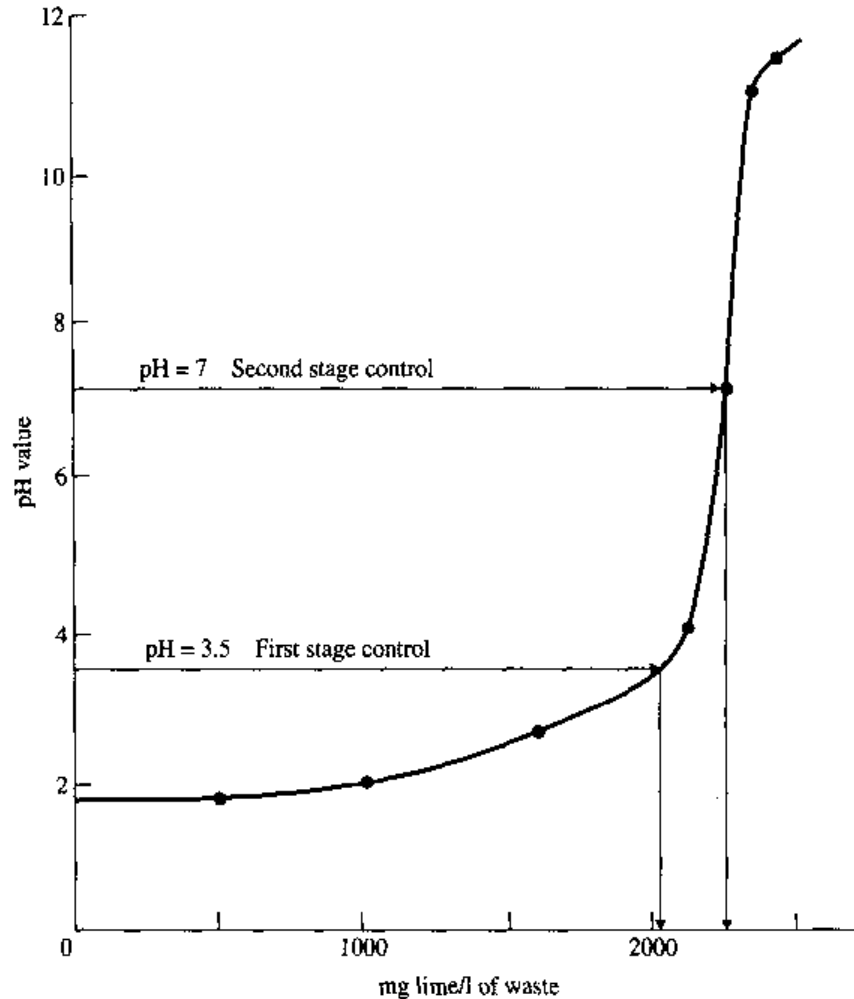
$$100 \times 1440 \times 8.34 \times 250 \times 10^{-6} = 300 \text{ lb/d (140 kg/d)}$$

The average lime dosage is 2700 lb/d (1.35 ton/d) (1230 kg/d). With this dosage and type of lime each basin should be designed with a detention time of 5 min.

$$\text{Volume} = 100 \text{ gal/min} \times 5 \text{ min} = 500 \text{ gal (1.9 m}^3\text{)}$$

Use two tanks, 4.6 ft (1.40 m) diameter  $\times$  4.1 ft (1.25 m) deep, so that diameter and depth are approximately equal.

To maintain proper mixing in the reactor tanks, the power level required for 5 min detention time,  $D/T = 0.33$ , is 0.2 hp/thousand gal (40 W/m<sup>3</sup>) (Fig. 3.16). Use 0.1-hp (75-W) mixers in each reaction tank.



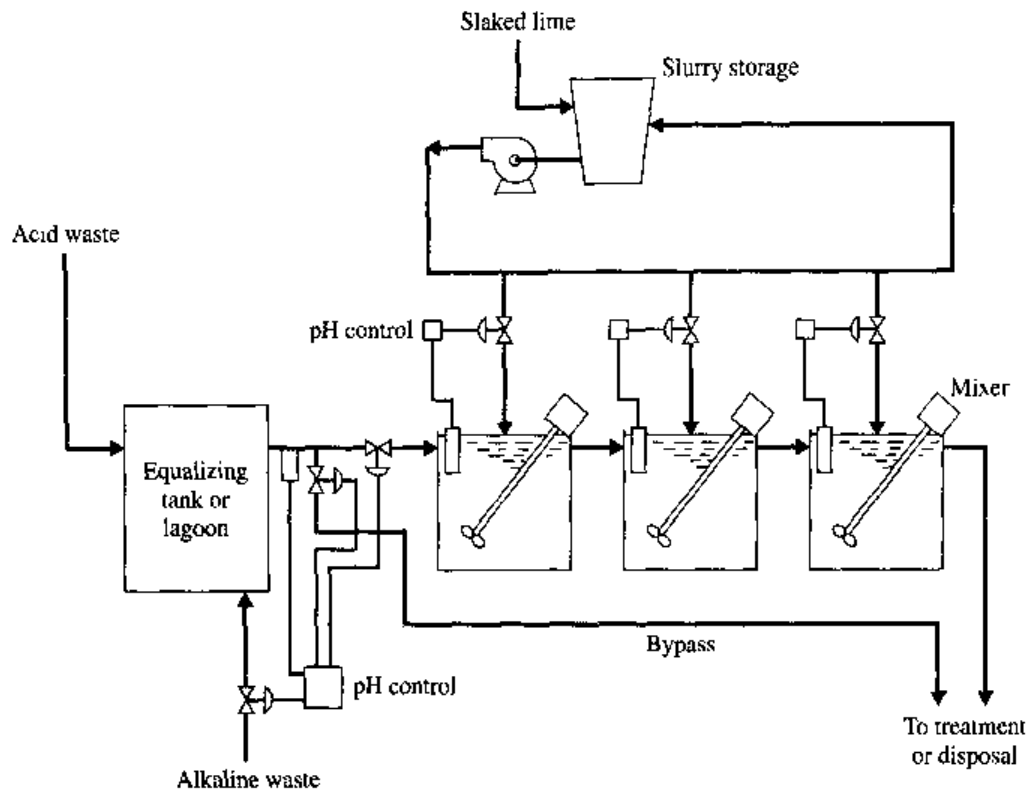
**FIGURE 3.14**  
Lime-waste titration curve for strong acid.

Either one or two standard wall baffles,  $180^\circ$  apart, and one-twelfth to one-twentieth of the width of the tank diameter, located 24 in (61 cm) from the periphery of the impeller, are recommended for this operation.

### 3.3 SEDIMENTATION

Sedimentation is employed for the removal of suspended solids from wastewaters. The process can be considered in three basic classifications, depending on the nature of the solids present in the suspension: discrete, flocculent, and zone settling. In discrete settling, the particle maintains its individuality and does not change in size, shape, or density during the settling process. Flocculent settling occurs when the particles agglomerate during the settling period with a resulting change in size and settling rate. Zone settling involves a flocculated suspension which forms a lattice structure and settles as a mass, exhibiting a distinct interface during the settling process. Compaction of the settled sludge occurs in all sedimentation but will be considered separately under thickening.





**FIGURE 3.15**  
Multistage neutralization process.

**TABLE 3.5**  
**Neutralization system design parameters**

Chemical storage tank	Liquid—use stored supply vessel Dry—dilute in a mix or day tank
Reaction tank:	
Size	Cubic or cylindrical with liquid depth equal to diameter
Retention time	5 to 30 min (lime—30 min)
Influent	Locate at tank top
Effluent	Locate at tank bottom
Agitator:	
Propeller type	Under 1000-gal tanks
Axial-flow type	Over 1000-gal tanks
Peripheral speeds	12 ft/s for large tanks 25 ft/s for tanks less than 1000 gal
pH sensor	Submersible preferred to flow-through type
Metering pump or control valve	Pump delivery range limited to 10 to 1; valves have greater ranges.

The selection of neutralizing will depend on availability, chemical cost, and feeding methods.

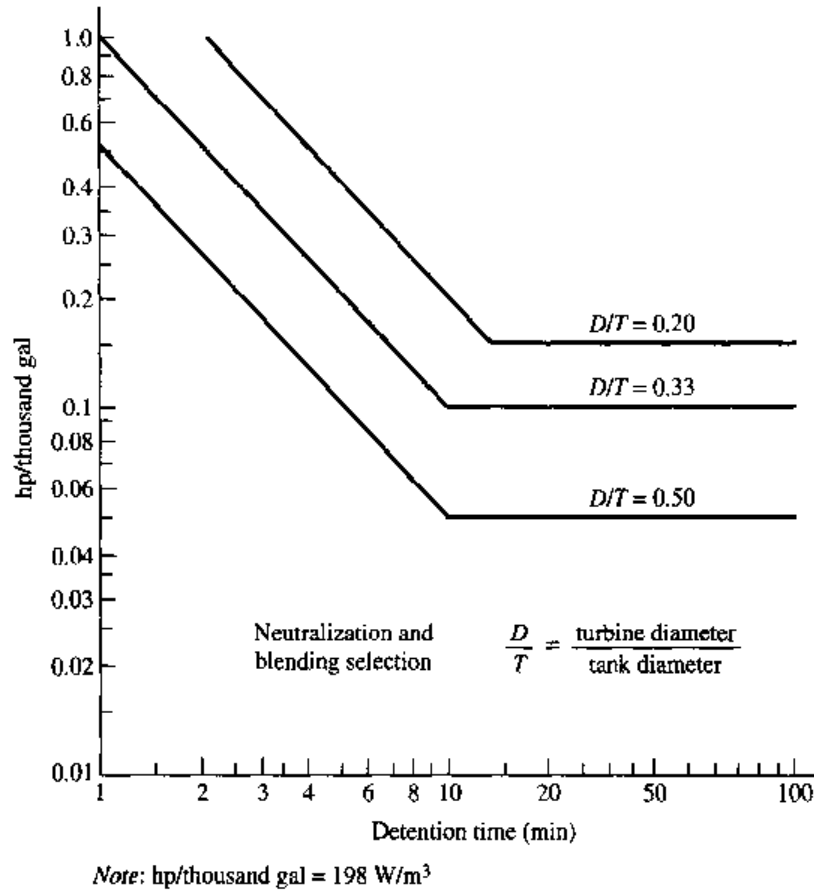


FIGURE 3.16

### Discrete Settling

A particle will settle when the impelling force of gravity exceeds the inertia and viscous forces. The terminal settling velocity of a particle is defined by the relationship

$$v = \sqrt{\frac{4g(\rho_s - \rho_l)D}{3C_d\rho_l}} \quad (3.3)$$

where

- $\rho_l$  = density of the fluid
- $\rho_s$  = density of the particle
- $v$  = terminal settling velocity of the particle
- $D$  = diameter of the particle
- $C_d$  = drag coefficient, which is related to the Reynolds number and particle shape
- $g$  = acceleration due to gravity

When the Reynolds number is small, i.e., less than 1.0 (small particles at low velocity), the viscous forces are predominant and

$$C_d = \frac{24}{N_{Re}} \quad (3.4)$$

where

$$N_{Re} = \frac{vD\rho_l}{\mu} \quad (3.5)$$

$\rho_l$  and  $\mu$  are the density and viscosity of the liquid, respectively. Substitution of Eq. (3.4) in Eq. (3.3) yields Stokes' law:

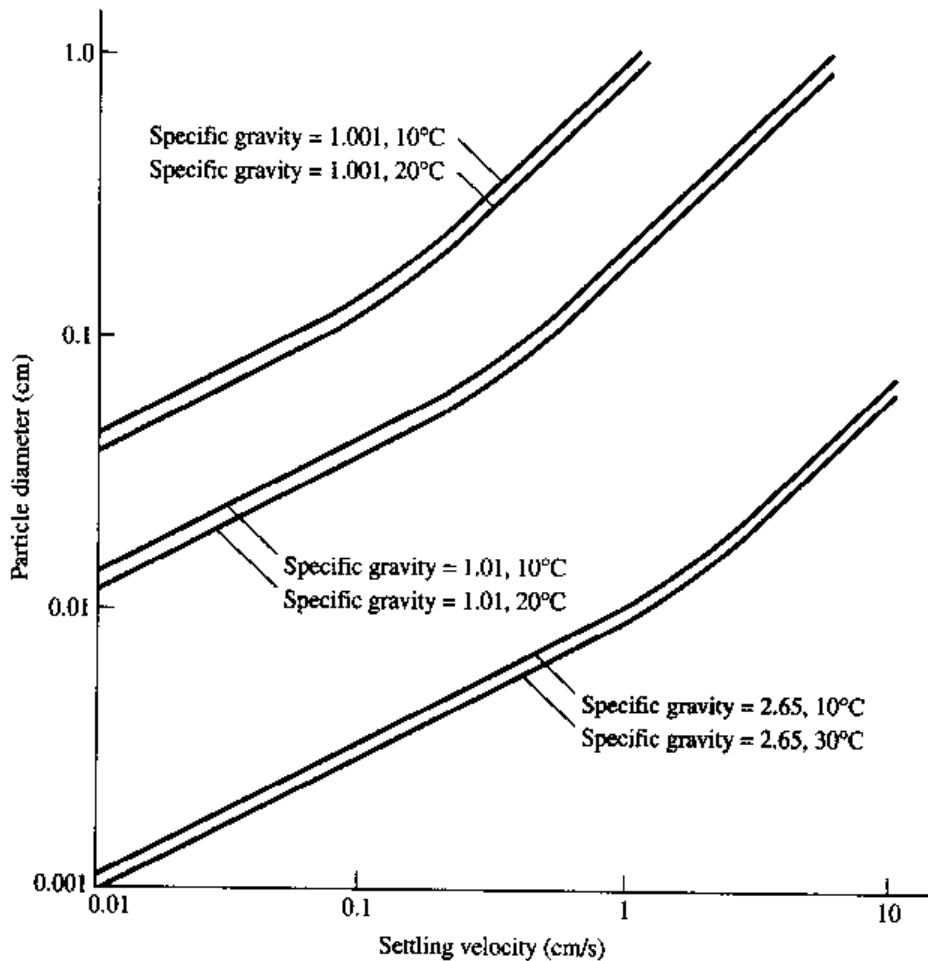
$$v = \frac{\rho_s - \rho_l}{18\mu} gD^2 \quad (3.6)$$

As the Reynolds number increases, a transition zone occurs in which both inertia and viscous forces are effective. This occurs over a Reynolds number range of 1 to 1000, where

$$C_d = \frac{18.5}{N_{Re}^{0.6}} \quad (3.7)$$

Above a Reynolds number of 1000, viscous forces are not significant and the coefficient of drag is constant at 0.4.

The settling velocities of discrete particles, as related to diameter and specific gravity, are shown in Fig. 3.17.



**FIGURE 3.17**  
Settling properties of discrete particles.

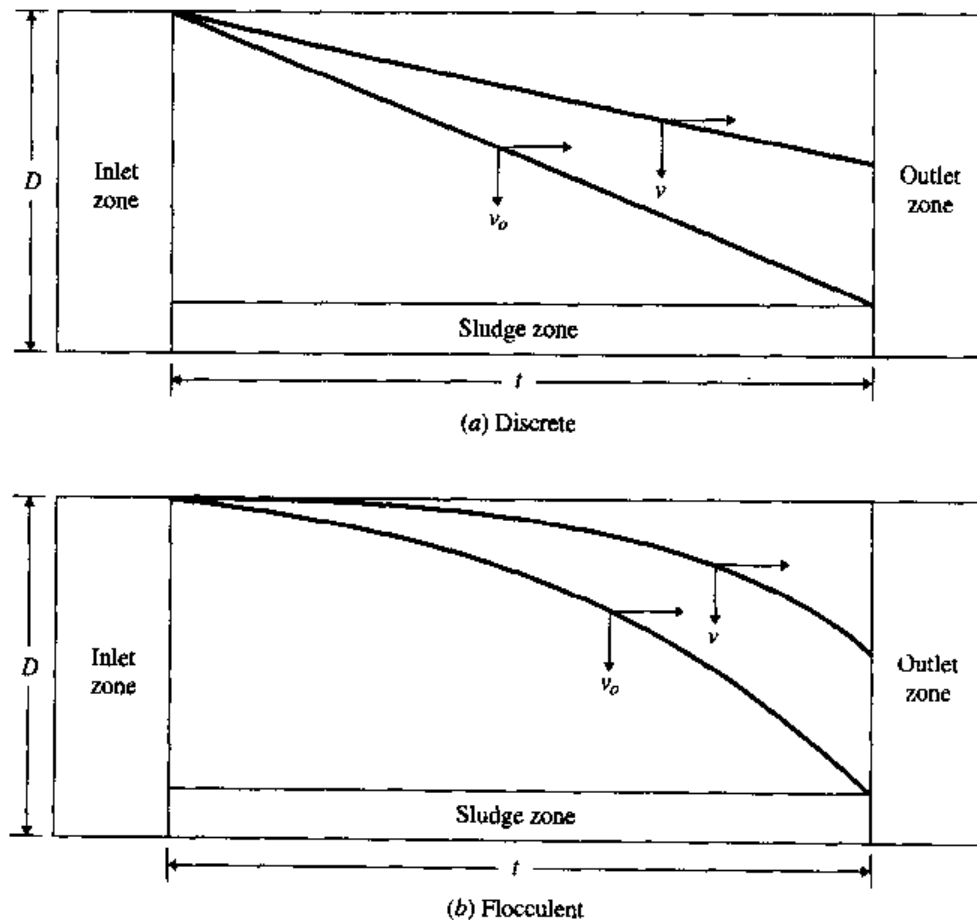
Hazen<sup>5</sup> and Camp<sup>6</sup> developed relationships applicable to the removal of discrete particles in an ideal settling tank, based on the premises that the particles entering the tanks are uniformly distributed over the influent cross section and that a particle is considered removed when it hits the bottom of the tank. The settling velocity of a particle that settles through a distance equal to the effective depth of the tank in the theoretical detention period can be considered as an overflow rate:

$$v_o = \frac{Q}{A} \quad (3.8)$$

where  $Q$  = rate of flow through the tank and  $A$  = tank surface area. All particles with settling velocities greater than  $v_o$  will be completely removed, and particles with settling velocities less than  $v_o$  will be removed in the ratio  $v/v_o$ , as shown in Fig. 3.18. The removal of discrete particles is independent of tank depth and is a function only of the overflow rate.

When the suspension to be removed has a wide range of particle sizes, the total removal is defined by the relationship

$$\text{Total removal} = (1 - f_o) + \frac{1}{v_o} \int_0^{f_o} v \, df \quad (3.9)$$



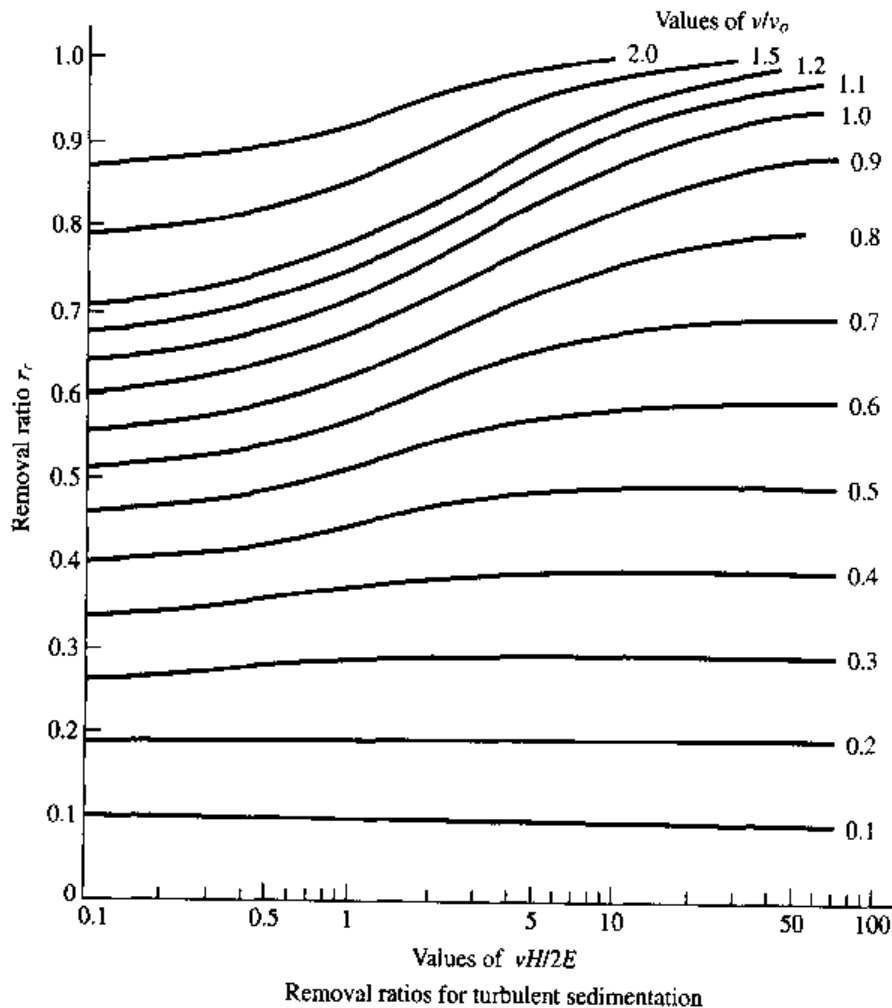
**FIGURE 3.18**  
Ideal settling tank.

where  $f_o$  is the fraction of particles having a settling velocity equal to or less than  $v_o$ . Equation (3.9) must usually be solved by graphical integration to obtain the total removal.

The foregoing analysis is based on the performance of an ideal settling tank under quiescent conditions. In practice, however, short circuiting, turbulence, and bottom scour will affect the degree of solids removal. Dobbins<sup>7</sup> and Camp<sup>6</sup> have developed a relationship to compensate for the decrease in removals caused by turbulence (Fig. 3.17). Figure 3.19 shows the effect of turbulence in reducing the removal ratio of particles having a settling velocity  $v$  from the theoretical value of  $v/v_o$ , where  $v_o$  refers to the overflow rate. The ratio  $vH/2E$  is a parameter of turbulent intensity, where  $H$  is the depth and  $E$  is a coefficient of turbulent transport. For narrow channels, Camp has shown the ratio to be equal to  $122v/V$ , where  $V$  is the average channel velocity.

Scour occurs when the flow-through velocity is sufficient to resuspend previously settled particles; it is defined by the relationship:

$$v_c = \sqrt{\frac{8\beta}{f} gD (S - 1)} \quad (3.10)$$



**FIGURE 3.19**

Effect of turbulence on the subsidence of particles (after Dobbins<sup>7</sup>).

- where  $v_c$  = velocity of scour  
 $\beta$  = constant (0.04 for ungranular sand, 0.06 for nonuniform sticky material)  
 $f$  = Weisbach-D'Arcy friction factor, 0.03 for concrete  
 $S$  = particle specific gravity  
 $g$  = acceleration due to gravity

Scour is usually not a problem in large settling tanks but can occur in grit chambers and narrow channels.

### Flocculent Settling

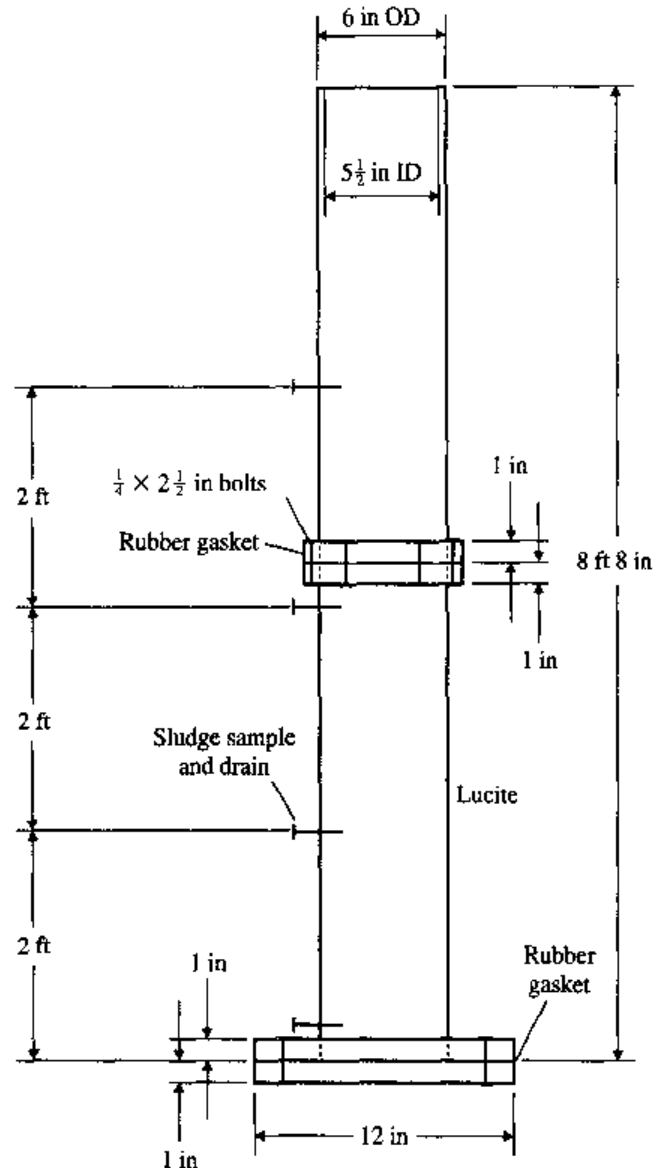
Flocculent settling occurs when the settling velocity of the particle increases as it settles through the tank depth, because of coalescence with other particles. This increases the settling rate, yielding a curvilinear settling path, as shown in Fig. 3.18*b*. Most of the suspended solids in industrial wastes are of a flocculent nature. For discrete particles, the efficiency of removal is related only to the overflow rate, but when flocculation occurs, both overflow rate and detention time become significant.

Since a mathematical analysis is not possible in the case of flocculent suspensions, a laboratory settling analysis is required to establish the necessary parameters. The laboratory settling study can be conducted in a column of the type shown in Fig. 3.20. A minimum diameter of 5 in (12.7 cm) is recommended to minimize wall effects. Taps are located at 2-ft (0.61-m) depth intervals.

The concentration of suspended solids must be uniform at the start of the test; sparging air into the bottom of the column for a few minutes will accomplish this. It is also essential that the temperature be maintained constant throughout the test period to eliminate settling interference by thermal currents. Suspended solids are determined on samples drawn off at selected time intervals up to 120 min. The data collected from the 2- (0.61-), 4- (1.22-), and 6-ft (1.83-m) depth taps are used to develop the settling rate-time relationships.

The results obtained are expressed in terms of percent removal of suspended solids at each tap and time interval. These removals are then plotted against their respective depths and times, as shown in Fig. 3.21. Smooth curves are drawn connecting points of equal removal. The curves thus drawn represent the limiting or maximum settling path for the indicated percent; i.e., the specified percent suspended solids will have a net settling velocity equal to or greater than that shown, and would therefore be removed in an ideal settling tank of the same depth and detention time. The calculation of removal can be illustrated from the data of Fig. 3.21.

The overflow rate  $v_o$  is the effective depth, 6 ft (1.83 in), divided by the time required for a given percent to settle this distance. All particles having a settling velocity equal to or greater than  $v_o$  will be 100 percent removed. Particles with a lesser settling velocity  $v$  will be removed in the proportion  $v/v_o$ . For example, referring to Figure 3.21*a*, at a detention period of 60 min and a 6-ft (1.83-m) settling depth [ $v_o = 6 \text{ ft/h}$  (1.83 m/h)], 50 percent of the suspended solids are completely removed; that is, 50 percent of the particles have a settling velocity equal to or greater than 6 ft/h (1.83 m/h). Particles in each additional 10 range will be removed



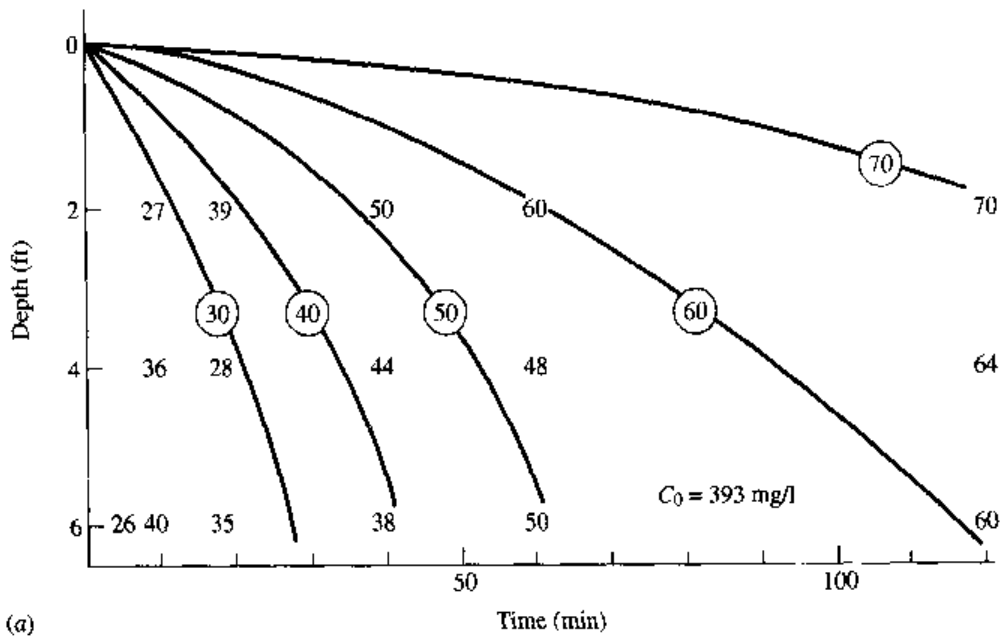
Note:  
 in = 2.54 cm  
 ft = 30.48 cm

**FIGURE 3.20**

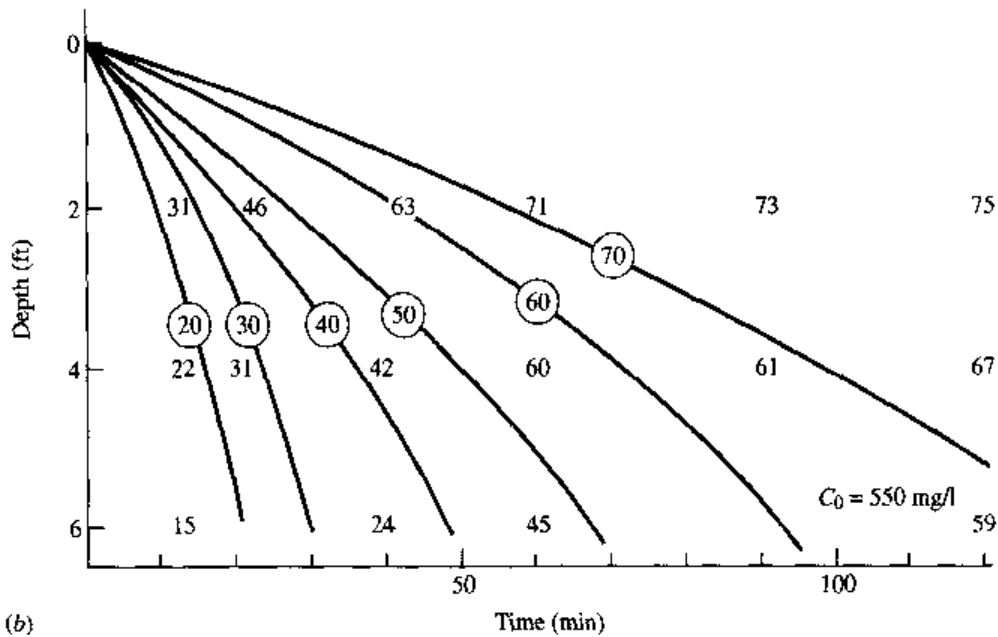
Laboratory settling column for the evaluation of flocculent settling.

in the proportion  $w/v_o$ , or in the proportion to the average depth settled to the total depth of 6 ft (1.83 m). The average depth to which the 50 to 60 percent range has settled in Fig. 3.21*b* is 3.8 ft (1.16 m). The percent removal of this fraction is therefore 3.8 ft/6.0 ft (1.16 m/1.83 m), or 63 percent of the 10 percent. Each subsequent percent range is computed in a similar manner, and the total removal developed as shown in Table 3.6.

The total removal of suspended solids of 62.4 percent can be accomplished at an overflow rate of 6 ft/h = 1080 gal/(d · ft<sup>2</sup>) [44 m<sup>3</sup>/(d · m<sup>2</sup>)] at a retention period of 60 min. In a similar manner various percent removals and their associated overflow rates and detention periods can be computed.



(a)



(b)

Note: ft = 0.3048 m

**FIGURE 3.21**  
Flocculent settling relationships.

**TABLE 3.6**  
Percent ranges for total removal of suspended solids

SS range, %	$d/d_0$	SS removal, %
0-50	1.0	50
50-60	0.64	6.4
60-70	0.25	2.5
70-100	0.05	1.5
Total removal		62.4



Since the degree of flocculation is influenced by the initial concentration of suspended solids, settling tests should be run over the anticipated range of suspended solids in the influent waste. In many wastes, a fraction of the measured suspended solids is not removed by settling, so the curves developed from the laboratory analysis will approach the removal as a limit.

Since the data obtained from the laboratory analysis represent ideal settling conditions, criteria for prototype design must account for the effects of turbulence, short circuiting, and inlet and outlet losses. The net effect of these factors is a decrease in the overflow rate and an increase in the detention time over that derived from the laboratory analysis. As a general rule, the overflow rate will be decreased by a factor of 1.25 to 1.75, and the detention period increased by a factor of 1.50 to 2.00. The development of these relationships is shown in Example 3.6.

**EXAMPLE 3.6.** Laboratory data were obtained on the settling of a paper mill waste (Table 3.7). Design a settling tank to produce a maximum effluent suspended solids of 150 mg/l.

**Solution.**

With the values given in Table 3.7, Fig. 3.21 can be drawn and Table 3.8 can be constructed by calculating the percent removal, the velocity, and the overflow rate of different times as indicated above.

By plotting the SS removal versus overflow rate and time, Figs. 3.22 and 3.23 can be drawn.

From Figs. 3.22 and 3.23:

For 393 mg/l:

$$\text{Percent removal} = \frac{393 - 150}{393} \times 100 = 62$$

$$\text{Overflow rate} = 770 \text{ gal}/(\text{d} \cdot \text{ft}^2) [31.4 \text{ m}^3/(\text{d} \cdot \text{m}^2)]$$

$$\text{Detention time} = 74 \text{ min}$$

For 550 mg/l:

$$\text{Percent removal} = \frac{550 - 150}{550} \times 100 = 73$$

$$\text{Overflow rate} = 540 \text{ gal}/(\text{d} \cdot \text{ft}^2) [22.0 \text{ m}^3/(\text{d} \cdot \text{m}^2)]$$

$$\text{Detention time} = 104 \text{ min}$$

Design:

$$\text{Overflow rate} = \frac{540}{1.5} = 360 \text{ gal}/(\text{d} \cdot \text{ft}^2) [14.7 \text{ m}^3/(\text{d} \cdot \text{m}^2)]$$

$$\text{Detention time } t = \frac{104 \text{ min}}{60 \text{ min/h}} \times 1.75 = 3 \text{ h}$$

For 1 million gal/d:

$$\text{Area } A = \frac{\text{flow}}{\text{overflow rate}} = \frac{10^6 \text{ gal/d}}{360 \text{ gal}/(\text{d} \cdot \text{ft}^2)} = 2780 \text{ ft}^2 (258 \text{ m}^2)$$

$$\text{Effective depth} = \frac{t \times \text{flow}}{A}$$

$$\begin{aligned}
 &= \frac{3 \text{ h} \times 10^6 \text{ gal/d}}{2780 \text{ ft}^2} \times \frac{0.134 \text{ ft}^3/\text{gal}}{24 \text{ h/d}} \\
 &= 6 \text{ ft (1.8 m)}
 \end{aligned}$$

**TABLE 3.7**  
**Settling data**

Removal, %			
Time, min	2 ft	4 ft	6 ft
<b>Initial solids, 393 mg/l</b>			
5			26
10	27	36	40
20	39	28	35
40	50	44	38
60	60	48	50
120	70	64	60
<b>Initial solids, 550 mg/l</b>			
15	31	22	15
20	46	31	
40	63	42	24
60	71	60	45
90	73	61	
120	75	67	59

Note: ft = 30.48 cm

**TABLE 3.8**

Time, min	Velocity, ft/h	Removal of SS, %	Overflow rate, gal/(d · ft <sup>2</sup> )
<b>C<sub>0</sub> = 393 mg/l</b>			
27.5	13.1	41.6	2360
42.0	8.6	49.5	1550
62.0	5.8	57.3	1050
115.0	3.1	65.8	560
<b>C<sub>0</sub> = 550 mg/l</b>			
20	18.0	36.7	3250
27	13.3	46.8	2400
47	7.7	56.5	1400
66	5.4	62.5	980
83	3.8	70.8	690

Note:

ft/h = 0.305 m/h

gal/(d · ft<sup>2</sup>) = 4.07 × 10<sup>-2</sup> m<sup>3</sup>/(d · m<sup>2</sup>)

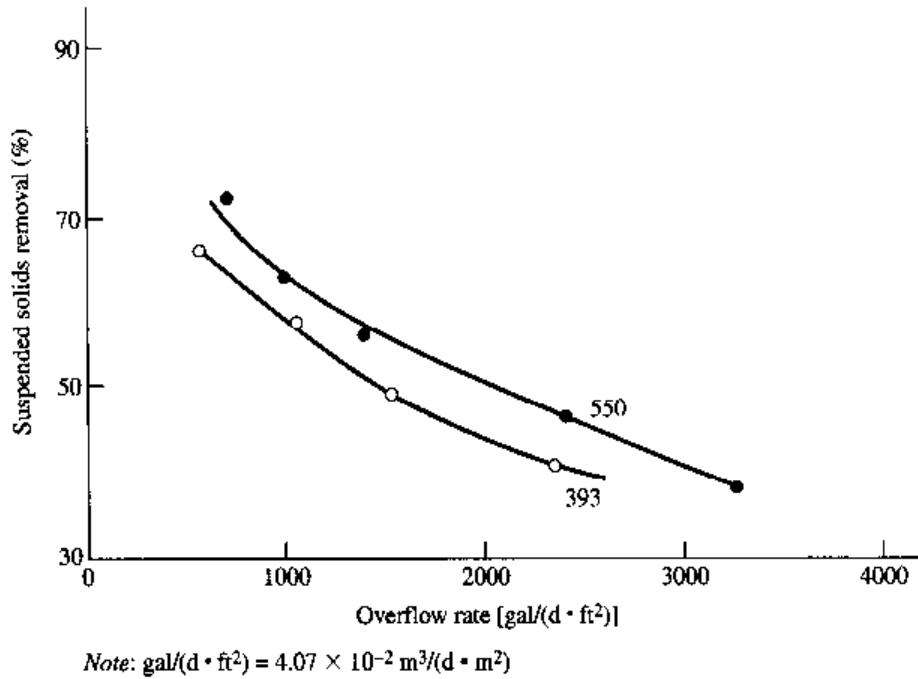


FIGURE 3.22

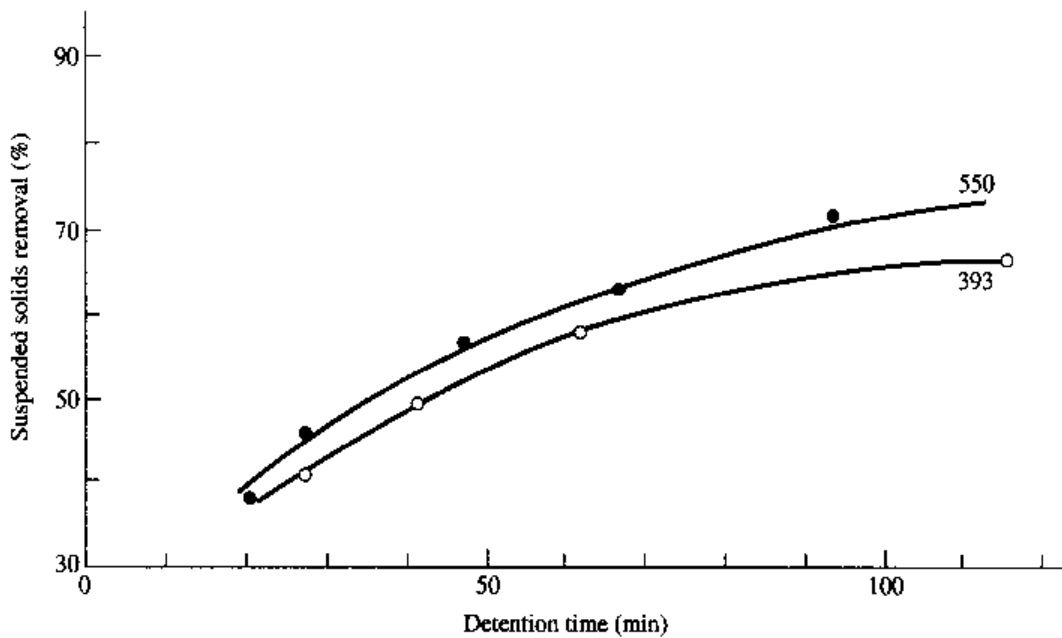


FIGURE 3.23

The sedimentation performances for various pulp and paper-mill wastes are summarized in Table 3.9.

Tanning wastewaters<sup>9</sup> with an initial suspended solids of 1200 mg/l showed 69 percent reduction with a retention period of 2 h. BOD removals of 86.9 percent were obtained from the settling of cornstarch wastes.<sup>10</sup>

The effect of the initial concentration of suspended solids on the sedimentation efficiency of a pulpwood waste is shown in Fig. 3.24.

TABLE 3.9  
Settling characteristics of pulp and paper-mill wastes<sup>a</sup>

Type of waste	Flow, million gal/day	Raw SS, ppm	Raw BOD, ppm	Temperature, °F	Removal %		Detention time, h	OR, gal/(d · ft <sup>2</sup> )
					SS	BOD		
Paperboard	4.5	2,500	450	85	90	67	5.35	504
	0.75	136		85	90	50	1.15	940
	1.36	10,000	360	62	85	24	5.40	430
	2.5	1,185	395		96.1	19	5.3	525
	31	524	195	110	42	25	9.4	438
	30	850	250	95	80	25	0.5	1910
	3.3	2,000		90	85		2.6	1028
	0.25	50	100	100	80	25	4.5	39
	0.301	1,150	250	110	98	50		90
	35	4,000	200	100	90	10-15	1.5	374
Specialty	9.4	203	97	81	94	86	2.56	832
	2.2	6,215	120	120		90	1.5	157
	1.8	665	620	95	91	58	0.5	406
	50	120	85	100	80	16	18.2	477
Fine paper	6	200		65	95	90	3.9	695
	6.0	254	235	90	50	34	2.2	890
	9.9	500	364	70-100	90	35	2.4	1120
	3.5	300	250	65	95	48	6.0	372
	7.5-9.0	560	126	65	80	42	4.0	670
Miscellaneous	7	430	250	70	70	20	1.8	505
	14	1,000	330	73	65	60		911
	25	75	100		90	0.0	6.9	17
	17	100	425		95	50	5.9	846
	0.5	200	200	85	90		1.9	1590
	1.0	1,000	900	100		95	2.9	509

Note:

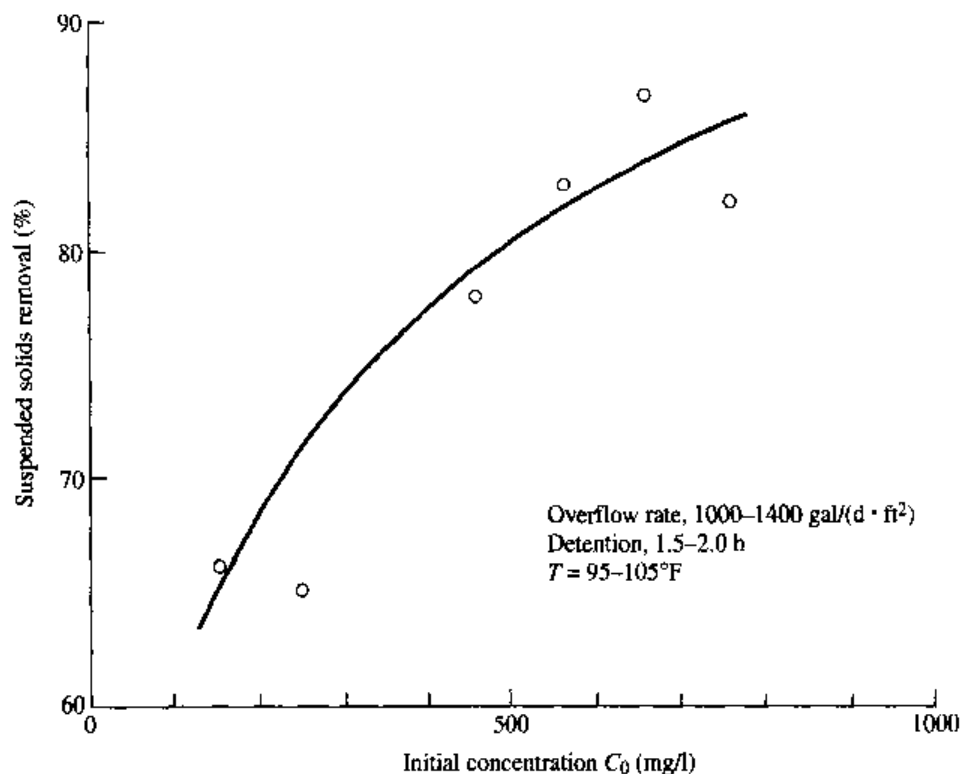
million gal/d =  $3.75 \times 10^3$  m<sup>3</sup>/d

°C =  $\frac{5}{9}$ (°F - 32)

gal/(d · ft<sup>2</sup>) =  $4.07 \times 10^{-2}$  m<sup>3</sup>/(d · m<sup>2</sup>)

## Zone Settling

Zone settling is characterized by activated sludge and flocculated chemical suspensions when the concentration of solids exceeds approximately 500 mg/l. The floc particles adhere together and the mass settles as a blanket, forming a distinct interface between the floc and the supernatant. The settling process is distinguished by



Note:

$$\text{gal}/(\text{d} \cdot \text{ft}^2) = 4.07 \times 10^{-2} \text{ m}^3/(\text{d} \cdot \text{m}^2)$$

$$^{\circ}\text{C} = \frac{5}{9} (^{\circ}\text{F} - 32)$$

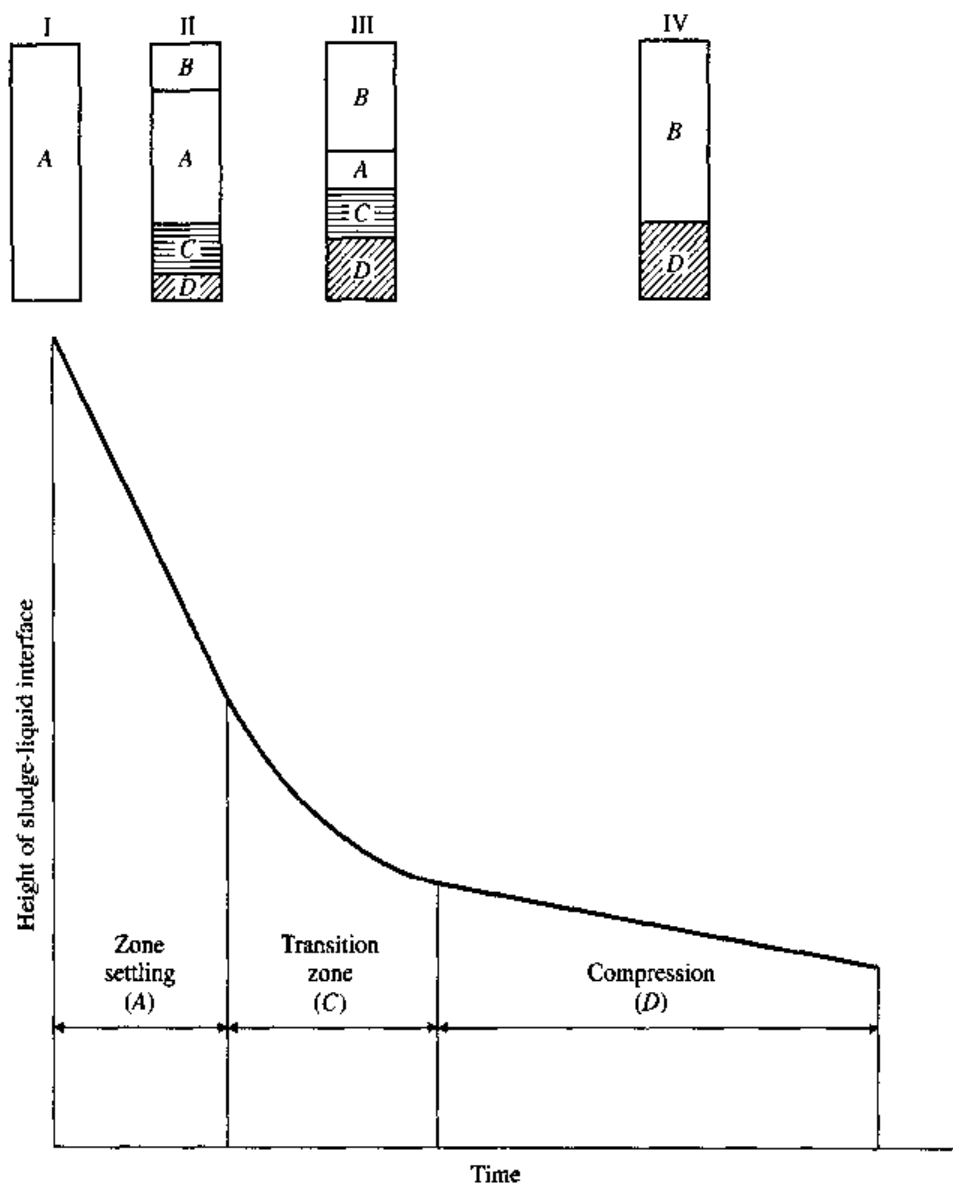
**FIGURE 3.24**

Effect of initial suspended solids concentration on percent removal from a pulp and paper-mill wastewater.

four zones, as shown in Fig. 3.25. Initially, all the sludge is at a uniform concentration, *A* in Fig. 3.25.

During the initial settling period the sludge settles at a uniform velocity. The settling rate is a function of the initial solids concentration *A*. As settling proceeds, the collapsed solids *D* on the bottom of the settling unit build up at a constant rate. *C* is a zone of transition through which the settling velocity decreases as the result of an increasing concentration of solids. The concentration of solids in the zone settling layer remains constant until the settling interface approaches the rising layers of collapsed solids, *III*, and a transition zone occurs. Through the transition zone *C*, the settling velocity will decrease because of the increasing density and viscosity of the suspension surrounding the particles. When the rising layer of settled solids reaches the interface, a compression zone occurs in stage *IV*.

In the separation of flocculent suspensions, both clarification of the liquid overflow and thickening of the sludge underflow are involved. The overflow rate for clarification requires that the average rise velocity of the liquid overflowing the tank be less than the zone settling velocity of the suspension. The tank surface area requirements for thickening the underflow to a desired concentration level are



**FIGURE 3.25**  
Settling properties of a flocculated sludge.

related to the solids loading to the unit and are usually expressed in terms of a mass loading (pounds of solids per square foot per day or kilograms per square meter per day) or a unit area (square feet per pound of solids per day or square meters per kilogram per day).

The mass loading concept for the thickening of industrial sludges is developed in Chap. 11.

### Laboratory Evaluation of Zone Settling and Calculation of Solids Flux

The settling properties of flocculated sludges can be evaluated in a liter cylinder equipped with a slow-speed stirrer rotating at a speed of 4 to 5 revolutions per hour

( $r/h$ ). The effect of the stirrer is to simulate the hydraulic motion and rake action in a clarifier and to break the stratification and arching action of the settling sludge. In some cases, an initial flocculation of the sludge occurs when it is added to the graduated cylinder. The settling and compaction curve is developed by plotting the height of the sludge interface versus the time of settling.

## Clarifiers

Clarifiers may be either rectangular or circular. In most rectangular clarifiers, scraper flights extending the width of the tank move the settled sludge toward the inlet end of the tank at a speed of about 1 ft/min (0.3 m/min). Some designs move the sludge toward the effluent end of the tank, corresponding to the direction of flow of the density current. A typical unit is shown in Fig. 3.26.

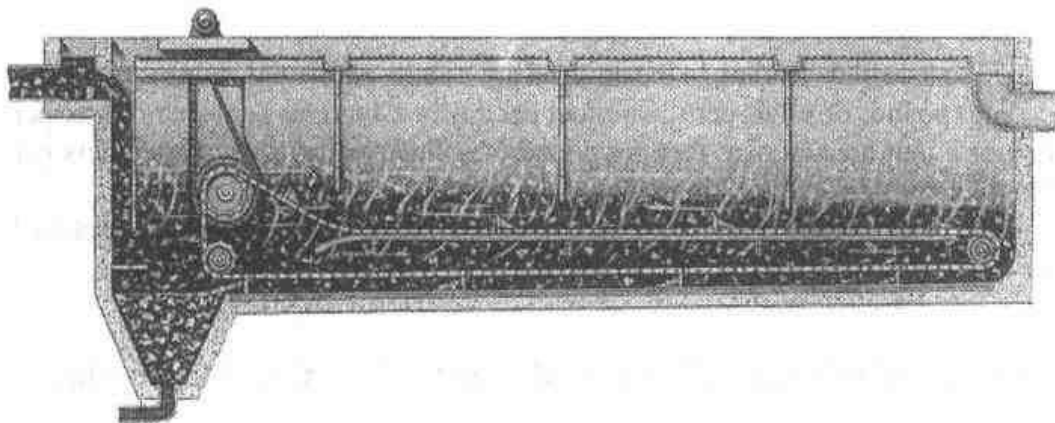
Circular clarifiers may employ either a center-feed well or a peripheral inlet. The tank can be designed for center sludge withdrawal or vacuum withdrawal over the entire tank bottom.

Circular clarifiers are of three general types. With the center-feed type, the water is fed into a center well and the effluent is pulled off at a weir along the outside. With a peripheral-feed tank, the effluent is pulled off at the tank center. With a rim-flow clarifier, the peripheral feed and effluent drainoff are also along the clarifier rim, but this type is usually used for larger clarifiers.

The circular clarifier usually gives the optimal performance. Rectangular tanks may be desired where construction space is limited and multiple tanks are to be constructed. In addition, a series of rectangular tanks would be cheaper to construct because of the "shared wall" concept.

The reactor clarifier is another variation where the functions of chemical mixing, flocculation, and clarification are combined in the highly efficient solids contact unit. This combination achieves the highest overflow rate and the highest effluent quality of all clarifier designs.

The circular clarifier can be designed for center sludge withdrawal or vacuum withdrawal over the entire tank bottom. Center sludge withdrawal requires a min-



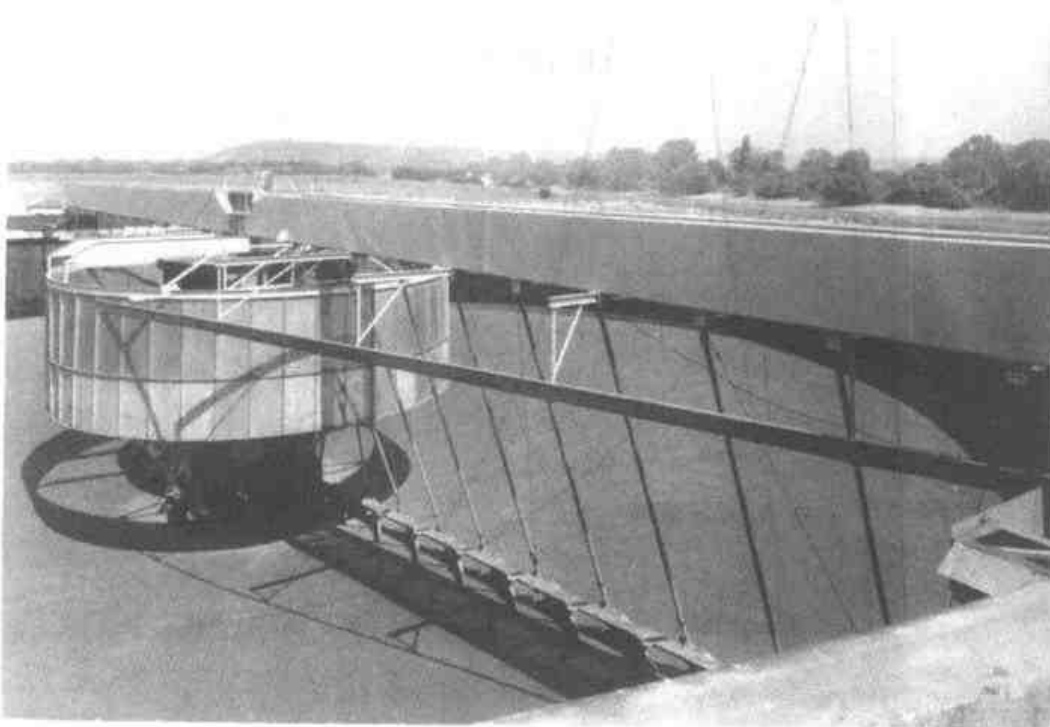
**FIGURE 3.26**  
Rectangular clarifier.

imum bottom slope of 1 in/ft (8.3 cm/m). The flow of sludge to the center well is largely hydraulically motivated by the collection mechanism, which serves to overcome inertia and avoid sludge adherence to the tank bottom. The vacuum drawoff is particularly adaptable to secondary clarification and thickening of activated sludge. A circular clarifier is shown in Fig. 3.27.

The mechanisms can be of the plow type or the rotary-hoe type. The plow-type mechanism employs staggered plows attached to two opposing arms that move at about 10 ft/min (3 m/min). The rotary-hoe mechanism consists of a series of short scrapers suspended from a rotating supporting bridge on endless chains that make contact with the tank bottom at the periphery and move to the center of the tank.

An inlet device is designed to distribute the flow across the width and depth of the settling tank. The outlet device is likewise designed to collect the effluent uniformly at the outlet end of the tank. Well-designed inlets and outlets will reduce the short-circuiting characteristics of the tank. Increased weir length can be provided by extending the effluent channels back into the basin or by providing multiple effluent channels. In circular basins, inboard or radial weirs will ensure low take-off velocities. Relocation of weirs is sometimes necessary to minimize solids carryover induced by density currents and resulting in upwelling swells of sludge at the end of the settling tank. The installation of a plate below the effluent weir extending 18 in (45.7 cm) into the clarifier will deflect rising solids and permit them to resettle. Improved performance of secondary clarifiers has been achieved with this modification.

Tube settlers offer increased removal efficiency at higher loading rates and lower detention times. An immediate advantage is that modules of inclined tubes constructed of plastic can be installed in existing clarifiers to upgrade performance.



**FIGURE 3.27**  
Circular clarifier.

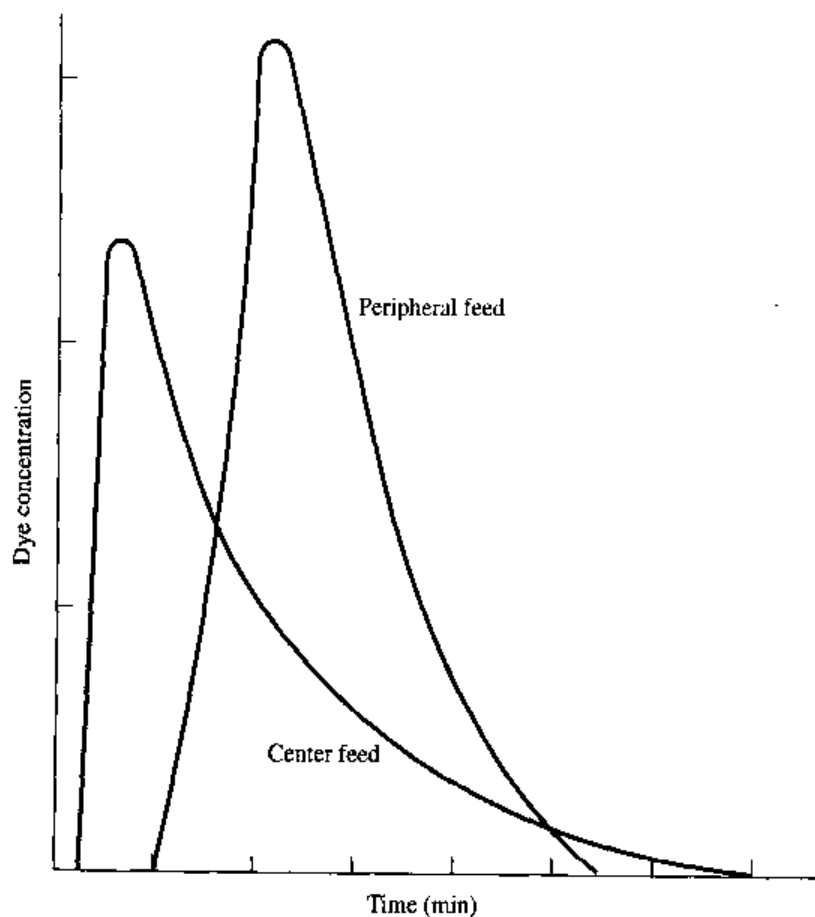


There are two types of tube clarifiers, the slightly inclined and the steeply inclined units. The slightly inclined unit usually has the tubes inclined at a  $5^\circ$  angle. For the removal of discrete particles, an inclination of  $5^\circ$  has proven most efficient.

The steeply inclined unit is less efficient in removal of discrete particles, but can be operated continuously. When the tubes are inclined greater than  $45^\circ$ , the sludge is deposited and slides back out of the tube, forming a countercurrent flow. In practice most wastes are flocculent in nature, and removal efficiency is improved when the tubes are inclined to  $60^\circ$  to take advantage of the increased flocculation that occurs as the solids slide back out of the tube. Steeply inclined units are usually used where sedimentation units are being upgraded.

The hydraulic characteristics of a settling tank can be defined by a dispersion test in which dye or tracer is injected into the influent as a slug, and the concentration measured in the effluent as a function of time.

It is frequently possible to improve the performance of an existing settling basin by making modifications based on the results of a dispersion test. A comparison of a hydraulically overloaded center-feed tank converted to a peripheral-feed tank is shown in Fig. 3.28.



**FIGURE 3.28**

Dispersion characteristics of two settling tanks.

### 3.4 OIL SEPARATION

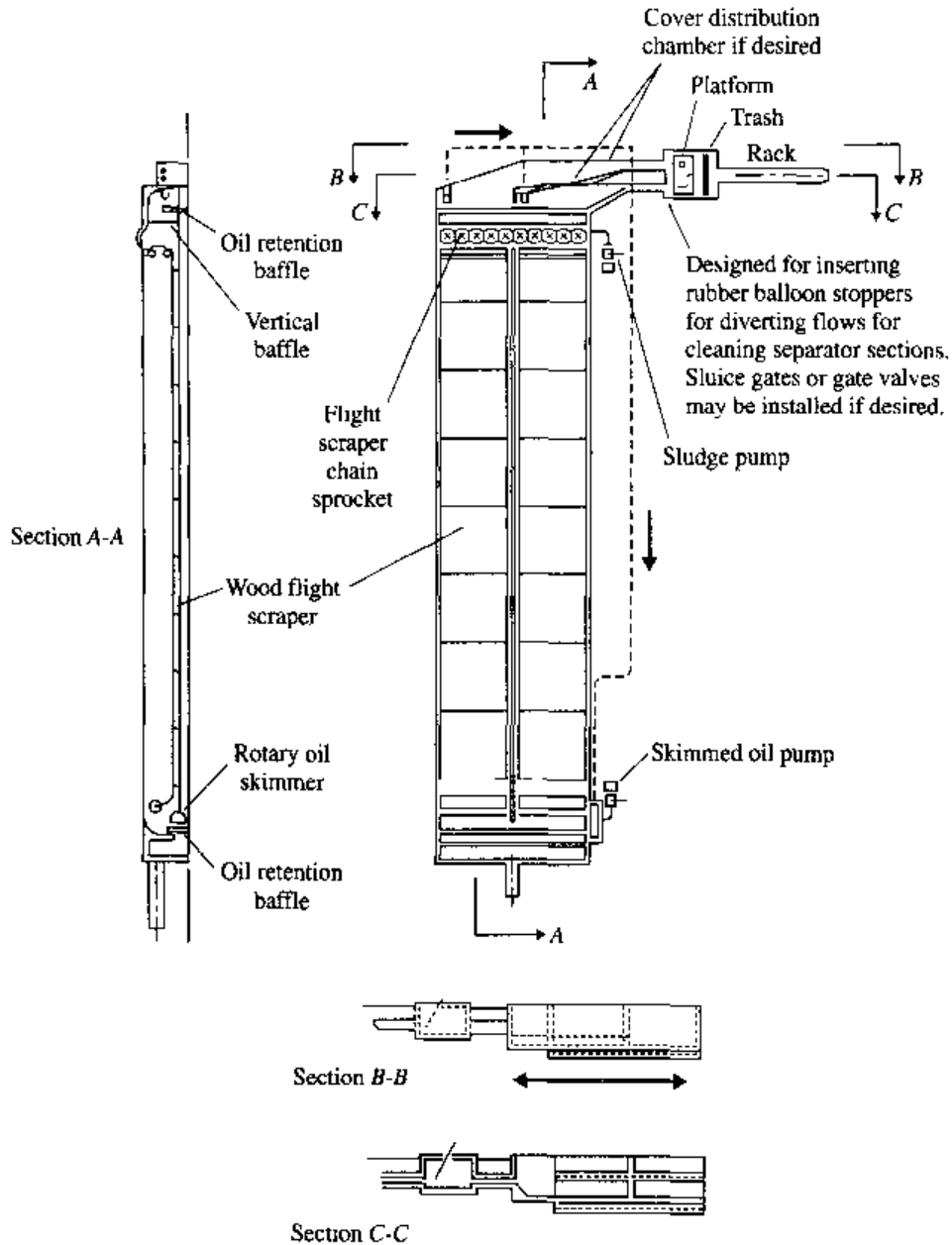
In an oil separator, free oil is floated to the surface of a tank and then skimmed off. The same conditions holding for the subsidence of particles apply, except that the lighter-than-water oil globules rise through the liquid. The design of gravity separators as specified by the American Petroleum Institute<sup>11</sup> is based on the removal of all free oil globules larger than 0.015 cm.

The Reynolds number is less than 0.5, so Stokes' law applies. A design procedure considering short circuiting and turbulence has been developed.<sup>12</sup>

An API oil separator is shown in Fig. 3.29. The performance of an API separator is shown in Figs. 3.30 and 3.31 and typical efficiencies shown in Table 3.10.<sup>13</sup> Design criteria suggest that the flow rate should not exceed 2 ft/min, the length to width ratio should be at least 5 to avoid dead spots in the separator, and the minimum depth set at 4 ft. Variability in performance reported by Rebhun and Galil<sup>14</sup> is shown in Fig. 3.32. The influence of initial oil concentration on separator efficiency is shown in Fig. 3.33.<sup>13</sup>

Plate separators include parallel plate separators and corrugated plate separators (CPS). Plate separators are designed to separate oil droplets larger than 0.006 cm. It has been found by experience that a 0.006-cm separation will generally produce a 10-mg/l free oil nonemulsified effluent. This quality can usually be met when the influent oil content is less than 1 percent. One problem with the CPS is that reduced efficiency results from high oil loadings caused by oil-droplet shear and reentrainment of the oil droplet. This is largely overcome using a cross-flow corrugated plate separator in which the separated oil rises across the direction of flow rather than against the direction of flow (plates are angled at 45° and spaced at 10 mm). The hydraulic loading varies with temperature and the specific gravity of the oil. Nominal flow rates are specified for a temperature of 20°C and a specific gravity of 0.9 for the oil. A hydraulic loading of 0.5 m<sup>3</sup>/(h · m<sup>2</sup>) of actual plate area will usually result in separation of 0.006-cm droplets. A 50 percent safety factor is usually employed for design purposes. A plate separator is shown in Fig. 3.34.

Several types of filtration devices have proved effective in removing free and emulsified oils from refinery-petrochemical wastewaters. These vary from filters with sand media to those containing special media which exhibit a specific affinity for oil. One type is an upflow unit using a graded silica medium as the filtering and coalescing section. Even the small particles and globules are separated and retained on the medium. The oil particles, which flow upward by gravity differential and fluid flow, rise through the coalescent medium and through the water phase from which the oil is separated and collected near the top of the separator. The bed is regenerated by introducing wash water at a rapid rate and evacuating the solids and remaining oil. This filtration and coalescing process is often enhanced by the use of polymer resin media. The primary application of these units are for selected in-plant streams which are dirt-free. Another application would be ballast water treatment following phase separation.

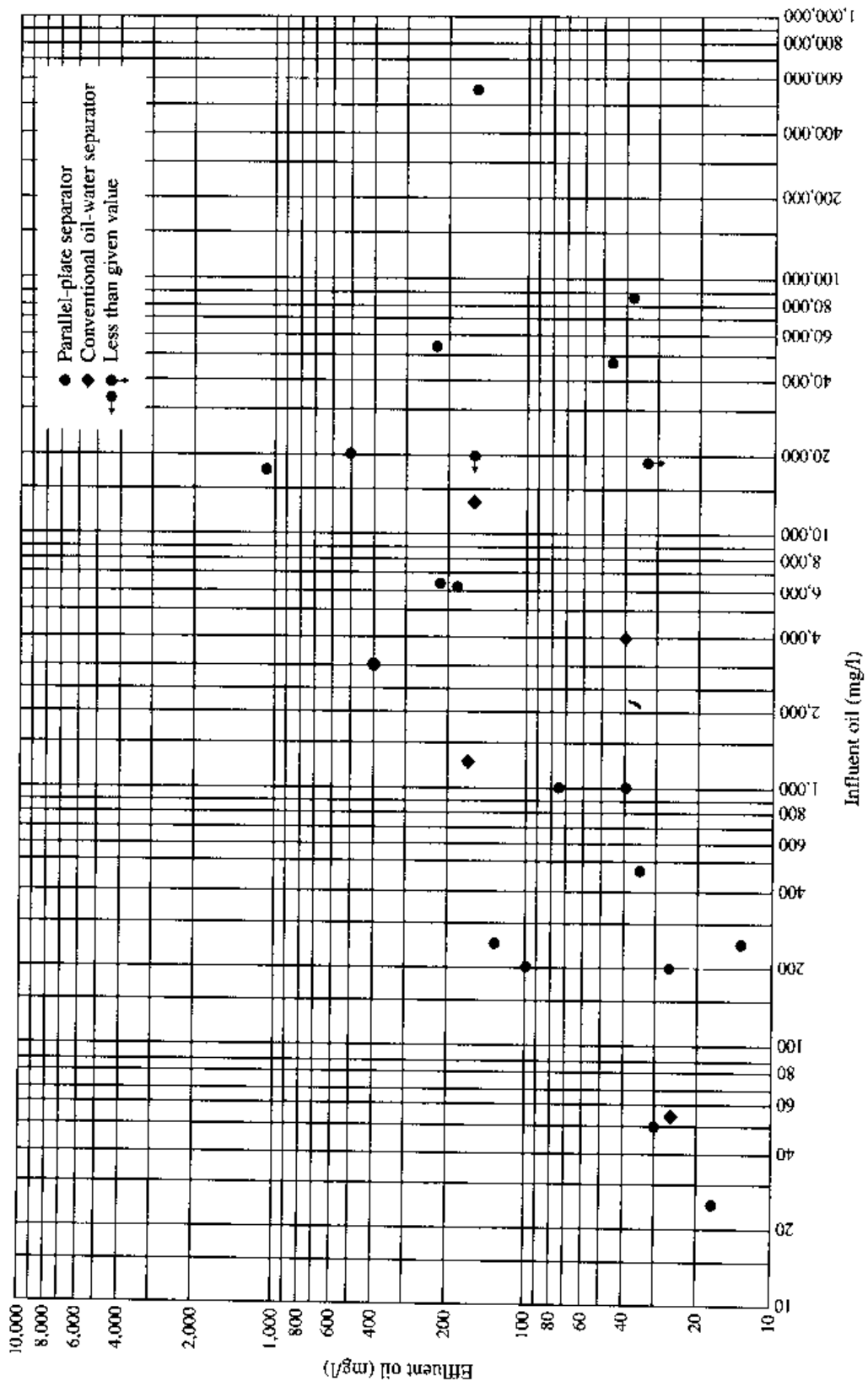


**FIGURE 3.29**

Example of general arrangement for API separator (*courtesy of the American Petroleum Institute*).

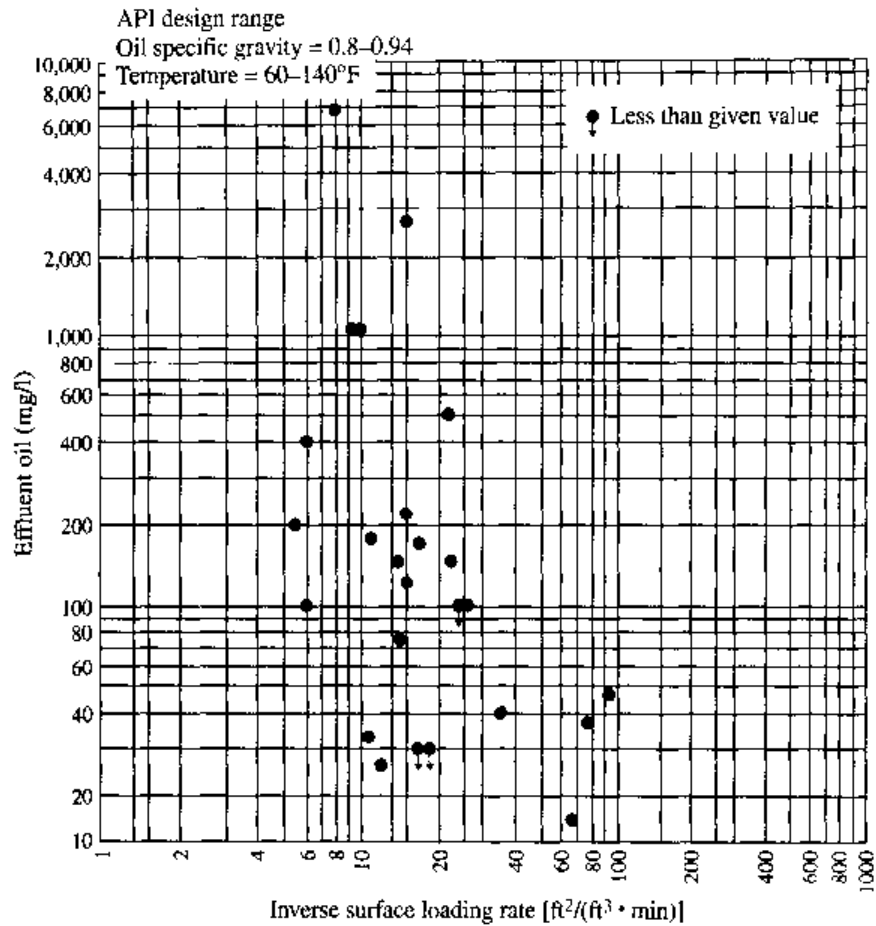
Emulsified oily materials require special treatment to break the emulsions so that the oily materials will be free and can be separated by gravity, coagulation, or air flotation. The breaking of emulsions is a complex art and may require laboratory or pilot-scale investigations prior to developing a final process design.

Emulsions can be broken by a variety of techniques. Quick-breaking detergents form unstable emulsions which break in 5 to 60 min to 95 to 98 percent completion. Emulsions can be broken by acidification, the addition of alum or iron salts, or the use of emulsion-breaking polymers. The disadvantage of alum or iron is the large quantities of sludge generated.



Note: The data in this figure are taken from the 1985 API Refinery Survey.

**FIGURE 3.30**  
Correlation between influent and effluent oil levels for existing oil-water separators.

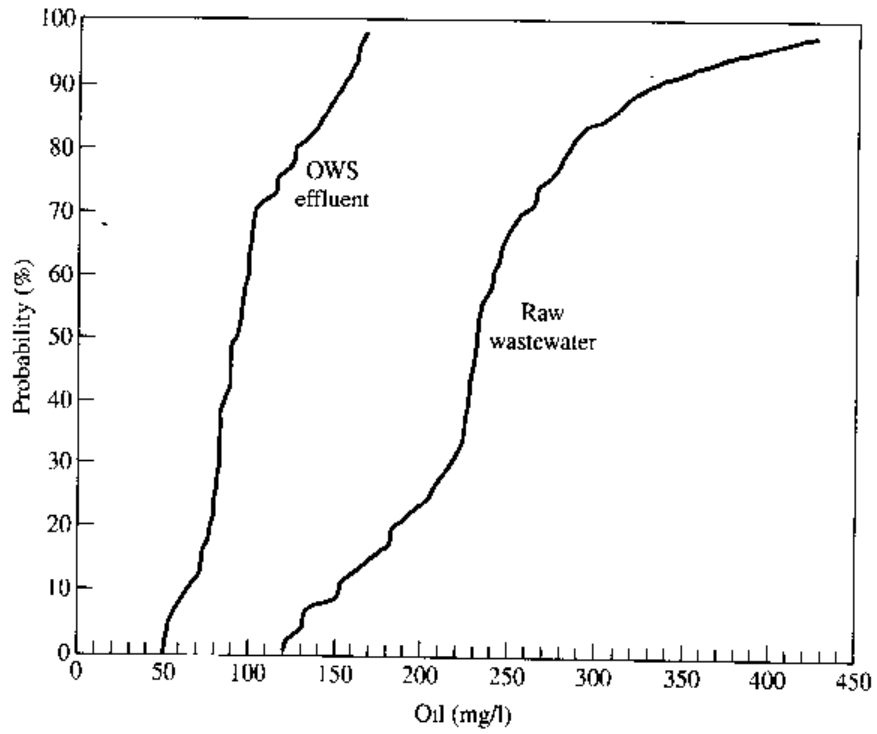


Note. The data in this figure are taken from the 1985 API Refinery Survey.

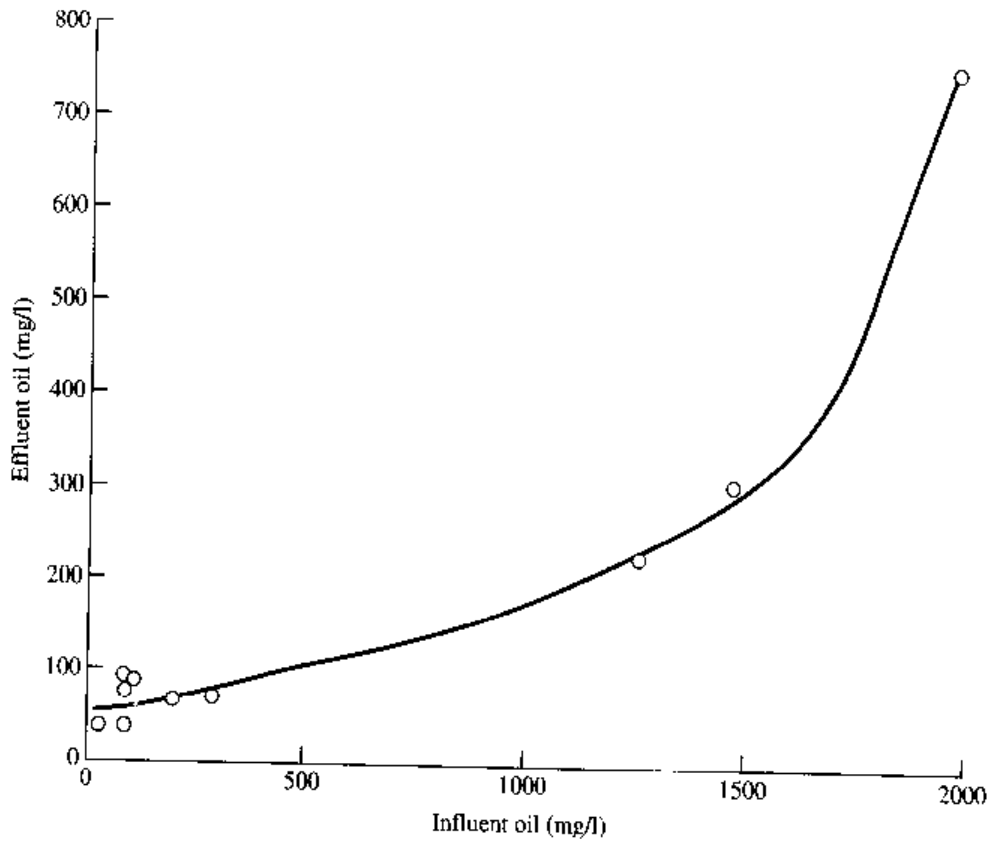
**FIGURE 3.31**  
Performance of conventional oil-water separators.

**TABLE 3.10**  
Typical efficiencies of oil separation units

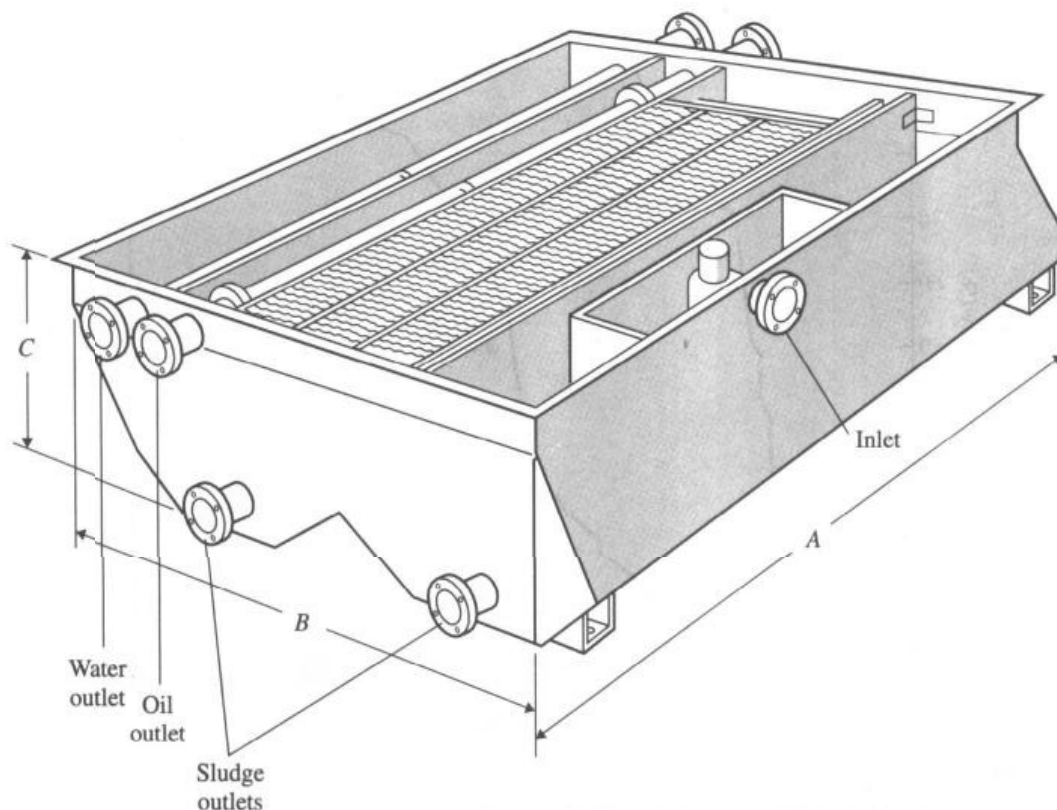
Oil content		Oil removed, %	Type	COD removed, %	SS removed, %
Influent, mg/l	Effluent, mg/l				
300	40	87	Parallel plate	—	—
220	49	78	API	45	—
108	20	82	Circular	—	—
108	50	54	Circular	16	—
98	44	55	API	—	—
100	40	60	API	—	—
42	20	52	API	—	—
2000	746	63	API	22	33
1250	170	87	API	—	68
1400	270	81	API	—	35



**FIGURE 3.32**  
Oil removal by the oil-water separation (OWS) unit.



**FIGURE 3.33**  
Effect of influent oil concentration separator efficiency.



**FIGURE 3.34**  
Cross-flow plate separator.

### 3.5 SOUR WATER STRIPPERS

Stripping processes are used to remove selected constituents from liquid streams. The two most prevalent pollutants found in refinery wastewaters which are susceptible to stripping are hydrogen sulfide and ammonia resulting from the destruction of essentially all the organic nitrogen and sulfur compounds during desulfurization, denitrification, and hydrotreating. The use of steam within the processes is the primary source of conveyance, as the condensation occurs simultaneously with the condensation of hydrocarbon liquids and in the presence of a hydrocarbon vapor phase which contains  $H_2S$  and  $NH_3$ .<sup>12</sup> Phenols also may be present in these "sour water" condensates and can be stripped from solutions, although the efficiency of removal is less than for sulfide and ammonia. Other aromatics also can be stripped from solution at various levels of efficiency. As the regulatory agencies are imposing increasingly stringent quality standards for refinery wastewater in terms of immediate oxygen demand (sulfide causative) and ammonia, the necessity of in-plant control through stripping towers may be required whether it can be justified in terms of product recovery or not.

The design criteria for sour water strippers is well documented and is outlined in detail elsewhere.<sup>12, 15</sup> There are various types of strippers but most involve a single tower equipped with trays or some type of packing. The feed water enters at the top of the tower and steam or stripping gas is introduced at the bottom. As  $H_2S$

is less soluble in water than  $\text{NH}_3$ , it is more readily stripped from the solution. High temperatures (230°F or more) are required to remove  $\text{NH}_3$ , where  $\text{H}_2\text{S}$  could be stripped at 100°F if  $\text{NH}_3$  were fixed or not present. Therefore, acidification with a mineral acid or flue gas is often used to fix the  $\text{NH}_3$  and allow more efficient  $\text{H}_2\text{S}$  removal. Average operating characteristics of some sour water strippers are cited in Table 3.11.<sup>15</sup> Although acidification enhances sulfide removal, it fixes the ammonia and prevents its removal. This has led to a two-stage stripping and recovery process developed by the Chevron Research Company. The process includes a degasser-surge tank combination which allows operational flexibility. After any floating hydrocarbon is skimmed, it is routed to the first column where the  $\text{H}_2\text{S}$  is stripped and sent to a sulfur recovery plant. The water-ammonia mixture then goes to a second fractionator for ammonia stripping. The overhead ammonia, approximately 98 percent pure as it leaves the condenser, is further purified passing through a scrubber system, and is then liquefied as high-purity ammonia. The cooled water bottoms from the system are then sufficiently free of  $\text{H}_2\text{S}$  and  $\text{NH}_3$  to satisfy most quality criteria, containing less than 5 mg/l  $\text{H}_2\text{S}$  and 50 mg/l  $\text{NH}_3$ .

### 3.6 FLOTATION

Flotation is used for the removal of suspended solids and oil and grease from wastewaters and for the separation and concentration of sludges. The waste flow or a portion of clarified effluent is pressurized to 50 to 70 lb/in<sup>2</sup> (345 to 483 kPa or 3.4 to 4.8 atm) in the presence of sufficient air to approach saturation. When this pressurized air-liquid mixture is released to atmospheric pressure in the flotation unit, minute air bubbles are released from solution. The sludge flocs, suspended solids, or oil globules are floated by these minute air bubbles, which attach themselves to and become enmeshed in the floc particles. The air-solids mixture rises to

TABLE 3.11  
Average operating characteristics of sour water strippers

Type of stripper	Flow rate of stripping medium, SCF/gal	Removal		Temperature	
		$\text{H}_2\text{S}$ , %	$\text{NH}_3$ , %	Tower feed, °F	Tower bottom, °F
Steam					
With acidifying <sup>†</sup>	8-32	96-100	69-95	150-240	230-270
Without acidifying <sup>‡</sup>	4-6	97-100	0	200	230-250
Flue gas					
With steam <sup>§</sup>	12.7	88-98	77-90	235	235
Without steam <sup>§</sup>	11.9	99	8	135	140
Natural gas					
With acidifying	7.5	98	0	70-100	70-100

<sup>†</sup>Data from eight towers.

<sup>§</sup>Data from only one tower.

<sup>‡</sup>Data from two towers.



the surface, where it is skimmed off. The clarified liquid is removed from the bottom of the flotation unit; at this time a portion of the effluent may be recycled back to the pressure chamber. When flocculent sludges are to be clarified, pressurized recycle will usually yield a superior effluent quality since the flocs are not subjected to shearing stresses through the pumps and pressurizing system.

### Air Solubility and Release

The saturation of air in water is directly proportional to pressure and inversely proportional to temperature. Pray<sup>16</sup> and Frohlich<sup>17</sup> found that the oxygen and nitrogen solubilities in water follow Henry's law over a wide pressure range. Vrablick<sup>18</sup> has shown that although a linear relationship exists between pressure and solubility for most industrial wastes, the slope of the curve varies, depending on the nature of the waste constituents present. The solubility of air in water at atmospheric pressure is shown in Table 3.12.

The quantity of air that will theoretically be released from solution when the pressure is reduced to 1 atm can be computed from

$$s = s_a \frac{P}{P_a} - s_a \quad (3.11)$$

where  $s$  = air released at atmospheric pressure per unit volume at 100 percent saturation,  $\text{cm}^3/\text{l}$

$s_a$  = air saturation at atmospheric pressure,  $\text{cm}^3/\text{l}$

$P$  = absolute pressure

$P_a$  = atmospheric pressure

The actual quantity of air released will depend upon turbulent mixing conditions at the point of pressure reduction and on the degree of saturation obtained in the pres-

TABLE 3.12  
Air characteristics and solubilities

Temperature		Volume solubility		Weight solubility		Density	
°C	°F	ml/l	ft <sup>3</sup> /thousand gal	mg/l	lb/thousand gal	g/l	lb/ft <sup>3</sup>
0	32	28.8	3.86	37.2	0.311	1.293	0.0808
10	50	23.5	3.15	29.3	0.245	1.249	0.0779
20	68	20.1	2.70	24.3	0.203	1.206	0.0752
30	86	17.9	2.40	20.9	0.175	1.166	0.0727
40	104	16.4	2.20	18.5	0.155	1.130	0.0704
50	122	15.6	2.09	17.0	0.142	1.093	0.0682
60	140	15.0	2.01	15.9	0.133	1.061	0.0662
70	158	14.9	2.00	15.3	0.128	1.030	0.0643
80	176	15.0	2.01	15.0	0.125	1.000	0.0625
90	194	15.3	2.05	14.9	0.124	0.974	0.0607
100	212	15.9	2.13	15.0	0.125	0.949	0.0591

Values presented in absence of water vapor and at 14.7 lb/in<sup>2</sup> abs pressure (1 atm).

surizing system. Since the solubility in industrial wastes may be less than that in water, a correction may have to be applied to Eq. (3.11). Retention tanks will generally yield 86 to 90 percent saturation. Equation (3.11) can be modified to account for air saturation:

$$s = s_a \left( \frac{fP}{P_a} - 1 \right) \quad (3.12)$$

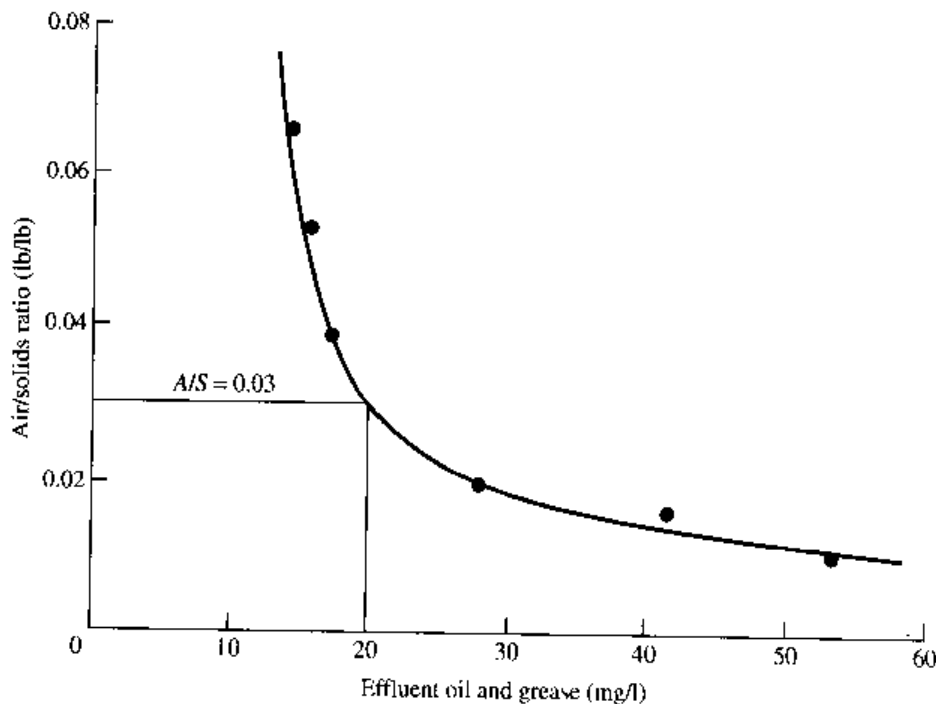
where  $f$  is the fraction of saturation in the retention tank.

The performance of a flotation system depends on having sufficient air bubbles present to float substantially all of the suspended solids. An insufficient quantity of air will result in only partial flotation of the solids, and excessive air will yield no improvement. The performance of a flotation unit in terms of effluent quality and solids concentration in the float can be related to an air/solids ( $A/S$ ) ratio, which is usually defined as mass of air released per mass of suspended solids in the influent waste:

$$\frac{A}{S} = \frac{s_a R}{S_a Q} \left( \frac{fP}{P_a} - 1 \right) \quad (3.13)$$

where  $Q$  = wastewater flow  
 $R$  = pressurized recycle  
 $S_a$  = influent oil and/or suspended solids

The relationship between the air/solids ratio and effluent quality is shown in Fig. 3.35. It should be noted that the shape of the curve will vary with the nature of the solids in the feed.

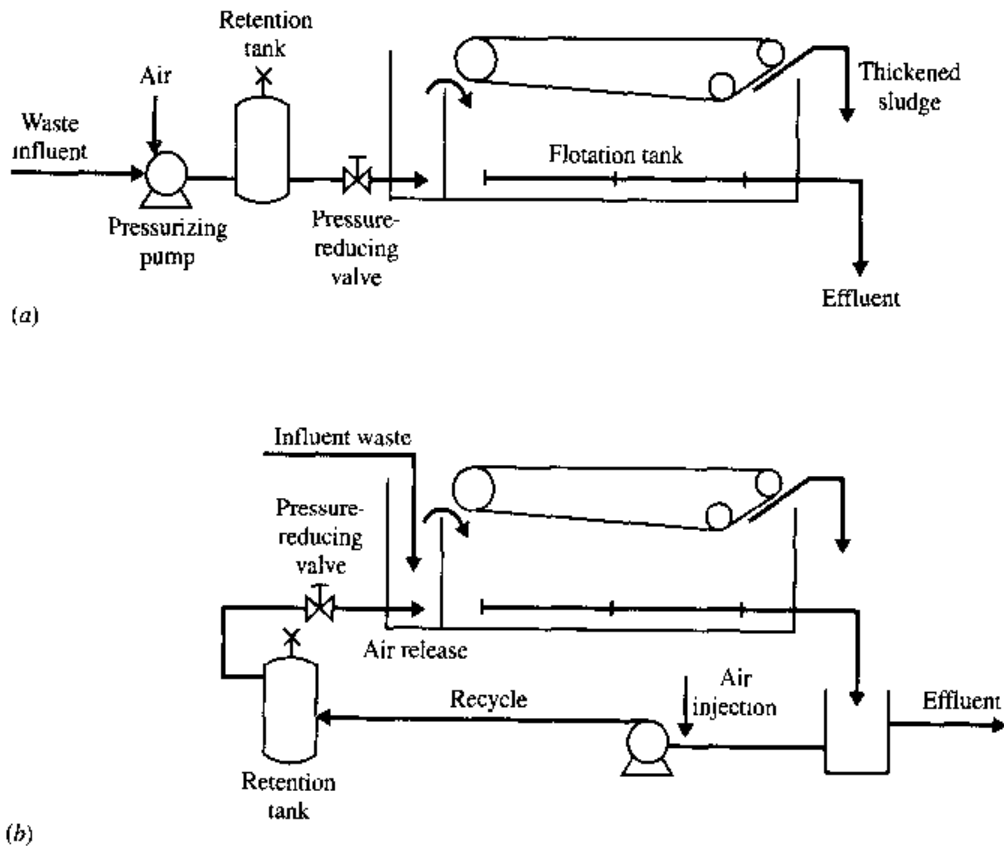


**FIGURE 3.35**  
Effects on  $A/S$  on effluent quality.

Vrablick<sup>18</sup> has shown that the bubbles released after pressurization (20 to 50 lb/in<sup>2</sup> or 1.36 to 3.40 atm) range in size from 30 to 100  $\mu\text{m}$ . The rise velocity closely follows Stokes' law. The rise velocity of a solids-air mixture has been observed to vary from 1 to 5 in/min (2.56 to 12.7 cm/min) and will increase with an increasing air/solids ratio. In the flotation of activated sludge of 0.91 percent solids and 40 lb/in<sup>2</sup> (276 kPa or 2.72 atm), Hurwitz and Katz<sup>19</sup> observed free rises of 0.3 (9), 1.2 (37), and 1.8 ft/min (55 cm/min) for recycle ratios of 100, 200, and 300 percent, respectively. The initial rise rate will vary with the character of the solids.

The primary variables for flotation design are pressure, recycle ratio, feed solids concentration, and retention period. The effluent suspended solids decrease and the concentration of solids in the float increase with increasing retention period. When the flotation process is used primarily for clarification, a detention period of 20 to 30 min is adequate for separation and concentration. Rise rates of 1.5 to 4.0 gal/(min  $\cdot$  ft<sup>2</sup>) [0.061 to 0.163 m<sup>3</sup>/(min  $\cdot$  m<sup>2</sup>)] are commonly employed. When the process is employed for thickening, longer retention periods are necessary to permit the sludge to compact.

The principal components of a flotation system are a pressurizing pump, air-injection facilities, a retention tank, a backpressure regulating device, and a flotation unit, as shown in Fig. 3.36. The pressurizing pump creates an elevated pres-



**FIGURE 3.36**

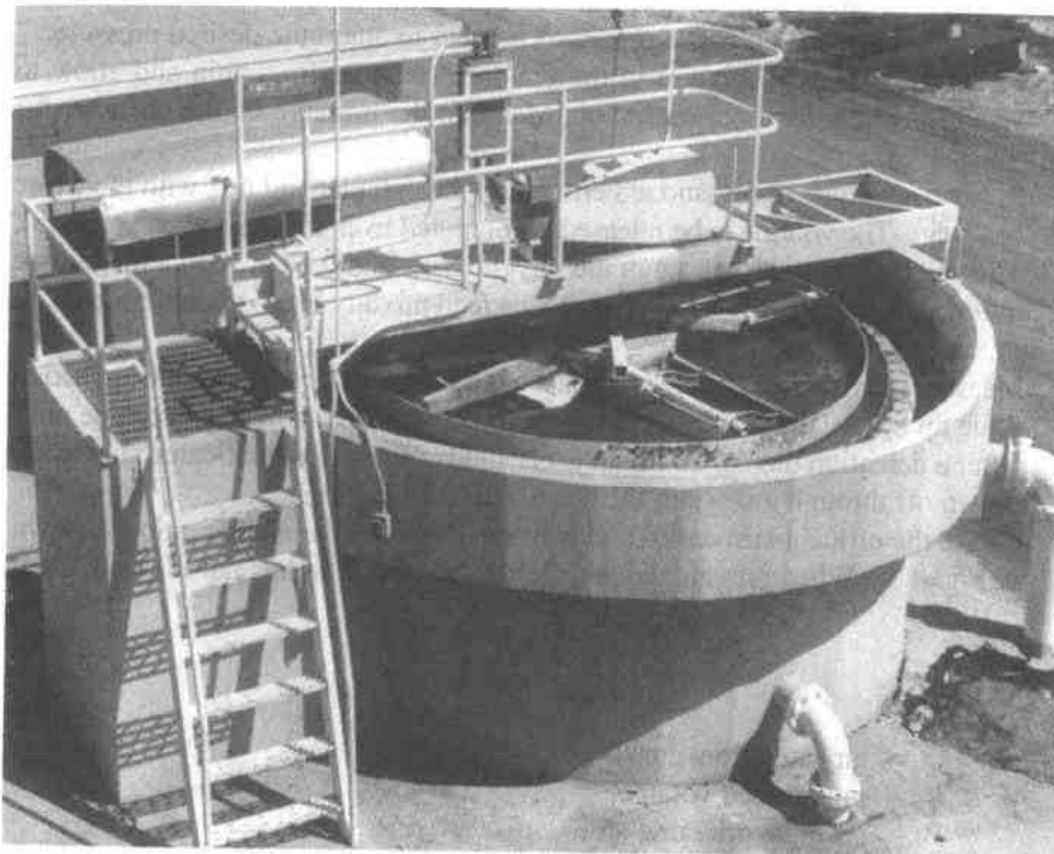
Schematic representation of flotation systems. (a) Flotation system without recirculation. (b) Flotation system with recirculation.

sure to increase the solubility of air. Air is usually added through an injector on the suction side of the pump or directly to the retention tank.

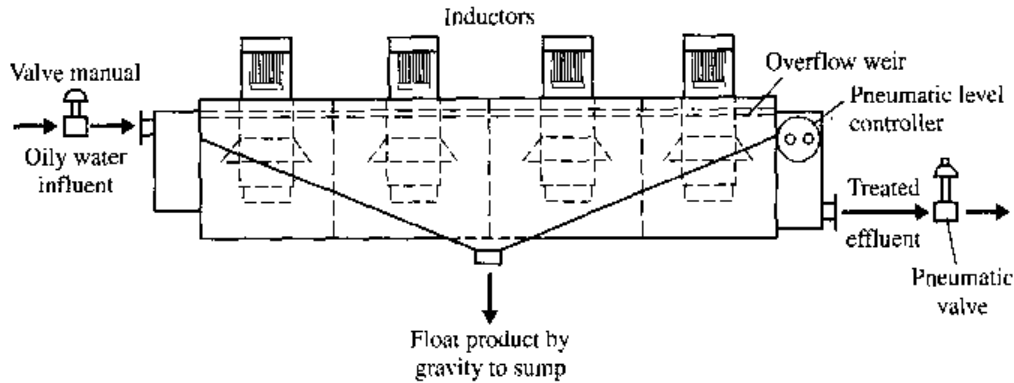
The air and liquid are mixed under pressure in a retention tank with a detention time of 1 to 3 min. A backpressure regulating device maintains a constant head on the pressurizing pump. Various types of valves are used for this purpose. The flotation unit may be either circular or rectangular with a skimming device to remove the thickened, floated sludge, as shown in Fig. 3.37.

The induced-air flotation system, shown in Fig. 3.38, operates on the same principles as a pressurized-air DAF unit. The gas, however, is self-induced by a rotor-disperser mechanism. The rotor, the only moving part of the mechanism that is submerged in the liquid, forces the liquid through the disperser openings, thereby creating a negative pressure. It pulls the gas downward into the liquid, causing the desired gas-liquid contact. The liquid moves through a series of four cells before leaving the tank, and the float skimmings pass over the overflow weirs on each side of the unit. This type of system offers the advantages of significantly lower capital cost and smaller space requirements than the pressurized system, and current performance data indicate that these systems have the capacity to effectively remove free oil and suspended materials.

The disadvantages include higher connected power requirements than the pressurized system, performance dependent on strict hydraulic control, less chemical



**FIGURE 3.37**  
Clarifier flotation unit.



**FIGURE 3.38**  
Induced air flotation system (*Wemco Envirotech Company*).

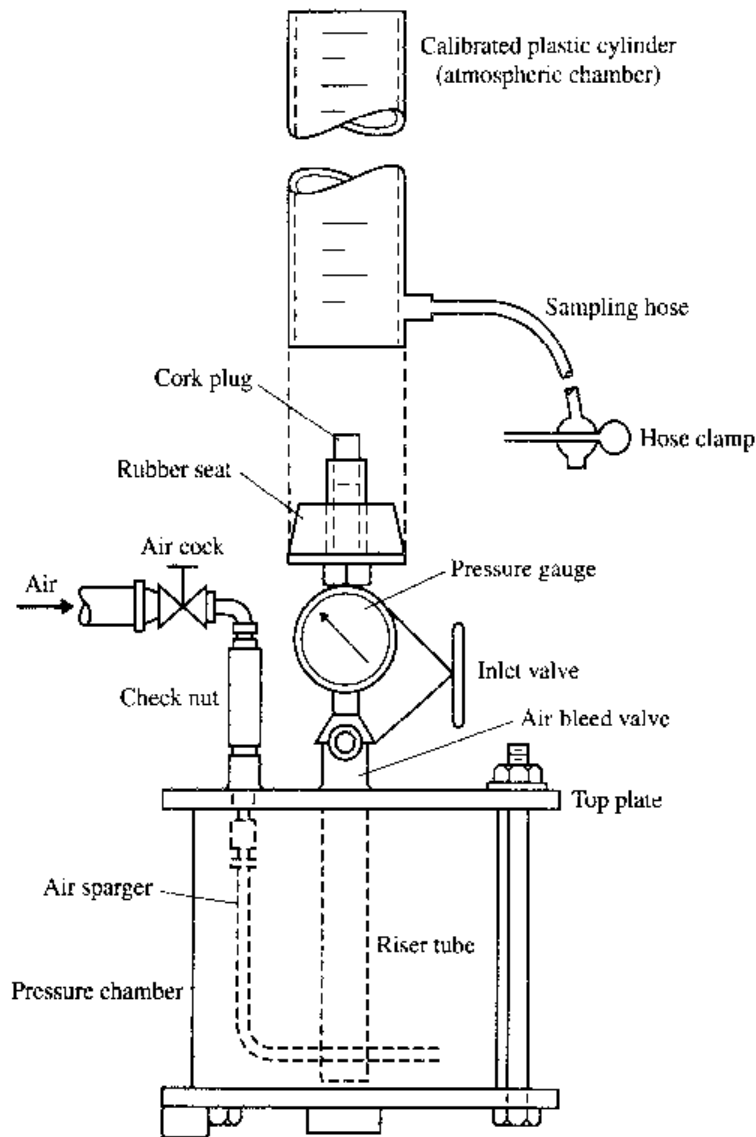
addition and flocculation flexibility, and relatively high volumes of float skimmings as a function of liquid throughput (3 to 7 percent of the incoming flow for induced-air systems is common compared to less than 1 percent for pressurized-air systems).

It is possible to estimate the flotation characteristics of a waste by the use of a laboratory flotation cell, as shown in Fig. 3.39. The procedure is as follows:

1. Partially fill the calibrated cylinder with waste or flocculated sludge mixture and the pressure chamber with clarified effluent or water.
2. Apply compressed air to the pressure chamber to attain the desired pressure.
3. Shake the air-liquid mixture in the pressure chamber for 1 min and allow to stand for 3 min to attain saturation. Maintain the pressure on the chamber for this period.
4. Release a volume of pressurized effluent to the cylinder and mix with the waste or sludge. The volume to be released is computed from the desired recycle ratio. The velocity of release through the inlet nozzle should be of such a magnitude as not to shear the suspended solids in the feed mixture but to maintain adequate mixing.
5. Measure the rise of the sludge interface with time. Correction must be applied to scale up the height of rise in the test cylinder to the depth of the prototype unit.
6. After a detention time of 20 min, the clarified effluent and the floated sludge are drawn off through a valve in the bottom of the cylinder.
7. Relate the effluent suspended solids to the calculated air/solids ratio as shown in Fig. 3.35. When pressurized recycle is used, the air/solids ratio is computed:

$$\frac{A}{S} = \frac{1.3s_a R(P - 1)}{QS_a}$$

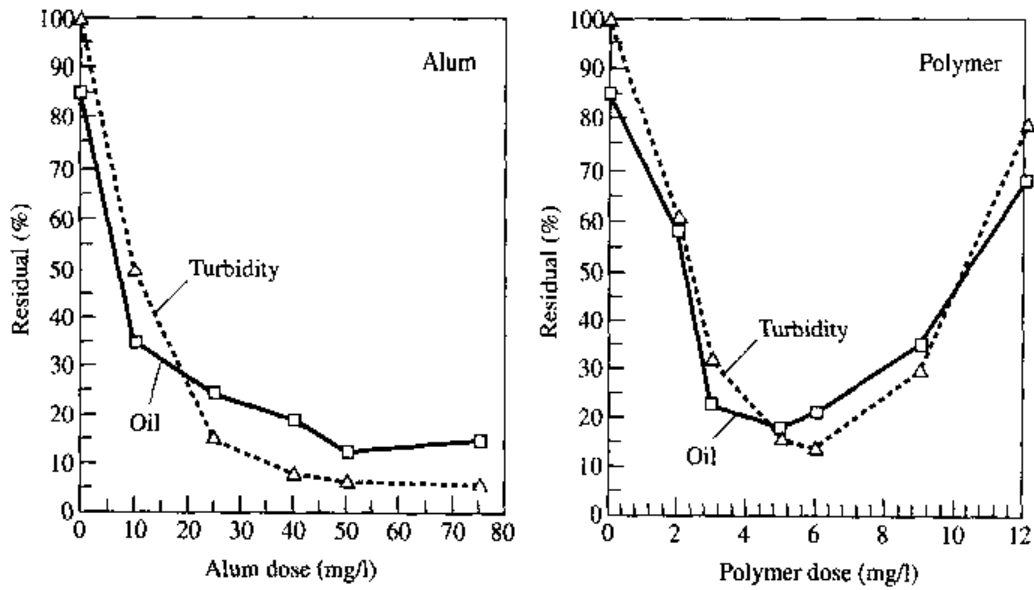
where  $s_a$  = air saturation,  $\text{cm}^3/\text{l}$   
 $R$  = pressurized volume, l  
 $P$  = absolute pressure, atm  
 $Q$  = waste flow, l  
 $S_a$  = influent suspended solids,  $\text{mg/l}$



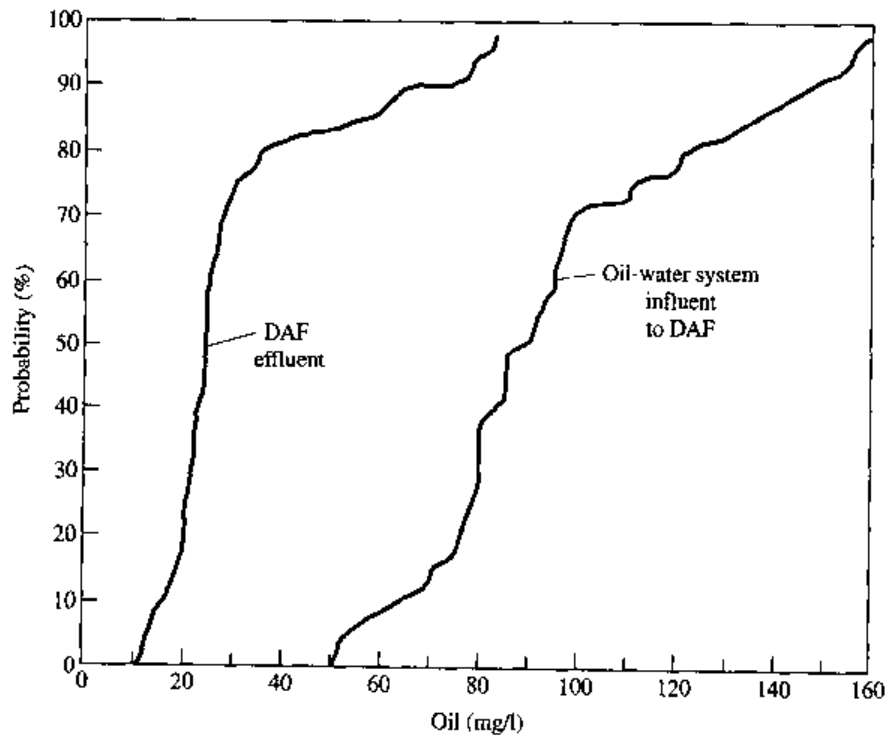
**FIGURE 3.39**  
Laboratory flotation cell.

High-degree clarification frequently requires that flocculating chemicals be added to the influent before it is mixed with the pressurized recycle. Alum or polyelectrolytes are used as flocculating agents. Hurwitz and Katz<sup>19</sup> have shown that the rise rate of chemical floc will vary from 0.65 to 2.0 ft/min (20 to 61 cm/min), depending on the floc size and characteristics. Treatment efficiency with chemical addition is shown in Fig. 3.40.

Flotation design for an oily wastewater is shown in Example 3.7. Flotation units have been used for the clarification of wastewaters, for the removal of oil, and for the concentration of waste sludges. Variability in DAF performance is shown in Figs. 3.41 and 3.42. Some reported data for petroleum refinery effluents are shown in Table 3.13 and for a variety of wastewaters in Table 3.14.



**FIGURE 3.40**  
Treatment efficiency in chemical flocculation.<sup>14</sup>



**FIGURE 3.41**  
Oil removal by chemical flocculation and DAF.<sup>14</sup>

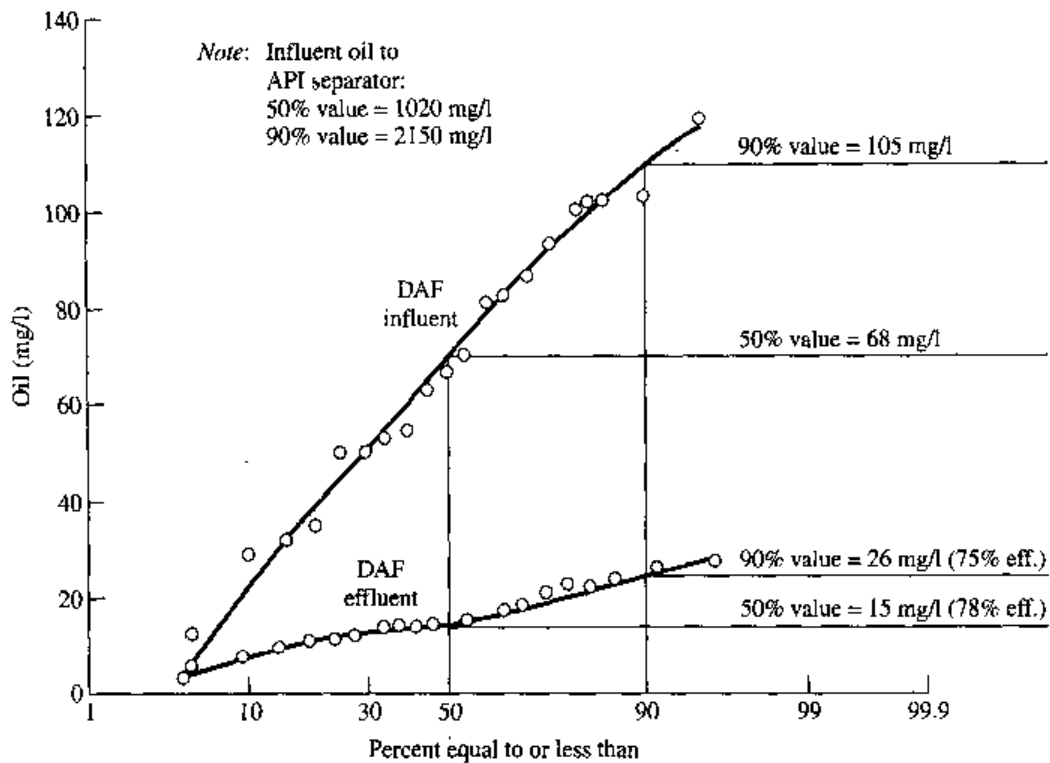


FIGURE 3.42

TABLE 3.13  
DAF performance data

Influent oil, mg/l	Effluent oil, mg/l	% removal	Chemicals <sup>†</sup>	Configuration
1930 (90%)	128 (90%)	93	Yes	Circular
580 (50%)	68 (50%)	88	Yes	Circular
105 (90%)	26 (90%)	78	Yes	Rectangular
68 (50%)	15 (50%)	75	Yes	Rectangular
170	52	70	No	Circular
125	30	71	Yes	Circular
100	10	90	Yes	Circular
133	15	89	Yes	Circular
94	13	86	Yes	Circular
838	60	91	Yes	Rectangular
153	25	83	Yes	Rectangular
75	13	82	Yes	Rectangular
61	15	75	Yes	Rectangular
360	45	87	Yes	Rectangular
315	54	83	Yes	Rectangular

<sup>†</sup>Alum most common, 100–300 mg/l. Polyelectrolyte, 1–5 mg/l, is occasionally added.



TABLE 3.14  
Air flotation treatment of oily wastewaters

Wastewater	Coagulant, mg/l	Oil concentration, mg/l		
		Influent	Effluent	Removal, %
Refinery	0	125	35	72
	100 alum	100	10	90
	130 alum	580	68	88
	0	170	52	70
Oil tanker ballast water	100 alum + 1 mg/l polymer	133	15	89
Paint manufacture	150 alum + 1 mg/l polymer	1900	0	100
Aircraft maintenance	30 alum + 10 mg/l activated silica	250-700	20-50	>90
Meat packing		3830	270	93
		4360	170	96

**EXAMPLE 3.7.** A wastestream of 150 gal/min (0.57 m<sup>3</sup>/min) and a temperature of 103°F (39.4°C) contains significant quantities of nonemulsified oil and nonsettleable suspended solids. The concentration of oil is 120 mg/l. Reduce the oil to less than 20 mg/l. Laboratory studies showed:

Alum dose = 50 mg/l

Pressure = 60 lb/in<sup>2</sup> gage (515 kPa absolute or 4.1 relative atm)

Sludge production = 0.64 mg/mg alum

Sludge = 3 percent by weight

Calculate:

- The recycle rate
- Surface area of the flotation unit
- Sludge quantities generated

The air/solids ratio for effluent oil and grease of 20 mg/l is found from Figure 3.35:

$$\frac{A}{S} = 0.03 \text{ lb air released/lb solids applied}$$

At 103°F (39.4°C) the weight solubility of air is 18.6 mg/l from Table 3.12. The value of  $f$  is assumed to be 0.85.

**Solution.**

- The recycle rate is

$$\begin{aligned}
 R &= \frac{(A/S)QS_a}{s_a(fP/P_a - 1)} \\
 &= \frac{0.03 \times 150 \times 120}{18.6(0.85 \times 515/101.3) - 1} \\
 &= 8.75 \text{ gal/min (33.1 l/min)}
 \end{aligned}$$

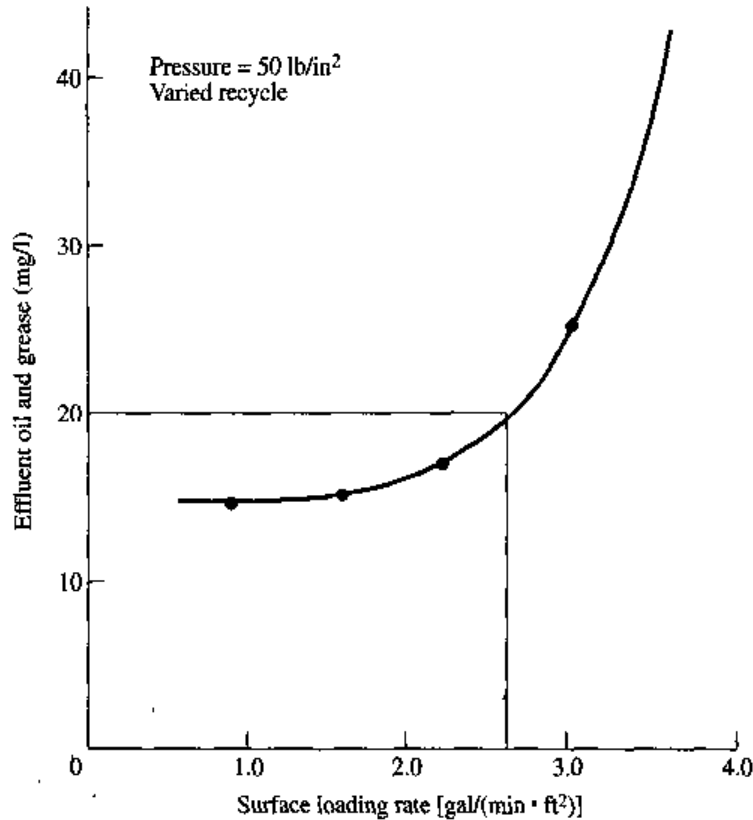


FIGURE 3.43

- (b) The hydraulic loading for oil removal is determined from Fig. 3.43, and is 2.6 gal/(min · ft<sup>2</sup>) [0.11 m<sup>3</sup>/(min · m<sup>2</sup>)] for an effluent of 20 mg/l. The required surface area is

$$\begin{aligned}
 A &= \frac{Q + R}{\text{loading}} \\
 &= \frac{150 + 8.75}{2.6} \\
 &= 61 \text{ ft}^2 (5.7 \text{ m}^2)
 \end{aligned}$$

- (c) Sludge quantities generated:

$$\begin{aligned}
 \text{Oil sludge} &= (120 - 20) \text{ mg/l} \times 150 \text{ gal/min} \times 1440 \text{ min/d} \\
 &\quad \times (\text{million gal}/10^6 \text{ gal}) \left( 8.34 \frac{\text{lb/million gal}}{\text{mg/l}} \right) \\
 &= 180 \text{ lb/d} (82 \text{ kg/d})
 \end{aligned}$$

$$\text{Alum sludge} = 0.64 \text{ mg sludge/mg alum} \times 50 \text{ mg/l alum}$$

$$\times 150 \text{ gal/min}$$

$$\times (1440 \text{ min/d})(\text{million gal}/10^6 \text{ gal})(8.34)$$

$$= 58 \text{ lb/d (26 kg/d)}$$

$$\text{Total sludge} = 238 \text{ lb/d (108 kg/d)}$$

$$\text{Total sludge volume} = 238/0.03 \text{ lb/d (gal/8.34 lb)}(\text{day}/1440 \text{ min})$$

$$= 0.66 \text{ gal/min (2.5 l/min)}$$

### PROBLEMS

- 3.1. An industry is required to equalize its wastewater and discharge it such that the load in BOD/day to a POTW is constant over the 24 h. The POTW sewage flow is 6.47 million gal/d, with a BOD of 200 mg/l. The diurnal sewage variation in flow is shown in Fig. P3.1. The industrial waste flow is 3.17 million gal/d, with a BOD of 1200 mg/l, and is constant over 10 h (8 A.M. to 6 P.M.).
- Compute the volume of equalization (or holding) tank required.
  - Plot the discharge curve of the industrial waste over 24 h.

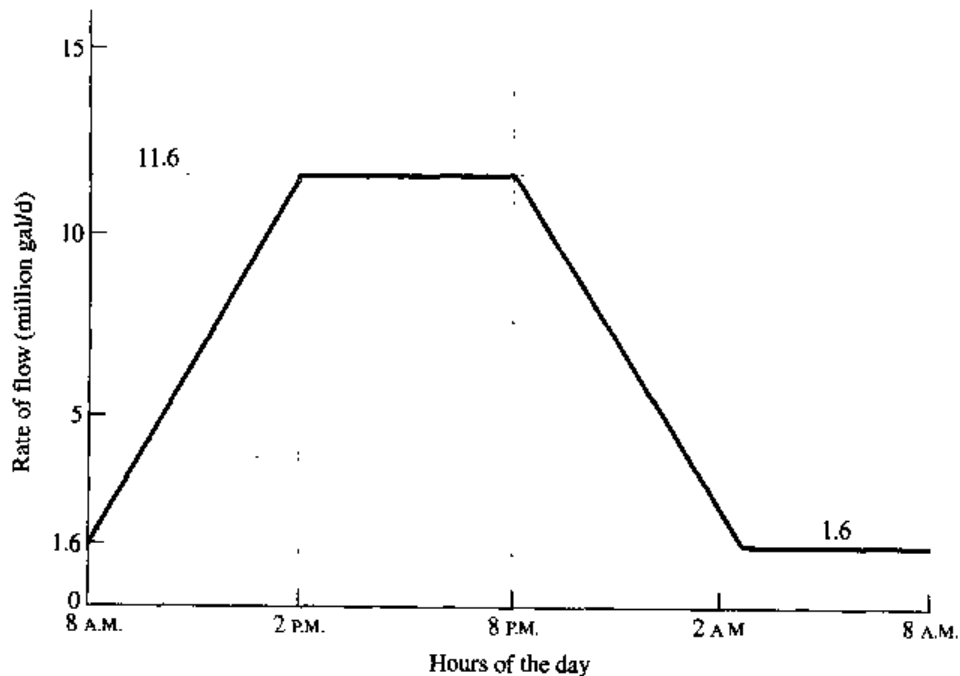


FIGURE P3.1

3.2. A survey of the discharge from a pharmaceutical plant showed the following data.

Time	Flow, gph	COD, mg/l
<b>Day 1</b>		
7:00 A.M.	1025	80
8:00 A.M.	600	55
9:00 A.M.	1200	48
10:00 A.M.	600	45
11:00 A.M.	720	95
12:00 P.M.	1080	66
1:00 P.M.	1200	41
2:00 P.M.	1620	39
3:00 P.M.	1200	29
4:00 P.M.	1320	138
5:00 P.M.	1020	146
6:00 P.M.	720	154
<b>Day 2</b>		
7:00 A.M.	960	47
8:00 A.M.	900	40
9:00 A.M.	1020	139
10:00 A.M.	900	1167
11:00 A.M.	1140	491
12:00 P.M.	1320	163
1:00 P.M.	900	90
2:00 P.M.	1320	143
3:00 P.M.	1200	88
4:00 P.M.	900	35
5:00 P.M.	1140	35
6:00 P.M.	960	47

Compute the volume of an equalization basin to yield a peaking factor of 1.2 and 1.4 based on flow through the system at constant volume and on a constant discharge rate (i.e., variable volume). For the variable-volume case the low level in the basin will be 20 percent of the daily flow.

3.3. An acidic industrial wastewater flow of 150 gal/min ( $0.57 \text{ m}^3/\text{min}$ ) with a peak factor of 1.2 is to be neutralized to pH 6.0 using lime. The titration curve is as follows:

pH	mg lime/l waste
1.8	0
1.9	500
2.05	1000
2.25	1500
3.5	2000
4.1	2100
5.0	2150
7.0	2200

Consider providing the necessary capacity for a maximum 2-week lime requirement for  $\text{pH} = 7.0$  with an hourly requirement 20 percent greater.

Determine:

- The lime feed rate for each stage in a two-stage system.
- The lime storage capacity ( $\text{ft}^3$ ) based on the controlling requirement of either the mean monthly requirement or the maximum two-week requirement. Assume the use of pebbled quicklime ( $\text{CaO}$ ), which has a bulk density of  $65 \text{ lb/ft}^3$  ( $1060 \text{ kg/m}^3$ ).
- The capacity of the lime slaker and mechanism for transporting the bulk lime based on the maximum estimated requirements.
- The mean and maximum slaking water requirements assuming a 10 percent by weight slurry.
- The size of the slurry control tank based on a minimum resident time of 5 minutes.
- The size of the caustic storage tank based on 24-h caustic feed ( $\text{NaOH}$ ) at the maximum extended usage equivalent to a hydrated lime requirement of  $1000 \text{ mg/l}$ . Assume  $\text{NaOH}$  is available with a purity of 98.9 percent and a solubility of  $2.5 \text{ lb/gal}$  ( $300 \text{ kg/m}^3$ ).
- The maximum caustic ( $\text{NaOH}$ ) feed rate for backup of the lime system.

- 3.4. A laboratory settling analysis for a pulp and paper mill effluent gave the following results for  $C_o = 430 \text{ mg/l}$ ,  $T = 29^\circ\text{C}$ :

Time, min	Suspended solids removed at indicated depth, %		
	2 ft	4 ft	6 ft
10	47	27	16
20	50	34	43
30	62	48	47
45	71	52	46
60	76	65	48

Note:  $\text{ft} = 30.5 \text{ cm}$

- Design a settling tank to remove 70 percent of the suspended solids for 1 million gal/d flow ( $3785 \text{ m}^3/\text{d}$ ). (Apply appropriate factors and neglect initial solids effects.)
  - What removal will be attained if the flow is increased to 2 million gal/d ( $7570 \text{ m}^3/\text{d}$ )?
- 3.5. A wastewater has a flow of  $250 \text{ gal/min}$  ( $0.95 \text{ m}^3/\text{min}$ ) and a temperature of  $105^\circ\text{F}$  ( $40.5^\circ\text{C}$ ). The concentration of oil and grease is  $150 \text{ mg/l}$  and the suspended solids  $100 \text{ mg/l}$ . An effluent concentration of  $20 \text{ mg/l}$  is required. An alum dosage of  $30 \text{ mg/l}$  is required. The required  $A/S$  is  $0.04$  and the surface loading rate is  $2 \text{ gal}/(\text{min} \cdot \text{ft}^2)$  [ $0.081 \text{ m}^3/(\text{min} \cdot \text{m}^2)$ ]. The operating pressure is  $65 \text{ lb/in}^2$  gage ( $4.4 \text{ rel. atm}$ ).

Compute:

- The required recycle flow
- The surface area of the unit
- The volume of sludge produced if the skimmings are 3 percent by weight

## REFERENCES

1. Novotny, V., and A. J. England: *Water Res.*, vol. 8, p. 325, 1974.
2. Patterson, J. W., and J. P. Menez: *Am. Inst. Chem. Engrs. Env. Prog.*, vol. 3, p. 2, 1984.
3. Tully, T. J.: *Sewage Ind. Wastes*, vol. 30, p. 1385, 1958.
4. Okey, R. W. et al.: *Proc. 32nd Purdue Industrial Waste Conf.*, Ann Arbor Science Pub., 1977.
5. Hazen, A.: *Trans. ASCE*, vol. 53, p. 45, 1904.
6. Camp, T. R.: *Trans. ASCE*, vol. 111, p. 909, 1946.
7. Dobbins, W. E.: "Advances in Sewage Treatment Design," Sanitary Engineering Division, Met. Section, Manhattan College, May 1961.
8. Committee on Industrial Waste Practice of SED: *J. Sanit. Engrg. Div. ASCE*, December 1964.
9. Sutherland, R.: *Ind. Eng. Chem.*, p. 630, May 1947.
10. Greenfield, R. E., and G. N. Cornell: *Ind. Eng. Chem.*, p. 583, May 1947.
11. American Petroleum Institute: *Manual on Disposal of Refinery Wastes*, vol. 1, New York, 1959.
12. Azad, H. S. (editor): *Industrial Wastewater Management Handbook*, McGraw-Hill, New York, 1976.
13. Ford, D. L., private communication.
14. Galil, N., and M. Rebhum: *Water Sci. Tech.*, vol. 27, no. 7-8, p. 79, 1993.
15. Jones, H. R.: *Pollution Control in the Petroleum Industry*, Noyes Data Corp., Princeton, New Jersey, 1973.
16. Pray, H. A.: *Ind. Eng. Chem.*, vol. 44, pt. 1, p. 146, 1952.
17. Frolich, R.: *Ind. Eng. Chem.*, vol. 23, p. 548, 1931.
18. Vrablick, E. R.: *Proc. 14th Ind. Waste Conf.*, 1959, Purdue University.
19. Hurwitz, E., and W. J. Katz: "Laboratory Experiments on Dewatering Sewage Sludges by Dissolved Air Flotation," unpublished report, Chicago, 1959.

---

## COAGULATION, PRECIPITATION, AND METALS REMOVAL

---

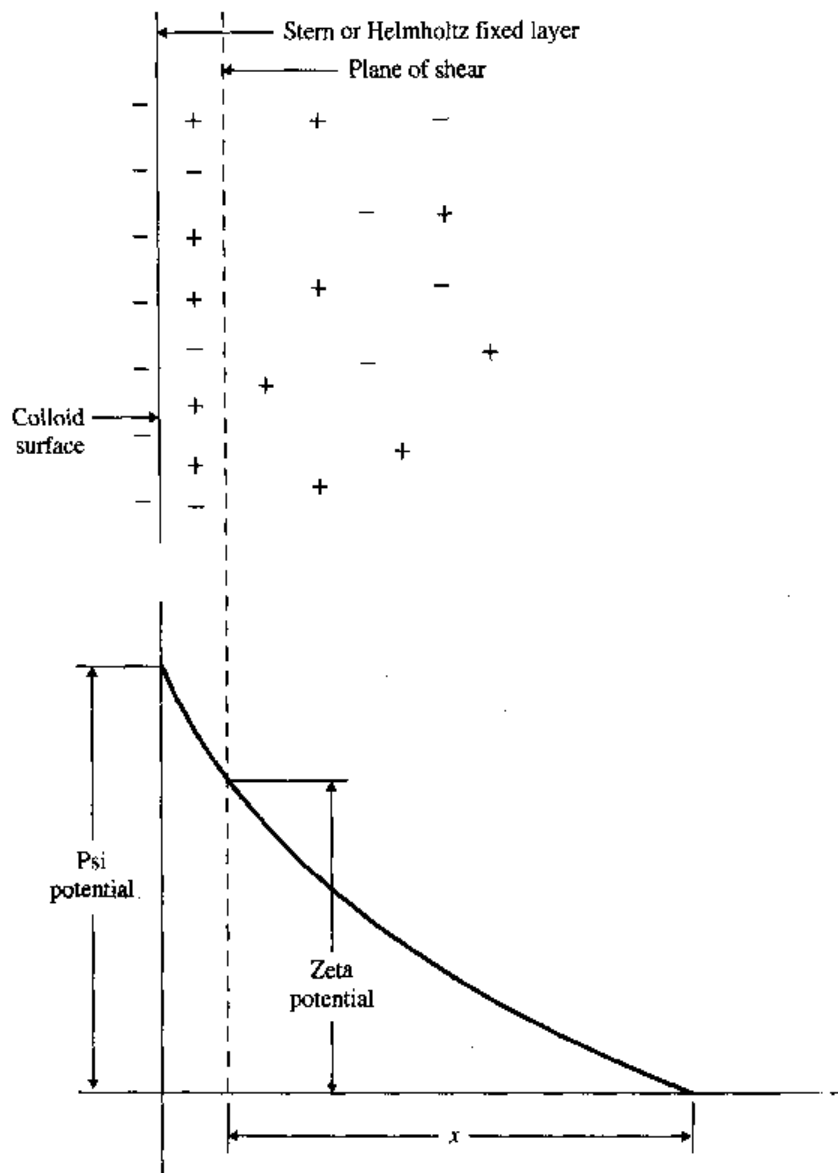
### 4.1 COAGULATION

Coagulation is employed for the removal of waste materials in suspended or colloidal form. Colloids are particles within the size range of 1 nm ( $10^{-7}$  cm) to 0.1 nm ( $10^{-8}$  cm). These particles do not settle out on standing and cannot be removed by conventional physical treatment processes.

Colloids present in wastewater can be either hydrophobic or hydrophilic. The hydrophobic colloids (clays, etc.) possess no affinity for the liquid medium and lack stability in the presence of electrolytes. They are readily susceptible to coagulation. Hydrophilic colloids, such as proteins, exhibit a marked affinity for water. The absorbed water retards flocculation and frequently requires special treatment to achieve effective coagulation.<sup>1</sup>

Colloids possess electrical properties which create a repelling force and prevent agglomeration and settling. Stabilizing ions are strongly absorbed to an inner fixed layer which provides a particle charge that varies with the valence and number of adsorbed ions. Ions of an opposite charge form a diffuse outer layer which is held near the surface by electrostatic forces. The psi ( $\psi$ ) potential is defined as the potential drop between the interface of the colloid and the body of solution. The zeta potential ( $\zeta$ ) is the potential drop between the slipping plane and the body of solution and is related to the particle charge and the thickness of the double layer. The thickness of the double layer ( $\chi$ ) is inversely proportional to the concentration and valence of nonspecific electrolytes, as shown in Fig. 4.1. A van der Waals attractive force is effective in close proximity to the colloidal particle.

The stability of a colloid is due to the repulsive electrostatic forces, and in the case of hydrophilic colloids, also to solvation in which an envelope of water retards coagulation.



**FIGURE 4.1**  
Electrochemical properties of a colloidal particle.

### Zeta Potential

Since the stability of a colloid is primarily due to electrostatic forces, neutralization of this charge is necessary to induce flocculation and precipitation. Although it is not possible to measure the psi potential, the zeta potential can be determined, and hence the magnitude of the charge and resulting degree of stability can be determined as well. The zeta potential is defined as

$$\zeta = \frac{4\pi\eta v}{\epsilon X} = \frac{4\pi\eta EM}{\epsilon} \quad (4.1)$$



where  $v$  = particle velocity  
 $\epsilon$  = dielectric constant of the medium  
 $\eta$  = viscosity of the medium  
 $X$  = applied potential per unit length of cell  
 EM = electrophoretic mobility

For practical usage in the determination of the zeta potential, Eq. (4.1) can be re-expressed:

$$\zeta \text{ (mV)} = \frac{113,000}{\epsilon} \eta(\text{poise}) \text{EM} \left( \frac{\mu\text{m/s}}{\text{V/cm}} \right) \quad (4.2)$$

where EM = electrophoretic mobility,  $(\mu\text{m/s})/(\text{V/cm})$ .

At 25°C, Eq. (4.2) reduces to

$$\zeta = 12.8 \text{ EM} \quad (4.3)$$

The zeta potential is determined by measurement of the mobility of colloidal particles across a cell, as viewed through a microscope.<sup>2,3</sup> Several types of apparatus are commercially available for this purpose. A recently developed Lazer Zee meter does not track individual particles, but rather adjusts the image to produce a stationary cloud of particles using a rotating prism technique. This apparatus is shown in Fig. 4.2. The computations involved in determining the zeta potential are illustrated in Example 4.1.

**EXAMPLE 4.1.** In a electrophoresis cell 10 cm in length, grid divisions are  $160 \mu\text{m}$  at  $6 \times$  magnification. Compute the zeta potential at an impressed voltage of 35 V. The time of travel between grid divisions is 42 s and the temperature is 20°C.

**Solution.**

At 20°C:

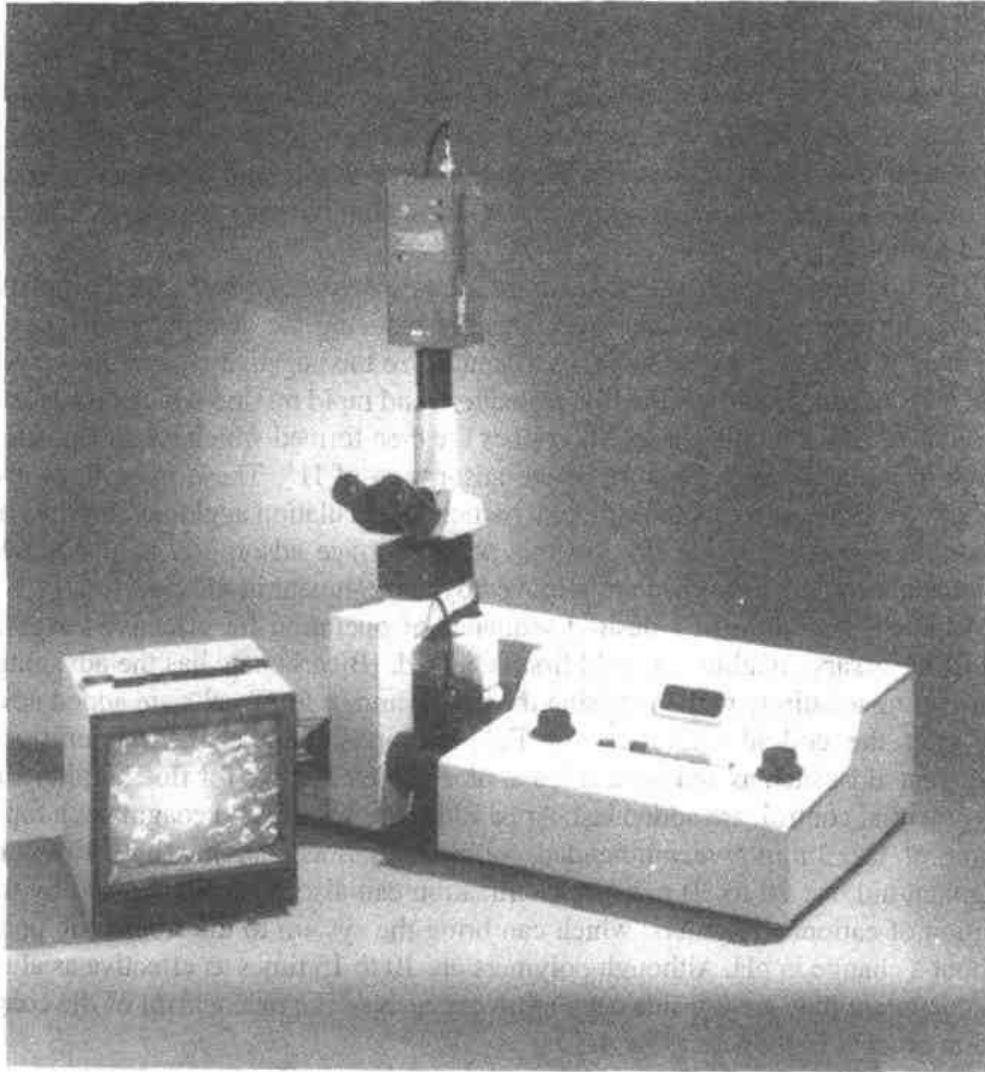
$$\eta = 0.01 \text{ poise}$$

$$\epsilon = 80.36$$

$$\text{EM} = \frac{v}{X} = \frac{160 \mu\text{m}/42 \text{ s}}{35 \text{ V}/10 \text{ cm}} = 1.09 \left( \frac{\mu\text{m/s}}{\text{V/cm}} \right)$$

$$\begin{aligned} \zeta(\text{mV}) &= 113,000 \times \frac{\eta(\text{poise}) \text{EM}(\mu\text{m/s})/(\text{V/cm})}{\epsilon} \\ &= 113,000 \times \frac{0.01 \times 1.09}{80.36} \\ &= 15.3 \text{ mV} \end{aligned}$$

Since there will usually be a statistical variation in the mobility of individual particles, around 20 to 30 values should be averaged for any one determination. The magnitude of the zeta potential for water and waste colloids has been found to average from  $-16$  to  $-22$  mV with a range of  $-12$  to  $-40$  mV.<sup>3</sup> The zeta potential is unaffected by pH over a range of pH 5.5 to 9.5.

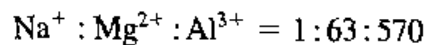
**FIGURE 4.2**

Lazer Zee meter for zeta potential measurement (*courtesy of Penkem Inc.*).

The zeta potential is lowered by:

1. Change in the concentration of the potential determining ions.
2. Addition of ions of opposite charge.
3. Contraction of the diffuse part of the double layer by increase in the ion concentration in solution.

Since a vast majority of colloids in industrial wastes possess a negative charge, the zeta potential is lowered and coagulation is induced by the addition of high-valence cations. The precipitating power or effectiveness of cation valence in the precipitation of arsenious oxide is



Optimum coagulation will occur when the zeta potential is zero; this is defined as the isoelectric point. Effective coagulation will usually occur over a zeta potential range of  $\pm 0.5$  mV.

## Mechanism of Coagulation

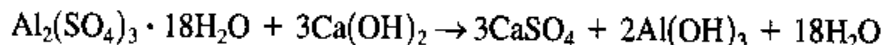
Coagulation results from two basic mechanisms: perikinetic (or electrokinetic) coagulation, in which the zeta potential is reduced by ions or colloids of opposite charge to a level below the van der Waals attractive forces, and orthokinetic coagulation, in which the micelles aggregate and form clumps that agglomerate the colloidal particles.

The addition of high-valence cations depresses the particle charge and the effective distance of the double layer, thereby reducing the zeta potential. As the coagulant dissolves, the cations serve to neutralize the negative charge on the colloids. This occurs before visible floc formation, and rapid mixing which "coats" the colloid is effective in this phase. Microflocs are then formed which retain a positive charge in the acid range because of the adsorption of  $H^+$ . These microflocs also serve to neutralize and coat the colloidal particle. Flocculation agglomerates the colloids with a hydrous oxide floc. In this phase, surface adsorption is also active. Colloids not initially adsorbed are removed by enmeshment in the floc.

Riddick<sup>3</sup> has outlined a desired sequence of operation for effective coagulation. If necessary, alkalinity should first be added. (Bicarbonate has the advantage of providing alkalinity without raising the pH.) Alum or ferric salts are added next; they coat the colloid with  $Al^{3+}$  or  $Fe^{3+}$  and positively charged microflocs. Coagulant aids, such as activated silica and/or polyelectrolyte for floc buildup and zeta potential control, are added last. After addition of alkali and coagulant, a rapid mixing of 1 to 3 min is recommended, followed by flocculation, with addition of coagulant aid, for 20 to 30 min. Destabilization can also be accomplished by the addition of cationic polymers, which can bring the system to the isoelectric point without a change in pH. Although polymers are 10 to 15 times as effective as alum as a coagulant they are considerably more expensive. The mechanism of the coagulation process is shown in Fig. 4.3.

## Properties of Coagulants

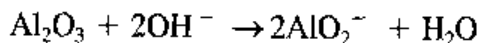
The most popular coagulant in waste-treatment application is aluminum sulfate, or alum  $[Al_2(SO_4)_3 \cdot 18H_2O]$ , which can be obtained in either solid or liquid form. When alum is added to water in the presence of alkalinity, the reaction is



The aluminum hydroxide is actually of the chemical form  $Al_2O_3 \cdot xH_2O$  and is amphoteric in that it can act as either an acid or a base. Under acidic conditions

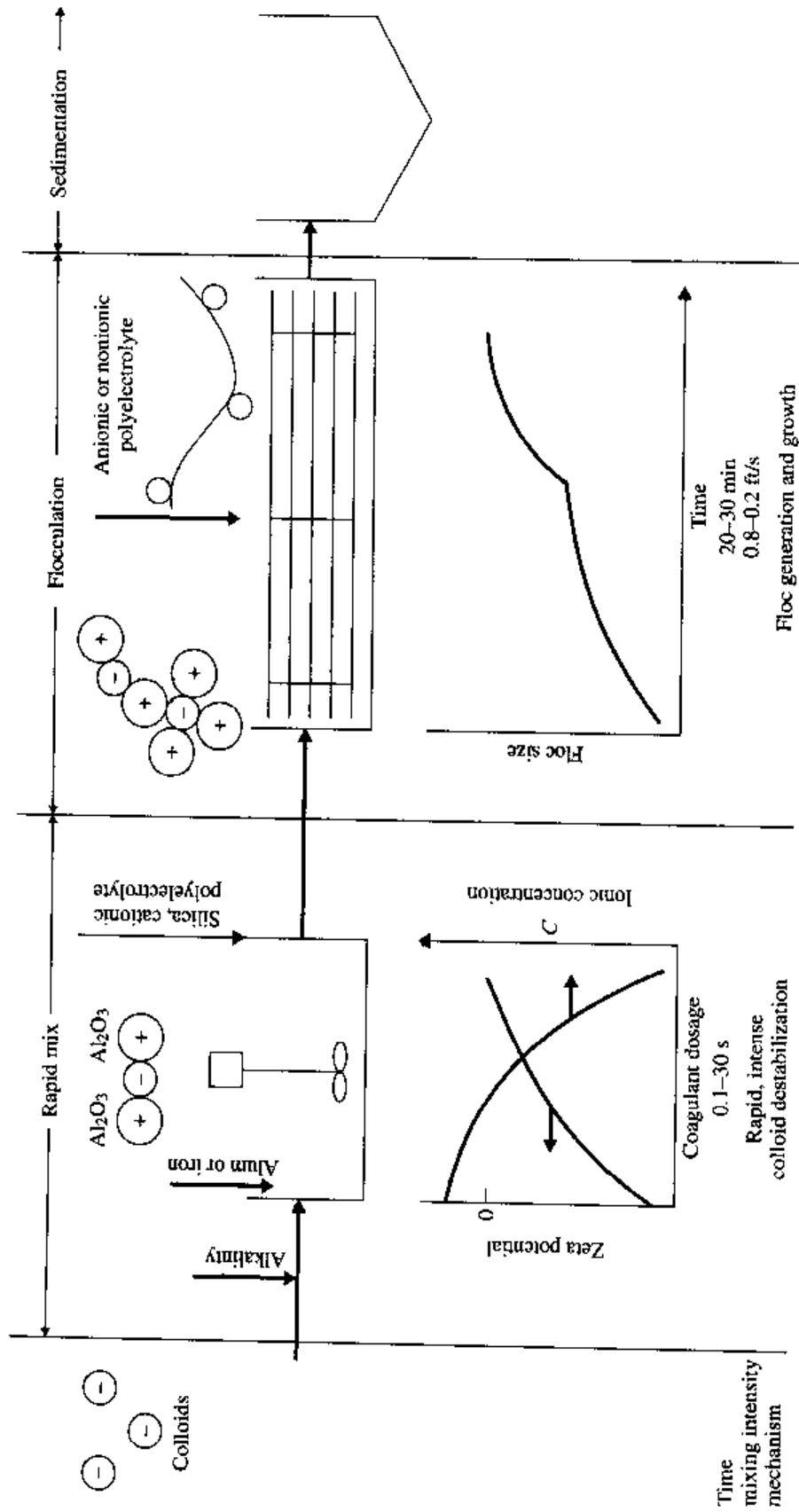
$$[Al^{3+}][OH^-]^3 = 1.9 \times 10^{-33}$$

At pH 4.0, 51.3 mg/l of  $Al^{3+}$  is in solution. Under alkaline conditions, the hydrous aluminum oxide dissociates:



$$[AlO_2^-][H^+] = 4 \times 10^{-13}$$

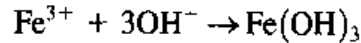
At pH 9.0, 10.8 mg/l of aluminum is in solution.



**FIGURE 4.3**  
Mechanisms of coagulation.

The alum floc is least soluble at a pH of approximately 7.0. The floc charge is positive below pH 7.6 and negative above pH 8.2. Between these limits the floc charge is mixed. These relationships with respect to the zeta potential are shown in Fig. 4.4. High alum dosages used in the treatment of some industrial wastes may bring about postprecipitation of alum floc, depending on the pH of flocculation.

Ferric salts are also commonly used as coagulants but have the disadvantage of being more difficult to handle. An insoluble hydrous ferric oxide is produced over a pH range of 3.0 to 13.0:

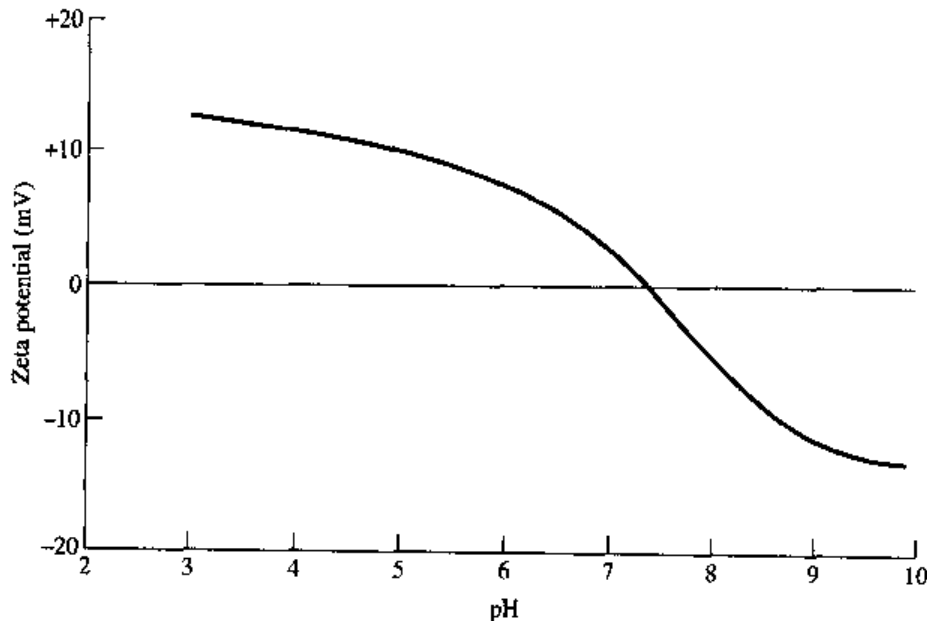


$$[\text{Fe}^{3+}] [\text{OH}^-]^3 = 10^{-36}$$

The floc charge is positive in the acid range and negative in the alkaline range, with mixed charges over the pH range 6.5 to 8.0.

The presence of anions will alter the range of effective flocculation. Sulfate ion will increase the acid range but decrease the alkaline range. Chloride ion increases the range slightly on both sides.

Lime is not a true coagulant but reacts with bicarbonate alkalinity to precipitate calcium carbonate and with *ortho*-phosphate to precipitate calcium hydroxyapatite. Magnesium hydroxide precipitates at high pH levels. Good clarification usually requires the presence of some gelatinous  $\text{Mg}(\text{OH})_2$ , but this makes the sludge more difficult to dewater. Lime sludge can frequently be thickened, dewatered, and calcined to convert calcium carbonate to lime for reuse.



**FIGURE 4.4**

Zeta potential-pH plot for electrolytic aluminum hydroxide (after Riddick<sup>3</sup>).

## Coagulant Aids

The addition of some chemicals will enhance coagulation by promoting the growth of large, rapid-settling flocs. Activated silica is a short-chain polymer that serves to bind together particles of microfine aluminum hydrate. At high dosages, silica will inhibit floc formation because of its electronegative properties. The usual dosage is 5 to 10 mg/l.

Polyelectrolytes are high-molecular-weight polymers which contain adsorbable groups and form bridges between particles or charged flocs. Large flocs (0.3 to 1 mm) are thus created when small dosages of polyelectrolyte (1 to 5 mg/l) are added in conjunction with alum or ferric chloride. The polyelectrolyte is substantially unaffected by pH and can serve as a coagulant itself by reducing the effective charge on a colloid. There are three types of polyelectrolytes: a cationic, which adsorbs on a negative colloid or floc particle; an anionic, which replaces the anionic groups on a colloidal particle and permits hydrogen bonding between the colloid and the polymer; and a nonionic, which adsorbs and flocculates by hydrogen bonding between the solid surfaces and the polar groups in the polymer. The general application of coagulants is shown in Table 4.1.

## Laboratory Control of Coagulation

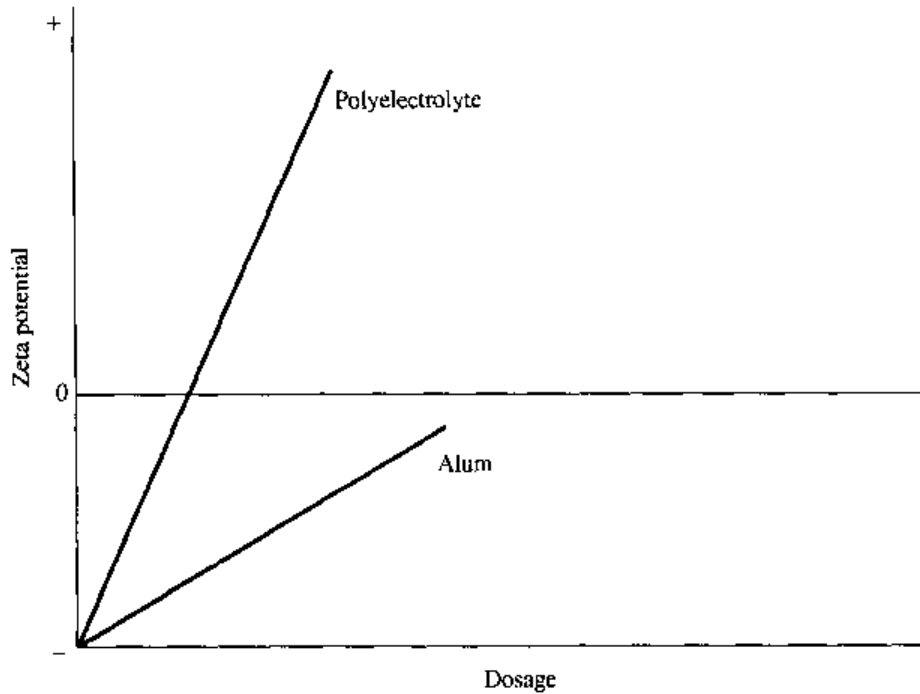
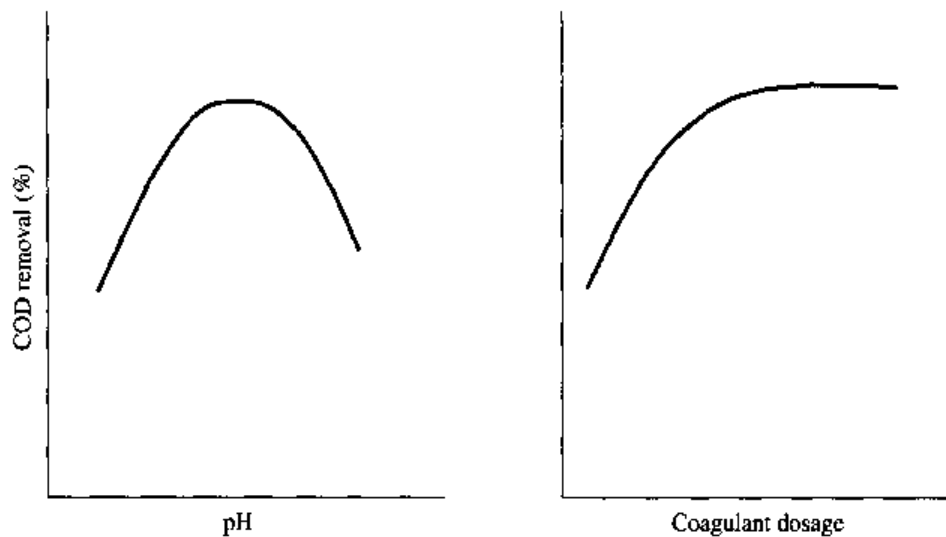
Because of the complex reactions involved, laboratory experimentation is essential to establish the optimum pH and coagulant dosage for coagulation of a wastewater. Two procedures can be followed for this purpose: the jar test, in which pH and coagulant dosage are varied to attain the optimum operating conditions; and zeta potential control as proposed by Riddick,<sup>3</sup> in which coagulant is added to zero zeta potential. The procedures to determine the optimum coagulant dosage using these two tests are outlined below:

1. By zeta potential measurement:<sup>3</sup>
  - (a) Place 1000 ml of sample in a beaker.
  - (b) Add the coagulant in known increments. (The optimum pH should be established either by zeta potential or by a jar-test procedure.)
  - (c) Rapid-mix the sample for 3 min after each addition of coagulant; follow with a slow mix.
  - (d) Determine the zeta potential after each reagent addition and plot the results as shown in Fig. 4.5. To maintain constant volume, return the sample after each determination.
  - (e) If a polyelectrolyte is to be used as a coagulant aid, it should be added last.
2. By jar-test procedure:
  - (a) Using 200 ml of sample on a magnetic stirrer, add coagulant in small increments at a pH of 6.0. After each addition, provide a 1-min rapid mix followed by a 3-min slow mix. Continue addition until a visible floc is formed.
  - (b) Using this dosage, place 1000 ml of sample in each of six beakers.
  - (c) Adjust the pH to 4.0, 5.0, 6.0, 7.0, 8.0, and 9.0 with standard alkali.

TABLE 4.1  
Chemical coagulant applications

Chemical process	Dosage range, mg/l	pH	Comments
Lime	150-500	9.0-11.0	For colloid coagulation and P removal Wastewater with low alkalinity, and high and variable P Basic reactions: $\text{Ca(OH)}_2 + \text{Ca(HCO}_3)_2 \rightarrow 2\text{CaCO}_3 + 2\text{H}_2\text{O}$ $\text{MgCO}_3 + \text{Ca(OH)}_2 \rightarrow \text{Mg(OH)}_2 + \text{CaCO}_3$
Alum	75-250	4.5-7.0	For colloid coagulation and P removal Wastewater with high alkalinity and low and stable P Basic reactions: $\text{Al}_2(\text{SO}_4)_3 + 6\text{H}_2\text{O} \rightarrow 2\text{Al(OH)}_3 + 3\text{H}_2\text{SO}_4$
$\text{FeCl}_3$ , $\text{FeCl}_2$	35-150	4.0-7.0	For colloid coagulation and P removal
$\text{FeSO}_4 \cdot 7\text{H}_2\text{O}$	70-200	4.0-7.0	Wastewater with high alkalinity and low and stable P Where leaching of iron in the effluent is allowable or can be controlled Where economical source of waste iron is available (steel mills, etc.) Basic reactions: $\text{FeCl}_3 + 3\text{H}_2\text{O} \rightarrow \text{Fe(OH)}_3 + 3\text{HCl}$
Cationic polymers	2-5	No change	For colloid coagulation or to aid coagulation with a metal Where the buildup of an inert chemical is to be avoided
Anionic and some nonionic polymers	0.25-1.0	No change	Use as a flocculation aid to speed flocculation and settling and to toughen floc for filtration
Weighting aids and clays	3-20	No change	Used for very dilute colloidal suspensions for weighting

- (d) Rapid-mix each sample for 3 min; follow this with 12-min flocculation at slow speed.
- (e) Measure the effluent concentration of each settled sample.
- (f) Plot the percent removal of characteristic versus pH and select the optimum pH (Fig. 4.6).
- (g) Using this pH, repeat steps (b), (d), and (e), varying the coagulant dosage.
- (h) Plot the percent removal versus the coagulant dosage and select the optimum dosage (Fig. 4.6).
- (i) If a polyelectrolyte is used, repeat the procedure, adding polyelectrolyte toward the end of a rapid mix.

**FIGURE 4.5****FIGURE 4.6**  
Characteristic plots of jar-test analysis.

### Coagulation Equipment

There are two basic types of equipment adaptable to the flocculation and coagulation of industrial wastes. The conventional system uses a rapid-mix tank, followed by a flocculation tank containing longitudinal paddles which provide slow mixing. The flocculated mixture is then settled in conventional settling tanks.

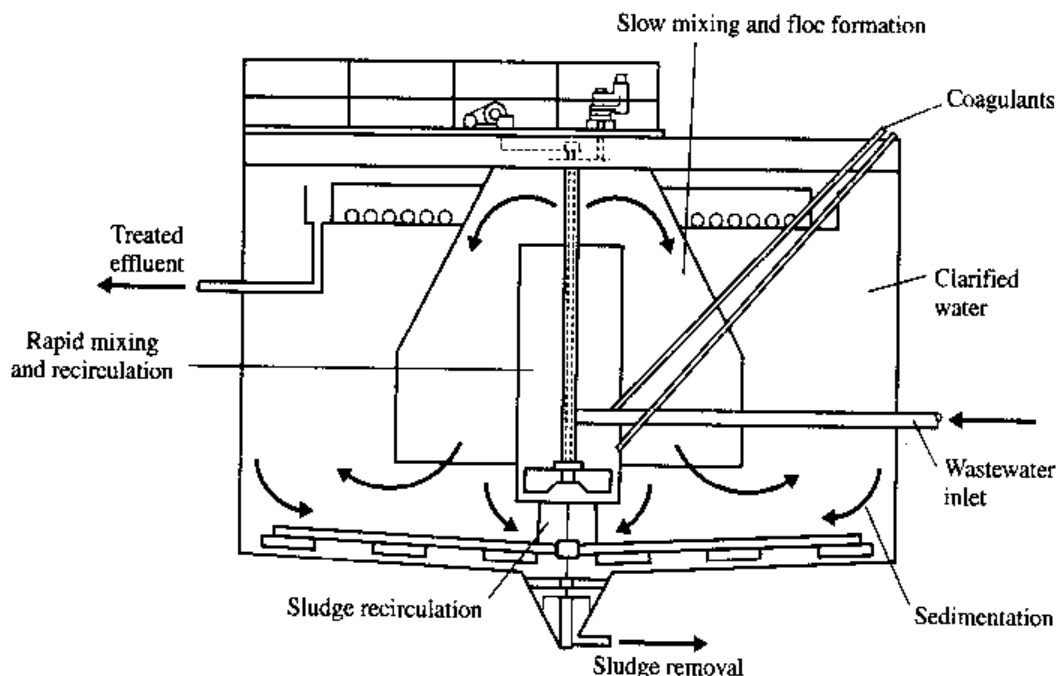


A sludge-blanket unit combines mixing, flocculation, and settling in a single unit. Although colloidal destabilization might be less effective than in the conventional system, there are distinct advantages in recycling preformed floc. With lime and a few other coagulants, the time required to form a settleable floc is a function of the time necessary for calcium carbonate or other calcium precipitates to form nuclei on which other calcium materials can deposit and grow large enough to settle. It is possible to reduce both coagulant dosage and the time of floc formation by seeding the influent wastewater with previously formed nuclei or by recycling a portion of the precipitated sludge. Recycling preformed floc can frequently reduce chemical dosages, the blanket serves as a filter for improved effluent clarity, and denser sludges are frequently attainable. A sludge-blanket unit is shown in Fig. 4.7.

### Coagulation of Industrial Wastes

Coagulation may be used for the clarification of industrial wastes containing colloidal and suspended solids. Paperboard wastes can be effectively coagulated with low dosages of alum. Silica or polyelectrolyte will aid in the formation of a rapid-settling floc. Typical data reported are summarized in Table 4.2.

Wastes containing emulsified oils can be clarified by coagulation.<sup>7</sup> An emulsion can consist of droplets of oil in water. The oil droplets are of approximately  $10^{-5}$  cm and are stabilized by adsorbed ions. Emulsifying agents include soaps and anion-active agents. The emulsion can be broken by "salting out" with the addition of salts, such as  $\text{CaCl}_2$ . Flocculation will then effect charge neutralization and entrainment, resulting in clarification. An emulsion can also frequently be broken by lowering of the pH of the waste solution. An example of such a waste is that



**FIGURE 4.7**

A reactor clarifier designed for both coagulation and settling.

TABLE 4.2  
Chemical treatment of paper and paperboard wastes

Waste	Influent			Effluent			Coagulants			Sludge, % solids	Remarks	Reference
	BOD, ppm	SS, ppm	pH	BOD, ppm	SS, ppm	pH	Alum, ppm	Silica, ppm	Other, ppm			
Board	350-450			15-60			3	5		1.7	2-4	4
Board	140-420			10-40			1		10 <sup>†</sup>	0.3	2	4
Board	240-600			35-85						2.0	2-5	5
Board <sup>‡</sup>	127	593	6.7	44		6.7	10-12	10		1.3	1.76	5
Tissue	140	720		10-15			2	4				6
Tissue	208		6.6	33				4				6

<sup>†</sup> Gluc.

<sup>‡</sup> 15,000 gal/ton waste paper.

Note:

gal/(d · ft<sup>2</sup>) = 4.075 × 10<sup>-2</sup> m<sup>3</sup>/(d · m<sup>2</sup>)

gal/ton = 4.17 × 10<sup>-3</sup> m<sup>3</sup>/t

produced by ball-bearing manufacture, which contains cleaning soaps and detergents, water-soluble grinding oils, cutting oils, and phosphoric acid cleaners and solvents. Treatment of this waste has been effected by the use of 800 mg/l alum, 450 mg/l  $H_2SO_4$ , and 45 mg/l polyelectrolyte. The results obtained are summarized in Table 4.3a.

The presence of anionic surface agents in a waste will increase the coagulant dosage. The polar head of the surfactant molecule enters the double layer and stabilizes the negative colloids. Industrial laundry wastes have been treated with  $H_2SO_4$  followed by lime and alum; this has resulted in a reduction of COD of 12,000 mg/l to 1800 mg/l and a reduction of suspended solids of 1620 mg/l to 105 mg/l. Chemical dosages of 1400 mg/l  $H_2SO_4$ , 1500 mg/l lime, and 300 mg/l alum were required, yielding 25 percent by volume of settled sludge.

Laundromat wastes containing synthetic detergent have been coagulated with a cationic surfactant to neutralize the anionic detergent and the addition of a calcium salt to provide a calcium phosphate precipitate for flocculation. Typical

TABLE 4.3  
Coagulation of industrial wastewaters

(a) Ball bearing manufacture <sup>1</sup>		
	Analysis	
	Influent	Effluent
pH	10.3	7.1
Suspended solids, mg/l	544	40
Oil and grease, mg/l	302	28
Fe, mg/l	17.9	1.6
PO <sub>4</sub> , mg/l	222	8.5
(b) Laundromat		
	Influent, mg/l	Effluent, mg/l
ABS	63	0.1
BOD	243	90
COD	512	171
PO <sub>4</sub>	267	150
CaCl <sub>2</sub>	480	
Cationic surfactant	88	
pH	7.1	7.7
(c) Latex-base paint manufacture <sup>2</sup>		
	Influent, mg/l	Effluent, mg/l
COD	4340	178
BOD	1070	90
Total solids	2550	446

<sup>1</sup>800 mg/l alum, 450 mg/l  $H_2SO_4$ , 45 mg/l polyelectrolyte.

<sup>2</sup>345 mg/l alum, pH 3.5-4.0.

results obtained are summarized in Table 4.3*b*. Operating the system above pH 8.5 will produce nearly complete phosphate removal.

BOD removals of 90 percent have been achieved on laundry wastes at pH 6.4 to 6.6 with coagulant dosages of 2 lb  $\text{Fe}_2(\text{SO}_4)_3$ /thousand gal waste<sup>12</sup> (0.24 kg/m<sup>3</sup>).

Polymer waste from latex manufacture has been coagulated with 500 mg/l ferric chloride and 200 mg/l lime at pH 9.6. COD and BOD reductions of 75 and 94 percent, respectively, were achieved from initial values of 1000 mg/l and 120 mg/l. The resulting sludge was 1.2 percent solids by weight, containing 101 lb solids/thousand gal waste (12 kg/m<sup>3</sup>) treated. Waste from the manufacture of latex base paints<sup>8</sup> has been coagulated with 345 mg/l alum at pH 3.0 to 4.0, yielding 20.5 lb sludge/thousand gal waste (2.5 kg/m<sup>3</sup>) of 2.95 percent solids by weight. The treatment results are summarized in Table 4.3*c*. Wastes from paint-spray booths in automobile assembly plants have been clarified with 400 mg/l  $\text{FeSO}_4$  at pH 7.0, yielding 8 percent sludge by weight.

Synthetic rubber wastes have been treated at pH 6.7 with 100 mg/l alum, yielding a sludge that was 2 percent of the original waste volume. COD was reduced from 570 to 100 mg/l, and BOD from 85 to 15 mg/l.

Vegetable-processing wastes have been coagulated<sup>9</sup> with lime, yielding BOD removals of 35 to 70 percent with lime dosages of approximately 0.5 lb lime/lb influent BOD (0.5 kg/kg). Results from the coagulation of textile wastewaters are shown in Table 4.4 and color removal from pulp and paper mill effluents in Table 4.5.

BOD removals of 75 to 80 percent have been obtained on wool-scouring wastes with 1 to 3 lb  $\text{CaCl}_2$ /lb BOD (1 to 3 kg/kg). Carbonation was used for pH control.<sup>13</sup>

Talinli<sup>14</sup> treated tannery wastewaters with 2000 mg/l lime at pH 11 and 2 mg/l nonionic polyelectrolyte, as shown in Table 4.6. The resulting sludge volume was 30 percent.

TABLE 4.4  
Coagulation of textile wastewaters<sup>10</sup>

Plant	Coagulant	Dosage, mg/l	pH	Color <sup>†</sup>		COD	
				Influent	Removal, %	Influent, mg/l	Removal, %
1	$\text{Fe}_2(\text{SO}_4)_3$	250	7.5–11.0	0.25	90	584	33
	Alum	300	5–9		86		39
	Lime	1200			68		30
2	$\text{Fe}_2(\text{SO}_4)_3$	500	3–4, 9–11	0.74	89	840	49
	Alum	500	8.5–10		89		40
	Lime	2000			65		40
3	$\text{Fe}_2(\text{SO}_4)_3$	250	9.5–11	1.84	95	825	38
	Alum	250	6–9		95		31
	Lime	600			78		50
4	$\text{Fe}_2(\text{SO}_4)_3$	1000	9–11	4.60	87	1570	31
	Alum	750	5–6		89		44
	Lime	2500			87		44

<sup>†</sup> Color sum of absorbances at wavelengths of 450, 550, and 650 nm.

TABLE 4.5  
Color removal from pulp and paper mill effluents<sup>11</sup>

Plant	Coagulant	Dosage, mg/l	pH	Color		COD	
				Influent	Removal, %	Influent, mg/l	Removal, %
1	Fe <sub>2</sub> (SO <sub>4</sub> ) <sub>3</sub>	500	3.5-4.5	2250	92	776	60
	Alum	400	4.0-5.0		92		53
	Lime	1500	—		92		38
2	Fe <sub>2</sub> (SO <sub>4</sub> ) <sub>3</sub>	275	3.5-4.5	1470	91	480	53
	Alum	250	4.0-5.5		93		48
	Lime	1000	—		85		45
3	Fe <sub>2</sub> (SO <sub>4</sub> ) <sub>3</sub>	250	4.5-5.5	940	85	468	53
	Alum	250	5.0-6.5		91		44
	Lime	1000	—		85		40

TABLE 4.6  
Coagulation of tannery wastewaters<sup>14</sup>

Parameter	Influent	Effluent	% Removal
COD	7800	2900	63
BOD	3500	1450	58
SO <sub>4</sub>	1800	1200	33
Chromium	100	3	97

## 4.2 HEAVY METALS REMOVAL

There are a number of technologies available for the removal of heavy metals from a wastewater. These are summarized in Table 4.7. Chemical precipitation is most commonly employed for most of the metals. Common precipitants include OH<sup>-</sup>, CO<sub>3</sub><sup>2-</sup> and S<sup>2-</sup>. Metals are precipitated as the hydroxide through the addition of lime or caustic to a pH of minimum solubility. However, several of these compounds are amphoteric and exhibit a point of minimum solubility. The pH of minimum solubility varies with the metal in question as shown in Fig. 4.8. Metals can also be precipitated as the sulfide (Fig. 4.8) or in some cases as the carbonate (Fig. 4.9).

In treating industrial wastewaters containing metals, it is frequently necessary to pretreat the wastewaters to remove substances that will interfere with the precipitation of the metals. Cyanide and ammonia form complexes with many metals that limit the removal that can be achieved by precipitation as shown in Fig. 4.10 for the case of ammonia. Cyanide can be removed by alkaline chlorination or other processes such as catalytic oxidation of carbon. Cyanide wastewaters containing nickel or silver are difficult to treat by alkaline chlorination because of the slow reaction rate of these metal complexes. Ferrocyanide [Fe(CN)<sub>6</sub><sup>4-</sup>] is oxidized to ferricyanide [Fe(CN)<sub>6</sub><sup>3-</sup>], which resists further oxidation. Ammonia can

TABLE 4.7  
Heavy metals removal technologies

---

Conventional precipitation
Hydroxide
Sulfide
Carbonate
Coprecipitation
Enhanced precipitation
Dimethyl thio carbamate
Diethyl thio carbamate
Trimercapto-s-triazine, trisodium salt
Other methods
Ion exchange
Adsorption
Recovery opportunities
Ion exchange
Membranes
Electrolytic techniques

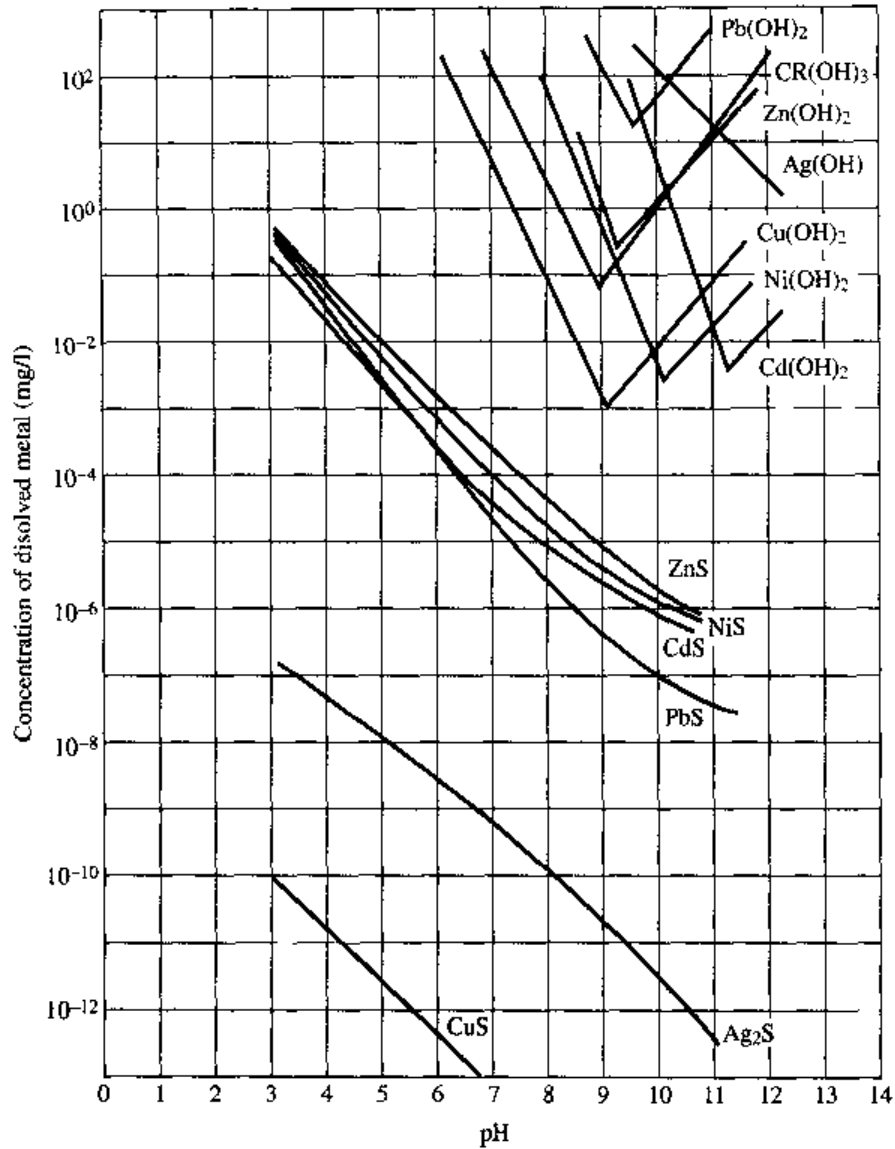
---

be removed by stripping, break-point chlorination, or other suitable methods prior to the removal of metals.

For many metals, such as arsenic and cadmium, coprecipitation with iron or aluminum is highly effective for removal to low residual levels. In this case the metal adsorbs to the alum or iron floc. In order to meet low effluent requirements, it may be necessary in some cases to provide filtration to remove floc carried over from the precipitation process. With precipitation and clarification alone, effluent metals concentrations may be as high as 1 to 2 mg/l. Filtration should reduce these concentrations to 0.5 mg/l or less. Carbamate salts can be employed for enhanced precipitation. Because of the chemical cost, this type of precipitation is usually employed as a polishing step following conventional precipitation. Typical results are shown in Table 4.8. Metals can be removed by adsorption on activated carbon (see p. 442), aluminum oxides, silica, clays, and synthetic material such as zeolites and resins (see Chap. 9). In the case of adsorption, higher pH favors the adsorption of cations while a lower pH favors the adsorption of anions. Complexing agents will interfere with cationic species. There will be competition from major background ions such as calcium or sodium. For chromium waste treatment, hexavalent chromium must first be reduced to the trivalent state,  $\text{Cr}^{3+}$ , and then precipitated with lime. This is referred to as the process of reduction and precipitation.

### Arsenic

Arsenic and arsenical compounds are present in wastewaters from the metallurgical industry, glassware and ceramic production, tannery operation, dyestuff manufacture,

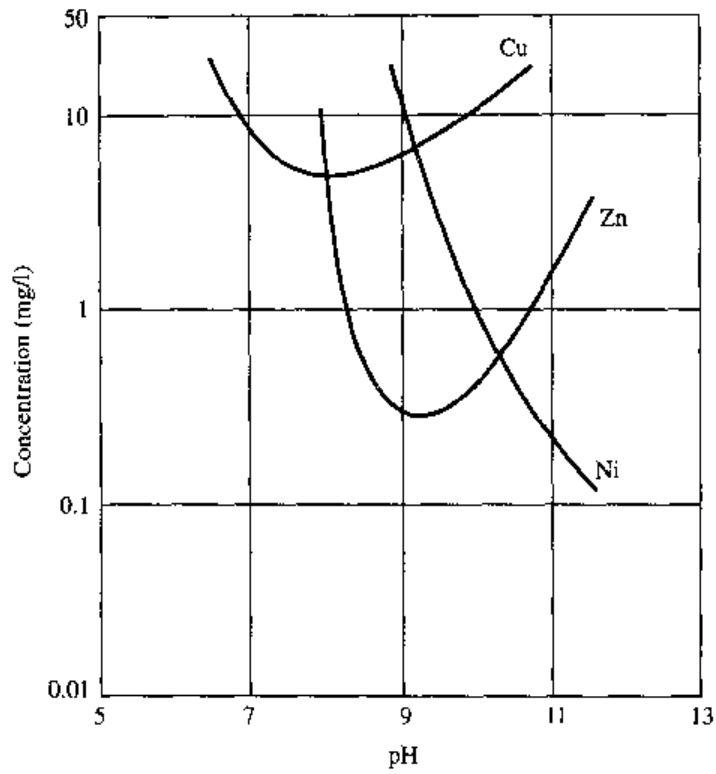


**FIGURE 4.8**

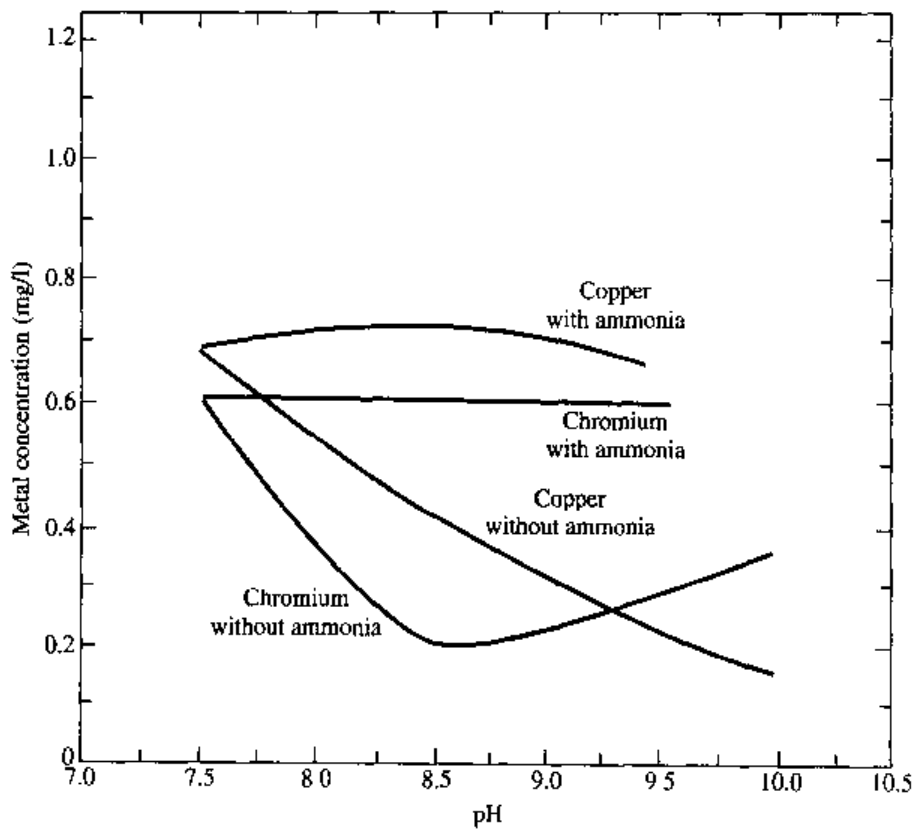
Heavy metals precipitation as the hydroxide and the sulfide.

pesticide manufacture, some organic and inorganic chemicals manufacture, petroleum refining, and the rare-earth industry. Arsenic is removed from wastewater by chemical precipitation. Enhanced performance is achieved as arsenate ( $AsO_4^{3-}$ ,  $As^{5+}$ ) rather than arsenite ( $AsO_2^-$ ,  $As^{3+}$ ). Arsenite is therefore usually oxidized to arsenate prior to precipitation. Effluent arsenic levels of 0.05 mg/l are obtainable by precipitation of the arsenic as the sulfide by the addition of sodium or hydrogen sulfide at pH of 6 to 7. In order to meet reported effluent levels, polishing of the effluent by filtration would usually be required.

Arsenic present in low concentrations can also be reduced by filtration through activated carbon. Effluent concentrations of 0.06 mg/l arsenic have been reported from an initial concentration of 0.2 mg/l. Arsenic is removed by coprecipitation with a ferric hydroxide floc that ties up the arsenic and removes it from solution. Effluent concentrations of less than 0.005 mg/l have been reported from this process.



**FIGURE 4.9**  
Residual soluble metal concentrations using  $\text{Na}_2\text{CO}_3$ .



**FIGURE 4.10**  
Comparative optimum pH values for metal removal with and without ammonia.



TABLE 4.8  
Enhanced removal of soluble metals by precipitation

Metal	Input, mg/l	Ca(OH) <sub>2</sub> , mg/l	X, <sup>†</sup> mg/l
Cadmium	0.4	0.2	0.04
Chromium	1.2	0.1	0.05
Copper	1.3	0.1	0.05
Nickel	3.5	0.9	0.67
Lead	7.4	0.4	0.35
Mercury	1.4	0.1	0.01
Zinc	13.5	0.2	0.09

<sup>†</sup>Enhancing chemicals:

TMT15— trimercapto triazine trisodium salt

Nalfloc Nalmet 8154 (diethyl thio carbamate)

IMP HMI (dimethyl thio carbamate)

## Barium

Barium is present in wastewaters from the paint and pigment industry; the metallurgical industry; glass, ceramic, and dye manufacturers; and the vulcanizing of rubber. Barium has also been reported in explosives manufacturing wastewater. Barium is removed from solution by precipitation as barium sulfate.

Barium sulfate is extremely insoluble, having a maximum theoretical solubility at 25°C of approximately 1.4 mg/l as barium at stoichiometric concentrations of barium and sulfate. The solubility level of barium can be reduced in the presence of excess sulfate. Coagulation of barium salts as the sulfate would be capable of reducing barium to effluent levels of 0.03 to 0.3 mg/l. Barium can also be removed from solution by ion exchange and electro dialysis, although these processes would be more expensive than chemical precipitation.

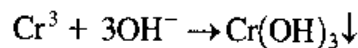
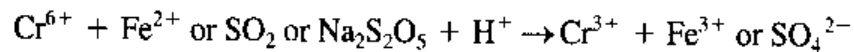
## Cadmium

Cadmium is present in wastewaters from metallurgical alloying, ceramics, electroplating, photography, pigment works, textile printing, chemical industries, and lead mine drainage. Cadmium is removed from wastewaters by precipitation or ion exchange. In some cases, electrolytic and evaporative recovery processes can be employed, provided the wastewater is in a concentrated form. Cadmium forms an insoluble and highly stable hydroxide at an alkaline pH. Cadmium in solution is approximately 1 mg/l at pH 8 and 0.05 mg/l at pH 10 to 11. Coprecipitation with iron hydroxide at pH 6.5 will reduce cadmium to 0.008 mg/l; iron hydroxide at pH 8.5 reduces cadmium to 0.05 mg/l. Sulfide and lime precipitation with filtration will yield 0.002 to 0.03 mg/l at pH 8.5 to 10. Cadmium is not precipitated in the presence of complexing ions, such as cyanide. In these cases, it is necessary to pre-treat the wastewater to destroy the complexing agent. In the case of cyanide, cyanide destruction is necessary prior to cadmium precipitation. A hydrogen per-

oxide oxidation precipitation system has been developed that simultaneously oxidizes cyanides and forms the oxide of cadmium, thereby yielding cadmium, whose recovery is feasible. Results for the hydroxide precipitation of cadmium are shown in Table 4.9.

## Chromium

The reducing agents commonly used for chromium wastes are ferrous sulfate, sodium meta-bisulfite, or sulfur dioxide. Ferrous sulfate and sodium meta-bisulfite may be dry- or solution-fed;  $\text{SO}_2$  is diffused into the system directly from gas cylinders. Since the reduction of chromium is most effective at acidic pH values, a reducing agent with acidic properties is desirable. When ferrous sulfate is used as the reducing agent, the  $\text{Fe}^{2+}$  is oxidized to  $\text{Fe}^{3+}$ ; if meta-bisulfite or sulfur dioxide is used, the negative radical  $\text{SO}_3^{2-}$  is converted to  $\text{SO}_4^{2-}$ . The general reactions are



Ferrous ion reacts with hexavalent chromium in an oxidation-reduction reaction, reducing the chromium to a trivalent state and oxidizing the ferrous ion to the ferric state. This reaction occurs rapidly at pH levels below 3.0. The acidic properties of ferrous sulfate are low at high dilution; acid must therefore be added for pH adjustment. The use of ferrous sulfate as a reducing agent has the disadvantage that a contaminating sludge of  $\text{Fe}(\text{OH})_3$  is formed when an alkali is added. In order to obtain a complete reaction, an excess dosage of 2.5 times the theoretical addition of ferrous sulfate must be used.

TABLE 4.9  
Hydroxide precipitation treatment for cadmium

Method	Treatment pH	Initial Cd, mg/l	Final Cd, mg/l
Hydroxide precipitation	8.0	—	1.0
	9.0	—	0.54
	10.0	—	0.10
	9.3-10.6	4.0	0.20
Hydroxide precipitation plus filtration	10.0	0.34	0.054
	10.0	0.34	0.033
Hydroxide precipitation plus filtration	11.0	—	0.00075
	11.0	—	0.00070
Hydroxide precipitation plus filtration	11.5	—	0.014
Hydroxide precipitation plus filtration	—	—	0.08
Coprecipitation with ferrous hydroxide	6.0	—	0.050
Coprecipitation with ferrous hydroxide	10.0	—	0.044
Coprecipitation with alum	6.4	0.7	0.39

Reduction of chromium can also be accomplished by using either sodium meta-bisulfite or  $\text{SO}_2$ . In either case reduction occurs by reaction with the  $\text{H}_2\text{SO}_3$  produced in the reaction. The  $\text{H}_2\text{SO}_3$  ionizes according to the mass action:

$$\frac{(\text{H}^+)(\text{HSO}_3^-)}{(\text{H}_2\text{SO}_3)} = 1.72 \times 10^{-2}$$

Above pH 4.0, only 1 percent of sulfite is present as  $\text{H}_2\text{SO}_3$  and the reaction is very slow. During this reaction, acid is required to neutralize the NaOH formed. The reaction is highly dependent on both pH and temperature. At pH levels below 2.0 the reaction is practically instantaneous and close to theoretical requirements.

The theoretical quantities of chemicals required for 1 ppm Cr are:

2.81 ppm  $\text{Na}_2\text{S}_2\text{O}_5$  (97.5 percent)

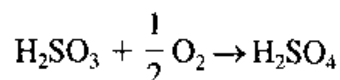
1.52 ppm  $\text{H}_2\text{SO}_4$

2.38 ppm lime (90 percent)

1.85 ppm  $\text{SO}_2$

At pH levels above 3, when a basic chrome sulfate is produced, the quantities of lime required for subsequent neutralization are reduced. At pH 8.0 to 9.9,  $\text{Cr}(\text{OH})_3$  is virtually insoluble. Experimental investigations have shown that the sludge produced will compact to 1 to 2 percent by weight.

Since dissolved oxygen is usually present in wastewaters, an excess of  $\text{SO}_2$  must be added to account for the oxidation of the  $\text{SO}_3^{2-}$  to  $\text{SO}_4^{2-}$ :

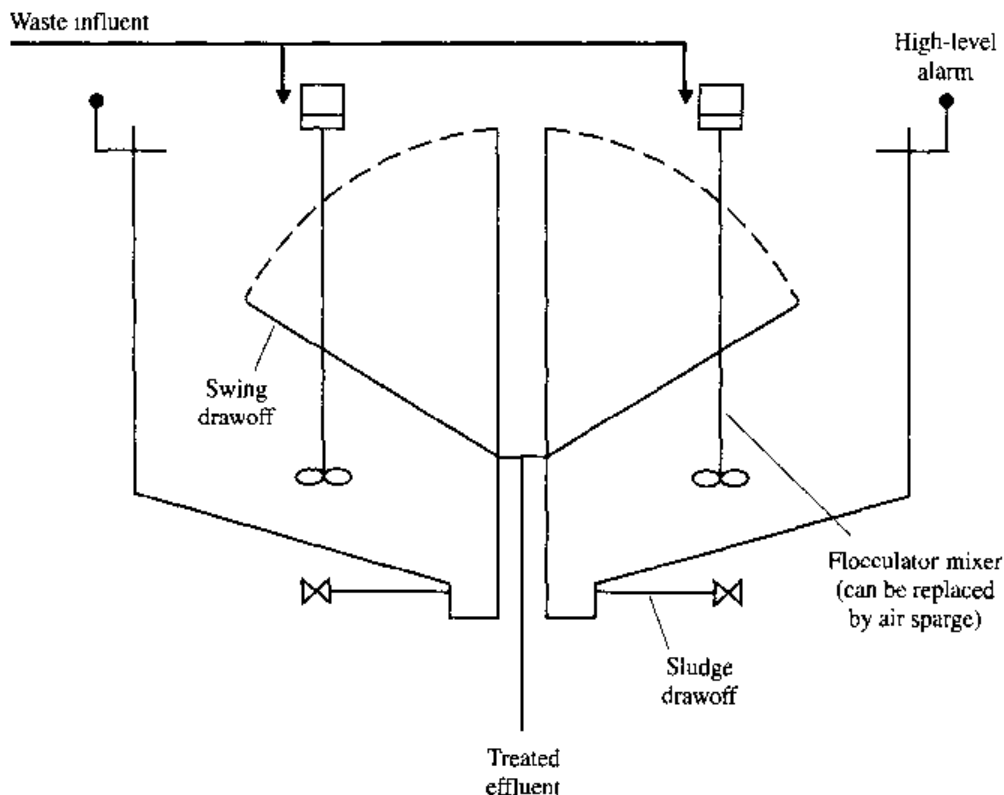


An excess dosage of 35 ppm  $\text{SO}_2$  will usually be sufficient for reaction with the dissolved oxygen present.

The acid requirements for the reduction of  $\text{Cr}^{6+}$  depend on the acidity of the original waste, the pH of the reduction reaction, and the type of reducing agent used (for example,  $\text{SO}_2$  produces an acid but meta-bisulfite does not). Since it is difficult, if not impossible, to predict these requirements, it is usually necessary to titrate a sample to the desired pH endpoint with standardized acid.

Many small plating plants have a total daily volume of waste of less than 30,000 gal/d (114  $\text{m}^3/\text{d}$ ). The most economical system for such plants is a batch treatment in which two tanks are provided, each with a capacity of one day's flow. One tank is undergoing treatment while the other is filling. Accumulated sludge is either drawn off and hauled to disposal or dewatered on sand drying beds. A separable dry cake can be obtained after 48 hours on a sand bed. A typical batch treatment system is schematically shown in Fig. 4.11.

When the daily volume of waste exceeds 30,000 to 40,000 gal (114 to 151  $\text{m}^3$ ), batch treatment is usually not feasible because of the large tankage required. Continuous treatment requires a tank for acidification and reduction, then a mixing tank, for lime addition, and a settling tank. The retention time in the reduction tank is dependent on the pH employed but should be at least 4 times the theoretical time for complete reduction. Twenty minutes will usually be adequate for flocculation. Final settling should not be designed for an overflow rate in excess of 500 gal/(d · ft<sup>2</sup>) [20  $\text{m}^3/(\text{d} \cdot \text{m}^2)$ ].



**FIGURE 4.11**  
Batch treatment of chromium wastes.

In cases where the chrome content of the rinsewater varies markedly, equalization should be provided before the reduction tank to minimize fluctuations in the chemical feed system. The fluctuation in chrome content can be minimized by provision of a drain station before the rinse tanks.

Successful operation of a continuous chrome reduction process requires instrumentation and automatic control. pH and redox control are provided for the reduction tank. The addition of lime should be modulated by a second pH control system. A continuous chrome reduction/precipitation process is shown in Fig. 4.12. Reported results for the precipitation of chromium are shown in Table 4.10. Removal of chromium by ion exchange is shown in Table 4.11. An example of metals removal is shown in Example 4.2.

**EXAMPLE 4.2.** 30,000 gal/d (114 m<sup>3</sup>/d) of a waste containing 49 mg/l Cr<sup>6+</sup>, 11 mg/l Cu, and 12 mg/l Zn is to be treated daily by using SO<sub>2</sub>. Compute the chemical requirements and the daily sludge production. (Assume the waste contains 5 mg/l O<sub>2</sub>.)

**Solution.**

(a) SO<sub>2</sub> requirements are as follows. For Cr<sup>6+</sup>

$$1.85 \left( \frac{\text{mg SO}_2}{\text{mg Cr}^{6+}} \right) \times 49(\text{mg Cr}^{6+}/\text{l}) \times 8.34 \left( \frac{\text{lb/million gal}}{\text{mg/l}} \right) \\ \times 0.03 \text{ million gal/d} = 22.7 \text{ lb/d} \quad (10.3 \text{ kg/d})$$

and for  $O_2$ , where 1 part of  $O_2$  requires 4 parts of  $SO_2$ :

$$4 \left( \frac{\text{mg } SO_2}{\text{mg } O_2} \right) \times 5(\text{mg } O_2/\text{l}) \times 8.34 \times 0.03 = 5.0 \text{ lb/d} \quad (2.3 \text{ kg/d})$$

$$\text{Total} = 27.7 \text{ lb/d} \quad (12.6 \text{ kg/d})$$

(b) Lime requirements are as follows. For  $Cr^{3+}$ :

$$2.38 \left( \frac{\text{mg lime}}{\text{mg } Cr^{3+}} \right) \times 49 \times 8.34 \times 0.03 = 29.2 \text{ lb/d} \quad (13.3 \text{ kg/d})$$

and for Cu and Zn (each part of Cu and Zn requiring 1.3 parts of 90 percent lime for precipitation):

$$1.3 \left( \frac{\text{mg lime}}{\text{mg Cu or Zn}} \right) \times 23(\text{mg Cu and Zn/l}) \times 8.34 \times 0.03 = 7.5 \text{ lb/d} \quad (3.4 \text{ kg/d})$$

$$\text{Total} = 36.7 \text{ lb/d} \quad (16.7 \text{ kg/d})$$

(c) Sludge production is:

$$1.98 \left( \frac{\text{mg } Cr(OH)_3}{\text{mg } Cr^{6+}} \right) \times 49 \times 8.34 \times 0.03 = 24.3 \text{ lb/d } Cr(OH)_3 \quad (11 \text{ kg/d})$$

$$1.53 \left( \frac{\text{mg sludge}}{\text{mg Cu or Zn}} \right) \times 23 \times 8.34 \times 0.03$$

$$= 8.8 \text{ lb/d } Cu(OH)_2 \text{ and } Zn(OH)_2 \quad (4 \text{ kg/d})$$

$$\text{Total} = 33.1 \text{ lb/d} \quad (15 \text{ kg/d})$$

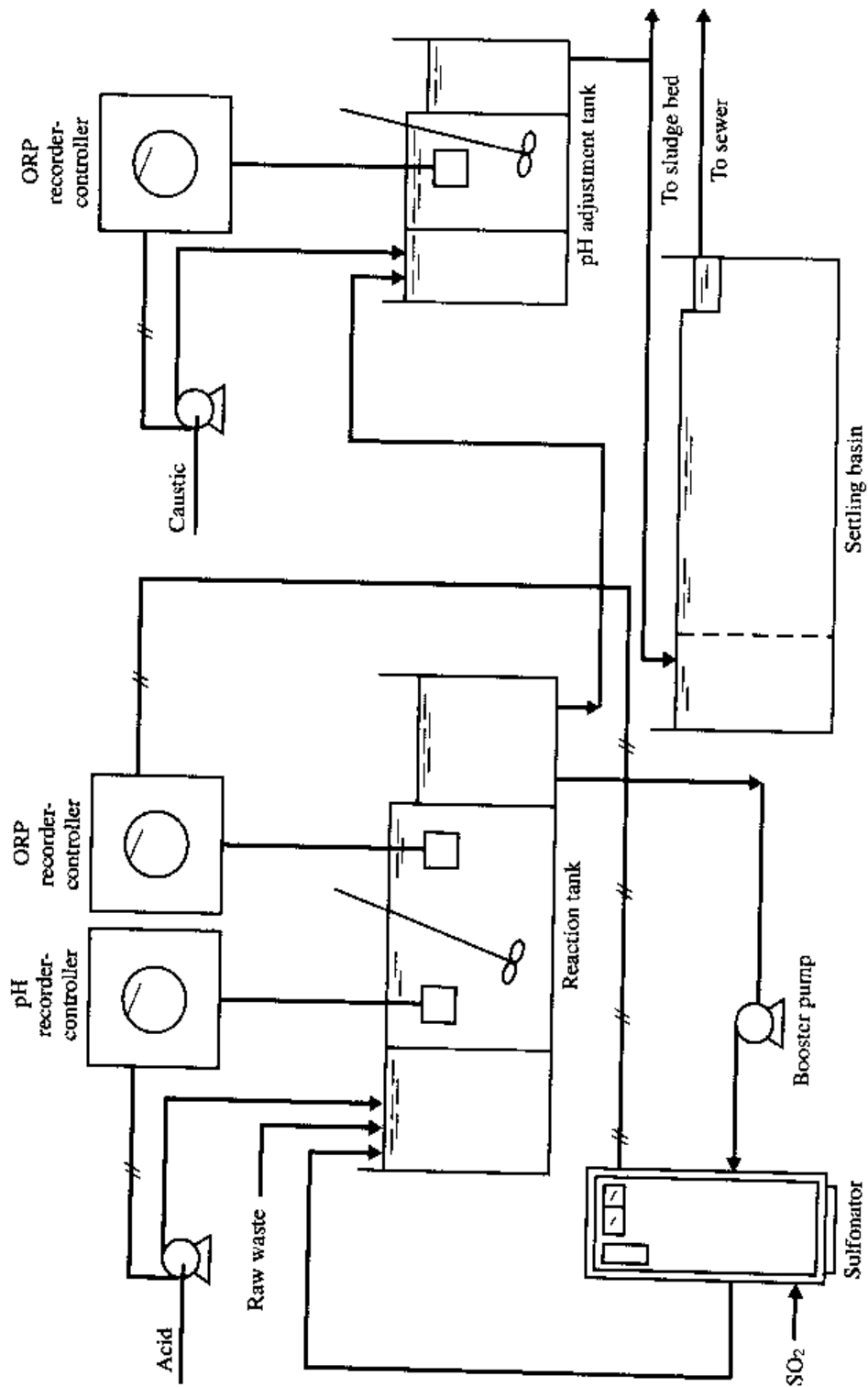
If the sludge concentrates to 1.5 percent by weight, the volume that will require disposal each day can be calculated as follows:

$$\frac{33.1 \text{ lb/d}}{0.015 \text{ lb solids/lb sludge} \times 8.34 \text{ lb/gal}} = 265 \text{ gal/d} \quad (1.0 \text{ m}^3/\text{d})$$

It should be noted that some of the copper and zinc will be soluble unless the final pH after lime addition exceeds pH 9.0.

## Copper

The primary sources of copper in industrial wastewaters are metal-process pickling baths and plating baths. Copper may also be present in wastewaters from a variety of chemical manufacturing processes employing copper salts or a copper catalyst. Copper is removed from wastewaters by precipitation or recovery processes, which include ion exchange, evaporation, and electrodialysis. The value of recovered copper metal will frequently make recovery processes attractive. Ion exchange or activated carbon are feasible treatment methods for wastewaters containing copper at concentrations of less than 200 mg/l. Copper is precipitated as a relatively insoluble metal hydroxide at alkaline pH. In the presence of high sulfates, calcium



**FIGURE 4.12**  
 Continuous chrome waste treatment system (courtesy of Fischer-Porter, Inc.).

TABLE 4.10  
Summary of trivalent chromium treatment results

Method	pH	Chromium, mg/l	
		Initial	Final
Precipitation	7-8	140	1.0
	7.8-8.2	16.0	0.06-0.15
	8.5	47-52	0.3-1.5
	8.8	650	18
	8.5-10.5	26.0	0.44-0.86
	8.8-10.1	--	0.6-30
	12.2	650	0.3
Precipitation with sand filtration	8.5	7400	1.3-4.6
	8.5	7400	0.3-1.3
	9.8-10.0	49.4	0.17
	9.8-10.0	49.4	0.05

TABLE 4.11  
Ion exchange performance in hexavalent chromium removal<sup>15</sup>

Wastewater source	Chromium, mg/l		Resin capacity <sup>†</sup>
	Influent	Effluent	
Cooling tower blowdown	17.9	1.8	5-6
	10.0	1.0	2.5-4.5
	7.4-10.3	1.0	—
	9.0	0.2	2.5
Plating rinsewater	44.8	0.025	1.7-2.0
	41.6	0.01	5.2-6.3
Pigment manufacture	1210	<0.5	—

<sup>†</sup>lb chromate/ft<sup>3</sup> resin.

sulfate will also be precipitated and will interfere with the recovery value of the copper sludge. This may dictate the use of a more expensive alkali such as NaOH to obtain a pure sludge. Cupric oxide has a minimum solubility between pH 9.0 and 10.3 with a reported solubility of 0.01 mg/l. Field practice has indicated that the maximum technically feasible treatment level for copper by chemical precipitation is 0.02 to 0.07 mg/l as soluble copper. Precipitation with sulfide at pH 8.5 will result in effluent copper concentrations of 0.01 to 0.02 mg/l. Low residual concentrations of copper are difficult to achieve in the presence of complexing agents such as cyanide and ammonia. Removal of the complexing agent by pretreatment is essential for high copper removal. Copper cyanide is effectively removed on activated carbon. A summary of copper results after hydroxide precipitation is shown in Table 4.12.

TABLE 4.12  
Summary of copper results after hydroxide precipitation treatment<sup>15</sup>

Source (treatment)	Copper concentration, mg/l	
	Initial	Final
Metal processing (lime)	204-385	0.5
Nonferrous metal processing (lime)	—	0.2-2.3
Metal processing (lime)	—	1.4-7.8
Electroplating (caustic, soda ash + hydrazine)	6.0-15.5	0.09-0.24 (solution) 0.30-0.45 (total)
Machine plating (lime + coagulant)	—	2.2
Metal finishing (lime)	—	0.19 average
Brass mill (lime)	10-20	1-2
Plating (CN oxidation, Cr reduction neutralization)	11.4	2.0
Wood preserving (lime)	0.25-1.1	0.1-0.35
Brass mill (hydrazine + caustic)	75-124	0.25-0.85
Silver plating (CN oxidation, lime + $\text{FeCl}_3$ + filtration)	30 (average)	0.16-0.3
Copper sulfate manufacture (lime)	433	0.14-1.25 (0.48 average)
Integrated circuit manufacture (lime)	0.23	0.05

## Fluorides

Fluorides are present in wastewaters from glass manufacturing, electroplating, steel and aluminum production, and pesticide and fertilizer manufacture. Fluoride is removed by precipitation with lime as calcium fluoride. Effluent concentrations in the order of 10 to 20 mg/l are readily obtainable. Lime precipitation at a pH above 12 has created problems with solids removal, poor settling, and cementation of filters. Enhanced removal of fluoride has been reported in the presence of magnesium. The increased removal is attributed to adsorption of the fluoride ion into the magnesium hydroxide floc, resulting in effluent fluoride concentrations of less than 1.0 mg/l. Alum coprecipitation will result in effluent levels of 0.5 to 2.0 mg/l. Low concentrations of fluoride can be removed by ion exchange. Fluoride removal through ion exchange pretreated and regenerated with aluminum salts is attributable to aluminum hydroxide precipitated in a column bed. Fluoride is removed through contact beds of activated alumina, which may be employed as a polishing unit to follow lime precipitation. Fluoride concentrations of 30 mg/l from the lime precipitation process have been reduced to approximately 2 mg/l upon passage through an activated alumina contact bed. A summary of fluoride treatment processes and levels of treatment achieved is in Table 4.13.



TABLE 4.13  
Summary of fluoride treatment processes and levels of treatment achieved<sup>15</sup>

Treatment process	Fluoride concentration, mg/l		Current application
	Initial	Final	
Lime		10	Industrial
Lime	1000-3000	20	Industrial
Lime	500-1000	20-40	Industrial
Lime	200-700	6 (16-h settling)	Industrial
Lime	45	8	Industrial
Lime	4-20	5.9 (average)	Industrial
Lime	590	80	Industrial
Lime	57.8	29.1 (average)	Industrial
		14-16 (best)	
Lime	93,000	0.8-8.8	Industrial (pilot-scale)
Lime	—	10.6 (clarified)	Industrial
		10.4 (filtered)	
Lime, two-stage	1,460	9	Industrial
Lime + calcium chloride	—	12	Industrial
Lime + alum	—	1.5	Industrial
Lime + alum	2,020	2.4	Industrial (pilot-scale)
Calcium carbonate + lime, two-stage	11,100	6	Industrial

## Iron

Iron is present in a wide variety of industrial wastewaters including mining operations, ore milling, chemical industrial wastewater, dye manufacture, metal processing, textile mills, petroleum refining, and others. Iron exists in the ferric or ferrous form, depending on pH and dissolved oxygen concentration. At neutral pH and in the presence of oxygen, soluble ferrous iron is oxidized to ferric iron, which readily hydrolyzes to form the insoluble ferric hydroxide precipitate. At high pH values ferric hydroxide will solubilize through the formation of the  $\text{Fe}(\text{OH})_4^-$  complex. Ferric and ferrous iron may also be solubilized in the presence of cyanide by the formation of ferro- and ferricyanide complexes. The primary removal process for iron is conversion of the ferrous to the ferric state and precipitation of ferric hydroxide at a pH of near 7, corresponding to minimum solubility. Conversion of ferrous to ferric iron occurs rapidly upon aeration at pH 7.5. In the presence of dissolved organic matter, the iron oxidation rate is reduced. Two-stage hydroxide precipitation or sulfate precipitation will reduce iron to 0.01 mg/l.

## Lead

Lead is present in wastewaters from storage-battery manufacture. Lead is generally removed from wastewaters by precipitation as the carbonate,  $\text{PbCO}_3$ , or the hydroxide,  $\text{Pb(OH)}_2$ . Lead is effectively precipitated as the carbonate by the addition of soda ash, resulting in effluent-dissolved lead concentrations of 0.01 to 0.03 mg/l at a pH of 9.0 to 9.5. Precipitation with lime at pH 11.5 resulted in effluent concentrations of 0.019 to 0.2 mg/l. Precipitation as the sulfide to 0.01 mg/l can be accomplished with sodium sulfide at a pH of 7.5 to 8.5.

## Manganese

Manganese and its salts are found in wastewaters from manufacture of steel alloy, dry-cell batteries, glass and ceramics, paint and varnish, and inks and dye. Among the many forms and compounds of manganese only the manganous salts and the highly oxidized permanganate anion are appreciably soluble. The latter is a strong oxidant that is reduced under normal circumstances to insoluble manganese dioxide. Treatment technology for the removal of manganese involves conversion of the soluble manganous ion to an insoluble precipitate. Removal is effected by oxidation of the manganous ion and separation of the resulting insoluble oxides and hydroxides. Manganous ion has a low reactivity with oxygen and simple aeration is not an effective technique below pH 9. It has been reported that even at high pH levels, organic matter in solution can combine with manganese and prevent its oxidation by simple aeration. A reaction pH above 9.4 is required to achieve significant manganese reduction by precipitation. The use of chemical oxidants to convert manganous ion to insoluble manganese dioxide in conjunction with coagulation and filtration has been employed. The presence of copper ion enhances air oxidation of manganese, and chlorine dioxide rapidly oxidizes manganese to the insoluble form. Permanganate has successfully been employed in the oxidation of manganese. Ozone has been employed in conjunction with lime for the oxidation and removal of manganese. The drawback in the application of ion exchange is the nonselective removal of other ions, which increases operating costs.

## Mercury

The major consumptive user of mercury in the United States is the chlor-alkali industry. Mercury is also used in the electrical and electronics industry, explosives manufacturing, the photographic industry, and the pesticide and preservative industry. Mercury is used as a catalyst in the chemical and petrochemical industry. Mercury is also found in most laboratory wastewaters. Power generation is a large source of mercury release into the environment through the combustion of fossil fuel. When scrubber devices are installed on thermal power plant stacks for sulfur dioxide removal, accumulation of mercury is possible if extensive recycle is practiced. Mercury can be removed from wastewaters by precipitation, ion exchange, and adsorption. Mercury ions can be reduced upon contact with other metals such

as copper, zinc, or aluminum. In most cases mercury recovery can be achieved by distillation. For precipitation, mercury compounds must be oxidized to the mercuric ion. Table 4.14 shows effluent levels achievable by candidate technology.

### Nickel

Wastewaters containing nickel originate from metal-processing industries, steel foundries, motor vehicle and aircraft industries, printing, and in some cases, the chemicals industry. In the presence of complexing agents such as cyanide, nickel may exist in a soluble complex form. The presence of nickel cyanide complexes interferes with both cyanide and nickel treatment. Nickel forms insoluble nickel hydroxide upon the addition of lime, resulting in a minimum solubility of 0.12 mg/l at pH 10 to 11. Nickel hydroxide precipitates have poor settling properties. Nickel can also be precipitated as the carbonate or the sulfate associated with recovery systems. In practice, lime addition (pH 11.5) may be expected to yield residual nickel concentrations in the order of 0.15 mg/l after sedimentation and filtration. Recovery of nickel can be accomplished by ion exchange or evaporative recovery, provided the nickel concentrations in the wastewaters are at a sufficiently high level. Results of nickel precipitation are shown in Table 4.15.

### Selenium

Selenium may be present in various types of paper, fly ash, and metallic sulfide ores. The selenious ion appears to be the most common form of selenium in wastewater except for pigment and dye wastes, which contain selenide (yellow cadmium selenide). Selenium can be removed from wastewaters by precipitation as the sulfide at a pH of 6.6. Effluent levels of 0.05 mg/l are reported. Ferric hydroxide coprecipitation at pH 6.2 will reduce selenium to 0.01 to 0.05 mg/l. Alumina adsorption results in effluent levels of 0.005 to 0.02 mg/l.

TABLE 4.14  
Mercury removal, effluent levels

Technology	Effluent, $\mu\text{g/l}$
Sulfide precipitation	10-20
Alum coprecipitation	1-10
Iron coprecipitation	0.5-5
Ion exchange	1-5
Carbon adsorption	
Influent	—
High	20
Moderate	2
Low	0.25

TABLE 4.15  
**Comparison of lime versus lime-plus-sulfide precipitation  
of nickel in electroplating wastewaters<sup>16</sup>**

Parameter	Wastewater		
	A	B	C
Treatment pH	8.5	8.75	9.0
Initial nickel, mg/l	119.0	99.0	3.2
Lime treatment			
Clarifier effluent	12.0	16.0	0.47
Filter effluent	9.4	12.0	0.07
Lime plus sulfide			
Clarifier effluent	11.0	7.0	0.35
Filter effluent	3.5	4.2	0.20

## Silver

Soluble silver, usually in the form of silver nitrate, is found in wastewaters from the porcelain, photographic, electroplating, and ink manufacturing industries. Treatment technology for the removal of silver usually considers recovery because of the high value of the metal. Basic treatment methods include precipitation, ion exchange, reductive exchange, and electrolytic recovery. Silver is removed from wastewater by precipitation as silver chloride, which is an extremely insoluble precipitate resulting in the maximum silver concentration at 25°C of approximately 1.4 mg/l. An excess of chloride will reduce this value, but greater excess concentrations will increase the solubility of silver through the formation of soluble silver chloride complexes. Silver can be selectively precipitated as silver chloride from a mixed-metal wastestream without initial wastewater segregation or concurrent precipitation of other metals. If the treatment conditions are alkaline, resulting in precipitation of hydroxides of other metals along with the silver chloride, acid washing of the precipitated sludge will remove contaminated metal ions, leaving the insoluble silver chloride. Plating wastes contain silver in the form of silver cyanide, which interferes with the precipitation of silver as the chloride salt. Oxidation of the cyanide with chlorine releases chloride ions into solution, which in turn react to form silver chloride directly. Sulfide will precipitate silver from photographic solutions as the extremely insoluble silver sulfide. Ion exchange has been employed for the removal of soluble silver from wastewaters. Activated carbon will remove low concentrations of silver. The mechanism reported is one of reductive recovery by formation of elemental silver at the carbon surface. Reported results indicate that the carbon is capable of retaining silver to 9 percent of its weight at a pH of 2.1 and 12 percent of its weight at a pH of 5.4. Alum or iron coprecipitation will reduce silver to 0.025 mg/l and hydroxide precipitation at pH 11 to 0.02 mg/l.

## Zinc

Zinc is present in wastewater streams from steelworks, rayon yarn and fiber manufacture, ground wood-pulp production, and recirculating cooling water systems employing cathodic treatment. Zinc is also present in wastewaters from the plating and metal-processing industry. Zinc can be removed by precipitation as zinc hydroxide with either lime or caustic. The disadvantage of lime addition is the concurrent precipitation of calcium sulfate in the presence of high sulfate levels in the wastewater. An effluent soluble zinc of less than 0.1 mg/l has been achieved at pH 11.0. A summary of hydroxide precipitation results is shown in Table 4.16.

TABLE 4.16  
Summary of hydroxide precipitation treatment results for zinc wastewaters<sup>15</sup>

Industrial source	Zinc concentration, mg/l		Comments <sup>†</sup>
	Initial	Final	
Zinc plating	—	0.2–0.5	pH 8.7–9.3
General plating	18.4	2.0	pH 9.0
	—	0.6	Sand filtration
	55–120	1.0	pH 7.5
	46	2.9	pH 8.5
		1.9	pH 9.2
		2.8	pH 9.8
		2.9	pH 10.5
Vulcanized fiber	100–300	1.0	pH 8.5–9.5
Tableware plant	16.1	0.02–0.23	Sand filtration
Viscose rayon	26–120	0.86–1.5	—
	70	3–5	pH 5
	20	1.0	—
Metal fabrication	—	0.5–1.2	Sedimentation
		0.1–0.5	Sand filtration
Radiator manufacture		0.33–2.37	Sedimentation
		0.03–0.38	Sand filtration
Blast furnace gas scrubber water	50	0.2	pH 8.8
Zinc smelter	744	50	
	1500	2.6	
Ferroalloy waste	11.2–34	0.29–2.5	
	3–89	4.2–7.9	
Ferrous foundry	72	1.26	Sedimentation
		0.41	Sand filtration
Deep coal mine—acid water	33–7.2	0.01–10	

<sup>†</sup>All treatment involved precipitation plus sedimentation. Special or additional aspects of treatment are indicated under Comments. (Patterson, 1985)

Results for reverse osmosis treatment of zinc wastewaters are shown in Table 4.17. Electrolytic treatment of zinc cyanide wastewaters results are shown in Table 4.18.

TABLE 4.17  
Pilot-scale results for reverse osmosis treatment of zinc wastewaters<sup>17</sup>

Industrial source	Zinc concentration, $\mu\text{g/l}$		
	Feed	Permeate	Percent removal
Zinc cyanide plating rinse	1,700	30	98
Steam electric power plant	300	53	82
	780	3	99
Textile mill	7,200	140	98
	5,400	6,600	-20
	460	250	46
	520	360	31
	7,200	360	95
	1,400	30	98
	4,100	180	96
	1,200	22	98
Cooling tower blowdown	24,000	430	98
	9,700	37	>99
Cooling tower blowdown	10,000	300	97

TABLE 4.18  
Electrolytic treatment of zinc cyanide wastes

Waste	Parameter	Concentration, $\text{mg/l}$	
		Initial	Final
A	Zinc	352	0.7
	Cyanide	258	12.0
B	Zinc	117	0.3
	Copper	842	0.5
	Cyanide	1230	<0.1

## Summary

Effluent concentrations achievable by metals removal or processes are summarized in Table 4.19. A detailed discussion of metals removal has been presented by Patterson.<sup>15</sup>

TABLE 4.19  
Effluent levels achievable in heavy metals removal<sup>14</sup>

Metal	Achievable effluent concentration, mg/l	Technology
Arsenic	0.05	Sulfide ppt with filtration <sup>†</sup>
	0.06	Carbon adsorption
	0.005	Ferric hydroxide co-ppt
Barium	0.5	Sulfate ppt
Cadmium	0.05	Hydroxide ppt at pH 10–11
	0.05	Co-ppt with ferric hydroxide
	0.008	Sulfide precipitation
Copper	0.02–0.07	Hydroxide ppt
	0.01–0.02	Sulfide ppt
Mercury	0.01–0.02	Sulfide ppt
	0.001–0.01	Alum co-ppt
	0.0005–0.005	Ferric hydroxide co-ppt
	0.001–0.005	Ion exchange
Nickel	0.12	Hydroxide ppt at pH 10
Selenium	0.05	Sulfide ppt
Zinc	0.1	Hydroxide ppt at pH 11

<sup>†</sup>Note: ppt = precipitation

## PROBLEM

- 4.1. A metal-finishing plant has a wastewater flow of 72,000 gal/d (273 m<sup>3</sup>/d) with the following characteristics:

Cr<sup>6+</sup> 75 mg/l  
Cu 10 mg/l  
Ni 8 mg/l

Design a reduction and precipitation plant for

1. Continuous flow

2. Batch flow

- (a) Develop the ORP control points using SO<sub>2</sub> as the reducing agent.  
(b) Compute the quantity of sludge and drying bed area assuming the sludge concentrates to 2 percent, is applied to the bed to a depth of 18 in (0.46 m), and is removed every 5 days at 12 percent.  
(c) Compute the residual soluble metal if a terminal pH of 8.5 is used for the precipitation.

## REFERENCES

1. Mysels, K. J.: *Introduction to Colloid Chemistry*, Interscience Publishers, New York, 1959.
2. Black, A. P., and H. L. Smith: *J. Am. Water Works Assoc.*, vol. 54, p. 371, 1962.

3. Riddick, T. M.: *Tappi*, vol. 47, pt. 1, p. 171A, 1964.
4. Palladino, A. I.: *Proc. 10th Ind. Waste Conf.*, May 1955, Purdue University.
5. Knack, M. F.: *Proc. 4th Ind. Waste Conf.*, 1949, Purdue University.
6. Leonard, A. G., and R. G. Keating: *Proc. 13th Ind. Waste Conf.*, 1946, Purdue University.
7. Bloodgood, D., and W. J. Kellenher: *Proc. 7th Ind. Waste Conf.*, 1952, Purdue University.
8. Eckenfelder, W. W., and D. J. O'Connor: *Proc. 10th Ind. Waste Conf.*, May 1955, p. 17, Purdue University.
9. Webster, R. A.: *Sewage Ind. Wastes*, vol. 25, pt. 12, p. 1432, December 1953.
10. Olthof, M. G., and W. W. Eckenfelder: *Textile Chemist and Colorist*, vol. 8, pt. 7, p. 18, 1976.
11. Olthof, M. G., and W. W. Eckenfelder: *Water Res.*, vol. 9, p. 853, 1975.
12. Southgate, B. A.: *Treatment and Disposal of Industrial Waste Waters*, His Majesty's Stationery Office, London, 1948, p. 186.
13. McCarthy, Joseph A.: *Sewage Works J.*, vol. 21, pt. 1, p. 75, January 1949.
14. Tatintli, I.: *Wat. Sci. Tech.*, 29, 9, p. 175, 1994.
15. Patterson, J. W.: *Industrial Wastewater Treatment Technology*, Butterworth Publishers, Boston, 1985.
16. Robinson, A. and J. Sum: U.S. EPA 600/2-80-139, June 1980.
17. Cawley, W. (ed.): *Treatability Manual*, vol. III, U.S. EPA 600/8-80-042-C, July 1980.



---

# 5

---

## AERATION AND MASS TRANSFER

---

### 5.1 MECHANISM OF OXYGEN TRANSFER

Aeration is used for transferring oxygen to biological-treatment processes, for stripping solvents from wastewaters, and for removing volatile gases such as  $H_2S$  and  $NH_3$ .

Aeration is a gas-liquid mass-transfer process in which interphase diffusion occurs when a driving force is created by a departure from equilibrium. In the gas phase, the driving force is a partial pressure gradient; in the liquid phase, it is a concentration gradient.

The rate of molecular diffusion of a dissolved gas in a liquid is dependent on the characteristics of the gas and the liquid, the temperature, the concentration gradient, and the cross-sectional area across which diffusion occurs. The diffusional process is defined by Fick's law:

$$N = -D_L A \frac{dc}{dy} \quad (5.1)$$

where  $N$  = mass transfer per unit time  
 $A$  = cross-sectional area through which diffusion occurs  
 $dc/dy$  = concentration gradient perpendicular to cross-sectional area  
 $D_L$  = diffusion coefficient through the liquid film

If it is assumed that equilibrium conditions exist at the interface, the mass-transfer process can be reexpressed as:

$$N = \left( -D_g A \frac{dp}{dy} \right)_1 = \left( -D_L A \frac{dc}{dy} \right)_2 = \left( -D_e A \frac{dc}{dy} \right)_3 \quad (5.2)$$

where  $D_g$  = diffusion coefficient through the gas film  
 $D_e$  = eddy diffusion coefficient of the gas in the body of the liquid  
 $D_L$  = diffusion coefficient through the liquid film

Since the systems dealt with in waste treatment involve high degrees of turbulence, the eddy diffusivity will be several orders of magnitude greater than the coefficients of molecular diffusivity, and this need not be considered as a rate-controlling step. An exception may be large aerated lagoons or aeration in flowing rivers.

Lewis and Whitman<sup>1</sup> developed the two-film concept which considers stagnant films at the gas and liquid interfaces through which mass transfer must occur. Equation (5.2) can be reexpressed in terms of a liquid and gas film:

$$N = K_L A(C_s - C_L) = K_g A(P_g - P) \quad (5.3)$$

where  $N$  = mass of oxygen transferred per unit area  
 $A$  = interfacial surface area  
 $C_s$  = oxygen saturation concentration  
 $C_L$  = concentration of oxygen in the liquid  
 $K_L$  = liquid-film coefficient, defined as  $D_L/Y_L$   
 $K_g$  = gas-film coefficient, defined as  $D_g/Y_g$   
 $Y_L$  = liquid-film thickness  
 $Y_g$  = gas-film thickness

For sparingly soluble gases, such as oxygen and  $\text{CO}_2$ , the liquid-film resistance controls the rate of mass transfer; for highly soluble gases, such as ammonia, the gas-film resistance controls the transfer rate. Most of the mass-transfer applications in waste treatment are liquid-film controlled. Increasing the fluid turbulence will decrease the film thickness and hence increase  $K_L$ . Danckwartz<sup>2</sup> has defined the liquid-film coefficient as the square root of the product of the diffusivity and the rate of surface renewal:

$$K_L = \sqrt{D_L r} \quad (5.4)$$

The rate of surface renewal  $r$  can be considered as the frequency with which fluid with a solute concentration  $C_L$  is replacing fluid from the interface with a concentration  $C_s$ . High degrees of fluid turbulence will increase  $r$ .

Dobbins<sup>3</sup> has proposed a relationship that describes the aforementioned transfer mechanisms:

$$K_L = (D_L r)^{1/2} \coth\left(\frac{r Y_L^2}{D_L}\right)^{1/2} \quad (5.5)$$

When the surface-renewal rate is zero,  $K_L$  is equal to  $D_L/Y_L$  and the transfer is controlled by molecular diffusion through the surface film. As  $r$  increases,  $K_L$  becomes equal to  $\sqrt{D_L r}$  and the transfer is a function of the rate of surface renewal.

For liquid-film-controlled processes, Eq. (5.3) can be reexpressed in concentration units:

$$\frac{1}{V} N = \frac{dc}{dt} = K_L \frac{A}{V} (C_s - C_L) \quad (5.6)$$

in which  $V$  is the liquid volume and

$$K_L \frac{A}{V} = K_L a$$

$K_L a$  is an overall film coefficient and is usually used to compute the transfer rate.

The most important application of aeration in waste treatment is the transfer of oxygen to biological-treatment processes and the natural reaeration of streams and other watercourses.

The equilibrium concentration of oxygen in contact with water,  $C_s$ , is defined by Henry's law:

$$p = HC_s \quad (5.7)$$

where  $p$  = partial pressure of oxygen in the gas phase and  $H$  = Henry's constant, which is proportional to temperature and is influenced by the presence of dissolved solids.

The solubility of oxygen in water at various temperatures is summarized in Table 5.1. As temperature and dissolved solids concentrations increase, Henry's constant also increases, thereby reducing  $C_s$ . It is therefore usually necessary in industrial wastes to measure solubility experimentally.

In aeration tanks, where air is released at an increased liquid depth, the solubility of oxygen is influenced both by the increasing partial pressure of the air

TABLE 5.1  
Solubility of oxygen (mg/l) at various temperatures,  
elevations, and total dissolved solids levels

Temperature		Elevation, ft							TDS (sit sea level), ppm			
°F	°C	0	1000	2000	3000	4000	5000	6000	400	800	1500	2500
32.0	0	14.6	14.1	13.6	13.1	12.6	12.1	11.7	—	—	—	—
35.6	2	13.8	13.3	12.8	12.4	11.9	11.5	11.1	13.74	13.68	13.58	13.42
39.2	4	13.1	12.6	12.2	11.8	11.4	10.9	10.5	13.04	12.98	12.89	12.75
42.8	6	12.5	12.0	11.6	11.2	10.8	10.4	10.0	12.44	12.38	12.29	12.15
46.4	8	11.9	11.4	11.0	10.6	10.2	9.9	9.5	11.85	11.80	11.70	11.58
50.0	10	11.3	10.9	10.5	10.1	9.8	9.4	9.1	11.25	11.20	11.12	11.00
53.6	12	10.8	10.4	10.1	9.7	9.4	9.0	8.6	10.76	10.71	10.64	10.52
57.2	14	10.4	10.0	9.6	9.3	8.9	8.6	8.3	10.36	10.32	10.25	10.15
60.8	16	10.0	9.6	9.2	8.9	8.6	8.3	8.0	9.96	9.92	9.85	9.75
64.4	18	9.5	9.2	8.9	8.5	8.2	7.9	7.6	9.46	9.43	9.36	9.27
68.0	20	9.2	8.8	8.5	8.2	7.9	7.6	7.3	9.16	9.13	9.06	8.97
71.6	22	8.8	8.5	8.2	7.9	7.6	7.3	7.1	8.77	8.73	8.68	8.60
75.2	24	8.5	8.2	7.9	7.6	7.3	7.1	6.8	8.47	8.43	8.38	8.30
78.8	26	8.2	7.9	7.6	7.3	7.1	6.8	6.6	8.17	8.13	8.08	8.00
82.4	28	7.9	7.6	7.4	7.1	6.8	6.6	6.3	7.87	7.83	7.78	7.70
86.0	30	7.6	7.4	7.1	6.9	6.6	6.4	6.1	7.57	7.53	7.48	7.40
89.6	32	7.4	7.1	6.9	6.6	6.4	6.2	5.9	7.4	—	—	—
93.2	34	7.2	6.9	6.7	6.4	6.2	6.0	5.8	7.2	—	—	—
96.8	36	7.0	6.7	6.5	6.3	6.0	5.8	5.6	7.0	—	—	—
100.4	38	6.8	6.6	6.3	6.1	5.9	5.6	5.4	6.8	—	—	—
104.0	40	6.6	6.4	6.1	5.9	5.7	5.5	5.3	6.6	—	—	—

Note: ft = 0.3048 m.

entering the aeration tank and by the decreasing partial pressure in the air bubble as oxygen is absorbed. For these cases, a mean saturation value corresponding to the aeration tank middepth is used:

$$C_{s,m} = C_s \times \frac{1}{2} \left( \frac{P_b}{P_a} + \frac{O_i}{20.9} \right) \quad (5.8)$$

where  $P_a$  = atmospheric pressure  
 $P_b$  = absolute pressure at the depth of air release  
 $O_i$  = percent concentration of oxygen in the air leaving the aeration tank

Mueller et al.<sup>4</sup> have shown that oxygen saturation is a function not only of submergence but also of diffuser type. Coarse bubble units provide lower clean water saturation values than the fine bubble or jet diffusers. Saturation appears to be related to both bubble size and mixing pattern. It should further be noted that field data seems to suggest that the 0.25 depth level may be more accurate for fine bubble diffusers (Schmit et al.<sup>5</sup>). Therefore where possible oxygen saturation should be determined from field data.

To account for wastewater constituents, a factor is used:

$$\beta = \frac{C_s \text{ wastewater}}{C_s \text{ tap water}}$$

The ASCE committee on oxygen transfer<sup>19</sup> has recommended using a correction for TDS as shown in Table 5.1 to determine  $\beta$ .

The oxygen-transfer coefficient  $K_L a$  is affected by the physical and chemical variables characteristic of the aeration system:

1. *Temperature.* The liquid-film coefficient will increase with increasing temperature. When air bubbles are involved, changes in liquid temperature will also affect the size of bubbles generated in the system. The effect of temperature on the coefficient is

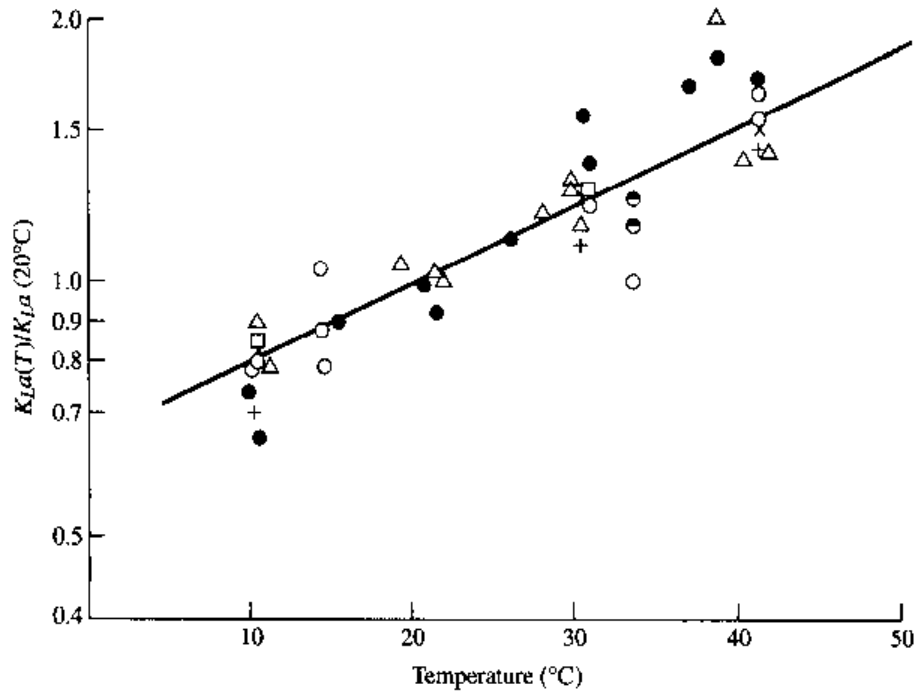
$$K_L(T) = K_L(20^\circ\text{C})\theta^{T-20} \quad (5.9)$$

For diffused aeration units,  $\theta$  is usually taken as 1.02. Correlation's of Imhoff and Albrect<sup>6</sup> showed  $\theta$  to be higher for low-turbulence diffused systems and lower for high-turbulence surface aeration systems. Landberg et al.<sup>7</sup> suggested  $\theta$  of 1.012 for surface aeration systems. The effect of temperature on  $K_L a$  is shown in Figure 5.1.

2. *Turbulent mixing.* Increasing the degree of turbulent mixing will increase the overall transfer coefficient.
3. *Liquid depth.* The effect of liquid depth  $H$  on  $K_L a$  will depend in large measure on the method of aeration. For most types of bubble-diffusion systems,  $K_L a$  will vary with depth according to the relationship

$$\frac{K_L a(H_1)}{K_L a(H_2)} = \left( \frac{H_1}{H_2} \right)^n \quad (5.10)$$

The exponent  $n$  has a value near 0.7 for most systems. Wagner and Popel<sup>8</sup> evaluated several diffused aeration systems and showed that the oxygen-transfer efficiency increased 1.5 percent per foot of depth.



Symbol	Substance	Unit
○	Water	Spinnerette 20 holes, 0.035 mm diameter
+	Water	Spinnerette 10 holes, 0.05 mm diameter
●	Water	Aloxite stone
△	1% KCl	Aloxite stone
□	1% KCl	Spinnerette 10 holes, 0.05 mm diameter
×	50 ppm heptanoic acid	Spinnerette 20 holes, 0.035 mm diameter
●	Water	Data of Carpani and Roxburgh <sup>9</sup>
△	Water	Data of Gameson and Robertson <sup>10</sup>

**FIGURE 5.1**

Relationship between the overall transfer coefficient  $K_L a$  and temperature.

4. *Waste characteristics.* The presence of surface-active agents and other organics will have a profound effect on both  $K_L$  and  $A/V$ . Molecules of surface-active materials will orient themselves on the interfacial surface and create a barrier to diffusion. The excess surface concentration is related to the change in surface tension, as defined by the Gibbs equation, such that small concentrations of surface-active material will depress  $K_L$  while large concentrations will exert no further effect. The absolute effect of surfactants on  $K_L$  will also depend on the nature of the aeration surface. Less effect would be exerted at a highly turbulent liquid surface, since the short life of any interface would restrict the formation of an adsorbed film. Conversely, a greater effect would be exerted at a bubble surface because of the relatively long life of the bubble as it rises through an aeration tank. A decrease in surface tension will decrease the size of bubbles generated from an air-diffusion system. This in turn will increase  $A/V$ .

In some cases, the increase in  $A/V$  will exceed the decrease in  $K_L$ , and the transfer rate will increase over that in water. The effect of waste characteristics on  $K_L a$  is defined by a coefficient  $\alpha$  in which

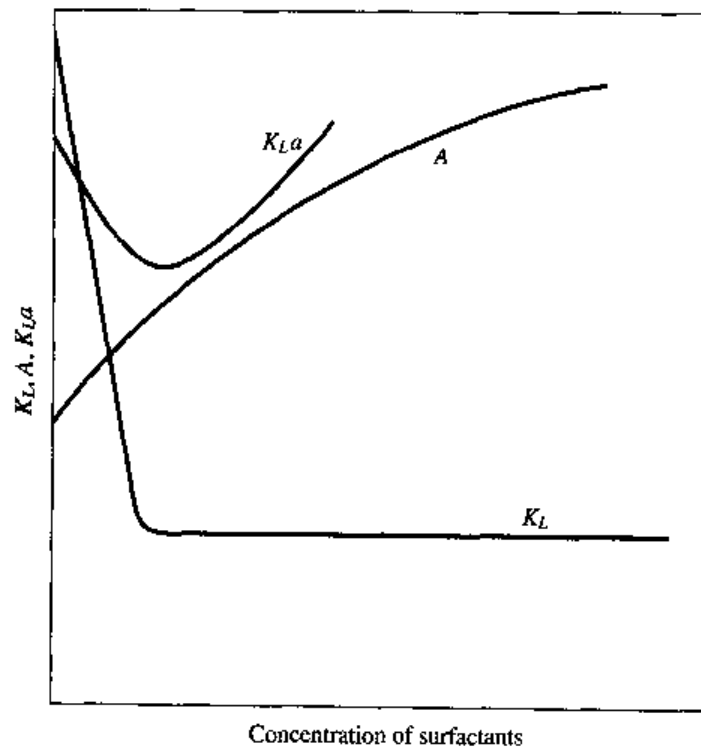
$$\alpha = \frac{K_L a \text{ waste}}{K_L a \text{ water}}$$

These relationships are shown in Fig. 5.2.

Turbulence has a significant effect on  $\alpha$ . At high turbulence levels, oxygen transfer is dependent on surface renewal and not significantly affected by diffusion through interfacial resistances. Under these conditions  $\alpha$  may be greater than 1.0 because of the increased  $A/V$  ratio. Under low-turbulence conditions, the bulk oxygen transfer resistance is reduced but surface renewal does not yet occur, thus surfactant interfacial resistance causes a significant reduction in the oxygen transfer rate, as shown in Fig. 5.3. Increasing the TDS will increase  $K_L a$  due to the generation of finer bubbles, as shown in Fig. 5.4.

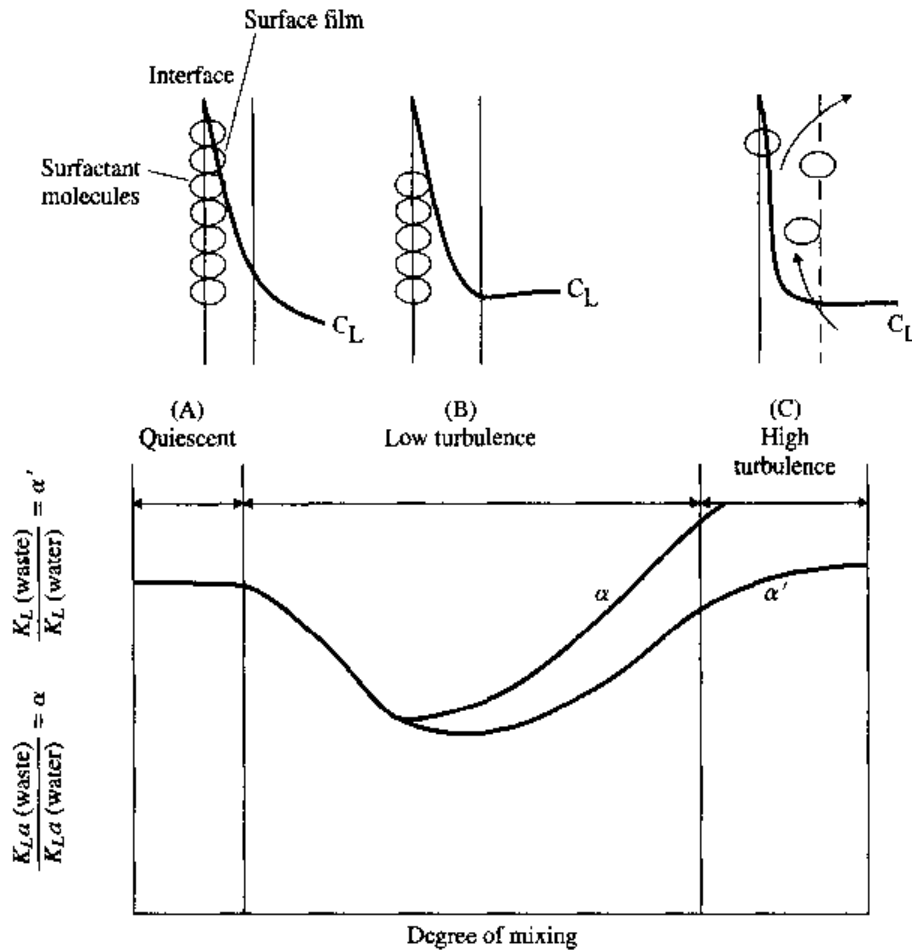
In order to compare the transfer rate in water to a waste with a particular aeration device, a coefficient  $\alpha$  has been defined as  $K_L a (\text{waste})/K_L a (\text{water})$ . The coefficient  $\alpha$  can be expected to increase or decrease and approach unity during the course of biooxidation, since the substances affecting the transfer rate are being removed in the biological process, as shown in Fig. 5.5.

In view of the effects previously mentioned, the type of aeration will have a profound effect on  $\alpha$ . For the fine-bubble diffuser systems, values are generally lower than for coarse-bubble or surface aeration systems. Variation in mixed liquor



**FIGURE 5.2**

Effect of concentration of surface active agent on oxygen transfer.



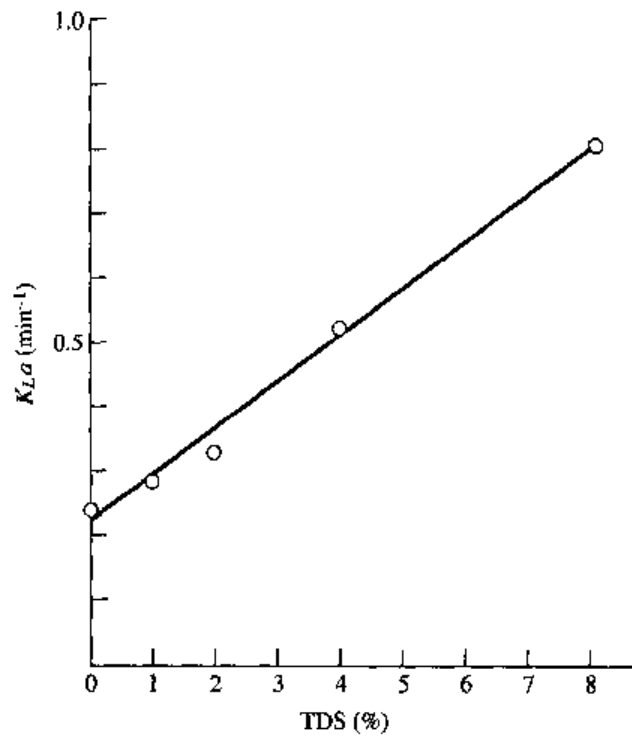
**FIGURE 5.3**  
Effect of turbulence on oxygen transfer.

suspended solids (MLSS) from 2000 to 7000 mg/l with dome diffusers had no significant effect on  $K_L\alpha$ . Reported values of  $\alpha$  for different aeration devices are summarized in Table 5.2. In plug flow basins the  $\alpha$  value will increase as purification occurs through the tank length. This is shown in Fig. 5.6 for two types of aeration devices.<sup>15</sup>

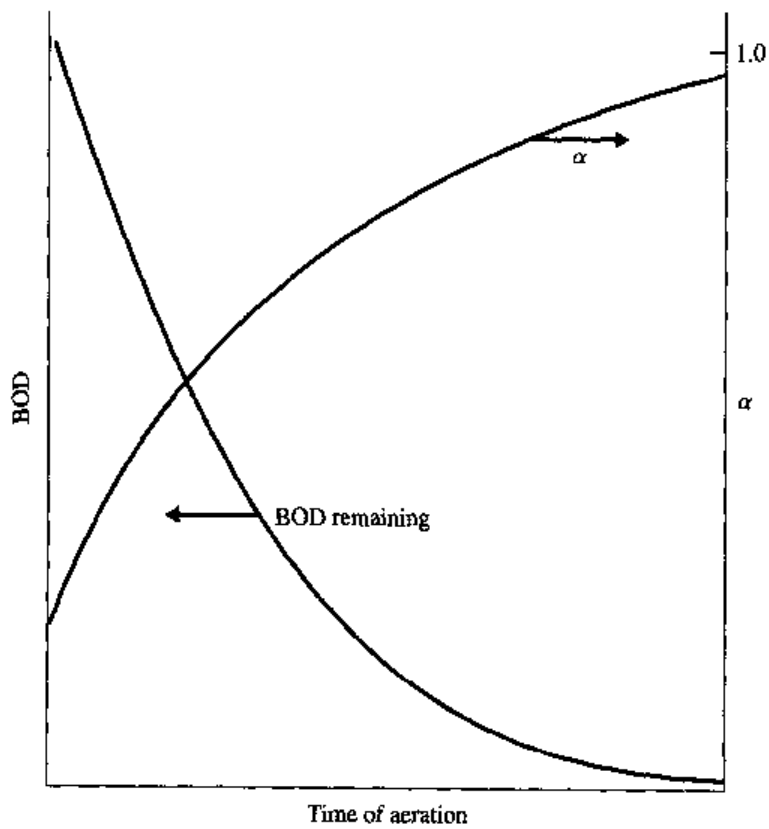
In diffused aeration systems, air bubbles are formed at an orifice from which they break off and rise through the liquid, finally bursting at the liquid surface. The velocity and shape of the air bubbles is related to a modified Reynolds number. At  $N_{Re}$  of 300 to 4000, the bubbles assume an ellipsoidal shape and rise with a rectilinear rocking motion. At  $N_{Re}$  greater than 4000, the bubbles form spherical caps. The rising velocity of the bubble is increased at high airflows because of the proximity of other bubbles and the resulting disturbances of the bubble wakes.

A general correlation for oxygen transfer from air bubbles rising through a still water column has been developed by Eckenfelder,<sup>11</sup> as shown in Fig. 5.7. The general relationship obtained is

$$\frac{K_L d_B}{D_L} H^{1/3} = C \left( \frac{d_B^3 \nu_B \rho}{\mu} \right) \quad (5.11)$$



**FIGURE 5.4**  
Effect of TDS on the oxygen transfer rate.

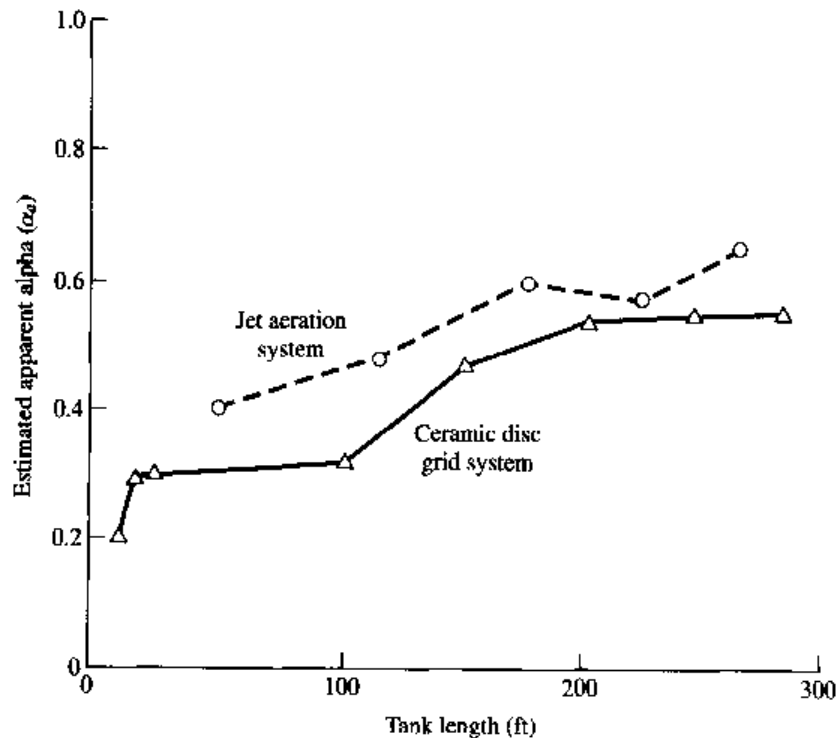


**FIGURE 5.5**  
Change in transfer coefficient  $\alpha$  in a biological oxidation process.

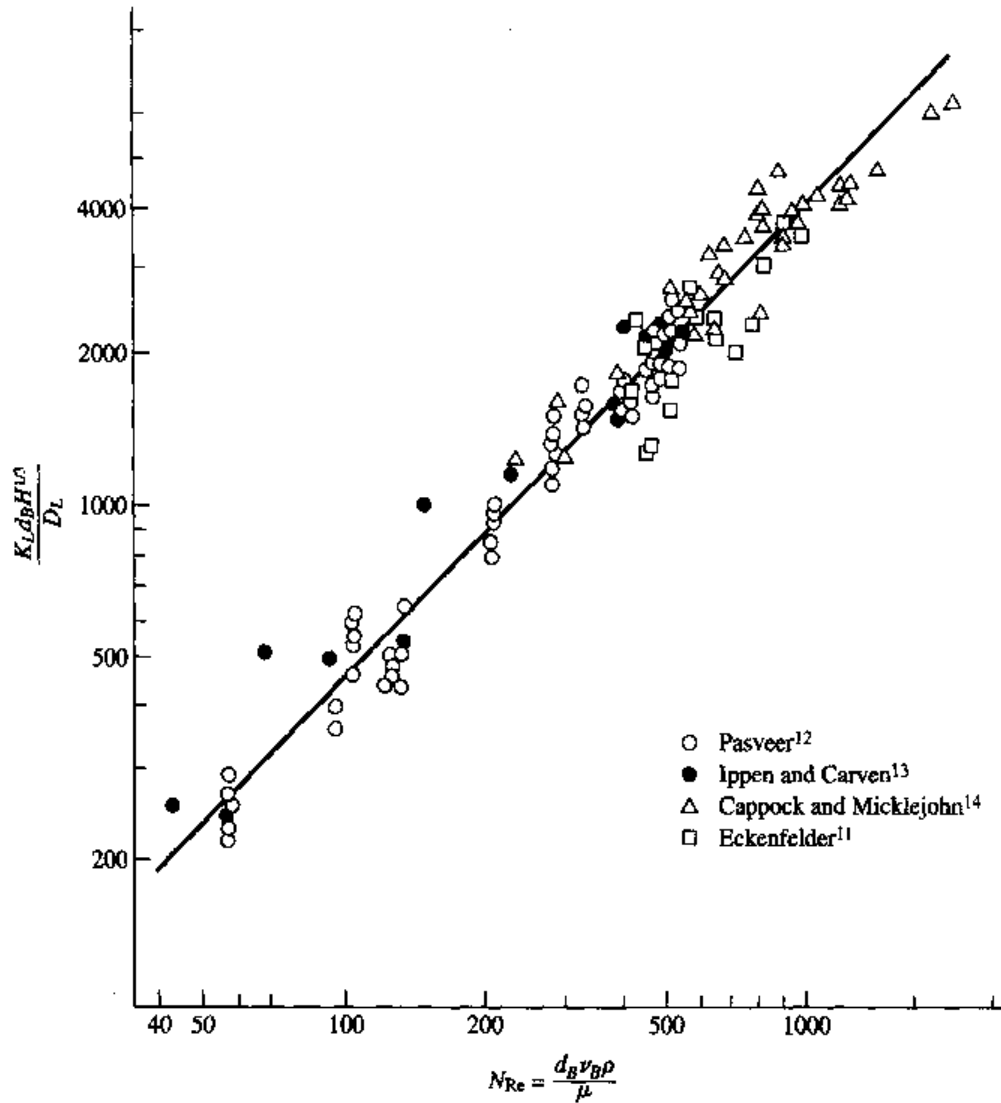


**TABLE 5.2**  
**Values of  $\alpha$  for different aeration devices**

Aeration device	Alpha factor	Wastewater
Fine bubble diffuser	0.4–0.6	Tap water containing detergent
Brush	0.8	Domestic wastewater
Coarse bubble diffuser, sparger	0.7–0.8	Domestic wastewater
Coarse bubble diffuser, wide band	0.65–0.75	Tap water with detergent
Coarse bubble diffuser, sparger	0.55	Activated sludge contact tank
Static aerator	0.60–0.95	Activated sludge treating high-strength industrial waste
Static aerator	1.0–1.1	Tap water with detergent
Surface aerators	0.6–1.2	Alpha factor tends to increase with increasing power (tap water containing detergent and small amounts of activated sludge)
Turbine aerators	0.6–1.2	Alpha factor tends to increase with increasing power; 25, 50, 190 gal tanks (tap water containing detergent)



**FIGURE 5.6**  
Estimated change in apparent alpha with tank length, Whittier Narrows, California.



**FIGURE 5.7**  
Correlation of bubble-aeration data.

where  $C$  = constant  
 $d_B$  = bubble diameter  
 $v_B$  = bubble velocity  
 $\rho$  = liquid density  
 $\mu$  = liquid viscosity

Equation (5.11) can be expressed in terms of the overall coefficient  $K_L a$  if  $A/V$  for air bubbles in an aeration tank is considered as

$$\frac{A}{V} = \frac{6G_s H}{d_B v_B V} \quad (5.12)$$

where  $G_s$  is the airflow. Equation (5.11) neglects the aeration tank liquid surface as small compared to the interfacial bubble surface.

Over the range of airflows normally encountered in aeration practice,

$$d_B \approx G_s^n \quad (5.13)$$

Equations (5.11) to (5.13) can be combined to yield a general relationship for oxygen transfer from air-diffusion systems:

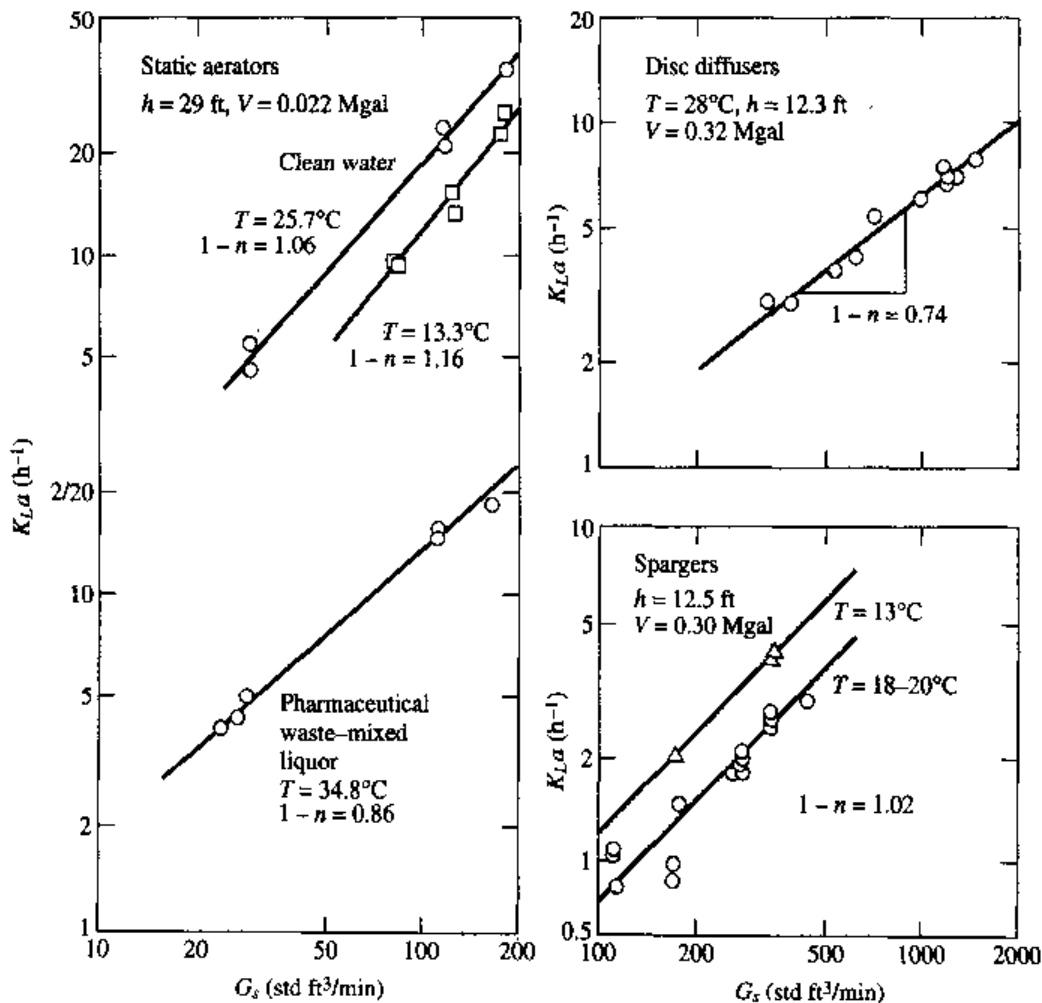
$$K_L a = \frac{C'H^{2/3}G_s^{(1-n)}}{V} \quad (5.14)$$

The relationship between  $K_L a$  and gas flow for several diffusion devices is shown in Fig. 5.8.

Equation (5.14) can be reexpressed in terms of the mass of oxygen transferred per diffusion unit:

$$N = C'H^{2/3}G_s^{(1-n)}(C_s - C_L) \quad (5.15)$$

where  $N$  is the mass of  $O_2$  per hour transferred per diffuser unit.



**FIGURE 5.8**

Effect of gas flow on  $K_L a$  for various types of diffuser systems under process conditions.<sup>22</sup>

The oxygen transfer efficiency of a unit is defined as

$$\begin{aligned} \text{Percent transfer} &= \frac{\text{wt O}_2 \text{ adsorbed/unit time}}{\text{wt O}_2 \text{ supplied/unit time}} \times 100 \\ &= \frac{K_L a (C_s - C_L) \times V}{G_s (\text{std ft}^3/\text{min}) \times 0.232 \text{ lb O}_2/\text{lb air}} \times 100 \\ &\quad \times 0.075 \text{ lbs air/std ft}^3 \end{aligned} \quad (5.16)$$

**EXAMPLE 5.1.** The following data were obtained on the oxygen transfer capacity of an air-diffusion unit in clean water.

Airflow rate	25 std ft <sup>3</sup> /min · thousand ft <sup>3</sup> [25 l/(min · m <sup>3</sup> )]
Volume	1000 ft <sup>3</sup> (28.3 m <sup>3</sup> )
Temperature	54°F (12°C)
Liquid depth	15 ft (4.6 m)
Average bubble diameter	0.3 cm
Average bubble velocity	32 cm/s

Time, min	C <sub>L</sub> , mg/l
3	0.6
6	1.6
9	3.1
12	4.3
15	5.4
18	6.0
21	7.0

- Compute  $K_L a$  and  $K_L$ .
- Compute the mass of O<sub>2</sub> per hour transferred per unit volume at 20°C and zero dissolved oxygen, and the oxygen transfer efficiency.
- How much oxygen will be transferred to a waste with an  $\alpha$  of 0.82, a temperature of 32°C, and an operating dissolved oxygen of 1.5 mg/l?

**Solution.**

- At a temperature of 54°F (12°C) saturation is 10.8 mg/l. The mean saturation in the aeration tank, assuming 10 percent oxygen adsorption, is

$$C_{s,m} = C_s \left( \frac{P_b}{29.4} + \frac{O_t}{42} \right)$$

where

$$P_b = \frac{15 \text{ ft}}{2.3 \text{ ft}/(\text{lb} \cdot \text{in}^2)} + 14.7 = 21.2 \text{ lb}/\text{in}^2 (1.44 \text{ atm})$$

$$O_t = \frac{21(1 - 0.1)}{21(1 - 0.1) + 79} \times 100 = 19.3\% \text{ O}_2$$

$$C_{s,m} = 10.8 \left( \frac{21.2}{29.4} + \frac{19.3}{42} \right) = 10.8 \times 1.18$$

$$= 12.7 \text{ mg/l}$$

Time, min	$C_{s,m} - C_L$
3	12.1
6	11.1
9	9.6
12	8.4
15	7.3
18	6.7
21	5.7

From Eq. (5.22),

$$\log(C_{s,m} - C_L) = \log(C_{s,m} - C_0) - \frac{K_L a}{2.3} t$$

which represents a straight line on a semilog plot of  $\log(C_{s,m} - C_L)$  versus  $L$ .  $K_L a$  can be computed from the slope of the line in Fig. 5.9.

$$K_L a = 2.3 \frac{\log(14/9)}{10} \times 60 = 2.63/\text{h}$$

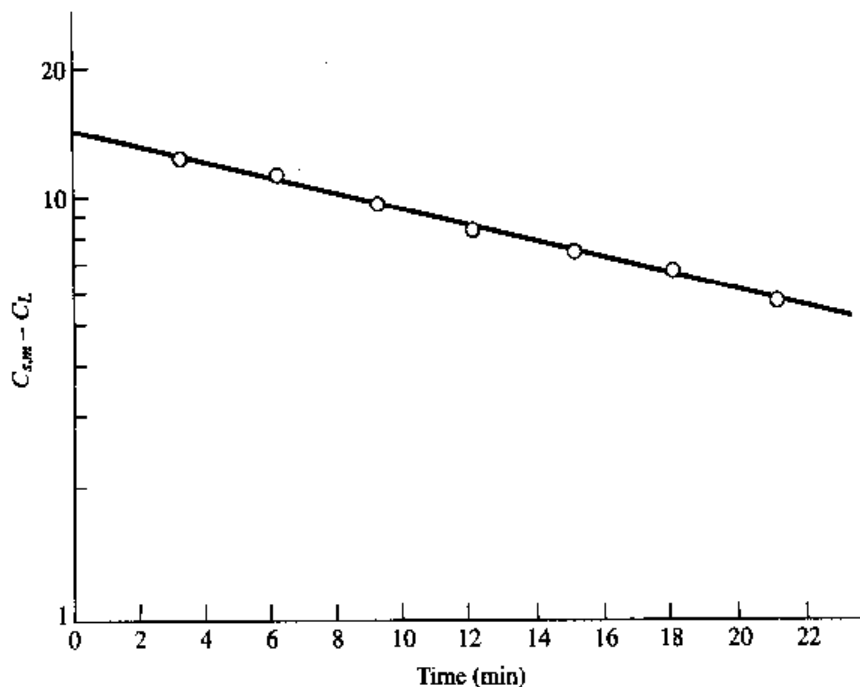


FIGURE 5.9

The interfacial area/volume ratio  $A/V$  is

$$\frac{A}{V} = \frac{6G_s H}{d_B v_B V} = \frac{6 \times 25 \times 15 \times 60}{(0.3/30.5) \times (32/30.5) \times 3600 \times 1000} = 3.65 \text{ ft}^2/\text{ft}^3 \text{ (12 m}^2/\text{m}^3\text{)}$$

where  $d_B$  = average bubble diameter  
 $H$  = aeration liquid depth  
 $v_B$  = average bubble velocity  
 $V$  = volume

$$\begin{aligned} K_L &= \frac{K_L a}{A/V} \\ &= \frac{2.63}{3.65} = 0.72 \text{ ft/h (21.96 cm/h)} \end{aligned}$$

(b)

$$\begin{aligned} K_L a_T &= K_L a_{20} \times 1.02^{T-20} \\ K_L a_{20} &= 1.02^8 \times 2.63 = 1.17 \times 2.63 = 3.07/\text{h} \\ C_{s,m(20^\circ)} &= 9.1 \times 1.18 = 10.7 \text{ mg/l} \\ N_O &= K_L a V C_{s,m} \\ &= 3.07/\text{h} \times 1000 \text{ ft}^3 \times 10.7 \text{ mg/l} \times 7.48 \text{ gal/ft}^3 \\ &\quad \times 8.34 \times 10^{-6} \\ &= 2.05 \text{ lb O}_2/\text{h} \quad (0.93 \text{ kg O}_2/\text{h}) \end{aligned}$$

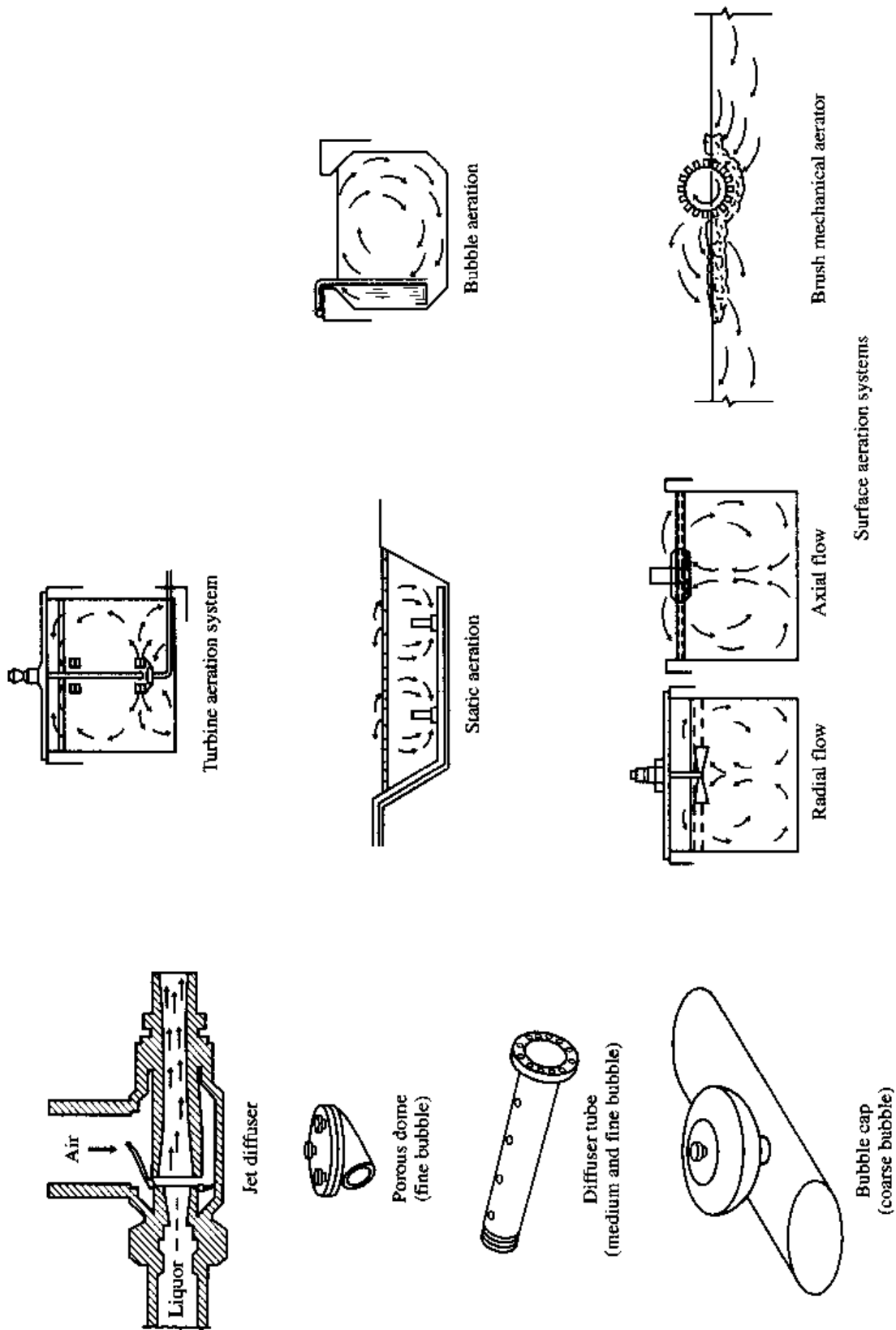
$$\begin{aligned} \% \text{ O}_2 \text{ transfer efficiency} &= \frac{2.05 \text{ lb O}_2/\text{h transferred}}{25 \times 60 \times 0.0746 \times 0.232 \text{ lb O}_2/\text{h supplied}} \times 100 \\ &= 8.0 \end{aligned}$$

(c) The weight of oxygen transferred is determined from Eq. (5.17):

$$\begin{aligned} N &= N_O \left( \frac{\beta C_{s,m} - C_L}{C_{s,m(20^\circ)}} \right) \alpha \times 1.02^{T-20} \\ &= 2.05 \left( \frac{0.99 \times 7.4 \times 1.18 - 1.5}{10.7} \right) \times 0.82 \times 1.02^{12} \\ &= 1.42 \text{ lb/h (0.64 kg/h)} \end{aligned}$$

## 5.2 AERATION EQUIPMENT

The aeration equipment commonly used in the industrial waste field consists of air-diffusion units, turbine aeration systems in which air is released below the rotating blades of an impeller, and surface aeration units in which oxygen transfer is accomplished by high surface turbulence and liquid sprays. Generic types of aeration equipment are shown in Fig. 5.10.



**FIGURE 5.10**  
Aeration equipment.

A manufacturer will generally designate the oxygen transfer capability of his equipment in terms of the pounds of  $O_2$  transferred per horsepower-hour [ $kg O_2/(kW \cdot h)$ ] or the oxygen-transfer efficiency or pounds of  $O_2$  transferred per hour ( $kg O_2/h$ ) per diffusion unit. This is called the standard oxygen rating (SOR) in tap water, at  $20^\circ C$ , and zero dissolved oxygen at sea level.

The actual oxygen transferred to the wastewater (AOR) is computed from

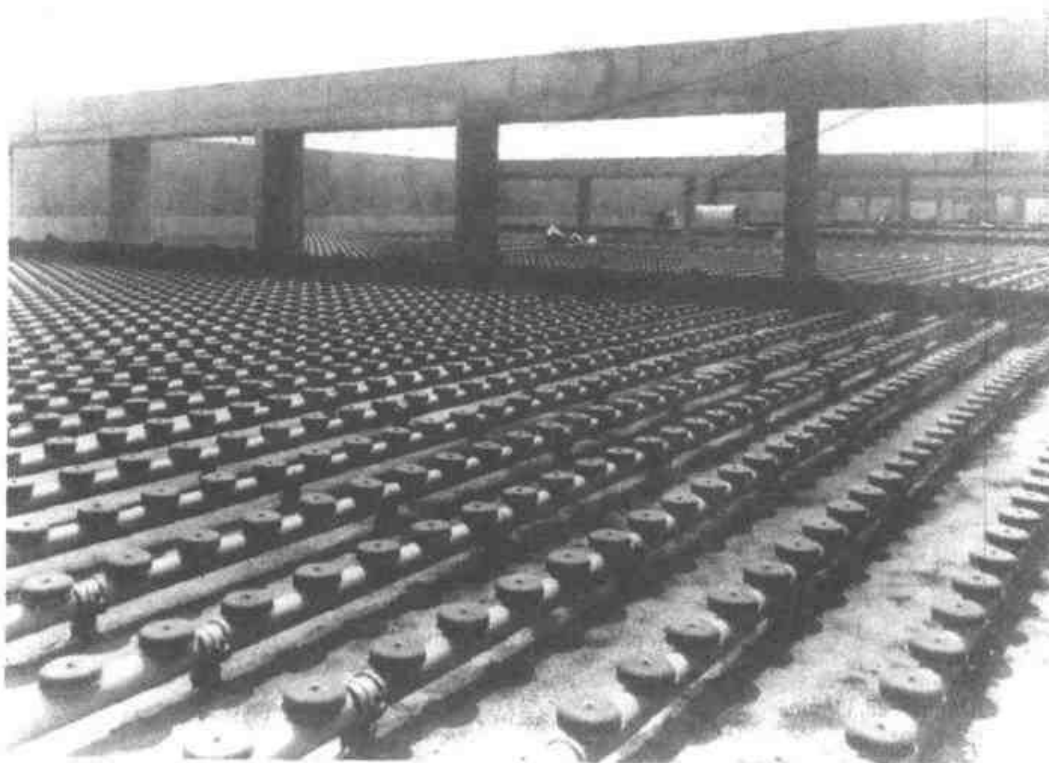
$$N = N_o \left( \frac{\beta C_s - C_L}{9.2} \right) \alpha \times 1.02^{T-20} \quad (5.17)$$

where  $N$  = AOR, lb  $O_2/hp \cdot h$       [ $kg O_2/kW \cdot h$ ]  
 $N_o$  = SOR, lb  $O_2/hp \cdot h$       [ $kg O_2/kW \cdot h$ ]

### Diffused Aeration Equipment

Basically, there are two types of diffused aeration equipment: units producing a small bubble from a porous medium or membrane and units using a large orifice or a hydraulic shear device to produce large air bubbles.

Porous media are either tubes or plates constructed of carborundum or other finely porous media or membranes. Tubes are placed at the sidewall of the aeration tank, perpendicular to the wall, and generate a rolling motion to maintain mixing or across the bottom of the basin. Maximum spacing is required to maintain solids in suspension; minimum spacing is required to avoid bubble coalescence. A diffused aeration system is shown in Fig. 5.11.

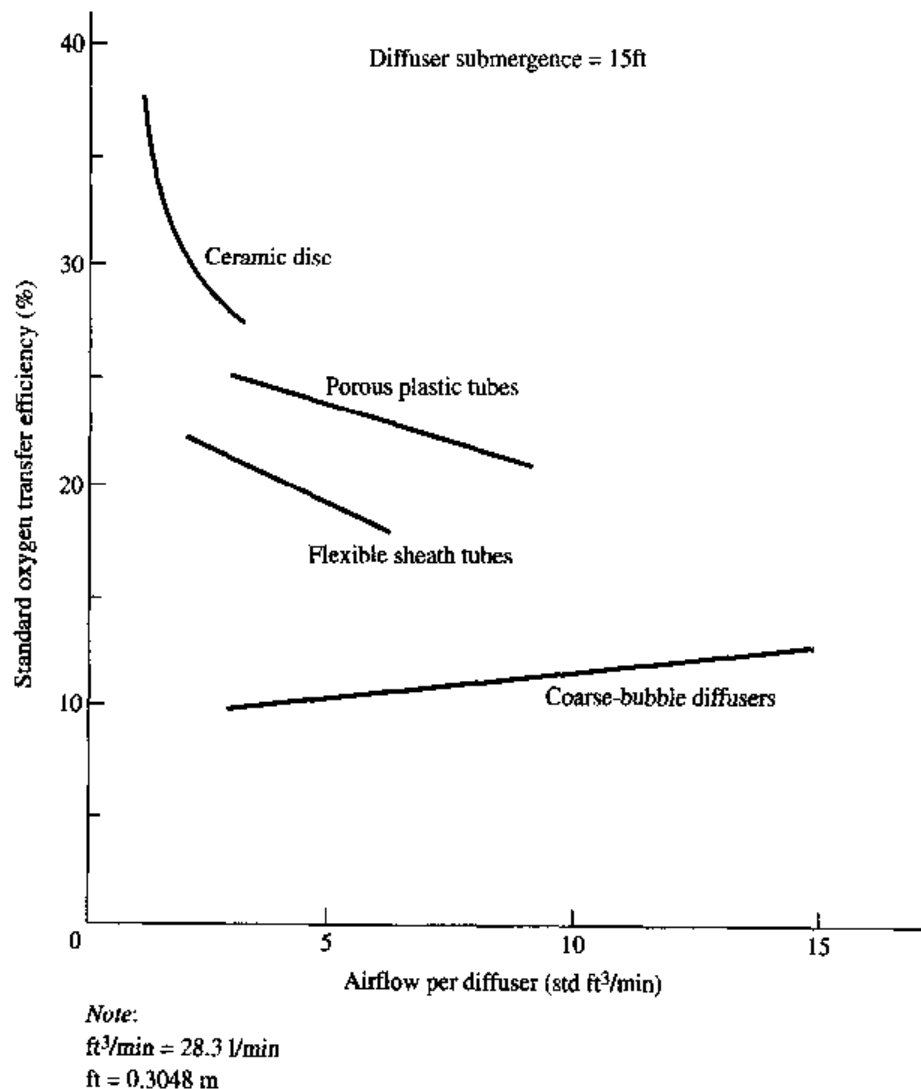


**FIGURE 5.11**  
Diffused aeration system.



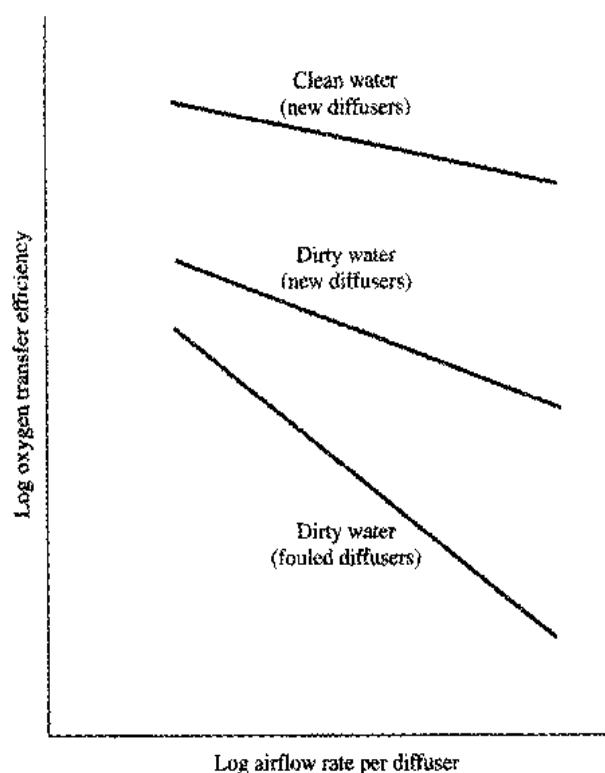
In order for adequate mixing to be maintained for sidewall mounts, the maximum width of the aeration tank is approximately twice its depth. This width can be doubled by placing a line of diffusion units along the centerline of the aeration tank. Figure 5.12 shows the performance of air-diffusion units in water in an aeration tank 15 ft (4.6 m) deep and 24 ft (7.3 m) wide. Fine bubble diffusers tend to clog with time, resulting in a reduced oxygen transfer efficiency as shown in Fig. 5.13. For bottom tank coverage, the tank must be drained and the diffusers cleaned.

The effect of diffuser placement on clean water oxygen transfer efficiency is shown in Table 5.3. Fine-bubble and membrane diffusers will tend to clog on the liquid side because of the precipitation of metal hydroxides and carbonates or formation of a biofilm layer. The fouling factor  $F$  is site specific and can vary from 0.2 to 0.9.  $F$  appears to increase with increasing solids retention time (SRT). The average  $F$  value for municipal wastewater treatment facilities using medium- to fine-bubble membrane diffusers is 0.6. This value will apply for most industrial



**FIGURE 5.12**

Effect of airflow rate per diffuser on oxygen transfer efficiency.



**FIGURE 5.13**  
Change in oxygen transfer efficiency with fine-pore diffuser fouling—a hypothetical case.

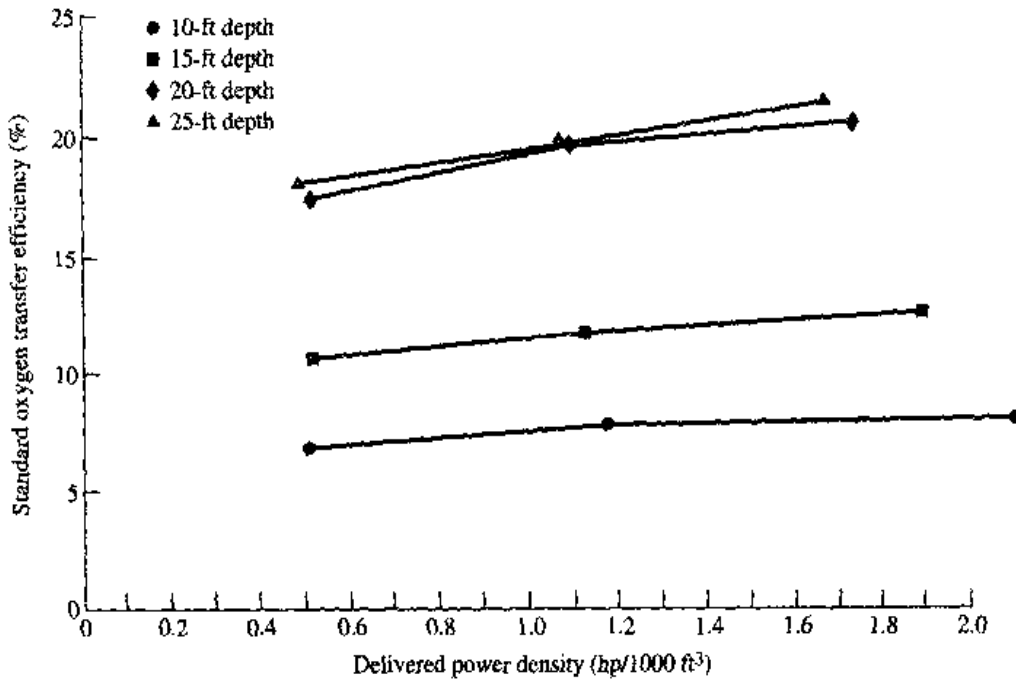
**TABLE 5.3**  
Effects of diffuser placement on clean water oxygen transfer efficiencies (OTEs) of flexible sheath tubes<sup>15</sup>

Placement	Airflow (std ft <sup>3</sup> /min/diffuser)	Standard OTE (%) at water depth		
		3 m	4.5 m	6 m
Floor cover (grid)	1-4	14-18	21-27	29-35
Quarter points	2-6	13-15	18-22	24-29
Mid-width	2-6	9-11	15-18	23-17
Single-spiral roll	2-6	7-11	14-18	21-28

Note: cfm  $\times$  0.47 = l/s

facilities unless other information is available. In cases where fouling is a factor,  $\alpha$  in Eq. (5.17) should be corrected to  $F\alpha$ .

Large-bubble air-diffusion units will not yield the oxygen-transfer efficiency of fine-bubble diffusers since the interfacial area for transfer is considerably less. These units have the advantage, however, of not requiring air filters and of generally requiring less maintenance. These units generally operate over a wider range of airflow per unit. Performance data for coarse-bubble aeration units are shown in Fig. 5.14.



Note:

10- and 20-ft depths: 24-D-24 fixed-orifice diffusers applied in a total floor coverage configuration.  
15- and 25-ft depths: 30-D-24 fixed-orifice diffusers applied in a wide-band configuration along one centerline of the tank.

**FIGURE 5.14**

Oxygen transfer efficiency of coarse-bubble diffusers (courtesy of Sanitaire Corp.). Results are for clean water.

Static aerators consist of vertical cylindrical tubes placed at specified intervals in an aeration basin and containing fixed internal elements.

In aeration of sewage or industrial wastes, the coefficient  $\alpha$  will usually be less than 1.0. There is some evidence that the large-bubble diffusers are less affected by the presence of surface-active materials than are the fine-bubble diffusers.

A diffused aeration design is shown in Example 5.2.

**EXAMPLE 5.2.** An aeration system is to operate under the following conditions:

Aeration Design

$$1000 \text{ lb } O_2/h$$

$$T = 30^\circ\text{C}$$

$$C_L = 2 \text{ mg/l}$$

$$\beta = 0.95$$

$$\alpha = 0.85$$

$$D = 20 \text{ ft}$$

Use coarse bubble diffusers with a 12 percent oxygen transfer efficiency (OTE) at 15 std ft<sup>3</sup>/min per tube and 15-ft liquid depth. At 20 ft:

$$\text{OTE} = 12 \left( \frac{20}{15} \right)^{0.7} = 14.7\%$$

O<sub>2</sub> saturation at 30°C is 7.6 mg/l. Assume 15% OTE. Then

$$O_t = \frac{21(1 - 0.15) \times 100}{79 + 21(1 - 0.15)}$$

$$= 0.18$$

$$C_{s,m} = \frac{7.6}{2} \left[ \frac{14.7 + 0.433 \times 20}{14.7} + \frac{18}{21} \right]$$

$$= 9.3 \text{ mg/l}$$

$$N = 15 \text{ std ft}^3/\text{min}/\text{unit} \times 60 \times 0.232 \times 0.0746 \times 0.147$$

$$= 2.29 \text{ lb O}_2/\text{h}/\text{unit}$$

$$N = N_o \left[ \frac{\beta C_{sw} - C_L}{C_s} \right] \alpha \times 1.02^{T-20}$$

$$= 2.29 \left[ \frac{0.95 \times 9.3 - 2.0}{9.3} \right] 0.85 \times 1.02^{10}$$

$$= 1.74 \text{ lb O}_2/\text{h}/\text{unit}$$

$$\frac{1000 \text{ lb O}_2/\text{h}}{1.74} = 575 \text{ diffusers}$$

$$\text{Airflow} = 575 \times 15 = 8620 \text{ std ft}^3/\text{min}$$

$$\text{hp} = \frac{(\text{std ft}^3/\text{min})(\text{lb}/\text{in}^2)(144)}{0.7 \times 33,000} \quad (195 \text{ kW})$$

$$= \frac{8620 \times 10 \times 144}{0.7 \times 33,000} = 537$$

## Turbine Aeration Equipment

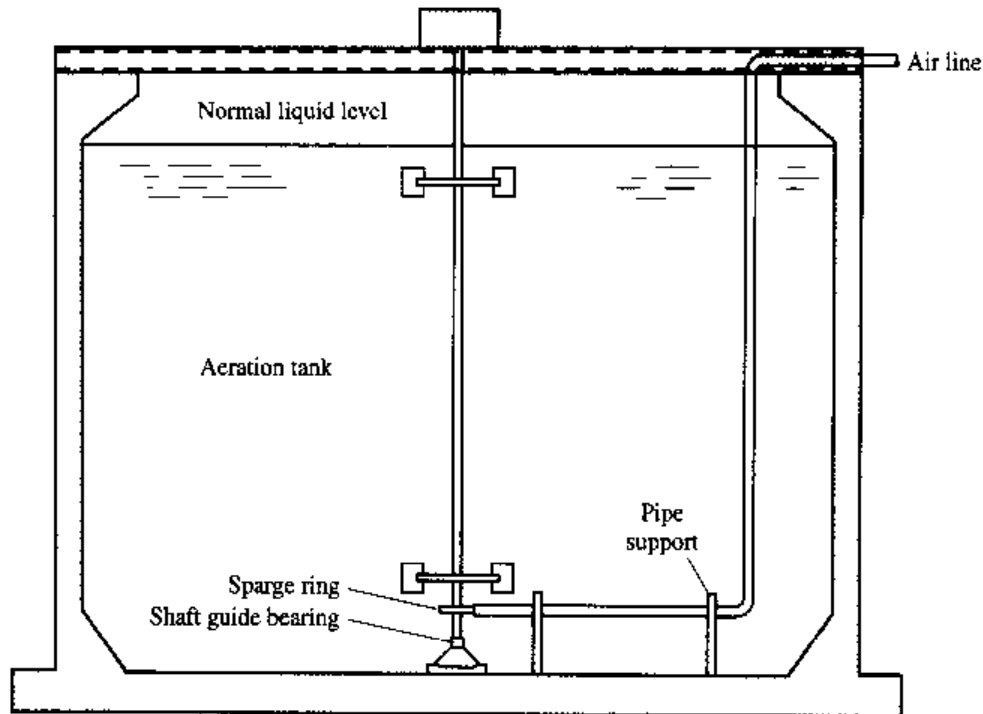
Turbine aeration units disperse compressed air by the shearing and pumping action of a rotating impeller. Since the degree of mixing is independently controlled by the power input to the turbine, there are no restrictive limitations to tank geometry. Figure 5.15 shows a typical turbine aeration unit.

Air is usually fed to the turbine through a sparge ring located just beneath the impeller blades. The ratio of the turbine diameter to the equivalent tank diameter varies from 0.1 to 0.2. Most aeration applications have employed impeller tip speeds of 10 to 18 ft/s (3.1 to 5.5 m/s).

Quirk<sup>16</sup> showed that the oxygen transfer for a turbine aerator can be estimated.

$$\text{O}_2 \text{ transfer efficiency} = CP_d^n \quad (5.18)$$

where  $P_d = \text{hp}_R/\text{hp}_C$  in which  $\text{hp}_R$  and  $\text{hp}_C$  are the horsepower (kW) of the turbine and compressor, respectively. The optimum oxygenation efficiency occurs when the power split between turbine and blower is near a 1:1 ratio.<sup>15</sup>



**FIGURE 5.15**  
Typical turbine aerator installation.

The actual power drawn by the impeller will decrease as air is introduced under the impeller because of the decreased density of the aerating mixture. The transfer efficiency of turbine aeration units will vary from 1.6 to 2.9 lb O<sub>2</sub>/hp · h [0.97 to 1.76 kg O<sub>2</sub>/(kW · h)], depending on the turbine-blower power split.

To eliminate swirling and vortexing, baffles are normally required. In a round tank, four baffles are placed equally around the circumference of the wall. In a square tank, two baffles on opposite walls are used, while in a rectangular tank with a length/width ratio greater than 1.5 no baffles are required.

### Surface-Aeration Equipment

Surface-aeration units are of two types: those employing a draft tube and those with only a surface impeller. In both types, oxygen transfer occurs through a vortexing action and from the surface area exposure of large volumes of liquid sprayed over the surface of the aeration tank. Examples of these units are shown in Figs. 5.16 and 5.17. The transfer rate is influenced by the diameter of the impeller and its speed of rotation, and by the submergence level of the rotating element. Under optimum submergence conditions, the transfer rate per unit horsepower (W) remains relatively constant over a wide range of impeller diameters.

The quantity of oxygen transferred at the liquid surface is a function of the power level, and the overall oxygen transfer rate generally increases with increasing power level. Kormanik et al.<sup>17</sup> have shown a correlation between the oxygen-transfer rate



**FIGURE 5.16**  
Low-speed surface aerator.



**FIGURE 5.17**  
High speed surface aerator (*courtesy of Aqua Aerobic Systems Inc.*).

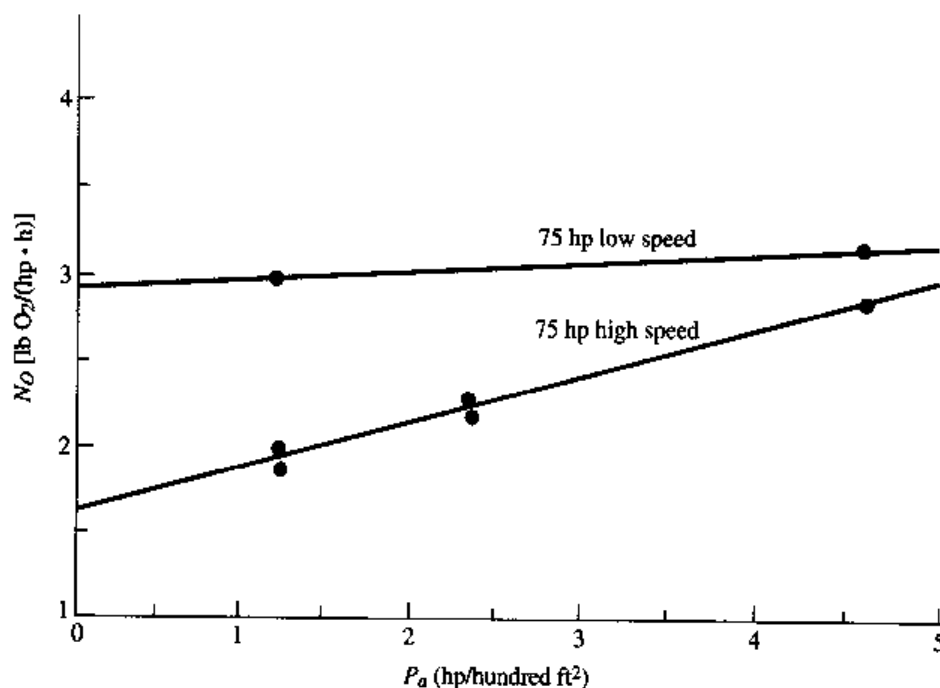
and horsepower per unit surface area, as shown in Fig. 5.18. To maintain uniform dissolved oxygen concentrations requires power levels of 6 to 10 hp/million gal (1.2 to 2.0 W/m<sup>3</sup>). The maximum area of influence for high speed and low speed surface aerators is shown in Table 5.4. To maintain biological solids in suspension, a minimum bottom velocity of 0.4 ft/s (12 cm/s) is required for 5000 mg/l MLSS.

To prevent bottom scour, minimum depths of 6 to 8 ft (1.8 to 2.4 m) are recommended, and, to maintain solids in suspension, maximum depths of 12 ft (3.7 m) are recommended for high-speed aerators and 16 ft (4.9 m) for low-speed aerators.

The brush aerator, which has been very popular in Europe, uses a high-speed rotating brush that sprays liquid across the tank surface. A circular liquid motion is induced in the aeration tank. The performance of the brush aerator is related to the speed of rotation and submergence of the brush. The efficiencies of various aerators are shown in Table 5.5. Mixing requirements are shown in Table 5.6.

### Measurement of Oxygen Transfer Efficiency

Although several procedures have been followed to estimate the transfer efficiency of aeration devices, the non-steady-state aeration procedure has been generally adopted as a standard. This test involves the chemical removal of dissolved oxygen by the addition of sodium sulfite with cobalt added as a catalyst. The cobalt concentration should be 0.05 mg/l to avoid a "cobalt effect" on the magnitude of  $K_L a$ . The increase in oxygen concentration is measured during aeration under specified



Note:  
 lb/(hp · h) = 0.608 kg/(kW · h)  
 hp = 0.75 kW  
 hp/hundred ft<sup>2</sup> = 80.3 W/m<sup>2</sup>

**FIGURE 5.18**

Comparative effect of surface area on high- and low-speed surface aerators.<sup>17</sup>

TABLE 5.4  
Maximum area of influence for high-speed and for low-speed surface aerators<sup>18</sup>

Horsepower	Radius of influence, ft	
	High speed	Low speed
5	40	50
10	55	70
20	80	95
30	100	120
50	130	155
75	155	190
100	—	220
150	—	260

TABLE 5.5  
Summary of aerator efficiencies

Type of aerator	Water depth, ft	O <sub>2</sub> E, %	lb O <sub>2</sub> /hp · h <sup>†</sup>	Reference
<i>Fine bubble</i>				
Tubes—spiral roll	15	15–20	6.0–8.0	20
Domes—full floor coverage	15	27–31	10.8–12.4	20
<i>Coarse bubble</i>				
Tubes—spiral roll	15	10–13	4.0–5.2	20
Spargers—spiral roll	14.5	8.6	3.4	21
Jet aerators	15	15–24	4.4–4.8	20
Static aerators	15	10–11	4.0–4.4	20
	30	25–30	6.0–7.5	
<i>Turbine</i>	15	10–25	— <sup>‡</sup>	16
<i>Surface aerator</i>				
Low speed	12	—	5.9–7.5	17
High speed	12	—	3.3–5.0	17

<sup>†</sup> Wire horsepower must correct for overall blower efficiency.

<sup>‡</sup> Horsepower depends on power split.

Note:

ft = 0.3048 m

lb/(hp · h) = 0.608 kg/(kW · h)

conditions, and the overall transfer coefficient is calculated from Eq. (5.6). Dissolved oxygen can be measured by the Winkler test or by use of a dissolved oxygen probe. The suggested procedure for non-steady-state aeration is as follows:

1. Remove the dissolved oxygen in the aeration unit by adding sodium sulfite and cobalt chloride. A concentration of 0.05 mg/l of cobalt should be added, and 8 mg/l Na<sub>2</sub>SO<sub>3</sub> per mg/l dissolved oxygen.
2. Thoroughly mix the tank contents. In a diffused aeration unit, aeration for 1 to 2 minutes will usually be sufficient.



TABLE 5.6  
Activated sludge process mixing horsepower guide<sup>18</sup>

Aeration device <sup>†</sup>	hp/1000 ft <sup>3</sup> , activated sludge	hp/1000 ft <sup>3</sup> , aerobic digestion
High speed	1.30	2.00
Low speed	1.00	1.50
Brush ditch	0.60	1.00
Fine bubble (floor cover)	0.40	0.80
Fine bubble (gut roll)	1.00	1.50
Fine bubble (spiral roll)	0.75	1.25
Fine bubble (moving bridge)	0.60	1.00
Jet	1.00	1.50
Coarse bubble (floor cover)	0.60	1.00
Coarse bubble (gut roll)	1.00	1.50
Coarse bubble (spiral roll)	0.75	1.25
Submerged turbine	0.75	1.25

<sup>†</sup> Operation conditions:  
hp, delivered or water horsepower  
MLSS, 1500–3000 mg/l (activated sludge)  
MLSS, 10,000–20,000 mg/l (aerobic digestion)

3. Start the aeration unit at the desired operating rate. Sample for dissolved oxygen at selected time intervals. (At least 5 points should be obtained before 90 percent of saturation is reached.)
4. In a large aeration tank, multiple sampling points should be selected (both longitudinally and vertically) to compensate for concentration gradients.
5. If a dissolved oxygen probe is used, it can be left in the aeration tank; the values from the probe can be recorded at appropriate time intervals.
6. Record the temperature and measure oxygen saturation. If water is being aerated, it is usually satisfactory to select the saturation value from Table 5.1. For diffused aeration units, saturation should be corrected to the tank middepth according to Eq. (5.8).
7. Compute the oxygen-transfer rate in accordance with Eq. (5.6) (see Example 5.1).

Equation (5.6) can be integrated to yield

$$C_s - C_L = (C_s - C_0)e^{-K_L a t} \quad (5.19)$$

where  $C_0$  = dissolved oxygen at time zero. To evaluate the constants in Eq. (5.19), a nonlinear least-squares program is recommended by ASCE<sup>19</sup>, one that provides the best set for  $K_L a$ ,  $C_0$ , and  $C_s$ .

It is occasionally desirable to measure the oxygen-transfer rate in the presence of activated sludge. Either a steady-state or non-steady-state procedure can be followed for this purpose.

In the aeration of activated sludge, Eq. (5.6) must be modified to account for the effect of the oxygen-utilization rate of the sludge-liquid mixture:

$$\frac{dc}{dt} = K_L a(C_s - C_L) - r_r \quad (5.20)$$

where  $r_r$  is the oxygen-utilization rate in milligrams per liter per hour.

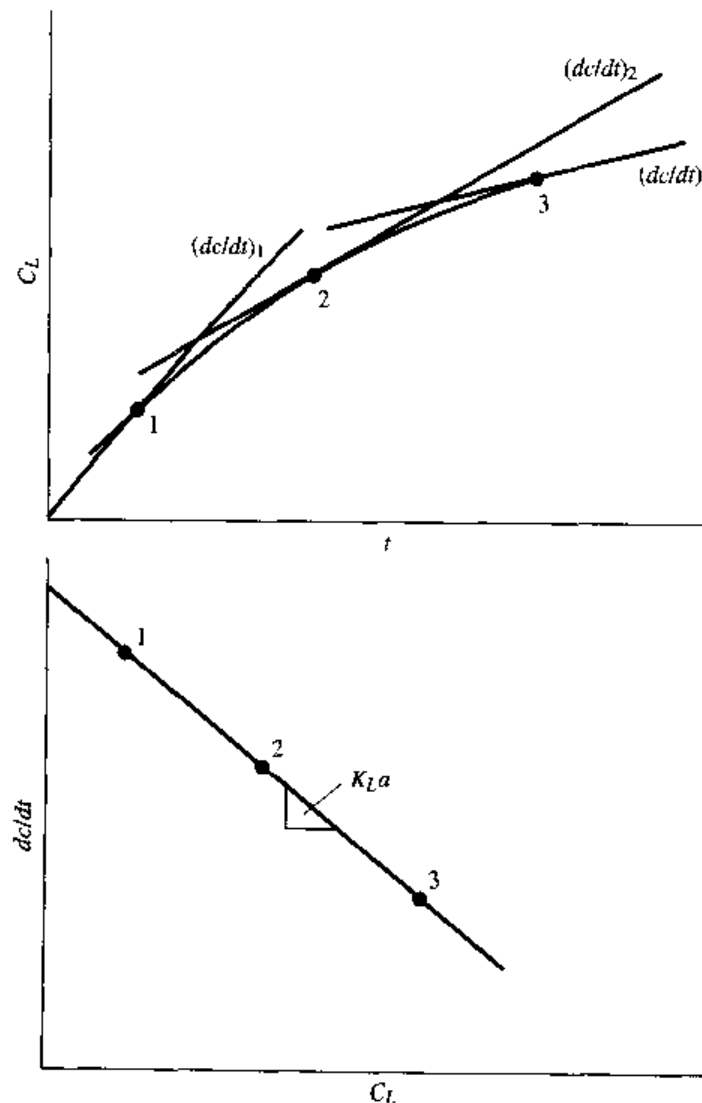
Under steady-state operation  $dc/dt \rightarrow 0$ , and  $K_L a$  can be computed from the relationship

$$K_L a = \frac{r_r}{C_s - C_L} \quad (5.21)$$

Aeration is continued until a constant oxygen uptake rate is obtained in order to ensure a steady state.

In the nonsteady procedure, aeration is stopped and the dissolved oxygen is allowed to approach zero by microbial respiration. Aeration is then begun and the buildup in dissolved oxygen recorded as in the non-steady-state water procedure; Fig. 5.19 shows how.  $K_L a$  can be computed from the slope of a plot of  $dc/dt$  versus  $C_L$ , in accordance with a rearrangement of Eq. (5.20):

$$\frac{dc}{dt} = K_L a(C_s - r_r) - K_L a C_L \quad (5.22)$$



**FIGURE 5.19**  
Non-steady-state evaluation of  $K_L a$ .

since  $K_L a(C_s - r_r)$  will be constant for any specific operating condition. This is shown in Example 5.3.

**EXAMPLE 5.3.** The following data were obtained for non-steady-state aeration in an activated sludge basin:

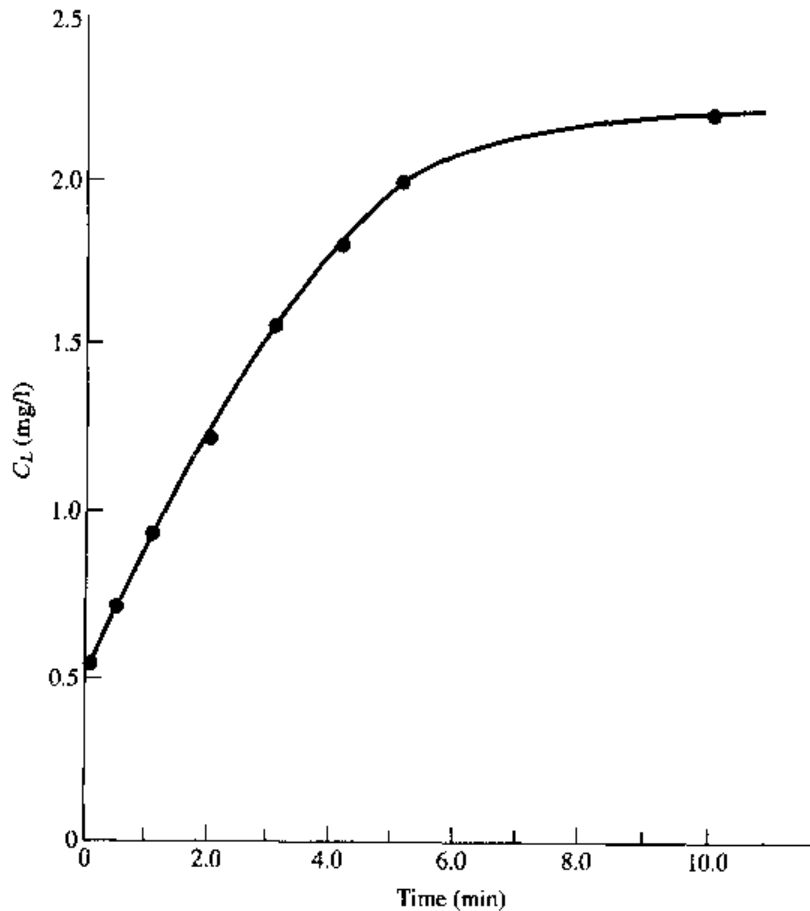
Time, min	$C_L$ , mg/l
0.0	0.52
0.5	0.70
1.0	0.93
2.0	1.23
3.0	1.55
4.0	1.80
5.0	2.00
10.0	2.20

**Solution.**

Determine the  $K_L a$ .

The non-steady-state equation is:

$$\frac{dC_L}{dt} = K_L a(C_s - C_L) - R_r$$



**FIGURE 1** For Example 5.3

Rearrangement yields:

$$\frac{dC_L}{dt} = (K_L a C_s - R_r) - K_L a C_L$$

In a plot of  $dC_L/dt$  against  $C_L$ , the negative slope of the resulting straight line is  $K_L a$ . The  $dC_L/dt$  values are calculated and plotted in Table I and Figs. I and II.

TABLE I		
$t, \text{min}$	$C_L, \text{mg/l}$	$dC_L/dt$
0	0.51	0.43
1	0.91	0.37
2	1.25	0.32
3	1.55	0.27
4	1.80	0.22
5	1.99	0.17

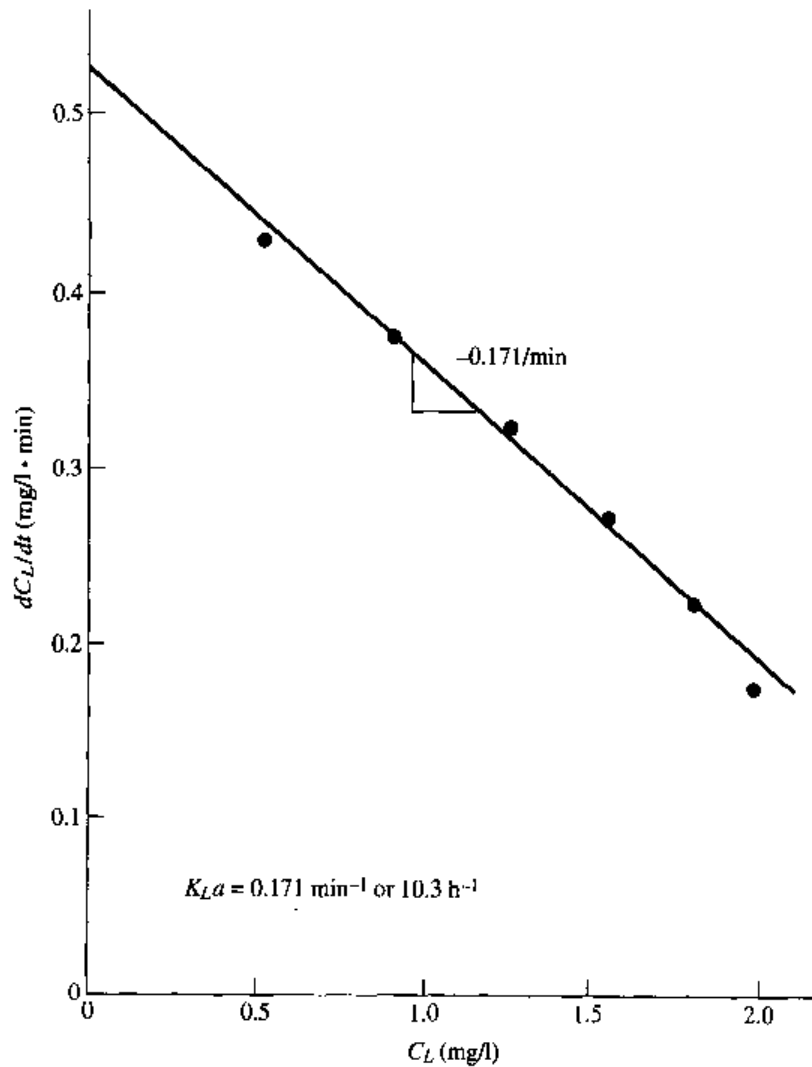


FIGURE II For Example 5.3.

## Other Measuring Techniques

The off-gas analysis utilizes a hood over a portion of the aeration tank to collect the off-gases for  $O_2$  analysis with a non-membrane-type probe. This technique is applicable for diffused aeration systems with transfer efficiencies above 5 percent.<sup>20</sup>

A radioactive tracer technique has been developed by Neal and Tsivoglou.<sup>21</sup> Their technique uses the stripping of krypton from the aeration tank to measure  $K_La$  under the exact aeration tank mixing and waste conditions. The oxygen transfer coefficient is then calculated from the known ratio of  $(K_La)_{O_2}/(K_La)_{\text{krypton}}$ .

### 5.3

## AIR STRIPPING OF VOLATILE ORGANIC COMPOUNDS

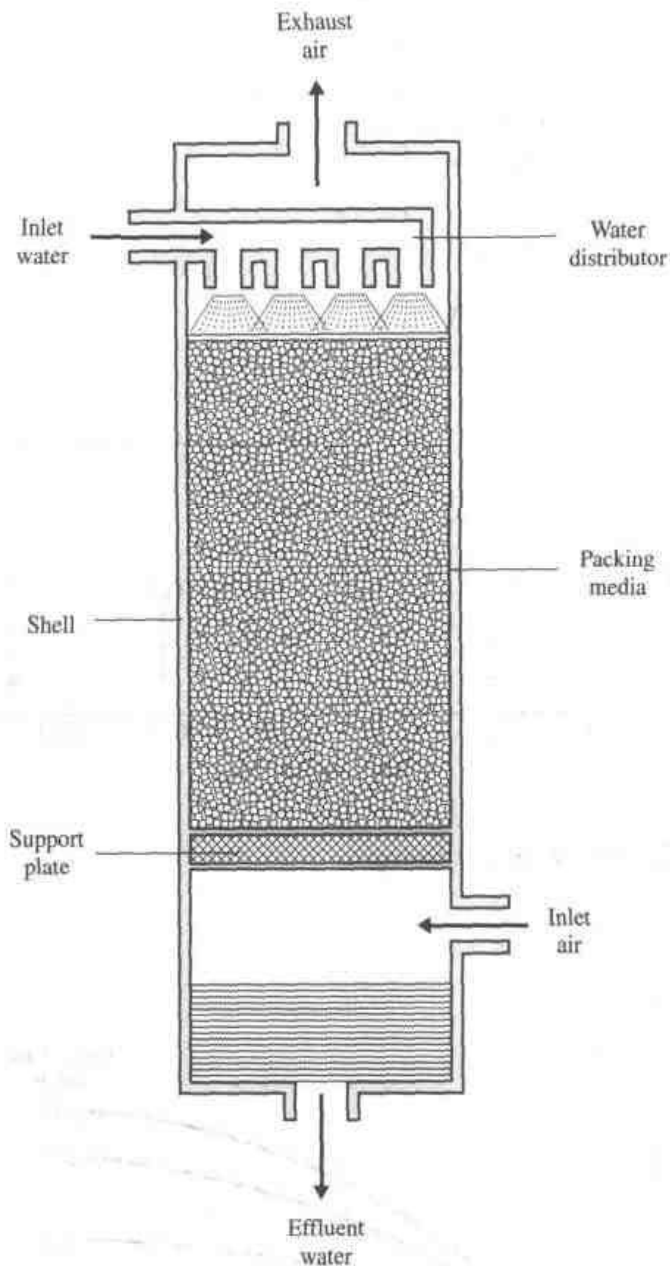
The physical process of transferring volatile organic compounds (VOCs) from water into air is called *desorption* or *air stripping*. This can be accomplished by injection of water into air via spray systems, spray towers, or packed towers, or by injection of air into water through diffused or mechanical aeration systems. The most common systems in use today are packed towers or aeration systems. Aeration systems are usually used in conjunction with biological wastewater-treatment processes. Stripping efficiencies for various techniques are shown in Fig. 5.20. A typical packed tower is shown in Fig. 5.21.

Packed tower media are open-structured, chemically inert materials, usually plastic, which are selected to give high surface areas for good contacting while offering a low pressure drop through the tower. Some of the factors that affect removal of VOCs are the contact area, the solubility of the contaminant, the diffusivity of the contaminant in the air and water, and the temperature. All of these factors except diffusivity and temperature are influenced by the airflow and water-flow rates and the type of packing media. General relationships are shown in Fig. 5.22. The efficiency of transfer of contaminant from water to air depends on the mass-transfer coefficient and Henry's law constant [see Eq. (5.7)]. The mass-transfer coefficient defines the transfer of contaminant from water to air per unit volume of packing per unit time. The ability of a contaminant to be air stripped can be estimated from its Henry's law constant. A high Henry's constant indicates that the contaminant has low solubility in water and can therefore be removed by air stripping. In general, Henry's constant increases with increasing temperature and decreases with increasing solubility.

### Packed Towers

Packed-tower air strippers can be designed for a wide variety of flow ranges, temperatures, and organics. One of the first steps in applying air stripping is to estimate the maximum possible removal for a given contaminant, based on its Henry's law constant, temperature, and volumetric air/water ratio. By assuming equilibrium between a volume of gas and a volume of water, the following equation can be used:

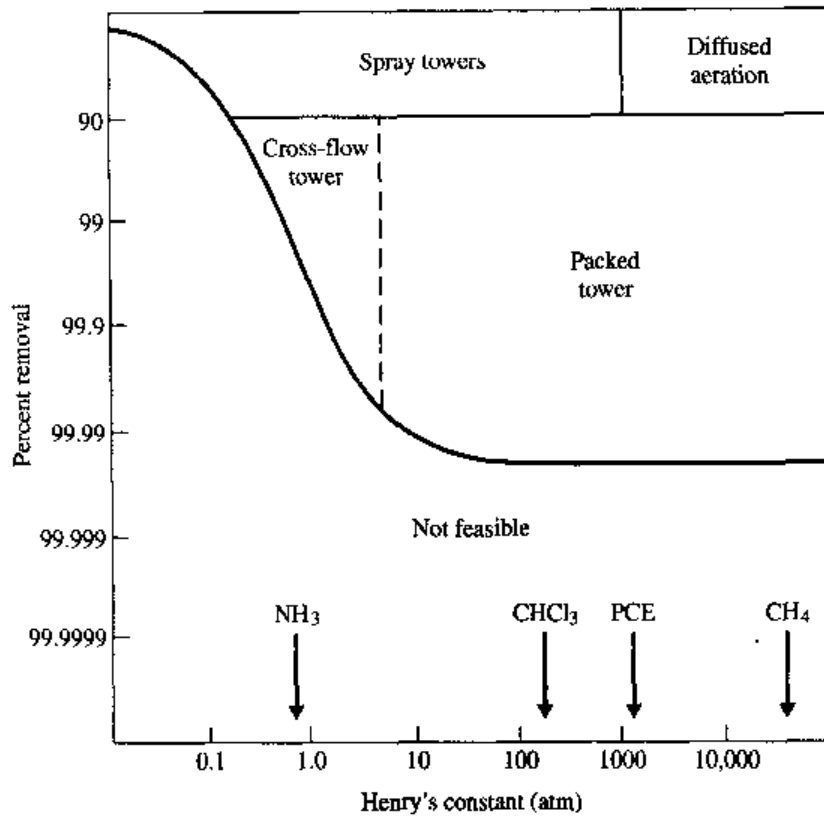
$$\frac{C_2}{C_1} = \left( 1 + \frac{H_M A_w}{RT} \right)^{-1} \quad (5.23)$$



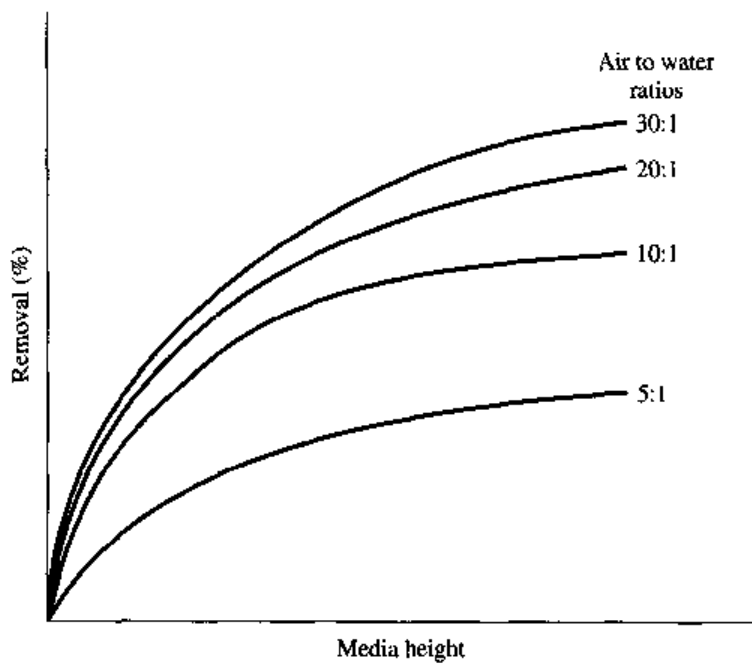
**FIGURE 5.20**  
Typical packed tower.

where  $C_2$  = final concentration of organic,  $\mu\text{g/L}$   
 $C_1$  = initial concentration of organic,  $\mu\text{g/L}$   
 $H_M$  = Henry's law constant,  $\text{atm} \cdot \text{m}^3/\text{mol}$   
 $A_w$  = volumetric air/water ratio  
 $R$  = universal gas constant,  $8.206 \times 10^{-5} \text{ atm} \cdot \text{m}^3/(\text{mol} \cdot \text{K})$   
 $T$  = temperature, K

While Henry's constant is not accurately defined for many organics, Table 5.7 lists estimated values for some organics that are found in wastewaters. In the scientific literature Henry's constant is often expressed as  $H_M$  ( $\text{atm} \cdot \text{m}^3/\text{mol}$ ). Another form



**FIGURE 5.21**  
Stripping efficiency of various technologies.



**FIGURE 5.22**  
Illustrative relationships of air stripping removal efficiencies to media height and air to water ratios.

TABLE 5.7  
Henry's constants for selected compounds at 20°C

Compound	Formula	Henry's constant	
		$H_M$ , atm · m <sup>3</sup> /mol	$H_C$ , (μg/L)/(μg/L)
<b>Easy to strip</b>			
Vinyl chloride	CH <sub>2</sub> CHCl	6.38	265
Trichloroethylene	CCHCl <sub>3</sub>	0.010	0.43
1,1,1 Trichloroethane	CCH <sub>3</sub> Cl <sub>3</sub>	0.007	0.29
Toluene	C <sub>6</sub> H <sub>5</sub> CH <sub>3</sub>	0.006	0.25
Benzene	C <sub>6</sub> H <sub>6</sub>	0.004	0.17
Chloroform	CHCl <sub>3</sub>	0.003	0.12
<b>Difficult to strip</b>			
1,1,2-Trichloroethane	CCH <sub>2</sub> Cl <sub>3</sub>	7.7 × 10 <sup>-4</sup>	0.032
Bromoform	CHBr <sub>3</sub>	6.3 × 10 <sup>-4</sup>	0.026
<b>Nonstrippable</b>			
Pentachlorophenol	C <sub>6</sub> (OH)Cl <sub>5</sub>	2.1 × 10 <sup>-6</sup>	0.000087
Dieldrin	—	1.7 × 10 <sup>-8</sup>	0.0000007

of Henry's constant is calculated as  $H_c = H_M/RT$  (expressed as m<sup>3</sup> water/m<sup>3</sup> air). At 20°C,  $H_c = 41.6H_M$ , with the constant varying from 44.6 to 40.2 for a temperature range between 0 and 30°C.

The effect of temperature on the Henry's law constant is not well defined. Ashworth et al.<sup>23</sup> developed the following empirical relationship:

$$H_M = \exp\left(A - \frac{B}{T}\right) \quad (5.24)$$

where  $A$  = empirical constant = 5.534 for benzene, 7.845 for trichloroethylene, 8.483 for methylene chloride

$B$  = empirical constant = 3194 for benzene, 3702 for trichloroethylene, 4268 for methylene chloride

$T$  = temperature, K

In general, the ability of a contaminant to be air stripped increases with increasing temperature and decreases with increasing solubility. Compounds with  $H_M > 10^3$  atm · m<sup>3</sup>/mol are easy to strip, compounds with  $H_M$  between 10<sup>-4</sup> and 10<sup>3</sup> atm · m<sup>3</sup>/mol are difficult to strip, and compounds with  $H_M$  less than 10<sup>4</sup> atm · m<sup>3</sup>/mol are nonstrippable.

The effect of feed temperature on the removal of soluble compounds is shown in Table 5.8.

The height of the stripping tower can be computed from the relationship

$$H = \frac{L_v}{K_L a} \left[ \frac{S}{S-1} \ln \frac{\left(\frac{C_1}{C_2}(S-1) + 1\right)}{S} \right] \quad (5.25)$$



TABLE 5.8  
Influence of feed temperature on  
removal of water-soluble compounds from groundwater

Compound	Percent removal at		
	12°C	35°C	73°C
2-Propanol	10	23	70
Acetone	35	80	95
Tetrahydrofuran	50	92	>99

where  $L_v$  = volumetric liquid loading rate, ft/s  
 $H$  = packing height, ft  
 $K_L a$  = mass-transfer coefficient  
 $S$  = stripping factor =  $H_c A_w$

In order to calculate the amount of packing needed to obtain the removal found from Eq. (5.25), the mass transfer coefficient  $K_L a$  must be known for the VOC of interest, the type of packing media used, and the design conditions.  $K_L a$  can be determined through pilot testing or calculated as follows:

$$\frac{1}{K_L a} = \left( \frac{1}{k_L a} \right) + \left( \frac{1}{H_c k_g a} \right) \quad (5.26)$$

Onda et al.<sup>24</sup> developed relationships to define  $k_L$  and  $k_g$  as summarized below.

$$k_L \left( \frac{\rho_L}{\mu_L g} \right)^{1/3} = 0.0051 \left( \frac{L}{a_w \mu_L} \right)^{2/3} \left( \frac{\mu_L}{\rho_L D_L} \right)^{-0.5} (a_t d_p)^{0.4} \quad (5.27)$$

$$\frac{k_G}{a_t D_g} = 5.23 \left( \frac{G}{a_t \mu_g} \right)^{0.7} \left( \frac{\mu_g}{\rho_g D_g} \right)^{1/3} (a_t d_p)^{-2} \quad (5.28)$$

$$\frac{a_w}{a_t} = 1 - \exp \left[ -1.45 \left( \frac{\sigma_c}{\sigma_L} \right)^{0.75} (\text{Re}_L)^{0.1} (\text{Fr}_L)^{-0.05} (\text{We}_L)^{-0.2} \right] \quad (5.29)$$

where  $k_L$  = liquid-phase mass-transfer coefficient  
 $\mu_L$  = viscosity of liquid, Pa · s  
 $\rho_L$  = density of liquid, kg/m<sup>3</sup>  
 $g$  = gravitational acceleration, 9.81 m/s<sup>2</sup>  
 $L$  = liquid loading rate, kg/(m<sup>2</sup> · s)  
 $a_w$  = wetted specific surface area, m<sup>2</sup>/m<sup>3</sup>  
 $D_L$  = liquid-phase diffusivity, m<sup>2</sup>/s  
 $a_t$  = total specific surface area, m<sup>2</sup>/m<sup>3</sup>  
 $d_p$  = nominal packing size, m  
 $k_g$  = gas-phase mass-transfer coefficient  
 $D_g$  = gas-phase diffusivity, m<sup>2</sup>/s  
 $G$  = gas loading rate, kg/(m<sup>2</sup> · s)  
 $\mu_g$  = viscosity of gas, Pa · s

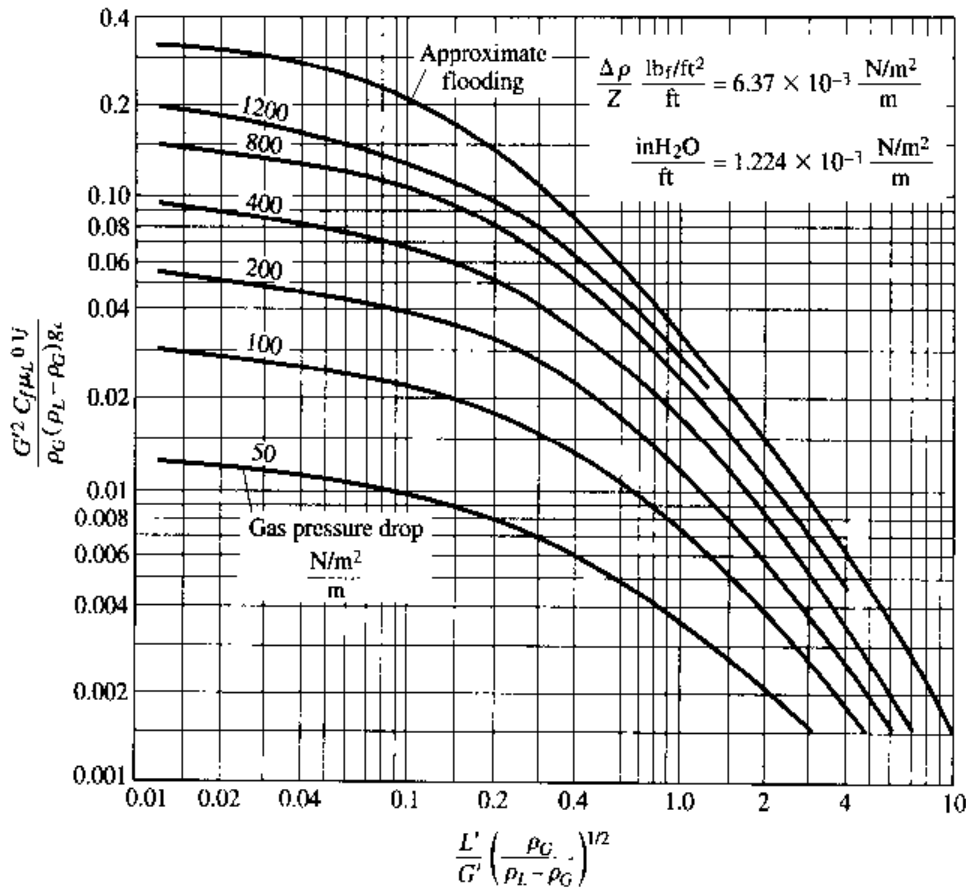
- $\rho_g$  = density of gas, kg/m<sup>3</sup>
- $\sigma_c$  = surface tension of packing material, N/m
- $\sigma_L$  = surface tension of liquid, N/m
- $Re_L$  = liquid-phase Reynold's number =  $L/a_t\mu_L$
- $Fr_L$  = liquid-phase Froude number =  $L^2a_t/(\rho_L)^2g$
- $We_L$  = liquid-phase Weber number =  $L^2/\rho_L\sigma_La_t$

The  $K_La$  can be adjusted for different temperatures as follows:

$$K_La_{T_2} = K_La_{T_1} \times 1.024^{T_2 - T_1}$$

Once the packing volume has been calculated, the tower diameter can be found from the desired pressure drop calculated in Fig. 5.23, which is a generalized correlation for predicting pressure drop in packed towers.<sup>25</sup> The following Eqs. (5.30) and (5.31) are the x- and y-axis values of Fig. 5.23, respectively. The packing factor is unique to the type of packing and can usually be obtained from the manufacturer.

$$\frac{L}{G} \left( \frac{\rho_g}{\rho_L} \right)^{0.5} \tag{5.30}$$



**FIGURE 5.23**  
Generalized flooding and pressure drop curves for packed towers.

where  $L$  = liquid loading rate, lb/(ft<sup>2</sup> · s)  
 $G$  = gas loading rate, lb/(ft<sup>2</sup> · s)  
 $\rho_g$  = density of gas, lb/ft<sup>3</sup>  
 $\rho_L$  = density of liquid, lb/ft<sup>3</sup>

$$\frac{G^2 F \mu_L^{0.1} J}{\rho_g (\rho_L - \rho_g) g_c} \quad (5.31)$$

where  $F$  = packing factor [97 for 16-mm ( $\frac{5}{8}$ -in) plastic Pall rings]  
 $\mu$  = liquid viscosity, cP [kg/m · s]  
 $g_c$  =  $4.18 \times 10^8$  for English units (1 for SI units)  
 $J$  = 1.502 for English units (1 for SI units)

To estimate the tower size, an allowable pressure drop value is selected. Usually a pressure drop in the range of 0.25 to 0.50 in of water per foot of packed bed gives an average-size tower and a flexible operating range. Once the pressure drop is chosen, the  $x$ -axis value for Fig. 5.23 is calculated from Eq. (5.30). A vertical line is drawn from the  $x$ -axis to the intersection of the pressure drop curve corresponding to the selected value. At this intersection, the  $y$ -axis value is read. Equation (5.31) is rearranged and solved for  $G$ :

$$G = \left( \frac{(y\text{-axis value}) \rho_g (\rho_L - \rho_g) g_c}{F \mu_L^{0.1} J} \right)^{0.5} \quad (5.32)$$

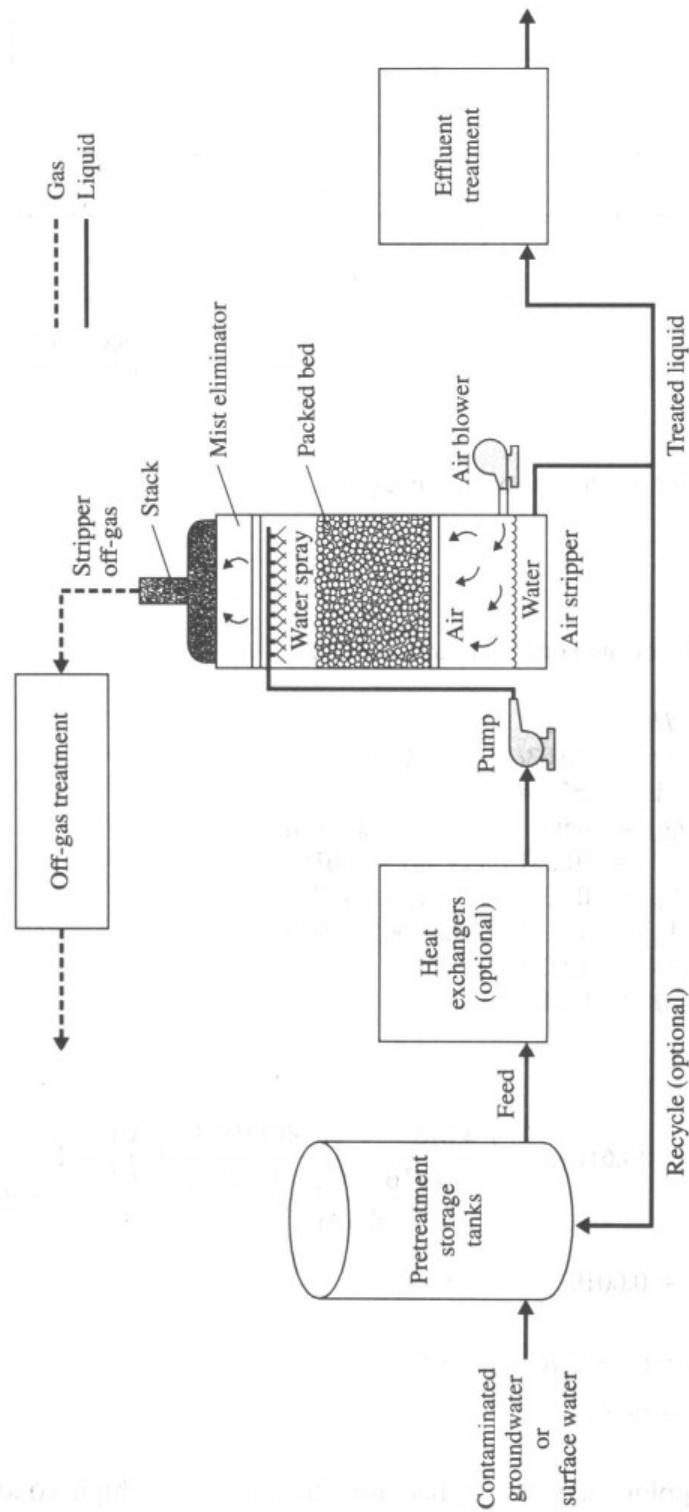
The tower cross-sectional area is found by dividing the air mass flow rate by  $G$ , and the diameter is calculated from the area. The total packed-bed depth is calculated by dividing the volume of packing by the cross-sectional area. The total pressure drop is the pressure drop per foot of packing times the packed bed depth.

A schematic diagram of an air stripping system is shown in Fig. 5.24. The off gas containing the volatile organics must usually be treated. Applicable technologies are shown in Fig. 5.25.

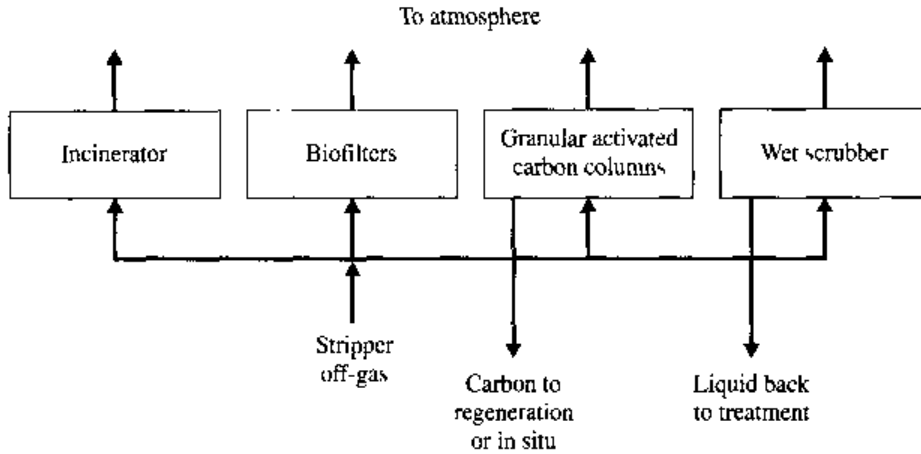
**EXAMPLE 5.4.** Air stripper removal efficiency can be calculated from the equation

$$\frac{C_1}{C_2} = \frac{(S) \exp \left[ \left( \frac{S-1}{S} \right) \left( \frac{HK_L a}{L_v} \right) \right] - 1}{S - 1}$$

where  $C_1$  = influent concentration  
 $C_2$  = effluent concentration  
 $H$  = packing height  
 $L_v$  = volumetric liquid loading rate =  $Q_L/A$   
 $A$  = tower cross-sectional area =  $\pi r^2$   
 $Q_L$  = water-flow rate  
 $S$  = stripping factor =  $H_c A_w$   
 $H_c$  = Henry's constant  
 $A_w$  = volumetric air to water ratio =  $Q_G/Q_L$   
 $Q_G$  = airflow rate  
 $K_L a$  = mass-transfer coefficient



**FIGURE 5.24**  
Schematic diagram of air stripping system.



**FIGURE 5.25**  
Process options for air stripper off-gas treatment.

If the following conditions are assumed:

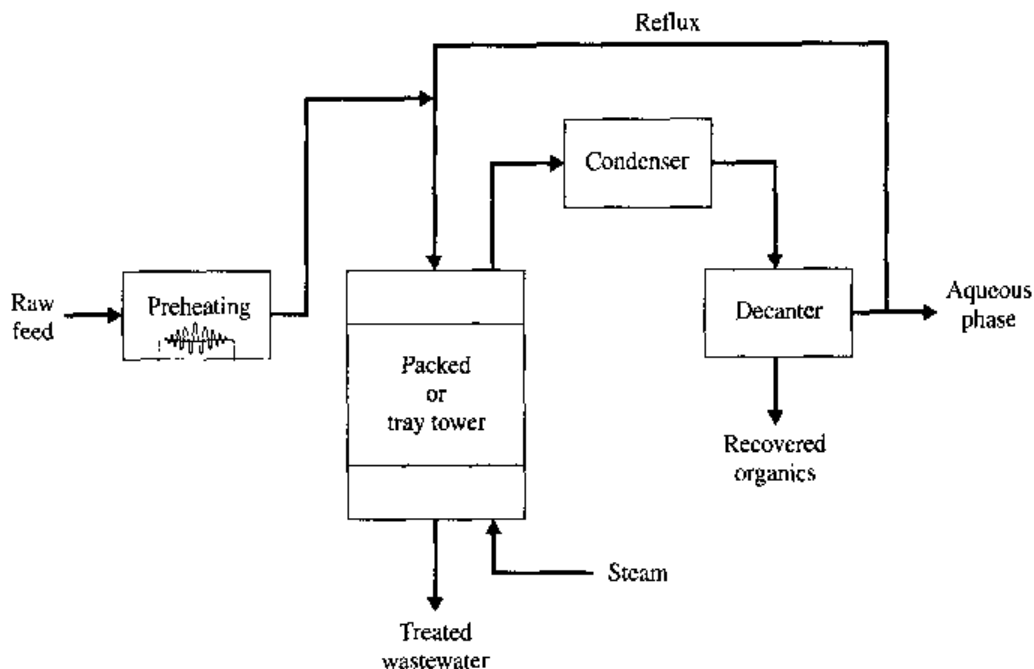
$$\begin{aligned}
 H &= 40 \text{ ft} \\
 L_v &= 10.03/153.9 = 0.06517 \text{ ft/s} \\
 A &= \pi 7^2 = 153.9 \text{ ft}^2 \\
 Q_L &= 4500 \text{ gal/min} = 10.03 \text{ ft}^3/\text{s} \\
 S &= (0.2315)(19.94) = 4.616 \\
 H_c &= 0.2315 \text{ for TCE at } 10^\circ\text{C} \\
 A_w &= 12,000/(10.03)(60) = 19.94 \\
 Q_G &= 12,000 \text{ ft}^3/\text{min} \\
 K_L a &= 0.0125 \text{ s}^{-1}
 \end{aligned}$$

then

$$\begin{aligned}
 \frac{C_1}{C_2} &= \frac{(4.616) \exp \left[ \left( \frac{4.616 - 1}{4.616} \right) \left( \frac{(40)(0.0125)}{0.06517} \right) \right] - 1}{4.616} = 520 \\
 &= 0.00192
 \end{aligned}$$

$$\begin{aligned}
 \% \text{ Removal} &= (1 - C_2/C_1) \times 100\% \\
 &= 99.81
 \end{aligned}$$

Steam stripping may be applied for the removal of high concentrations of volatile organics. The principal index used to estimate the steam stripping capability is the boiling point of the organic compound. A compound should exhibit a relatively low boiling point ( $150^\circ\text{C}$ ) and an acceptable Henry's law constant for effective steam stripping. A contaminated condensate is produced that may be recovered or treated further. A steam stripping system is shown in Fig. 5.26 and performance characteristics are given in Table 5.9.



**FIGURE 5.26**  
Typical steam stripping process.

**TABLE 5.9**  
**Full-scale industrial steam stripper performance summary**

Plants using steam stripping	Stripped compound	Henry's constant, atm	Vapor pressure, mmHg @ 25°C	Concentration, ppm		Percent removal
				Influent	Effluent	
<b>Pesticide industry</b>						
Plant 1	Methylene chloride	177	425	<159	<0.01	99.9
Plant 2	Chloroform	188	180	70.0	<5.0	>92.6
Plant 3	Toluene	370	29	721	43.4	94.0
<b>Organic chemicals industry</b>						
Plant 4	Benzene	306	74	<15.4	<0.230	98.5
Plant 5	Methylene chloride	177	425	<3.02	<0.0141	99.5
	Toluene	370	29	178	<52.8	>70.3
Plant 6a	Methylene chloride	177	425	1430	<0.0153	>99.99
	Carbon tetrachloride	1280	113	<665	<0.0549	>99.99
	Chloroform	188	180	<8.81	1.15	<86.9
Plant 6b	Methylene chloride	177	425	4.73	<0.0021	>99.95
	Chloroform	188	180	<18.6	<1.9	89.8
	1,2-Dichloroethane	62	82	<36.2	<4.36	88.0
	Carbon tetrachloride	1280	113	<9.7	<0.030	99.7
Plant 7	Benzene	306	74	24.1	<0.042	>99.8
	Toluene	370	29	22.3	<0.091	>99.6
	Methylene chloride	177	425	34	<0.01	>99.97
	Chloroform	188	180	4509	<0.01	99.99
	1,2-Dichloroethane	62	82	9030	<0.01	>99.99

### PROBLEMS

- 5.1 An air diffuser yielded a  $K_L a$  of 6.5/h at 10°C. The airflow is 50 cm<sup>3</sup>/min, the bubble diameter 0.15 cm, and the bubble velocity 28 cm/s. The depth of the aeration column is 250 cm with a volume of 4000 cm<sup>3</sup>.
- (a) Compute  $K_L$ .
- (b) Compute  $K_L a$  at 25°C.
- 5.2 Design an aeration system using coarse bubble diffusers with a 12 percent OTE at 15-ft liquid depth under standard conditions.
- 1000 lb O<sub>2</sub>/h  
 $T = 30^\circ\text{C}$   
 $C_L = 2 \text{ mg/l}$   
 $\beta = 0.95$   
 $\alpha = 0.85$   
 $D = 20 \text{ ft}$
- 5.3 The following data were collected at 29°C for non-steady state oxygen transfer in an activated sludge basin. Compute  $K_L$  and  $K_L a$  at 20°C.

Time, min	$C_L$ , mg/l
0	0.75
3	1.60
6	2.30
9	2.80
12	3.20
15	3.50
18	3.72

- 5.4 A pilot study was conducted to evaluate the removal of benzene by air stripping. The pilot packed-tower air stripper had a 10-in diameter and 10 ft of packing height. The tower was operated at 50°C with a flow rate of 10 gal/min and an air to water ratio of 50:1. The benzene concentration was reduced from 1400  $\mu\text{g/l}$  to 200  $\mu\text{g/l}$ . What is the required tower size to reduce the benzene concentration from 1600  $\mu\text{g/l}$  to 10  $\mu\text{g/l}$  at 50 gal/min? Assume the same packing type, liquid loading rate, air to water ratio, and temperature as the pilot study.

### REFERENCES

- Lewis, W. K., and W. G. Whitman: *Ind. Eng. Chem.*, vol. 16, p. 1215, 1924.
- Danckwartz, P. V.: *Ind. Eng. Chem.*, vol. 43, p. 6, 1951.
- Dobbins, W. E.: *Advances in Water Pollution Research*, vol. 2, p. 61, Pergamon Press, 1964.
- Mueller, J. A. et al.: *Proc. 37th Ind. Waste Conf.*, May 1982, Purdue University.
- Schmit, F. and D. Redmon: *J. Water Pollution Control Fed.*, November 1975.

6. Imhoff, K., and D. Albrecht: *Proc. 6th International Conf. on Water Pollution Research*, Jerusalem, 1972.
7. Landberg, G. et al.: *Water Research*, vol. 3, p. 445, 1969.
8. Wagner, M. R., and H. J. Popel: *Proc. Wat. Env. Fed.*, Dallas, 1996.
9. Carpani, R. E., and J. M. Roxburgh: *Can. J. Chem. Engrg.*, vol. 36, p. 73, April 1958.
10. Gameson, A. H., and H. B. Robertson: *J. Appl. Chem. Engrg.*, vol. 5, p. 503, 1955.
11. Eckenfelder, W. W.: *J. Sanit. Engrg. Div. ASCE*, vol. 85, pp. 88-99, 1959.
12. Pasveer, A.: *Sewage Ind. Wastes*, vol. 27, pt. 10, p. 1130, 1955.
13. Ippen, H. T., and C. E. Carver: MIT Hydrodynamics Lab. Tech. Rep. 14, 1955.
14. Cappock, P. D., and G. T. Micklejohn: *Trans. Inst. Chem. Engrs. London*, vol. 29, p. 75, 1951.
15. *WPCF Aeration Manual of Practice*, FD-13, 1988.
16. Quirk, T. P.: personal communication.
17. Kormanik, R. et al.: *Proc. 28th Ind. Waste Conf.*, 1973, Purdue University.
18. Arthur, R. M., *Treatment Efficiency and Energy Use III, Activated Sludge Process Control*, Butterworths, Boston 1986.
19. "ASCE Standard Measurement of Oxygen Transfer in Clean Water," ASCE, New York, 1992.
20. Redman, D., and W. C. Boyle: Report to Oxygen Transfer Subcommittee of ASCE, 1981.
21. Neal, L. A., and E. C. Tsivoglou: *J. Water Pollut. Control Fed.*, vol. 46, p. 247, 1974.
22. Muller, J.: Manhattan College Summer Institute, 1996.
23. Ashworth, R. A., G. B. Howe, M. E. Mullins, and T. N. Rogers: "Air-Water Partitioning Coefficients of Organics in Dilute Aqueous Solutions," *Jour. Haz. Mat.*, vol. 18, pp. 25-36, 1988.
24. Onda, K., H. Takeuchi, and Y. Okumoto: "Mass Transfer Coefficients between Gas and Liquid Phases in Packed Columns," *J. Chem. Engrg. Japan*, vol. 1, no. 1, 1968.
25. Eckert, J. S.: *Chem. Eng. Progress*, vol. 66, March 1970.



## PRINCIPLES OF AEROBIC BIOLOGICAL OXIDATION

Organics are removed in a biological-treatment process by one or more mechanisms, namely sorption, stripping, or biodegradation. Table 6.1 identifies several organics and the mechanisms responsible for their removal.

### 6.1 ORGANICS REMOVAL MECHANISMS

#### Sorption

Limited sorption of nondegradable organics on biological solids occurs for a variety of organics, and this phenomenon is not a primary mechanism of organic removal in the majority of cases. An exception is Lindane, as reported by Weber and Jones,<sup>1</sup> who showed that while no biodegradation occurred, there was significant sorption. It is probable that other pesticides will respond in a similar manner in biological wastewater-treatment processes.

This removal mechanism is termed *partitioning* and has been related to the octanol-water partition coefficient of the organic.

$$K_{sw} = kK_{ow}^n \quad (6.1)$$

where  $K_{sw}$  = biosolids accumulation factor, ratio of organic sorbed and in solution, (mg/mg)(mg/l)

$K_{ow}$  = octanol-water partition coefficient, (mg/l)<sub>o</sub>/(mg/l)<sub>w</sub>

$k, n$  = factors that have been reported to vary from  $1.38 \times 10^{-5}$  to  $4.3 \times 10^{-7}$  ( $k$ ) and from 0.58 to 1.0 ( $n$ )<sup>2-5</sup>

In most industrial wastewaters, partitioning provides negligible SCOD removal but may be a method of bioaccumulation of certain lipid-soluble organic compounds.

The removal by adsorption can be determined through the relationship

$$\frac{C_e}{C_i} = \frac{1}{\left[ 1 + \frac{k_{sw} \cdot X_t}{\theta_c} \right]} \quad (6.1a)$$

TABLE 6.1  
Specific removal efficiencies of priority pollutants

Compounds	Percent treatment achieved		
	Stripping	Adsorption	Biodegradation
Nitrogen compounds			
Acrylonitrile			99.9
Phenols			
Phenol			99.9
2,4-DNP			99.3
2,4-DCP			95.2
PCP		0.58	97.3
Aromatics			
1,2-DCB	21.7		78.2
1,3-DCB	—	—	—
Nitrobenzene			97.8
Benzene	2.0		97.9
Toluene	5.1	0.02	94.9
Ethylbenzene	5.2	0.19	94.6
Halogenated hydrocarbons			
Methylene chloride	8.0		91.7
1,2-DCE	99.5	0.50	
1,1,1-TCE	100.0		
1,1,2,2-TCE	93.5		
1,2-DCP	99.9		
TCE	65.1	0.83	33.8
Chloroform	19.0	1.19	78.7
Carbon tetrachloride	33.0	1.38	64.9
Oxygenated compounds			
Acrolein			99.9
Polynuclear aromatics			
Phenanthrene			98.2
Naphthalene			98.6
Phthalates			
Bis (2-ethylhexyl) phthalates			76.9
Other			
Ethyl acetate			98.8

where  $C_e$  = effluent concentration, mg/l  
 $C_i$  = influent concentration, mg/l  
 $X$  = mixed liquor suspended solids, mg/l  
 $t$  = hydraulic detention time, d  
 $\theta_c$  = sludge age, d

Adsorption is not a significant factor when  $\log K_{OW}$  is less than 4.

**EXAMPLE 6.1.** Determine the adsorption of tetrachloroethane and Lindane in the activated sludge process for the following conditions.

Tetrachloroethane  $K_{ow} = 363$   
 Lindane  $K_{ow} = 12,600$   
 In Eq. (6.1),  $k = 3.45 \times 10^{-7}$  l/mg  
 $X = 3500$  mg/l  
 $t = 0.23$  d  
 $\theta_c = 6$  d

**Solution.**

For tetrachlorethane:

$$\frac{C_e}{C_i} = \frac{1}{\left[ 1 + 3.45 \times 10^{-7} \frac{1}{\text{mg}} (363)(3500) \frac{\text{mg}}{1} \times \frac{0.23 \text{ d}}{6 \text{ d}} \right]}$$

$$= 0.984 \quad \text{or} \quad 1.6\% \text{ adsorbed}$$

For Lindane:

$$\frac{C_e}{C_i} = \frac{1}{\left[ 1 + 3.45 \times 10^{-7} (12,600)(3500) \times \frac{0.23}{6} \right]}$$

$$= 0.633 \quad \text{or} \quad 37\% \text{ adsorbed}$$

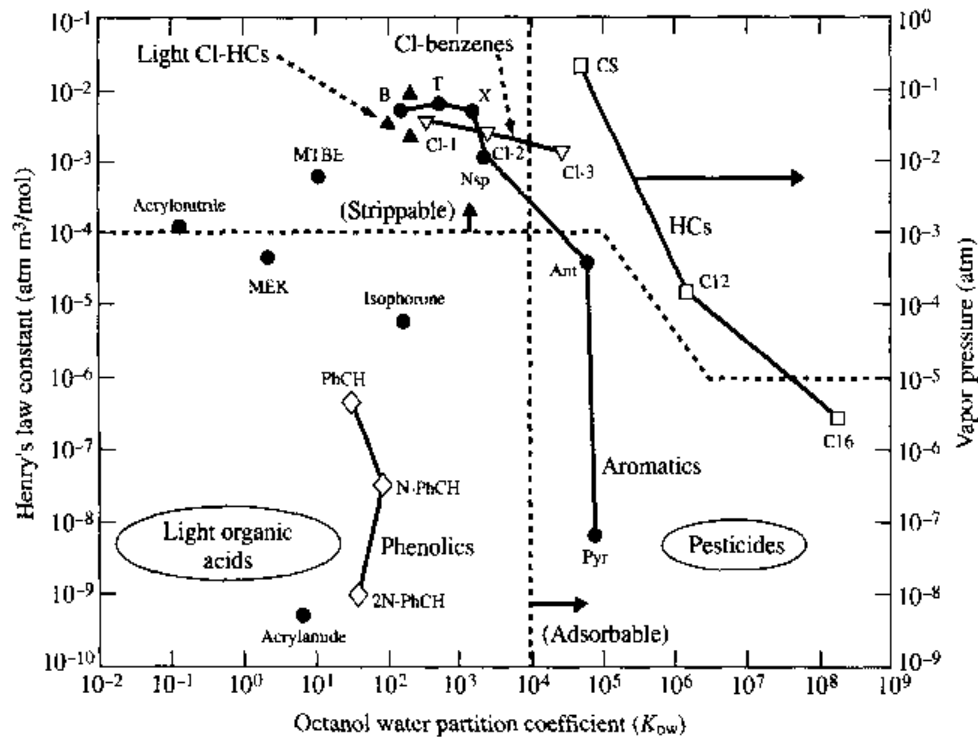
While sorption on biomass does not seem to be a significant removal mechanism for toxic organics, sorption on suspended solids in primary treatment may be significant. The importance of this phenomenon is the fate of the organics during subsequent sludge-handling operations. In some cases, toxicity to anaerobic digestion may result or land-disposal alternatives may be restricted.

While sorption of organics on biomass is usually not significant, this is not true of heavy metals. Metals will complex with the cell wall and bioaccumulate. While low concentrations of metals in the wastewater are generally not inhibitory to the organic removal efficiency, their accumulation on the sludges can markedly affect subsequent sludge treatment and disposal operations.

## Stripping

Volatile organic carbon compounds (VOCs) will air strip in biological-treatment processes, i.e., trickling filters, activated sludge, aerated lagoons. Depending on the VOC in question, both air stripping and biodegradation may occur, as shown on p. 274 and described by Kincannon and Stover.<sup>6</sup> Stripping of VOCs in biological treatment processes is currently receiving considerable attention in the United States, as legislation is severely limiting the permissible atmospheric emissions of VOCs.

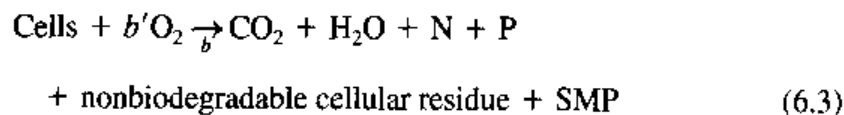
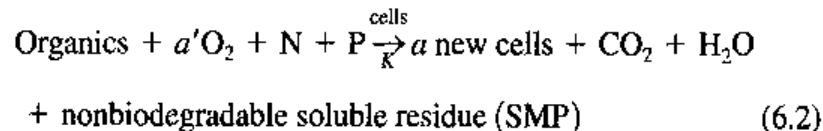
The general relationship between the volatilization, biodegradation, and sorption of certain organic compounds is shown in Fig. 6.1 and is discussed on p. 271.



**FIGURE 6.1**  
Categorization of organic compounds—strippability versus sorbability.<sup>7</sup>

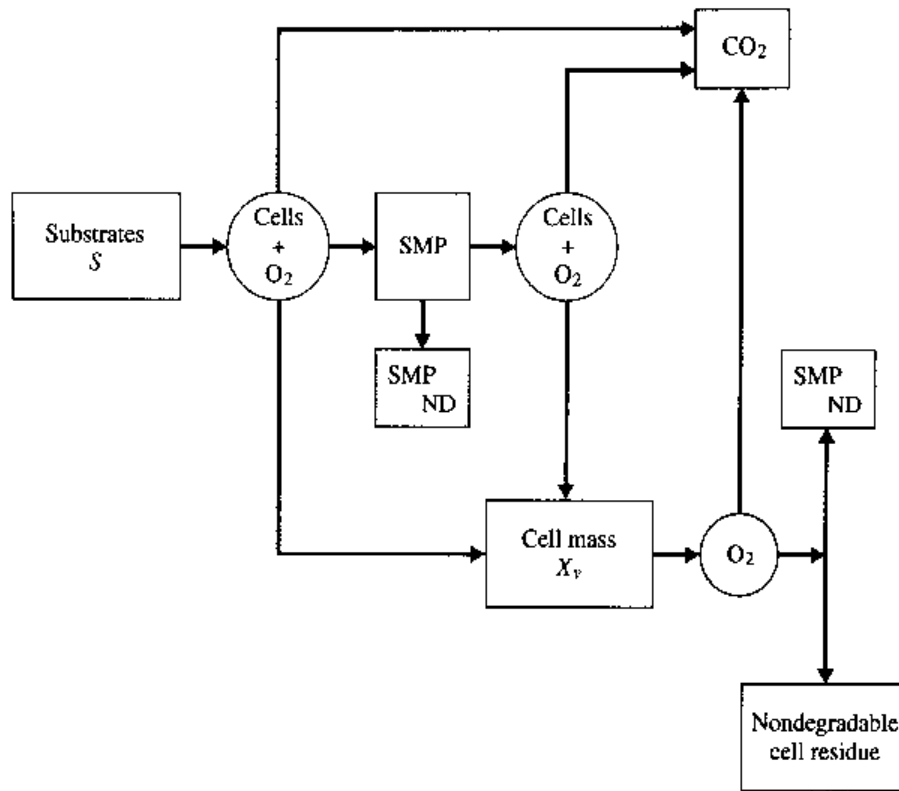
## Biodegradation

When organic matter is removed from solution by aerobic microorganisms, two basic phenomena occur: Oxygen is consumed by the organisms for energy, and new cell mass is synthesized. The organisms also undergo progressive autooxidation in their cellular mass. These reactions can be illustrated by the following generic equations:



These relationships are shown in Fig. 6.2.

Of primary concern to the engineer in the design and operation of industrial waste treatment facilities are the rate at which these reactions occur, the amounts of oxygen and nutrient they require, and the quantity of biological sludge they produce.



**FIGURE 6.2**  
Mechanism of biodegradation.

In Eq. (6.2),  $K$  is a rate coefficient and is a function of the biodegradability of the organic or the mixture of organics in the wastewater. The coefficient  $a'$  is the fraction of the organics removed that is oxidized to end products for energy and the coefficient  $a$  is the fraction of organics removed that is synthesized to cell mass. The coefficient  $b$  is the fraction per day of degradable biomass oxidized, and  $b'$  is the oxygen required for this oxidation.

A small portion of the organics removed in Eq. (6.2) remains as nondegradable by-products which appear in the effluent as TOC or COD but not BOD and are defined as soluble microbial products (SMP). A portion of the cell mass generated in Eq. (6.2) remains as a nondegradable residue.

For the design or operation of a biological treatment facility, a primary objective is to balance Eqs. (6.2) and (6.3) for the wastewater in question.

Disregarding the SMP, all of the organics removed are either oxidized to end products of  $\text{CO}_2$  and  $\text{H}_2\text{O}$  or synthesized to biomass.

Therefore,

$$a_{\text{COD}} + a'_{\text{COD}} \sim 1$$

Since the biomass is usually expressed as volatile suspended solids (VSS) and that 1.4 lbs  $\text{O}_2$  is required to oxidize 1 lb of cells as VSS, then:

$$1.4a_{\text{VSS}} + a'_{\text{COD}} \sim 1$$

## 6.2

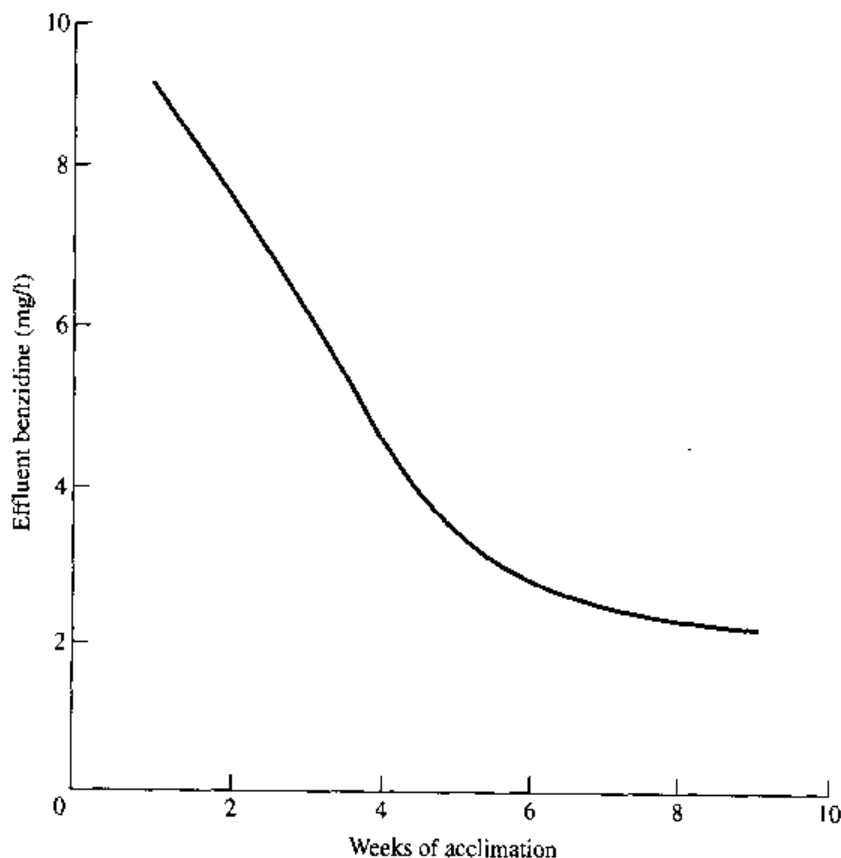
### THE MECHANISMS OF ORGANIC REMOVAL BY BIOOXIDATION

The major organic-removal mechanism for most wastewaters is biooxidation in accordance with Eqs. (6.2) and (6.3).

It should be noted that, in treating industrial wastewaters, the active microbial population must be acclimated to the wastewater in question. For the more complex wastewaters, acclimation may take up to 6 weeks, as shown in Fig. 6.3 for benzidine.<sup>8</sup> When acclimating sludge the feed concentration of the organic in question must be less than the inhibition level, if one exists.

BOD removal from a wastewater by a biological sludge may be considered as occurring in two phases. An initial high removal of suspended, colloidal, and soluble BOD is followed by a slow progressive removal of remaining soluble BOD. Initial BOD removal is accomplished by one or more mechanisms, depending on the physical and chemical characteristics of the organic matter. These mechanisms are:

1. Removal of suspended matter by enmeshment in the biological floc. This removal is rapid and depends upon adequate mixing of the wastewater with the sludge.



**FIGURE 6.3**

Acclimation for the degradation of benzidine.

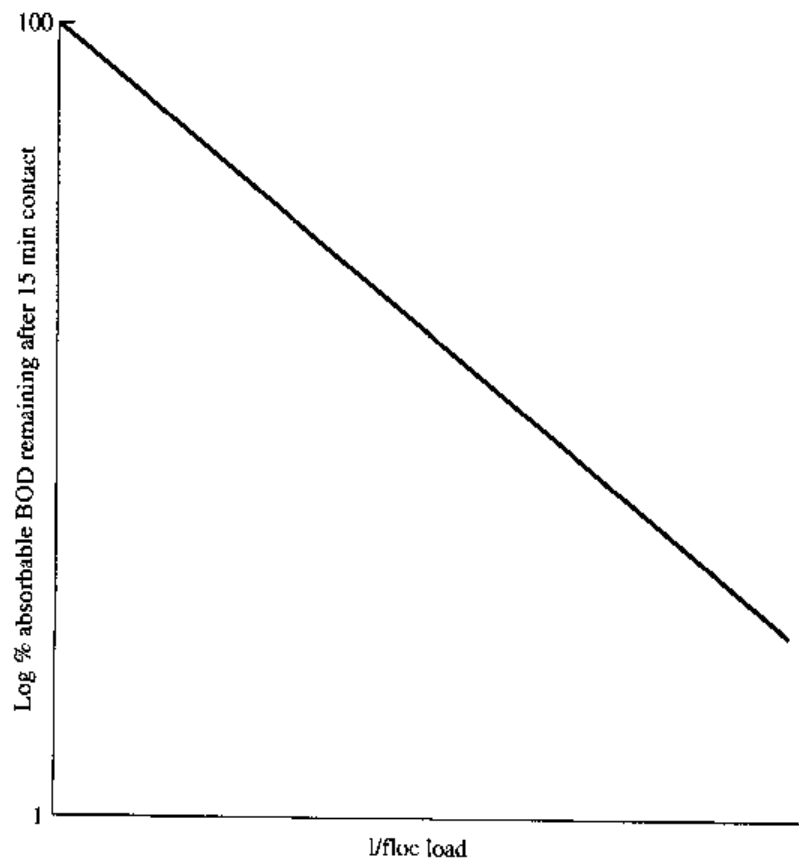
2. Removal of colloidal material by physicochemical adsorption on the biological floc.
3. A biosorption of soluble organic matter by the microorganisms. There is some question as to whether this removal is the result of enzymatic complexing or is a surface phenomenon and whether the organic matter is held to the bacterial surface or is within the cell as a storage product or both. The amount of immediate removal of soluble BOD is directly proportional to the concentration of sludge present, the sludge age, and the chemical characteristics of the soluble organic matter.

The biosorption phenomenon is related to the microbial floc load in a contact time of 10 to 15 min:

$$\text{Floc load} = \frac{\text{mg BOD applied}}{\text{g VSS biological}} \quad (6.4)$$

where VSS = volatile suspended solids. The relationship between floc load and organic removal by biosorption is shown in Fig. 6.4.

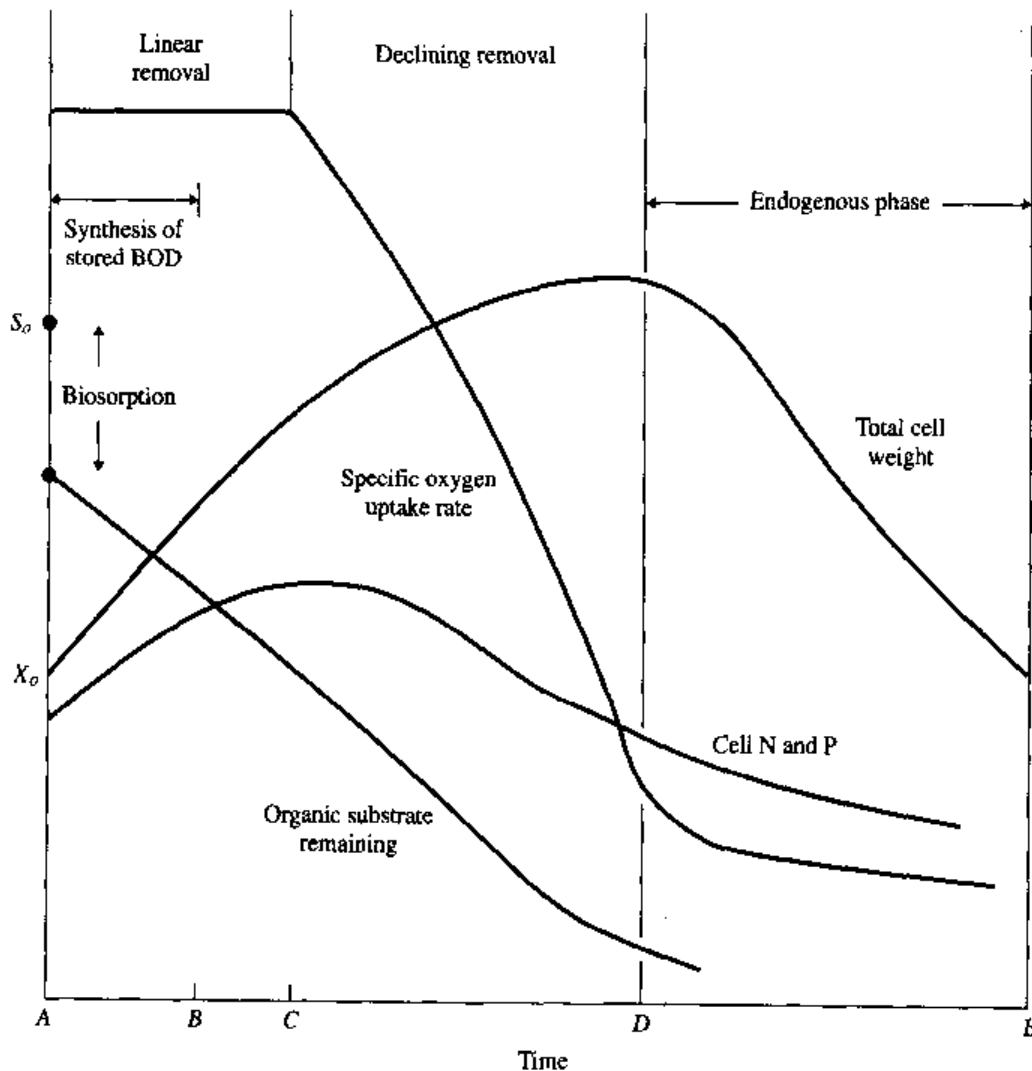
The type of sludge generated markedly affects its sorptive properties. In general, biomass generated from a batch or plug flow configuration will have better sorptive properties than that generated from a complex mix configuration.



**FIGURE 6.4**  
Biosorption relationship for soluble degradable wastewaters.

The three mechanisms begin immediately on contact of biomass with wastewater. The colloidal and suspended material must undergo sequential breakdown to smaller molecules in order that it may be made available to the cell for oxidation and synthesis. The time required for this breakdown in an acclimated system is related primarily to the characteristics of the organic matter and to the concentration of active sludge. In a complex waste mixture at high concentrations of BOD, the rate of synthesis is independent of concentration as long as all components remain and, as a result, there is a constant and maximum rate of cellular growth. With continuing aeration, the more readily removable components are depleted and the rate of growth will decrease with decreasing concentration of BOD remaining in solution. This is shown in Fig. 6.12 on p. 219.

This causes a decrease in cellular mass and cellular carbon accompanied by a corresponding decrease in cellular nitrogen, as shown in Fig. 6.5. This phenomenon has been demonstrated by Gaudy,<sup>9</sup> by Englebrecht and McKinney,<sup>10</sup> and by



**FIGURE 6.5**  
Reactions occurring during biooxidation.



McWhorter and Heukelekian.<sup>11</sup> Gaudy, in the treatment of pulp mill wastes, showed a peak in cellular carbohydrate after a 3-h aeration with a corresponding cellular protein peak after a 6-h aeration. The decrease in cellular mass after substantial exhaustion of substrate, shown by Engelbrecht and McKinney,<sup>10</sup> can be attributed to conversion of stored carbohydrate to cellular protoplasm.

In Fig. 6.5 declining removal occurs following biosorption. Stored carbohydrate is used by the cell over the time interval *AC*; this results in an increase in cellular nitrogen. The cellular nitrogen is at its peak at point *C*, when the stored carbohydrate is depleted. The cellular mass is shown to increase over the time interval *CD* (declining growth and removal). Depending on the concentration of BOD remaining at point *C* and the rate of removal, the sludge mass may tend to remain constant or even increase while the cellular nitrogen would remain substantially constant. Beyond point *D*, cell death and decay, the endogenous or autooxidation phase results in a decrease in both cell weight and cell nitrogen.

The oxygen uptake rate per unit of cell mass  $k_r$  will remain constant at a maximum rate during the log-growth phase, since substrate is not limiting the rate of synthesis.

The oxygen utilization will continue at a maximum rate until depletion of the sorbed BOD; after this it will decrease as the rate of BOD removal decreases. In wastes containing suspended and colloidal matter, the oxygen-uptake rate will also reflect the rate of solubilization and subsequent synthesis of colloidal and suspended BOD.

### Sludge Yield and Oxygen Utilization

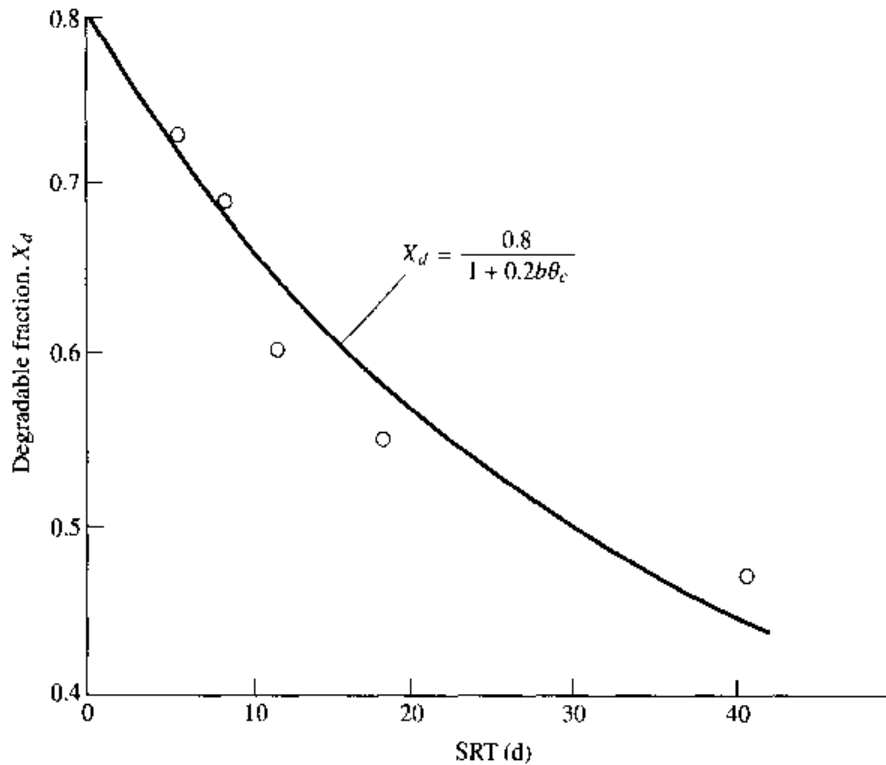
As shown in Eq. (6.3), endogenous respiration results in a degradation of cell mass. A portion of the volatile cell mass, however, is nondegradable, i.e., does not degrade in the time frame of the biological process. Quirk and Eckenfelder<sup>12</sup> have shown that a portion of the volatile biomass is nondegradable. As aeration proceeds the degradable portion of the biomass is oxidized, resulting in a decrease in the degradable fraction. Through kinetic and mass balances, the degradable fraction can be related to the endogenous rate coefficient and the sludge age:

$$X_d = \frac{X'_d}{1 + bX'_n\theta_c} \quad (6.5)$$

- where  $X_d$  = degradable fraction of the biological VSS  
 $X'_d$  = degradable fraction of the biological VSS at generation, that is, Eq. (6.2) average of 0.8  
 $X'_n$  = nondegradable fraction of the biological VSS at generation, that is, Eq. (6.2) average of  $0.2(X'_d + X'_n) = 1.0$   
 $b$  = endogenous rate coefficient,  $d^{-1}$   
 $\theta_c$  = sludge age,  $d$

This relationship is shown for a food processing wastewater in Fig. 6.6.

The degradable fraction is related to the viable or active mass. The degradable mass can be related to oxygen-uptake rates, ATP, dehydrogenase enzyme content,

**FIGURE 6.6**

Relationship between degradable fraction and solids retention time (SRT) for a food processing wastewater.

or plate count measurement, as shown in Fig. 6.7. It is significant to note that, while volatile suspended solids are traditionally used as a measure of biomass, only the active mass is responsive in the process. In plant operation, some measure of active mass is necessary for process control in order to detect toxic shocks, shock loads, etc. Oxygen-uptake rate is most commonly used for this purpose.

Sludge age is defined as the average length of time the microorganisms are under aeration. In a flow-through system, i.e., no biomass recycle, sludge age is the reciprocal of the dilution rate  $Q/V$ . In order for growth to occur and to effect BOD removal, the growth rate becomes

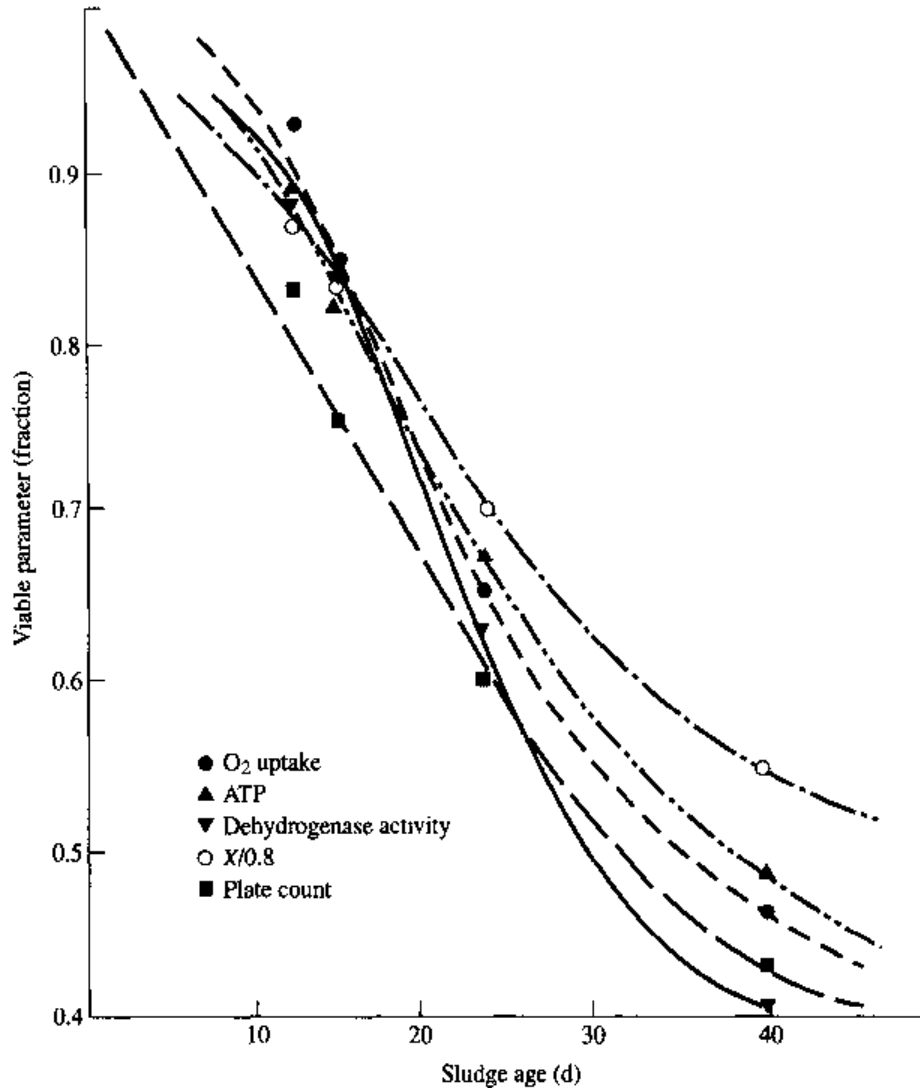
$$\theta_c = \frac{V}{Q} \quad (6.6)$$

where  $\theta_c$  is the sludge age.

In a recycle system such as an activated sludge plant, the sludge age is defined:

$$\theta_c = \frac{X_v t}{\Delta X_v} \quad (6.7)$$

where  $X_v$  = volatile suspended solids concentration, mg/l  
 $t$  =  $V/Q$ , the hydraulic detention time, d  
 $\Delta X_v$  = the volatile suspended solids wasted per day in milligrams per liter, based on influent flow



**FIGURE 6.7**  
Viable fraction of activated sludge as related to sludge age.

Process performance can also be related to the organic loading of the process as defined by the food/microorganism ratio  $F/M$ :

$$\frac{F}{M} = \frac{S_o}{f_b X_v t} \quad (6.8)$$

in which  $X_v$  = the volatile suspended solids under aeration and  $f_b$  = the fraction which is biological.

The  $F/M$  is related to the sludge age  $\theta_c$  by the relationship

$$\frac{1}{\theta_c} = a \frac{F}{M} - b X_d \quad (6.9)$$

when the effluent BOD is negligible, where  $a$  = the yield coefficient or the fraction of organic removed synthesized to biomass.

Several investigations have shown that a constant mass of biological cells is synthesized from a given weight of organic matter removed (expressed as total oxygen demand, COD). McKinney<sup>10</sup> has indicated that one-third of the ultimate oxygen demand (COD) of a substrate is used for energy and that two-thirds results in synthesis. Using a factor of 0.7 g VSS/g O<sub>2</sub> for conversion of oxygen to cellular volatile solids, 0.47 g VSS (volatile suspended solids) will be synthesized for each gram of COD removed. Variations in this value have been attributed to endogenous respiration effects. Sawyer<sup>13</sup> and Gellman and Heukelekian<sup>14</sup> have shown that for sewage and several industrial wastes, 0.5 g VSS is synthesized per gram of BOD<sub>5</sub> removed. Busch and Myrick<sup>15</sup> showed total synthesis from glucose to be 0.44 g cells/g COD. Using NO<sub>3</sub><sup>-</sup> as a nitrogen source, McWhorter and Heukelekian<sup>11</sup> found an average synthesis of 0.315 g VSS/g COD from glucose. As shown by Pipes,<sup>16</sup> the reduction of nitrate to amino nitrogen requires energy such that some of the COD is consumed for this reduction, resulting in a lower yield than when ammonia is used as a nitrogen source.

When the nutrient nitrogen level is lowered below the optimum value, cell yield tends to increase as more substrate is shunted to the buildup of insoluble cell polymers.

Sludge generation from the biological oxidation of soluble substrates ( $f_b = 1.0$ ) has been summarized by Eckenfelder<sup>17</sup>:

$$\Delta X_v = aS_r - bX_d X_v t \quad (6.10)$$

where  $S_r$  represents the soluble substrate removed.

In a system with sludge recycle and wastage of excess sludge, sludge age can be computed from Eq. (6.10) and is defined as

$$\theta_c = \frac{X_v t}{aS_r - bX_d X_v t} \quad (6.11)$$

In Eq. (6.11), when both  $\theta_c$  and  $X_d$  are unknown,  $\theta_c$  can be computed by combining Eqs. (6.5) and (6.11) for soluble substrates to yield

$$\theta_c = \frac{-(aS_r - bX_v t) + \sqrt{(aS_r - bX_v t)^2 + 4(abX'_n S_r)(X_v t)}}{2abX'_n S_r} \quad (6.12)$$

If the influent contains bioresistant VSS, such as in a pulp and paper mill wastewater, Eq. (6.10) is modified to include this contribution.

$$\Delta X_v = a[S_r + f_d f_x X_i] - bX_d f_b X_v t + (1 - f_d) f_x X_i + (1 - f_x) X_i \quad (6.13)$$

where  $X_i$  = influent VSS, mg/l

$f_x$  = fraction of influent VSS that is degradable

$f_d$  = fraction of degradable influent VSS degraded

$f_b$  = fraction of mixed liquor VSS that is biomass

The degradation rate of the influent degradable VSS is a function of the solids retention time (SRT) and the specific degradation rate of the solids:

$$(1 - f_d) = e^{-k_r \theta_c} \quad (6.14)$$

where  $k_p$  = degradation rate coefficient of influent VSS,  $d^{-1}$ .

If it is assumed that 1 mg/l VSS solubilizes to generate 1 mg/l COD, then the fraction of biomass ( $f_b$ ) in the overall mixed liquor can be determined as follows:

$$f_b = 1 - [(1 - f_v) + (1 - f_d)f_x] \frac{X_i}{X_v} \cdot \frac{\theta_c}{t} \quad (6.15)$$

Most pulp and fiber in pulp and paper mill wastewater are essentially non-degradable, and hence  $(1 - f_d)$  is approximately unity. In food processing wastewaters, however,  $(1 - f_d)$  may be less than 0.2. If the influent contains high levels of degradable VSS, the value  $(1 - f_d)$  must be experimentally determined in order to accurately predict the volatile sludge production rate and true biomass yield.

The impact of influent nonvolatile suspended solids on mixed liquor characteristics and sludge production rate can also be significant. The quantity of inert material generated is related to the SRT, the hydraulic retention time, the fraction of influent suspended solids that is nondegradable/nonsolubilized, and the formation of nonbiomass particulates in the activated sludge process.

Total sludge production can be calculated as

$$\Delta X = \frac{\Delta X_v}{f_v} \quad (6.16)$$

in which  $f_v$  = the volatile fraction of the mixed liquor suspended solids.

The impact of the total suspended solids production on the operating aeration basin MLSS concentration is a direct function of SRT or sludge age. As SRT increases, the aeration basin mixed liquor suspended solids (MLSS) will increase. Consideration must be given in secondary clarifier solids loading rate design to accommodate the inert and volatile suspended solids generation while maintaining the required SRT for substrate removal. The calculations are shown in Example 6.2.

**EXAMPLE 6.2.** Develop a process material balance for the following conditions.

Influent

$$Q = 3 \text{ million gal/d (11,360 m}^3\text{/d)}$$

$$S_o = 700 \text{ mg/l (soluble COD)}$$

$$X_i = 40 \text{ mg/l (nondegradable)}$$

Effluent

$$S_e = 150 \text{ mg/l (soluble COD)}$$

$$\text{VSS}_e = 25 \text{ mg/l}$$

Waste sludge

$$Q_w = 0.056 \text{ million gal/d (212 m}^3\text{/d)}$$

$$\text{VSS}_w = 6000 \text{ mg/l}$$

Aeration basin

$$V = 0.84 \text{ mg (3180 m}^3\text{)}$$

$$\text{MLVSS} = 2500 \text{ mg/l}$$

$$b = 0.18/\text{d}$$

$$t = 0.28 \text{ d}$$

$$r_T = 61 \text{ mg/l} \cdot \text{h}$$

where MLVSS is mixed liquor volatile suspended solids.

**Solution.**

$$\begin{aligned}\theta_c &= \frac{X_v V}{\Delta X_t} = \frac{X_v V}{VSS_r + Q_w VSS_w} \\ &= \frac{2500 \cdot 0.84}{25 \cdot 3 + 0.056 \cdot 6000} \\ &= 5.1 \text{ d}\end{aligned}$$

$$\begin{aligned}X_d &= \frac{0.8}{1 + 0.2b\theta_c} \\ &= \frac{0.8}{1 + 0.2 \cdot 0.18 \cdot 5} \\ &= 0.68\end{aligned}$$

Calculation of nonbiological VSS:

$$\begin{aligned}X_{v, nb} &= \frac{X_i \theta_c}{t} \\ &= \frac{40 \cdot 5}{0.28} = 714 \text{ mg/l} \\ f_b &= \frac{(2500 - 714)}{2500} = 0.71\end{aligned}$$

Calculation of biomass yield coefficient  $a$ :

$$\begin{aligned}f_b \Delta X_v &= aS_r - bX_d f_b X_v \\ 0.71(0.056 \cdot 6000 \cdot 8.34 + 25 \cdot 3 \cdot 8.34) &= a(550 \cdot 3 \cdot 8.34) \\ &\quad - 0.18 \cdot 0.68 \cdot 0.71 \cdot 2500 \cdot 0.84 \cdot 8.34 \\ a &= 0.29\end{aligned}$$

Calculation of oxygen consumption coefficient  $a'$ :

Oxygen uptake rate (OUR) = 61 mg/(l · h)

$$\begin{aligned}O_2/d &= 61 \cdot 0.84 \cdot 8.34 \cdot 24 \\ &= 10,256 \text{ lb } O_2/d \quad (4650 \text{ kg } O_2/d)\end{aligned}$$

$$10,256 = a'(13,761) + 1.4 \cdot 0.18 \cdot 0.68 \cdot 0.71 \cdot 2500 \cdot 0.84 \cdot 8.34$$

$$a' = 0.59 \text{ mg } O_2/\text{mg } \Delta\text{COD}$$

Check of  $a$  and  $a'$ :

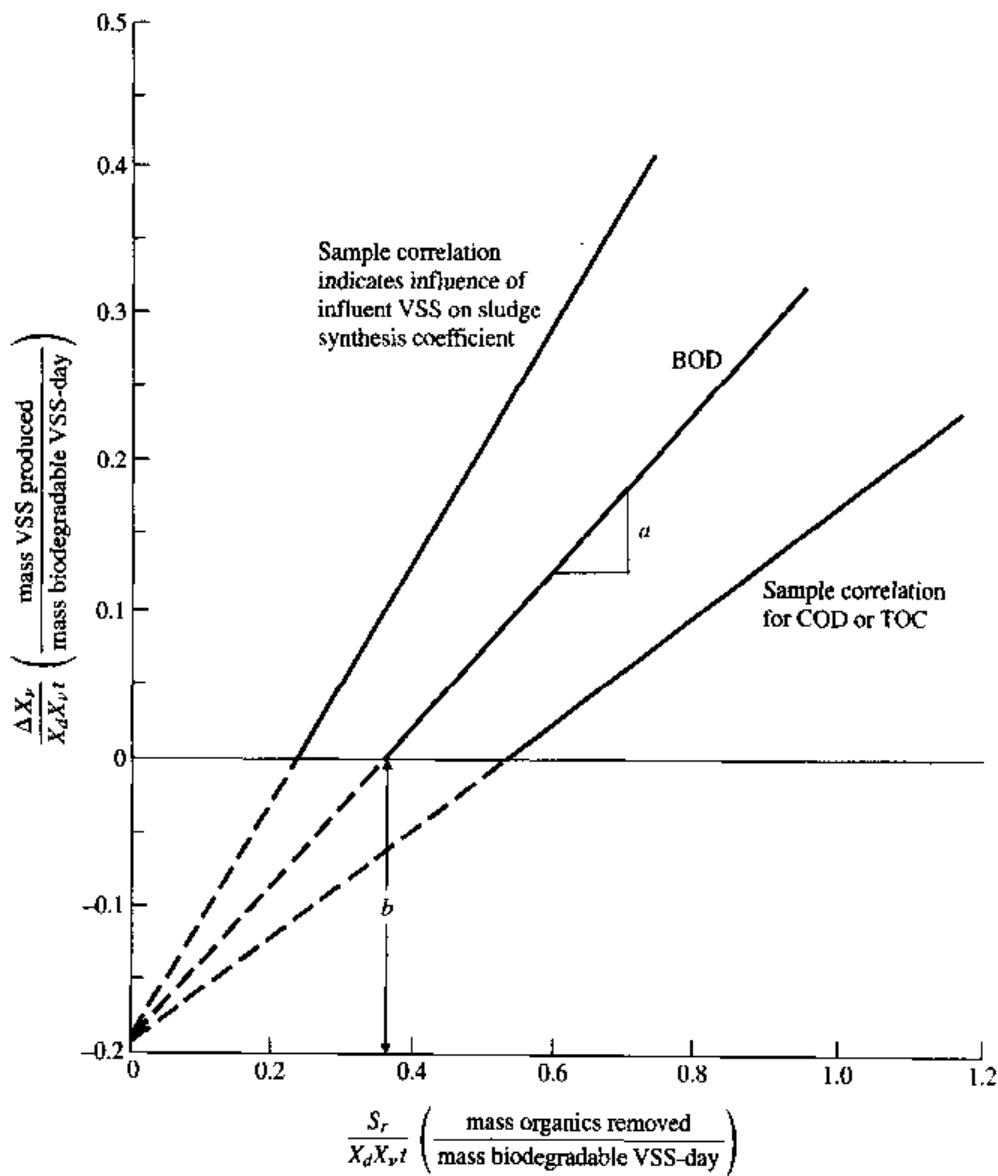
$$1.4 \cdot 0.29 + 0.59 = 0.99$$

The correlations for sludge yield and endogenous rate coefficient are shown in Fig. 6.8.

Data obtained from the treatment of a soluble pharmaceutical waste are shown in Fig. 6.9. Although the synthesis coefficient  $a$  is 0.645 on a BOD<sub>5</sub> basis, the coefficient that results from plotting on a COD basis is 0.37.

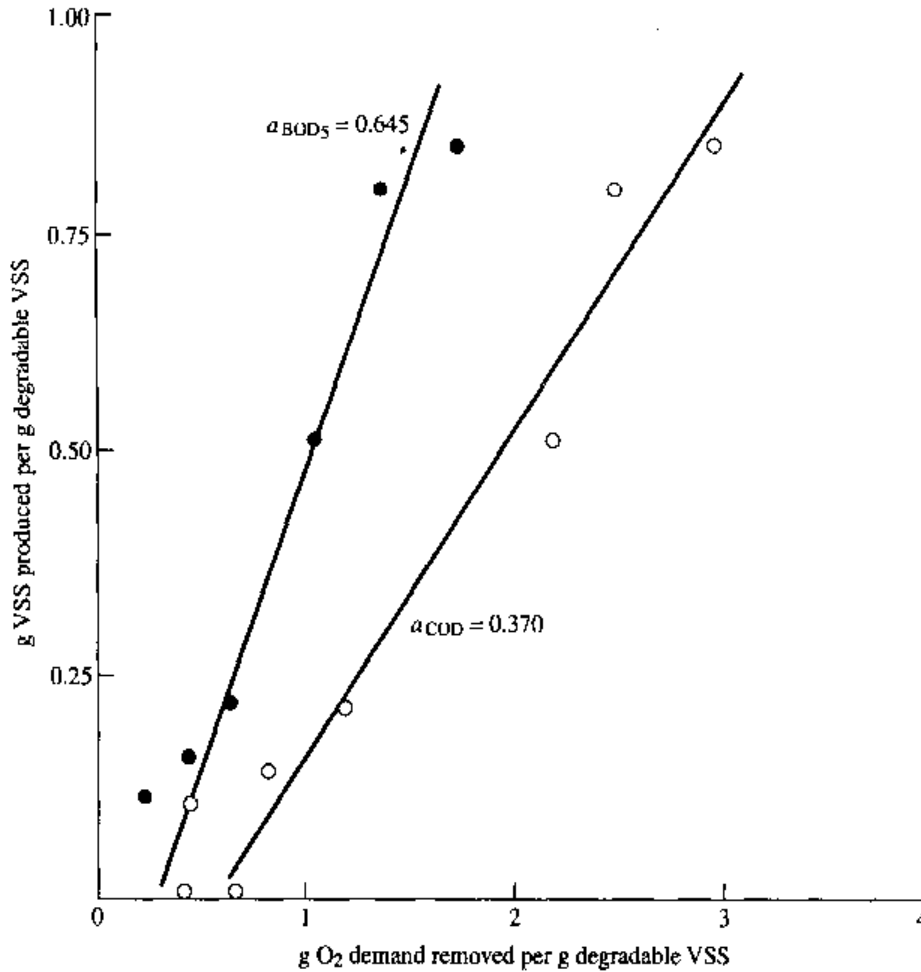
### Oxygen Utilization

It has been previously shown that the total oxygen requirements in a system are related to the oxygen consumed to supply energy for synthesis and the oxygen con-



**FIGURE 6.8**

Determination of sludge production coefficients from Eq. (6.10).



**FIGURE 6.9**  
Cell synthesis relationship for a soluble pharmaceutical wastewater.

sumed for endogenous respiration [Eqs. (6.2) and (6.3)], in which  $a'$  is the fraction of organics consumed to oxidize to end products and  $b'$  is the autooxidation rate of the sludge. In a similar manner, the oxygen requirements for a soluble substrate can be calculated:

$$r_r = \frac{a' S_r}{t} + b' X_d f_b X_v \quad (6.17)$$

in which  $r_r$  = the oxygen uptake rate, mg/(l · d).

During the log-growth phase, the specific oxygen uptake rate (SOUR)  $k_r = r_r/X_v$  is constant, and hence  $r_r$  will increase with increasing synthesis of new cells. As the substrate concentration decreases, the oxygen uptake rate decreases. When the available substrate is exhausted, the oxygen uptake rate decreases to the endogenous rate, which is approximately  $b' X_d f_b X_v$  in Eq. (6.18). Process material balance calculations are shown in Examples 6.2 and 6.3.



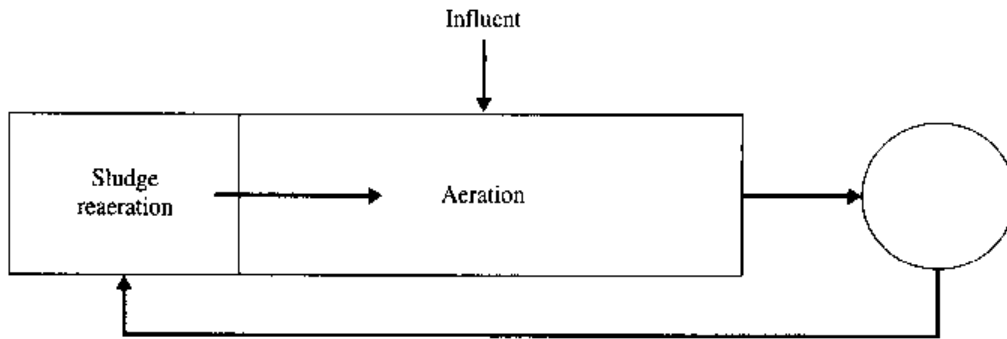
**EXAMPLE 6.3.** Determine the coefficients  $a$  and  $a'$  from the following data.

Soluble TOD removed across aeration = 12,000 lb/d (5450 kg/d)

Sludge re-aeration (subscript  $e$  – endogenous):

$$\text{OUR}_e = 0.45 \text{ mg}/(l \cdot \text{min})$$

$$\text{VSS}_e = 9000 \text{ mg}/l$$



Aeration (subscript  $a$ ):

$$\text{OUR}_a = 1.73 \text{ mg}/(l \cdot \text{min})$$

$$\text{VSS}_a = 6000 \text{ mg}/l$$

$$\text{Volume}_a = 0.26 \text{ million gal } (984 \text{ m}^3)$$

**Solution.**

$$b'X_d = \frac{\text{OUR}_e}{\text{VSS}_e} = \frac{0.45 \text{ mg}/(l \cdot \text{min}) \times 1440 \text{ min}/\text{d}}{9000 \text{ mg}/l} = 0.07/\text{d}$$

$$\begin{aligned} a' &= \frac{8.34V_a[\text{OUR}_a \times 1440 - (\text{OUR}_e \times 1440 \times \text{VSS}_a)/\text{VSS}_e]}{\text{soluble TOD removed}} \\ &= \frac{8.34 [(\text{lb}/\text{million gal})/(\text{mg}/l)] \times 0.26 \text{ million gal} \times 1440 \text{ min}}{12,000 \text{ lb}/\text{d}} \\ &\quad \times [1.73 \text{ mg}/(l \cdot \text{min}) - (0.45 \text{ mg}/(l \cdot \text{min}) \times 6000 \text{ mg}/l)/900] \\ &= 0.37 \end{aligned}$$

$$a = \frac{1 - a'}{1.4} = \frac{1 - 0.37}{1.4} = 0.45$$

If the influent contains degradable VSS, Eq. (6.17) is modified to

$$r_r = a'(S_r + f_d f_s X_i) + b'X_d f_b X_v \quad (6.18)$$

## Nutrient Requirements

Several mineral elements are essential for the metabolism of organic matter by microorganisms. All but nitrogen and phosphorus are usually present in sufficient quantity in the carrier water. An exception is process wastewater generated from deionized water or high-strength industrial wastewaters. Iron and other trace nutrients may be deficient in this case. Trace nutrient requirements are shown in Table 6.2.

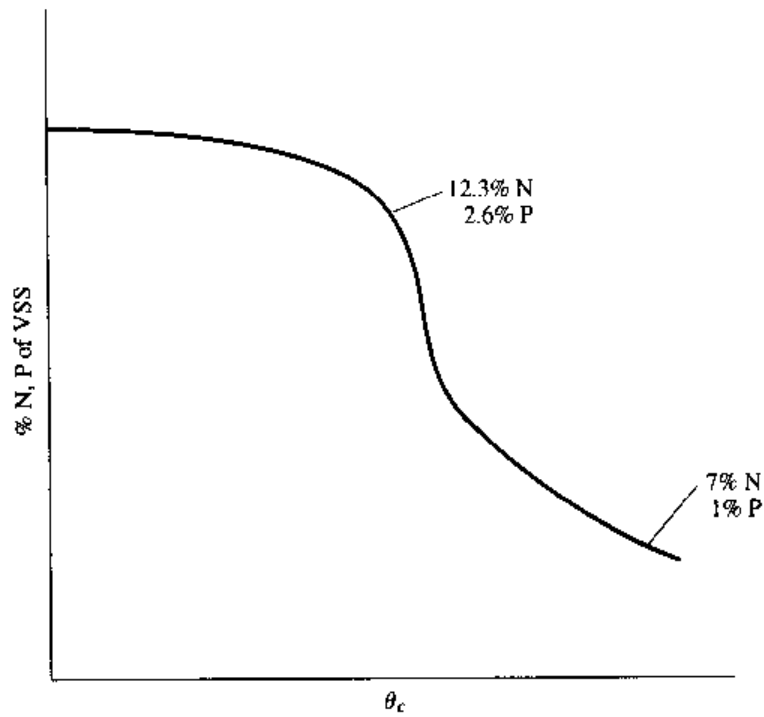
Sewage provides a balanced microbial diet, but many industrial wastes (cannery, pulp and paper, etc.) do not contain sufficient nitrogen and phosphorus and require their addition as a supplement.

The quantity of nitrogen required for effective BOD removal and microbial synthesis has been the subject of much research. Early work by Helmetts et al.<sup>18</sup> indicates a nitrogen requirement of 4.3 lb N/100 lb BOD<sub>rem</sub> (4.3 kg N/100 kg BOD<sub>rem</sub>) and a phosphorus requirement of 0.6 lb P/100 lb BOD<sub>rem</sub> (0.6 kg P/100 kg BOD<sub>rem</sub>). These represent average values derived from the treatment of several nitrogen-supplemented industrial wastes. When insufficient nitrogen is present, the amount of cellular material synthesized per unit of organic matter removed increases as an accumulation of polysaccharide. At some point, nitrogen-limiting conditions restrict the rate of BOD removal. The rule-of-thumb number is BOD:N:P of 100:5:1. Nutrient-limiting conditions will also stimulate filamentous growth, as discussed on p. 255.

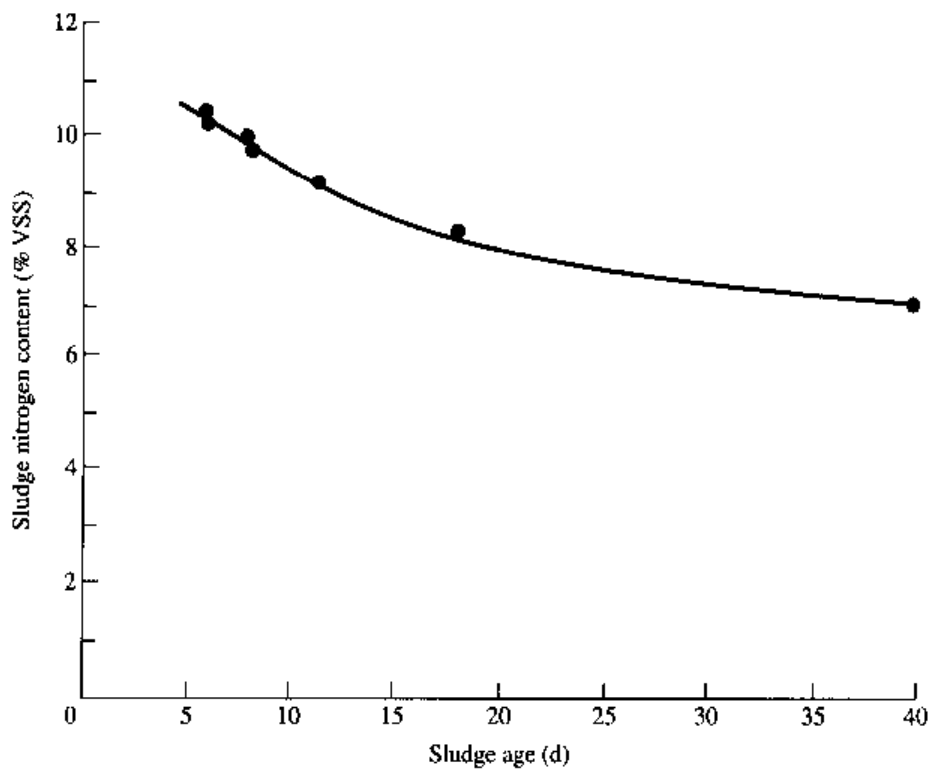
The nitrogen content of sludge as generated in the process has been shown to average 12.3 percent on the basis of the VSS. The nitrogen content of the sludge will decline during the endogenous phase. The nitrogen content of the nondegradable cellular mass has been shown to average 7 percent. This is shown in Fig. 6.10. The decrease in nitrogen content of an activated sludge with a soluble substrate as a function of sludge age is shown in Fig. 6.11. The phosphorus content of sludge

TABLE 6.2  
Trace nutrient requirements for  
biological oxidation

	mg/mg BOD
Mn	$10 \times 10^{-5}$
Cu	$14.6 \times 10^{-5}$
Zn	$16 \times 10^{-5}$
Mo	$43 \times 10^{-5}$
Se	$14 \times 10^{-10}$
Mg	$30 \times 10^{-4}$
Co	$13 \times 10^{-5}$
Ca	$62 \times 10^{-4}$
Na	$5 \times 10^{-5}$
K	$45 \times 10^{-4}$
Fe	$12 \times 10^{-3}$
CO <sub>3</sub>	$27 \times 10^{-4}$



**FIGURE 6.10**  
Nutrient requirements.



**FIGURE 6.11**  
Nitrogen content of activated sludge as related to sludge age.

at generation has been found to average 2.6 percent with the nondegradable cellular mass having a phosphorus content of 1 percent. The nitrogen and phosphorus requirements can be calculated by considering the nitrogen and phosphorus content of the biological sludge wasted from the process:

$$N = 0.123 \frac{X_d}{0.8} \Delta X_{v_s} + 0.07 \frac{0.8 - X_d}{0.8} \Delta X_{v_s} \quad (6.19)$$

$$P = 0.026 \frac{X_d}{0.8} \Delta X_{v_s} + 0.01 \frac{0.8 - X_d}{0.8} \Delta X_{v_s} \quad (6.20)$$

Not all organic nitrogen compounds are available for synthesis. Ammonia is the most readily available form, and other nitrogen compounds must be converted to ammonia. Nitrite, nitrate, and about 75 percent of organic nitrogen compounds are also available.

Phosphorus may be fed as phosphoric acid in larger plants and ammonia as anhydrous or aqueous ammonia. In small plants, nutrients may be fed as diammonium phosphate. In many cases, in aerated lagoons treating pulp and paper mill wastewaters, nitrogen and phosphorus have not been added, but rather the retention time has been increased. Calculated rate coefficients with and without the addition of nutrients is shown in Table 6.3. Nutrient requirements are computed in Example 6.4.

**EXAMPLE 6.4.** An activated sludge plant treating an industrial wastewater operated under the following conditions:

- Flow = 1.6 million gal/d
- $S_o = 560$  mg/l (BOD basis)
- $S_e = 20$  mg/l
- $X_v = 3000$  mg/l
- $a = 0.55$
- $b = 0.1/\text{d}$
- $\text{NH}_3\text{-N} = 5$  mg/l
- $P = 3$  mg/l
- $F/M = 0.4/\text{d}^{-1}$
- $\theta_c = 7$  d

Compute the N and P which must be added to the process.

TABLE 6.3

Waste	$K, \text{d}^{-1}$	
	Without nutrients	With nutrients
Kraft paper	0.35	1.33
Board mill	0.70	3.20
Hardboard	0.34	1.66

**Solution.**

$$t = \frac{S_0}{X_v F/M} = \frac{560}{3000 \cdot 0.4} = 0.47 \text{ d}$$

$$X_d = \frac{0.8}{1 + (0.2 \cdot 0.1 \cdot 7)} = 0.7$$

$$\Delta X_v = aS_r - bX_d X_v t$$

$$\begin{aligned} \Delta X_v &= 0.55(540) - 0.1 \cdot 0.7 \cdot 3000 \cdot 0.47 \\ &= 198 \text{ mg/l or } 2642 \text{ lb/d} \quad (1200 \text{ kg/d}) \end{aligned}$$

$$\begin{aligned} N &= 0.123 \frac{0.7}{0.8} \cdot 2642 + 0.07 \cdot \frac{0.8 - 0.7}{0.8} \cdot 2642 \\ &= 284 + 23 = 307 \text{ lb/d} \quad (140 \text{ kg/d}) \end{aligned}$$

$$N_{\text{INFLUENT}} = 5 \cdot 1.6 \cdot 8.34 = 67 \text{ lb/d} \quad (30 \text{ kg/d})$$

$$N_{\text{ADDED}} = 307 - 67 = 240 \text{ lb/d}$$

$$\begin{aligned} P &= 0.026 \cdot \frac{0.7}{0.8} \cdot 2642 + 0.01 \cdot \frac{0.8 - 0.7}{0.8} \cdot 2642 \\ &= 60 + 3.3 \\ &= 63.3 \text{ lb/d} \quad (29 \text{ kg/d}) \end{aligned}$$

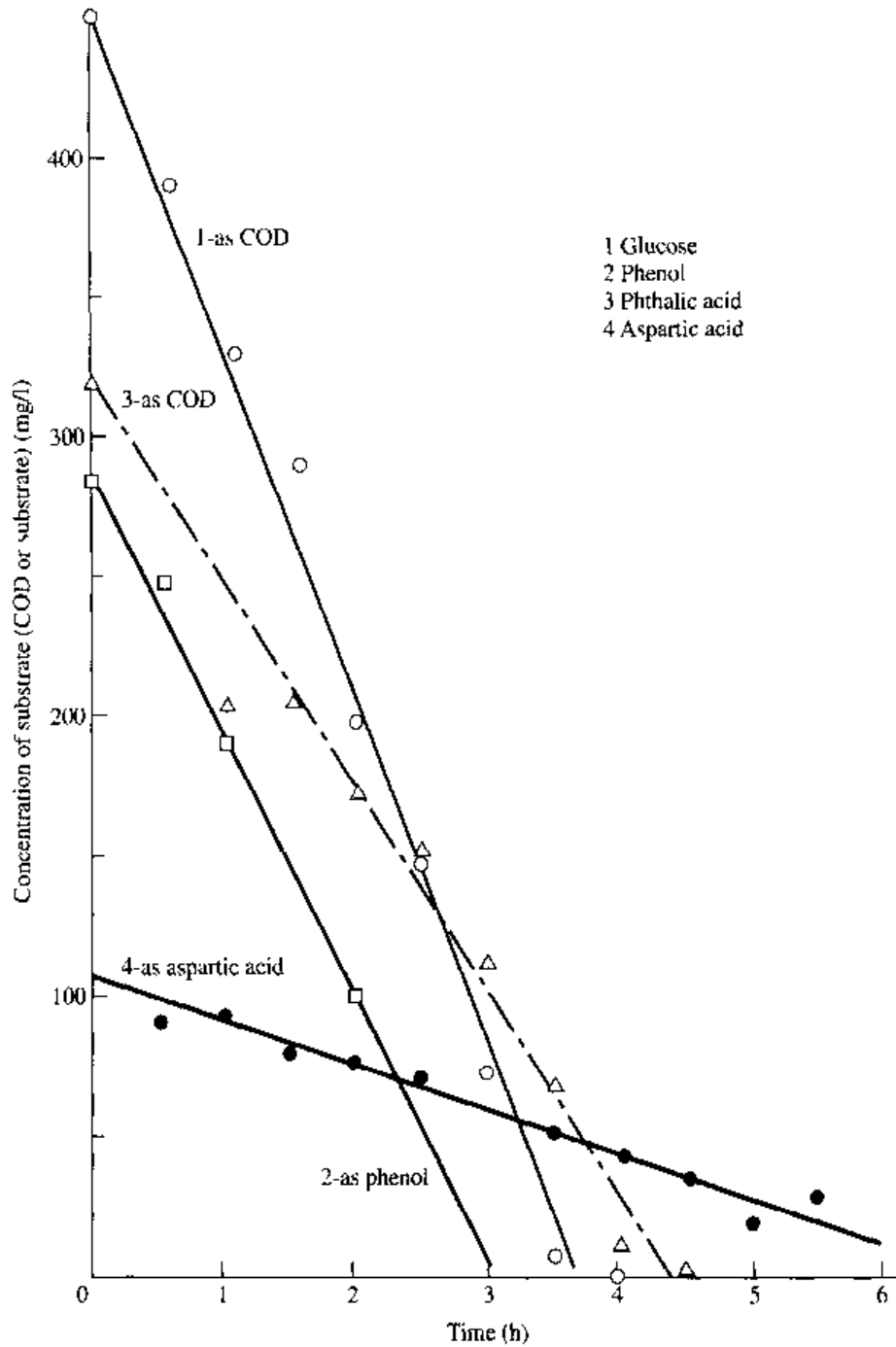
$$P_{\text{INFLUENT}} = 3 \cdot 1.6 \cdot 8.34 = 40 \text{ lb/d} \quad (18 \text{ kg/d})$$

$$P_{\text{ADDED}} = 63.3 - 40 = 23.3 \text{ lb/d} \quad (11 \text{ kg/d})$$

**Mathematical Relationships of Organic Removal**

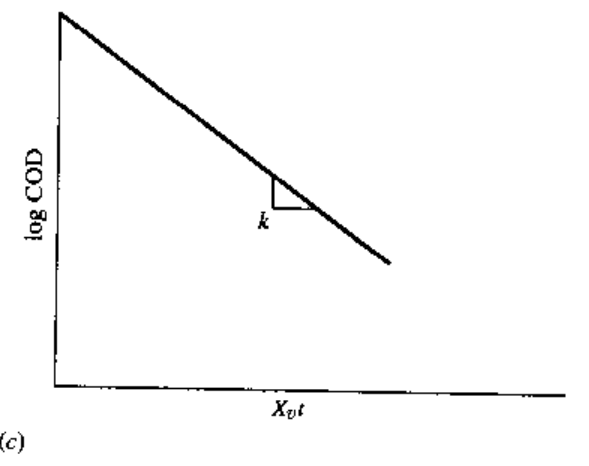
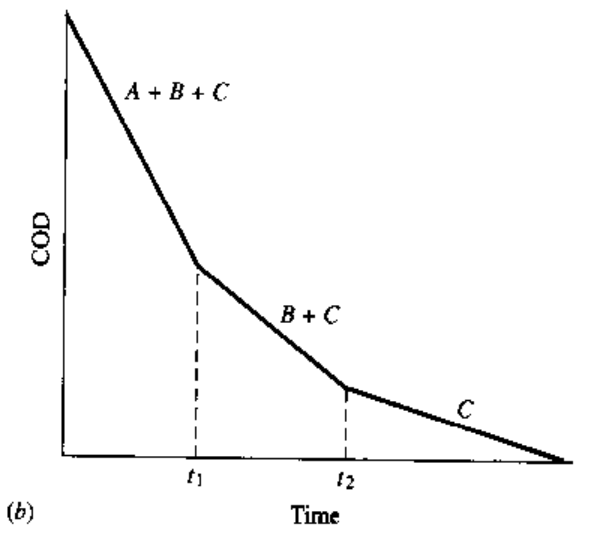
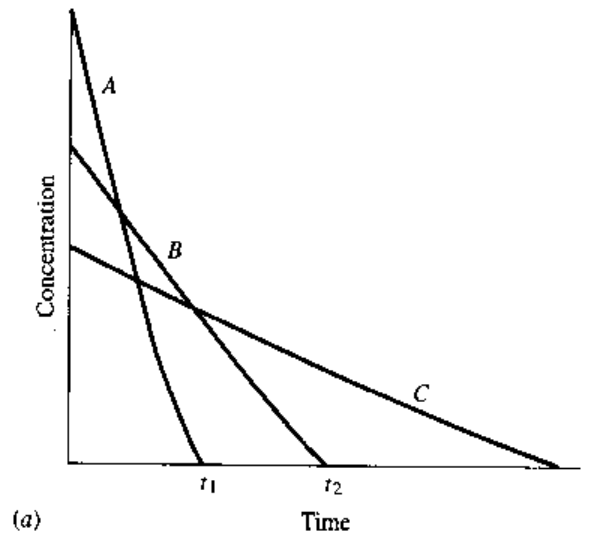
Several mathematical models have been offered to explain the mechanism of BOD removal by biological oxidation processes. All these models have shown that, at high BOD levels, the rate of BOD removal per unit mass of cells will remain constant to a limiting BOD concentration, below which the rate will become concentration-dependent and will decrease as the concentration. Wuhrmann<sup>19</sup> and Tischler and Eckenfelder<sup>20</sup> have shown that single substances are removed by a zero-order reaction to very low substrate levels. Some reactions are shown in Fig. 6.12. In a mixture of substances being removed at different rates, a constant maximum removal rate will prevail until one of the substances is completely removed. As other substances are progressively removed, the overall rate will decrease. As Gaudy, Komolrit, and Bhatla<sup>21</sup> have shown, sequential substrate removal will also yield a decreasing overall rate.

It is assumed that the volatile suspended solids concentration in the reactor is proportional to the cell mass. If volatile suspended solids are present in the influent wastewater, this assumption must be modified as discussed on p. 209.



**FIGURE 6.12**  
Zero-order removal rates for specific substrates.

In the case of a multicomponent wastewater where concurrent zero-order reactions occur, the overall removal can be formulated as shown in Fig. 6.13. The zero-order removal for three components is shown in Fig. 6.13a. When considering the total removal of all components as BOD, COD, or TOC, the overall rate will remain constant until time  $t_1$ , when component *A* is substantially removed. The overall rate will then decrease to reflect components *B* and *C*. At time  $t_2$ ,



**FIGURE 6.13**  
Schematic representation of multicomponent substrate removal.

component *B* is substantially removed and the rate will decrease to reflect only component *C*. For a wastewater consisting of many components, the breaks in Figure 6.13*b* are not apparent and a curve results. In most cases, this curve can be linearized and can be fitted to another order reaction equation<sup>20, 22, 23</sup> of the following form:

$$\frac{dS}{dt} = -K_n X_a \left( \frac{S}{S_o} \right)^n \quad (6.21)$$

where  $S$  = COD concentration at time  $t$ , mg/l  
 $S_o$  = COD concentration at time zero, mg/l  
 $X_a$  = active biomass concentration, mg/l  
 $t$  = time, d  
 $K_n$  = curve fitting coefficient,  $d^{-1}$   
 $n$  = function power order

The active mass can be defined as

$$X_a = X_v \cdot \frac{X_d}{0.8} \cdot f_b \quad (6.22)$$

If the wastewater contains no influent VSS,

$$f_b = 1.0$$

If the influent VSS are nondegradable,

$$f_b = 1 - \frac{X_i \theta_c}{X_v t} \quad (6.23)$$

If the influent VSS are degradable, Eq. (6.15) applies.

Regardless of the actual degradation rates of the individual substrate components, the integrated form of Eq. (6.21) represents the performance of a batch or a continuous plug flow reactor (CPFR). The integrated forms of Eq. (6.21) for  $n = 1$  and  $n = 2$  are:

$$S_e = S_o e^{-K_1 f_b X_v t / S_o} \quad (6.24)$$

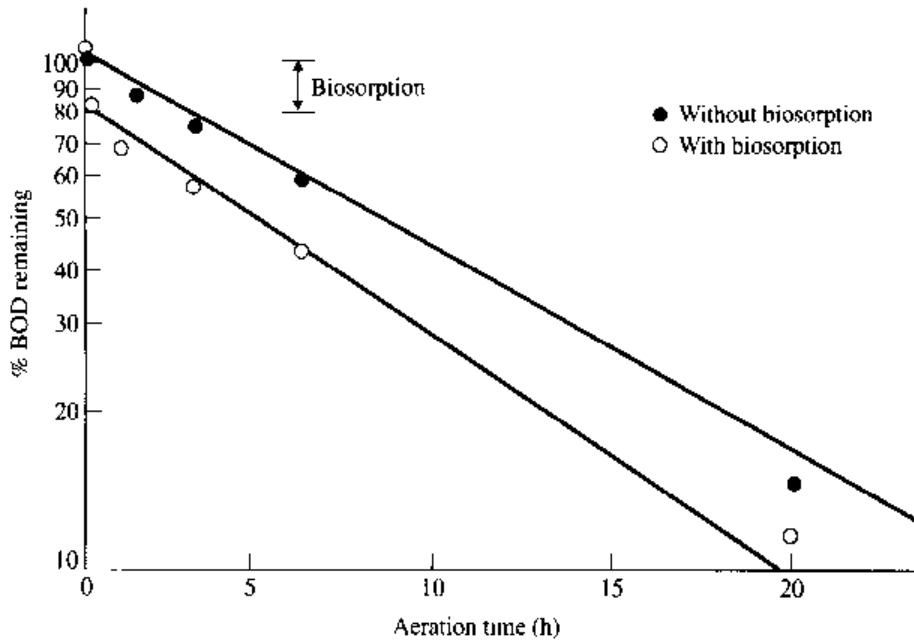
$$S_e = \frac{S_o^2}{S_o + K_2 f_b X_v t} \quad (6.25)$$

where  $S_e$  = effluent COD or BOD in a CPFR or a batch reactor, mg/l  
 $t$  = CPFR's hydraulic retention time or batch test reaction time, d  
 $K_1$  = first-order coefficient,  $d^{-1}$   
 $K_2$  = second-order coefficient,  $d^{-1}$

Batch kinetics for a first-order approximation and a second-order approximation are shown in Figs. 6.14 and 6.15.

Plug flow kinetics following a first-order function for a pulp and paper mill wastewater are shown in Fig. 6.16. Initial biosorption in the plug flow reactor should be noted.





**FIGURE 6.14**

Batch activated sludge with and without biosorption for a pulp and paper mill wastewater.

If the individual components of the substrate are degraded at a zero-order rate, the overall rate for a CSTR will still follow a kinetic equation similar to Eq. (6.21), assuming a nonsegregated flow regime.<sup>24, 25</sup>

In a complete mix basin, the overall removal rate will decrease as the concentration of organics remaining in solution decreases, since the more readily degradable organics will be removed first. The kinetics of the oxidation are therefore limited by the effluent concentration and can be expressed as

$$\frac{S_o - S_e}{f_b X_v t} = K \frac{S_e}{S_o} \quad (6.26)$$

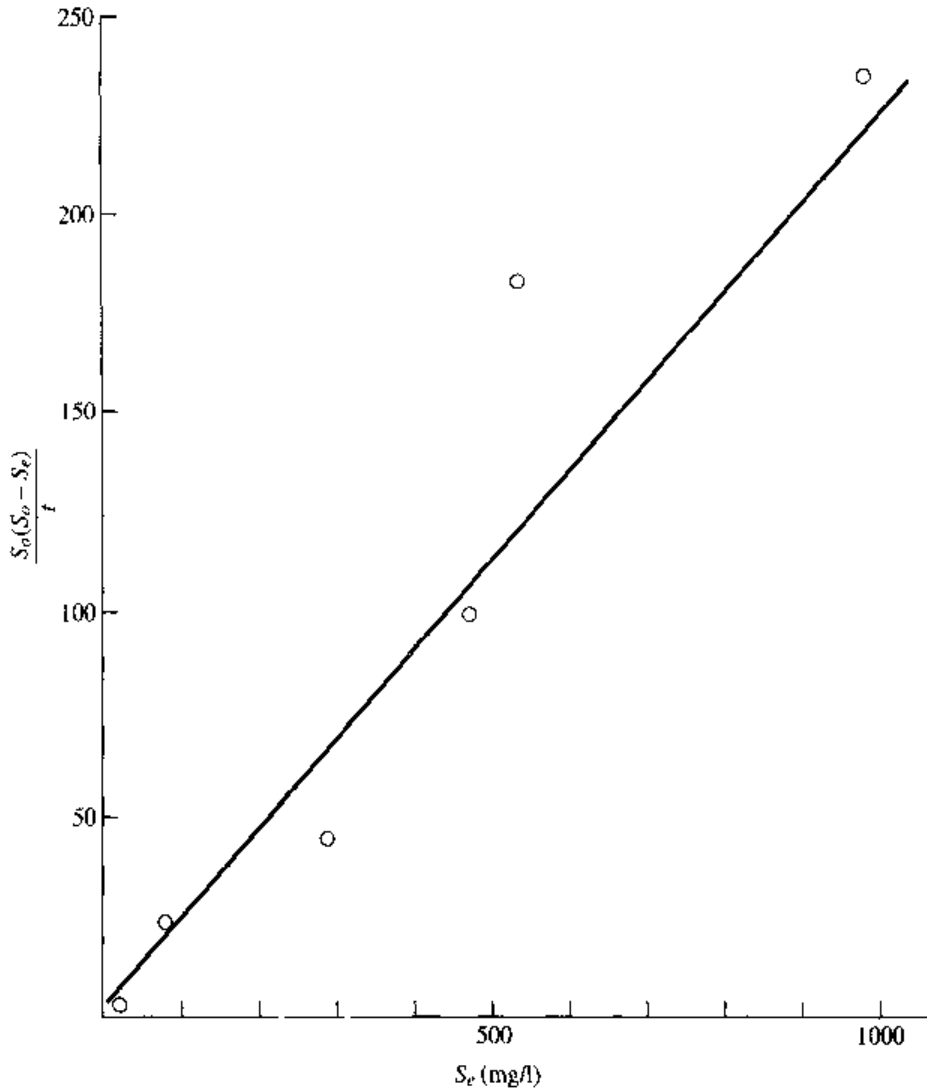
This relationship is shown in Fig. 6.17 for a soybean wastewater.

The relative biodegradability of various organic compounds is shown in Table 6.4. The rate coefficient  $K$  for various industrial wastewaters in CMAS systems is shown in Table 6.5.

In all kinetic calculations the rate coefficient  $K$  should be based on active mass in the reactor.

There are two operating conditions which influence the organic removal rate, as defined by a rate coefficient  $K$ . These are the active fraction of the biomass in the MLVSS and the aerobic portion of the biofloc. The active fraction of the MLVSS is related to the sludge age or the  $F/M$ . Increasing the  $F/M$  or decreasing the  $\theta_c$  will increase the active fraction of the biomass as shown in Fig. 6.18. The second condition defines that portion of the floc which is aerobic and is related to the turbulence level or mixing intensity and bulk dissolved oxygen level in the aeration basin.

The fraction of active biomass in the mixed liquor is defined here as the biodegradable fraction  $X_d$  divided by 0.80. This is illustrated in Examples 6.5 and 6.6.

**FIGURE 6.15**

Batch oxidation of a chemical industry wastewater following second-order kinetics.

**EXAMPLE 6.5.** A complete mix activated sludge plant with an influent BOD of 800 mg/l and a  $K$  of  $6 \text{ d}^{-1}$  is operating at an SRT of 10 d. What is the effluent quality and what will the effluent quality be if the SRT is increased to 30 days?  $a$  is 0.5 and  $b$  is  $0.1 \text{ d}^{-1}$ .

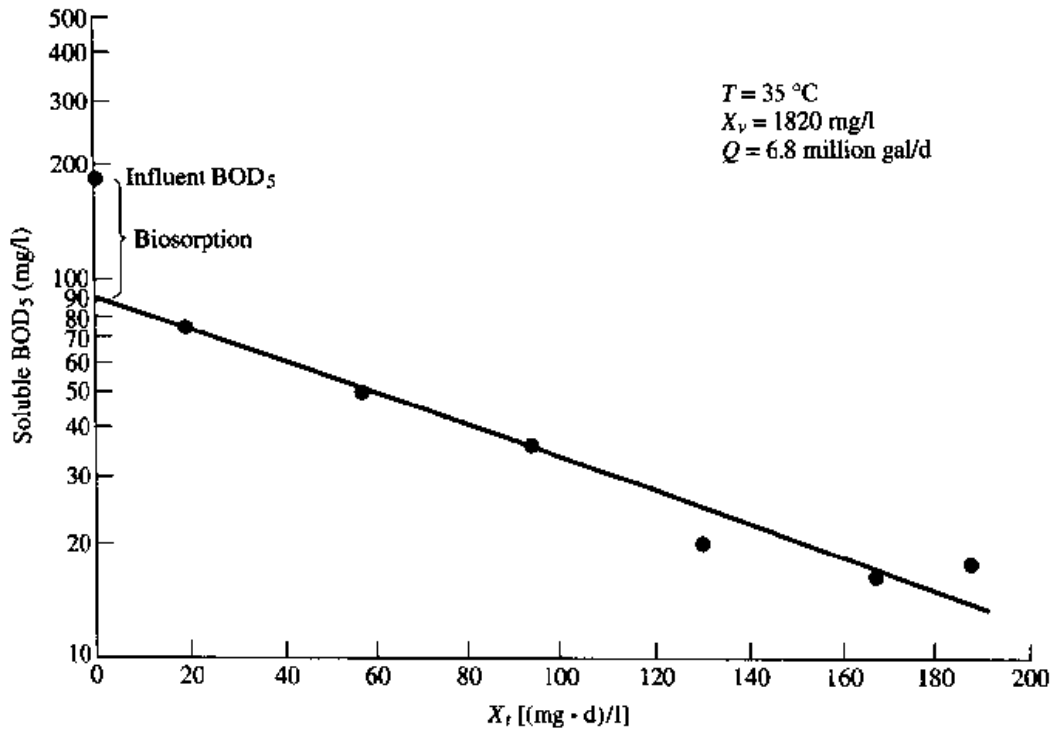
**Solution.**

$$\frac{1}{\theta_c} = aK \frac{S_e}{S_0} - bX_d$$

At  $\theta_c = 10 \text{ d}$ ,

$$\frac{1}{10} = 0.5 \cdot 6 \cdot \frac{S_e}{S_0} - 0.1 \cdot \left( \frac{0.8}{1 + 0.2 \cdot 0.1 \cdot 10} \right)$$

$$\frac{S_e}{S_0} = 0.056$$



**FIGURE 6.16**  
Plug flow BOD removal kinetics for a bleached kraft pulp and paper wastewater.

and

$$S_e = 0.056 \cdot 800 = 45\text{ mg/l}$$

At  $\theta_c = 30\text{ d}$ , the  $K$  can be adjusted by Fig. 6.18:

$$K = 6 \cdot \frac{0.625}{0.83} = 4.5\text{ d}^{-1}$$

$$\frac{1}{30} = 0.5 \cdot 4.5 \frac{S_e}{S_o} - 0.1 \cdot \left( \frac{0.8}{1 + 0.2 \cdot 0.1 \cdot 30} \right)$$

$$\frac{S_e}{S_o} = 0.0368$$

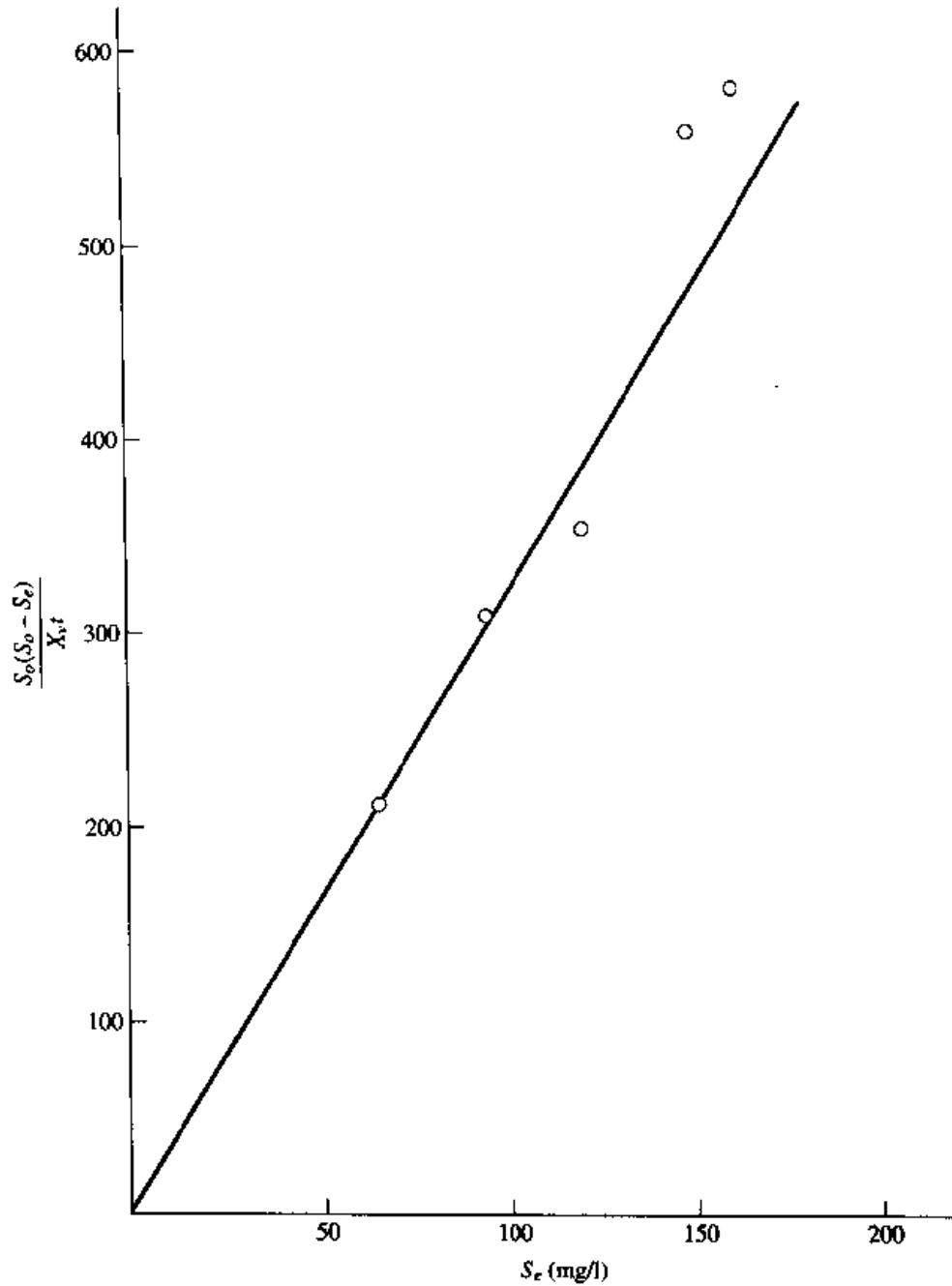
and

$$S_e = 0.0368 \cdot 800 = 30\text{ mg/l}$$

If  $X_v$  is 2500 mg/l and  $t = 0.9\text{ d}$  at  $\theta_c = 10\text{ d}$ , the  $X_v t$  at a 30-d SRT is

$$\begin{aligned} X_v t &= \frac{\theta_c a S_r}{1 + \theta_c b X_d} \\ &= \frac{30 \cdot 0.5 \cdot 770}{1 + 30 \cdot 0.1 \cdot 0.5} = 4620\text{ (mg · d)/l} \end{aligned}$$

$$X_v = 5133\text{ mg/l}$$



**FIGURE 6.17**  
Complete mix kinetics for a soybean wastewater.

**EXAMPLE 6.6.** Determine the hydraulic retention time and the sludge age for the following condition:

$$\begin{aligned}
 S_o &= 700 \text{ mg/l} \\
 S_e &= 30 \text{ mg/l} \\
 K &= 10/\text{d} \\
 X_v &= 3000 \text{ mg/l} \\
 a &= 0.4
 \end{aligned}$$

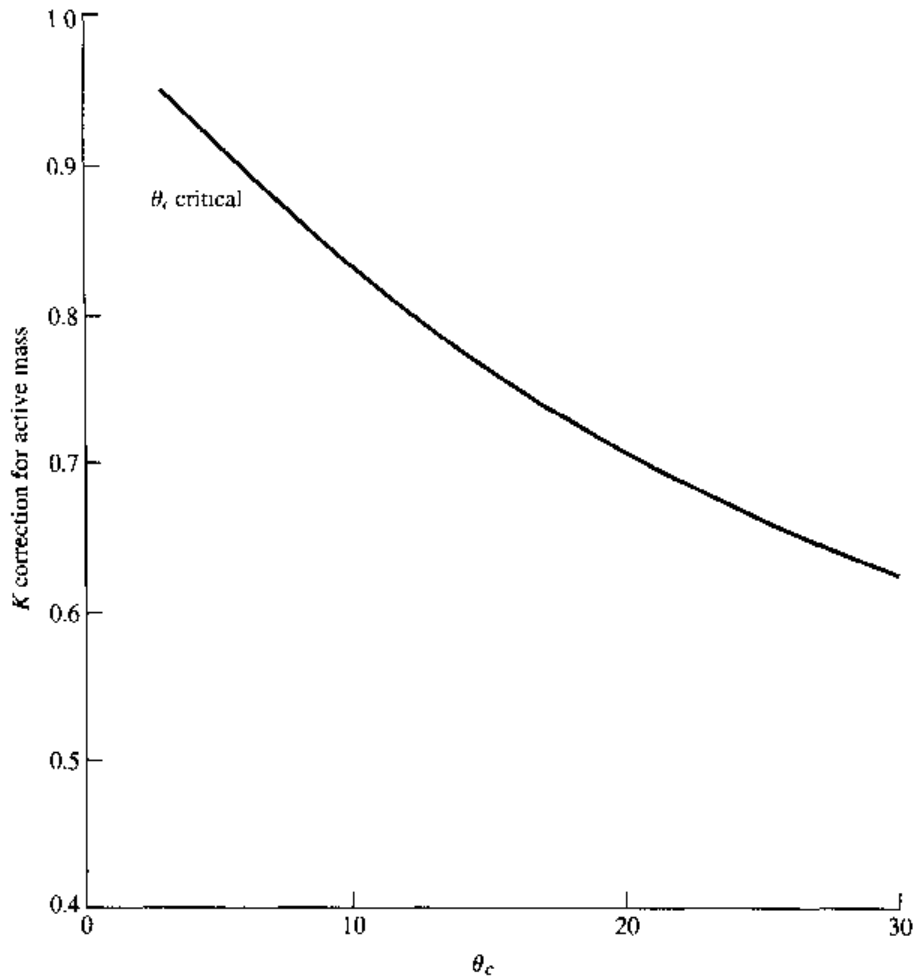
**TABLE 6.4**  
**Relative biodegradability of certain organic compounds**

<b>Biodegradable organic compounds<sup>†</sup></b>	<b>Compounds generally resistant to biological degradation</b>
Acrylic acid	Ethers
Aliphatic acids	Ethylene chlorohydrin
Aliphatic alcohols (normal, iso, secondary)	Isoprene
Aliphatic aldehydes	Methyl vinyl ketone
Aliphatic esters	Morpholine
Alkyl benzene sulfonates with exception of porpylene-based benzaldehyde	Oil
Aromatic amines	Polymeric compounds
Dichlorophenols	Polypropylene benzene sulfonates
Ethanolamines	Selected hydrocarbons
Glycols	Aliphatics
Ketones	Aromatics
Methacrylic acid	Alkyl-aryl groups
Methyl methacrylate	Tertiary aliphatic alcohols
Monochlorophenols	Tertiary aliphatic sulfonates
Nitriles	Trichlorophenols
Phenols	
Primary aliphatic amines	
Styrene	
Vinyl acetate	

<sup>†</sup>Some compounds can be degraded biologically only after extended periods of seed acclimation.

**TABLE 6.5**  
**Reaction rate coefficient for selected wastewaters**

<b>Wastewater source</b>	<b>K, d<sup>-1</sup></b>	<b>Temperature, °C</b>
Vegetable tannery	1.2	20
Cellulose acetate	2.6	20
Peptone	4.0	22
Organic phosphates	5.0	21
Vinyl acetate monomer	5.3	20
Organic intermediates	5.8	8
	20.6	26
Viscose rayon and nylon	6.7	11
	8.2	19
Domestic sewage (solubles)	8.0	20
Polyester fiber	14.0	21
Formaldehyde, propanol, methanol	19.0	20
High-nitrogen organics	22.2	22
Potato processing	36.0	20

**FIGURE 6.18**

Relationship between  $K$  and  $\theta_c$ , considering biological active mass.

What will be the required hydraulic retention time to produce the same effluent if the influent nondegradable VSS is 50 mg/l?

**Solution.**

Solving Eq. (6.24) for the hydraulic retention time  $t$  produces,  $S_p = 30$  mg/l,

$$\begin{aligned} t &= \frac{S_o S_r}{K X_v S_e} \\ &= \frac{700 \cdot 670}{10 \cdot 3000 \cdot 30} = 0.52 \text{ d} \end{aligned}$$

and

$$X_v t = 1560 \text{ (mg} \cdot \text{d)/l}$$

The SRT for these conditions is

$$\theta_c = \frac{X_v t}{a S_r - b X_d X_v t}$$

Assume  $X_d = 0.7$ . Then

$$\begin{aligned}\theta_c &= \frac{1560}{0.4 \cdot 670 - 0.1 \cdot 0.7 \cdot 1560} \\ &= \frac{1560}{159} = 9.8 \text{ d, say } 10 \text{ d}\end{aligned}$$

Check assumption for  $X_d = 0.7$  of  $\text{SRT} = 10$  d:

$$\begin{aligned}X_d &= \frac{0.8}{1 + 0.2 \cdot 0.1 \cdot 10} \\ X_d &= 0.67\end{aligned}$$

To determine the required hydraulic retention time to produce the same effluent  $S_e = 30$  mg/l if the influent nondegradable VSS = 50 mg/l, assume  $t = 0.69$  d (by trial and error) and calculate the accumulation of the influent VSS in the mixed liquor (MLVSS<sub>i</sub>):

$$\text{MLVSS}_i = \frac{50 \cdot 10}{0.69} = 725 \text{ mg/l}$$

The residual biomass VSS in the mixed liquor is

$$X_{vb} = 3000 - 725 = 2275 \text{ mg/l}$$

Calculate the required  $t$ :

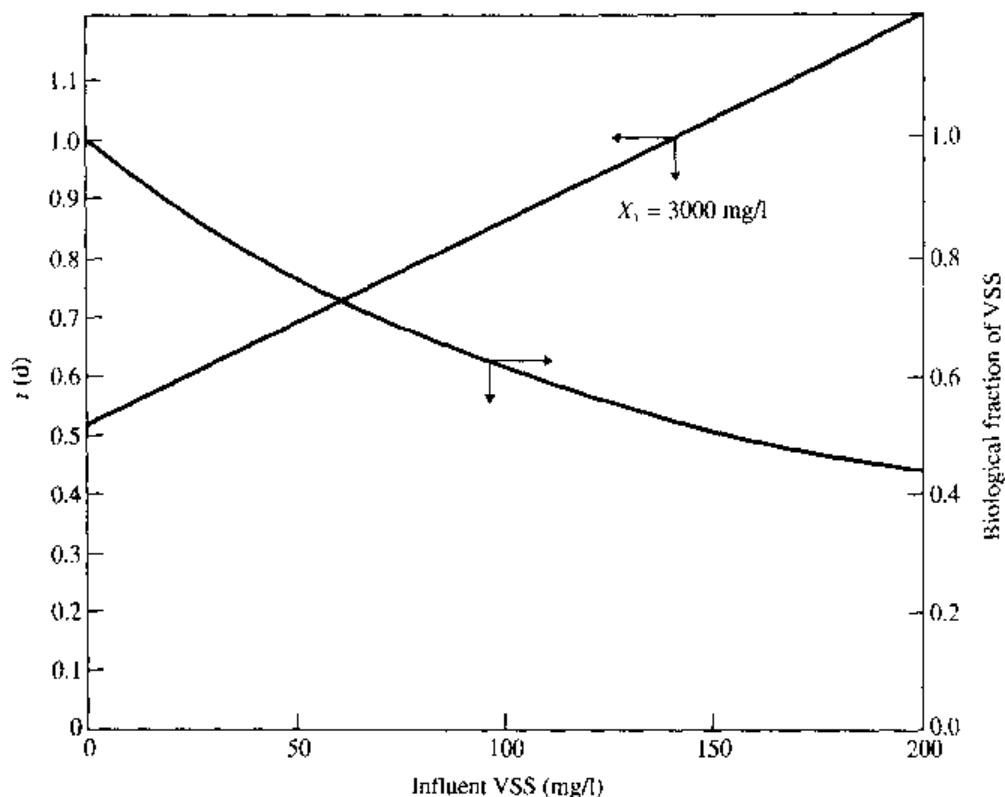
$$\begin{aligned}t &= \frac{X_{vb} t}{X_{vb}} = \frac{1560}{2275} = 0.69 \text{ d} \\ f_b &= 2275/3000 = 0.76\end{aligned}$$

Check sludge age:

$$\begin{aligned}\theta_c &= \frac{X_v t}{(aS_r - bX_{vb} X_d t) + X_i} \\ &= \frac{3000 \cdot 0.69}{(268 - 0.1 \cdot 2275 \cdot 0.7 \cdot 0.69) + 50} \\ &= \frac{2070}{208} = 9.9 \text{ d}\end{aligned}$$

The greater hydraulic retention time is required to produce the same effluent quality since the nondegradable influent VSS accumulated in the constant MLVSS concentration of 3000 mg/l. This is shown in the figure on the next page.

The size and the aerobic fraction of the biological floc are related to the operating power level in the aeration basin and the mixed liquor bulk dissolved oxygen concentration. These in turn influence both the reaction rate coefficient and the endogenous decay rate. The effect on the reaction rate coefficient has been demonstrated in treatment of wastewater from a bleached kraft pulp and paper mill. The biodegradation rate [ $K$  in Eq. (6.26)] under operation at an  $F/M$  of  $0.3 \text{ d}^{-1}$  and a conventional aeration basin power level of 200 hp/million gal averaged  $4.5 \text{ d}^{-1}$ .



Operation at an  $F/M$  of  $0.88 \text{ d}^{-1}$  and a power level of 500 hp/million gal averaged a  $K$  of  $12.5 \text{ d}^{-1}$ . BOD removal of 92 percent was achieved under these conditions.

Two factors will influence the endogenous decay rate and the observed sludge yield. These are the degradable fraction  $X_b$ , which is a function of SRT or  $F/M$ , and the aerobic fraction of the MLVSS. Increasing the mixing intensity in the aeration basin will increase the aerobic fraction of the mixed liquor solids and the rate of endogenous respiration. This condition has been observed in the high-purity-oxygen activated sludge process in which high mixed liquor dissolved oxygen levels increased the aerobic fraction of the floc and decreased the observed sludge yield. Rickard and Gaudy<sup>26</sup> showed a decrease in observed sludge yield with increasing agitation at a constant  $F/M$ .

It has been observed that, at high energy levels in the aeration basin, filamentous bulking is suppressed. This was noted by Rickard and Gaudy,<sup>26</sup> who showed that, at a velocity gradient of  $310 \text{ s}^{-1}$ , a majority of the cells were of the filamentous type, while, at a velocity gradient of  $1010/\text{s}^{-1}$ , filaments were reportedly absent. Zahradka<sup>27</sup> observed that a high power input caused the growth of sludge flocs of small and uniform size and suppressed the growth of filamentous organisms. This can be explained by the fact that, at high power levels, oxygen and BOD diffusion is not limiting with small flocs, and therefore the floc formers will dominate over the filaments. It is therefore important to consider the aeration power level and its effect on the reaction coefficient  $K$  and  $b$  in a process design or a pilot plant study.



In cases where multiple wastewaters are mixed for biological treatment, a mean reaction rate  $K$  is determined. In this case the average rate coefficient  $K_c$  can be computed:

$$\frac{1}{K_c} = \frac{\frac{1}{K_1}(Q_1S_{o_1}) + \frac{1}{K_2}(Q_2S_{o_2})}{Q_1S_{o_1} + Q_2S_{o_2}} \quad (6.27)$$

This is shown in Example 6.7. The multiple zero-order concept may also predict the performance of a combined system, where two or more different wastewater streams are treated in one unit.

**EXAMPLE 6.7. Treatment of mixed industrial wastewaters.** Three industrial wastewaters are to be blended and treated in an activated sludge plant. Compute the sludge age and the hydraulic retention time required to produce an effluent of 20 mg/L BOD. The characteristics of the three wastewaters are

1.  $Q = 2$  million gal/d  
 $S_o = 600$  mg/l  
 $K = 5$  d<sup>-1</sup>
2.  $Q = 1$  million gal/d  
 $S_o = 1200$  mg/l  
 $K = 10$  d<sup>-1</sup>
3.  $Q = 5$  million gal/d  
 $S_o = 300$  mg/l  
 $K = 2$  d<sup>-1</sup>

**Solution.**

The average influent BOD is

$$S_{o_{ave}} = \frac{2 \cdot 600 + 1 \cdot 1200 + 5 \cdot 300}{8} = 487 \text{ mg/l}$$

The average  $K$  is

$$\begin{aligned} \frac{1}{K_{ave}} &= \frac{Q_1S_{o_1}/K_1 + Q_2S_{o_2}/K_2 + Q_3S_{o_3}/K_3}{Q_1S_{o_1} + Q_2S_{o_2} + Q_3S_{o_3}} \\ &= \frac{0.2 \cdot 600 + 0.1 \cdot 1 \cdot 1200 + 0.5 \cdot 5 \cdot 300}{2 \cdot 600 + 1 \cdot 1200 + 5 \cdot 300} \\ &= 0.28 \end{aligned}$$

$$K_{ave} = 3.57 \text{ d}^{-1}$$

The mean yield coefficient  $a$  is 0.5,  $b$  is 0.1, and  $X_v$  is 3000 mg/l. For a  $K_{ave}$  of 3.57,

$$\begin{aligned} \frac{1}{\theta_c} &= aK \frac{S_e}{S_o} - bX_d \\ &= 0.5 \cdot 3.57 \cdot \frac{20}{487} - 0.1 \cdot 0.46 \\ &= 0.027 \end{aligned}$$

$$\theta_c = 37 \text{ d}$$

$$\theta_c = \frac{X_v t}{aS_r - bX_d X_v t}$$

or

$$\begin{aligned} X_v t &= \frac{\theta_c a S_r}{1 + \theta_c b X_d} \\ &= \frac{37 \cdot 0.5 \cdot 467}{1 + 37 \cdot 0.1 \cdot 0.46} \\ &= 3200 \\ t &= \frac{3200}{3000} = 1.07 \text{ d} \end{aligned}$$

In a two-stage activated sludge system without an intermediate clarifier, the effluent will be the same as a single-stage system as long as multiple zero-order kinetics apply and the second-stage kinetic coefficient is proportional to the squared ratio of the pretreated to raw substrate concentrations. In a two-stage system with an intermediate clarifier between the two stages, leading to the development of a biomass specifically acclimated to the substrate remaining in the first-stage effluent, the rate coefficient in the second stage will be lower than in the first stage since the more degradable compounds were removed in the first stage. The second stage  $K$  can be estimated from the relationship

$$K_2 = K_1 \left[ \frac{S_1}{S_o} \right] \quad (6.28)$$

where  $K_2$  = rate coefficient for the second stage  
 $K_1$  = rate coefficient for the first stage  
 $S_o$  = influent BOD or COD to stage 1  
 $S_1$  = influent BOD or COD to stage 2

The application of Eq. (6.28) can be illustrated by using data from a two-stage activated sludge plant treating a pharmaceutical wastewater. The first stage has an influent BOD of 5825 mg/l, an effluent BOD of 540 mg/l, and a  $K$  of 3.9 d<sup>-1</sup>. The influent BOD to the second stage is 540 mg/l and the  $K$  is 0.4 d<sup>-1</sup>. The calculated  $K$  in stage 2, from Eq. (6.28), is

$$\begin{aligned} K_2 &= K_1 \left( \frac{S_1}{S_o} \right) \\ &= 3.9 \left( \frac{540}{5825} \right) \\ &= 0.36 \text{ d}^{-1} \end{aligned}$$

This is in good agreement with the measured value of 0.4 d<sup>-1</sup>.

Kinetic parameters for a pulp and paper mill wastewater are shown in Table 6.6. Parameters for petroleum refinery wastewaters are shown in Table 6.7.

TABLE 6.6  
Reaction rate coefficient for pulp and paper mills

Type of mill	$K, d^{-1}$	Temperature, °C
Oxygen bleached kraft	13.5	35
Virgin pulp and wastepaper	13.6	23
Unbleached kraft	4.5	38
Sulfite	5.0	18
Bleached sulfite	6.2	—
Bleached kraft	5.2	—
Bleached kraft	4.4	34

TABLE 6.7  
Biological treatment coefficients for petroleum refinery wastewaters

Influent		Organic removal rate $K^{\dagger}$		Sludge growth coefficients				Oxygen requirements <sup>‡</sup>		Residual COD, mg/l
BOD, mg/l	COD, mg/l	BOD, $d^{-1}$	COD, $d^{-1}$	BOD basis		COD basis		$a'$	$b'X_d$	
				$a$	$bX_d$	$a$	$bX_d$			
244	509	4.15	2.74	—	—	—	—	0.57	0.1	106
575	981	—	7.97	—	—	0.5	0.06	0.60	0.11	53
396	782	—	5.86	—	—	0.5	0.06	0.34	0.06	100
153	428	—	2.92	0.5	0.08	0.44	0.1	0.35	0.08	22
170	600	—	5.0	—	—	0.26	0.03	0.46	0.05	100 <sup>§</sup>
248	563	4.11	7.79	—	—	0.2	0.08	0.40	0.01	76
345	806	—	7.24	—	—	0.43	0.10	0.52	0.14	82
196	310	4.70	—	0.6	0.05	—	—	0.46	0.14	50
138	275	—	—	0.58	—	0.25	—	0.60	0.09	42

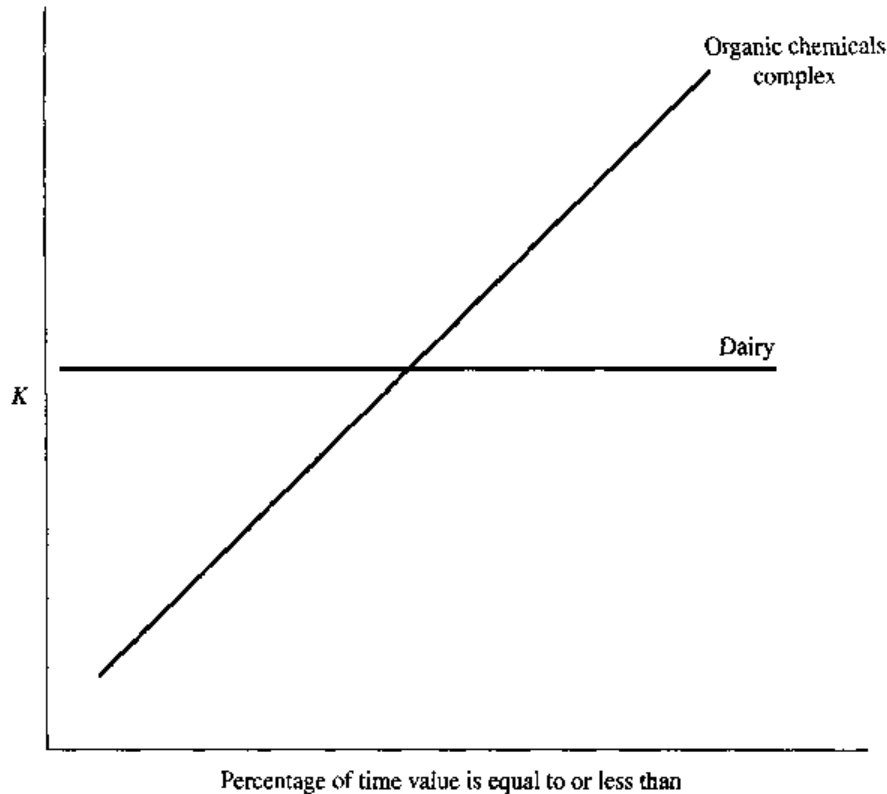
<sup>†</sup> At 24°C.

<sup>‡</sup> COD basis.

<sup>§</sup> TOD.

It is apparent that, as the organic composition of the wastewater changes the rate coefficient  $K$  in Eq. 6.26 will also change. This is not a problem for wastewaters such as those from a dairy or food processing plant since their composition remains substantially unchanged, and hence,  $K$  will remain nearly constant. Wastewaters generated from plants with multi-products and campaign production, however, will experience a constantly changing wastewater composition and, hence, a highly variable  $K$  value, as shown in Fig. 6.19.

The rate coefficient combines the effects of all removal mechanisms: biosorption, biodegradation, and volatilization, unless steps are taken to separate the effects of an individual removal mechanism. Unusually high "apparent" reaction rate coefficients may be observed when volatile organics constitute a large portion of the wastewater. Volatilization of substrate should be considered when calculated  $K$  values exceed about  $30/d^{-1}$  at 20 to 25°C.



**FIGURE 6.19**  
Variability in  $K$  as related to wastewater composition.

Industrial wastewater discharge permits typically contain two limiting conditions: a monthly average limit and a daily or weekly maximum limit. The treatment process must be designed and operated to reliably satisfy both of these discharge conditions.

A suggested design approach is based on a statistical distribution of the removal rate coefficient and the performance of the upstream equalization basin. For average discharge conditions, the mean  $K$  value is based on the average discharge limit and average influent load. These values are substituted into Eq. (6.26) to yield

$$\frac{\bar{S}_o - \bar{S}_e}{f_b X_v t} = K_{50\%} \frac{\bar{S}_e}{\bar{S}_o} \quad (6.29)$$

where  $\bar{S}_o$  = average influent BOD, mg/l

$\bar{S}_e$  = soluble BOD at average permit limit, mg/l

$K_{50\%}$  = the 50 percentile value of  $K$ ,  $d^{-1}$

For the maximum permit condition, Equation (6.29) can be expressed as

$$\frac{S_{o_m} - S_{e_m}}{f_b X_v t} = K_{5\%} \frac{S_{e_m}}{S_{o_m}} \quad (6.30)$$

where  $S_{o_m}$  = maximum effluent BOD from the equalization basin, mg/l

$S_{e_m}$  = soluble BOD at maximum permit limit, mg/l

$K_{5\%}$  = 5 percentile value of  $K$ ,  $d^{-1}$

The values of  $X_{v,t}$  are calculated for Eq. (6.29) and (6.30), and the larger of the two values is used for design. However, if the  $X_{v,t}$  value computed for the maximum permit condition exceeds twice the value computed for the average condition, changes in the equalization capacity or plant production schedules should be considered in order to reduce the difference. Alternatively, a less conservative value of  $K$  ( $> K_{5\%}$ ) could be used.

### Specific Organic Compounds

The kinetic removal mechanism for specific organics in an aerobic biological process has been defined by Monod:

$$\mu = \frac{\mu_m S}{K_S + S} \quad \text{and} \quad q = \frac{q_m S}{K_S + S} \quad (6.31)$$

where  $\mu$  = specific growth rate,  $d^{-1}$

$\mu_m$  = maximum specific growth rate,  $d^{-1}$

$S$  = substrate concentration, mg/l

$K_S$  = substrate concentration when the rate is one-half the maximum rate, mg/l

$q$  = specific substrate removal rate,  $d^{-1}$

$q_m$  = maximum substrate removal rate,  $d^{-1}$

The relative biodegradability of specific organics in terms of the Monod relationship is shown in Fig. 6.20.

In complete mix activated sludge (CMAS) with sludge recycle, the Monod equation can be expressed:

$$S_o - S = \frac{q_m S}{K_S + S} \cdot X_{vb} t \quad (6.32)$$

where  $S_o$  = influent substrate concentration, mg/l

$X_{vb}$  = biological volatile suspended solids under aeration, mg/l

$t$  = liquid retention time, d

Solving for  $S$  yields:

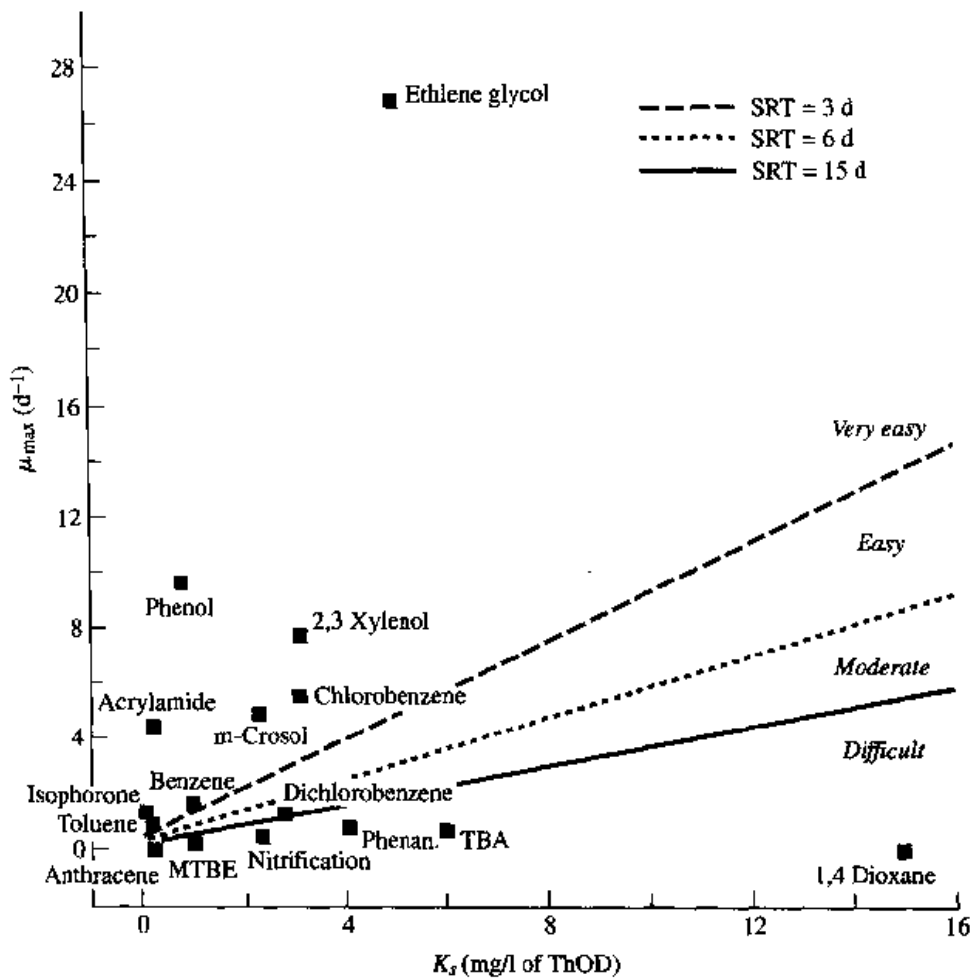
$$S = \frac{-B + (B^2 + 4S_o K_S)^{1/2}}{2} \quad (6.33)$$

in which

$$B = q_m X_{vb} t + K_S - S_o$$

The SRT in the activated sludge process for a soluble substrate can be defined as follows:

$$\theta_c = \frac{X_{vb} t}{a(S_o - S) - bX_d X_{vb} t} \quad (6.11)$$



**FIGURE 6.20** Relative biodegradability of specific organics at different SRT at 25°C (effluent concentration = 0.5 mg/l as COD and  $b = 0.11$  per day).<sup>7</sup>

where  $\theta_c = \text{SRT, d}$   
 $a = \text{yield coefficient, d}^{-1}$   
 $b = \text{endogenous coefficient, d}^{-1}$   
 $X_d = \text{degradable fraction of the VSS}$

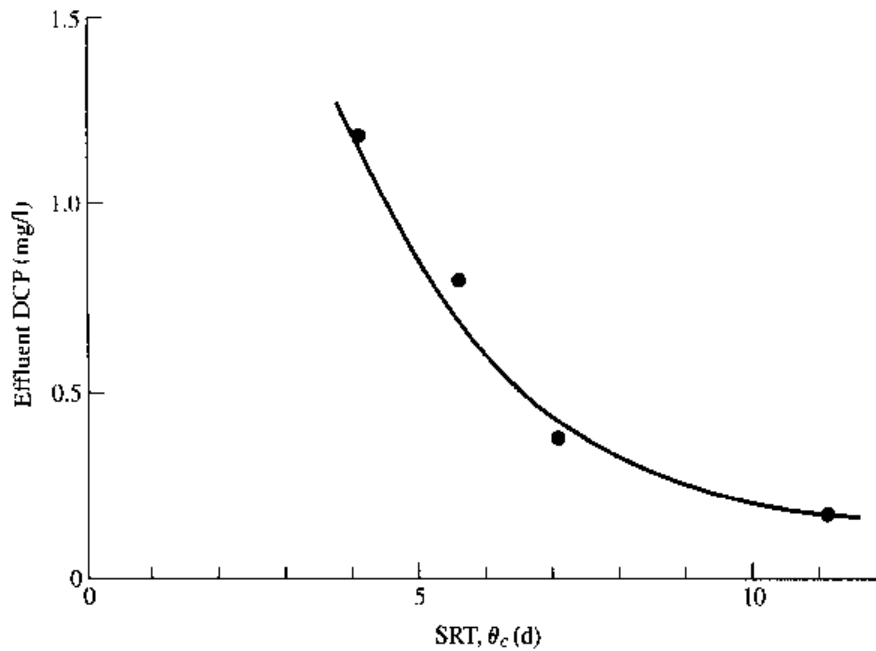
In complete mix activated sludge (CMAS), the effluent substrate concentration is directly related to the SRT ( $\theta_c$ ). Combining Eqs. (6.31) and (6.11) yields:

$$S = \frac{K_s(1 + bX_d\theta_c)}{\theta_c(a - bX_d) - 1} \quad (6.34)$$

This relationship for dichlorophenol (DCP) is shown in Fig. 6.21.

For the case of a plug flow activated sludge (PFAS) reactor with sludge recycle, the performance equation derived from the Monod relationship is:

$$\frac{1}{\theta_c} = \frac{\mu_m(S_o - S)}{(S_o - S) + CK_s} - bX_d \quad (6.35)$$

**FIGURE 6.21**

Effect of SRT on DCP removal.

where  $C = (1 + \alpha)\ln[X(\alpha S + S_o)/(1 + \alpha)S]$

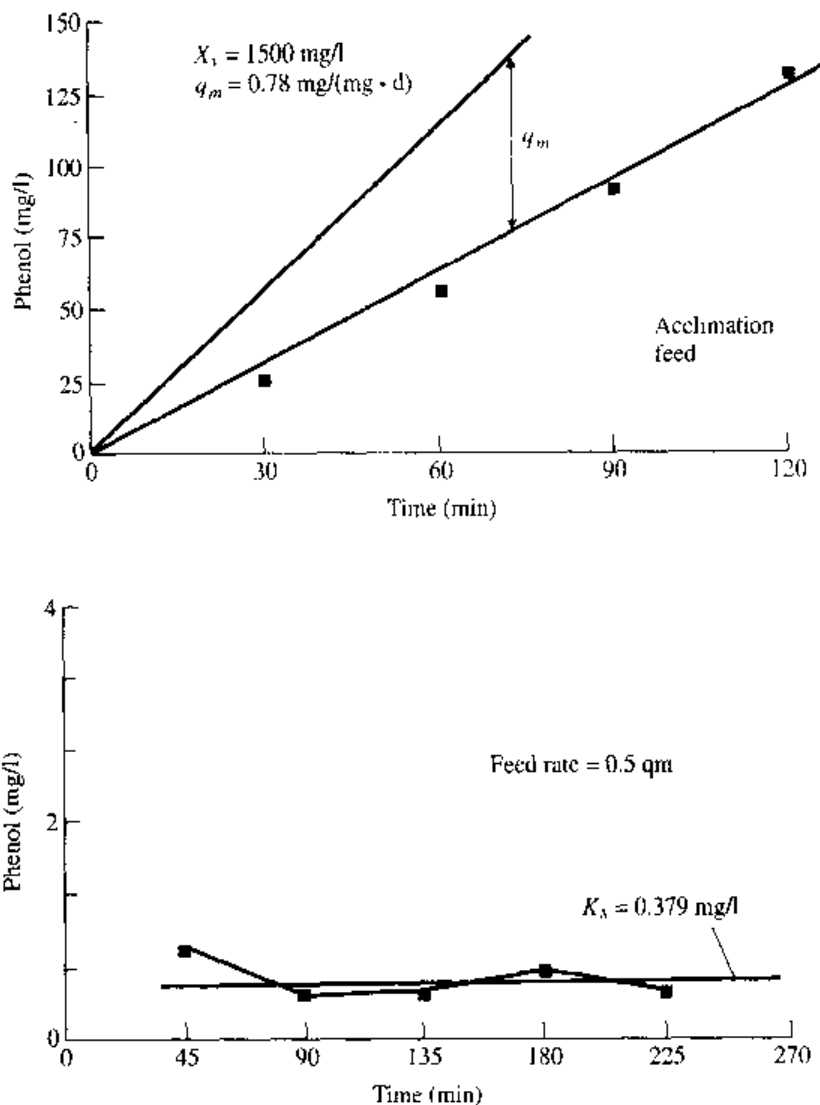
$\alpha = R/Q$

$S_o$  = influent substrate concentration prior to mixing with the recycle

Effluent levels of specific priority organics, e.g., phenol, can be computed from Eqs. (6.34) or (6.35), depending on the configuration of the reactor, complete mix or plug flow.

The modified fed batch reactor (FBR) test described by Philbrook and Grady<sup>28</sup> is applicable to the determination of the kinetic coefficients  $q_m$  and  $K_S$  under field operating conditions. In the test, plant or pilot plant sludge at the desired SRT is placed in a 2-L reactor, and plant wastewater is added at a constant rate. In order to determine  $q_m$ , the addition rate must exceed the degradation rate. Since, in many wastewaters, the priority pollutant levels are low, the wastewater may have to be spiked to ensure a sufficient concentration of pollutant to meet the conditions of the test. It is important, however, that the concentration levels achieved in the test are below the inhibition threshold. This can be found by the shape of the concentration-time curve. The degradation rate  $q_m$  is computed as the difference in the slopes of the substrate addition rate and the residual substrate accumulation.

A second FBR test is then conducted with the addition rate of the priority pollutant equal to one-half the maximum rate determined in the first test. The steady-state concentration observed in the reactor will be  $K_S$ . FBR test data for phenol are shown in Fig. 6.22. Hoover<sup>29</sup> found a high variability in  $q_m$  with sludges operating under the same loading conditions with time. Based on these observations, a rou-



**FIGURE 6.22**  
FBR test for the determination of  $q_m$  and  $K_S$ .

tine test program should be established at a treatment plant and values for  $q_m$  and  $K_S$  interpreted on a statistical basis.

In the pulp and paper industry attention is being focused on absorbable organic halides (AOX) and chlorinated phenolics in bleach plant effluents. Chlorophenols are amenable to aerobic mineralization, while methoxalated chlorophenols are recalcitrant to aerobic oxidation. Anaerobic pretreatment however, results in readily degradable aerobic forms. Table 6.8 summarizes the observed removal of pollutants from pulp and paper mill wastewaters using activated sludge (AS), facultative stabilization basins (FSB), and aerated stabilization basins (ASB). Substituting oxygen bleaching for conventional chlorine bleaching has a marked effect on the removal of both AOX and chlorinated phenolics as shown in Table 6.9.



TABLE 6.8  
Removal performance summary for conventional pollutants and AOX

Parameter	50th and (90th) percentile values		
	AS	FSB	ASB
Conventional			
COD removal, %	54 (65)	55 (78)	57 (68)
BOD removal, %	96 (98)	96 (98)	96 (98)
NH <sub>4</sub> -N <sub>eff</sub> , mg/l	1.5 (10.1)	0.25 (5.8)	0.25 (4.5)
(NO <sub>2</sub> + NO <sub>3</sub> )-N <sub>eff</sub> , mg/l	1.4 (8.0)	4.3 (11.1)	8.0 (13.2)
VSS <sub>eff</sub> , mg/l	32 (110)	62 (200)	75 (200)
AOX			
Total AOX removal, %	22 (1.7)	43 (1.3)	40 (1.3)
Filt-AOX removal, %	28 (1.5)	48 (1.2)	45 (1.2)
(Nonfilt-AOX/total AOX) <sub>eff</sub> , %	8 (1.9)	8 (1.9)	8 (1.9)
(Nonfilt-AOX/CSS) <sub>eff</sub> , mg/g	45 (2.8)	28 (1.9)	20 (2.6)

TABLE 6.9  
Comparison of conventional and oxygen bleaching on  
activated sludge performance (kraft hardwood)<sup>30</sup>

Parameter	Reduction (%) for bleaching process	
	Conventional	Oxygen
AOX	22 <sup>†</sup>	40 <sup>†</sup>
Chlorinated Phenols		
Phenol	39	45
Guajacols	41	79
Catacols	50	63

<sup>†</sup> Based on influent AOX concentrations of 136 mg/l and 57 mg/l.

**EXAMPLE 6.8.** Compute the SRT required in a complete mix activated sludge plant to reduce phenol from  $S_o = 10$  mg/l to  $15 \mu\text{g/l}$ , where:

$$q_m = 1.8 \text{ g/(g VSS} \cdot \text{d) at } 20^\circ\text{C}$$

$$\theta = 1.1 \text{ (temperature coefficient)}$$

$$K_S = 100 \mu\text{g/l}$$

$$a = 0.6$$

$$bX_d = 0.05 \text{ d}^{-1} \text{ at } 20^\circ\text{C} = 0.033 \text{ at } 10^\circ\text{C}$$

**Solution.**

Equation (6.34) can be rearranged to yield

$$\theta_c = \frac{K_S + S}{aq_m S - bX_d(K_S + S)}$$

$$\begin{aligned}
 &= \frac{0.1 + 0.015}{0.6 \cdot 1.8 \cdot 0.015 - 0.05(0.115)} \\
 &= 11.0 \text{ d}
 \end{aligned}$$

What is the required SRT if the temperature is reduced from 20°C to 10°C?

$$\begin{aligned}
 q_{m(10^\circ)} &= q_{m(20^\circ)} \cdot 1.1^{-10} \\
 &= 1.8/2.6 \\
 &= 0.69 \text{ d}^{-1} \\
 \theta_c &= \frac{0.1 + 0.015}{0.6 \cdot 0.69 \cdot 0.015 - 0.033(0.115)} \\
 &= 47.6 \text{ d}
 \end{aligned}$$

In practice in a majority of cases, a high degree of back-mixing takes place so that conditions in a plug flow tank may approach that of complete mixing. However, in order to take advantage of the kinetics of priority pollutant removal, multiple basins in series will offer distinct advantages over a single complete mix basin.

Equation (6.34) can be applied to predict the performance of multiple reactors in series as shown by the following example.

**EXAMPLE 6.9.** Design a single-stage and a three-stage activated sludge reactor to reduce phenol. Compute the effluent phenol level in each case.

$$\begin{aligned}
 S_o &= 10 \text{ mg/l} \\
 bX_d &= 0.05 \\
 \theta_c &= 10 \text{ d} \\
 q_m &= 0.6 \\
 K_S &= 0.2 \\
 a &= 0.6
 \end{aligned}$$

**Solution.**

For the CMAS (one stage),  $X_{v,t} = 39.44 \text{ mg/(l} \cdot \text{d)}$  is computed from Eqs. (6.32) and (6.33).

$$\begin{aligned}
 B &= 0.6(39.44) + 0.2 - 10 \\
 &= 13.86
 \end{aligned}$$

$$\begin{aligned}
 S &= \frac{-13.86 + [(13.86)^2 + 4 \cdot 10 \cdot 0.2]^{1/2}}{2} \\
 &= 0.14 \text{ mg/l}
 \end{aligned}$$

Hence,  $S$  for a single complete mix basin is 0.14 mg/l. We can now compute the performance of three basins in series. Each basin is considered as a complete mix basin in which the retention time is based on  $(Q + R)$ . The effluent from the third

basin is assumed negligible. The concentration entering the first basin with a 50 percent recycle is

$$\begin{aligned} S_o &= \frac{10}{1.5} \\ &= 6.67 \text{ mg/l} \end{aligned}$$

For the same total basin volume as in the complete mix case,  $X_{v,t}$  is reduced by a factor of 1.5:

$$\begin{aligned} X_{v,t} &= 39.44/3 \cdot 1.5 \\ &= 8.76 \text{ mg/(l}\cdot\text{d)} \\ B &= 0.6 \cdot 8.76 + 0.2 - 6.67 \\ &= -1.21 \\ S &= \frac{-1.21 + [1.21^2 + 4 \cdot 0.2 \cdot 6.67]^{1/2}}{2} \\ &= 1.9 \text{ mg/l} \end{aligned}$$

In like manner, the effluent ( $S$ ) from basin 2 is computed as 0.105 mg/l and from basin 3 as 0.005 mg/l.

### 6.3 EFFECT OF TEMPERATURE

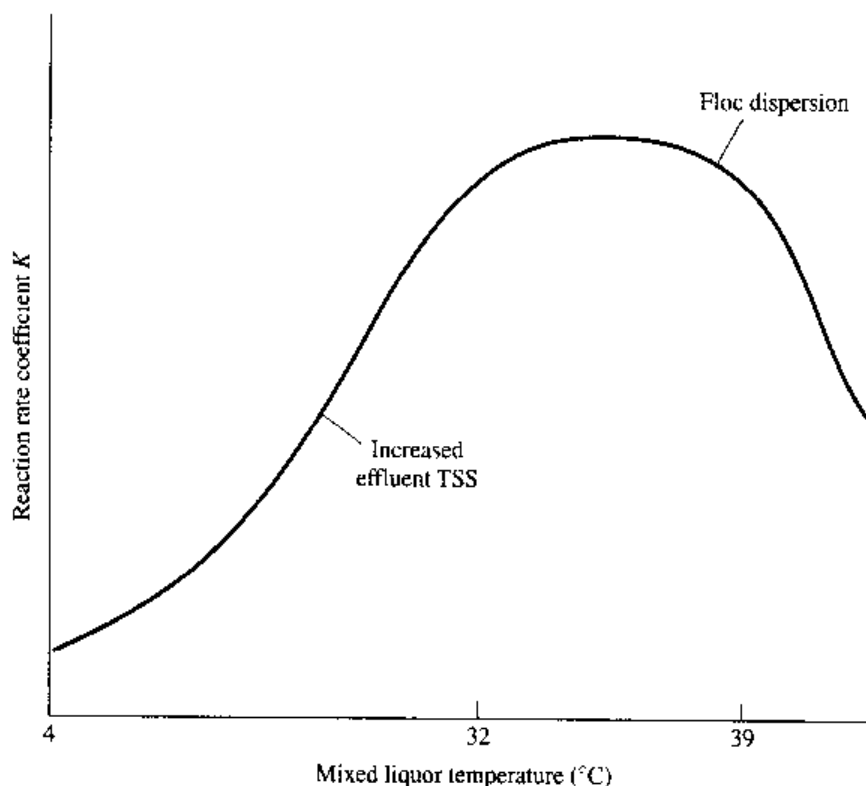
Variations in temperature affect all biological processes. There are three temperature regimes: the mesophilic over a temperature range of 4 to 39°C, the thermophilic which peaks at a temperature of 55°C, and the psychrophilic which operates at temperatures below 4°C. For economic and geographical reasons, most aerobic biological treatment processes operate in the mesophilic range, which is shown in Fig. 6.23. In the mesophilic range, the rate of the biological reaction will increase with temperature to a maximum value at approximately 31°C for most aerobic waste systems. A temperature above 39°C will result in a decreased rate for mesophilic organisms.

Over a temperature range of 4 to 31°C

$$K_t = K_{20^\circ} \cdot \theta^{T-20} \quad (6.36)$$

The temperature coefficient  $\theta$  has been found to vary from 1.03 to 1.1 for a variety of industrial wastewaters. This relationship for a chemical wastewater is shown in Fig. 6.24 and for a bleached sulfite mill in Fig. 6.25.

It should be noted that the temperature coefficient  $\theta$  for municipal wastewater has a value of 1.015, showing relatively little effect. This is because a major portion of the BOD is present as colloidal or suspended organics, which are biocoagulated with very little temperature effect. When industrial wastewaters are discharged to municipal systems, the soluble organic content is increased and hence the temperature coefficient  $\theta$  is also increased.

**FIGURE 6.23**

Effect of temperature on biological oxidation rate constant  $K$ .

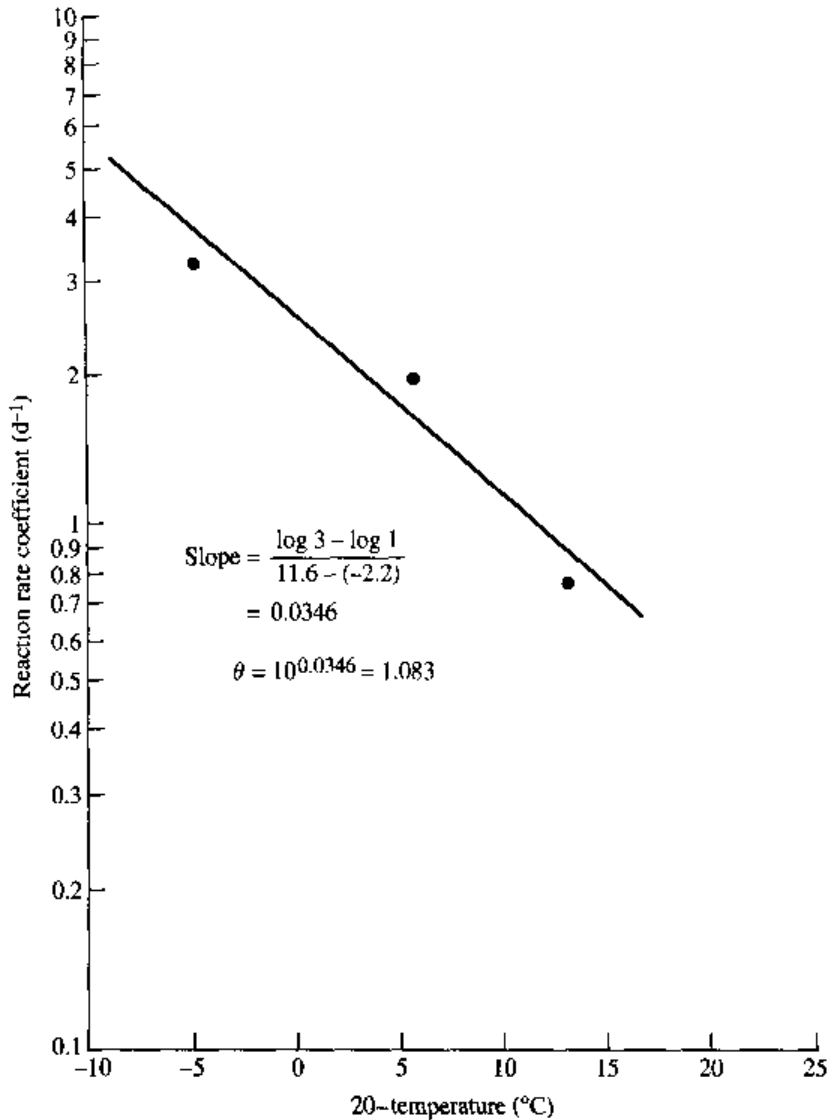
Decreasing aeration basin temperature will also cause an increase in effluent suspended solids. The solids are of a dispersed nature and are nonsettleable. For example, the Union Carbide plant at South Charleston, West Virginia, had an effluent suspended solids of 42 mg/l during the summer and 104 mg/l during the winter. Removal of these suspended solids requires the addition of coagulating chemicals (see p. 371).

The endogenous coefficient  $b$  is also affected by temperature through the relationship

$$b_T = b_{20^\circ\text{C}} \cdot 1.04^{T-20} \quad (6.37)$$

At temperatures above 96°F (35.5°C) there is a deterioration in the biological floc. Protozoa have been observed to disappear at 104°F (40°C) and a dispersed floc with filaments to dominate at 110°F (43.3°C).

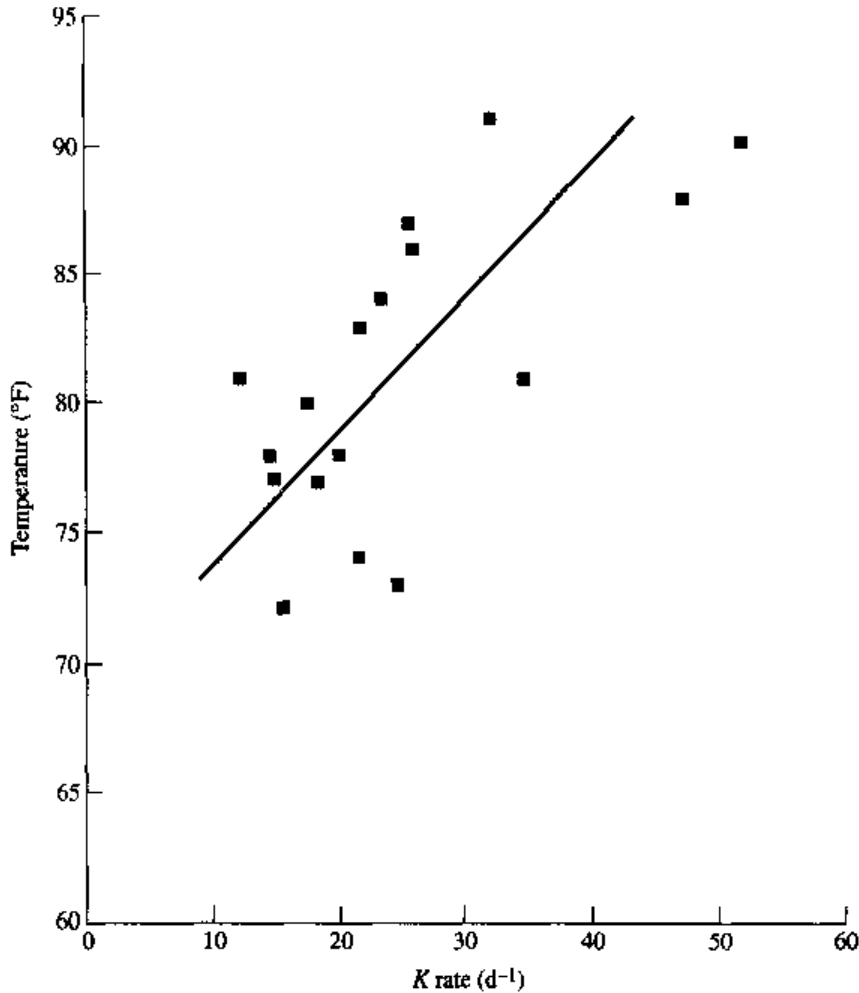
In the past, hot wastewaters such as those in the pulp and paper industry were pretreated through a cooling tower so that the aeration basin temperature did not exceed 35°C. Recent air pollution regulations preclude stripping in a cooling tower without off-gas treatment. As a result, in many cases, the aeration basins must be covered and the off-gas treated. The consequence of this is a substantial temperature rise in the aeration basin due to the heat release from the exothermal biological reaction. In a recent study on a pharmaceutical wastewater, the average heat release was calculated as high as 5000 Btu/lb COD removed.

**FIGURE 6.24**

Effect of temperature on the reaction rate coefficient  $K$  for an agricultural chemicals wastewater.

In one case of a pulp and paper mill effluent, the aeration basin temperature reached 43°C. The characteristics of the sludge at 35°C and 43°C are shown in Fig. 6.26. One can see in Fig. 6.26 the absence of protozoans and the presence of filaments and dispersed floc at 43°C. The relationship between zone settling velocity and temperature is shown in Fig. 6.27. The net effect is a flux limitation on the final clarifier, resulting in decreased plant performance.

In a second case of an agricultural chemicals wastewater, floc dispersion resulted at an aeration basin temperature of 36°C. In order to maintain plant performance, massive polymer doses were required. The problem was solved by installing heat exchangers on the influent wastewater so that the influent temperature did not exceed 30°C. In a third case, treatment of a high-strength synfuels wastewater resulted in basin temperatures of 44°C during the summer months. Plant performance is shown in Fig. 6.28.

**FIGURE 6.25**

Effect of temperature on the reaction rate for a bleached sulfite mill wastewater.

**EXAMPLE 6.10.** Estimate the maximum influent temperature for a wastewater with the following characteristics.

Influent degradable COD,  $S_o = 2580$  mg/l

Effluent degradable COD,  $S_e = 70$  mg/l

Reaction rate coefficient  $K = 5.0$  d<sup>-1</sup>

MLVSS,  $X_v = 3000$  mg/l

Wastewater flow  $Q = 1$  million gal/d

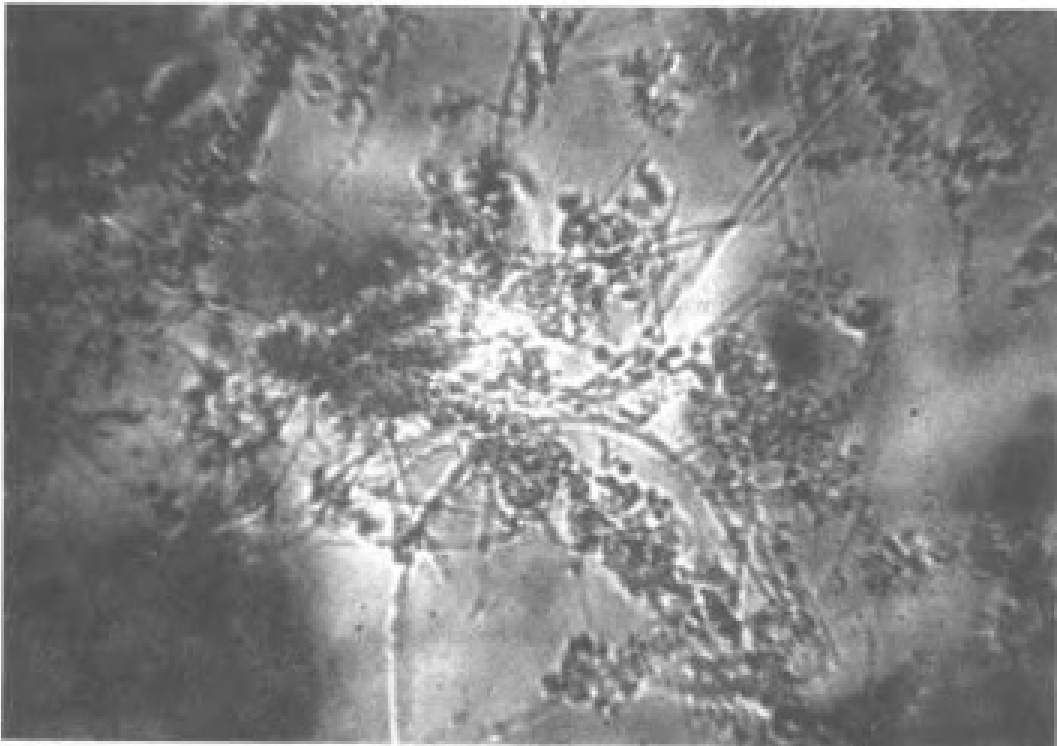
**Solution.**

The required aeration detention time can be calculated:

$$\begin{aligned}
 t &= \frac{S_o(S_o - S_e)}{KX_v S_e} \\
 &= \frac{2580(2580 - 70)}{5 \cdot 3000 \cdot 70} \\
 &= 6.1 \text{ d}
 \end{aligned}$$

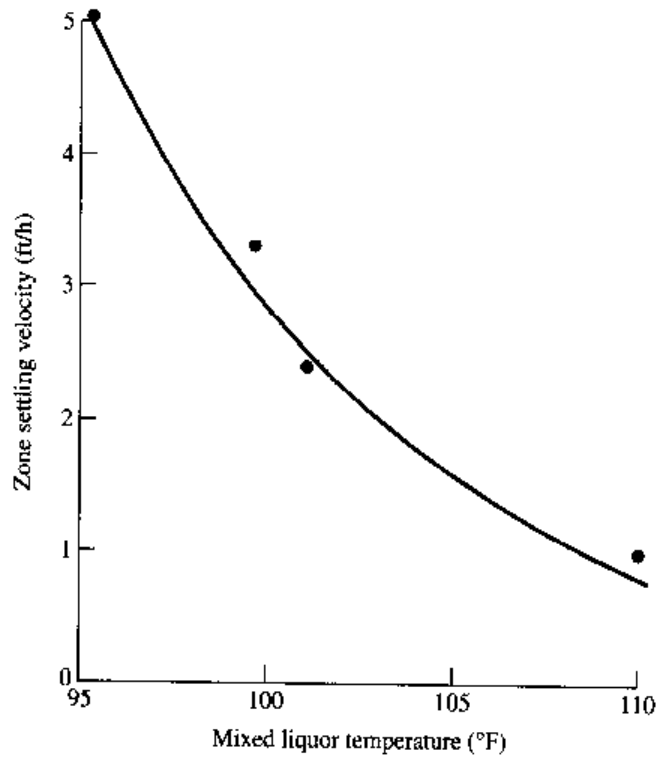


(a)



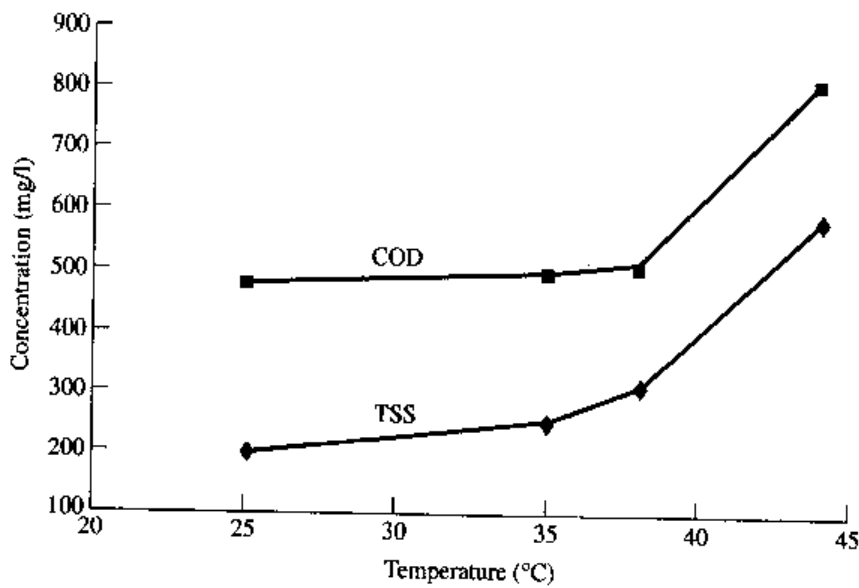
(b)

**FIGURE 6.26**  
Sludge characteristics at (a) 35°C and (b) 43°C.



ft/h = 0.305 m/h  
 $^{\circ}\text{F} = 0.555 (^{\circ}\text{F} - 32) ^{\circ}\text{C}$

**FIGURE 6.27**  
 Effect of mixed liquor temperature on the zone settling velocity of activated sludge pulp and paper wastewater.



**FIGURE 6.28**  
 Effect of mixed liquor temperature on effluent quality.



The  $F/M$  is:

$$\begin{aligned} F/M &= \frac{S_o}{X_v t} \\ &= \frac{2580}{3000 \cdot 6.1} \\ &= 0.14 \text{ d}^{-1} \end{aligned}$$

The aeration basin volume is 6.1 million gal. The heat loss from a concrete basin can be calculated assuming a total basin surface area of 56,650 ft<sup>2</sup>.

If we assume the basin temperature at 96°F and an average air temperature of 85°F during the summer months, the heat loss can be estimated:

$$q \text{ (Btu/h)} = UA\Delta T$$

where  $U$  = overall heat transfer coefficient, assumed as 0.35 Btu/ft<sup>2</sup> · °F · h  
 $A$  = exposed surface area  
 $\Delta T$  = difference between the basin and air temperature  
 $= 0.35 \cdot 56,650 \cdot 11$   
 $= 218,102 \text{ Btu/h} = 5.2 \times 10^6 \text{ Btu/d} \text{ (5.5 KJ/d)}$

The heat generated can be calculated by assuming that 5000 Btu is generated per pound of COD removed. COD removed is:

$$(2580 \cdot 70) \cdot 1 \cdot 8.34 = 20,933 \text{ lb/d (9500) kg/d}$$

The Btu generated is:

$$20,933 \cdot 5000 \text{ Btu/16 COD}_{\text{rem}} = 104.6 \times 10^6 \text{ Btu/d}$$

The net Btu increase is:

$$104.6 - 5.2 = 99.4 \times 10^6 \text{ Btu/d}$$

The temperature increase can be calculated:

$$\frac{99.4 \times 10^6 \text{ Btu/d}}{1 \text{ Btu/lb} \cdot \text{°F} \times 8.34 \times 10^6} = 11.9\text{°F} \quad (6.6\text{°C})$$

Under these conditions, the maximum allowable influent temperature is:

$$96 - 11.9 = 84.1\text{°F} \quad (29\text{°C})$$

### Effect of pH

A relatively narrow effective pH range will exist for most biooxidation systems. For most processes, this covers a range of pH 5 to 9 with optimum rates occurring over the range pH 6.05 to 8.5. It is significant to note that this relates to the pH of the mixed liquor in contact with the biological growths and not the pH of the waste entering the system. The influent waste is diluted by the aeration tank contents and is neutralized by reaction with the CO<sub>2</sub> produced by microbial respiration. In the case of both caustic and acidic wastes, the end product is bicarbonate (HCO<sub>3</sub><sup>-</sup>), which effectively buffers the aeration system at near pH 8.0. Application of the complete mixing concept is essential in order to take advantage of these reactions.

The amount of caustic that can be present in a wastestream is related to the BOD removal, which in turn will determine the  $\text{CO}_2$  produced for reaction with the caustic. If we consider 0.9 lb or kg of  $\text{CO}_2$  produced per lb or kg of COD removed (assuming conventional loadings) and 70 percent of this is reactive with caustic alkalinity present, then 0.63 lb or kg of caustic alkalinity (as  $\text{CaCO}_3$ ) will be neutralized per pound or kilogram of COD removed.

Since the oxidation of organic acids results in the production of  $\text{CO}_2$ , the permissible concentration of organic acids in the wastestream is related to the reaction rate of acid degradation to  $\text{CO}_2$ .

As long as the buffering capacity of the process is maintained, the pH of the aeration tank contents should remain near pH 8.0, even under conditions of fluctuating caustic or acidic loads.

## Toxicity

Toxicity in biological oxidation systems may have any of several causes:

1. An organic substance, such as phenol, which is toxic in high concentrations, but biodegradable in low concentrations.
2. Substances such as heavy metals that have a toxic threshold depending on the operating conditions.
3. Inorganic salts and ammonia, which exhibit a retardation at high concentrations.

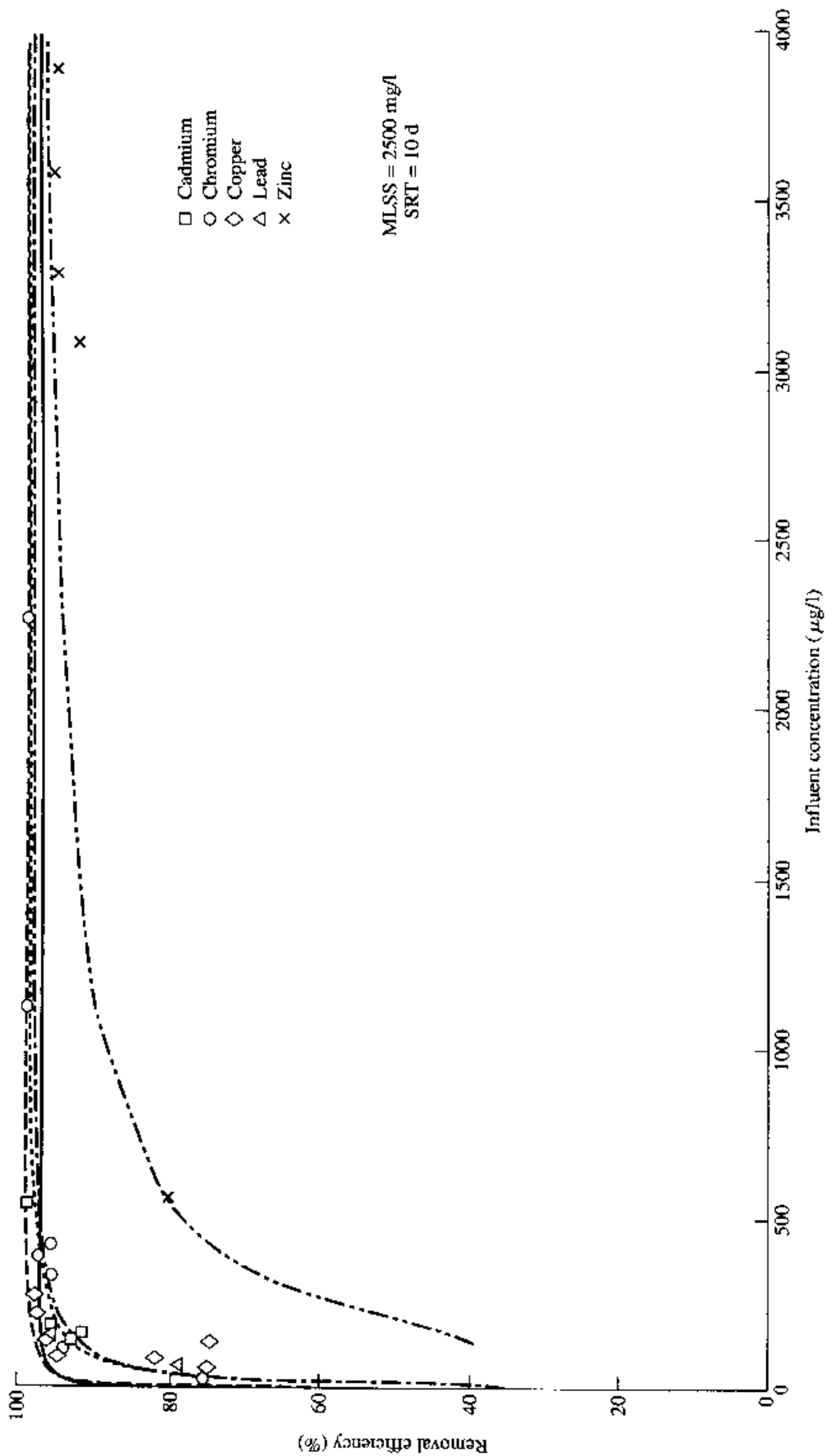
The toxic effects of organics can be minimized by employing the complete mixing system, in which the influent is diluted by the aeration tank contents and the microorganisms are in contact only with the effluent concentration. In this way wastes with concentrations many times the toxic threshold can be successfully treated.

Heavy metals exhibit a toxicity in low concentrations to biological sludges. Acclimation of the sludge to the metal, however, will increase the toxic threshold considerably.

While an acclimated biological process is tolerant of the presence of heavy metals, the metal will concentrate in the sludge by complexing with the cell wall. Metal concentrations in the sludge as high as 4 percent have been reported. Data on heavy metal removal from petroleum refinery wastewater is shown in Table 6.10. Data on removal of metals at low concentration in a municipal plant is shown in Fig. 6.29.

TABLE 6.10  
Heavy metals removal in the activated sludge process  
treatment of petroleum refinery wastewater

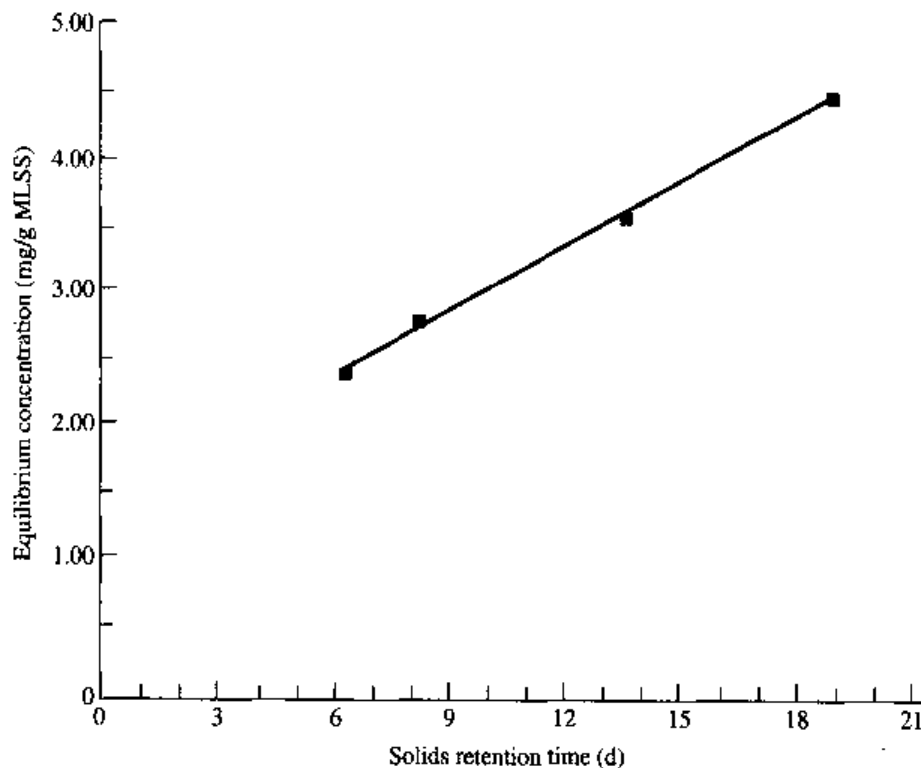
Heavy metal	Activated sludge plant	
	Influent, mg/l	Effluent, mg/l
Cr	2.2	0.9
Cu	0.5	0.1
Zn	0.7	0.4



**FIGURE 6.29**  
 Heavy metals removal from municipal sewage in the activated sludge process.

This in turn creates problems relative to ultimate sludge disposal. The accumulation of copper on activated sludge with increasing sludge age is shown in Fig. 6.30.

High concentrations of inorganic salts are not toxic in the conventional sense, but rather exhibit progressive inhibition and a decrease in rate kinetics. Biological sludges, however, can be acclimated to high concentrations of salt. Processes are successfully operating with as high as 6 percent salt by weight. Frequently, high salt content will increase the effluent suspended solids. The effect of high salt concentration on suspended solids is shown in Table 6.11, which indicates that most of the biomass was nonfloculated. Monovalent ions such as  $\text{Na}^+$  and  $\text{K}^+$  will disperse the biological flocs while divalent ions such as  $\text{Ca}^{2+}$  and  $\text{Mg}^{2+}$  will tend to aid flocculation.<sup>32</sup>



**FIGURE 6.30**

Copper accumulation in the activated sludge process as a function of solids retention time.

**TABLE 6.11**  
Effect of high salt content on process performance

Influent		Effluent			
COD, mg/l	COD <sub>p</sub> , mg/l	COD <sub>e</sub> , mg/l	VSS, mg/l <sup>†</sup>	VSS, mg/l <sup>‡</sup>	TDS, mg/l
6437	1182	181	50	597	44,000

<sup>†</sup> 1.5-micron filter

<sup>‡</sup> 0.45-micron filter

## 6.4 SLUDGE QUALITY CONSIDERATIONS

One of the factors essential to the performance of the activated sludge process is effective flocculation of the sludge, with subsequent rapid settling and compaction. McKinney<sup>12</sup> related flocculation to the food/microorganism ratio and showed that certain organisms normally present in activated sludge deflocculate rapidly under starvation conditions. More recently, it has been shown that flocculation results from the production of a sticky polysaccharide slime layer to which organisms adhere. Flagellates are also entrapped in this slimy material. Filamentous organisms are present in most activated sludges (exceptions are found in the chemical and petrochemical industry).

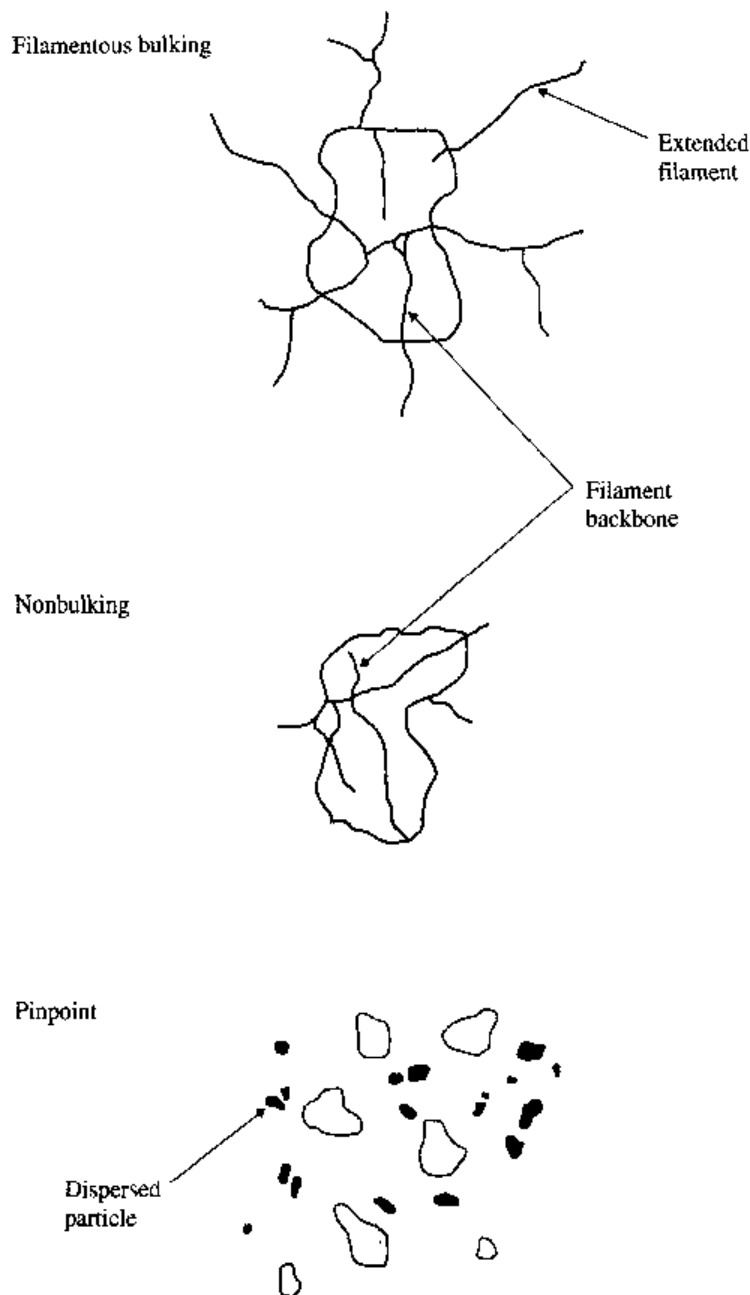
Palm, Jenkins, and Parker<sup>33</sup> have identified three generic types of activated sludge, as shown in Fig. 6.31. Nonbulking sludge will result from plug flow or selector plant configuration or from complex organic wastewaters. Bulking sludges result from degradable wastewaters treated in a complete mix process or from oxygen or nutrient deficiencies. Pin floc usually results from low  $F/M$  (long sludge age) operation.

A number of filamentous organisms have been identified in activated sludge treating municipal and industrial wastewaters. Depending on process operating conditions, one or more of these organisms may dominate in the process, as shown in Table 6.12. Identification and control of filaments have been reported. Filament types found in various industrial wastewaters are shown in Table 6.13.<sup>34</sup> Proper process design and operation should not permit the filaments to overgrow the floc formers.

Filamentous overgrowth is affected by:

1. *Wastewater composition.* Wastewaters containing glucoselike saccharides (glucose, saccharin, lactose, maltose, etc.) promote filamentous growth while laundry, textile, and complex chemical wastewaters inhibit filamentous growth in a completely mixed system. In general, the more readily degradable the substrate, the more prone the system is to filamentous bulking. This can broadly be related to the reaction rate coefficient  $K$  as shown in Table 6.14.
2. *Dissolved oxygen concentration.* Oxygen must diffuse into the floc in order to be available to the organisms within the floc. The depth of oxygen penetration within the floc depends on the bulk concentration of oxygen in the surrounding liquid and on the oxygen-utilization rate of the floc. The oxygen-utilization rate is proportional to the organic loading ( $F/M$ ). Hence, as the organic loading increases, the dissolved oxygen necessary to maintain a fully aerobic floc also increases. The thin filaments (1 to 4  $\mu\text{m}$ ) can readily obtain oxygen at concentrations less than 0.1 mg/l. The relationship between dissolved oxygen concentration to maintain a fully aerobic floc and  $F/M$  developed from the data of Palm, Jenkins, and Parker<sup>33</sup> is shown in Fig. 6.32. Performance data from a pulp and paper mill is shown in Fig. 6.33.

With degradable substrates at low concentrations, the filaments tend to grow. This explains why complete mix systems with low mixed liquor substrate concentrations favor filamentous growth.



**FIGURE 6.31**  
Activated sludge characteristics.

One of the more common causes of filamentous bulking in industrial wastewaters is inadequate nitrogen or phosphorus. There are numerous examples, particularly in the pulp and paper industry, in which severe filamentous bulking resulted from inadequate nitrogen. This is shown in Fig. 6.34. Restoration of adequate nitrogen restored a flocculated sludge within three sludge ages. Studies on a Wisconsin pulp mill indicated a minimum concentration of  $\text{NH}_3\text{-N}$  in the effluent of 1.5 mg/l to favor zoogeal growth. Other studies indicate that higher ammonia concentrations may be required in some cases. Minimum soluble phosphorus concentrations in the effluent of 0.5 mg/l have been reported as required for optimal zoogeal growth.

TABLE 6.12

## Dominant filament types as indicators of activated sludge operational problems

Suggested causative conditions	Indicative filament types
Low dissolved oxygen (DO)	Type 1701, <i>S. natans</i> , <i>H. hydrossis</i>
Low food/mass ratio ( <i>F/M</i> )	<i>M. parvicella</i> , <i>H. hydrossis</i> , <i>Nocardia</i> spp., types 021N, 0041, 0675, 0092, 0581, 0961, and 0803
Septic wastewater sulfides	<i>Thiothrix</i> spp., <i>Beggiatoa</i> spp., and type 021N
Nutrient deficiencies	<i>Thiothrix</i> spp., <i>S. natans</i> , type 021N, and possibly <i>H. hydrossis</i> and types 0041 and 0675
Low pH	Fungi

TABLE 6.13<sup>14</sup>

## Filament types found in industrial wastewaters

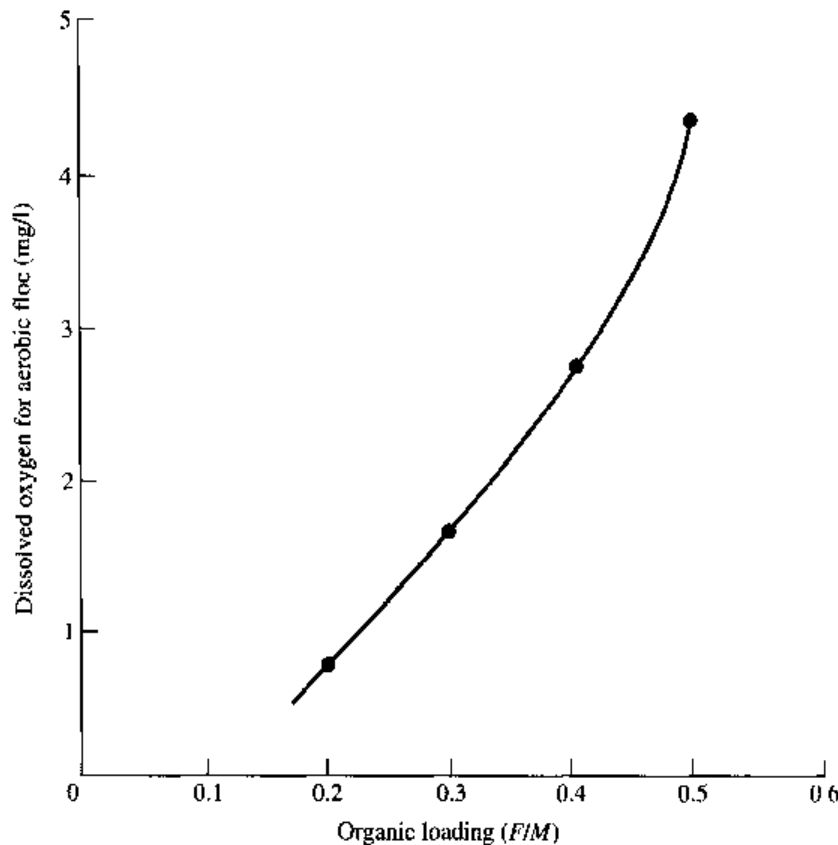
	<i>S. natans</i>	Type 1701	<i>H. hydrossis</i>	Type 021N	<i>Thiothrix</i> I and II	Type 1851	Type 0581	Type 0041	Type 0803	Type 0675	Type 0211	Type 0092	Type 0914	<i>M. parvicella</i>	<i>N. limicola</i>	Type 0411	<i>Nocardia</i>
Food processing and brewing	•	•	•	•	•												•
Textile					•	•	•		•			•					
Slaughterhouse and meat processing	•	•	•	•	•									•			•
Petrochemical	•	•	•		•												•
Organic chemicals				•	•							•	•				•
Pulp and paper mill	•	•	•	•	•	•	•	•	•	•	•	•	•	•	•	•	•

TABLE 6.14

## Composite reaction rate coefficients for industrial wastewaters

Wastewater characteristics	$K_{20^{\circ}\text{C}}, \text{d}^{-1}$
Readily degradable (food process, brewery)	16–30
Moderately degradable (petroleum, pulp and paper)	8–15
Poorly degradable (chemical, textile)	2–6

Therefore deficiency in substrates, such as the macro- or micronutrient concentration, residual soluble BOD, and/or dissolved oxygen concentration in the biological floc, can promote filamentous growth and sludge bulking. To illustrate these effects, consider the transfer of dissolved oxygen to the hypothetical biological floc particles, as illustrated in Fig. 6.35. Oxygen must diffuse from the bulk liquid through the floc in order to be available to the organisms within the interior of the floc particle. As it diffuses, it is consumed by the organisms within the floc.



**FIGURE 6.32**  
Relationship between dissolved oxygen and  $F/M$  for an aerobic floc.<sup>33</sup>

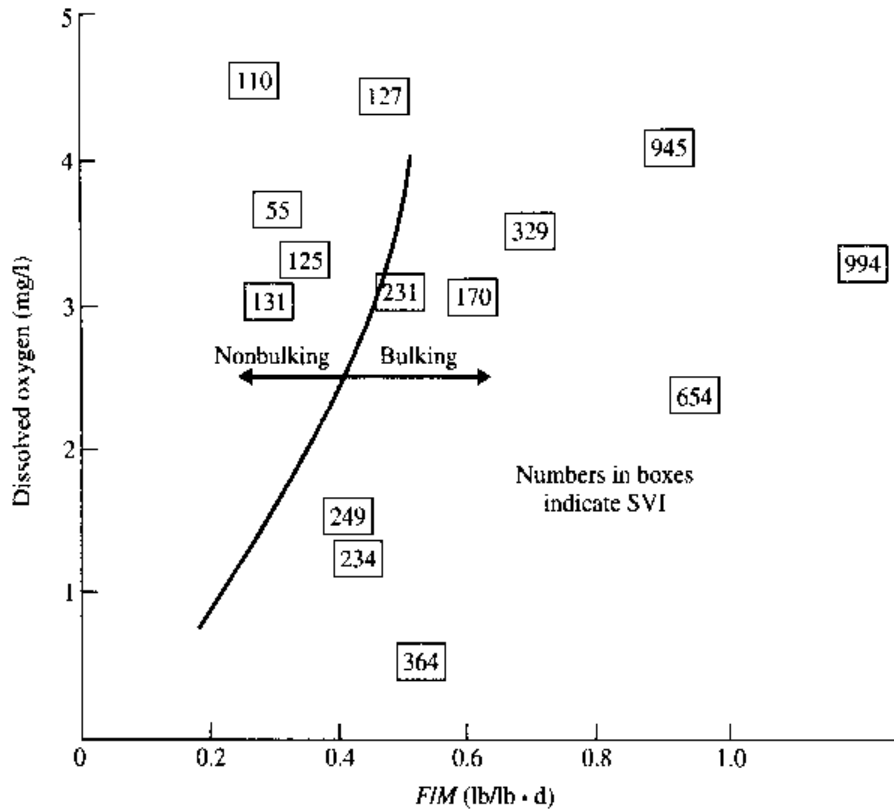
If there is an adequate residual of dissolved oxygen (and nutrients and organics), the rate of growth of the floc-forming organisms will exceed that of the filaments, and a flocculant well-settling sludge will result. If there is a deficiency in any of these substrates, however, the filaments, having a high surface area to volume ratio, will have a “feeding” advantage over the floc formers and will proliferate because of their higher growth rate under the adverse conditions.

Considering Case 1 in Fig. 6.35 at an  $F/M$  of  $0.1 \text{ d}^{-1}$ , the oxygen utilization rate is low, and even with a bulk liquid dissolved oxygen concentration of  $1.0 \text{ mg/l}$ , oxygen will fully penetrate the floc. Under these conditions, the floc formers will outgrow the filaments. In Case 2, the  $F/M$  is increased to  $0.4 \text{ d}^{-1}$ , causing a corresponding increase in oxygen uptake rate. If the bulk mixed liquor dissolved oxygen is maintained at  $1.0 \text{ mg/l}$ , the available oxygen will be rapidly consumed at the periphery of the floc, thus depriving a large interior portion of the floc particle of oxygen. Since the filaments have a competitive growth advantage at low dissolved oxygen levels, they will be favored and will outgrow the floc formers.

### Filamentous Bulking Control

The bulk mixed liquor SBOD concentration must be sufficient to provide a driving force to penetrate the biological floc. In a complete mix basin, the concentration of





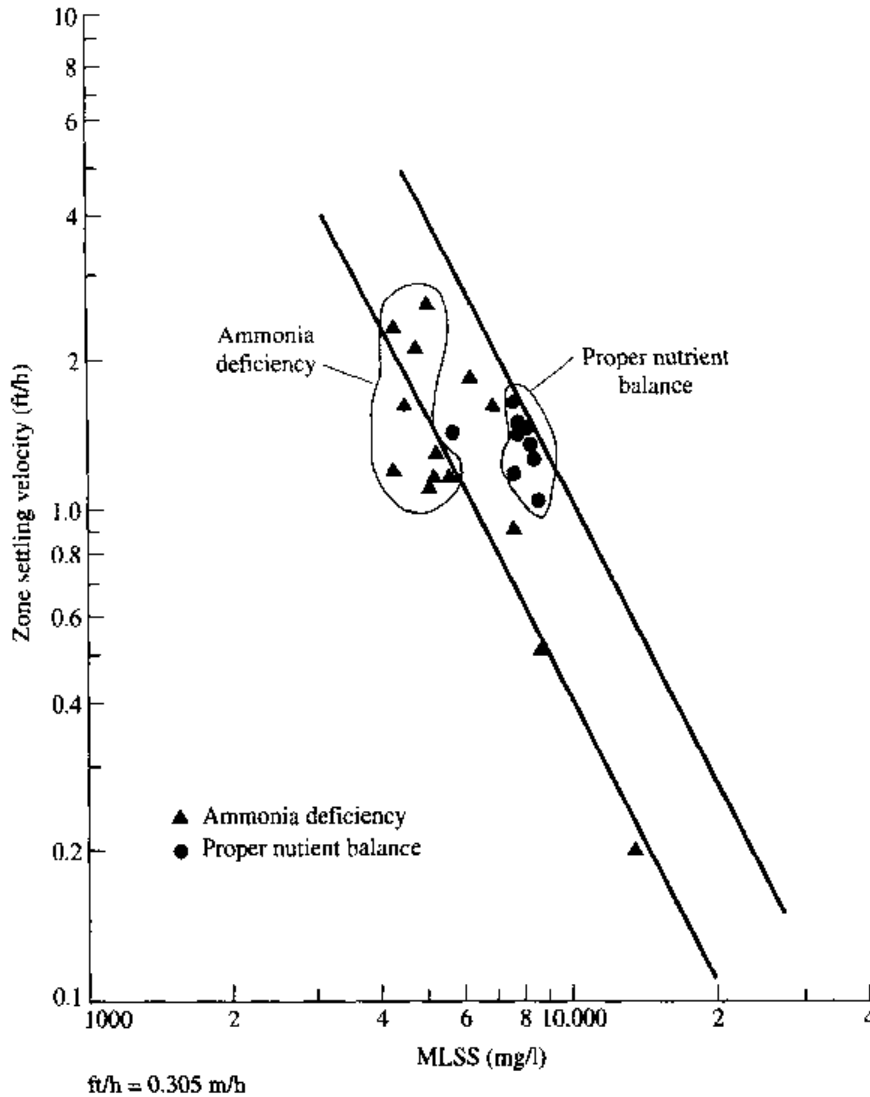
**FIGURE 6.33**

Relationship between  $F/M$  and dissolved oxygen relative to sludge bulking for a pulp and paper mill wastewater.

soluble BOD in the mixed liquor is essentially equal to the effluent concentration and is, therefore, low ( $< 10$  mg/l) for readily degradable wastewaters. As a result, substrate penetration of the floc is not achieved, and filaments dominate the interior floc population. In order to shift the population in favor of the floc formers, sufficient driving force must be developed to penetrate the floc and favor their growth. This can be achieved by a batch or plug flow operating configuration in which a high substrate gradient (driving force) exists. Maximum growth of floc formers occurs at the influent end of the plug flow basin or in the initial period of each feed cycle of a batch activated sludge process.

### Biological Selectors

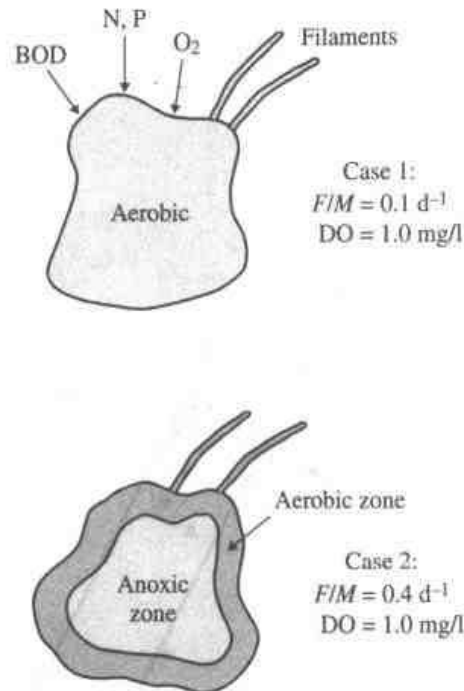
A biological selector may be used for filament control instead of a plug flow or batch treatment process. In the selector, a significant portion of the soluble substrate removal occurs by biosorption. Under these conditions, the substrate gradient is high and promotes the growth of floc formers over the filaments since they have a high "sorption" capacity, whereas the filamentous organisms do not. When the wastewater is discharged from the selector to the downstream CMAS, the sol-



**FIGURE 6.34**  
Effect of ammonia deficiency on zone settling velocity.

uble substrate concentration is relatively low and is available for utilization by both the floc formers and the filaments. The filaments do not predominate in the mixed liquor, however, since the principal mass of substrate removed in the selector has been initially directed to storage and subsequent growth of floc-forming biomass.

Results from parallel treatment studies of a grapefruit processing wastewater are shown in Table 6.15. Reactors 1 and 2 used an aerobic selector followed by a completely mixed aeration basin, whereas reactor 3 used a plug flow regime aeration basin. In all three cases, the SVI was below 100 ml/g, with effluent BOD concentrations ranging from 4 to 18 mg/l. The plug flow reactor, however, produced a sludge that was more readily dewatered and had superior thickening properties. A parallel complete mix activated sludge process (without selector) that was operated at the same organic loading rate as these systems suffered severe bulking problems and was shut down because it was inoperable.



**FIGURE 6.35**  
A mechanism of sludge bulking.

### Design of Aerobic Selectors

Several methods have been proposed for process design of the aerobic biological selector. Each of these is based on the selector  $F/M$  or the floc loading relationship for the wastewater-sludge mixture, as defined by Eq. (6.4). The design objective is to provide sufficient biomass-wastewater contact time to remove a significant portion of the influent degradable substrate. If 60 to 75 percent of the influent degradable substrate is sorbed in the selector, then the subsequent metabolism and growth of the floc formers is usually adequate to establish a well-settling sludge. If less degradable substrate is removed because of an excessive floc load, then higher concentrations "leak" into the activated sludge reactor and support filamentous growth.

The results of multiple batch floc load tests on a readily degradable pulp and paper mill wastewater are shown in Fig. 6.36. These data are correlated according to the relationship

$$\frac{S}{S_o} = e^{-KFL^{-1}}$$

as shown in Fig. 6.37. These data were used to select a floc loading of 100 to 150 mg COD/g VSS for operation of the aerobic selector of a bench-scale selector CMAS system.

Equation (6.4) can be rearranged to include mixed liquor recycle

$$FL = \frac{S_o}{rX_R + r_RX_v} \quad (6.38)$$

TABLE 6.15  
Treatment of a grapefruit processing wastewater

	Aerobic selector <sup>†</sup> with CMAS		Plug flow activated sludge
	Reactor 1	Reactor 2	
Operating characteristics:			
Influent BOD, mg/l	2543	3309	3309
Effluent BOD, mg/l	18	4	6
Influent COD, mg/l	4768	4460	4460
Effluent COD, mg/l	221	139	135
MLVSS, mg/l	3431	5975	5333
SRT, d	7.2	13.2	13.5
Temperature, °C	22	22	22
SVI, ml/g	71	67	69
$F/M$ , d <sup>-1</sup>	0.32	0.24	0.20
Sludge characteristics:			
	Limiting flux to achieve a 1.5% underflow		
	Solids flux without polymer, lb/ft <sup>2</sup> · d	Solids flux with polymer, lb/ft <sup>2</sup> · d	
Selector with CMAS	5.5	47	
Plug flow	24.5	62	
Specific Resistance:			
	Polymer dosage, lb/ton	Specific resistance, s <sup>2</sup> /g	
Selector with CMAS	3.2	190 × 10 <sup>6</sup>	
Plug flow	2.4	104 × 10 <sup>6</sup>	

<sup>†</sup> Floc load = 120 mg COD/g VSS.

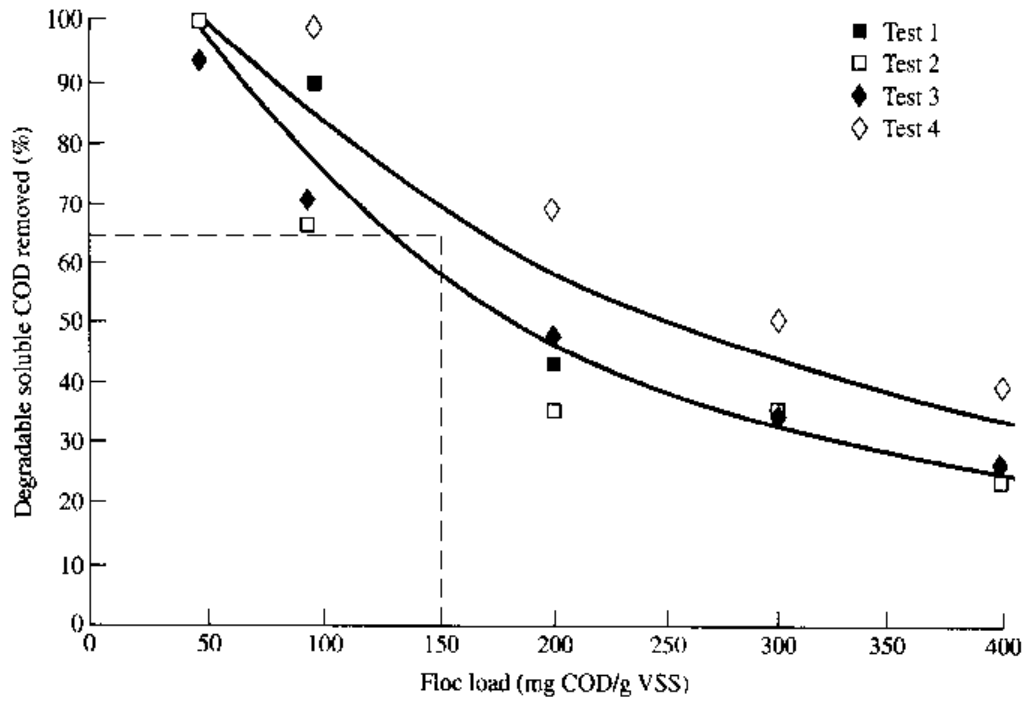
where  $S_o$  = the degradable COD, mg/l  
 $X_R$  = recycle VSS, mg/l  
 $X_v$  = mixed liquor VSS, mg/l  
 $r$  = sludge recycle ratio,  $R/Q$   
 $r_R$  = internal recycle ratio,  $Q_{R/Q}$

The aerobic selector design is shown in Example 6.11.

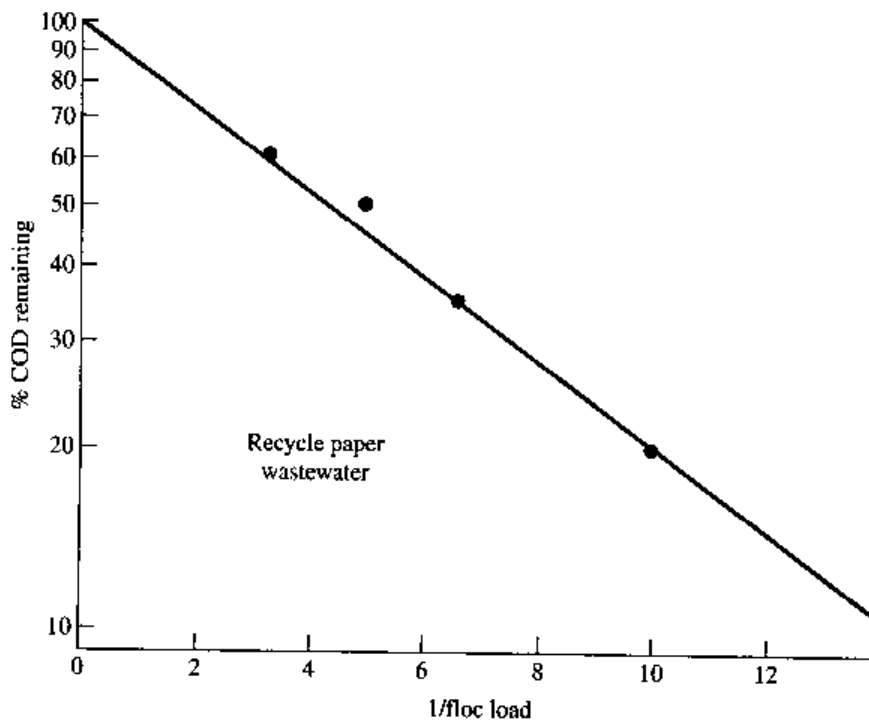
**EXAMPLE 6.11.** Aerobic selector design for industrial wastewaters. Biosorption correlations are shown in Fig. 6.36. The design basis is 65 percent removal of sorbable COD in the selector. For the recycle paper case, design an aerobic selector for an influent COD of 2000 mg/l and an MLVSS of 4000 mg/l. The floc load is 150 mg COD/g VSS. The recycle sludge concentration is 8000 mg/l VSS.

**Solution.**

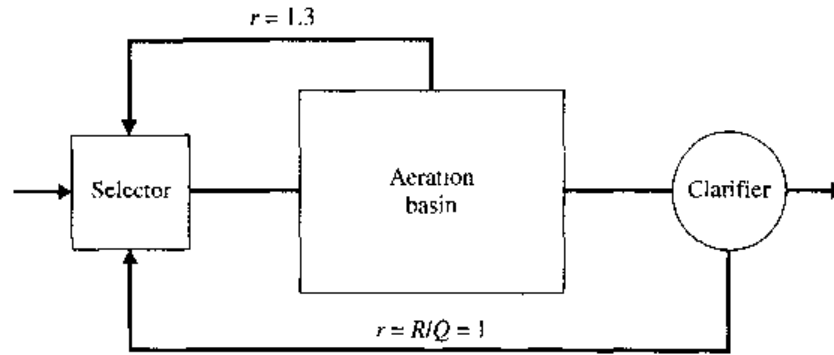
$$r = \frac{X_v}{X_r} = \frac{4000}{8000 - 4000} = 1.0$$



**FIGURE 6.36**  
Floc load test results for a pulp and paper mill wastewater.



**FIGURE 6.37**  
COD removal—floc load relationship.



**FIGURE 6.38**  
Selector flow sheet.

Rearranging Eq. (6.38) gives

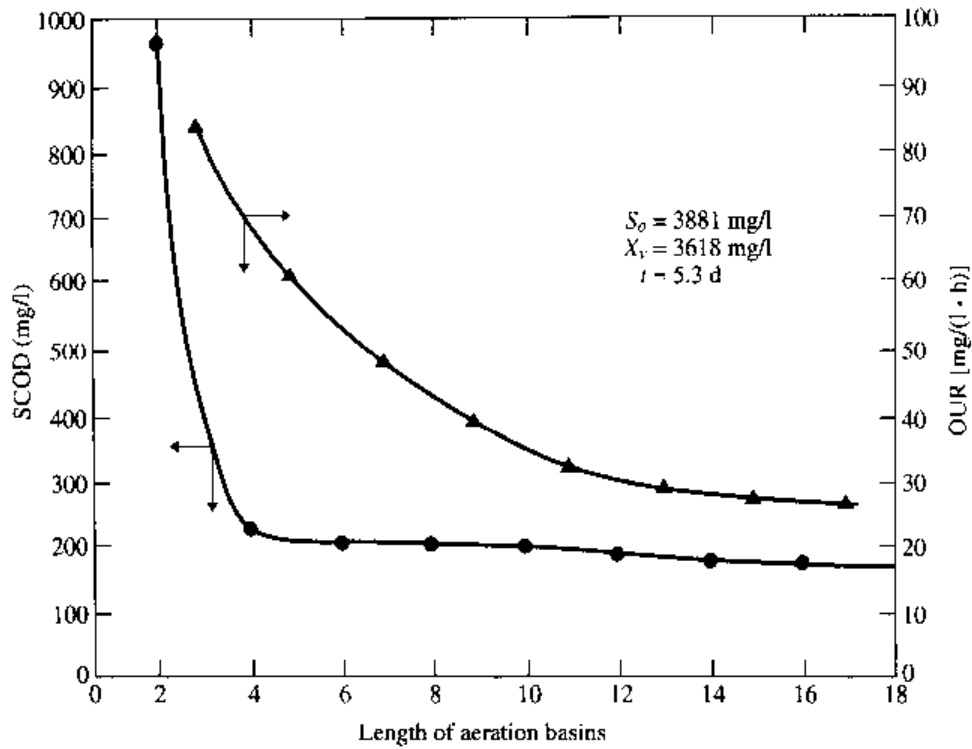
$$\begin{aligned} r_R &= \frac{S_o - FL_r X_R}{FL X_v} \\ &= \frac{2000 - 0.15 \cdot 1 \cdot 8000}{0.15 \cdot 4000} \\ &= 1.3 \end{aligned}$$

If the return sludge recycle rate is 100 percent, the internal recycle will be 130 percent. This is shown in Fig. 6.38. The selector detention time based on  $Q$  will be 0.825 h.

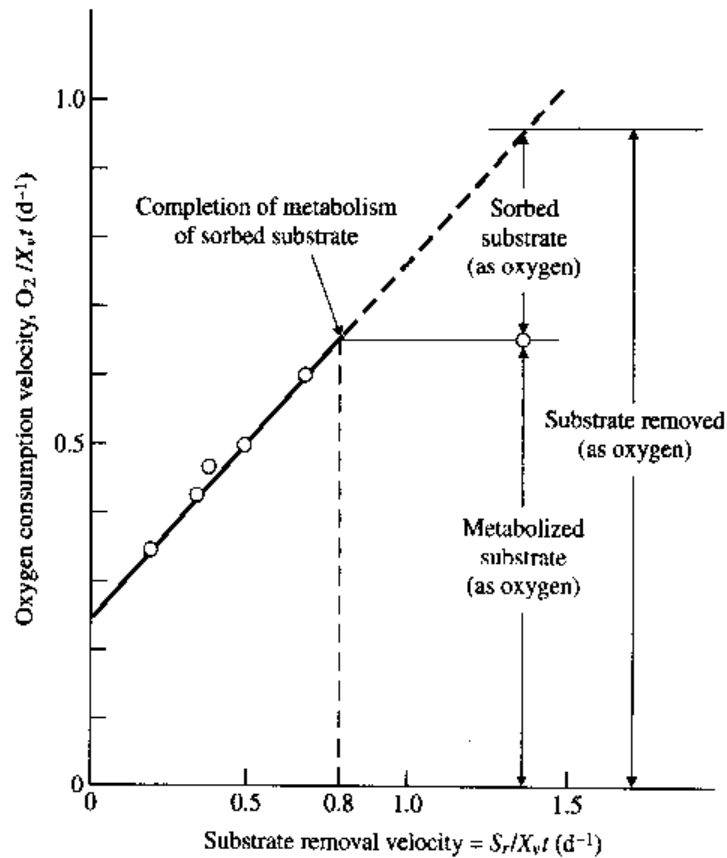
The sorption phenomenon provides the basis for selector design such that sufficient organics are sorbed for subsequent utilization and growth by the floc-forming organisms in preference to the growth of filamentous organisms.<sup>35</sup> After sorption is complete, a minimum aeration period must be provided to oxidize the sorbed organics. This is illustrated by plug flow data for a grapefruit processing wastewater, as shown in Fig. 6.39. When these data are replotted, the minimum required downstream aeration time can be determined as shown in Fig. 6.40. Metabolism of the sorbed substrate was completed at a substrate removal velocity of approximately  $0.8 \text{ d}^{-1}$ . The required minimum aeration time can then be calculated as

$$\begin{aligned} 0.8 &= \frac{S_r}{X_v t} \\ t &= \frac{3600 \text{ mg/l}}{3618 \text{ mg/l} \cdot 0.8/\text{d}} \\ &= 1.24 \text{ d} \end{aligned}$$

Many filamentous organisms are aerobic and can be destroyed by prolonged periods of anaerobiosis. Most of the bacteria, on the other hand, are facultative and can exist for extended periods without oxygen. Although available data are somewhat contradictory, it would appear that anaerobic or anoxic conditions maintained within the process will restrict the growth of these filaments. Marten and Daigger<sup>36</sup> recommend an anoxic selector  $F/M$  of 0.8 to 1.2 lb BOD/lb MLSS per



**FIGURE 6.39**  
Change in SCOD and OUR in a plug flow aeration basin.



**FIGURE 6.40**  
Stabilization time required for sorbed substrate.

day at temperatures greater than 18°C and 0.7 to 1.0 lb BOD/lb MLSS per day at temperatures less than 18°C.

The use of an anoxic zone was studied at an organic chemicals plant. Three systems were run in parallel: a conventional air system, an oxygen system, and an air system with an anoxic zone. The settling properties of the respective sludges indicated that the oxygen system yielded the best settling sludge, while the air system with insufficient dissolved oxygen demonstrated severe filamentous bulking. The anoxic-aerobic system was almost devoid of filaments, but exhibited poorer flocculation and settling than the oxygen system. These results are shown in Table 6.16.

Viscous bulking occurs when the activated sludge contains an excessive amount of extracellular biopolymers which impart a slimy, jellylike consistency to the sludge and the sludge becomes highly water retentive.<sup>37</sup> This hydrous sludge exhibits low settling and compaction velocities. This phenomenon has been reported to be caused by a lack of nutrients/micronutrients or the presence of a toxic compound. Low dissolved oxygen has also been shown to contribute to viscous bulking.

Chlorine or hydrogen peroxide can be added to the return sludge or the aeration basin to reduce bulking.<sup>38</sup> Hydrogen peroxide is selective for some filament types. Hydrogen peroxide dosages are in the order of 20 to 50 mg/l. Chlorine dosages may vary from 9 to 10 lb Cl<sub>2</sub>/(d · 1000 lb MLSS) [9 to 10 kg Cl<sub>2</sub>/(d · 1000 kg MLSS)] in cases of severe bulking and 1 to 2 lb Cl<sub>2</sub>/(d · 1000 lb MLSS) [1 to 2 kg Cl<sub>2</sub>/(d · 1000 kg MLSS)] in cases of moderate bulking. Because of the growth rate of the filaments, if the hydraulic retention time exceeds 8 h, chlorination must be applied directly to the aeration basin. Since the filaments exhibit a high negative zeta potential, they can be flocculated by the addition of cationic polyelectrolytes. This treatment is expensive and the filaments are not destroyed in the process.

*Nocardia* foams cause significant problems in plant operation. *Nocardia* actinomycetes are slower-growing organisms compared to floc-forming organisms. The growth of *Nocardia* can be controlled by reducing the SRT to less than 3 d to create washout conditions. These short SRTs are usually not feasible if nitrification is

TABLE 6.16  
Sludge characteristics under various operating conditions

System	ZSV, ft/hr	SVI, ml/g	MLSS, mg/l	F/M, <sup>†</sup> g/g · d	Temperature, °C	Effluent TSS, mg/l
Low DO	0.6	222	3500	0.44	33	120
Anoxic	2.0	116	3850	0.44	34	50
	2.0	129	3600	0.35	40	140
	1.4	228	2800	0.44	45	130
	3.6	100	3450	0.31	35	40
High DO	3.5	96	3350	0.61	39	160
	5.5	90	3200	0.55	45	200
	Low loading	3.2	133	2700	0.28	24
4.2		133	2200	0.25	35	275

<sup>†</sup> BOD basis

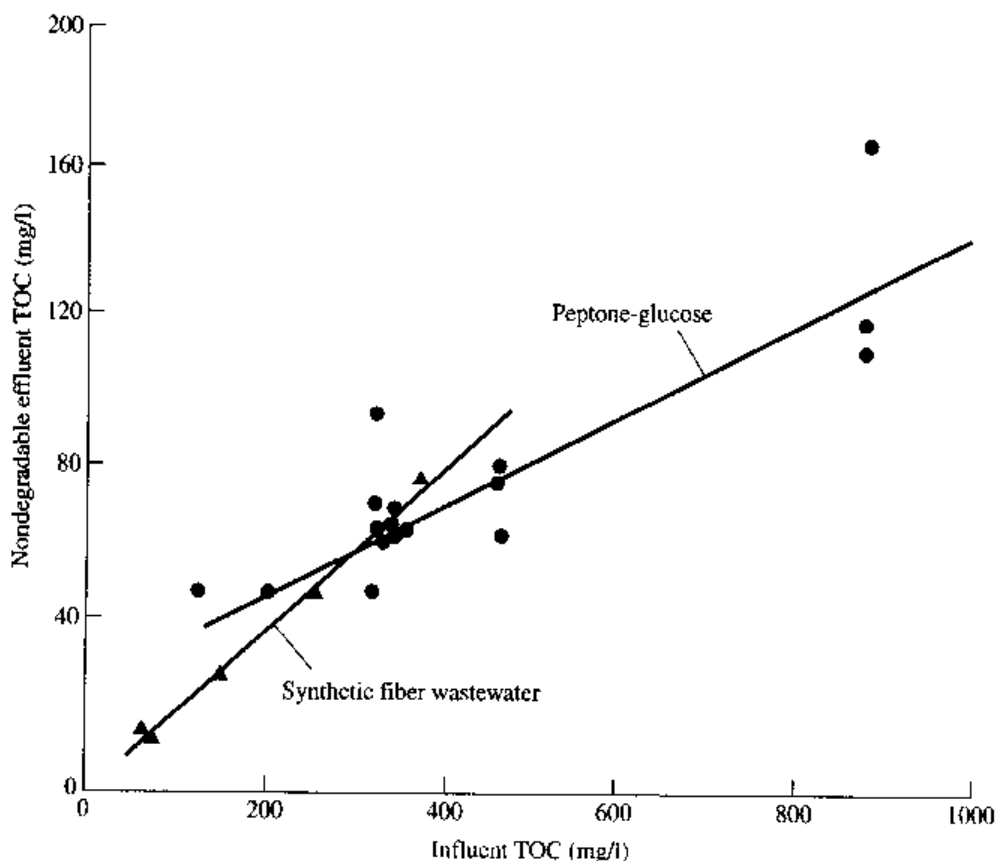


to be employed. Aerobic selectors or anoxic zones have been successful at controlling *Nocardia* foaming when operated at low SRTs. These methods are less effective at controlling *M. parvicella*. Successful control of biological foaming problems by applying powdered hypochlorite or a hypochlorite spray directly on the foam has been reported.

## 6.5

### SOLUBLE MICROBIAL PRODUCT FORMATION

Soluble microbial products (SMP) are generated in the activated sludge process through the biodegradation of organics and through endogenous degradation of the biomass. The SMP are oxidation by-products that are nondegradable. Pitter and Chudoba<sup>39</sup> have indicated that, depending on cultivation conditions, the nonbiodegradable waste products can amount to 2 to 10 percent of the COD removed. The COD, BOD, and  $SMP_{nd}$  relationships for several industrial wastewaters are summarized in Table 1.8. Data for biodegradation of a peptone-glucose mixture and a synthetic fiber wastewater are shown in Fig. 6.41. They indicate that approximately 0.20 mg of nondegradable TOC ( $TOC_{nd}$ ) was produced per mg of influent TOC for the synthetic fiber wastewater. The peptone-glucose-containing waste-



**FIGURE 6.41**  
Nondegradable TOC as related to influent TOC.

water produced approximately 0.12 mg  $\text{TOC}_{\text{nd}}$  per mg influent TOC. In both cases, the ratios were constant over the range of influent loading conditions. This indicates that there was a constant metabolic by-product or a portion of the original substrates that was nondegradable.

Many of the metabolic by-products are of high molecular weight. The molecular weight distribution (expressed as the TOC and COD fractions) of the influent and biologically treated effluent from a plastic additives wastewater and a biologically treated effluent from a glucose-based synthetic wastewater are presented in Table 6.17. Pitter and Chudoba<sup>39</sup> have indicated that approximately 75 percent of the  $\text{SMP}_{\text{nd}}$  from treatment of a wastewater containing only phenol had a molecular weight above 1000. It has been further determined that some of these high-molecular-weight fractions are toxic to some aquatic organisms. Results showing the aquatic toxicity of several wastewaters from the plastics industry before and after biological oxidation are shown in Fig. 6.42. They indicate that biological treatment reduced the TOC and toxicity in most cases. In two wastewaters, however, the TOC was reduced by 32 and 78 percent, but the treated effluent was more toxic than the influent wastewater, making the oxidation by-products suspect toxicants. There is reason to believe that the high-molecular-weight  $\text{SMP}_{\text{nd}}$  strongly adsorb on activated carbon. This characteristic makes granular-activated carbon (GAC) or powdered-activated carbon (PAC) an excellent candidate process for toxicity reduction when toxicity is caused by  $\text{SMP}_{\text{nd}}$ . Inhibition to nitrification by  $\text{SMP}_{\text{nd}}$  is shown in Fig. 6.43 from the data of Chudoba.<sup>40</sup>

## 6.6

### BIOINHIBITION OF THE ACTIVATED SLUDGE PROCESS

Many organics will exhibit a threshold concentration at which they inhibit the heterotropic and/or nitrifying organisms in the activated sludge process. Inhibition has been defined by the Haldane equation (or its modifications) using Monod kinetics:

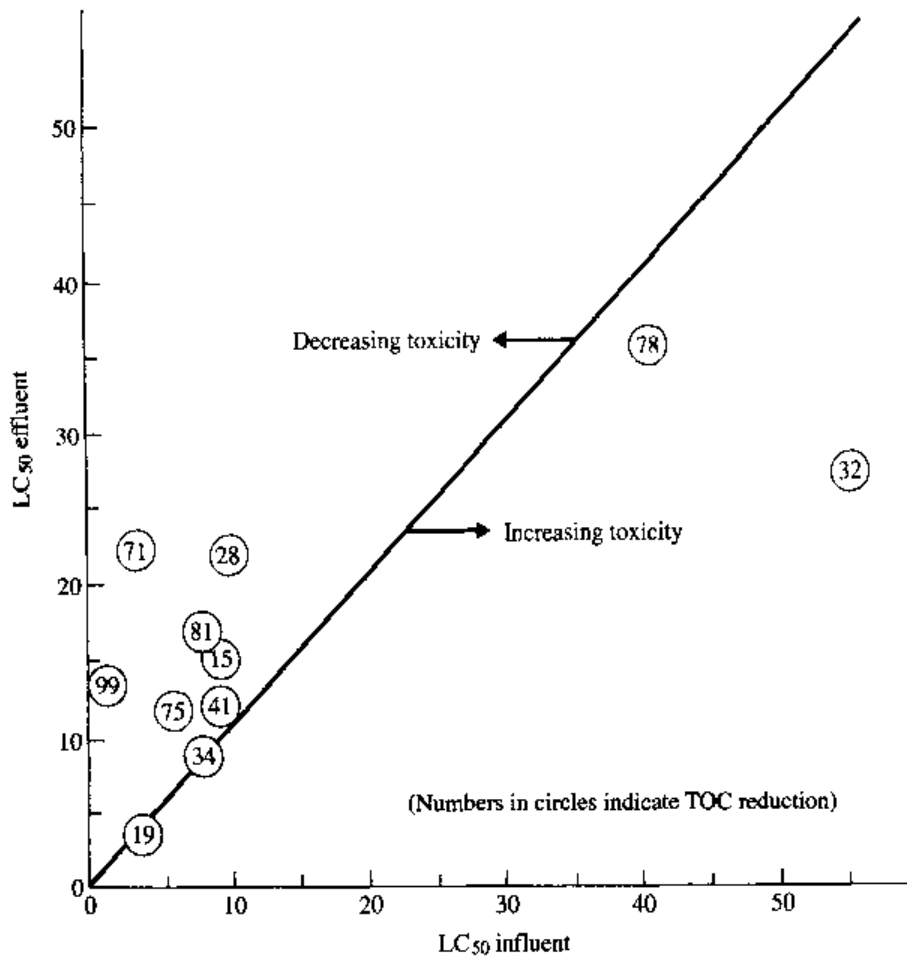
$$\mu = \frac{\mu_m S}{S + K_s + S^2/K_i} - b \quad (6.39)$$

in which  $K_i$  is the Haldane inhibition coefficient.

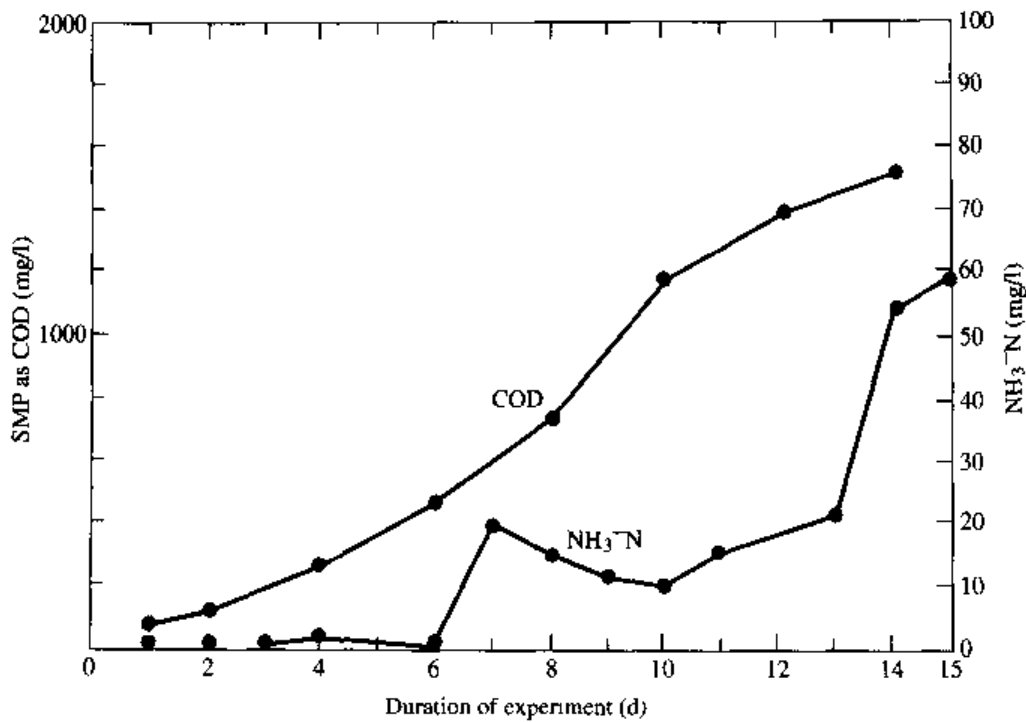
An example of bioinhibition by a plastics additives wastewater is shown in Fig. 6.44. The extent of bioinhibition is expressed as the ratio of the SOUR at the

TABLE 6.17  
Molecular weight distribution of a biological effluent

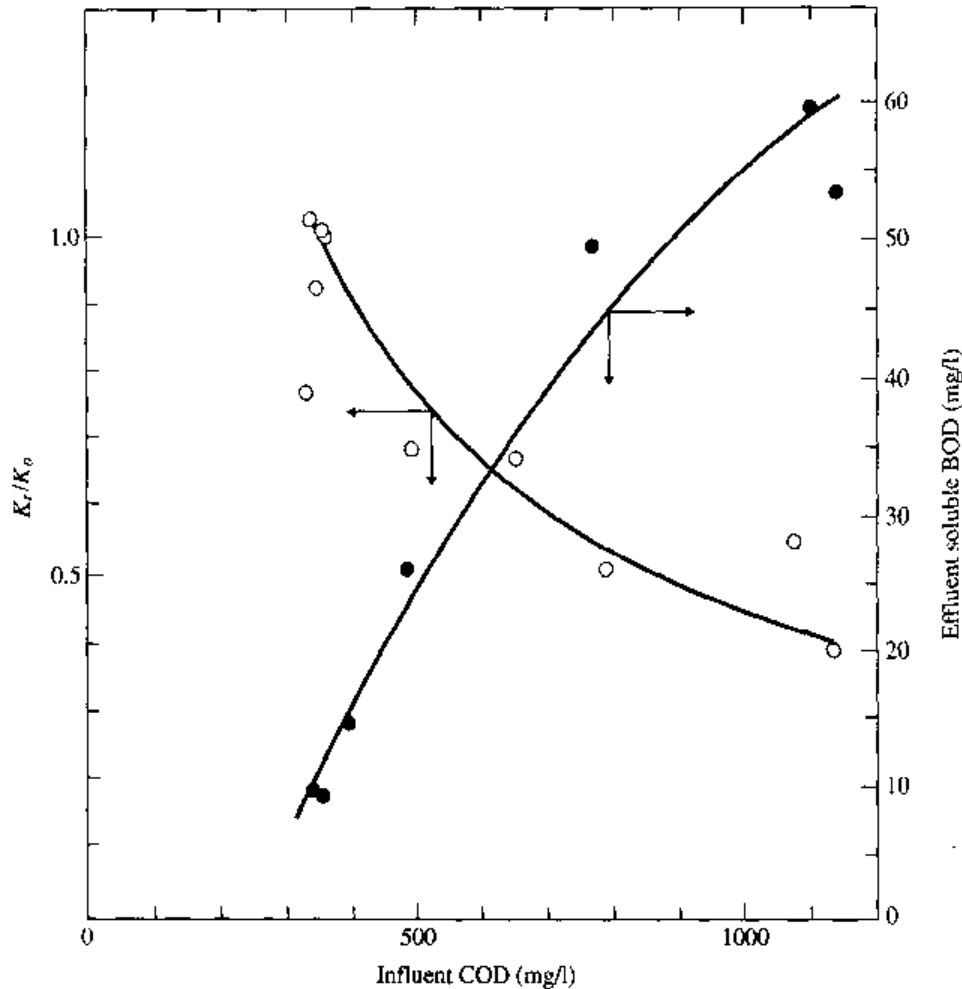
Molecular weight	Plastic additives wastewater		Glucose <sup>37</sup> wastewater COD, %
	Influent TOC, %	Bioeffluent TOC, %	
> 10,000	—	11.5	45
500- 10,000	—	14.5	16
< 500	100	74.0	39



**FIGURE 6.42**  
Effect of SMP on effluent toxicity for wastewaters from the plastics and dyestuffs industry.



**FIGURE 6.43**  
Relationship between SMP as COD on ammonia buildup.<sup>40</sup>

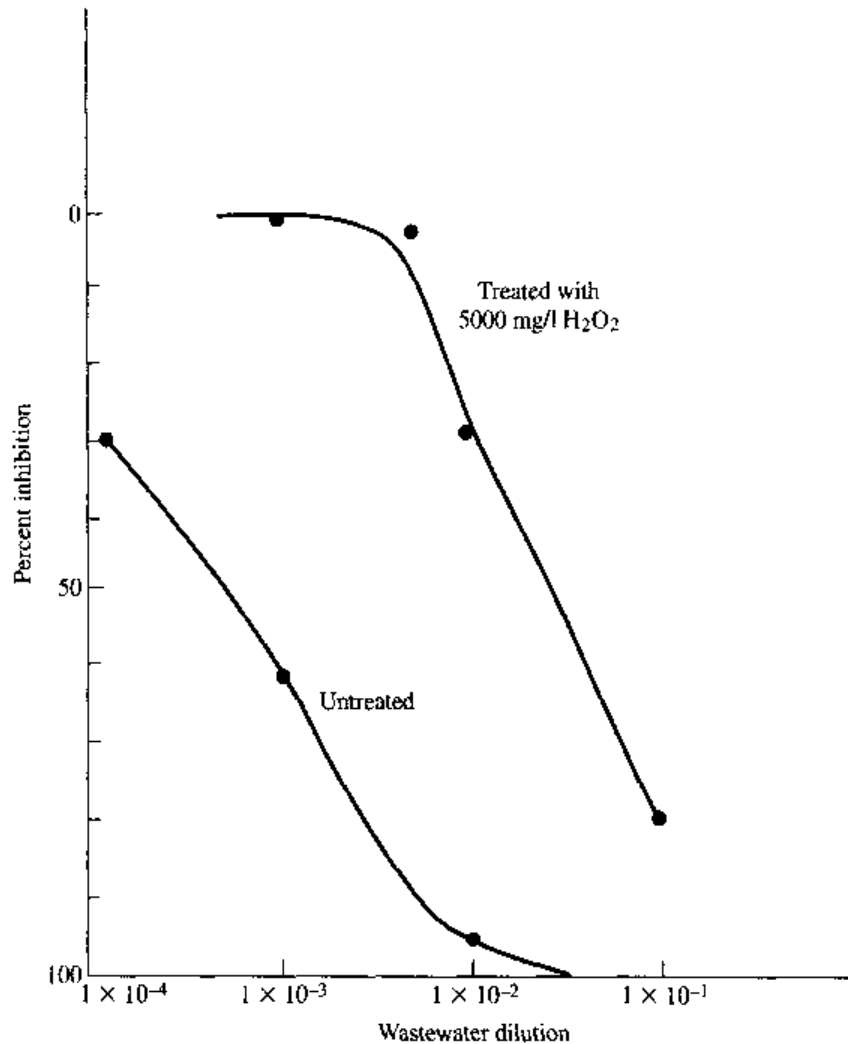
**FIGURE 6.44**

Activated sludge inhibition from a plastics additives wastewater.

selected influent loading concentration ( $K_r$ ) to the SOUR at the no-observed-effect loading ( $K_o$ ). As the concentration of influent COD (and inhibitory agent) increases, the SOUR decreases, resulting in higher effluent SBOD concentrations. In this case, the inhibition was removed by pretreating the wastewater with hydrogen peroxide ( $H_2O_2$ ), thereby effecting detoxification and enhanced biodegradability. These effects are shown in Fig. 6.45. Addition of powdered activated carbon to the mixed liquor to adsorb the toxicant was also shown to reduce the inhibition.

Several acidic, aromatic, and lipid-soluble organic compounds have been demonstrated to “uncouple” oxidative phosphorylation. The result of this uncoupling effect is uncontrolled respiration and oxidation of primary substrates and intracellular metabolites. At low concentrations, uncoupling is evidenced by highly elevated oxygen utilization rates but no effect on cell growth or substrate removal. At higher concentrations, inhibition and toxicity are demonstrated by dramatic reductions in both the oxygen utilization rate and cell growth.

Volskay and Grady<sup>41</sup> and Watkin<sup>42</sup> have shown that inhibition can be competitive (the inhibitor affects the base substrate utilization), noncompetitive (the inhibitor



**FIGURE 6.45**

Detoxification of a plastics additives wastewater.

rate is influenced), or mixed, in which both rates are influenced. The effects of substrate and inhibitor concentrations on the respiration rate of a microbial culture expressed as a fraction of the rate in the absence of the inhibitor have been shown by Volskay and Grady.<sup>41</sup>

While the relationships described above define the mechanism of inhibition, they are of limited use in evaluating industrial wastewaters. In most cases, the inhibitor itself is not defined, variable sludge and substrate composition will influence inhibition, and interactions will frequently exist between inhibitors. The inhibition constant  $K_I$  is highly dependent on the specific enzyme system involved, which, in turn, is dependent on the history and population dynamics of the sludge. In some cases, the inhibition constant may be dependent on the particular metabolic pathways that are present in any given microbial population. For example, Watkin and Eckenfelder<sup>43</sup> showed a variation in  $K_I$  of 6.5 to 40.4 for different sludges and operating conditions treating 2,4-dichlorophenol and glucose. Volskay and Grady<sup>38</sup> showed a variation of 2.6 to 25 mg/l in the concentration of pentachlorophenol, which would cause 50 percent inhibition of oxygen utilization rates.

It is apparent, therefore, that each wastewater must be independently evaluated for its bioinhibition effects. Several protocols have been developed for this purpose. These are the fed-batch reactor (FBR) of Philbrook and Grady<sup>28</sup> and Watkin and Eckenfelder,<sup>43</sup> the OECD method 209 of Volskay and Grady,<sup>41</sup> and the glucose inhibition test of Larson and Schaeffer.<sup>44</sup> Depending on the particular wastewater, one or more of these test protocols will be applicable. Each of these methods is discussed below.

### OECD Method 209

The OECD method 209 involves measurement of activated sludge oxygen uptake rate from a synthetic substrate to which the test compound has been added at various concentrations. The oxygen uptake rate is measured immediately after addition of the test compound and after 30 min of aeration. The  $EC_{50}$  value is determined as the concentration of test compound at which the oxygen uptake rate (at 30 min) is 50 percent of the uninhibited oxygen uptake rate. The OECD method uses 3,5-dichlorophenol as a reference toxicant to ensure that the test is working properly and that the biomass has the appropriate sensitivity. The reference  $EC_{50}$  value should be between 5 and 30 mg/l for the test to be valid.

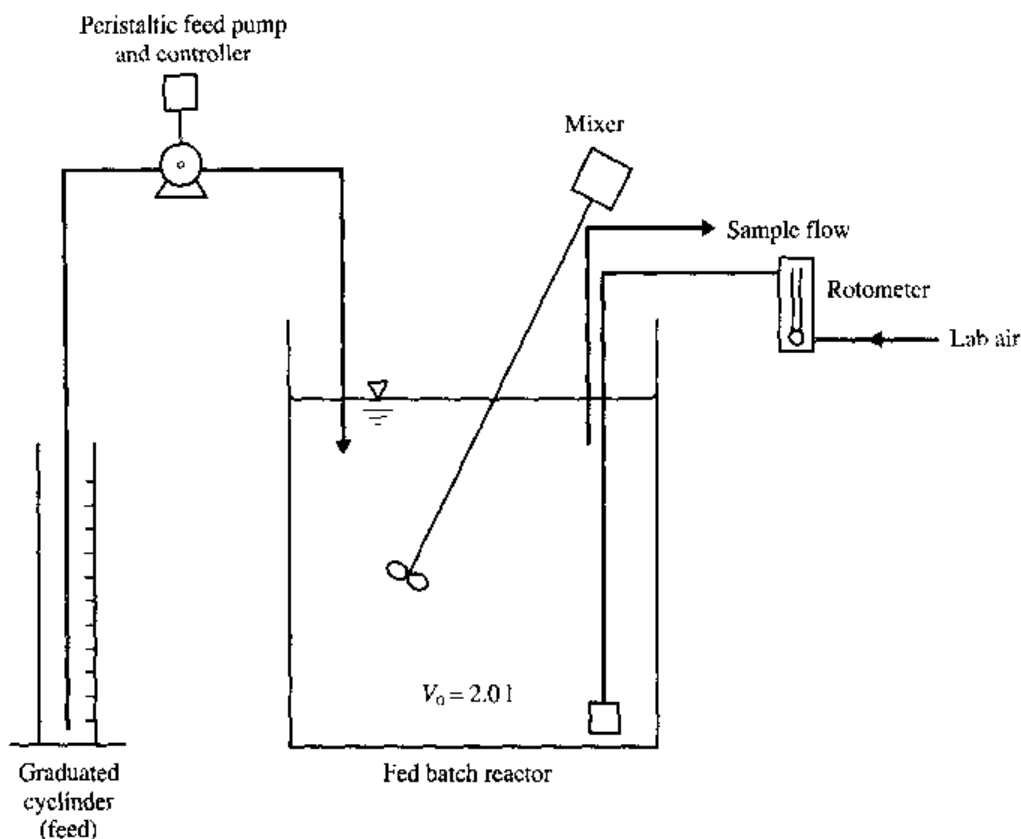
Volskay and Grady<sup>41</sup> employed a modified OECD method to determine the toxicity of selected organic compounds. Since many of the compounds were volatile, the test was modified by using more dilute cell and substrate concentrations and by conducting the test in vessels that were sealed by the insertion of a polyfluoroethylene plug. This protocol is recommended for wastewaters containing high concentrations of volatile organics.

### Fed Batch Reactor (FBR)

Fed batch reactors have been used to determine nitrification kinetics and removal kinetics of specific pollutants in activated sludge. The essential characteristics of the FBR procedure are that:

1. Substrate is continuously introduced at a sufficiently high concentration and low flow rate so that the reactor volume is not significantly changed during the test.
2. The feed rate exceeds the maximum substrate utilization rate.
3. The test duration is short and therefore allows simple modeling of biological solids growth.
4. Acclimated activated sludges are used.

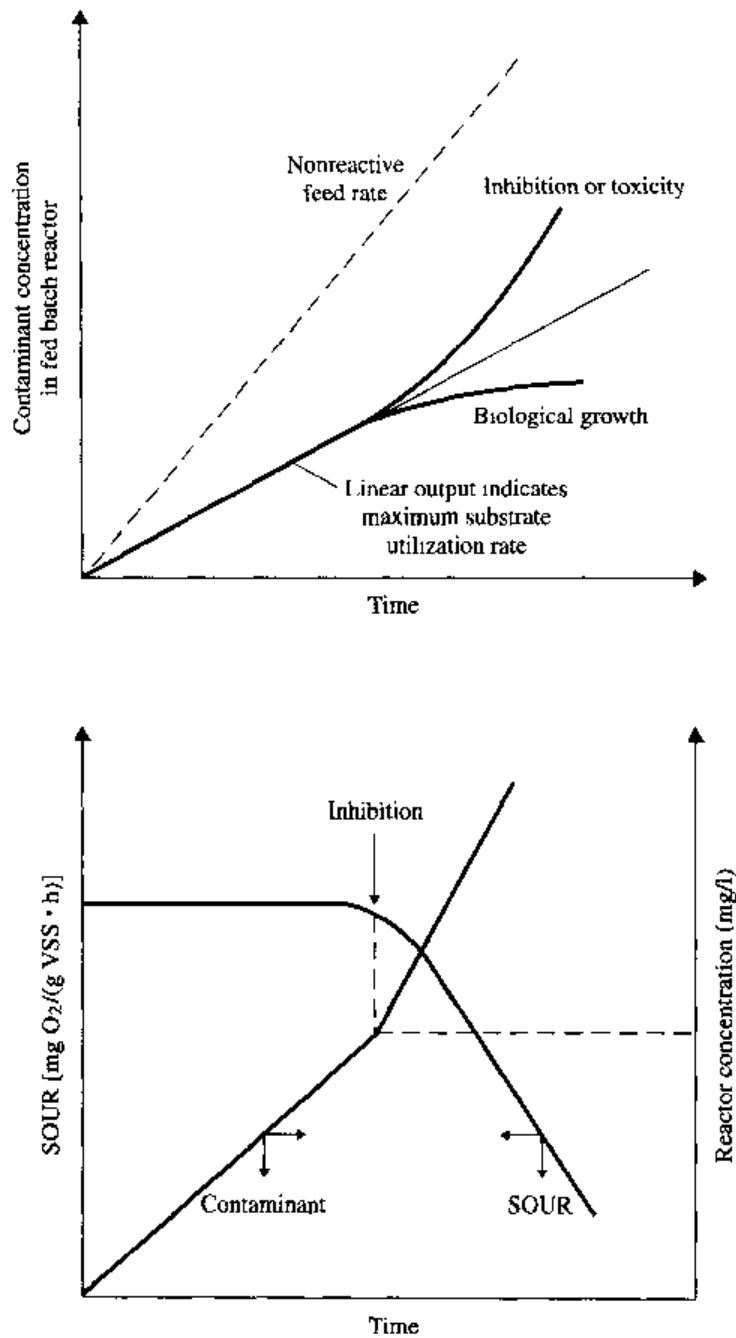
A schematic diagram of the FBR is shown in Fig. 6.46. Two liters of mixed liquor are placed in the reactor, and a sample is taken for determination of oxygen utilization rate (OUR) and mixed liquor volatile and total suspended solids prior to the start of the feed flow. The feed is introduced at a flow rate of 100 ml/h, and aliquots of the reactor contents are withdrawn every 20 min for the duration of the 3-h test. The OUR is determined in situ every 30 min during the test. Suspended solids determinations are made every hour during the test.



**FIGURE 6.46**  
Fed batch reactor (FBR) configuration.

As discussed under the OECD protocol, the oxygen uptake rate will decrease in the presence of inhibition. As long as there is no inhibition, the OUR will remain constant at a maximum rate. The same limitations apply to the FBR protocol as to the OECD method.

The theoretical responses in a fed batch reactor to both inhibitory and noninhibitory substrates are depicted in Fig. 6.47. In the case where substrate is added at a sufficiently high mass and low volumetric flow rate, the maximum substrate utilization rate will be exceeded, and the change in reactor volume will be insignificant. If the FBR volume change is negligible and the mass feed rate exceeds the maximum substrate utilization rate, then a substrate concentration buildup will result in the reactor with time. Noninhibitory substrate response results in a linear residual substrate buildup in the reactor with time. The maximum specific substrate utilization rate  $q_{\max}$  is calculated as the difference in slopes between the substrate feed rate and the residual substrate buildup rate divided by the biomass concentration. In the case of inhibition, substrate utilization would rapidly decrease, resulting in an upward deflection of the residual substrate concentration curve as shown in Fig. 6.47. As inhibition progresses and acute biotoxicity occurs, the trace of the residual substrate concentration should become parallel to the substrate feed rate. The inhibition constant  $K_I$  can be approximated by identifying the inhibitor concentration at the midpoint of the curvilinear portion of the substrate response.

**FIGURE 6.47**

Theoretical fed batch reactor output with influent substrate mass flow rate greater than  $q_{\max} \cdot X_v$  and inhibition effects.

### Glucose Inhibition Test

Larson and Schaeffer<sup>44</sup> developed a rapid toxicity test based on the inhibition of glucose uptake by activated sludge in the presence of toxicants. The test was subsequently modified for application to a variety of industrial wastewaters. The procedure is as follows:



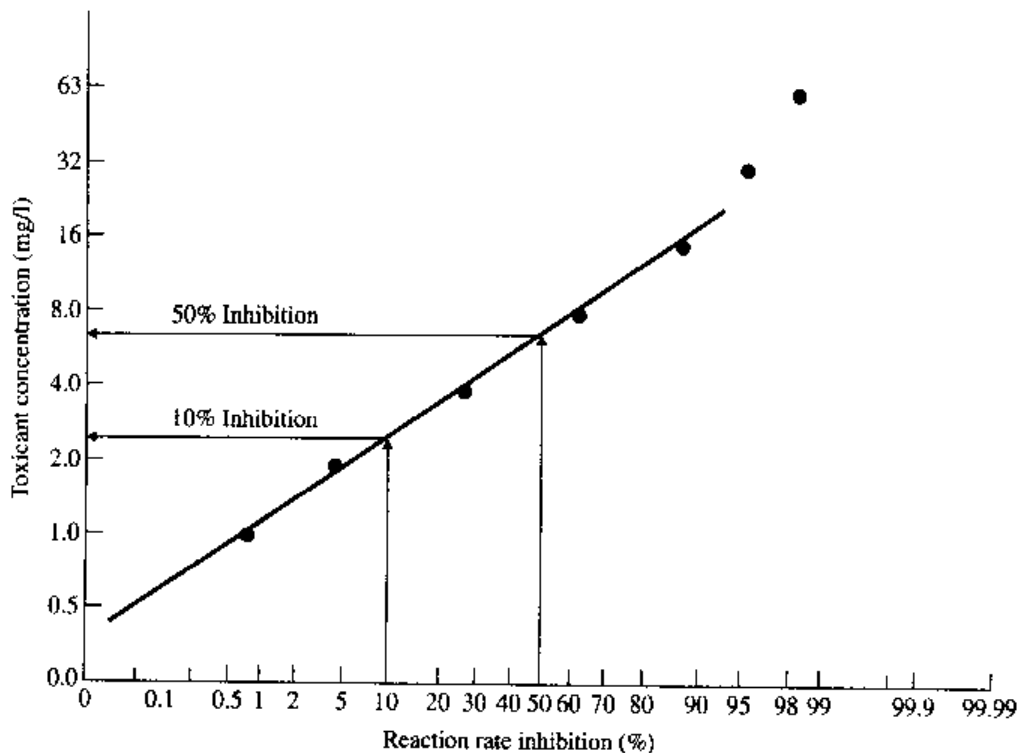
1. Place 10 ml of sample into a centrifuge tube.
2. Add 10 ml of the stock glucose.
3. Add 10 ml of activated sludge to the centrifuge tube and aerate at a low rate.
4. After 60 min, add two drops of HCl and transfer tubes to the centrifuge.
5. Measure glucose concentration.
6. Sludge control—substitute 10 ml of deionized water for the sample in step 1 and perform steps 2 through 5 as before.
7. Glucose control—place 30 ml of deionized water in a centrifuge tube. Add 1 ml of stock glucose solution. Do not add sludge or aerate. Add two drops of HCl and measure glucose uptake.

The percent inhibition is calculated as follows:

$$\text{Percent inhibition} = \left[ \frac{C - C_B}{C_o - C_B} \right] 100$$

where  $C$  = final glucose concentration in sample solution  
 $C_B$  = final glucose concentration in sludge control sample  
 $C_o$  = initial glucose concentration (glucose control)

Inhibition effects using the glucose test are presented in Fig. 6.48 for an organic chemicals wastewater.



**FIGURE 6.48**

Determination of bioinhibition effects from the glucose inhibition test.

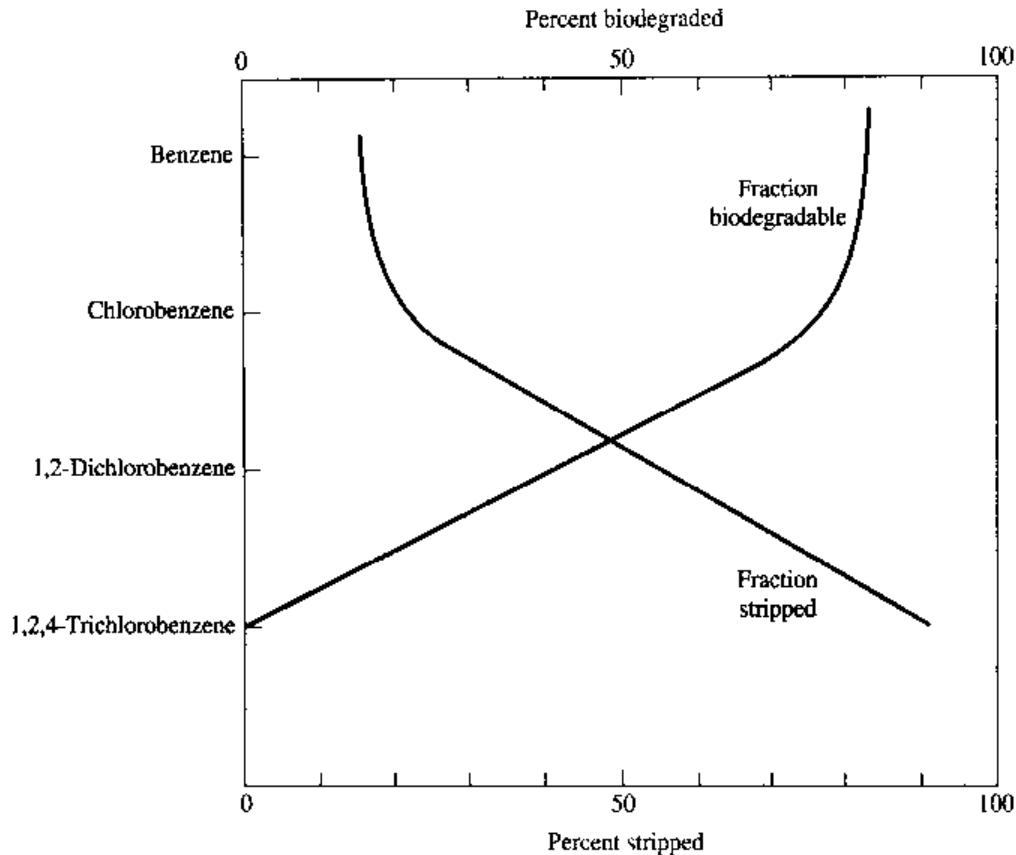
## 6.7 STRIPPING OF VOLATILE ORGANICS

Volatile organic compounds (VOCs) will be stripped from solution by oxygenation in the activated sludge process. Depending on the particular VOC, both air stripping and biodegradation may occur.

The fraction of the VOC that is stripped depends upon several factors. Compound specific factors include the Henry's law constant, the compound's biodegradation rate, and in some cases, the initial concentration of the compound and other substrates. Operational and facility design factors that influence stripping are the method of oxygenation and the power level in the aeration basin. The concentration of nonvolatile organics in the wastewater will affect the composition and mass of the sludge, the operating SRT, and hence, the fraction of VOC that is biodegraded and stripped. Biodegradation and stripping removal data for a range of VOCs are presented in Table 6.18. As a general rule, as more halogen atoms are added to the organic compound, the rate of biodegradation decreases, and the amount of compound stripped increases. This is shown in Fig. 6.49 for several chlorinated compounds in the benzene series. It should be noted that a greater SRT will usually result in less stripping since a lower power level will be employed and

TABLE 6.18  
Fate of selected VOCs in the activated sludge process

Compound	Influent concentration, mg/l	SRT, d	Amount stripped, %
Toluene	100	3	12-16
	0.1	3	17
	40	3	15
	40	12	5
	0.1	6	22
Nitrobenzene	0.1	6	<1
Benzene	153	6	15
	0.1	6	16
Chlorobenzene	0.1	6	20
1,2-Dichlorobenzene	0.1	6	59
1,2-Dichlorobenzene	83	6	24
1,2,4-Trichlorobenzene	0.1	6	90
<i>o</i> -Xylene	0.1	6	25
1,2-Dichloroethane	150	3	92-96
1,2-Dichloropropane	180	6	5
Methyl ethyl ketone	55	7	3
	430	7	10
1, 1, 1-Trichloroethane	141	6	76



**FIGURE 6.49**

Relationship between biodegradation and stripping for the chlorinated benzene series.<sup>1</sup>

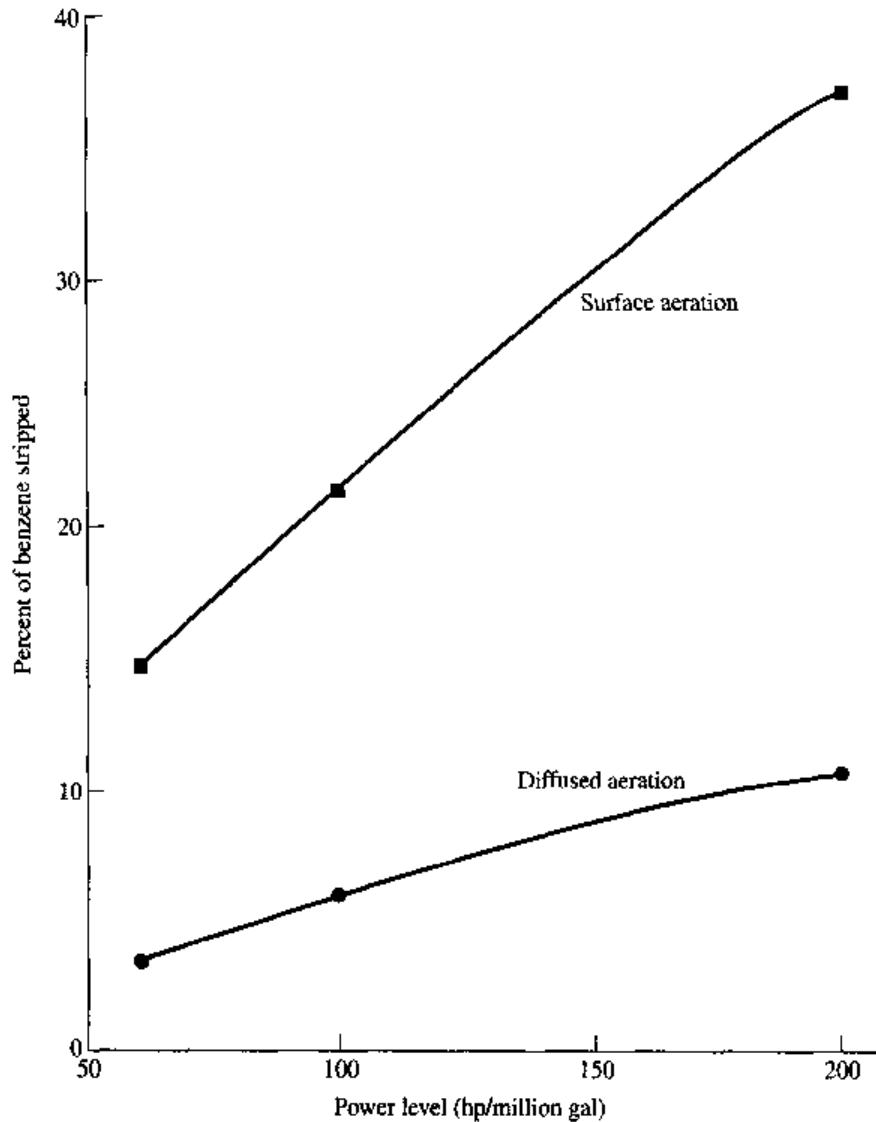
the biomass concentration will be higher. The effects of power level and the type of aeration device on the stripping of benzene are shown in Fig. 6.50, which was developed assuming an influent COD of 250 mg/l and an influent benzene concentration of 10 mg/l.

In a diffused air oxygenation system, equilibrium between the gas and liquid phases is quickly reached after the bubble is formed. Under these conditions, the amount of VOC that is stripped depends primarily on the gas to liquid ratio. Since, under most conditions, the volume of gas is relatively small, stripping is minimal. In a mechanical surface aeration system, however, the volume of gas in contact with the liquid is nearly infinite (i.e., the atmosphere), and hence, a greater quantity of VOC will be stripped.

The fraction emitted to the air of any volatile component entering an activated sludge aeration basin can be derived from the mass balance Eq. (6.39) neglecting the effects of adsorption on the biological floc:

$$Q_o C_{o,i} = Q_o C_{L,i} + r_i + r_{vi} \quad (6.40)$$

- where
- $Q_o$  = flow rate, l/s
  - $C_{o,i}$  = influent concentration of VOC  $i$ , g/l
  - $C_{L,i}$  = liquid effluent concentration of component  $i$ , g/l
  - $r_i$  = rate of biodegradation of component  $i$ , g/s
  - $r_{vi}$  = rate of volatilization of component  $i$ , g/s



**FIGURE 6.50**  
Stripping of benzene as related to power level and type of aerator.

For a complete mix system, the fraction of the influent VOC load that is emitted to the air ( $f_{\text{air}}$ ) is given by

$$f_{\text{air}} = \frac{r_{vi}}{Q_o C_{L,i} + r_i + r_{vi}} \quad (6.41)$$

When individual compounds, pure or in a mixture, are considered, it is appropriate to use a Monod kinetic model to describe their biodegradation. The concentrations of priority pollutants normally encountered in a complete mix reactor are in the  $\mu\text{g/l}$  range in order to comply with current regulations. Under these conditions, the Monod model reduces to a first-order rate expression, and the biodegradation rate of compound  $i$  (expressed as COD) is given by

$$r_i = W_i q_m X_{vb} V C_{L,i} / K_S \quad (6.42)$$

where  $W_i$  = weighting factor for compound  $i$   
 $q_m$  = biodegradation rate constant for compound  $i$ , g COD/(g VSS · s)  
 $X_v$  = volatile solids concentration, g/l  
 $V$  = volume of reactor, l  
 $C_{L,i}$  = concentration of compound  $i$  in the reactor, g/l  
 $K_S$  = Monod's half saturation constant for component  $i$ , g/l

The biomass is considered to be a mixed culture with each organic substrate being the growth-limiting factor for a specific microbial population. Under these circumstances, the fraction of biomass dedicated to a specific substrate would be proportional to the biomass yield associated with this substrate. Hence, the weighting factor would be

$$W_i = a_i C_{B,i} \left[ \sum_{j=1}^{n-1} a_j C_{B,j} \right]^{-1} \quad (6.43)$$

where  $C_{B,i}$  = concentration of component  $i$  that is biodegraded, g/l, and  $a_i$  = yield coefficient of component  $i$ , g VSS/g COD.

Stripping of VOC is computed by using the method of Roberts et al.<sup>45</sup> This model estimates stripping with surface or diffused aeration on the premise that the transfer rates for volatile solutes are proportional to one another. Since oxygen satisfies the volatility criteria and because a large mass-transfer database for it is available, oxygen has been selected as the reference compound. The overall mass-transfer coefficient for compound  $i$  is then proportional to that for oxygen at the operating conditions.

$$(K_L a)_i = \psi (K_L a)_{O_2} \quad (6.44)$$

It has been shown that the proportionality constant ( $\psi$ ) depends on the liquid-phase diffusivity ratio,  $D_i/D_{O_2}$ , and is approximately constant over a wide range of temperature and mixing conditions. Values of  $\psi$  are virtually identical in clean water and wastewater, indicating that the transfer rates of dissolved oxygen and organic solutes are inhibited to the same degree as wastewater constituents.

The overall gas transfer coefficient  $(K_L a)_{O_2}$  is related to the standard oxygenation rate:

$$(K_L a)_{O_2} = \frac{SOR \cdot P}{C_s \cdot V} \quad (6.45)$$

where  $C_s$  = oxygen solubility in clean water, g/l  
 $P$  = aeration basin power level, hp  
 $V$  = aeration basin volume, l  
 SOR = standard oxygenation rate, g O<sub>2</sub>/hp · h

For surface aeration, the stripping of VOCs can be computed from Eq. (6.45):

$$r_{vi} = \Psi (K_L a)_{O_2} \cdot C_{L,i} V \quad (6.46)$$

and the fraction of VOC emitted to the air becomes

$$f_{air} = \frac{\Psi K_L a_{O_2} V}{Q_o + (W_i q_m X_v V / K_S) + \Psi K_L a_{O_2} V} \quad (6.47)$$

For diffused air, assuming the exit air is in equilibrium with the liquid, the fraction of VOC remaining in the liquid phase is

$$r_{vi} = Q_{\text{air}} H_c C_{L,i} \quad (6.48)$$

in which  $(H_c)_i$  = Henry's constant for compound  $i$ . The fraction of VOC emitted using diffused aeration at an airflow rate of  $Q_{\text{air}}$  is

$$f_{\text{air}} = \frac{Q_{\text{air}} H_c}{Q_o + (W_i q_m X_{vb} V / K_s) + Q_{\text{air}} H_c} \quad (6.49)$$

Example 6.12 illustrates the calculation of VOC emissions.

**EXAMPLE 6.12.** Determine the fraction of benzene emitted to the air under the following loading conditions for mechanical aeration and diffused aeration. The mechanical aeration system uses 60 hp/million gal and has a  $(K_L a)_{\text{O}_2} = 1.52/\text{h}$ , and the diffused aeration system has an airflow rate of  $2.16 \text{ m}^3/\text{s}$ .

**Solution.**

$$\begin{aligned} V &= 3846 \text{ m}^3 \text{ (136,000 ft}^3\text{)} \\ Q_o &= 0.178 \text{ m}^3/\text{s (2820 gal/min)} \\ C_o &= 10 \text{ mg/l} \\ X_{vb} &= 3000 \text{ mg/l} \\ S_o &= 250 \text{ mg COD/l} \end{aligned}$$

$$r_i = \frac{W_i q_m X_{vb} V C_{L,i}}{K_{si}}$$

$$W_i = \frac{a_i f_{\text{bio},i} C_{o,i}}{a(S_o - S)} \frac{3.08 \text{ mg COD}}{\text{mg benzene}}$$

Assuming  $a_i = a$  and  $f_{\text{bio},i} = 0.87$ ,

$$W_i = \frac{0.87 \times 10 \times 3.08}{(250 - 20)} = 0.117$$

then for mechanical aeration,

$$f_{\text{air},i} = \frac{0.6 \times (1.52/3600) \times 3846}{0.178 + \frac{0.117 \times 5.78 \times 10^{-6} \times 3000 \times 3846}{1} + 0.974}$$

$$f_{\text{air},i} = \frac{0.974}{0.178 + 7.803 \times 0.974} = \frac{0.974}{8.955} = 0.109 = 11\%$$

Check  $f_{\text{bio},i}$ :

$$f_{\text{bio},i} = \frac{7.803}{8.955} = 0.871 = 87\% \quad \text{Checks}$$

For diffused aeration, assume 93 percent biodegradation.

$$W_t = \frac{0.93 \times 10 \times 3.08}{(250 - 20)} = 0.125$$

$$f_{air,t} = \frac{2.16 \times 0.225}{0.178 + \frac{0.125 \times 5.78 \times 10^{-6} \times 3000 \times 3846}{1} + 0.486}$$

$$f_{air,t} = \frac{0.486}{0.178 + 8.336 + 0.486} = \frac{0.486}{9.0} = 0.054 = 5.4\%$$

$$f_{bio,t} = \frac{8.336}{9.0} = 0.926 = 93\% \quad \text{Checks}$$

$$S_e = 20 \text{ mg COD/L}$$

$$\psi = 0.6$$

$$q_m = 5.78 \times 10^{-6}/s$$

$$K_s = 1.0 \text{ mg/l}$$

$$H_c = 0.225$$

### Treatment of VOC Emissions

If the off-gas from the aeration basin contains high concentrations of VOC or ammonia, air quality standards may require off-gas collection and treatment. Several treatment technologies are available, including thermal and catalytic incineration, carbon adsorption, macroreticular resin adsorption, and biological degradation. The removal performance of several of these technologies is shown in Fig. 6.51 as a function of the gas phase VOC concentration. In most cases of activated sludge treatment, the gas phase VOC concentration will be low (< 50 ppmv), and incineration would be required to provide the highest removal efficiency.

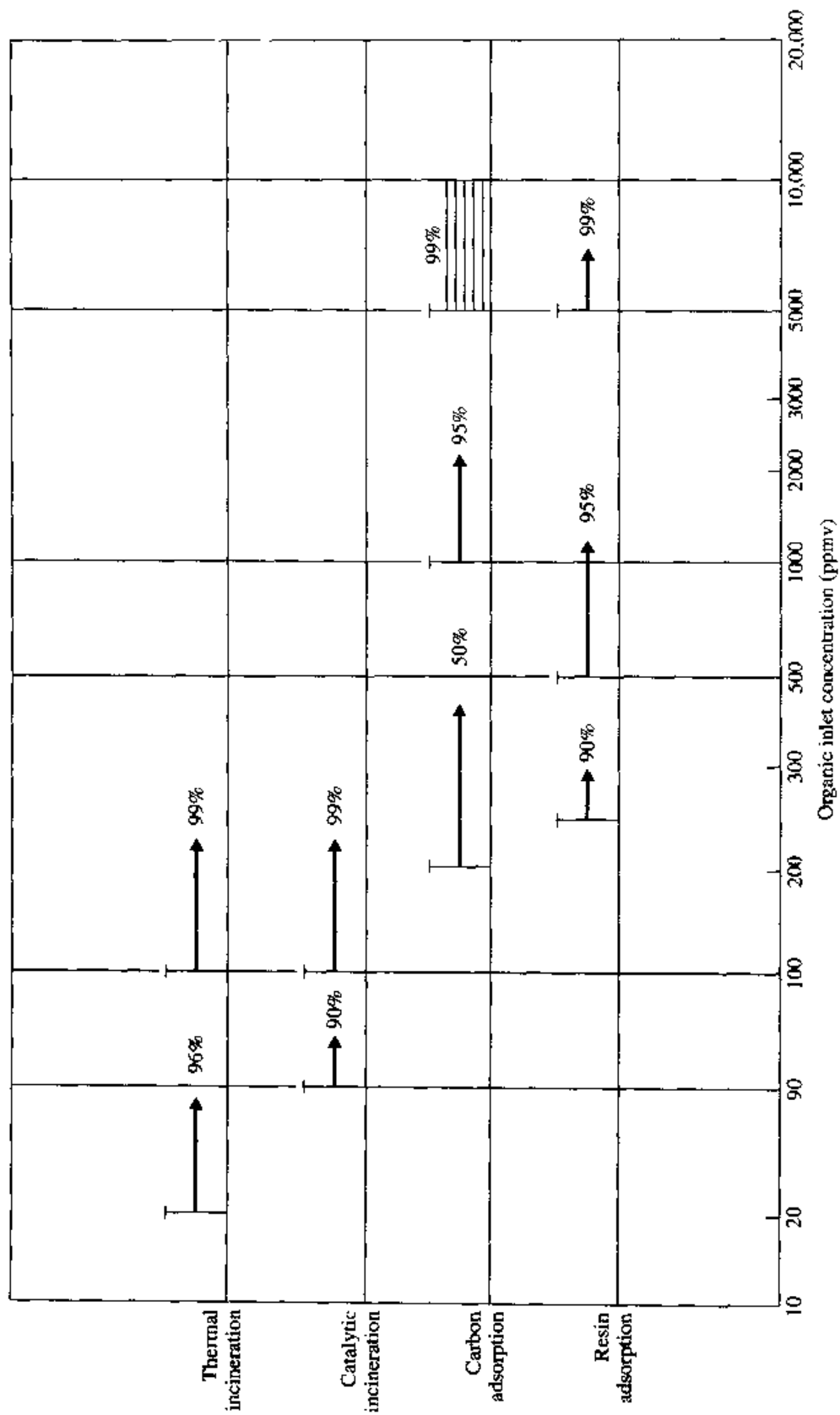
Biological treatment of the off-gas is a less costly alternative to incineration and can be done with static beds of compost material such as peat or corn silage. Granular activated carbon can be added to the bed material to adsorb poorly degradable VOCs. The beds are lightly seeded with biomass and maintained at proper pH, temperature, and moisture content to support biological activity. The off-gas is passed through the bed at surface flow rates of 1 to 10 ft<sup>3</sup>/(min · ft<sup>2</sup>)(0.31 to 3.1 m<sup>3</sup>/min · m<sup>2</sup>) to provide 2 to 12 min of bed contact time. The biomass concentration depends on the type of bed material and organic loading rates.

## 6.8

### NITRIFICATION AND DENITRIFICATION

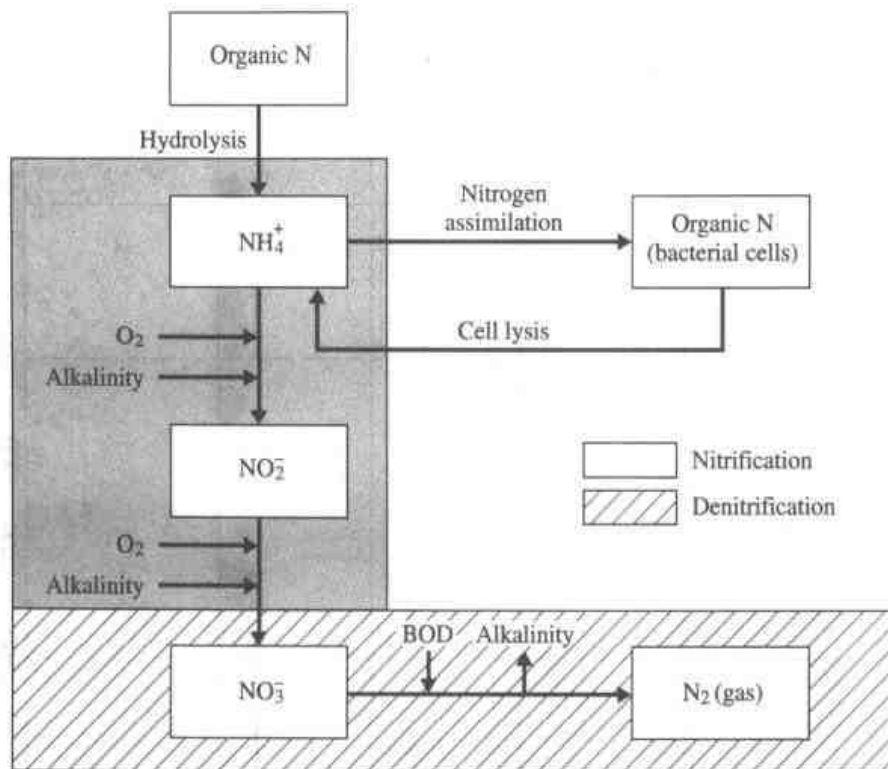
#### Nitrification

Nitrogen changes in a biological-treatment process are shown in Fig. 6.52. Nitrification is the biological oxidation of ammonia to nitrate with nitrite formation as



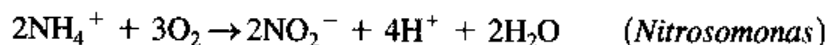
**FIGURE 6.51**  
Performance capabilities of VOC control devices.





**FIGURE 6.52**  
Nitrogen transformations.

an intermediate step. The microorganisms involved are the autotrophic species *Nitrosomonas* and *Nitrobacter*, which carry out the reaction in two steps:



The cell yield for *Nitrosomonas* has been reported as 0.05 to 0.29 mg VSS/mg  $\text{NH}_3\text{-N}$  and for *Nitrobacter* 0.02 to 0.08 mg VSS/mg  $\text{NH}_3\text{-N}$ . A value of 0.15 mg VSS/mg  $\text{NH}_3\text{-N}$  is usually used for design purposes. It is generally accepted that the biochemical reaction rate of *Nitrobacter* is faster than the reaction rate of *Nitrosomonas* and hence there is no accumulation of nitrite in the process and the reaction rate of *Nitrosomonas* will control the overall reaction. Poduska<sup>46</sup> reviewed the results on the effect of micronutrients on the growth of nitrifying bacteria in pure culture as shown in Table 6.19.

### Nitrification Kinetics

In order to maintain a population of nitrifying organisms in a mixed culture of activated sludge, the minimum aerobic sludge age  $(\theta_c)_{\min}$  must exceed the reciprocal of the nitrifiers' net specific growth rate:

$$(\theta_c)_{\min} \cong \frac{1}{\mu_{N_T} - b_{N_T}} \quad (6.50)$$

TABLE 6.19  
Stimulatory concentration of micronutrients for nitrifying bacteria<sup>46</sup>

Compound	Concentration, $\mu\text{g/l}$
Calcium	0.5
Copper	0.005–0.03
Iron	7.0
Magnesium	12.5–0.03
Molybdenum	0.001–1.0
Nickel	0.1
Phosphorus	310.0
Zinc	1.0

where  $\mu_{N_T}$  = nitrifiers' specific growth rate,  $\text{d}^{-1}$ , and  $b_{N_T}$  = nitrifiers' endogenous decay rate,  $\text{g } \Delta\text{VSS}_N / (\text{g } \text{VSS}_N \cdot \text{d})$ . The nitrifiers' specific growth rate is related to the specific nitrification rate

$$\mu_{N_T} = a_N q_N \quad (6.51)$$

in which  $q_N$  = specific nitrification rate,  $\text{d}^{-1}$ , and  $a_N$  = sludge yield coefficient for nitrifiers.

The specific nitrification rate in an activated sludge system depends on the concentrations of ammonia nitrogen in the effluent and dissolved oxygen as well as the pH. The effects of dissolved oxygen and effluent ammonia are defined as follows:

$$q_N = q_{N_M} \cdot \frac{\text{NH}_3\text{-N}}{K_N + \text{NH}_3\text{-N}} \cdot \frac{\text{DO}}{K_O + \text{DO}} \quad (6.52)$$

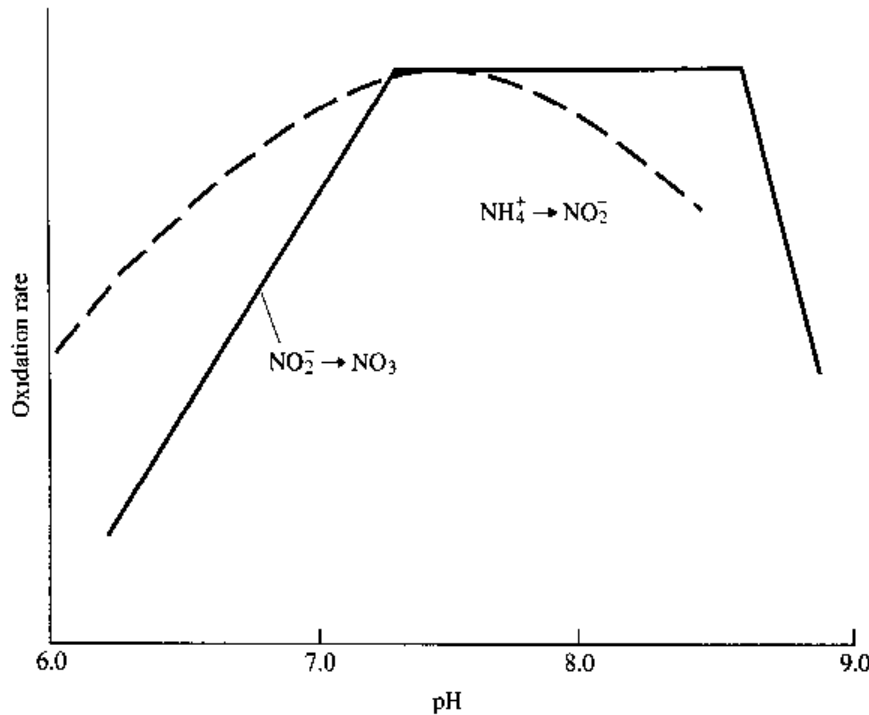
where  $K_N$  and  $K_O$  are the half saturation coefficients for nitrogen and oxygen, respectively. A typical value for  $K_N$  is 0.4;  $K_O$  may vary from 0 to 1.0.

The influence of mixed liquor dissolved oxygen on the nitrification rate has been somewhat controversial, partly because the bulk liquid concentration is not the same as the concentration within the floc where the oxygen is being consumed. Increased bulk liquid dissolved oxygen concentrations will increase the penetration of oxygen into the floc, thereby increasing the rate of nitrification. At a decreased SRT, the oxygen utilization rate due to carbon oxidation increases, thereby decreasing the penetration of oxygen. Conversely, at a high SRT, the low oxygen utilization rate permits higher oxygen levels within the floc, and consequently, higher nitrification rates occur. Therefore, to maintain the maximum nitrification rate, the bulk mixed liquor dissolved oxygen concentration must be increased as the SRT is decreased. This is reflected in the coefficient  $K_O$ .

The effect of pH on nitrification rate is shown in Fig. 6.53.

In treating industrial wastewaters that may inhibit nitrification, the maximum specific nitrification rate must be experimentally determined. The temperature dependence on the specific nitrification rate is given by

$$q_{N(T)} = q_{N(20^\circ\text{C})} \cdot 1.09^{T-20} \quad (6.53)$$



**FIGURE 6.53**  
Effect of pH on ammonia oxidation.<sup>47</sup>

The endogenous decay coefficient  $b_N$  has a temperature coefficient of 1.04:

$$b_N = b_{N(20^\circ\text{C})} \cdot 1.04^{T-20} \quad (6.54)$$

The nitrogen to be oxidized can be computed from

$$N_{\text{ox}} = \text{TKN} - \text{SON} - N_{\text{syn}} - (\text{NH}_3\text{-N})_e$$

in which SON = nondegradable organic nitrogen and  $N_{\text{syn}} = 0.08aS_r$ .

The fraction of nitrifiers can be computed from

$$f_N = \frac{0.15N_{\text{ox}}}{aS_r + 0.15N_{\text{ox}}} \quad (6.55)$$

The overall nitrification rate is

$$R_N = q_N f_N X_{vb} \quad (6.56)$$

in which  $R_N$  is the overall nitrification rate in  $\text{mg}/(\text{l} \cdot \text{d})$ .

The required nitrification detention time is

$$t_N = \frac{N_{\text{ox}}}{R_N}$$

In order to determine the SRT it is necessary to compute the waste activated sludge (WAS):

$$\Delta X_{vb} = (aS_r + 0.15N_{\text{ox}}) - bX_d X_{vb} t_N \quad (6.57)$$

and the SRT is

$$\theta_c = \frac{X_{vb} t_N}{\Delta X_{vb}}$$

The required oxygen is

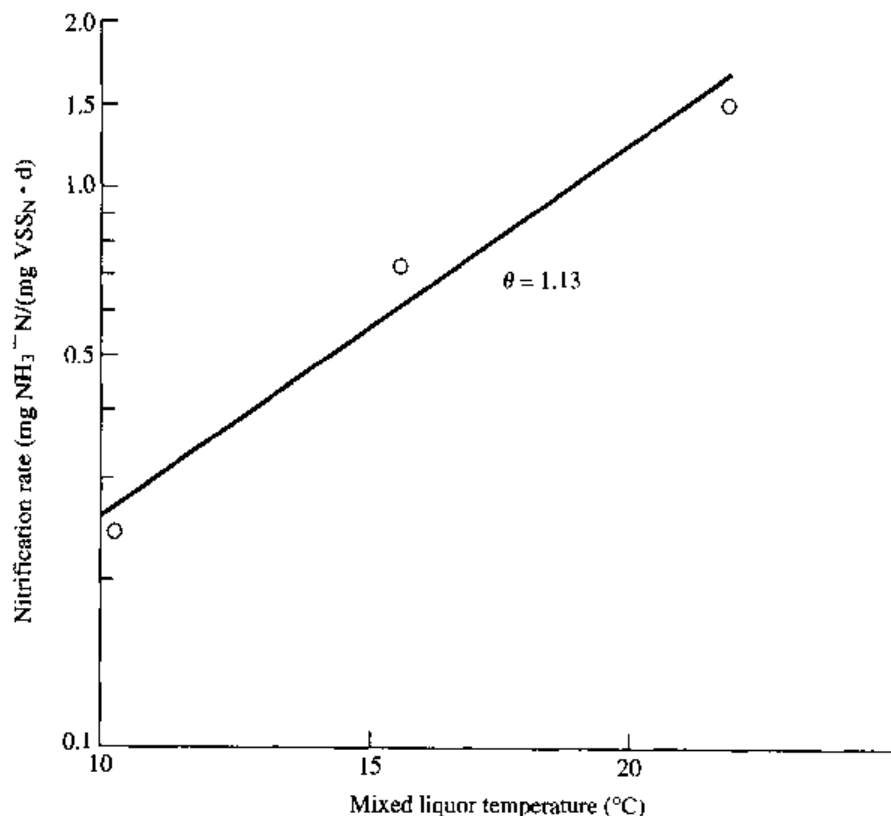
$$O_2 = 4.33N_{ox}$$

and the required alkalinity as  $CaCO_3$  is

$$ALK = 7.15N_{ox}$$

### Nitrification of High-Strength Wastewaters

Wastewaters containing high ammonia concentration and negligible BOD can be treated by biological nitrification. For example, wastewater from a fertilizer manufacturing complex was treated by the activated sludge process. The  $NH_4^+ - N$  content of the influent wastewater varied from 339 to 420 mg/l and inorganic suspended solids varied from 313 to 598 mg/l. The TDS was 6300 mg/l. Because of the high inert suspended solids, the mixed liquor was only 20 percent volatile with a sludge volume index (SVI) of 30 to 40 ml/g. A small fragile floc was generated, which provided an effluent TSS of 55 mg/l. Alkalinity was supplied to the system in the form of sodium bicarbonate. The relationship between nitrification rate and mixed liquor temperature is shown in Fig. 6.54. The temperature correction coefficient,  $\theta$ , was 1.13. This value is significantly higher than for typical domestic wastewater indicating that the nitrification rate was more sensitive to the operating



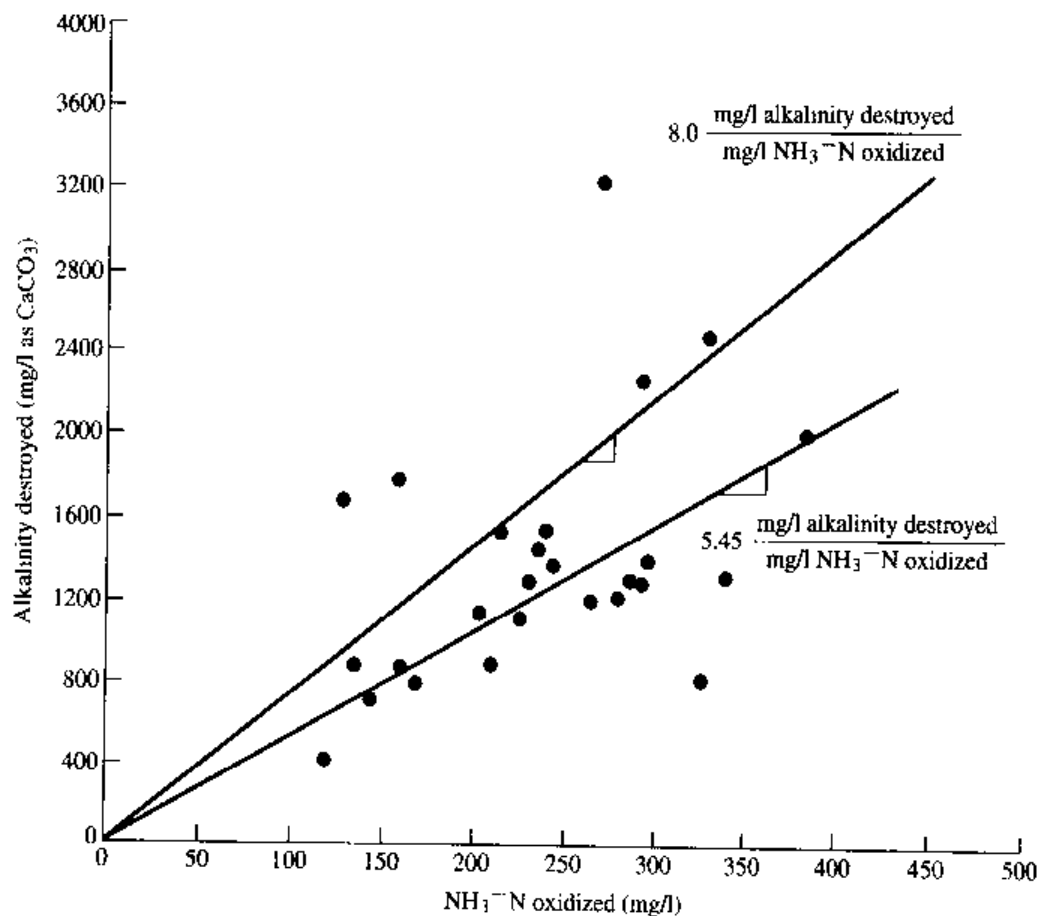
**FIGURE 6.54**

Relationship between nitrification rate and temperature for a fertilizer wastewater.

mixed liquor temperature. The alkalinity requirements showed considerable variation (Fig. 6.55), which was attributed to the presence of alkalinity in the influent suspended solids.

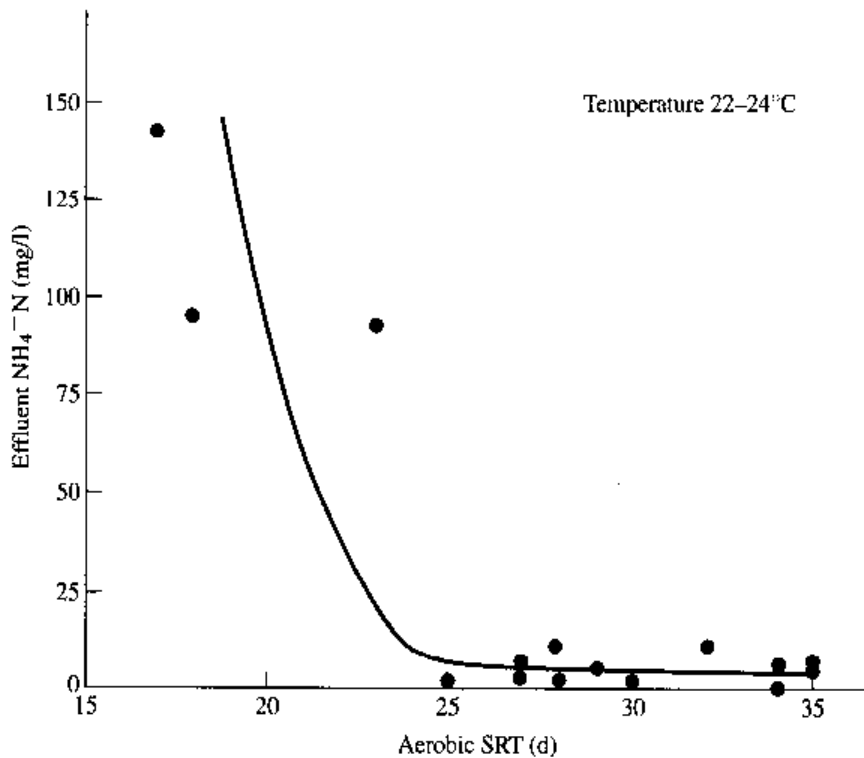
### Inhibition of Nitrification

In treating industrial wastewaters, nitrification is frequently inhibited, or in some instances prevented, by the presence of toxic organic or inorganic compounds. This is shown in Fig. 6.56, which shows the nitrification results for treatment of an organic chemicals wastewater. These data show that a minimum aerobic SRT of 25 d was required to obtain complete nitrification at 22 to 24°C. The minimum SRT required for complete nitrification of municipal wastewater at these temperatures is approximately 4 d. An SRT of 55 to 60 d was required for complete nitrification of this wastewater at 10°C versus approximately 12 d for municipal wastewater. It was also shown that, at a mixed liquor temperature of 10°C, the nitrifiers were less tolerant to variations in influent composition and temperature than were the heterotrophic organisms responsible for BOD removal and denitrification. Similar results were obtained for a wastewater from a coke plant in which the nitrification



**FIGURE 6.55**

Alkalinity utilization in the treatment of a fertilizer wastewater.

**FIGURE 6.56**

Nitrification relative to the aerobic SRT for an organic chemicals wastewater.<sup>53</sup>

rate was approximately one order of magnitude less than that for municipal wastewater, as shown in Fig. 6.57.

Blum and Speece<sup>48</sup> have characterized the toxicity of a variety of organic compounds to nitrification, as summarized in Table 6.20.

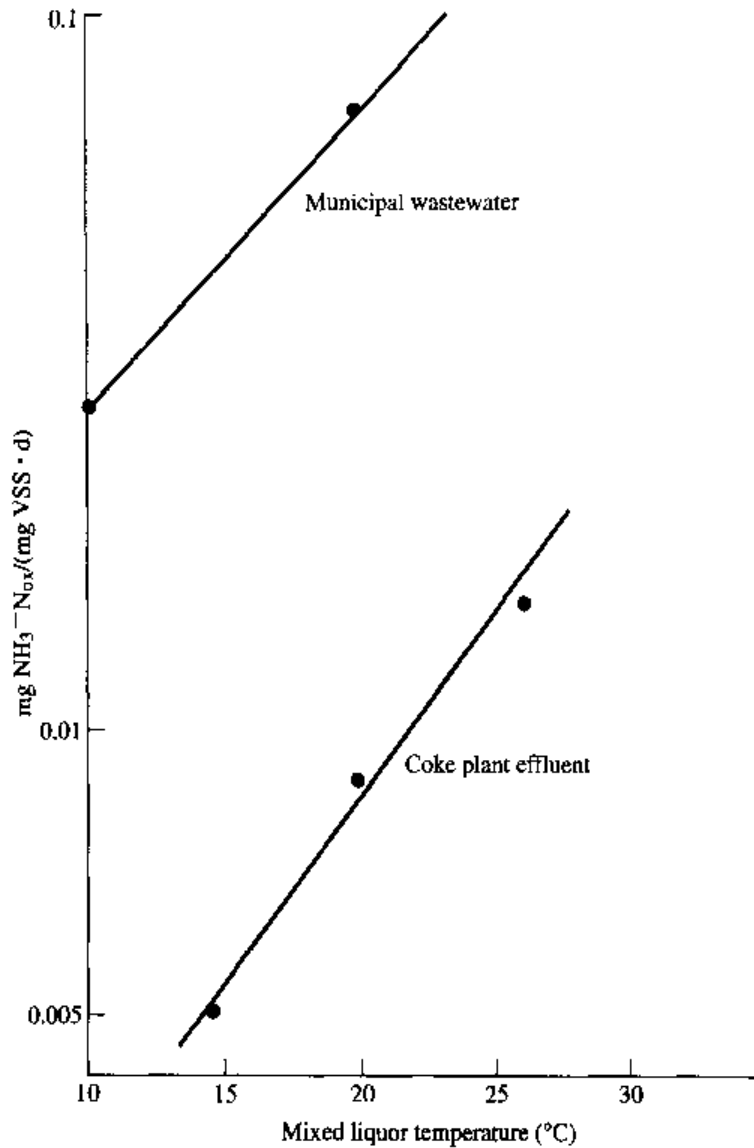
The effect of salt levels on nitrification were discussed by Henning and Kayser.<sup>49</sup> They found that fluoride concentrations of 100 mg/l reduced the nitrification rate by 80%. Sulfate had no effect at concentrations up to 50 g/l. Chlorides, however, showed significant inhibition, as shown in Fig. 6.58. They showed that nitrification rates were reduced up to 60 percent at NO<sub>2</sub><sup>-</sup>N concentrations of several hundred milligrams per liter at pH 8.0.

In cases where nitrification is significantly reduced or totally inhibited, the application of powdered activated carbon (PAC) to adsorb the toxic agents may enhance nitrification. However, in some cases, excessive quantities of PAC are required to achieve single-stage nitrification. In some cases a second-stage nitrification step can be successfully employed after a first-stage biological process for removal of carbonaceous material and reduction of toxicity.

Metals have been found to be toxic to growing *Nitrosomonas* culture (Skinner and Walker<sup>50</sup>) with complete inhibition for the following metals and concentrations: nickel 0.25 mg/l; Cr, 0.25 mg/l; and Cu, 0.1 to 0.5 mg/l.

Cyanide toxicity to nitrifiers is shown in Fig. 6.59.<sup>51, 52</sup>

Un-ionized ammonia (NH<sub>3</sub>) inhibits both *Nitrosomonas* and *Nitrobacter*, as shown in Fig. 6.60.<sup>53</sup> Since the un-ionized fraction increases with pH, a high pH combined with a high total ammonia concentration will severely inhibit or prevent



**FIGURE 6.57**

Relationship between nitrification rate and temperature for municipal wastewater and a coke plant effluent.

complete biological nitrification. Since *Nitrosomonas* is less sensitive to ammonia toxicity than *Nitrobacter*, the nitrification process may only be partially complete and result in accumulation of nitrite ion ( $\text{NO}_2^{2-}$ ). This can have severe consequences since  $\text{NO}_2^{2-}$  is strongly toxic to many aquatic organisms whereas  $\text{NO}_3^-$  is not. Ammonia toxicity to activated sludge biomass is rarely a problem in treating municipal wastewaters, since the concentration of total ammonia is low and the mixed liquor pH is near neutral. Industrial wastewaters with high ammonia levels and the potential for high pH excursions, however, may cause biotoxicity and loss of the nitrification process. Under these conditions, it is necessary to control the mixed liquor pH to avoid biotoxicity due to an ammonia spill or shock load. In extreme cases, two stages operated at different pH values may be required to separate the *Nitrosomonas* and *Nitrobacter* and allow complete nitrification.

TABLE 6.20  
Biodegradability and biotoxicity data<sup>48</sup>

Compound	Bio-degradability	Rate of biodegradation, mg COD/gVSS · h	EC <sub>50</sub> mg/l	
			<i>Nitrosomonas</i>	Heterotrophs
Cyclohexane	A	—	97	29
Octane	A	—	45	—
Decane	C	—	—	—
Dodecane	D	—	—	—
Methylene chloride	D	—	1.2	320
Chloroform	D	—	0.48	640
Carbon tetrachloride	—	—	51	130
1,1-Dichloroethane	—	—	0.91	620
1,2-Dichloroethane	—	—	29	470
1,1,1-Trichloroethane	—	—	8.5	450
1,1,2-Trichloroethane	—	—	1.9	240
1,1,1,2-Tetrachloroethane	—	—	8.7	230
1,1,2,2-Tetrachloroethane	—	—	1.4	130
Pentachloroethane	—	—	7.9	150
Hexachloroethane	—	—	32	—
1-Chloropropane	D	—	120	700
2-Chloropropane	—	—	110	440
1,2-Dichloropropane	—	—	43	—
1,3-Dichloropropane	C	—	4.8	210
1,2,3-Trichloropropane	—	—	30	290
1-Chlorobutane	D	—	120	230
1-Chloropentane	D	—	99	68
1,5-Dichloropentane	—	—	13	—
1-Chlorohexane	D	—	85	83
1-Chlorooctane	—	—	420	52
1-Chlorodecane	D	—	—	40
1,2-Dichloroethylene	D	—	—	—
Trans-1,2-dichloroethylene	—	—	80	1700
Trichloroethylene	A	—	0.81	130
Tetrachloroethylene	—	—	110	1900
1,3-Dichloropropene	—	—	0.67	120
5-Chloro-1-pentyne	—	—	0.59	86
Methanol	A	26	880	20,000
Ethanol	A	32	3900	24,000
1-Propanol	A	71	980	9600
1-Butanol	A	84	—	3900
1-Pentanol	A	—	520	—
1-Hexanol	A	—	—	—
1-Octanol	A	—	67	200
1-Decanol	B	—	—	—
1-Dodecanol	B	—	140	210



TABLE 6.20 (continued)

Compound	Bio-degradability	Rate of biodegradation, mg COD/gVSS · h	EC <sub>50</sub> , mg/l	
			<i>Nitrosomonas</i>	Heterotrophs
2,2,2-Trichloroethanol	—	—	2.0	—
3-Chloro-1,2 propanediol	D	—	—	—
Ethylether	C	—	—	17,000
Isopropylether	D	—	610	—
Acetone	B	—	1200	16,000
2-Butanone	—	—	790	11,000
4-Methyl-2-pentanone	—	—	1100	—
Ethyl-acrylate	—	—	47	—
Butyl-acrylate	—	—	38	470
2-Chloropropionic-acid	A	24	0.04	0.18
Trichloroacetic-acid	D	0	—	—
Diethanolamine	A	16	—	—
Acetonitrile	A	—	73	7500
Acrylonitrile	A	—	6.0	52
Benzene	A	—	13	520
Toluene	A	—	84	110
Xylene	A	—	100	1000
Ethylbenzene	B	—	96	130
Chlorobenzene	D	—	0.71	310
1,2-Dichlorobenzene	—	—	47	910
1,3-Dichlorobenzene	D	—	93	720
1,4-Dichlorobenzene	D	—	86	330
1, 2,3-Trichlorobenzene	—	—	96	—
1,2,4-Trichlorobenzene	D	—	210	7700
1, 3,5-Trichlorobenzene	—	—	96	—
1, 2,3,4-Tetrachlorobenzene	—	—	20	—
1,2,4,5-Tetrachlorobenzene	D	—	9	—
Hexachlorobenzene	D	—	4	350
Benzyl alcohol	A	—	390	2100
4-Chloroanisole	—	—	—	902
2-Furaldehyde	B	37	—	—
Benzonitrile	B	—	32	470
<i>m</i> -Tolunitrile	—	—	0.88	290
Nitrobenzene	A	14	0.92	370
2,6-Dinitrotoluene	—	—	183	—
1-Nitronaphthalene	—	—	—	380
Naphthalene	A	—	29	670
Phenanthrene	C	—	—	—
Benzidine	D	—	—	—
Pyridine	A	—	—	—
Quinoline	A	8.5	—	—
Phenol	A	80	21	1100

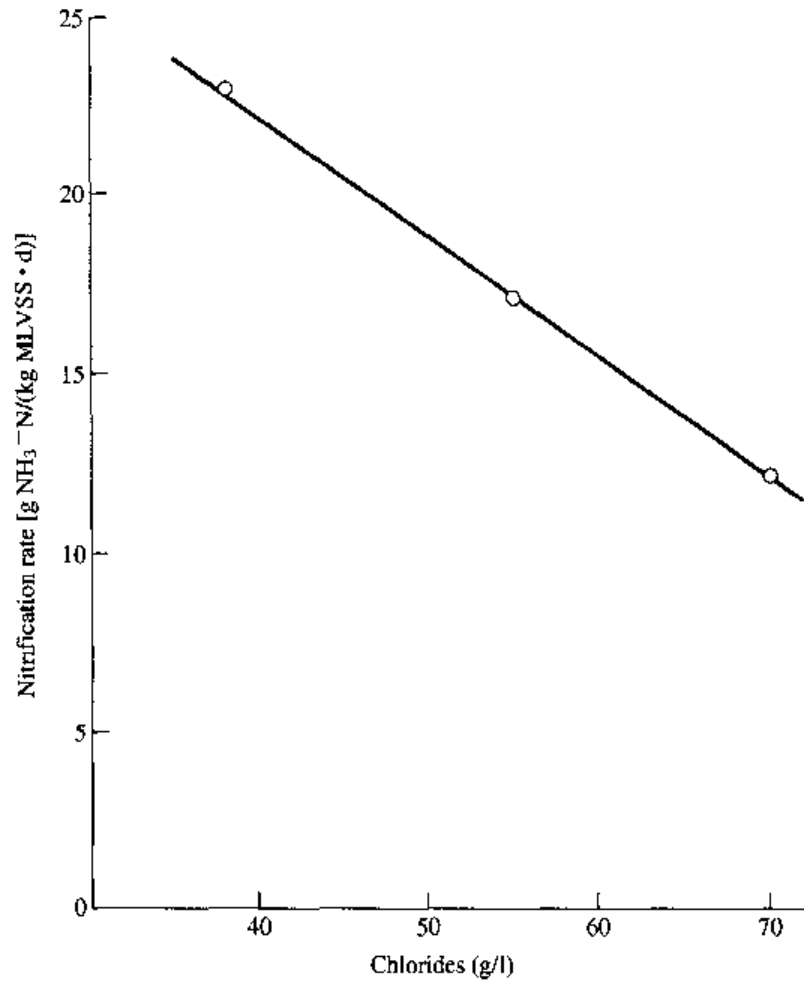
TABLE 6.20 (continued)

Compound	Bio-degradability	Rate of biodegradation, mg COD/gVSS · h	EC <sub>50</sub> , mg/l	
			<i>Nitrosomonas</i>	Heterotrophs
<i>m</i> -Cresol	A	—	0.78	440
<i>p</i> -Cresol	A	—	27	260
2,4-Dimethylphenol	—	28.2	—	—
3-Ethylphenol	—	—	—	144
4-Ethylphenol	—	—	14	—
2-Chlorophenol	—	—	2.7	360
3-Chlorophenol	—	—	0.20	160
4-Chlorophenol	A	39.8	0.73	98
2,3-Dichlorophenol	—	—	0.42	210
2,4-Dichlorophenol	—	10.5	0.79	—
2,5-Dichlorophenol	—	—	0.61	180
2,6-Dichlorophenol	—	—	8.1	410
3,5-Dichlorophenol	—	—	3.0	—
2,3,4-Trichlorophenol	—	—	52	7.8
2,3,5-Trichlorophenol	—	—	3.9	—
2,3,6-Trichlorophenol	—	—	0.42	14
2,4,5-Trichlorophenol	—	—	3.9	23
2,4,6-Trichlorophenol	—	—	7.9	—
2,3,5,6-Tetrachlorophenol	—	—	1.3	1.5
Pentachlorophenol	—	—	6.0	—
2-Bromophenol	—	—	0.35	—
4-Bromophenol	B	—	0.83	120
2,4,6-Tribromophenol	—	—	7.7	—
Pentabromophenol	—	—	0.27	—
Resorcinol	A	57.5	7.8	—
Hydroquinone	B	54.2	—	—
2-Aminophenol	—	21.1	0.27	0.04
4-Aminophenol	—	16.7	0.07	—
2-Nitrophenol	—	14.0	11	11
3-Nitrophenol	—	17.5	—	—
4-Nitrophenol	A	16.0	2.6	160
2,4-Dinitrophenol	—	6.0	—	—

All *Nitrosomonas* and aerobic heterotroph data corrected for pKa (ionization) and H (gas/liquid partitioning).

$$A = \frac{\text{BOD}}{\text{TOD}} > 50\%; \text{ readily biodegradable} \quad C = \frac{\text{BOD}}{\text{TOD}} < 10\% - 25\%; \text{ refractory}$$

$$B = \frac{\text{BOD}}{\text{TOD}} 25\% - 50\%; \text{ moderately biodegradable} \quad D = \frac{\text{BOD}}{\text{TOD}} < 10\%; \text{ nondegradable}$$

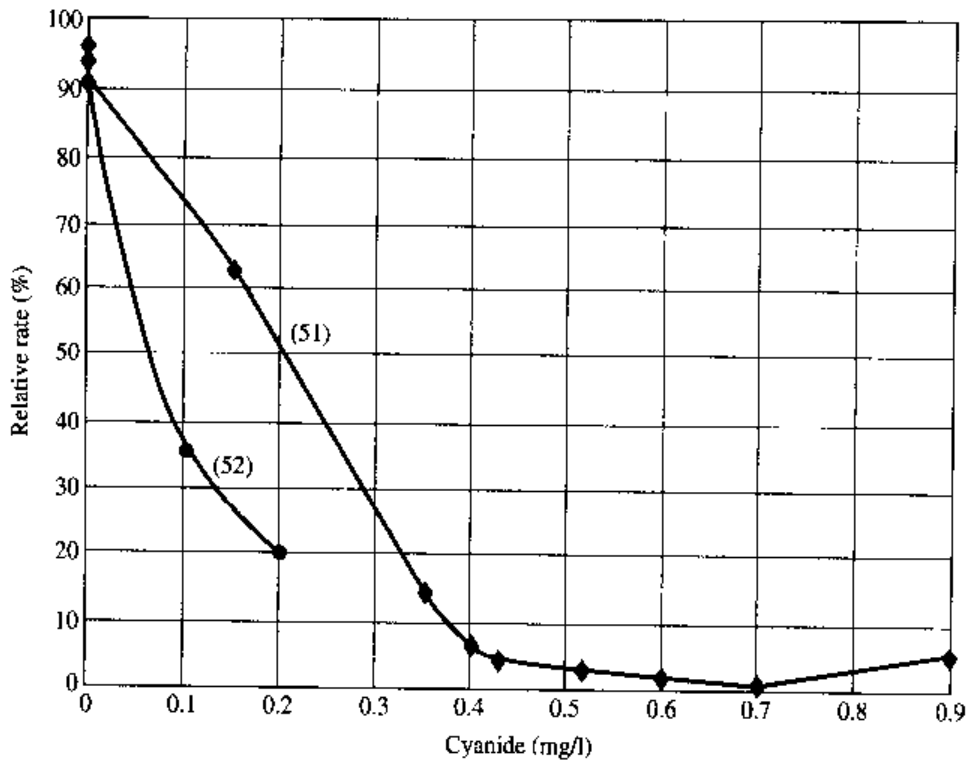


**FIGURE 6.58**  
Nitrification kinetics at different chloride concentrations.

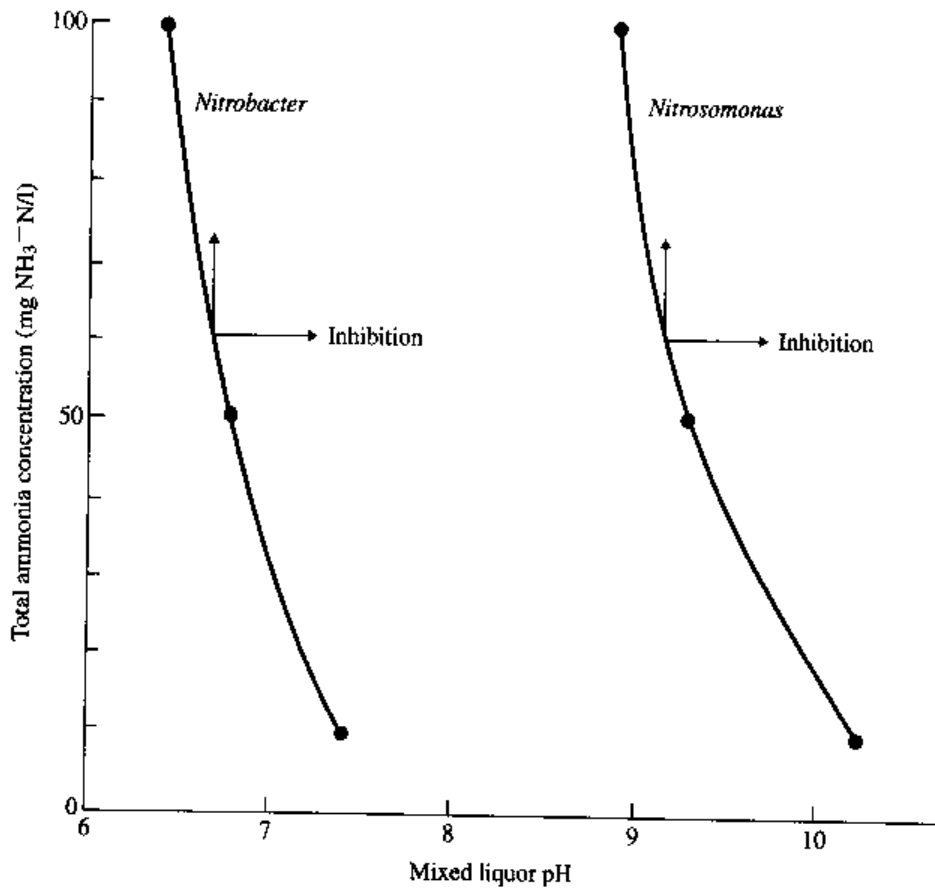
Unfortunately, many industrial wastewaters contain these and other compounds, which alone or together exert a greater but undetermined inhibition effect on the nitrification process. It is essential, therefore, to determine the specific nitrification rate  $q_N$  and the  $(\theta_c)_{\min}$  required to achieve nitrification under actual operating conditions. The value of  $q_N$  can be determined using either a batch activated sludge (BAS) test or the semicontinuous fed batch reactor method.

### Batch Activated Sludge Nitrification

In the BAS test procedure, a wastewater sample is aerated in the presence of an actively nitrifying sludge. The sludge can be obtained from either a municipal activated sludge plant with negligible industrial load or developed separately from a commercially available nitrifier culture. Regardless of the sludge source, it must be possible to quantify the mass of nitrifiers in the bulk MLVSS concentration since  $q_N$  is expressed per unit of nitrifier mass ( $VSS_N$ ). The initial  $\text{NH}_3\text{-N}$  concentration in the BAS test should be between 20 and 50 mg/l to eliminate substrate-induced



**FIGURE 6.59**  
Relative rate of nitrification as function of cyanide.<sup>51, 52</sup>



**FIGURE 6.60**  
Ammonia inhibition in the activated sludge process.<sup>53</sup>

toxicity. If the wastewater contains organic nitrogen, then TKN should also be measured to account for biohydrolysis during the test. Finally, the alkalinity should be adjusted with sodium bicarbonate ( $\text{NaHCO}_3$ ) to provide 7.15 mg alkalinity as  $\text{CaCO}_3$  mg TKN plus a 50 mg/l residual. A control test should be run using the same initial  $\text{NH}_3\text{-N}$  concentration. The wastewater and control sample should be vigorously aerated and aliquots withdrawn over time for analysis.

The results of a BAS nitrification test conducted at  $T = 21^\circ\text{C}$  are shown in Fig. 6.61 for a mixed liquor from a municipal wastewater treatment plant. On the basis of the plant's historical operating data and Eq. (6.54), the fraction of nitrifiers ( $f_N$ ) in the MLVSS was 0.0245 mg  $\text{VSS}_N/\text{mg VSS}$ . Initially, the wastewater had negligible  $\text{NO}_3\text{-N}$  and organic nitrogen and an  $\text{NH}_3\text{-N}$  concentration of 48 mg/l. After 24 h of aeration, 38 mg/l  $\text{NO}_3\text{-N}$  was produced.

The overall specific  $\text{NH}_3\text{-N}$  oxidation rate was

$$\frac{38 \text{ mg}/(1 \cdot \text{d})}{1200 \text{ mg VSS}/\text{l}} = 0.032 \text{ mg NH}_3\text{-N}/(\text{mg MLVSS} \cdot \text{d})$$

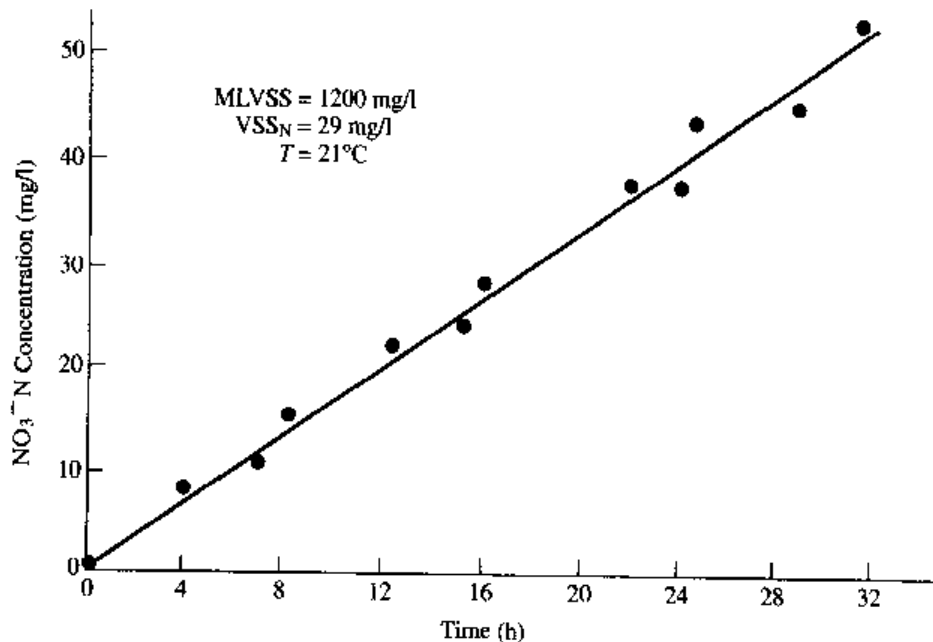
The nitrifier specific nitrification rate was

$$q_N = 0.032/0.0245 = 1.3 \text{ mg N}/(\text{mg VSS}_N \cdot \text{d})$$

The nitrifier specific growth rate for  $a_N = 0.15 \text{ mg}/\text{mg}$  was  $0.195 \text{ d}^{-1}$ . Neglecting temperature effects, and with  $b_N = 0.05 \text{ d}^{-1}$  the  $(\theta_c)_{\min}$  is

$$(\theta_c)_{\min} = \frac{1}{0.195 - 0.05} = 6.9 \text{ d}$$

The  $(\theta_c)_{\min}$  for municipal wastewater at  $T = 21^\circ\text{C}$  is approximately 4 d, indicating a two-fold inhibition effect on nitrification by the industrial wastewater. The  $\theta_c$  design would be determined using  $(\theta_c)_{\min}$  and an appropriate safety factor.



**FIGURE 6.61**

Results of batch nitrification test.

It should be noted that the BAS nitrification test used an existing sludge with a known  $f_N$  and  $VSS_N$  concentration to determine  $q_N$ . The actual mixed liquor established for treatment of this wastewater will have a different  $f_N$  value depending on its  $NH_3^-N$  and BOD concentrations. This nitrifier fraction and the measured  $q_N$  should be used to determine the hydraulic retention time required in the aeration basin.

### Fed Batch Reactor Nitrification Test

The FBR procedure described on p. 268 can also be used to determine the nitrification rate. The requirements for sludge characterization and alkalinity addition are the same as for the BAS nitrification test. The wastewater is added to the reactor at a constant rate, and aliquots are withdrawn over time for analysis. Nitrate ( $NO_3^-N$ ) and nitrite ( $NO_2^-N$ ) production is the preferred method of expressing the test results and determining  $q_N$ , since it eliminates adjustments needed to account for biohydrolysis and cell synthesis. If  $NH_4^-N$  removal is used, however, then TKN and COD (or BOD) must also be measured to complete the nitrogen balance.

The results of FBR nitrification tests with and without PAC addition (200 mg/l) are presented in Fig. 6.62. The mixed liquor had a  $VSS_N = 500$  mg/l, and the wastewater sample initially had significant concentrations of BOD, organic nitrogen, and  $NO_3^-N$ . The nitrification rates were calculated as the difference between the slopes of the two linear traces. They indicate that addition of 200 mg/l of PAC increased the nitrification rate from 0.6 to 1.45 mg  $NO_3^-N$ /(mg  $VSS_N \cdot d$ ). The  $(\theta_c)_{min}$  can be calculated as in the BAS nitrification test procedure.

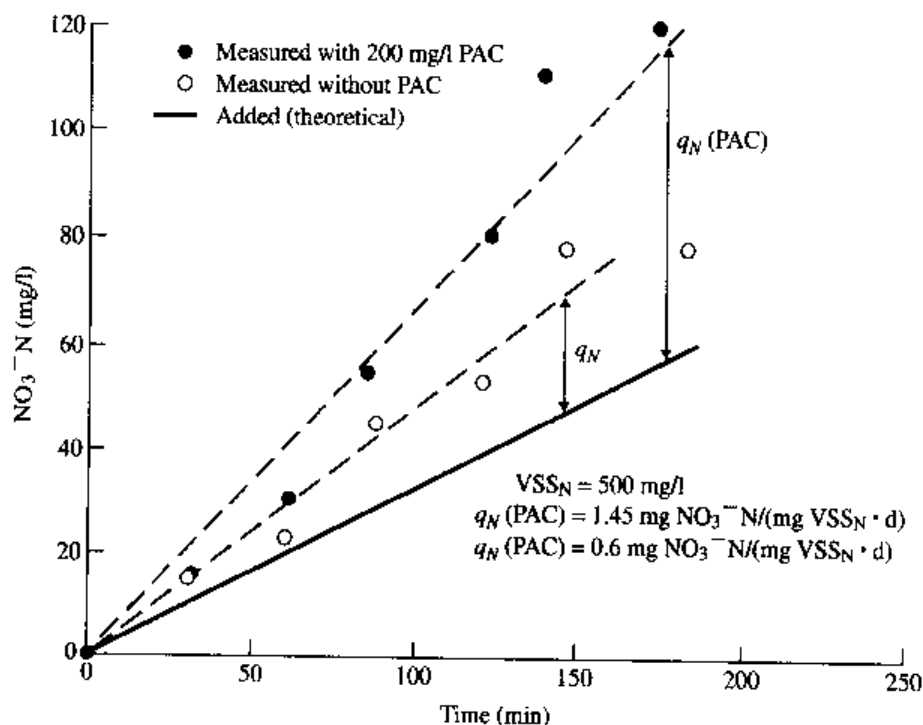
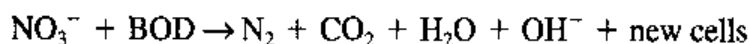


FIGURE 6.62

Determination of nitrification rate using FBR procedure with and without PAC addition.

## Denitrification

Some industrial wastewaters such as those from fertilizer, explosive/propellant manufacture, and the synthetic fibers industry contain high concentrations of nitrates, while others generate nitrates by nitrification. Since biological denitrification generates one hydroxyl ion while nitrification generates two hydrogen ions, it may be advantageous to couple the nitrification and denitrification processes to provide "internal" buffering capacity. While many organics inhibit biological nitrification, this is not generally true for denitrification. Sutton et al.<sup>54</sup> showed that denitrification rates for an organic chemicals plant wastewater were comparable to those observed using nitrified municipal wastewater; however, biological nitrification of the organic chemicals wastewater was severely inhibited. Denitrification uses BOD as a carbon source for synthesis and energy and nitrate as an oxygen source.



The denitrification process consumes approximately 3.7 g COD per g  $\text{NO}_3^- \text{N}$  reduced and produces 0.45 g VSS and 3.57 g alkalinity per g  $\text{NO}_3^- \text{N}$  reduced. This amounts to one-half the alkalinity that is consumed during nitrification. Some of this alkalinity, however, is lost by reaction with the  $\text{CO}_2$  generated by microbial respiration.

Orhon et al.<sup>55</sup> compared the sludge yield under aerobic conditions to anoxic conditions as shown in Table 6.21. McClintock et al.<sup>56</sup> showed that the biomass yield under anoxic conditions was 54 percent that under aerobic conditions and that the endogenous coefficient was 51 percent that under aerobic conditions. Comparative sludge yield will be a function of SRT.

The rate of denitrification  $q_{\text{DN}}$  is zero order to  $\text{NO}_3^- \text{N}$  concentrations of approximately 1.0 mg N/l and is determined by

$$q_{\text{DN}} = \frac{(\text{NO}_3^- \text{N})_o - (\text{NO}_3^- \text{N})_e}{X_{vb} t} \quad (6.58)$$

where  $q_{\text{DN}}$  = denitrification rate, g  $\text{NO}_3^- \text{N}/(\text{g VSS} \cdot \text{d})$ , and  $X_{vb}$  = nonnitrifier biomass under aeration, mg VSS/l. The denitrification rate is adjusted for mixed liquor temperature and bulk dissolved oxygen (DO) concentration by Eq. (6.59).

$$q_{\text{DN}_T} = q_{\text{DN}(20^\circ)} C \cdot \theta_{\text{DN}}^{T-20} (1 - \text{DO}) \quad (6.59)$$

TABLE 6.21  
Sludge yield coefficient (based on COD)<sup>55</sup>

Wastewater	Aerobic	Anoxic, g cell COD/g COD
Domestic sewage	0.63	0.50
Meat processing	0.64	0.51
Dairy	0.65	0.52
Confectionery	0.72	0.61

The temperature coefficient  $\theta_{DN}$  varies from 1.07 to 1.20.

While oxygen inhibits denitrifying facultative bacteria depending on plant operating conditions, flocs may contain anoxic zones where denitrification will occur even when the liquid contains dissolved oxygen.

OH and Silverstein<sup>57</sup> showed that the IAWQ relationship was more applicable at high dissolved oxygen levels

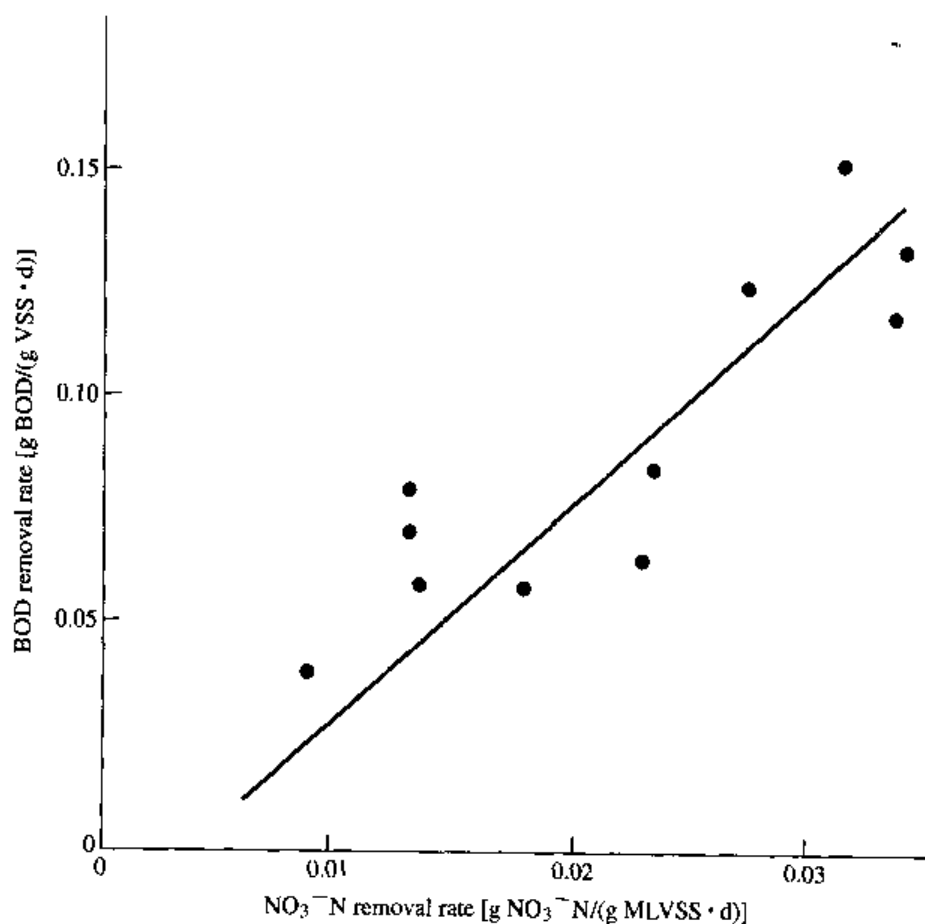
$$q_{DN} = q_{DN(\max)} \left( \frac{1}{1 + DO/k} \right) \quad (6.59a)$$

A suggested value for  $k$  is 0.38 mg/l. It is assumed that  $k$  will be a function of floc size and hence power level in the aeration basin.

Field experience has shown that as much as 10 to 25 percent denitrification can occur under aerobic conditions in aeration basins.

Results of denitrification of an organic chemicals plant wastewater are shown in Fig. 6.63. The temperature effect on denitrification using continuous flow and batch reactors is shown in Fig. 6.64.

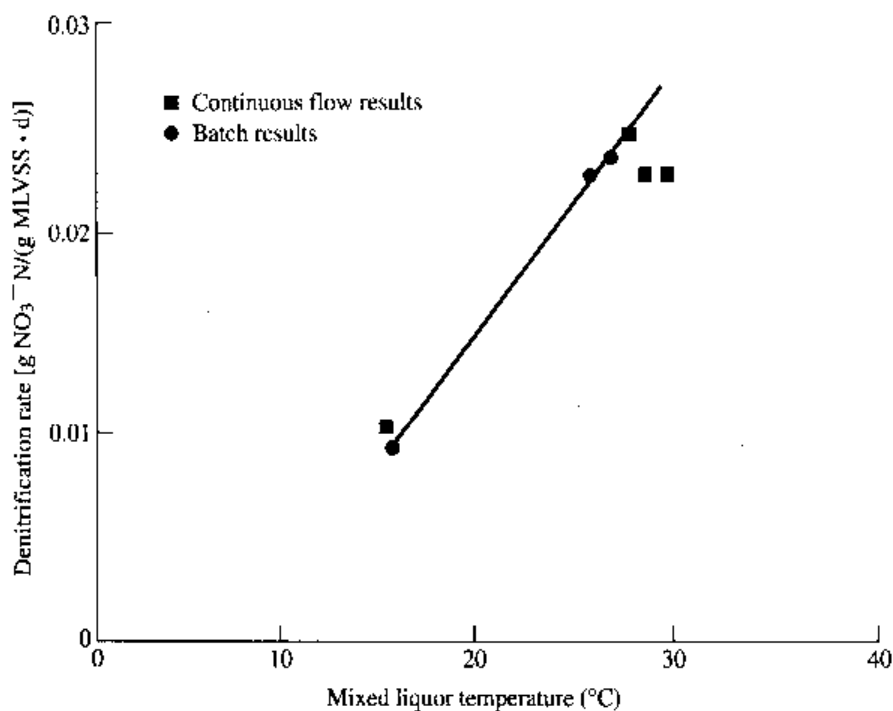
The denitrification rate will depend on the biodegradability of the organics in the wastewater and the concentration of active biomass under aeration similar to



**FIGURE 6.63**

Relationship between nitrate reduction and BOD removal for an organic chemicals wastewater.





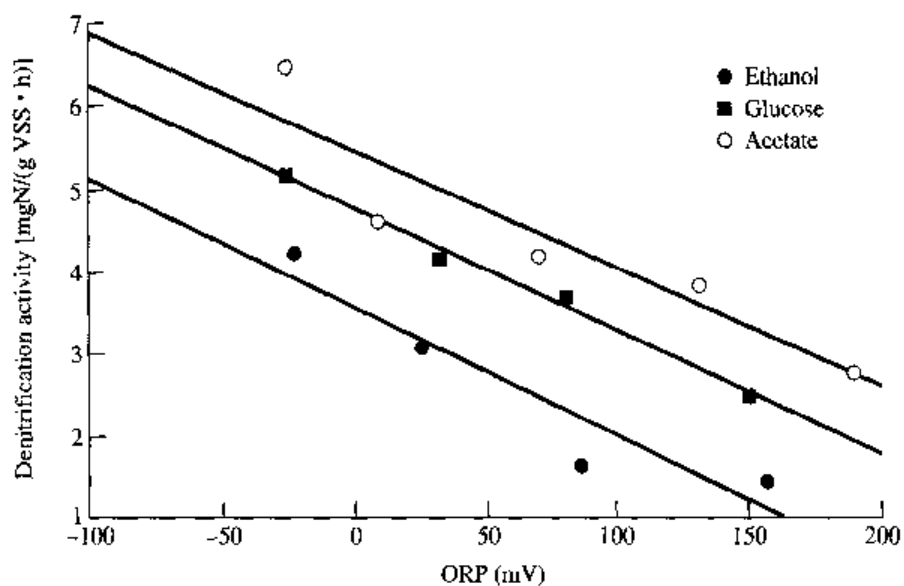
**FIGURE 6.64**

Relationship between denitrification rate and temperature for an organic chemicals wastewater.

the aerobic process. This, in turn, is related to both the SRT or  $F/M$  and the presence of inert solids in the sludge. As the  $F/M$  increases, the concentration of active biomass and the rate of denitrification increase. Although denitrification can occur under endogenous conditions (low  $F/M$ ), using internal biomass reserves, it is very slow and requires long hydraulic retention times. Since the rate of denitrification is affected by both wastewater characteristics and process design parameters, it is usually necessary to determine the rate by experimental means. A batch denitrification test should be conducted in which sludge and wastewater are mixed under anoxic conditions [oxidation reduction potential (ORP) = -100 mV], and the residual  $\text{NO}_3^- \text{N}$  concentration is determined with time. Depending on the organic composition of the wastewater, one of several removal rate relationships may be obtained. For a complex wastewater in a plug flow system, a pseudo first-order relationship may exist. In a complete mix system the rate will be proportional to the fraction of organics remaining in solution. Lie and Welander<sup>58</sup> have shown that the denitrification rate can be related to the ORP as shown in Fig. 6.65.

The denitrification rate for a wastewater can also be estimated from the oxygen uptake rate. In this case, the wastewater–anoxic sludge mixture is aerated and the SOUR determined over time. Correlation of  $R_{\text{DN}}$  and SOUR indicated that 1.0 mg  $\text{NO}_3^- \text{N}$  is equivalent to approximately 3.0 mg  $\text{O}_2$ , which is in good agreement with the theoretical value of 2.86 mg  $\text{NO}_3^- \text{N}/\text{mg O}_2$ .

In cases where a carbon source is not available in the wastewater, methanol has been used as a carbon source. Various industrial effluents can also be used as a carbon source. Baumann and Krauth<sup>59</sup> have summarized various carbon sources as shown in Table 6.22.



**FIGURE 6.65**  
Denitrification activity versus ORP for activated sludge from Sjölanda pilot plant with addition of different carbon sources.

**TABLE 6.22**  
**List of possible industrial wastes or waste by-products for denitrification<sup>59</sup>**

Industry	BOD <sub>5</sub> , mg/l	COD, mg/l	DN rate, mg NO <sub>3</sub> <sup>-</sup> -N/(g MLSS · h)
<b>Chemical industry</b>			
Deicing agent (airfield)	65,000	118,000	1.98–3.06
Glue production I	148,500	282,400	0.96–1.26
Glue production II	1,080,000	1,340,000	1.14–2.12
Pharmaceutical industry I	136,000	188,100	4.08
Pharmaceutical industry II	163,000	320,000	1.14–1.53
Photographic industry	126,000	686,000	1.59–1.70
<b>Food industry</b>			
Alcohol production	3,780	7,300	
Fusel oil	1,320,000	1,780,000	2.79–3.18
Milk processing industry	4,880	7,440	
Plant and vegetable processing	20,650	26,050	4.29
Slaughterhouse	183,000	246,000	1.44
Wine industry	173,100	211,100	5.40
Yeast industry	26,900	28,770	2.79–3.18
<b>Common substrates</b>			
Acetic acid		1,056,000	3.35
Endogenous			0.26–0.65

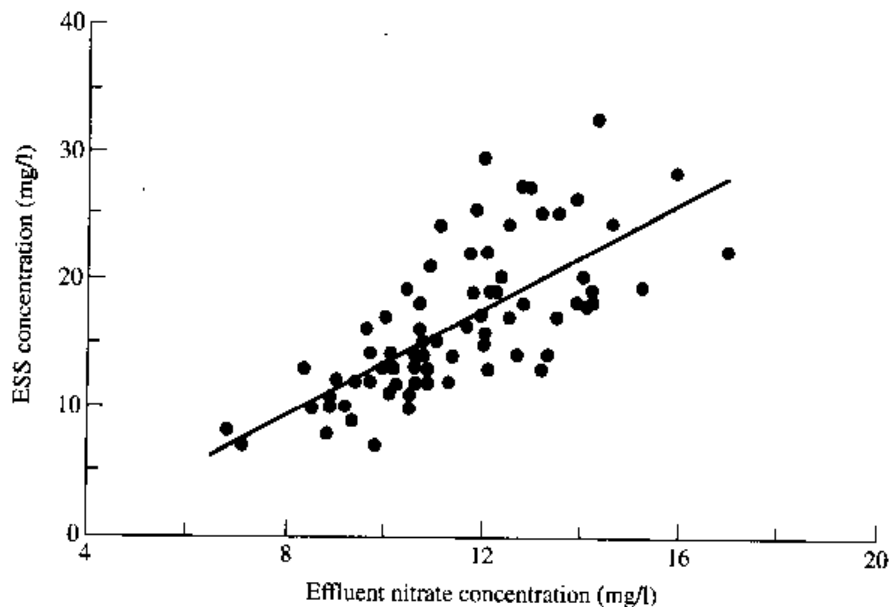
Temperature: 13–16°C

Denitrification in final clarifiers causes floating sludge and increased effluent suspended solids. The nitrogen gas rate production depends on the carbon source available for denitrification, the SRT, temperature and sludge concentration.<sup>60</sup> Henze et al.<sup>60</sup> estimated that 6 to 8 and 8 to 10 mg/l  $\text{NO}_3^- \text{N}$  needs to be denitrified in the sludge blanket to cause sludge flotation at 10 and 20°C, respectively. Most denitrification results from endogenous respiration and the utilization of adsorbed slowly degradable organics. This in turn is related to the active mass, which is a function of SRT. A relationship between effluent suspended solids and effluent nitrate concentration is shown in Fig. 6.66. The ATV<sup>61</sup> limits the thickening time in secondary clarifiers with nitrification to 1.0 to 1.5 h.

### Nitrification and Denitrification Systems

A number of alternative treatment systems are available to achieve nitrification and denitrification, in which some form of aerobic-anoxic sequencing is provided. The systems differ in whether they utilize a single sludge or two sludges in separate nitrification and denitrification reactors. The single-sludge system uses one basin and clarifier and the raw wastewater or endogenous reserves as the carbon and energy sources for denitrification.

The two-sludge system uses two basins with separate clarifiers to isolate the sludges. A supplemental carbon source such as methanol ( $\text{CH}_3\text{OH}$ ) is provided to the second stage for the carbon and energy source. The simplest configuration of the single-sludge system enables carbonaceous oxidation, nitrification, and denitrification to occur in a single basin by positioning the return sludge and aeration

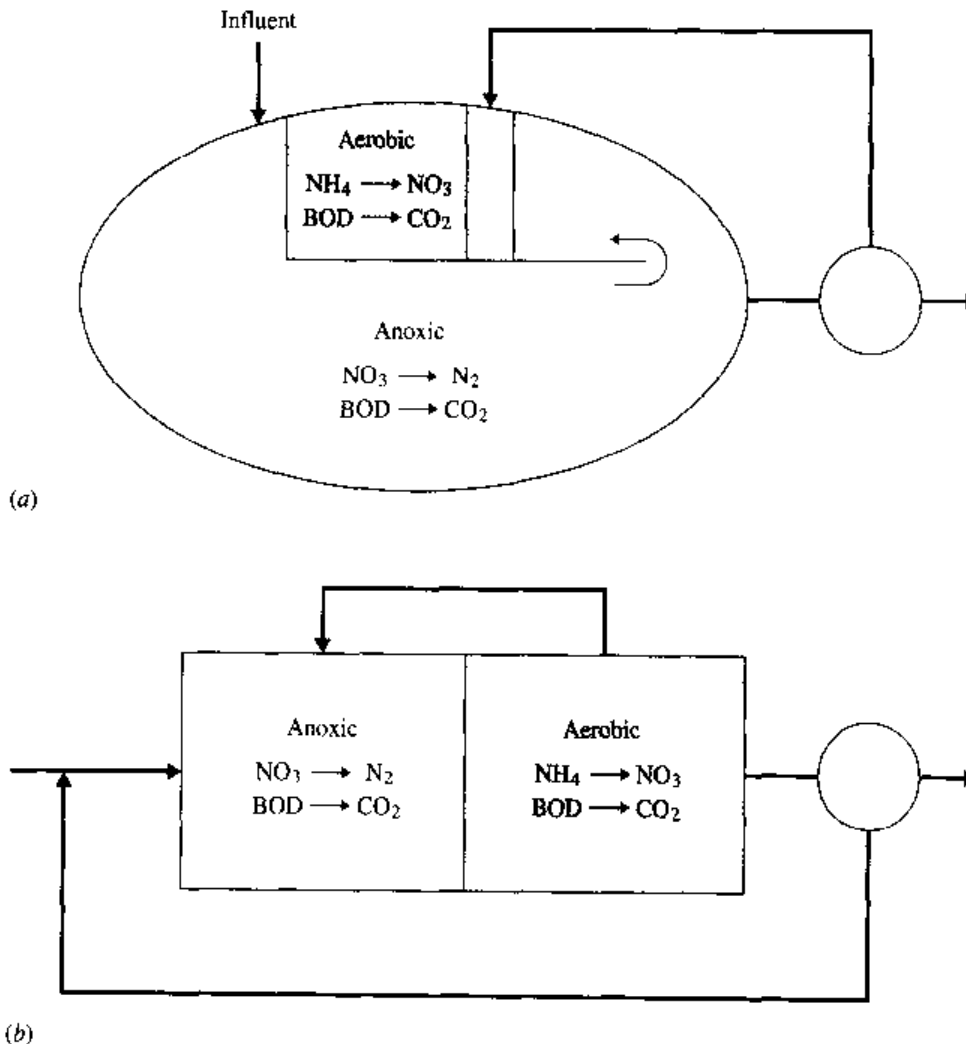


**FIGURE 6.66**

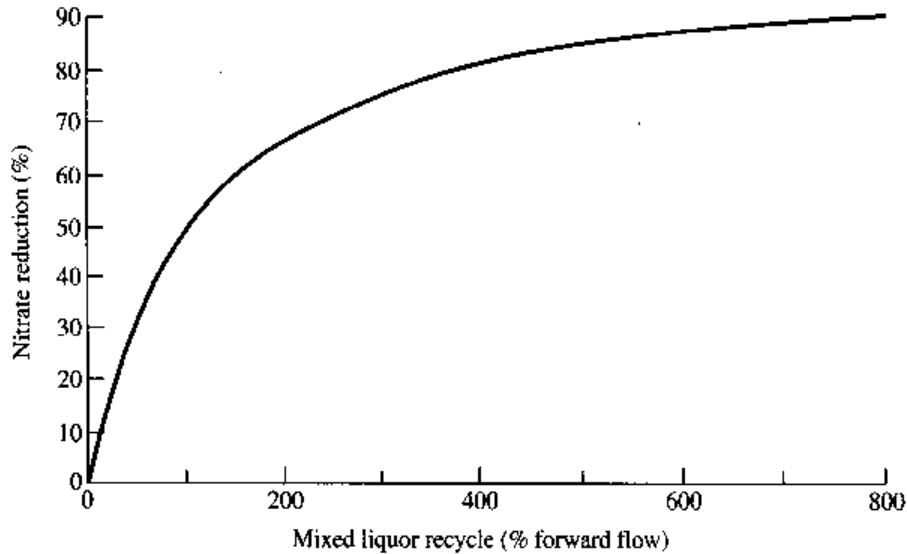
Effluent suspended solids concentration as a function of effluent nitrate concentration at a large nitrification/denitrification plant.<sup>54</sup>

equipment to maintain defined aerobic-anoxic zones in different basin sections. An alternative single-sludge system utilizes a single basin for both aeration and sedimentation by providing intermittent aeration and nonaeration cycles to yield aerobic and anoxic phases of sufficient duration to permit nitrate reduction. Two process flow configurations for single-sludge nitrification and denitrification are shown in Fig. 6.67. In the oxidation ditch (Fig. 6.67a), an aerobic zone exists in the vicinity of the aerator. As the mixed liquor passes away from the aerator, the dissolved oxygen is depleted. Anoxic conditions then exist, and denitrification occurs. This sequence is repeated around the ditch at each aerator installation.

In the internal recycle single-sludge process (Fig. 6.67b), nitrification occurs under aerobic conditions in the second basin. The second basin may be a separate tank (without intermediate clarification) or a single tank with internal baffles to isolate the aerobic and anoxic zones without short-circuiting. Each of these zones can be plug flow or CMAS. An internal recycle flow  $Q_{R,in}$  is



**FIGURE 6.67**  
Alternative single-stage nitrification-denitrification systems.

**FIGURE 6.68**

Theoretical nitrate removal using internal mixed liquor recycle in single-sludge system.

employed from the end of the aerobic basin to the inlet of the anoxic basin in which denitrification occurs. The total recycle ratio can be calculated by Eq. (6.60) and is shown in Fig. 6.68.

$$R = \frac{1}{(1 - f)} - 1 \quad (6.60)$$

where  $R$  = total return sludge rate, percent =  $(Q_R + Q_{R, \text{id}})/Q_o$   
 $f$  = overall denitrification efficiency

Nitrification and denitrification design is illustrated by Examples 6.13 and 6.14.

**EXAMPLE 6.13.**

- Design a nitrification system to produce an effluent  $\text{NH}_3\text{-N}$  of 1 mg/l at 20°C. The influent TKN is 40 mg/l and the  $\text{BOD}_5$  is 210 mg/l.
- What must the HRT and SRT be increased to if the temperature is 15°C?
- What will the maximum  $\text{NH}_3\text{-N}$  concentration effluent be if the influent  $\text{NH}_3\text{-N}$  increases to 60 mg/l at 20°C?

Conditions:

$$\begin{aligned} D_o &= 2.0 \text{ mg/l} \\ q_{N(\text{max})} &= 1.3 \text{ mg NH}_3\text{-N}(\text{mg VSS}_N \cdot \text{d}) \\ a_N &= 0.15 \\ a_H &= 0.6 \\ \text{SON} &= 1 \text{ mg/l} \\ \text{SBOD}_e &= 10 \text{ mg/l} \\ X_v &= 3000 \text{ mg/l} \\ b_N &= 0.05 \text{ d}^{-1} \\ b_H &= 0.1 \text{ d}^{-1} \end{aligned}$$

**Solution.**

(a)

$$q_N = q_{N(\max)} \frac{(\text{NH}_3\text{-N})_e}{0.4 + (\text{NH}_3\text{-N})_e} \cdot \frac{\text{DO}}{(0.2 + \text{DO})}$$

$$= 1.3 \frac{1}{(0.4 + 1)} \cdot \frac{2}{(0.2 + 2)} = 0.84 \text{ d}^{-1}$$

$$N_{\text{ox}} = \text{TKN} - (\text{NH}_3\text{-N})_e - 0.08 \cdot a_H S_r - \text{SON}$$

$$= 40 - 1 - 0.08 \cdot 0.6 \cdot 200 - 1 = 28.4 \text{ mg/l}$$

The nitrifier fraction is

$$f_N = \frac{0.15 \times 28.4}{0.6 \times 200 + 0.15 \times 28.4} = 0.034$$

The nitrification rate is

$$r_N = 0.84 \times 0.034 \times 3000 = 86 \text{ mg/(l} \cdot \text{d)}$$

The required hydraulic detention time is

$$t_N = \frac{28.4}{86} = 0.33 \text{ d}$$

The sludge production is

$$\Delta X_{vb} = (a_H S_r + 0.15 N_{\text{ox}}) - [b_H(1 - f_N) + b_N f_N] X_d X_{vb} t_N$$

$$= (0.6 \times 200 + 0.15 \cdot 28.4) - [0.1(1 - 0.034)$$

$$+ 0.05 - 0.034] 0.62 \times 3000 \times 0.33$$

$$= 124 - 58 = 66 \text{ mg/l}$$

$$\theta_c = \frac{3000 \times 0.33}{66} = 15 \text{ d}$$

(b) The specific nitrification rate at 15°C is

$$q_{N(15^\circ)} = q_{N(20^\circ)} 1.09^{15-20} = 0.84 \times 1.09^{-5} = 0.55 \text{ d}^{-1}$$

$$r_N = 0.55 \times 3000 \cdot 0.034 = 56 \text{ mg/(l} \cdot \text{d)}$$

$$t_N = \frac{28.4}{56} = 0.51 \text{ d}$$

The sludge production at 15°C is

$$\Delta X_{vb} = 124 - [0.082(1 - 0.034) + 0.041 \cdot 0.034] 0.56 \cdot 3000 \cdot 0.511$$

$$= 124 - 69 = 55 \text{ mg/l}$$

$$\theta_c = \frac{3000 \times 0.51}{55} = 28 \text{ d}$$

(c) Assume  $q_N$  will increase to  $q_{N(\max)}$ . Then

$$r_N = 1.3 \times 0.034 \times 3000 = 133 \text{ mg}/(1 \cdot \text{d})$$

$$N_{\text{ox}} = r_N t_N = 133 \times 0.33 = 44 \text{ mg/l}$$

$$(\text{NH}_3\text{-N})_c = 60 - 1 - 9.6 - 44 = 5.4 \text{ mg/l}$$

**EXAMPLE 6.14.** Using the results from Example 6.14 and a denitrification rate of  $0.1 \text{ mg NO}_3\text{-N}/(\text{mg VSS} \cdot \text{d})$ , design a system to achieve 75 percent overall denitrification ( $f = 0.75$ ), assuming complete denitrification in the anoxic zone.

**Solution.**

$$\frac{t_{\text{DN}}}{t_N} = \frac{q_N f_N f}{q_{\text{DN}}(1 - f_N)} = \frac{0.84 \times 0.034 \times 0.75}{0.1(1 - 0.034)} = 0.222$$

$$t_{\text{DN}} = 0.222 \times t_N = 0.33 \times 0.222 = 0.073 \text{ d}$$

The total detention time is

$$t = t_N + t_{\text{DN}} = 0.33 + 0.073 = 0.40 \text{ d}$$

The nitrogen to be denitrified is

$$N_{\text{DN}} = t_{\text{DN}} q_{\text{DN}} X_{vb}(1 - f_N) = 0.073 \times 0.1 \times 3000 = (1 - 0.034)1 = 21 \text{ mg/l}$$

The BOD removed during denitrification ( $S_{r,\text{DN}}$ ) assuming 3 mg BOD/mg N is

$$S_{r,\text{DN}} = 21 \times 3 = 63 \text{ mg/l}$$

The aerobic removal of BOD is

$$S_{r,\text{DN}} = 210 - 10 - 63 = 137 \text{ mg/l}$$

The sludge production becomes

$$\begin{aligned} \Delta X_{vb} = & a_D S_{r,\text{DN}} + a_H S_r + a_N N_{\text{ox}} - [b_H(1 - f_N)t_N \\ & + b_{H_0}(1 - f_N)t_{\text{DN}} + b_N f_N t_N] X_d X_{vb} \end{aligned}$$

Assuming  $a_D$  and  $b_D$  as 75 percent of  $a_H$  and  $b_H$ , respectively,

$$a_D = 0.75 \times 0.6 = 0.45$$

$$b_{H_0} = 0.75 \times 0.1 = 0.075 \text{ d}^{-1}$$

$$\begin{aligned} \Delta X_{vb} = & 0.45 \times 63 + 0.6 \times 137 + 0.15 \times 28.4 - [0.1(0.966)0.33 \\ & + 0.075(0.966)0.073 + 0.05(0.034)0.33]0.55 \times 3000 \\ = & 115 - [0.0377]3000 \times 0.55 = 115 - 113 \cdot 0.055 = 53 \text{ mg/l} \end{aligned}$$

$$\theta_c = \frac{3000 \times 0.4}{53} = 23 \text{ d}$$

The total required recycle is

$$R = \frac{1}{(1 - f)} - 1 = \frac{1}{(1 - 0.75)} - 1 = 3 \text{ or } 300\%$$

If  $Q_R = 50\%$ , then  $Q_{R,\text{in}} = 250\%$ .

## 6.9 LABORATORY AND PILOT PLANT PROCEDURES FOR DEVELOPMENT OF PROCESS DESIGN CRITERIA

### Wastewater Characterization

Wastewater characterization should be based on the equalized wastewater. Depending on the nature of the wastewater and the discharge permit requirements, the following parameters should be evaluated:

- BOD and/or COD or TOC
- Total and volatile suspended solids
- Oil and grease
- Volatile organics
- Priority pollutants
- Toxicity (bioassay)
- Nitrogen forms (TKN,  $\text{NH}_3$ ,  $\text{NO}_2^-$ ,  $\text{NO}_3^-$ )
- Phosphorus forms ( $o\text{-PO}_4$ , total P)

For wastewaters that do not contain aquatic toxicity, the following stepwise procedure is applicable to developing the necessary process design data:

1. Adjust the BOD:N:P ratio to 100:5:1, neglecting the wastewater organic nitrogen. Although organic nitrogen may be hydrolyzed to ammonia in the activated sludge process, it is initially neglected in order to ensure adequate nutrients in the experimental phase. The availability of the organic nitrogen will be reevaluated in the final process design.
2. Evaluate the wastewater's potential to promote filamentous bulking. In many cases, if the wastewater is readily degradable ( $K > 6 \text{ d}^{-1}$ ), filamentous bulking can be expected. If in doubt, evaluate this by operating a complete mix reactor at  $F/M \approx 0.4 \text{ d}^{-1}$  for 5 to 8 d to establish the proliferation of filaments.
3. Develop an acclimated mixed liquor. Determine the bioinhibition potential using the FBR procedure. If there is bioinhibition, adjust the initial feed rate of the wastewater to less than 50 percent of the inhibition threshold concentration. Operate the reactor at an  $F/M$  of  $0.3 \text{ d}^{-1}$ . As acclimation proceeds, gradually increase the feed rate until the full waste strength is being treated. For a wastewater with a low bulking potential, use a complete mix reactor. For a wastewater with a high bulking potential, acclimate the mixed liquor in a batch reactor, a sequencing batch reactor, or a biological selector.

Calculations for acclimation of a sludge using a batch fill-and-draw reactor are presented in Example 6.15.

**EXAMPLE 6.15.** Determine the operating conditions for a fill-and-draw acclimation procedure using a 20-l reactor volume and the following wastewater characteristics.

$$\text{BOD} = 2500 \text{ mg/l}$$

$$\text{TKN} = 12 \text{ mg/l}$$

$$\text{NH}_3\text{-N} = 2 \text{ mg/l}$$

$$o\text{-PO}_4\text{-P} = 3 \text{ mg/l}$$



Operate the reactor using an  $F/M = 0.3 \text{ d}^{-1}$ , with  $MLVSS = 3000 \text{ mg/l}$ .

**Solution.**

$$\begin{aligned} \text{NH}_3 \text{ required} &= [2500/(100/5)] - 2 \\ &= 123 \text{ mg N/l} \end{aligned}$$

$$\begin{aligned} o\text{-PO}_4\text{-P required} &= [2500/(100/1)] - 3 \\ &= 22 \text{ mg P/l} \end{aligned}$$

$$\begin{aligned} t &= \frac{S_o}{X_v(F/M)} = \frac{2500}{(3000 \cdot 0.3)} \\ &= 2.8 \text{ d} \end{aligned}$$

Assuming that the wastewater is not bioinhibitory (based on FBR test results), the volume added per feeding cycle is

$$V = \frac{20}{2.8} = 7.14 \text{ l/d}$$

If the FBR results indicate that the wastewater is inhibitory, then the feed should be diluted with a weak, but readily degradable, substrate to provide an  $S_o = 2500 \text{ mg/l}$ . The wastewater contribution to the blended feed volume should be gradually increased (about 10 percent per feed cycle) while maintaining  $S_o = 2500 \text{ mg/l}$ . The SOUR and SVI should be measured daily and the effluent SCOD concentration measured at the end of each feed cycle.

## Reactor Operation

At least three reactors should be operated in parallel over an SRT range of 3 to 12 d for a readily degradable wastewater and 10 to 40 d for a less degradable wastewater. Since floc size is related to power level, which in turn affects the reaction coefficient  $K$ , the power level in the pilot units should approximate field conditions. The SRT should be maintained by daily wasting of an appropriate mixed liquor volume (i.e., for a 10-d SRT, one-tenth of the reactor volume is wasted daily). The waste sludge mass is computed as the VSS in the wasted reactor volume, plus the VSS in the reactor effluent. The sampling and analytical schedule for the reactors is summarized in Table 6.23. If the wastewater is sorbable and readily degradable, a sequencing batch reactor (SBR) or a selector should be used to generate a nonfilamentous sludge (Fig. 6.69). For a more refractory wastewater, a complete mix reactor as shown in Fig. 6.70 should be used.

At the end of the treatability study, the degradable fraction  $X_d$  and the endogenous decay coefficient  $b$  are determined. Sludge from each reactor is washed and aerated, and the concentration of VSS is measured every 2 to 3 d until there is no further reduction in VSS. The degradable fraction and the endogenous decay coefficient can be calculated as shown in Fig. 6.71.

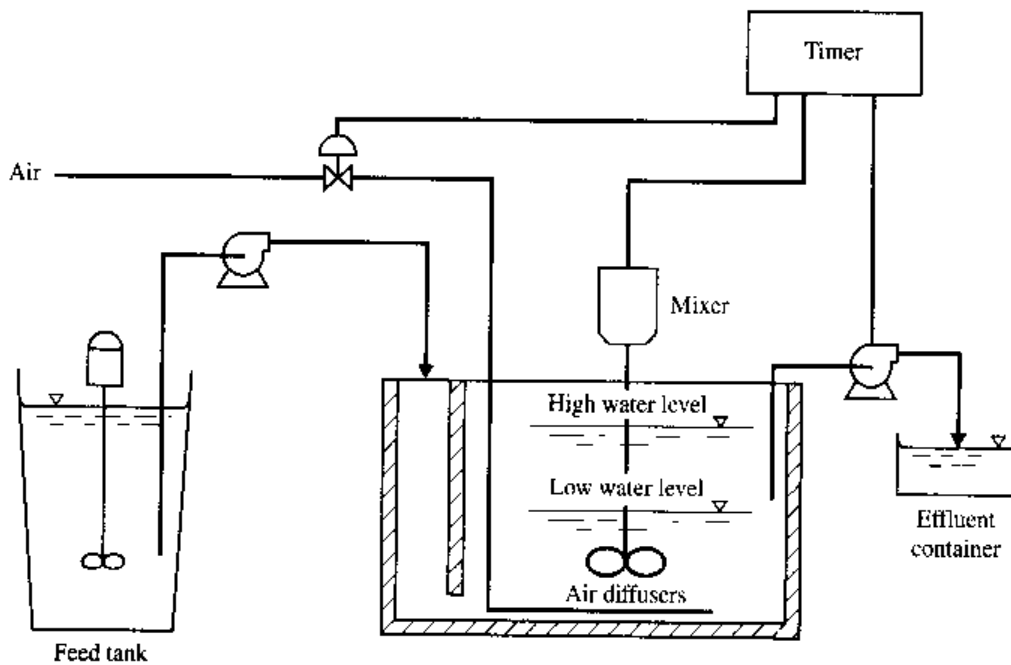
Figure 6.72 presents the methods for graphical analysis of the treatability reactor data. The rate coefficient  $K$  is determined by plotting  $S_o(S_o - S_e)/X_v t$  versus  $S_e$ . If the influent wastewater has a variable organic composition,  $K$  will not be con-

TABLE 6.23  
**Biological treatment process design study sampling and analysis schedule**

Analysis	Frequency
BOD	3/week
COD or TOC	Daily
O <sub>2</sub> uptake rate	Daily
MLVSS	Daily
Dissolved oxygen	Daily
pH	Daily
Temperature	Daily
Nitrogen <sup>†</sup>	2/week
Phosphorus	2/week
Bioassay <sup>‡</sup>	Weekly
Specific pollutants	Weekly

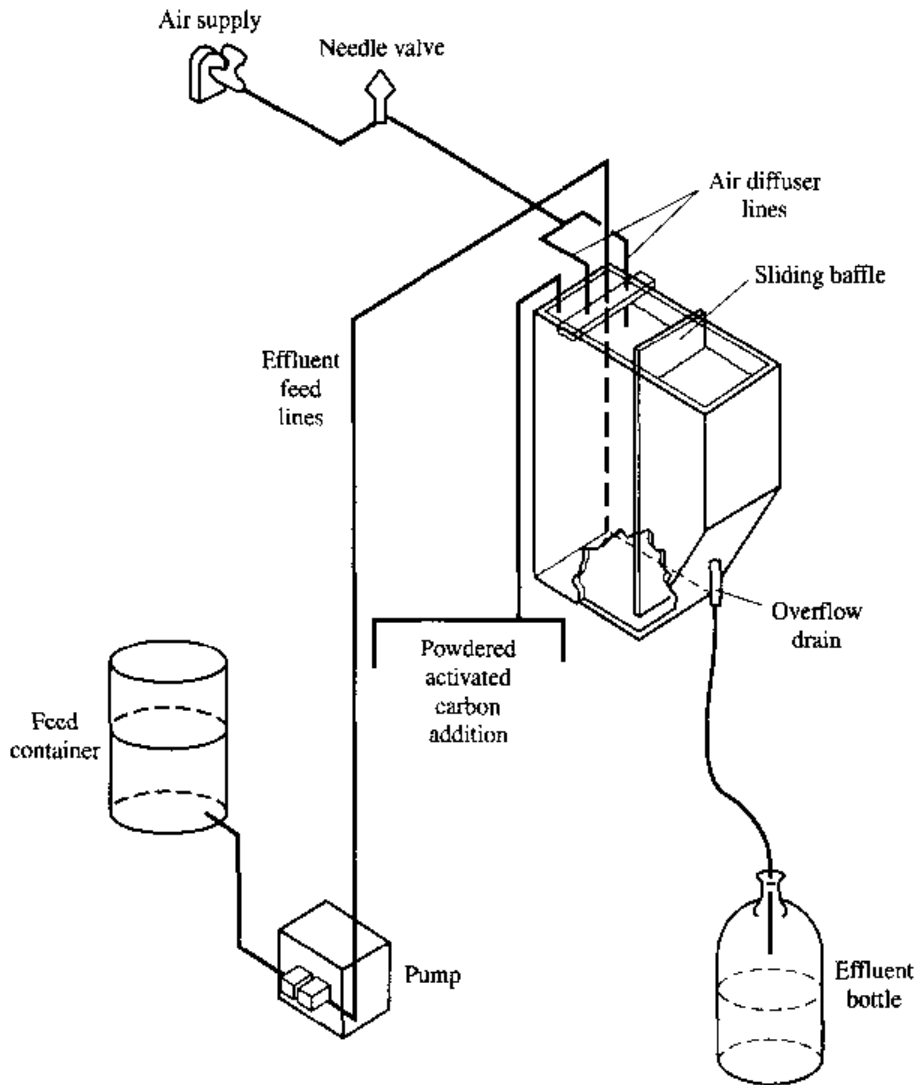
<sup>†</sup> The case of a nitrogen-deficient wastewater. If nitrification is desired, TKN, NH<sub>3</sub>-N, and NO<sub>3</sub><sup>-</sup>-N should be run 3 times per week.

<sup>‡</sup> The test species will depend on permit conditions.



**FIGURE 6.69**  
 Pilot plant activated sludge system (SBR modification).

stant. The oxygen coefficient  $a'$  is determined as the slope of the plot of  $O_2/X_d X_v t$  versus  $S_r/X_d X_v t$ , and the endogenous respiration coefficient  $b'$  is the intercept. The sludge yield coefficient  $a$  is determined from a plot of  $\Delta X_v/X_d X_v t$  versus  $S_r/X_d X_v t$ . It should be noted that  $\Delta X_v$  consists of the sludge wasted per day, plus that in the reactor effluent. The design criteria for the final clarifier are determined from zone settling velocity measurements and batch flux analysis of the sludge.

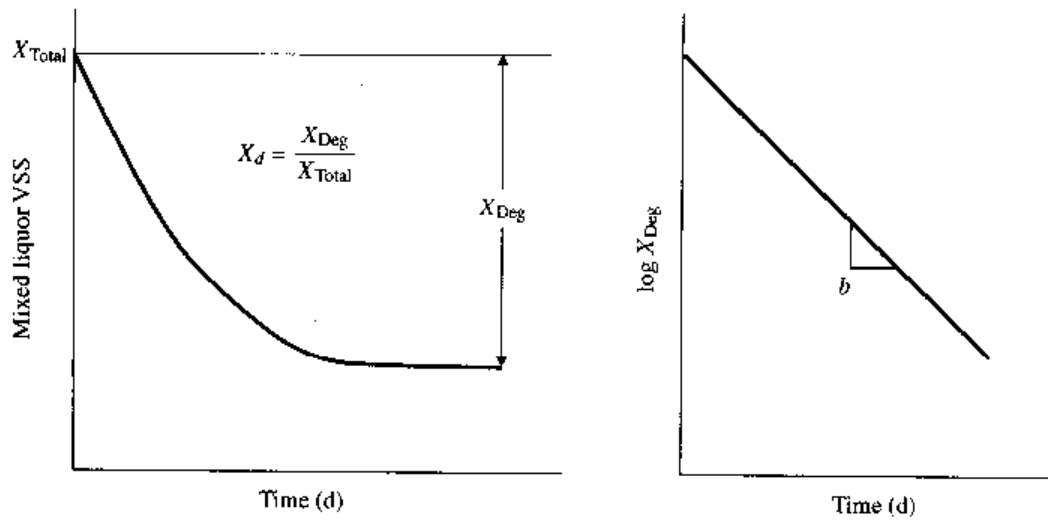


**FIGURE 6.70**  
Biological reactor with alternative PAC addition.

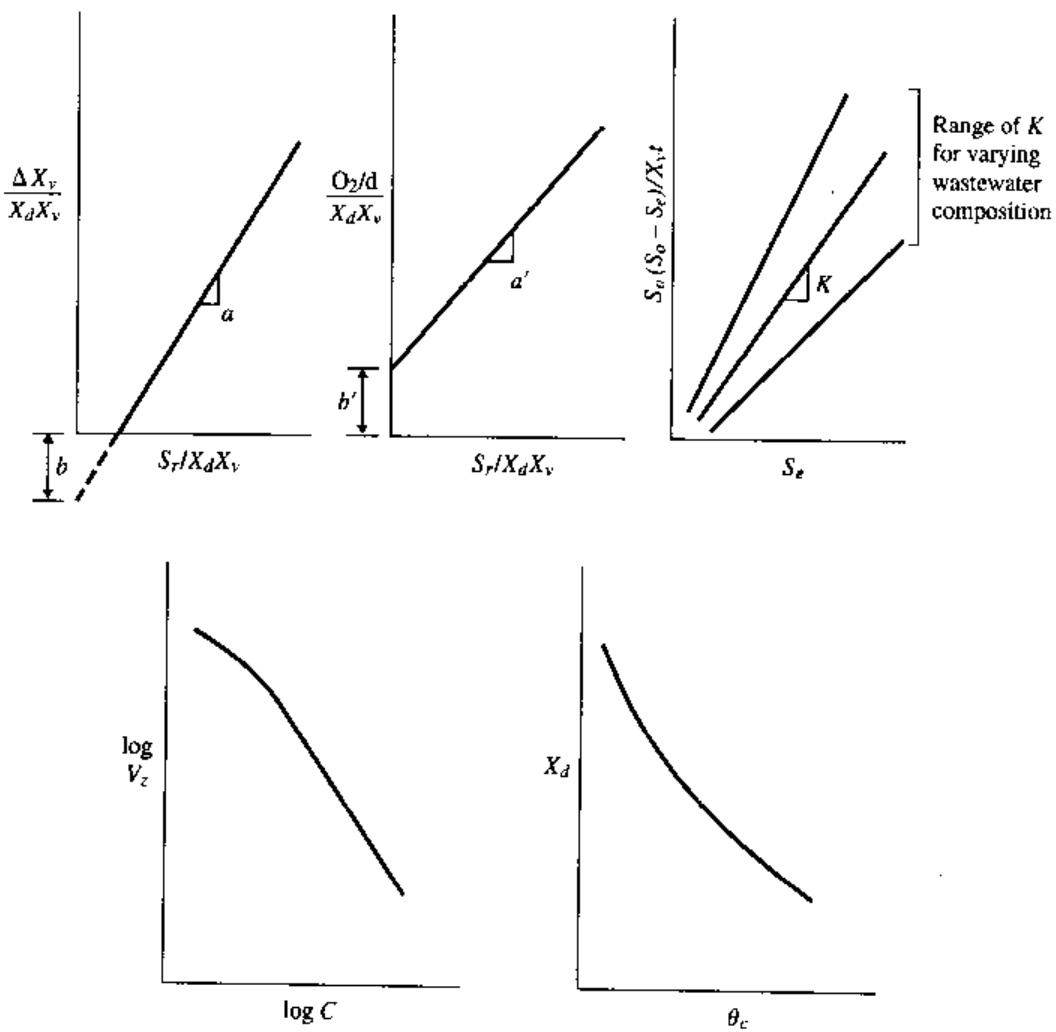
### Volatile Organic Carbon

The present emphasis on volatile emissions from wastewater treatment plants requires that stripping be considered in activated sludge process design where volatiles are present in the influent wastewater. There are several factors to be considered in the experimental design:

- Both the power level in the aeration basin and the type of aerator (i.e., diffused or mechanical) significantly influence stripping.
- The maximum expected concentration of each particular volatile should be employed. The degradation rate of specific volatiles will be related to both the composite wastewater composition and the process operating conditions, i.e., the SRT. Therefore, these variables must be fixed prior to volatile stripping and degradation studies.



**FIGURE 6.71**  
Determination of the degradable fraction and the endogenous coefficient.



**FIGURE 6.72**  
Parameter correlation plots.

- It has been shown that off-gas capture and recirculation will significantly enhance biodegradation of VOCs. Therefore, this process modification should be included in the pilot studies if VOC emission control is required for the plant.
- Covered aeration basins may result in a significant temperature rise due to the exothermic reaction with high-strength wastewaters. Basin temperatures in excess of approximately 38°C may result in floc dispersion. In these cases, it is necessary to monitor the reactor temperature and make appropriate temperature adjustments as required.

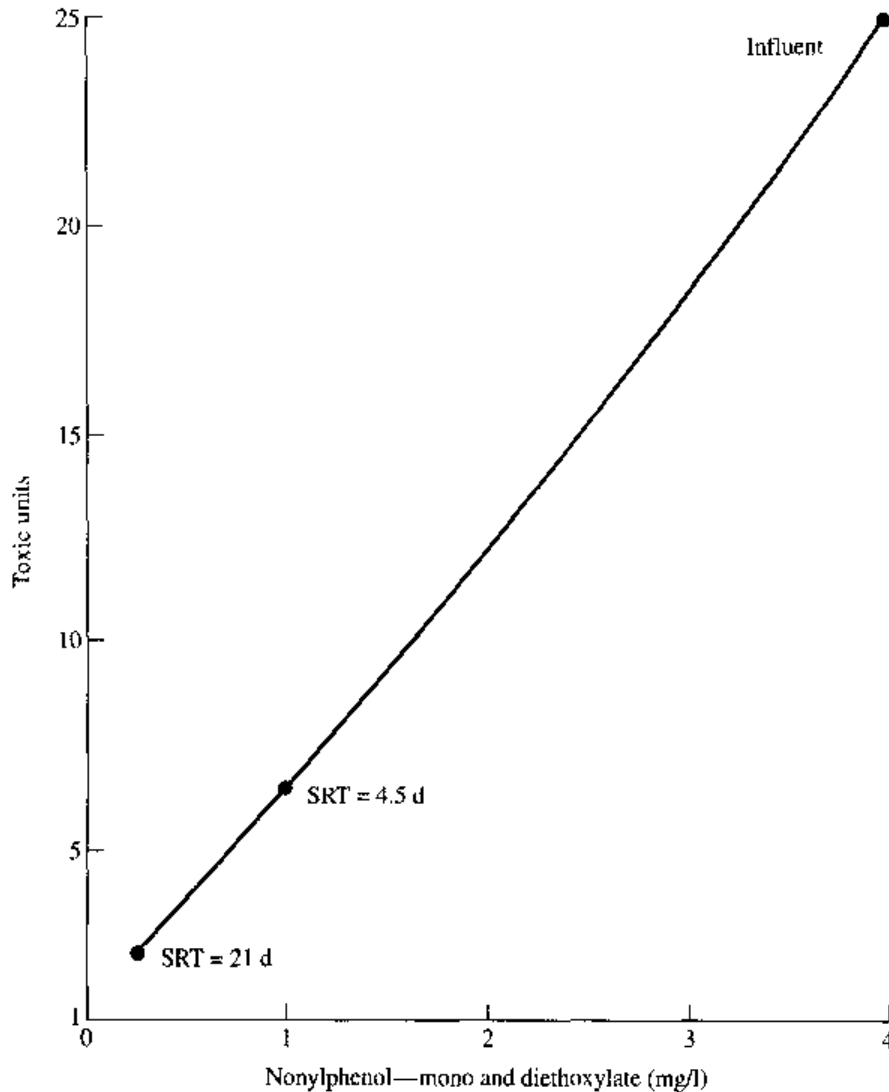
Once the degradation rate is defined, the calculations to determine the fraction of the volatile organics stripped can be made as described in on page 273.

### Reduction of Aquatic Toxicity

Aquatic toxicity is now regulated in virtually all industrial effluent discharge permits. Toxicity can be generated by inorganics and organics that are biodegradable, nonbiodegradable, or generated within the process (SMP). One of the first steps in a treatability study, therefore, is to determine the applicability of biological treatment to the wastewater.

Two cases will be considered. In the first, there is a known toxic compound that is biodegradable. A series of reactors at varying SRT are run in order to determine the required SRT to reduce the aquatic toxicity and meet permit requirements. An example of this using nonylphenol from a surfactant manufacturing wastewater is shown in Fig. 6.73. In the second, more common case, toxicity is caused by an unknown mixture of organics or is generated or enhanced by the production of SMP during biooxidation. In this case toxicity may be correlated to effluent COD as shown in Fig. 6.74 for a petroleum refinery wastewater. The testing protocol illustrated in Fig. 6.46 has been developed to define treatment options in this case. The biodegradability of the wastewater is determined by an FBR test. It is important that the biological sludge used in the test is fully acclimated to the wastewater. If the wastewater proves to be nondegradable and toxic, pretreatment must be considered. The primary objective of pretreatment would be detoxification and enhanced biodegradability. If the wastewater is degradable as defined by the FBR procedure, then a long-term oxidation test (e.g., 48 h aeration) is conducted to remove all degradable components. This effluent is then subjected to a bioassay. If this effluent is still toxic, then alternative pretreatment methods or tertiary treatment should be considered. Since it is not possible to distinguish between wastewater component toxicity and SMP toxicity, the wastewater should be pretreated for detoxification. A subsequent long-term oxidation test should then determine the source of the toxicity.

If the toxicity is caused by SMP, tertiary treatment with carbon should be evaluated. It is shown in Chap. 11 that, although laboratory adsorption isotherms will establish the applicability of carbon, they cannot be directly used for process design. A series of reactors should be run at various carbon dosages using the SRT required to remove degradable organics and/or priority pollutants. Each reactor

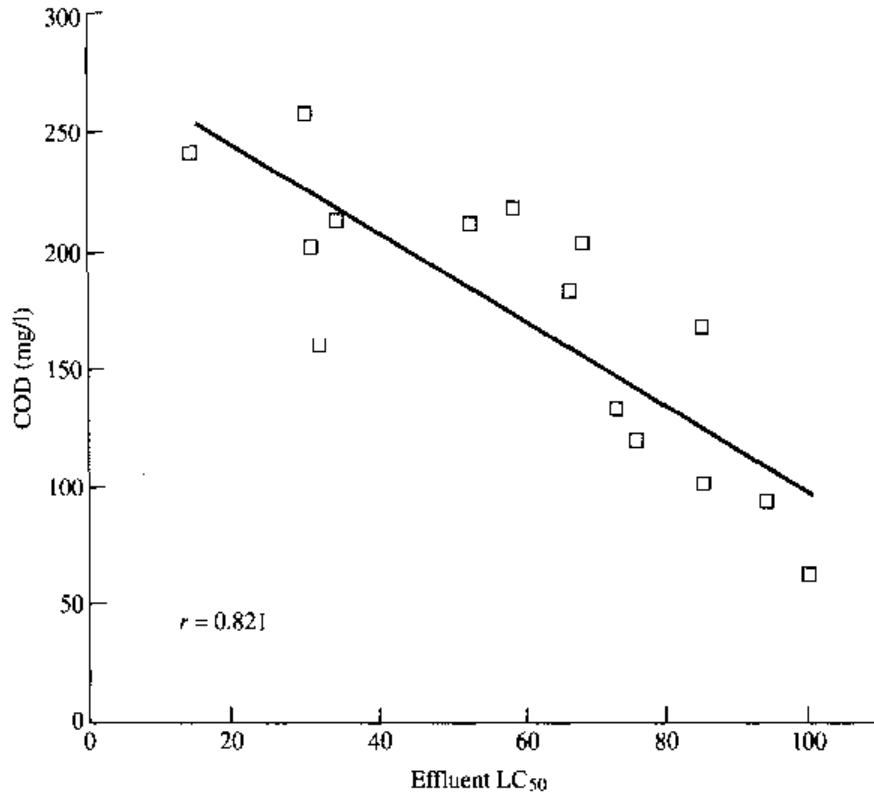


**FIGURE 6.73**  
Effects of SRT on toxicity reduction for nonylphenolics.

should be preloaded with carbon that has been brought into equilibrium with the reactor effluent. The equilibrium carbon concentration in the reactor mixed liquor is calculated from Eq. 8.12. If the PAC-treated wastewater still exhibits aquatic toxicity, then at-source treatment or elimination of the specific toxic wastewater streams should be considered.

## PROBLEMS

- 6.1.** The following data were developed from a pilot plant study at 20°C:
- Determine the  $K$  for this wastewater.
  - If  $\theta = 1.06$ , what is the  $K$  at 10°C?

**FIGURE 6.74**

Toxicity/COD correlation for wastewater treatment plant effluent.

$F/M, d^{-1}$	$X_v, mg/l$	$S_o, mg/l$	$S_e, mg/l$
0.3	2000	1640	26
0.48	1980	1640	44
0.72	2000	1640	70
0.96	2056	1640	100
1.18	2050	1640	167
2.68	2100	1640	333

6.2. A complete mix activated sludge plant treating an organic chemicals wastewater yielded the following performance data:

$$TOD_{\text{influent}} = 830 \text{ mg/l}$$

$$TOD_{\text{effluent}} = 50 \text{ mg/l}$$

$$\text{Oxygen uptake rate (OUR)} = 0.49 \text{ mg/(l} \cdot \text{min)}$$

$$MLVSS = 3200 \text{ mg/l}$$

$$Q = 3.2 \text{ million gal/d (12,100 m}^3\text{/d)}$$

$$t = 0.8 \text{ d}$$

A sample of mixed liquor was aerated in the laboratory to determine the endogenous oxygen uptake rate where

$$\text{OUR} = 0.3 \text{ mg/(l} \cdot \text{min)}$$

$$MLVSS = 4700 \text{ mg/l}$$

Calculate the endogenous coefficient  $b'$  and the coefficients  $a$  and  $a'$ .

- 6.3. Determine the operating  $F/M$ , MLVSS, and  $f_b$  for an activated sludge process under the following operating conditions:

$$\begin{aligned} a &= 0.45 \\ b &= 0.1 \text{ at } 20^\circ\text{C} \\ \theta_c &= 10 \text{ d} \\ X_i &= 200 \text{ mg/l} \\ f_x &= 0 \\ S_o &= 1000 \text{ mg/l} \\ S_e &= 20 \text{ mg/l} \\ t &= 0.9 \text{ d} \end{aligned}$$

- 6.4. Using the data from Example 6.6, compute the detention time required if the influent nondegradable VSS is 100 mg/l. If we wish to maintain the same detention time of 0.52 d, what must the MLVSS be increased to in order to maintain the same effluent quality?
- 6.5. The average operating and performance conditions for an activated sludge process are illustrated below.

*Influent*

$$\begin{aligned} \text{SCOD}_o &= 1018 \text{ mg/l} \\ X_i &= 51 \text{ mg/l} \\ f_x &= 0 \\ Q_o &= 5.19 \text{ million gal/d} \end{aligned}$$

*Effluent*

$$\begin{aligned} \text{SCOD}_e &= 248 \text{ mg/l} \\ \text{VSS}_e &= 34 \text{ mg/l} \end{aligned}$$

*Waste Sludge*

$$\begin{aligned} Q_w &= 0.08 \text{ million gal/d} \\ \text{VSS}_w &= 6080 \text{ mg/l} \end{aligned}$$

*Aeration Basin*

$$\begin{aligned} V &= 1 \text{ million gal/d} \\ \text{MLVSS} &= 2295 \text{ mg/l} \\ b &= 0.18 \text{ d}^{-1} \\ t &= 0.19 \text{ d} \\ \text{OUR} &= 146 \text{ mg/(l-h)} \end{aligned}$$

Develop a process material balance.

- 6.6. An untreated industrial wastewater has a BOD of 935 mg/l, negligible organic nitrogen,  $\text{NH}_3\text{-N}$  of 8 mg/l, and a flow rate of 1.5 million gal/d. The wastewater treatment plant operates at an SRT of 15 d with MLVSS of 3000 mg/l. The effluent soluble BOD is 15 mg/l. The sludge yield coefficient is 0.6,  $b$  is  $0.1 \text{ d}^{-1}$ , and the hydraulic retention time is 1.4 d. Compute the nitrogen that must be added.
- 6.7. A complete mix activated sludge plant is to be designed for the following conditions:
- $$\begin{aligned} Q &= 3.5 \text{ million gal/d } (1.32 \times 10^4 \text{ m}^3/\text{d}) \\ S_o &= 650 \text{ mg/l} \\ S \text{ (soluble)} &= 20 \text{ mg/l} \\ X_v &= 3000 \text{ mg/l} \end{aligned}$$



$$\begin{aligned}
 a &= 0.50 \\
 a' &= 0.52 \\
 b &= 0.1/\text{d at } 20^\circ\text{C} \\
 \theta &= 1.065 \\
 K &= 6.0/\text{d at } 20^\circ\text{C} \\
 b' &= 0.14/\text{d}
 \end{aligned}$$

Compute:

- (a) The aeration volume.
  - (b) The  $F/M$ .
  - (c) The sludge yield.
  - (d) The oxygen requirements.
  - (e) The nutrient requirements.
  - (f) The effluent quality at  $10^\circ\text{C}$ .
- 6.8.** Develop a relationship between the  $\text{NH}_3\text{-N/BOD}$  ratio and the aerobic volume percentage for a nitrification-denitrification channel. Consider a BOD of 200 mg/l and a range of  $\text{NH}_3\text{-N}$  of 10 to 70 mg/l. Compute the oxygen requirements for each case. Use the following parameters:

$$\begin{aligned}
 R_N &= \text{half the maximum rate} \\
 K_{\text{DN}} &= 0.06 \text{ mg NO}_3\text{-N}/(\text{mg VSS} \cdot \text{d}) \text{ at } 20^\circ\text{C} \\
 X_v &= 3000 \text{ mg/l} \\
 a' &= 0.55 \\
 K_{\text{BOD, aerobic}} &= 8.0/\text{day at } 20^\circ\text{C} \\
 \text{BOD/NO}_3\text{-N} &= 3.0 \\
 a &= 0.5 \\
 b &= 0.1 \text{ d}^{-1} \\
 X_d &= 0.45 \\
 S_e &= 10 \text{ mg/l}
 \end{aligned}$$

## REFERENCES

1. Weber, W. J., and B. E. Jones: EPA NTIS PB86-182425/AS, 1983.
2. Matter-Mutter et al.: *Prog. Water Tech.*, vol. 12, pp. 299-313, 1980.
3. Namkung, J., and Rittman: *J. WPCF*, vol. 59, no. 7, p. 670, 1987.
4. Branghman and Pariss: *Critical Review in Microbiology*, vol. 8, p. 205, 1981.
5. Dobbs, Wang, and Govind: *Environ. Sci. & Tech.*, vol. 23, no. 9, p. 1092, 1989.
6. Kincannon, D. F., and E. L. Stover: EPA Report CR-806843-01-02, 1982.
7. Grady C. P. L. et al.: *Water Research*, vol. 30, p. 742, 1996.
8. Tabak, H. H., and E. F. Barth: *J. WPCF*, vol. 50, p. 552, 1978.
9. Gaudy, A. F.: *J. WPCF*, vol. 34, pt. 2, p. 124, February 1962.
10. Englebrecht, R. S., and R. E. McKinney: *Sewage Ind. Wastes*, Vol. .29, pt. 12(1), p. 350, December 1957.
11. McWhorter, T. R., and H. Heukelekian: *Advances in Water Pollution Research*, vol. 2, Pergamon, New York, 1964.
12. Quirk, T., and W. W. Eckenfelder: *J. WPCF*, vol. 58, pt. 9, p. 932, 1986.
13. Sawyer, C. N.: *Biological Treatment of Sewage and Industrial Wastes*, vol. 1, Reinhold, New York, 1956.

14. Gellman, I., and H. Heukelekian: *Sewage Ind. Wastes*, vol. 25, pt. 10(1), p. 196, 1953.
15. Busch, A. W., and N. Myrick: *Proc. 15th Ind. Waste Conf.*, 1960, Purdue University.
16. Pipes, W.: *Proc. 18th Ind. Waste Conf.*, 1963, Purdue University.
17. Eckenfelder, W. W.: *Principles of Water Quality Management*, CBI, Boston, 1980.
18. Helmers, E. N., J. P. Frame, A. F. Greenbert, and C. N. Sawyer: *Sewage Ind. Wastes*, vol. 23, pt. 7, p. 834, 1951.
19. Wuhrmann, K.: *Biological Treatment of Sewage and Industrial Wastes*, vol. 1, Reinhold, New York, 1956.
20. Tischler, L. F., and W. W. Eckenfelder: *Advances in Water Pollution Research*, vol. 2, Pergamon, Oxford, England, 1969.
21. Gaudy, A. F., K. Komorrit, and M. N. Bhatla: *J. WPCF*, vol. 35, pt. 7, p. 903, July 1963.
22. Grau, P.: *Water Res.*, vol. 9, p. 637, 1975.
23. Adams, C. E., W. W. Eckenfelder, and J. Hovious: *Water Res.*, vol. 9, p. 37, 1975.
24. Van Niekerk et al.: *Wat. Sci. Tech.*, vol. 19, p. 505, 1987.
25. Argaman, Y.: *Water Research*, vol. 25, p. 1583, 1991.
26. Rickard, M. D., and Gaudy, A. F.: *J. WPCF*, vol. 49, R129, 1968.
27. Zahradka, V., *Advances in Water Pollution Research*, vol. 2, Water Pollution Control Federation, Washington, D.C., 1967.
28. Philbrook, D. M., and Grady, P. L.: *Proc. 40th Industrial Waste Conf.*, Purdue University, 1985.
29. Hoover, P.: M. S. Dissertation, Vanderbilt University, 1989.
30. Nevalainen, J. et al.: *Wat. Sci. Tech.*, vol. 24, no. 3-4, 1991.
31. Hall, E. R., and Randall, W. G.: *Wat. Sci. Tech.*, vol. 26, no. 1-12, 1992.
32. Higgins, M. J., and J. T. Novak: *Wat. Env. Res.*, vol. 69, no. 2, 1997.
33. Palm, J. C., D. Jenkins, and P. S. Parker: *J. WPCF*, vol. 52, pt. 2, p. 484, 1980.
34. Richard, M. G.: *WEF Ind. Waste Tech. Conf.*, New Orleans, 1997.
35. Eckenfelder, W. W., and J. Musterman: *Activated Sludge Treatment of Industrial Wastewaters*, Technomic Publishing, 1995.
36. Marten, W., and G. Daigger: *Water Env. Research*, vol. 69, no. 7, p. 1272, 1997.
37. Wanner, J.: *Activated Sludge Bulking and Foaming Control*, Technomic Publishing, 1994.
38. Jenkins, D., M. Richard, and G. Daigger: *Manual on the Causes and Control of Activated Sludge Bulking and Foaming Water*, Research Committee, Pretoria, S.A., 1984.
39. Pitter, J., and J. Chudoba: *Biodegradability of Organic Substances in the Aquatic Environment*, CRC Press, Boca Raton, Fla., 1990.
40. Chudoba, J.: *Water Res.*, vol. 19, no. 2, p. 197, 1985.
41. Volskay, V. T., and P. L. Grady: *J. WPCF*, vol. 60, no. 10, p. 1850, 1988.
42. Watkin, A.: Ph.D. dissertation, Vanderbilt University, 1986.
43. Watkin, A., and W. W. Eckenfelder: *Water Sci. Tech.*, vol. 21, p. 593, 1988.
44. Larson, R. J., and S. L. Schaeffer: *Water Res.*, vol. 16, p. 675, 1982.
45. Roberts, P. V. et al.: *J. WPCF*, vol. 56, no. 2, p. 157, 1984.
46. Poduska, R. A.: Ph.D. thesis, Clemson University, 1973.
47. Wong Chong, G. M., and R. C. Loehr: *Water Res.*, vol. 9, p. 1099, 1975.
48. Blum, J. W., and R.A. Speece: *Database of Chemical Toxicity to Bacteria and Its Use in Interspecies Comparisons and Correlations*, Vanderbilt University, 1990.
49. Henning, A., and R. Kayser, *42nd Purdue Ind. Waste Conf.*, p. 893, 1986.
50. Skinner, F. A., and N. Walker: *Arch. Mikrobiol.* pp. 38-339, 1961.
51. Sadick, T. E. et al.: *Proc. WEF*, vol. 1, Dallas, 1996.
52. Zacharias, B., and R. Kayser: *50th Purdue Ind. Waste Conf. Proc.*, Ann Arbor Press, 1995.

53. Anthoisen, A. C.: *J. WPCF*, vol. 48, p. 835, 1976.
54. Sutton et al.: First Workshop, Canadian-German Cooperation, Wastewater Technology Center, Burlington, Ontario, Canada, 1979.
55. Orhon, S. et al.: *Water Sci. Tech.*, vol. 34, no. 5, p. 67, 1996.
56. McClintock, S. A. et al.: *J. WPCF*, vol. 60, no. 3, 1988.
57. OH, J., and J. Silverstein: *Water Res.*, vol. 33, no. 8, p. 1925, 1999.
58. Lie, J., and R. Welander: *Water Sci. Tech.*, vol. 30, no. 6, p. 91, 1994.
59. Baumann, P., and Kh. Krauth: *Proc 2nd Specialized Conference on Pretreatment of Industrial Wastewaters*, Athens, Greece, 1996.
60. Henze H. et al.: *Water Res.*, vol. 27, no. 2, p. 231, 1993.
61. "Secondary Settling Tanks," scientific and technical report no. 6, IAWQ, 1998.

---

## BIOLOGICAL WASTEWATER TREATMENT PROCESSES

---

### 7.1 LAGOONS AND STABILIZATION BASINS

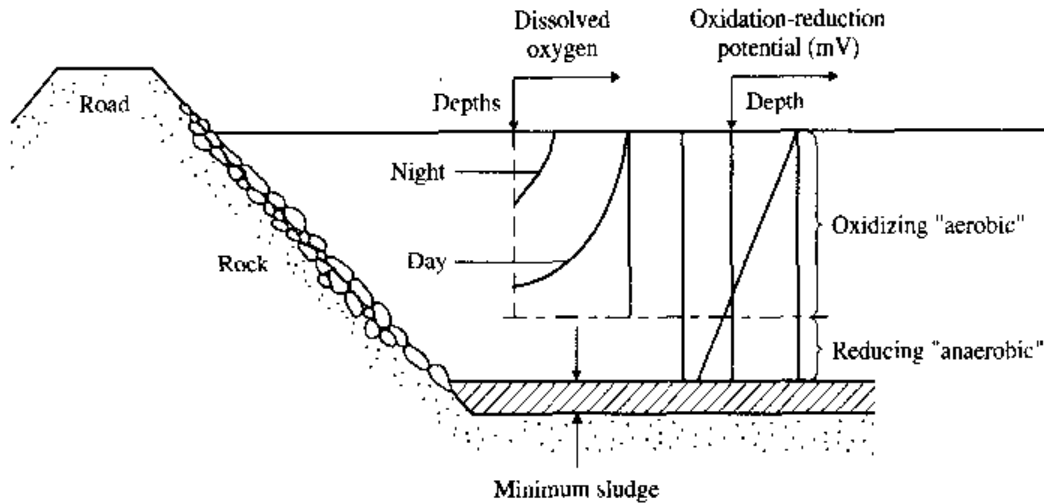
Stabilization basins are a common method of organic wastewater treatment where sufficient land area is available and where groundwater pollution from toxic organics or heavy metals is not a problem.

Stabilization basins can be divided into two classifications: the impounding and adsorption lagoon and the flow-through lagoon. In the impounding-adsorption lagoon, either there is no overflow or there is intermittent discharge during periods of high stream flow. The volumetric capacity of the basin is equal to the total waste flow less losses by evaporation and percolation. If there is intermittent discharge, the required capacity is related to the stream flow characteristics. In view of the large area requirements, impounding lagoons are usually limited to industries discharging low daily volumes of waste or to seasonal operations such as the canning industry.

The flow-through lagoon can be classified into three categories based on the dominant types of biological activity.

#### **Type I. Facultative Ponds**

Facultative ponds are divided by loading and thermal stratification into an aerobic surface and an anaerobic bottom. The aerobic surface layer will have a diurnal variation, increasing in oxygen content during the daylight hours due to algal photosynthesis and decreasing during the night, as shown in Fig. 7.1. Sludge deposited on the bottom will undergo anaerobic decomposition, producing methane and other gases. Odors will be produced if an aerobic layer is not maintained. Depths will vary from 3 to 6 ft (0.9 to 1.8 m).



**FIGURE 7.1**  
Waste stabilization pond—facultative type.<sup>1</sup>

Because oxygen generation by photosynthesis depends on light penetration, highly colored wastewaters such as textile and pulp and paper cannot be treated by this technology.

### Type II. Anaerobic Ponds

Anaerobic ponds are loaded to such an extent that anaerobic conditions exist throughout the liquid volume. The biological process is the same as that occurring in anaerobic digestion tanks, i.e., primarily organic acid formation followed by methane fermentation. The depth of an anaerobic pond is selected to give a minimum surface area/volume ratio and thereby provide maximum heat retention during cold weather.

### Type III. Aerated Lagoons

These range from a few days' to 2 weeks' detention, depending on the BOD removal efficiency desired. Oxygen is supplied by diffused or mechanical aeration systems, which also cause sufficient mixing to induce a significant amount of surface aeration. Depths from 6 to 15 ft (1.8 to 4.6 m) are common.

### Lagoon Applications

For some industrial waste applications, aerobic ponds have been used after anaerobic ponds to provide high-degree treatment. Stabilization basins are also used to polish effluents from biological-treatment systems such as trickling filters and activated sludge.

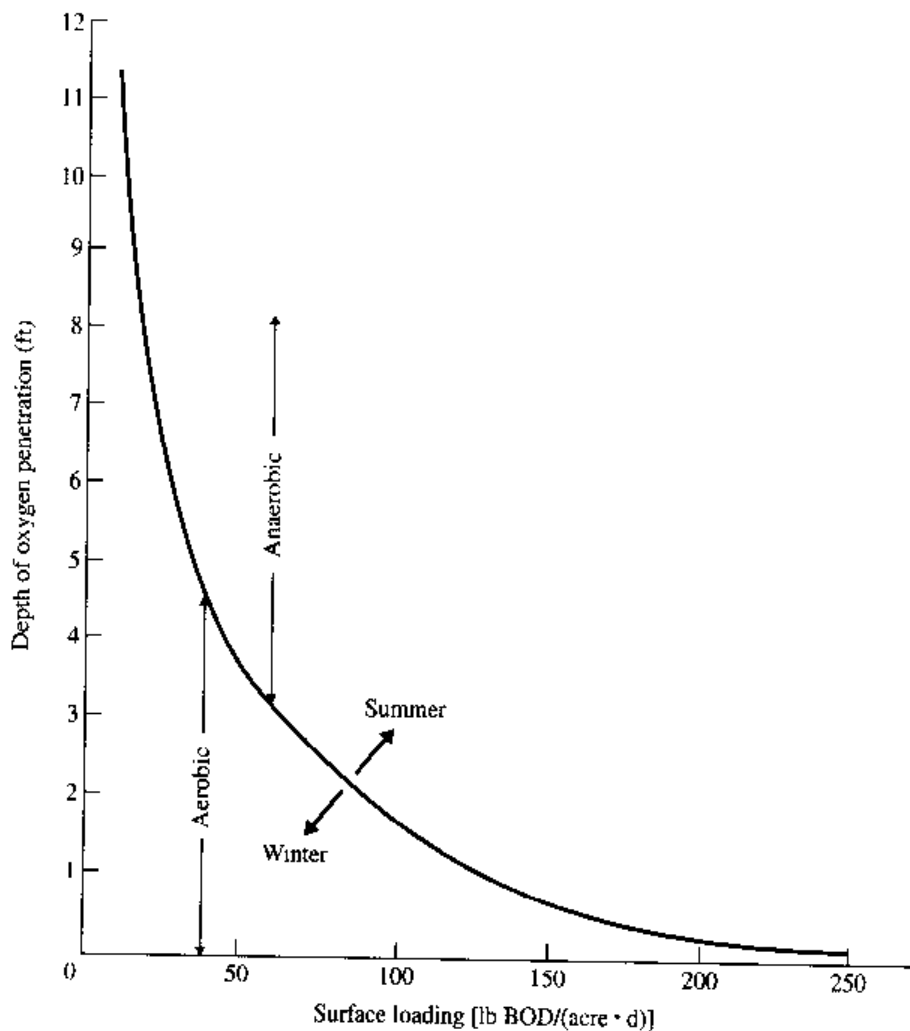
In aerobic ponds, the amount of oxygen produced by photosynthesis can be estimated from

$$O_2 = Cfs \quad (7.1)$$

where  $O_2$  = oxygen production, lb/(acre · d) or kg/(m<sup>2</sup> · d)  
 $C$  = 0.25 if  $O_2$  is in lb/(acre · d) or  $2.8 \times 10^{-5}$  if  $O_2$  is in kg/(m<sup>2</sup> · d)  
 $f$  = light conversion efficiency, %  
 $S$  = light intensity, cal/(cm<sup>2</sup> · d)

If the light conversion efficiency is estimated as 4 percent, then  $O_2 = S$ .  $S$  is a function of latitude and the month of the year and may be expected to vary from 100 to 300 calories/(cm<sup>2</sup> · d) during winter and summer for a latitude 30°. This, in turn, would imply maximum loadings of 100 to 300 lb BOD<sub>u</sub>/(acre · d) [0.011 to 0.034 kg/(m<sup>2</sup> · d)] in order to maintain any aerobic activity in the pond.

The depth of oxygen penetration in a facultative pond has been estimated as a function of surface loadings, as shown in Fig. 7.2. It should be noted that the data for Fig. 7.2 was developed from oxidation ponds treating domestic wastewater in



Note:  
 lb/(acre · d) =  $1.121 \times 10^{-4}$  kg/(m<sup>2</sup> · d)  
 ft = 0.3048 m

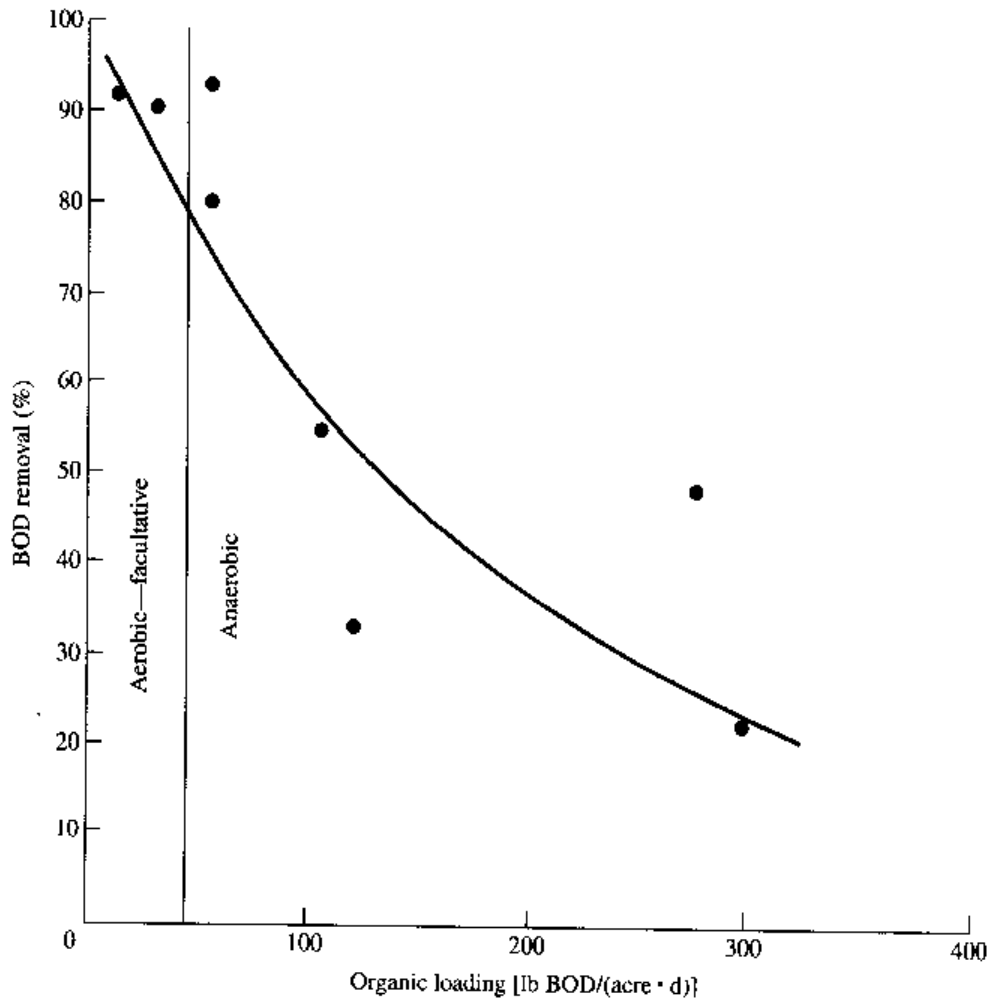
**FIGURE 7.2**  
 Depth of oxygen penetration in facultative ponds.<sup>2</sup>

California. Appropriate adjustments to this curve would have to be made for other types of wastewater being treated in other climatic conditions.

The typical green algae in waste stabilization basins are *Chlamydomonas*, *Chlorella*, and *Euglena*. Common blue-green algae are *Oscillatoria*, *Phormidium*, *Anacystis*, and *Anabaena*. Algae types in a pond will vary seasonally.

In the treatment of highly colored or turbid wastewaters such as from kraft pulp and paper mills, light penetration will be minimal and oxygen input will generate primarily from surface reaeration. Gellman and Berger<sup>3</sup> estimated oxygen input from reaeration at 45 lb O<sub>2</sub>/(acre · d) [0.005 kg/(m<sup>2</sup> · d)]. The performance of stabilization basins in the pulp and paper industry from their data is shown in Fig. 7.3.

Several concepts have been employed for the design of facultative and anaerobic ponds. Functional equations for anaerobic and facultative ponds have been developed as follows:



Note:  
 lb/(acre · d) =  $1.121 \times 10^{-4}$  kg/(m<sup>2</sup> · d)

**FIGURE 7.3**

Waste stabilization pond performance in the pulp and paper industry.

For a single well-mixed pond:

$$\frac{S}{S_o} = \frac{1}{1 + kt} \quad (7.2)$$

For multiple ponds:

$$\frac{S}{S_o} = \frac{1}{(1 + k_1 t_1)(1 + k_2 t_2) \cdots (1 + k_n t_n)} \quad (7.2a)$$

For an infinite number of ponds or for a plug flow pond:

$$\frac{S}{S_o} = e^{-kt} \quad (7.3)$$

When variable influent concentrations are considered, Eq. (7.2) can be modified to

$$\frac{S}{S_o} = \frac{1}{1 + kt/S_o} \quad (7.4)$$

The equation is functionally the same as that employed for aerated lagoons and activated sludge, except that the rate coefficient  $k$  includes the effect of biomass concentration. This is because it is generally impractical or impossible to effectively measure the biomass concentration (VSS) in waste stabilization basins.

When multiple ponds are to be considered [Eq. (7.3)],  $k$  is assumed to be the same for all ponds. For complex wastewaters, this is probably not true, since the more readily degradable compounds will be removed in the initial ponds. For these cases, an experimental study would need to be conducted for the wastewater in question to define the change in  $k$ .

Data from an organic chemicals plant showed  $k$  to be  $0.05 \text{ d}^{-1}$  under anaerobic conditions at  $20^\circ\text{C}$  and  $0.5 \text{ d}^{-1}$  under aerobic conditions.

In a stabilization basin, the average  $k_m$  can be computed:

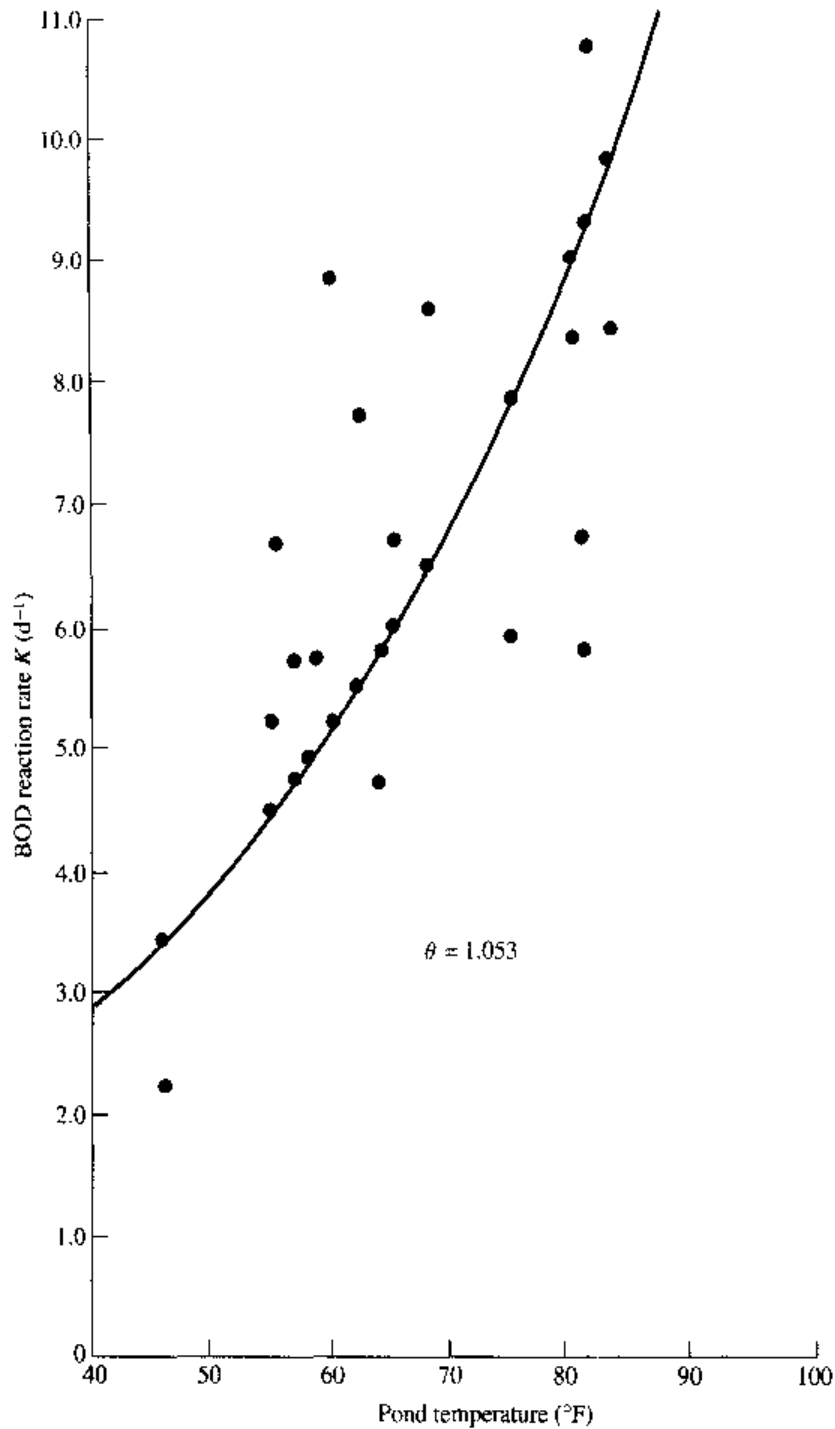
$$k_m = \frac{k_{\text{aerobic}} \times D_{\text{aerobic}} + k_{\text{anaerobic}} \times D_{\text{anaerobic}}}{D_{\text{total}}} \quad (7.5)$$

As in all biological processes, the biological activity in the pond will be a function of temperature, and the rate coefficient  $k$  can be corrected through the application of Eq. (6.37). Evaluation of the 30-d average performance for a kraft pulp and paper mill showed a  $\theta$  value of 1.053, as shown in Fig. 7.4. During winter operation in colder climates, the pond will ice over, resulting in anaerobic conditions and reduced performance. (Note that an ice cover will act as an insulator, maintaining higher temperature in the liquid.)

Certain design considerations are important to the successful operation of stabilization basins. These have been discussed by Hermann and Gloyna<sup>4</sup> and Marais.<sup>5</sup> Embankments should be constructed of impervious material with maximum slope between 3:1 and 4:1 and minimum slope of 6:1. A minimum freeboard of 3 ft (0.91 m) should be maintained in the basin. Provision should be made for protecting the bank from erosion. Wind action is important for pond mixing and is effective with a fetch of 650 ft (198 m) in a pond with a depth of 3 ft (0.91 m).

Meat waste has been treated in shallow aerobic ponds only 18 in (0.66 m) deep at loadings of 214 lb BOD/(acre · d) [0.024 kg/(m<sup>2</sup> · d)]. The waste was presettled





**FIGURE 7.4**

Temperature effect on 30-d average performance of a pond treating a pulp and paper mill effluent.

and had a concentration of 175 mg/l BOD. BOD reductions of 96 percent in the summer and 70 percent in the winter were obtained.

Use of an aerobic pond treating meat-packing waste after the anaerobic contact process yielded 80 percent BOD removal at a loading of 410 lb BOD/(acre · d)

[0.046 kg/(m<sup>2</sup> · d)]. The concentration of BOD entering the pond was 129 mg/l. Removals at various loadings have been summarized by Steffen.<sup>6</sup>

Packing-house waste loadings to anaerobic ponds 8 to 17 ft (2.4 to 5.2 m) deep have been reported to vary from 0.011 to 0.015 lb BOD/(ft<sup>3</sup> · d) [0.176 to 0.240 kg/(m<sup>3</sup> · d)], with high BOD removals. Treatment of corn waste with an initial BOD of 2936 mg/l in a lagoon with a 9.6-d detention yielded 59 percent BOD reduction. The organic loading was 0.184 lb BOD/(ft<sup>3</sup> · d) [2.95 kg/(m<sup>3</sup> · d)].

In order to improve the efficiency of lagoon operation, nitrogen and phosphorus must be added to nutrient-deficient wastes. The requirements for aerobic and anaerobic processes are discussed on pages 215 and 402, respectively.

Lagoons treating wastes in which aerobic conditions are not maintained frequently emit odors and provide a breeding ground for insects. The odor problems can frequently be eliminated by the addition of sodium nitrate at a dosage equal to 20 percent of the applied oxygen demand, as shown in Fig. 7.5. Surface sprays can be used to reduce the fly and insect nuisance and in some cases the odor.

High efficiencies can frequently be attained by the use of anaerobic ponds followed by aerobic ponds. An anaerobic pond with a 6-d detention and 14-ft (4.3 m) depth loaded at 0.014 lb BOD/(ft<sup>3</sup> · d) [0.224 kg/(m<sup>3</sup> · d)], followed by a 3-ft (0.9-m-) deep aerobic pond with a 19-d detention loaded at 50 lb BOD/(acre · d) [0.0056 kg/(m<sup>2</sup> · d)], yielded an overall reduction in BOD from 1100 to 67 mg/l.<sup>7</sup> Performance data for aerobic facultative and anaerobic ponds are summarized for various industrial wastewaters in Table 7.1. The design of facultative ponds is illustrated by Example 7.1.

**EXAMPLE 7.1.** An industrial wastewater with a BOD of 500 mg/l is to be treated in a pond or series of ponds with a total retention time of 50 d with a depth of 6 ft. The anaerobic  $k$  at 20°C is 0.05 d<sup>-1</sup> and the aerobic  $k$  is 0.51 d<sup>-1</sup>. Assume the oxygen relationships as shown in Fig. 7.2 apply and the pond temperature is 20°C.

**Solution.**

1. For one pond the applied loading is:

$$\begin{aligned} \text{Loading} &= \frac{2.7DS_o}{t} \\ &= \frac{2.7(6)(500)}{50} \\ &= 162 \text{ lb BOD}/(\text{acre} \cdot \text{d}) \end{aligned}$$

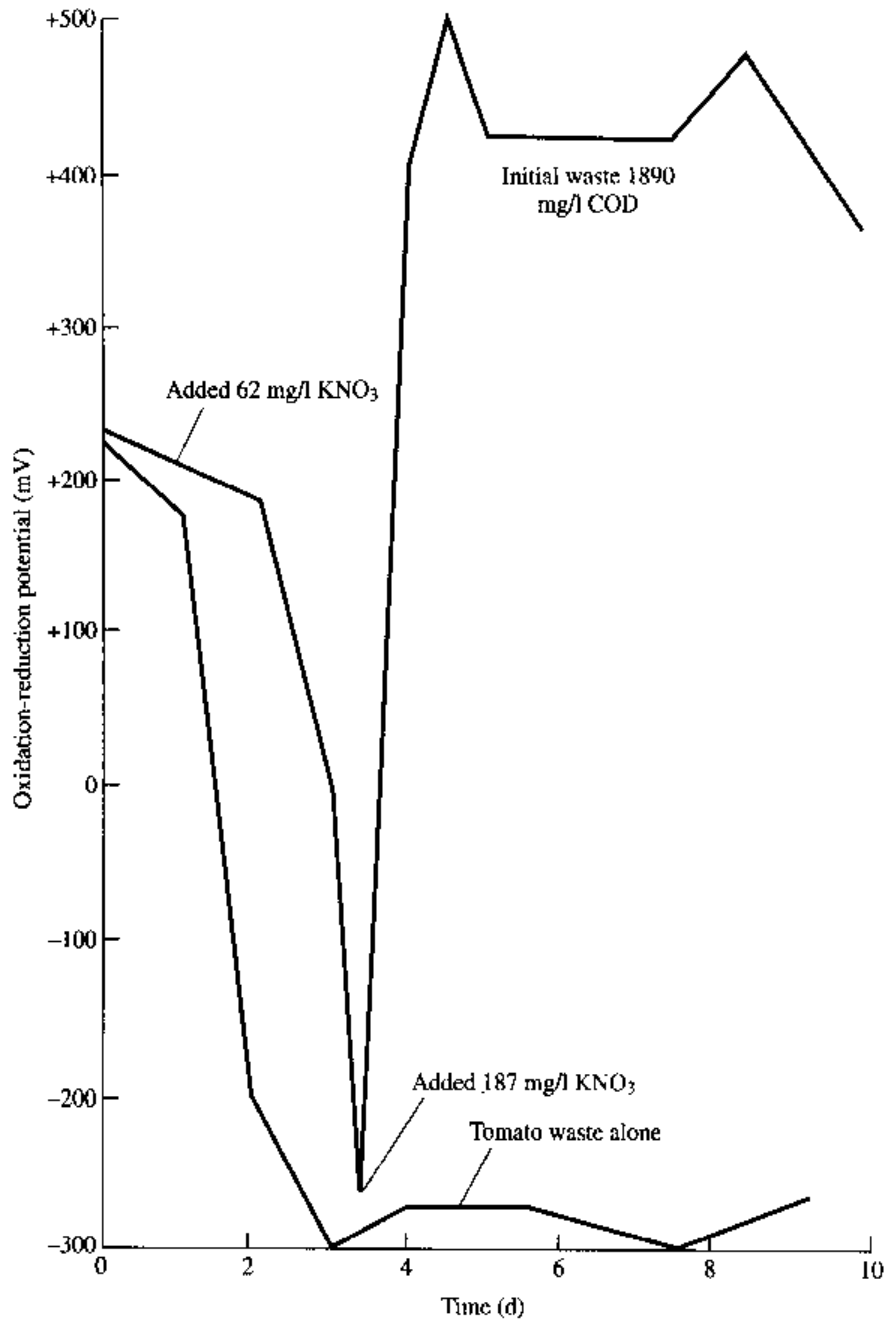
Dissolved oxygen will exist to a depth of 0.8 ft.

The mean  $k$  can be computed:

$$k = \frac{(0.8)(0.5) + 5.2(0.05)}{6} = 0.11 \text{ d}^{-1}$$

The effluent BOD is:

$$\begin{aligned} S_e &= \frac{S_o}{1 + kt} \\ &= \frac{500}{1 + 0.11(50)} \\ &= 77 \text{ mg/l} \end{aligned}$$



**FIGURE 7.5**  
ORP control of nitrate addition to pond treatment of tomato wastewaters.

2. For four ponds in series, the retention time in each pond will be 12.5 d.

The loading to the first pond is:

$$\frac{2.7(6)(500)}{12.5} = 648 \text{ lb BOD}/(\text{acre} \cdot \text{d})$$

and is anaerobic.

The effluent from the first pond is:

$$S_e = \frac{500}{1 + 0.05(12.5)} = 308 \text{ mg/l}$$

**TABLE 7.1**  
**Performance of lagoon systems**

<b>Summary of average data from aerobic and facultative ponds</b>					
<b>Industry</b>	<b>Area, acres</b>	<b>Depth, ft</b>	<b>Detention, d</b>	<b>Loading, lb/(acre · d)</b>	<b>BOD removal, %</b>
Meat and poultry	1.3	3.0	7.0	72	80
Canning	6.9	5.8	37.5	139	98
Chemical	31	5.0	10	157	87
Paper	84	5.0	30	105	80
Petroleum	15.5	5.0	25	28	76
Wine	7	1.5	24	221	
Dairy	7.5	5.0	98	22	95
Textile	3.1	4.0	14	165	45
Sugar	20	1.5	2	86	67
Rendering	2.2	4.2	4.8	36	76
Hog feeding	0.6	3.0	8	356	
Laundry	0.2	3.0	94	52	
Miscellaneous	15	4.0	88	56	95
Potato	25.3	5.0	105	111	
<b>Summary of average data from anaerobic ponds</b>					
<b>Industry</b>	<b>Area, acres</b>	<b>Depth, ft</b>	<b>Detention, d</b>	<b>Loading, lb/(acre · d)</b>	<b>BOD removal, %</b>
Canning	2.5	6.0	15	392	51
Meat and poultry	1.0	7.3	16	1260	80
Chemical	0.14	3.5	65	54	89
Paper	71	6.0	18.4	347	50
Textile	2.2	5.8	3.5	1433	44
Sugar	35	7.0	50	240	61
Wine	3.7	4.0	8.8		
Rendering	1.0	6.0	245	160	37
Leather	2.6	4.2	6.2	3000	68
Potato	10	4.0	3.9		
<b>Summary of average data from combined aerobic-anaerobic ponds</b>					
<b>Industry</b>	<b>Area, acres</b>	<b>Depth, ft</b>	<b>Detention, d</b>	<b>Loading, lb/(acre · d)</b>	<b>BOD removal, %</b>
Canning	5.5	5.0	22	617	91
Meat and poultry	0.8	4.0	43	267	94
Paper	2520	5.5	136	28	94
Leather	4.6	4.0	152	50	92
Miscellaneous industrial wastes	140	4.1	66	128	

*Note:*

ft = 0.3048 m

lb/(acre · d) =  $1.121 \times 10^{-4}$  kg/(m<sup>2</sup> · d)

acre =  $4.0469 \times 10^3$  m<sup>2</sup>

The loading to the second pond is:

$$\frac{2.7(6)(308)}{12.5} = 399 \text{ lb BOD}/(\text{acre} \cdot \text{d})$$

$$S_e = \frac{308}{1 + (0.05)(12.5)} = 190 \text{ mg/l}$$

The loading to the third pond is 246 lb BOD/(acre · d) and the effluent is 117 mg/l. The loading to the fourth pond is 152 lb BOD/(acre · d) and the aerobic depth is 1 ft.

The adjusted  $k$  is:

$$\frac{0.5(1) + 0.05(5)}{6} = 0.125 \text{ d}^{-1}$$

The effluent is:

$$S_e = \frac{117}{1 + (0.125)(12.5)} = 45.7 \text{ mg/l}$$

Four ponds in series with the same total retention time will produce a superior effluent. This assumes the reaction rate  $k$  does not change through the series of basins. This is probably not true in many cases and would have to be determined experimentally.

## 7.2 AERATED LAGOONS

An aerated lagoon is a basin of significant depth, e.g., 8 to 16 ft (2.4 to 4.9 m) deep, in which oxygenation is accomplished by mechanical or diffused aeration units and through induced surface aeration.

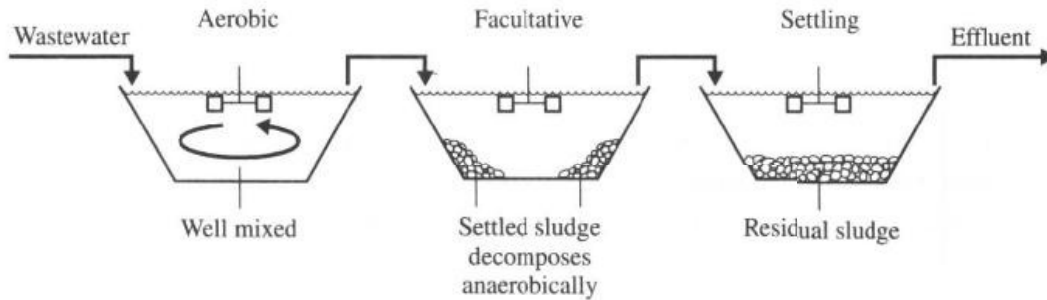
There are two types of aerated lagoons:

1. The aerobic lagoon in which dissolved oxygen and suspended solids are maintained uniformly throughout the basin.
2. The aerobic-anaerobic or facultative lagoon, in which oxygen is maintained in the upper liquid layers of the basin, but only a portion of the suspended solids is maintained in suspension. These basin types are shown in Fig. 7.6. A photo of a typical aerated lagoon is shown in Fig. 7.7.

In the aerobic lagoon, all solids are maintained in suspension, and this system may be thought of as a "flow-through" activated sludge system, i.e., without solids recycle. Thus, the effluent suspended solids concentration will be equal to the aeration basin solids concentration.

In the facultative lagoon, a portion of the suspended solids settle to the bottom of the basin, where they undergo anaerobic decomposition. The anaerobic by-products are subsequently oxidized in the upper aerobic layers of the basin. The facultative lagoon can also be modified to yield a more highly clarified effluent by the inclusion of a separate postsettling pond or a baffled settling compartment.

Aerobic and facultative lagoons are primarily differentiated by the power level employed in the basin. In the aerobic lagoon, the power level is sufficiently high to maintain all solids in suspension and may vary from 14 to 20 hp/million gal (2.8



**FIGURE 7.6**  
Aerated lagoon types.



**FIGURE 7.7**  
Aerated lagoon treating pulp and paper mill wastewater.

to  $3.9 \text{ W/m}^3$ ) of basin volume, depending on the nature of the suspended solids in the influent wastewater. Field data demonstrated that  $14 \text{ hp/million gal}$  ( $2.8 \text{ W/m}^3$ ) was generally sufficient to maintain pulp and paper solids in suspension, while  $20 \text{ hp/million gal}$  ( $3.9 \text{ W/m}^3$ ) was required for domestic wastewater treatment.

In the facultative lagoon, the power level employed is sufficient only to maintain dispersion and mixing of the dissolved oxygen. Experience in the pulp and paper industry showed that a minimum power level employing low-speed mechanical surface aerators is  $4 \text{ hp/million gal}$  ( $0.79 \text{ W/m}^3$ ). The use of other kinds of aeration equipment might require different power levels to maintain uniform dissolved oxygen in the basin.

### Aerobic Lagoons

At a constant basin detention time, the equilibrium biological solids concentration and the overall rate of organic removal can be expected to increase as the influent organic concentration increases. For a soluble industrial wastewater, the equilibrium biological solids concentration  $X_v$  can be predicted from the relationship:

$$X_v = \frac{aS_r}{1 + bt} \quad (7.6)$$

When nondegradable volatile suspended solids are present in the wastewater, Eq. (7.6) becomes

$$X_v = \frac{aS_r}{1 + bt} + X_i \quad (7.7)$$

in which  $X_i$  = influent volatile suspended solids not degraded in the lagoon. Combining Eq. (7.6) with the kinetic relationship [Eq. (6.24)], the effluent soluble organic concentration can be computed:

$$\frac{S}{S_o} = \frac{1 + bt}{aKt} \quad (7.8)$$

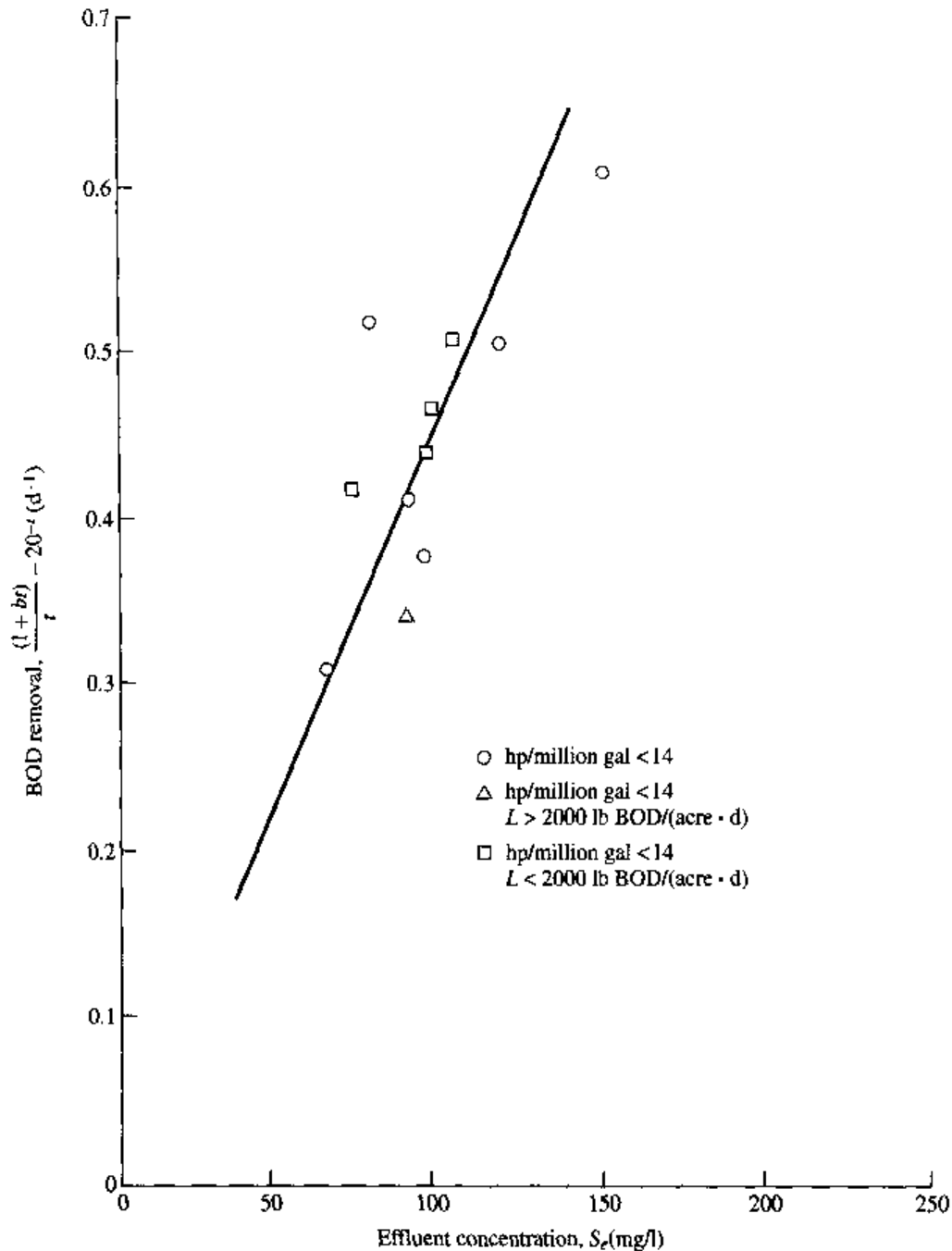
From Eq. (7.8), it can be concluded that the fraction of effluent soluble organic concentration remaining is independent of the influent organic concentration. For lagoons with fixed detention times, this conclusion is justified because higher influent organic concentrations result in higher equilibrium biological solids levels and, therefore, higher overall BOD removal rates. This relationship is shown in Fig. 7.8 for several wastewaters.

The specific organic reaction rate coefficient  $K$  is temperature-dependent, and can be corrected for temperature by Eq. (6.35). The oxygen requirements for an aerobic lagoon are computed using the same relationship employed for activated sludge [Eq. (6.18)]. Aerobic lagoons are employed for pretreatment of high-strength industrial wastewaters prior to discharge to a joint or municipal treatment system, or as the first basin in a two-basin aerated lagoon series, followed by a facultative basin. It should be noted that, while in an aerobic lagoon the soluble organic content is reduced, there is an increase in the effluent suspended solids through synthesis. The relationship obtained for an aerobic lagoon pretreating a brewery wastewater is shown in Fig. 7.9.

Power requirements should generally be designed for summer operation, since the rates of organic removal will be the greatest during this period of operation.

### Facultative Lagoons

In a facultative lagoon, the biological solids level maintained in suspension is a function of the power level employed in the basin. Results from the pulp and paper industry are shown in Fig. 7.10. Solids deposited in the bottom of the facultative lagoon will undergo anaerobic degradation, which results in a feedback of soluble



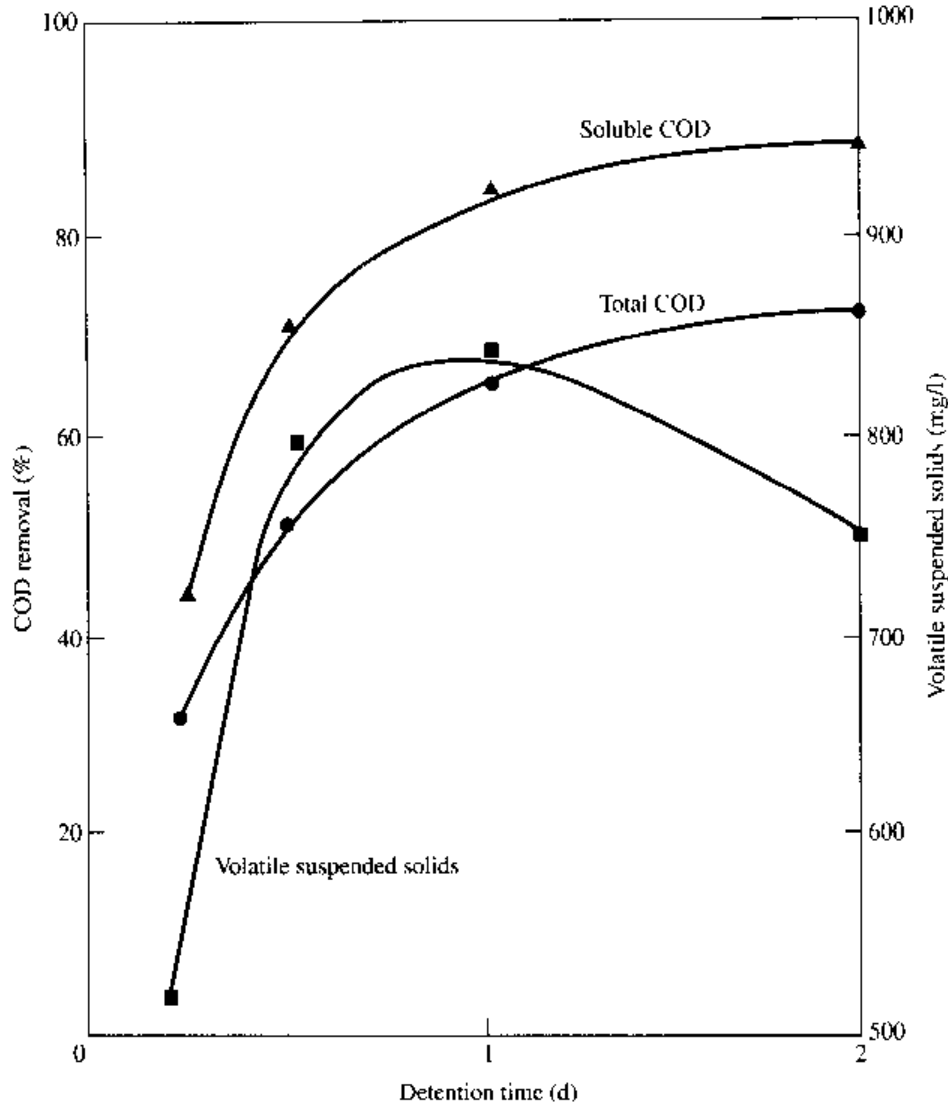
**FIGURE 7.8**  
Kinetic relationships in aerobic lagoons.

organics to the upper aerobic layers. Under these conditions Eq. (6.5) should be modified to

$$\frac{S}{FS_o} = \frac{FS_o}{FS_o + KX_t} \quad (7.9)$$

in which  $F$  is a coefficient that accounts for organic feedback due to anaerobic activity in the deposited sludge layers. The degree of anaerobic activity is highly temperature-dependent and the coefficient  $F$  may be expected to vary from 1.0





**FIGURE 7.9**

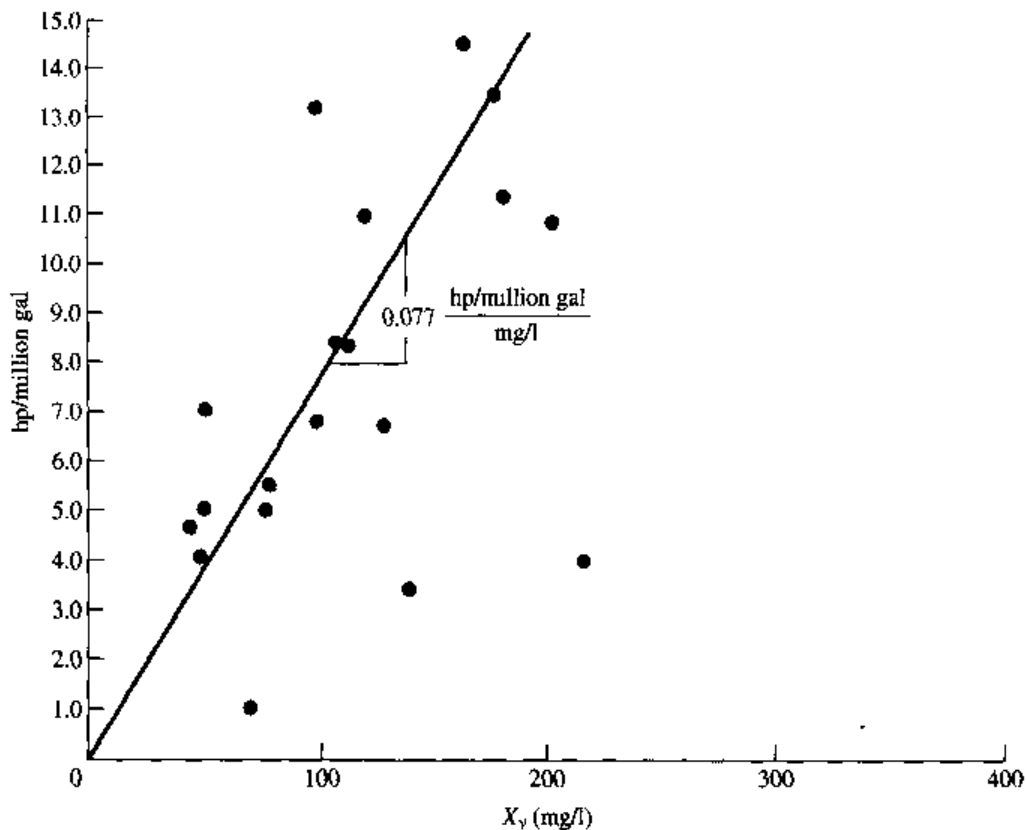
COD removal from brewery wastewater through an aerobic lagoon.

to 1.4 under winter and summer conditions, respectively, depending on the geographical location of the plant.

In a facultative lagoon, biological solids are maintained at a lower level than in an aerobic lagoon, and soluble organics are fed back to the liquid as anaerobic degradation products. It is therefore not possible to directly compute the oxygen requirements by employing Eq. (6.18). In this case, the oxygen requirements can be related empirically to organic removal and estimated from

$$R_r = F' S_r \quad (7.10)$$

in which  $F'$  is an overall oxygen-utilization coefficient for facultative lagoons. Results obtained for various industrial wastewaters would indicate that the coefficient  $F'$  is a function of the degree of organic feedback, which in turn is a function of influent settleable solids and temperature. In general, depending on the geographic location of the plant,  $F'$  can be estimated to vary from 0.8 to 1.1 during



Note: hp/million gal =  $0.1970 \text{ W/m}^3$

**FIGURE 7.10**

Correlation for mixing power input versus MLSS concentrations.

winter operation when anaerobic activity in the basin is low, and from 1.1 to 1.5 during summer operation when anaerobic activity in the bottom of the basin is at a maximum. The value selected will depend on the geographical location of the plant.

Nutrient requirements in aerated lagoons are computed in a similar way to the activated sludge process. In the case of a facultative lagoon, however, anaerobic decomposition of sludge deposited in the bottom of the basin will feed back nitrogen and phosphorus. This is usually sufficient for organic removal occurring in this type of basin, and no additional nitrogen and phosphorus needs to be added. The relationships for the design of aerated lagoon systems are summarized in Table 7.2.<sup>9</sup>

### Temperature Effects in Aerated Lagoons

The performance of aerated lagoons is significantly influenced by changes in basin temperature. In turn, the basin temperatures are influenced by the temperature of the influent wastewater and the ambient air temperature. Although heat is lost through evaporation, convection, and radiation, it is gained by solar radiation. While several formulas have been developed to estimate the temperature in aerated

TABLE 7.2  
Aerated lagoon design relationships<sup>9</sup>

	Aerobic	Facultative	Settling
Relationship	hp/million gal 14 to 20	hp/million gal > 4 < 10	
Kinetics	$\frac{S_1}{S_0} = \frac{1 + bt}{aKt}$	$S_2 = \frac{F^2 S_1^{2+}}{KX_v t^{\ddagger} + FS_1}$	$t < 2d^{\ddagger}$
Oxygen requirements	$O_2/d = a'S_r + b'X_v t$	$O_2/d = \begin{cases} 0.8 - 1.1 S_r \text{ (winter)}^{\ddagger} \\ 1.1 - 1.4 S_r \text{ (summer)} \end{cases}$	
Nutrient requirements	$N = 0.11 \Delta X_v$ $P = 0.02 \Delta X_v$	None required <sup>††</sup>	
Sludge yield	$X_v = \frac{aS_r}{1 + bt}$	0.1 $aS_r$ + inerts <sup>††</sup> 3 to 7 percent weight concentration	

<sup>†</sup> BOD feedback from benthic decomposition varies from 1.0 in winter to 1.4 in summer.

<sup>‡</sup> To minimize algae growth.

<sup>§</sup> Depends on power level in basin (see Fig. 7.10).

<sup>¶</sup> Factors employed depend on geographical location.

<sup>††</sup> Benthic decomposition feeds back N and P.

<sup>‡‡</sup> Most or biovolatile solids will break down through benthic decomposition.

Note: hp/million gal =  $1.98 \times 10^{-2}$  kW/m<sup>3</sup>

lagoons, the following equation will usually give a reasonable estimate for engineering design purposes:

$$\frac{t}{D} = \frac{T_i - T_w}{f(T_w - T_a)} \quad (7.11)$$

where  $t$  = basin detention time, d

$D$  = basin depth, ft

$T_i$  = influent wastewater temperature, °F

$T_a$  = mean air temperature, °F (usually taken as the mean weekly temperature)

$T_w$  = basin temperature, °F

Equation (7.11) was developed for surface aeration and hence cannot be used for subsurface aeration.

The coefficient  $f$  is a proportionality factor containing the heat-transfer coefficients, the surface area increase from aeration equipment, and wind and humidity effects.  $f$  has an approximate value of 90 for most aerated lagoons employing surface aeration equipment.

A general temperature model has been developed by Argaman and Adams<sup>8</sup> that considers an overall heat balance in the basin, including heat gained from solar radiation, mechanical energy input, biochemical reaction, and heat lost by long-wave radiation, evaporation from the basin surface, conduction from the basin sur-

face, evaporation and conduction from the aerator spray, and conduction through the basin walls. Their final equation is

$$\begin{aligned}
 T_w = T_a + & \left[ \frac{Q}{A}(T_i - T_a) + 10^{-6}(1 - 0.0071C_c^2)H_{s,o} + 6.95(\beta - 1) \right. \\
 & + 0.102(\beta - 1)T_a - e^{0.0604T_a} \left( 1 - \frac{f_a}{100} \right) 1.145A^{-0.05}V_w \\
 & \left. + \frac{126NFV_w}{A} + \frac{10^{-6}H_m}{A} + \frac{1.8S_r}{A} \right] \\
 & / \left[ \frac{Q}{A} + 0.102 + (0.068e^{0.0604T_w} + 0.118)A^{-0.05}V_w \right. \\
 & \left. + \frac{4.32NFV_w}{A} (3.0 + 1.75e^{0.0604T_w}) + \frac{10^{-6}UA_w}{A} \right] \quad (7.12)
 \end{aligned}$$

- where
- $T_w$  = basin water temperature, °C
  - $T_a$  = air temperature, °C
  - $T_i$  = influent waste temperature, °C
  - $Q$  = flow rate, m<sup>3</sup>/d
  - $A$  = surface area, m<sup>2</sup>
  - $C_c$  = average cloud cover, tenths
  - $H_{s,o}$  = average daily absorbed solar radiation under clear sky conditions, cal/(m<sup>2</sup> · d)
  - $U$  = heat-transfer coefficient, cal/(m<sup>2</sup> · d · °C)
  - $\beta$  = atmospheric radiation factor
  - $f_a$  = relative humidity, percent
  - $N$  = number of aerators
  - $F$  = aerator spray vertical cross-sectional area, m<sup>2</sup>
  - $V_w$  = wind speed at tree top, m/s
  - $H_m$  =  $15.2 \times 10^6 p$ , where  $p$  = aeration power, hp
  - $S_r$  = organic removal rate, kg COD removed/d
  - $A_w$  = effective wall area, m<sup>2</sup>

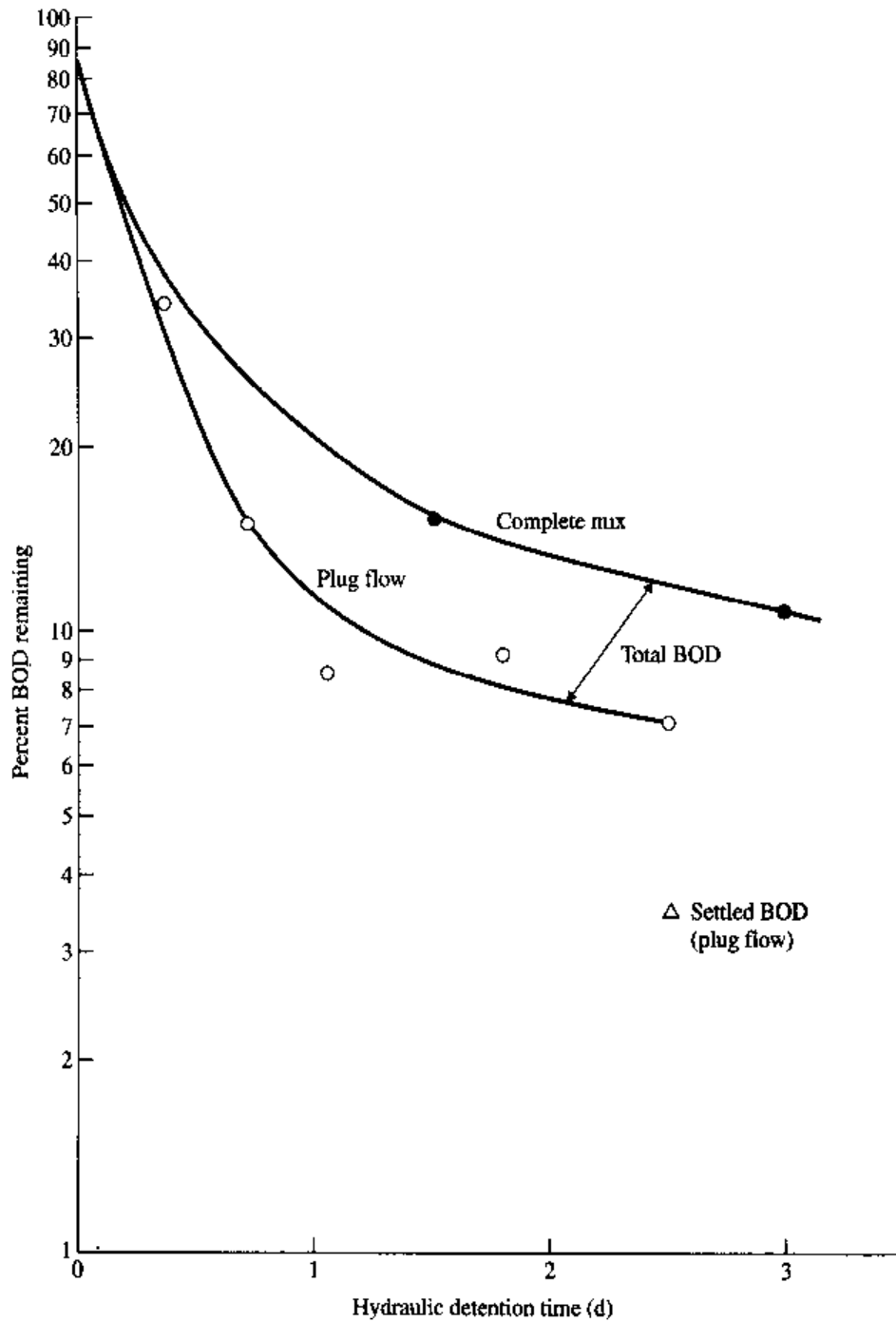
Equation (7.12) can be used to predict the temperature of diffused air systems by substituting

$$NFV_w = 2Q_A$$

where  $Q_A$  = air flow, m<sup>3</sup>/s.

### Aerated Lagoon Systems

Multiple basins may be most effectively employed in aerated lagoon systems under proper conditions. A comparison of single-stage and multistage operation for a pulp and paper mill is shown in Fig. 7.11. As can be seen, multistage operation is more efficient in terms of organic removal. In addition, series operation may be



**FIGURE 7.11**

Pilot plant results for single- and multistage operation.

desired where land availability is a concern. In considering a thermal balance, a minimum total basin volume can be obtained by employing two basins in series. The first basin volume is minimized to maintain a high temperature, a high biological solids level, and a resulting high BOD reaction rate in an aerobic lagoon. The second basin is a facultative basin at lower power (mixing) levels that permit solids settling and decomposition in the bottom of the basin. An optimization procedure can be employed to determine the smallest total basin volume and the low-

est aeration horsepower for a specified effluent quality. Where low effluent suspended solids are desired, a final settling basin can be employed. The settling basin should have:

1. A sufficiently long detention period to effect the desired suspended solids removal
2. Adequate volume for sludge storage
3. Minimal algal growth
4. Minimal odors from anaerobic activity

Unfortunately, these design objectives are not always compatible. Frequently short retention times are required to inhibit algal growth, which are too short for proper settling. Also, adequate volume must remain above the sludge deposits at all times to prevent the escape of the odorous gases of decomposition.

In order to achieve these objectives, a minimum detention time of 1 d is usually required to settle the majority of the settleable suspended solids. Where algal growths pose potential problems, a maximum detention time of 3 to 4 d is recommended. For odor control, a minimum water level of 3 ft (0.9 m) should be maintained above the sludge deposits at all times. Parker<sup>10</sup> has shown that a scale-up factor needs to be applied in aerated lagoon process design. The effect of scale on aerated lagoon treatment of a petrochemical wastewater is shown below:

Scale	$t, d$	$K_{20}$
Bench	0.83	10.0
Pilot	0.83	5.3
Full	1.3	2.8

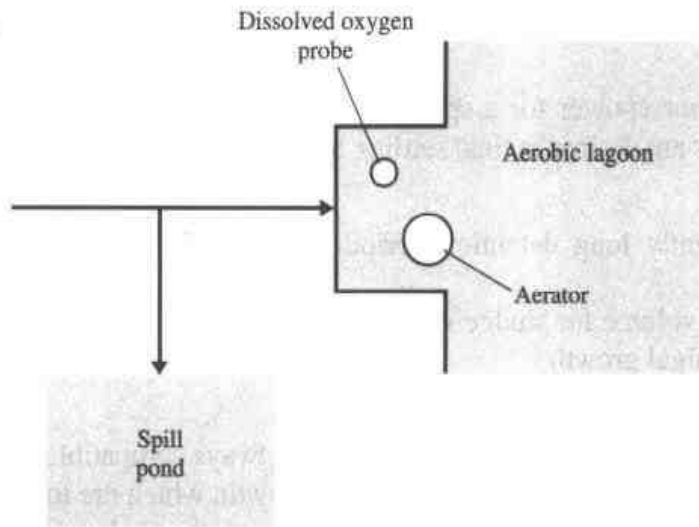
Parker<sup>10</sup> attributes this to wall effects in the bench scale and to differences in fluid shearing intensity. In any event, caution should be exercised in scaling up a design from laboratory data.

One problem with aerated lagoons, as well as other technologies, is the effect of shock loads on effluent quality. In one pulp and paper mill effluent, a dissolved oxygen probe at the head end of the basin was used to trigger a diversion to a spill pond as shown in Fig. 7.12. In this case when the dissolved oxygen dropped below 2 mg/l, indicating a shock load, a portion of the wastewater was diverted. The spill basin contents were then pumped at a controlled rate to the aerobic lagoon under dissolved oxygen control. The variability of one aerated lagoon performance is shown in Fig. 7.13.<sup>11</sup>

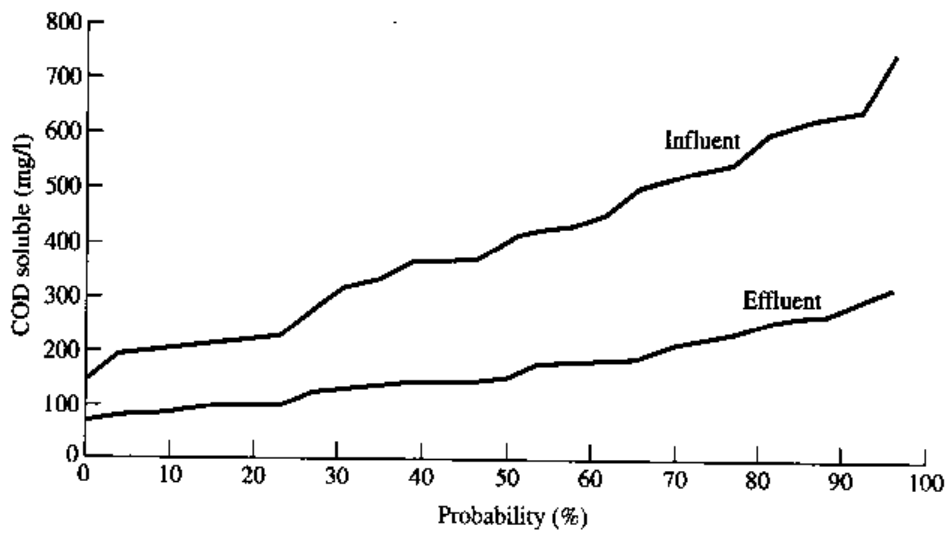
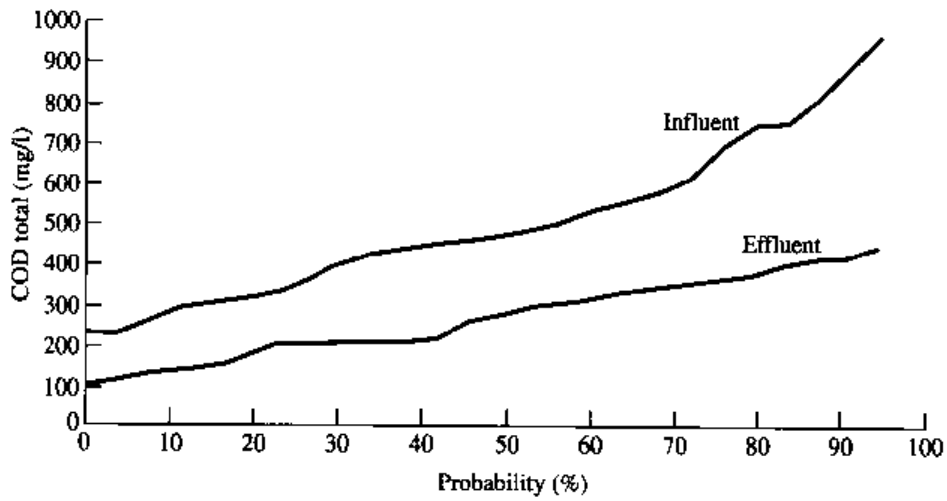
The design of an aerated lagoon system is illustrated by Example 7.2. Where temperature is not a consideration, a simplified procedure can be employed as shown in Example 7.3.

**EXAMPLE 7.2.** Design a two-stage aerated lagoon system of 12 ft (3.66 m) depth to treat an 8.5 million gal/d (32,170 m<sup>3</sup>/d) industrial wastewater with the following characteristics:

Influent: BOD<sub>5</sub> = 425 mg/l  
 Temperature = 85°F (29°C)  
 SS = 0 mg/l



**FIGURE 7.12**  
Spill diversion control.



**FIGURE 7.13**  
Performance of aerated ponds—COD removal.<sup>11</sup>

Ambient temperature: summer = 70°F (21°C)  
winter = 34°F (1°C)

Kinetic variables:  $K = 63/\text{d}$  at 20°C  
 $a = 0.5$   
 $b = 0.2/\text{d}$  at 20°C  
 $a' = 0.52$   
 $b' = 0.28/\text{d}$  at 20°C  
 $\theta = 1.035$  for BOD reaction rate  
 $\theta = 1.024$  for oxygen-transfer efficiency  
 $F = 1.0$  (winter)  
 $= 1.4$  (summer)  
 $F' = 1.5$  (summer)  
 $N_o = 3.2 \text{ lb O}_2/(\text{hp} \cdot \text{h})$  [1.95 kg/(kW · h)]  
 $\alpha = 0.85$   
 $\beta = 0.90$   
 $C_L = 1.0 \text{ mg/l}$

The final effluent should have a maximum soluble BOD<sub>5</sub> of 20 mg/l for the summer and 30 mg/l for the winter.

**Solution.**

In general, the required detention time of the lagoon system for reaching a terminal BOD<sub>5</sub> is controlled by winter temperatures while the oxygen requirements and power level will usually be controlled by summer conditions.

(a) *Design of basin based on minimum detention time*

1. Compute basin volume by assuming a detention time.

For  $t = 2 \text{ d}$ :

$$\begin{aligned} V &= Qt \\ &= 8.5 \times 2 \\ &= 17 \text{ million gal} \quad (64,350 \text{ m}^3) \end{aligned}$$

2. Calculate winter water temperature in basin:

$$\frac{t}{D} = \frac{T_i - T_w}{f(T_w - T_a)}$$

or

$$\begin{aligned} T_w &= \frac{DT_i + ftT_a}{D + ft} \\ &= \frac{12 \times 85 + 1.6 \times 2 \times 34}{12 + 1.6 \times 2} \\ &= 74.3^\circ\text{F} \quad \text{or} \quad 23.5^\circ\text{C} \end{aligned}$$

3. Correct the BOD reaction rate for winter conditions:

$$\begin{aligned} K_{(T_2)} &= K_{(T_1)} \theta^{T_2 - T_1} \\ K_{23.5} &= 6.3 \times 1.035^{23.5 - 20} \\ &= 7.11/\text{d} \end{aligned}$$



4. Calculate the winter effluent soluble BOD<sub>5</sub>:

$$\frac{S_e}{S_o} = \frac{1 + bt}{aKt}$$

$$S_e = \frac{1 + 0.2 \times 2}{0.5 \times 7.11 \times 2} 425$$

$$= 83.7 \text{ mg/l}$$

5. Repeat steps 2 through 4 for summer conditions:

$$T_w = \frac{12 \times 85 + 1.6 \times 2 \times 70}{12 + 1.6 \times 2}$$

$$= 81.8^\circ\text{F or } 27.7^\circ\text{C}$$

$$K_{27.7} = 6.3 \times 1.035^{27.7-20}$$

$$= 8.21/\text{d}$$

$$S_e = \frac{1 + 0.2 \times 2}{0.5 \times 8.21 \times 2} 425$$

$$= 72.5 \text{ mg/l}$$

6. Calculate average volatile suspended solids concentration under summer conditions:

$$X_v = \frac{aS_y}{1 + bt}$$

$$= \frac{0.5(425 - 72.5)}{1 + 0.2 \times 2}$$

$$= 126 \text{ mg/l}$$

7. Calculate oxygen requirement:

$$R_r = a'S_r + b'X_v$$

$$= 0.52 \times (425 - 72.5) \times 8.5 \times 8.34 + 0.28 \times 126 \times 8.5 \times 2 \times 8.34$$

$$= 17,996 \text{ lb/d (8170 kg/d)}$$

8. Compute horsepower requirement:

$$N = N_o \frac{\beta C_s - C_t}{C_{s(20)}} a\theta^{T-20}$$

$$= 3.2 \frac{0.90 \times 7.96 - 1.0}{9.2} 0.85 \times 1.024^{27.7-20}$$

$$= 2.19 \text{ lb/(hp} \cdot \text{h) (1.33 kg/kW} \cdot \text{h)}$$

$$\text{hp} = \frac{R_r}{N}$$

$$= \frac{17,996}{2.19 \times 24} = 342 \text{ hp (257 kW)}$$

9. Check power level:

$$\begin{aligned} \text{PL} &= \frac{\text{hp}}{V} \\ &= \frac{342}{17} = 20.1 \text{ hp/million gal} \quad (0.40 \text{ kW/m}^3) \end{aligned}$$

For a conservative design, the minimum power level should be 14 hp/million gal (0.28 kW/m<sup>3</sup>). If the power level is significantly less than 14 hp/million gal, then 14 hp/million gal should be used.

10. Repeat steps 1 through 9 using different detention times. The results can be tabulated as follows:

t, d	Winter or summer	$T_w$		K, d <sup>-1</sup>	$S_r$ , mg/l	$X_r$ , mg/l	$R_r$ , lb/d	hp required	PL, hp/million gal
		°F	°C						
1.0	W	79.0	26.1	7.77	131				
	S	83.2	28.4	8.41	121	127	13,727	261	30.7
2.0	W	74.3	23.5	7.11	83.7				
	S	81.8	27.7	8.21	72.5	126	17,996	342	20.1
3.0	W	70.4	21.3	6.59	68.8				
	S	80.7	27.1	8.04	56.4	115	20,436	389	153
4.0	W	67.3	19.6	6.21	61.6				
	S	79.8	26.6	7.91	48.4	105	22,219	476 (423) <sup>†</sup>	14 (12.4) <sup>†</sup>
5.0	W	64.6	18.1	5.90	57.6				
	S	79.0	26.1	7.77	43.8	95	23,480	595 (449)	14 (10.6)
6.0	W	62.3	16.8	5.64	55.3				
	S	78.3	25.7	7.66	40.7	87	24,528	714 (469)	14 (9.2)

† Minimum power level applied.

(b) *Design of basin based on minimum detention time*

It is assumed that the minimum power level in a facultative lagoon should be 4 hp/million gal (0.079 kW/m<sup>3</sup>) to maintain 50 mg/l of volatile suspended solids in suspension. The design of this basin is based on selecting an effluent BOD concentration from the first basin at given detention times to be the influent to the second basin.

1. Calculate the temperature in this basin and adjust the BOD reaction rate by assuming a detention time. For example, the effluent BOD concentrations at a 2-d detention time for the first basin are 83.7 and 72.5 mg/l for winter and summer, respectively. Basin temperature:

$$T_w = \frac{DT_i + ftT_a}{D + ft}$$

Corrected influent concentration:

$$S'_o = FS_o$$

Corrected BOD reaction rate:

$$K_{20} = \frac{6.3}{425} S'_o$$

Assume  $t = 5$  d.

Winter:

$$T_w = \frac{12 \times 74.3 + 1.6 \times 5 \times 34}{12 + 1.6 \times 5}$$

$$= 58.2^\circ\text{F} \quad \text{or} \quad 14.6^\circ\text{C}$$

$$K_{20} = \frac{6.3}{425} \cdot 1.0 \times 83.7$$

$$= 1.24/\text{d}$$

$$K_{14.6} = 1.24 \times 1.035^{14.6-20}$$

$$= 1.03/\text{d}$$

Summer:

$$T_w = \frac{12 \times 81.8 + 1.6 \times 5 \times 70}{12 + 1.6 \times 5}$$

$$= 77.1^\circ\text{F} \quad \text{or} \quad 25.1^\circ\text{C}$$

$$K_{20} = \frac{6.3}{425} \cdot 1.4 \times 72.5$$

$$= 1.50/\text{d}$$

$$K_{25.1} = 1.50 \times 1.035^{25.1-20}$$

$$= 1.79/\text{d}$$

2. Compute the detention time required to reduce the soluble BOD to the prescribed level:

$$S'_o = FS_o$$

$$t = \frac{S'_o(S'_o - S_e)}{KX_v S_e}$$

Winter:

$$S'_o = 83.7 \text{ mg/l}$$

$$t = \frac{83.7(83.7 - 30)}{1.03 \times 50 \times 30}$$

$$= 2.91 \text{ d}$$

Summer:

$$S'_o = 1.4 \times 72.5$$

$$= 102 \text{ mg/l}$$

$$t = \frac{102(102 - 20)}{1.79 \times 50 \times 20}$$

$$= 4.67 \text{ d}$$

Now summer conditions are controlling.

3. Repeat steps 1 and 2 until the computed detention time in step 2 is close enough to the assumed value in step 1. Final results are as follows:

$$t = 4.67 \text{ d}, V = 39.7 \text{ million gal (150,300 m}^3\text{)}$$

Winter:  $T_w = 58.8^\circ\text{F}$  or  $14.9^\circ\text{C}$

$$K_{14.9} = 1.04/\text{d}$$

$$S_e = 21.5 \text{ mg/l}$$

Summer:  $T_w = 77.3^\circ\text{F}$  or  $25.2^\circ\text{C}$

$$K_{25.2} = 1.79/\text{d}$$

$$S_e = 20.0 \text{ mg/l}$$

4. Calculate oxygen requirement:

$$R_r = F'S_r$$

$$= 1.5 \times (1.4 \times 72.5 - 20.0) \times 8.5 \times 8.34$$

$$= 8666 \text{ lb/d (3934 kg/d)}$$

5. Calculate horsepower requirement:

$$N = N_o \frac{\beta C_s - C_L}{C_s(20)} a\theta^{T-20}$$

$$= 3.2 \frac{0.90 \times 8.36 - 1.0}{9.2} 0.85 \times 1.024^{25.2-20}$$

$$= 2.18 \text{ lb/(hp} \cdot \text{h) [1.33 kg/(kW} \cdot \text{h)]}$$

$$\text{hp} = \frac{R_r}{N}$$

$$= \frac{8666}{2.18 \times 24}$$

$$= 166 \text{ hp (125 kW)}$$

6. Check power level:

$$\text{PI} = \frac{\text{hp}}{V}$$

$$= \frac{166}{39.7}$$

$$= 4.2 \text{ hp/million gal (0.083 kW/m}^3\text{)}$$

7. Repeat steps 1 through 6 using different detention times in the first basin with the adequate detention time in the second basin to meet the desired effluent quality. The results are tabulated below:

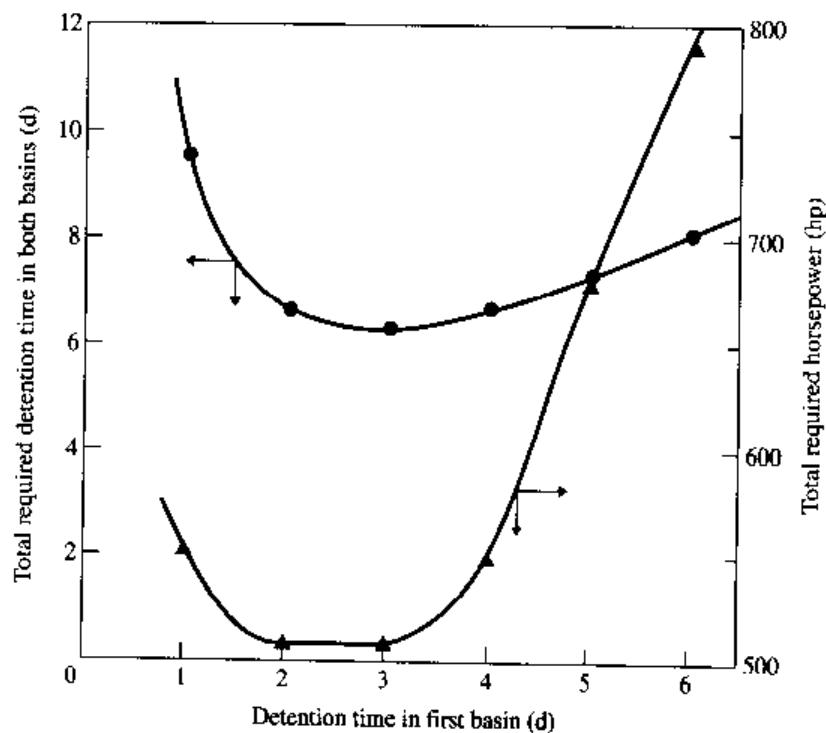
$S_o$ , mg/l	$T_w$		$K$ , $d^{-1}$	$t$ , d	$S_e$ , mg/l	$X_v$ , mg/l	$R_r$ , lb/d	hp required	PL, hp/million gal
	$^{\circ}F$	$^{\circ}C$							
131	55.0	12.8	1.51	8.57	22.1	50			
121	76.2	24.6	2.94	8.57	20.0	50	10,740	291 (205) <sup>†</sup>	4.0 (2.8) <sup>†</sup>
83.7	58.8	14.9	1.04	4.67	21.5	50			
72.5	77.3	25.2	1.79	4.67	20.0	50	8,666	166	4.2
68.8	59.2	15.1	0.862	3.33	22.3	50			
56.4	77.4	25.2	1.40	3.33	20.0	50	6,274	120	4.2
61.6	58.4	14.7	0.761	2.72	23.0	50			
48.4	77.2	25.1	1.19	2.72	20.0	50	5,083	97	4.2
57.6	57.3	14.1	0.697	2.34	23.8	50			
43.8	76.9	24.9	1.08	2.34	20.0	50	4,392	84	4.2
55.3	56.1	13.4	0.653	2.12	24.6	50			
40.7	76.5	24.7	0.993	2.12	20.0	50	3,934	75	4.2

<sup>†</sup> Minimum power level applied

(c) *Optimum lagoon system*

This two-stage lagoon system can be optimized to minimize either the total detention time or the total horsepower to be installed.

The following figure shows the summarized design results of the two-stage lagoon system. The minimum total required detention time is 6.33 d, with a corresponding total



Effect of detention time in first basin on total required time and horsepower.

installed horsepower of 509 hp (382 kW). The minimum total horsepower is 508 hp (381 kW) with a total detention time of 6.67 d. The second alternative may be the optimum system since the increased basin size will be more tolerable to the influent fluctuation in both flow rate and constituent concentration. It will also be justified by an economic gain realized by operating with less power input, although the difference in the horsepower installed is minimal. In this alternative, the detention time in the first basin is 2 d and the detention time in the second basin 4.67 d. The results are tabulated below:

First basin	<i>t</i> , d		hp installed		
	Second basin	Total	First basin	Second basin	Total
1.0	8.57	9.57	261	291	552
2.0	4.67	6.67	342	166	508
3.0	3.33	6.33	389	120	509
4.0	2.72	6.72	476	97	573
5.0	2.34	7.34	595	84	679
6.0	2.12	8.12	714	75	789

**EXAMPLE 7.3.** Design an aerated lagoon system consisting of an aerobic and a facultative lagoon for the following conditions:

$$\begin{aligned} \text{Flow} &= 4 \text{ million gal/d} \\ S_o &= 450 \text{ mg/l} \\ S_e &= 20 \text{ mg/l (soluble)} \\ K &= 6 \text{ d}^{-1} \\ b &= 0.1 \text{ d}^{-1} \\ a &= 0.6 \\ a' &= 0.5 \end{aligned}$$

**Solution.**

Design the aerobic lagoon:

$$\frac{S_e}{S_o} = \frac{1 + bt}{aKt}$$

<i>t</i> , d	$S_e/S_o$	$S_e$
1	0.3	135
2	0.17	77
3	0.12	54
4	0.097	44

Use a 2-d detention time in the aerobic lagoon.

$$\begin{aligned} X_v &= \frac{aS_r}{1 + bt} \\ &= \frac{0.6 \cdot 373}{1.2} = 187 \text{ mg/l} \end{aligned}$$

Oxygen requirement:

$$\begin{aligned} O_2 &= a'S_r + 0.14 X_v t \\ &= 0.5 \cdot 373 + 0.14 \cdot 187 \cdot 2 \\ &= 239 \text{ mg/l} \end{aligned}$$

$$\text{lb } O_2/\text{d} = 239 \cdot 4 \cdot 8.34 = 7968$$

$$\text{hp} = \frac{7968}{24 \cdot 1.5 \text{ lb } O_2/(\text{hp} \cdot \text{h})} = 22$$

$$\text{hp/million gal} = \frac{221}{8} = 27.7$$

Nutrient requirements:

$$\begin{aligned} N &= 0.11 \Delta X_v = 0.11 \cdot 187 = 20.6 \text{ mg/l} \\ &= 20.6 \cdot 4 \cdot 8.34 = 687 \text{ lb/d} \end{aligned}$$

$$\begin{aligned} P &= 0.02 \Delta X_v = 0.02 \cdot 187 = 3.74 \text{ mg/l} \\ &= 3.74 \cdot 4 \cdot 8.34 = 125 \text{ lb/d} \end{aligned}$$

Facultative lagoon: Reduce  $K$  to consider the lower reaction rate in the facultative lagoon [Eq. 6.28].

$$\begin{aligned} K_1 &= K \frac{S_1}{S_0} = 6 \cdot \frac{77}{450} \\ &= 1.02 \text{ d}^{-1} \end{aligned}$$

Use a feedback factor of 1.2. Assume  $X_v = 100 \text{ mg/l}$ .

$$\frac{(FS_1)^2 - S_0(FS_1)}{S_0 K X_v} = t$$

$$t = 3.27 \text{ d}$$

Oxygen requirement:

$$(77 \cdot 1.2 - 20) \cdot 4 \cdot 8.34 = 2400 \text{ lb/d}$$

$$\text{hp} = \frac{2400}{24 \cdot 1.5 \text{ lb } O_2/(\text{hp} \cdot \text{h})} = 67$$

$$\text{hp/million gal} = \frac{67}{3.27 \cdot 4} = 5$$

### 7.3

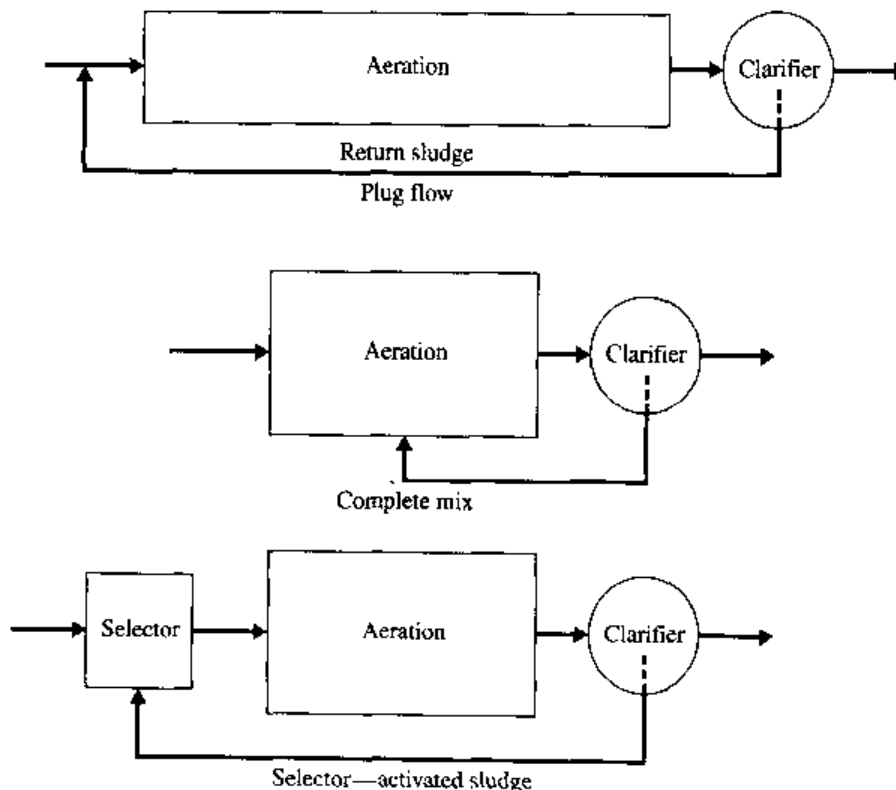
## ACTIVATED SLUDGE PROCESSES

The objective of the activated sludge process is to remove soluble and insoluble organics from a wastewater stream and to convert this material into a flocculent

microbial suspension that is readily settleable and will permit the use of gravitational solid-liquid separation techniques. A number of different modifications or variants of the activated sludge process have been developed since the original experiments of Arden and Lockett in 1914. These variants, to a large extent, have been developed out of necessity or to suit particular circumstances that have arisen. For the treatment of industrial wastewater, the common generic flowsheets are shown in Fig. 7.14. As discussed in Chap. 6, the nature of the wastewater will dictate the process type. Figure 7.15 illustrates the types of reaction that will occur and hence dictate the candidate process.

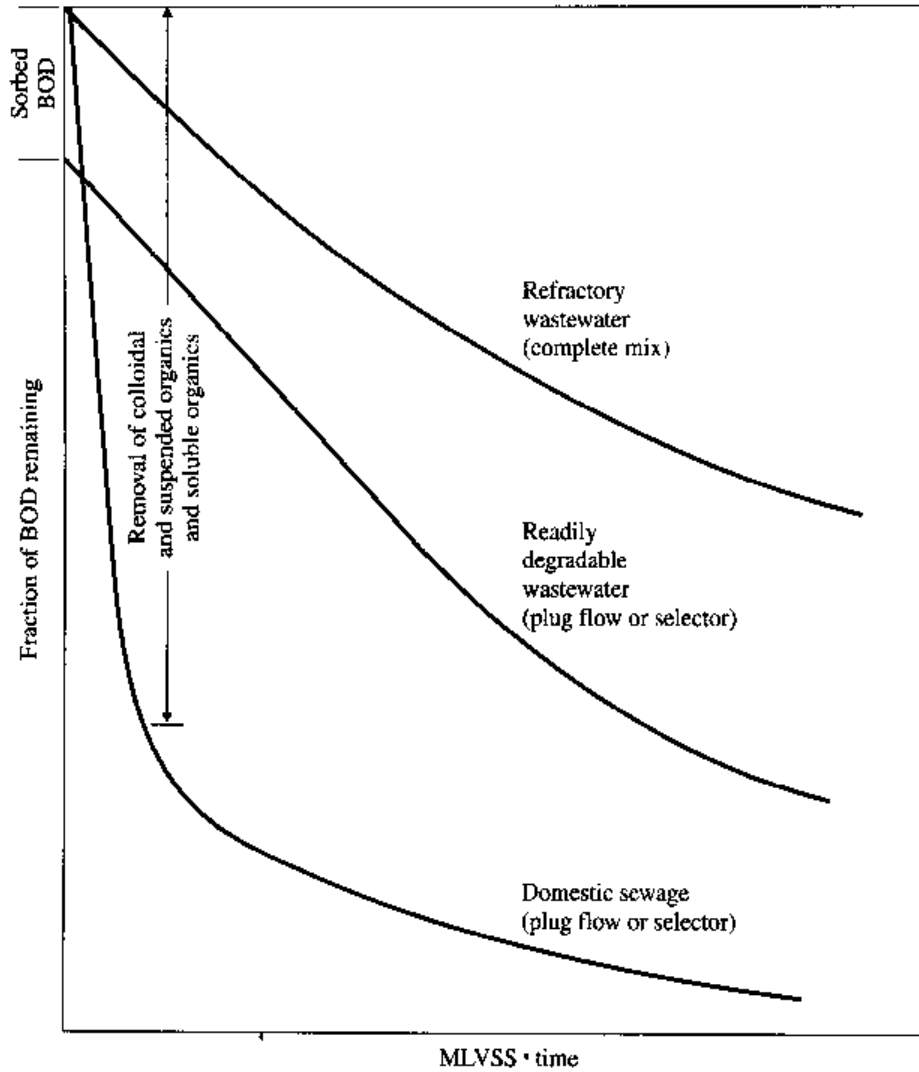
### Plug Flow Activated Sludge

The plug flow activated sludge process uses long, narrow aeration basins to provide a mixing regime that approaches plug flow. Wastewater is mixed with a biological culture under aerobic conditions. The biomass is then separated from the liquid stream in a secondary clarifier. A portion of the biological sludge is wasted and the remainder returned to the head of the aeration tank with additional incoming waste. The rate and concentration of activated sludge returned to the basin determine the mixed liquor suspended solids concentration. As discussed in Chap. 6, a plug flow regime promotes the growth of a well-flocculated, good settling sludge. If the wastewater contains toxic or inhibiting organics, they must be



**FIGURE 7.14**  
Types of activated sludge processes.





**FIGURE 7.15**  
Removal of BOD in the activated sludge process.

removed or equalized prior to entering the head end of the aeration basin. The oxygen utilization rate is high at the beginning of the aeration basin and decreases with aeration time. Where complete treatment is achieved, the oxygen utilization rate approaches the endogenous level toward the end of the aeration basin.

The dispersion number  $N_D$  can be used to express the degree of longitudinal mixing in an activated sludge plant. The dispersion number is a dimensionless number

$$N_D = \frac{D}{UL} \quad (7.13)$$

where  $N_D$  = dispersion number  
 $U$  = mean velocity of flow, m/s  
 $L$  = total length of aeration tank, m  
 $D$  = coefficient of axial dispersion,  $m^2/s$

A value of  $0.068 \text{ m}^2/\text{s}$  for  $D$  was determined by Boon et al.<sup>12</sup> in 24 activated sludge plants. Values of  $N_D$  less than about 0.1 should ensure good plug flow hydraulics in practice.

Equation (7.13) can be reexpressed:

$$N_D = \frac{Dt}{L^2} \quad (7.13a)$$

in which  $t$  = hydraulic detention time based on  $Q + R$ . The axial dispersion coefficient  $N_D$  is related to the airflow, increasing by a factor of 2 with an airflow increase from 20 to 100 std  $\text{ft}^3/\text{min}$  per 1000  $\text{ft}^3$  of tank volume.<sup>13</sup>

Modification of the way in which wastewater and recycle sludge are brought into contact in a plug flow system can have a number of benefits. For readily degradable wastewaters, a baffled inlet section will ensure sorption. The provisions of a separate zone at the inlet, with a volume of about 15 percent of the total aeration volume, together with a low-energy subsurface mechanical stirrer, can achieve controlled anoxic conditions such that nitrate associated with the recycled sludge fed to the zone can partially satisfy the BOD fed to the zone. In cases where nitrification occurs, recycle of nitrified mixed liquor from the end of the aeration basin to the anoxic zone at the head end can achieve significant denitrification. A typical plug flow process is shown in Fig. 7.16.

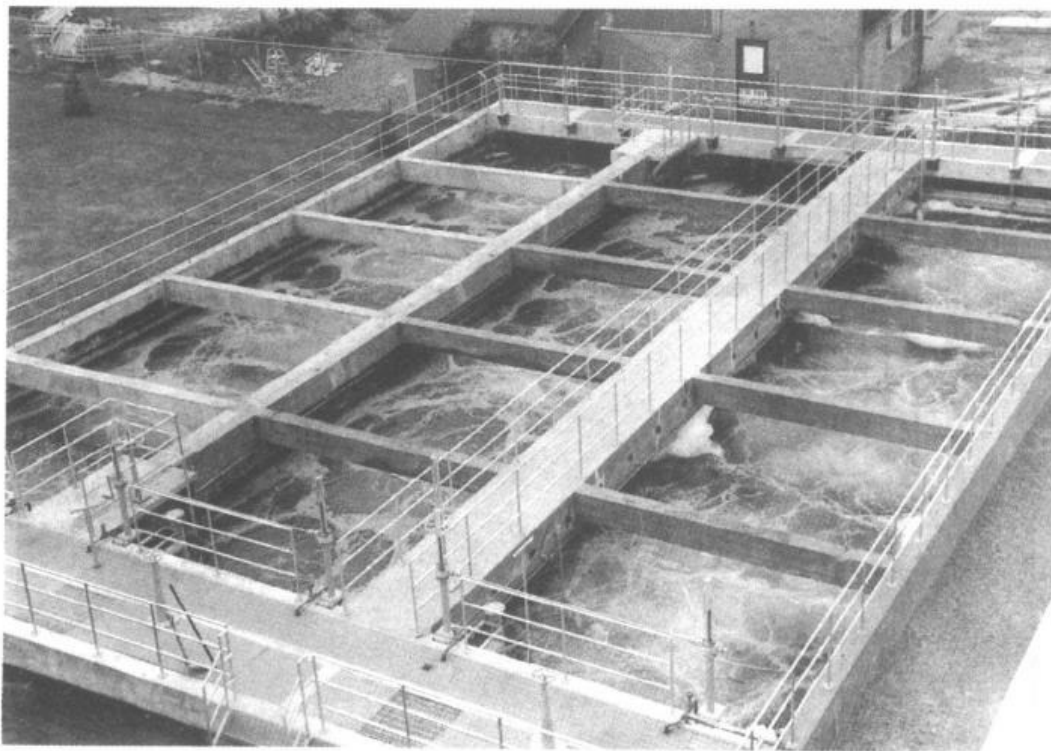


**FIGURE 7.16**  
Plug flow activated sludge process.

## Complete Mix Activated Sludge

To obtain complete mixing in the aeration tank, proper choices of tank geometry, feeding arrangement, and aeration equipment are required. Through the use of complete mixing, with either diffused or mechanical aeration, it is possible to establish a constant oxygen demand as well as a uniform mixed liquor suspended solids (MLSS) concentration throughout the basin volume. Hydraulic and organic load transients are dampened in these systems, giving a process that is very resistant to upset from shock loadings. Influent wastewater and recycled sludge are introduced to the aeration basin at different points. An activated sludge plant is shown in Fig. 7.17. Readily degradable wastewaters such as food-processing wastes will tend toward filamentous bulking in a complete mix system, as has previously been discussed.

Such conditions may be minimized by the inclusion of a precontacting zone to effect a high level of substrate availability to the recycled mixed liquor. The precontacting zone should have a retention time in the order of 15 minutes to maximize biosorption. Design parameters for this contacting zone appear to be waste-specific and require bench-scale trials for their assessment. By contrast, complex chemical wastewaters do not support filamentous growth and complete mix processes work very effectively in them. Performance data from the treatment of several industrial wastewaters are shown in Table 7.3.



**FIGURE 7.17**  
Complete mix activated sludge plant.

TABLE 7.3  
CMAS treatment performance for selected industrial wastewaters

Wastewater	Influent		Effluent		F/M							
	BOD, mg/l	COD, mg/l	BOD, mg/l	COD, mg/l	T, °C	BOD, d <sup>-1</sup>	COD, d <sup>-1</sup>	SRT, d	MVLS, mg/l	HRT, d	SVI, ml/g	ZSV, ft/h
Pharmaceutical	2950	5840	65	712	10.4	0.11	0.19		4970	5.4		
Coke and by-products chemical plant	3290	5780	23	561	20.8	0.11	0.18		5540	5.4		
	1880	1950	65	263		0.18	0.21		2430	4.1	42.4	26
Diversified chemical industry	725	1487	6	257	21	0.41	0.71		2874	0.61	119	4.54
Tannery	1020	2720	31	213	21	0.18	0.45	16	1900	3		
	1160	4360	54	561	21	0.15	0.49	20	2650	3		
Alkylamine manufacturing	893	1289	12	47		0.146	0.21		1977	3.1	133	4.2
ABS	1070	4560	68	510	33.5	0.24	0.94	6	2930	1.5	23	28.7
Viscose rayon	478	904	36	215		0.30	0.47		2759	0.57	117	4.7
Polyester and nylon fibers	207	543	10	107	13.1	0.18	0.40		1689	0.664	116	7.9
	208	559	4	71	22.4	0.20	0.48		1433	0.712	144	8.6
Protein processing	3178	5355	10	362	10	0.054	0.08		2818	21	180	2.9
	3178	5355	5.3	245	26.2	0.100	0.16		2451	12.7	215	2.7
Propylene oxide	532	1124	49	289	20	0.20	0.31		2969	1	51	12.5
	645	1085	99	346	37	0.19	0.25		2491	1.4	32	3.7
Paper mill	375	692	8	79	9.3	0.111	0.19	18.9	1414	2.38	63	22
	380	686	7	75	23.3	0.277	0.45	5.2	748	1.83	504	10
Vegetable oil	3474	6302	76	332		0.57	1.00		1740	3.5	49.2	30
	453	1097	3	178	20.3	0.10	0.21		2160	2.02	111	6.9
Organic chemicals												

### Extended Aeration

In this process, sludge wasting is minimized. This results in low growth rates, low sludge yields, and relatively high oxygen requirements by comparison with the conventional activated sludge processes. The trade-off is between a high-quality effluent and less sludge production. Extended aeration is a reaction-defined mode rather than a hydraulically defined mode, and can be nominally plug flow or complete mix. Design parameters typically include a food/microorganisms (*F/M*) ratio of 0.05 to 0.15, a sludge age of 15 to 35 days, and mixed liquor suspended solids concentrations of 3000 to 5000 mg/l. The extended aeration process can be sensitive to sudden increases in flow due to resultant high MLSS loadings to the final clarifier, but is relatively insensitive to shock loads in concentration due to the buffering effect of the large biomass volume. While the extended aeration process can be used in a number of configurations, a significant number are installed as loop-reactor systems where aerators of a specific type provide oxygen and establish a unidirectional mixing to the basin contents. The use of loop-reactor systems and modifications thereof in wastewater treatment have been significant over recent years.

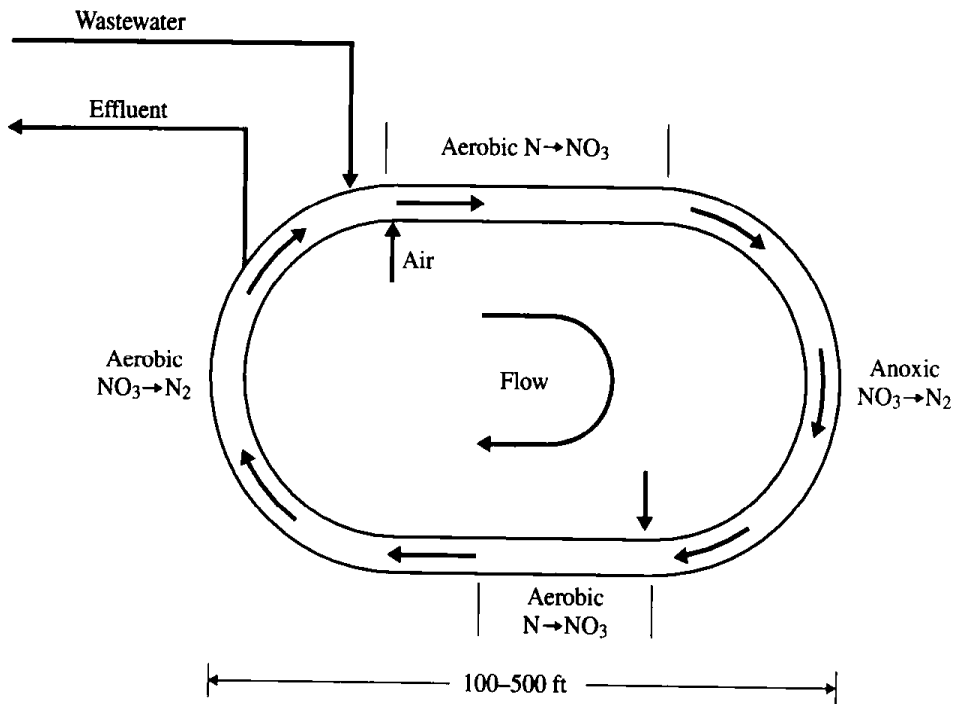
### Oxidation Ditch Systems

A number of loop-reactor or ditch system variants are now available. In any ditch system it is necessary to adequately match basin geometry and aerator performance in order to yield an adequate channel velocity for mixed liquor solids transport. The key design factors in these systems relate to the type of aeration that is to be provided. It is normal to design for a 1 ft/s (0.3 m/s) midchannel velocity in order to prevent solids deposition. The ditch system is particularly amenable to those cases where both BOD and nitrogen removal are desired. Both reactions can be achieved in the same basin by alternating aerobic and anoxic zones, as shown in Fig. 7.18.

A typical oxidation ditch aeration basin consists of a single channel or multiple interconnected channels, as shown in Fig. 7.19.

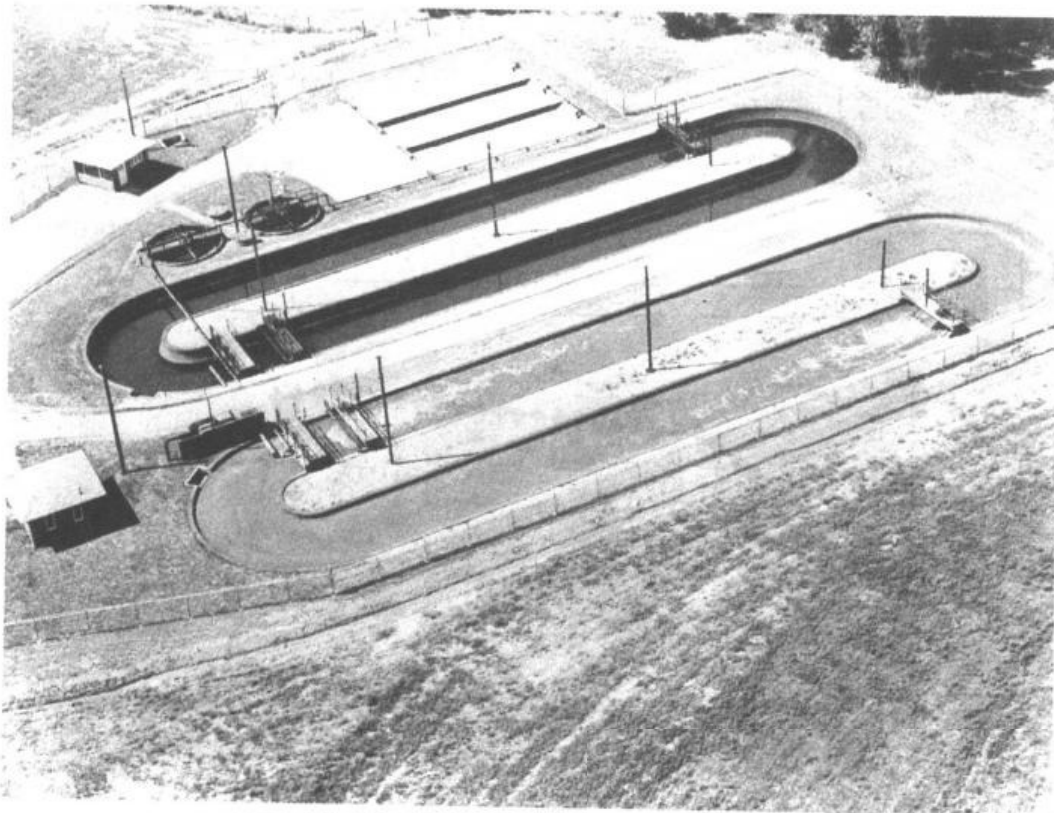
### Intermittently Aerated and Decanted Systems

In the intermittent treatment approach, a single vessel is used to accommodate all of the unit processes and operations normally associated with conventional activated sludge treatment, i.e., primary settlement, biological oxidation, secondary settlement, and sludge digestion, as well as nitrification and the ability for substantial denitrification. In using a single vessel, these processes and operations are simply timed sequences. The sequencing batch reactor (SBR) operates on timed cycles—fill, react, settle, decant—as shown in Fig. 7.20. The feed rate can be adjusted to a batch mode in the case of readily degradable wastewaters to avoid filamentous bulking. The treatment cycle for a pulp and paper mill wastewater is shown in Fig. 7.21. Denitrification is achieved through anoxic cycles. Performance data are shown in Tables 7.4 and 7.5. An SBR plant is shown in Fig. 7.22. A design example is given in Example 7.4.

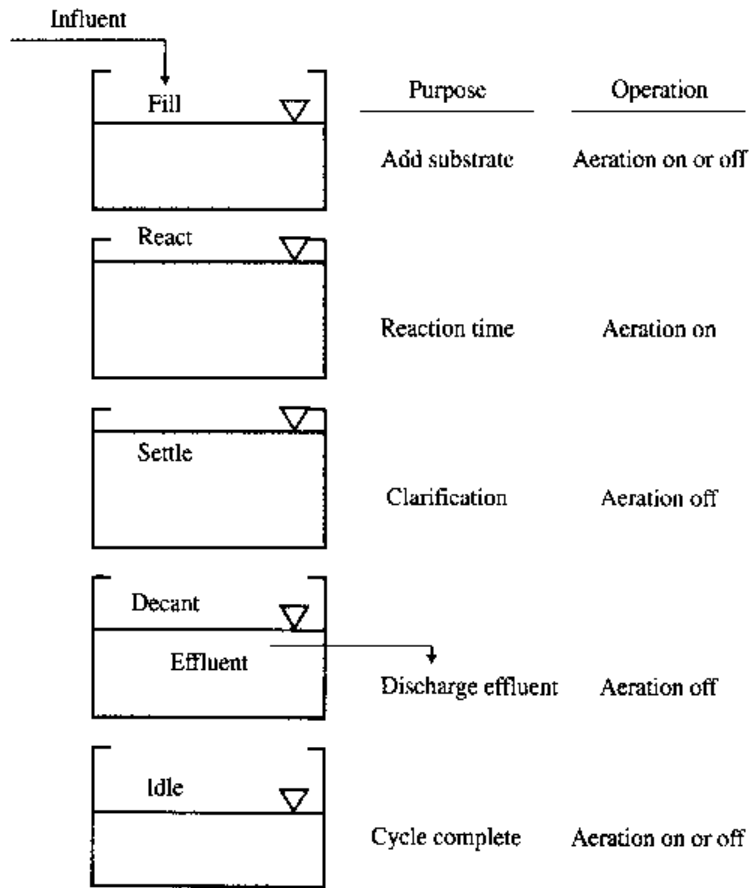


Note: ft = 0.3048 m

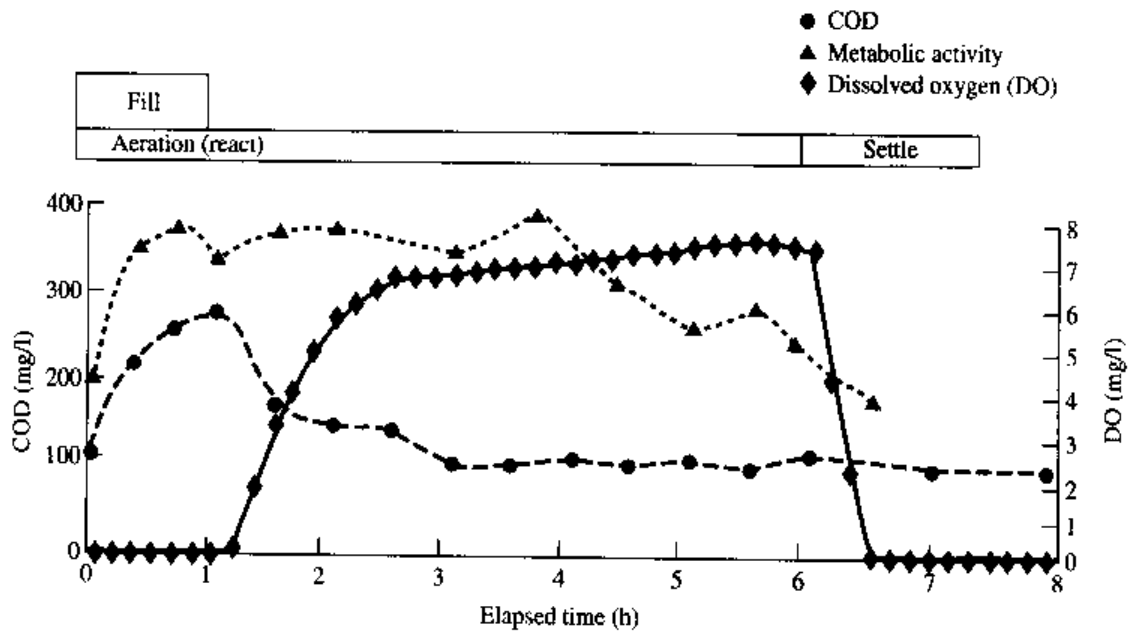
**FIGURE 7.18**  
Oxidation ditch with nitrification and denitrification.



**FIGURE 7.19**  
Oxidation ditch.



**FIGURE 7.20**  
SBR operation sequence.



**FIGURE 7.21**  
COD and metabolic activity of the activated sludge during an SBR cycle of reactor for pulp and paper mill wastewater (20-d sludge age, 8-h cycle time, 6-h aerated react time).<sup>14</sup>

**TABLE 7.4**  
**Treatment of dairy wastewater by an intermittent activated sludge system**

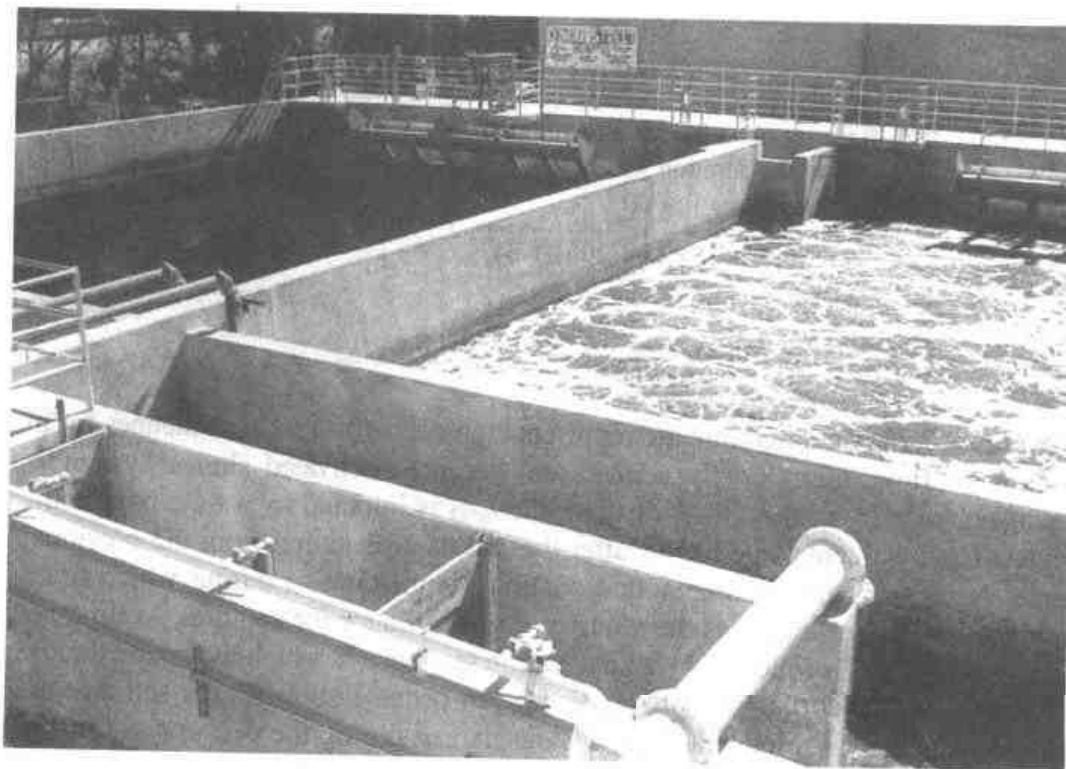
	Influent			Effluent		
	Flow, million gal/d	COD, mg/l	TSS, mg/l	COD, mg/l	BOD, mg/l	TSS, mg/l
Mean	0.094	2400	315	106	15	21
Standard deviation	0.023	903	164	26	104	17
Minimum	0.033	870	73	68	5	3
Maximum	0.133	5636	1030	172	70	80

**TABLE 7.5**  
**SBR treatment of a chemical wastewater<sup>†</sup>**

Sample point	TOC	TOX	Phenol	Benzoic acid	<i>o</i> -CBA <sup>‡</sup>	<i>m</i> -CBA	<i>p</i> -CBA
Feed, mg/l	8135	780	1650	2475	840	240	285
Effluent, mg/l	409	240	<1	7	3	<2	6

<sup>†</sup> 24-h cycle; MLSS = 10,000 mg/l with HRT = 10 d (10% feeding over 4-h fill period).

<sup>‡</sup> Chlorobenzoic acid.



**FIGURE 7.22**  
Sequencing batch reactor (SBR) plant.



**EXAMPLE 7.4.** Design an SBR to treat a wastewater having a flow rate of 0.50 million gal/d and a BOD of 500 mg/l. Assume an  $X_v t$  of 1250 ( $\text{mg} \cdot \text{d}$ )/l and a feed plus aeration period of 10 h, with 1 h settling and 1 h effluent decant periods (12 h total cycle time).

**Solution.**

$$X_v = \frac{1250}{10/24} = 3000 \text{ mg/l}$$

The volume treated during one cycle is 0.25 million gal, and the MLVSS is  $(0.25)(3000)(8.34) = 6255 \text{ lb}$ .

At an SVI of 150 ml/g, the volume required for storage of the settled sludge is

$$\left(150 \frac{\text{ml}}{\text{g}}\right) \left(454 \frac{\text{g}}{\text{lb}}\right) \left(3.53 \times 10^{-5} \frac{\text{ft}^3}{\text{ml}}\right) = 2.4 \text{ ft}^3/\text{lb MLSS}$$

Correcting for MLVSS/MLSS = 0.8, the volume required is

$$V = (6255)(1/0.8)(2.4)(7.48)/10^6 = 0.141 \text{ mg}$$

Provide 3 ft of freeboard between the settled sludge blanket and the supernatant water level at the end of the decant cycle.

The volume for aeration and settled sludge is

$$0.25 \text{ mg} + 0.141 \text{ mg} = 0.391 \text{ mg}$$

Select a side water depth (SWD) of 16 ft. The area is

$$\frac{391,000}{(7.48)(16)} = 3267 \text{ ft}^2$$

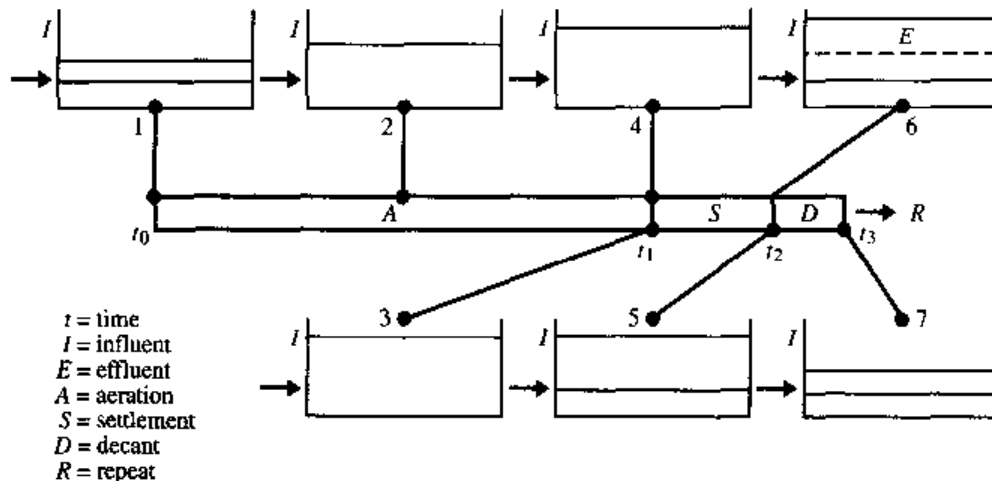
and the tank diameter is 65 ft. Use a total tank depth of 19 ft to include freeboard.

The MLVSS under aeration will be

$$\frac{6255}{(3267 \cdot 16 \cdot 7.48/106)(8.34)} = 1920 \text{ mg/l}$$

$$\text{MLSS} = \frac{1}{0.8} \times 1920 = 2400 \text{ mg/l}$$

Figure 7.23 is a diagrammatic representation of the operating sequences for a continuous-flow intermittently aerated and decanted activated sludge system.<sup>15</sup> Each sequence ( $t_0-t_1$ ,  $t_1-t_2$ ,  $t_2-t_3$ ) of the cycle  $t_0-t_3$  is initiated by a time-base controller. The treatment cycle begins after the end of decantation from the previous cycle. Aeration begins at time  $t_0$  and continues until time  $t_1$ , during which time influent wastewater increases the volume of mixed liquor for aeration. At time  $t_1$ , aeration stops and is followed by a nonaeration sequence in which the mixed liquor undergoes settlement and anoxic processes can occur. Following the settlement/anoxic sequence  $t_1-t_2$ , treated effluent is discharged during the period  $t_2-t_3$ ; at the completion of  $t_3$ , the same sequence of events is repeated. Operational sequences are developed to optimize specific functions within the main process. For example,

**FIGURE 7.23**

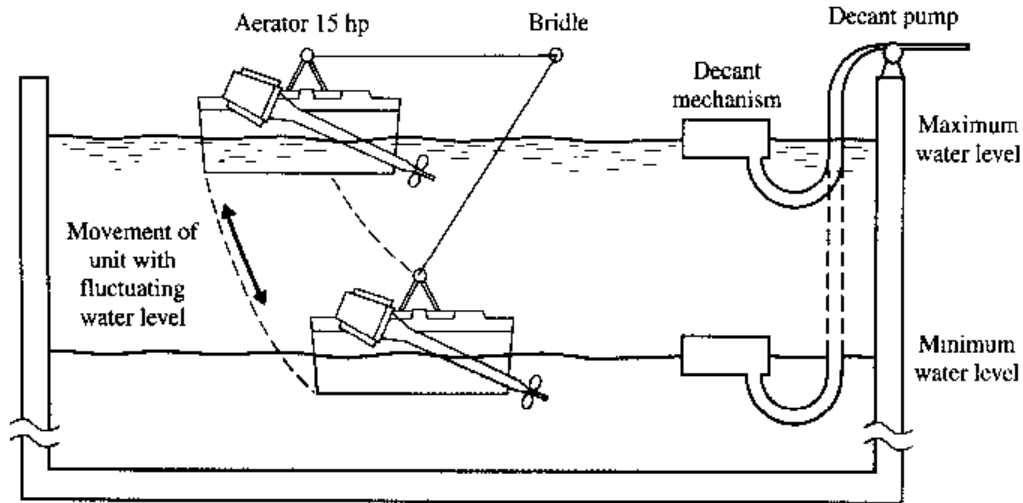
Diagrammatic representation of continuous-flow sequentially aerated activated sludge.

a denitrification cycle will require sufficient aeration to provide for total carbonaceous and nitrogenous oxidation within the time period  $t_0$ - $t_1$ , and the period  $t_1$ - $t_3$  must be adequate to effect the reduction of nitrate.

An important feature of these plants is their ability to accept prolonged high-flow conditions without loss of mixed liquor solids. The hydraulic capacity of conventional continuous systems is limited by the operational capacity of the secondary settlement unit.

The decanting device in these systems is located at the vessel end opposite the inlet. The movable weir of the unit is positioned out of the mixed liquor during aeration and settlement. During the decant sequence, a hydraulic ram is activated, which drives the weir through the surface layer of the vessel to the design bottom water level. In this way, a surface layer of treated effluent is skimmed continuously during the decant sequence from the vessel and discharged out of the vessel by gravity via the carrier system of the decanter.

Plants can be designed for an average  $F/M$  ratio of 0.05 to 0.20 lb BOD/(lb MLSS · d) [0.05 to 0.20 kg BOD/(kg MLSS · d)], depending on the quality of effluent that is specified, at a bottom water level suspended solids concentration of up to 5000 mg/l. In calculating the volume occupied by the sludge mass, an upper sludge volume index of 150 ml/g is used. To ensure solids are not withdrawn during decant, a buffer volume is provided, the depth of which is generally in excess of 1.5 ft (0.5 m) between bottom water level and top sludge level after settlement. Batch activated sludge is similar to the intermittent system except that it is usually employed for high-strength, low-volume industrial wastewaters. Wastewater is added over a short time period to maximize biosorption and flocculent sludge growth. Aeration is then continued for up to 20 h. The mixed liquor is then settled and the treated effluent decanted. A typical batch activated sludge system is shown in Fig. 7.24. Performance data for a high-strength chemical wastewater is shown in Table 7.6. A design example is shown by Example 7.5.



Note: hp = 0.7456 kW

**FIGURE 7.24**  
Batch activated sludge system.

**TABLE 7.6**  
Batch activated sludge treatment performance for a specialty chemicals wastewater

Parameter	Monthly average value							
	March	April	May	June	July	August	September	October
Influent TBOD, mg/l	5,734	5,734	5,734	5,734	7,317	7,317	7,317	7,317
Effluent SBOD, mg/l	43	57	49	119	39	156	91	391
Influent COD, mg/l	10,207	10,207	10,207	10,207	15,242	15,242	15,242	15,242
Effluent COD, mg/l	920	1,992	1,456	2,067	705	2,023	1,682	2,735
Effluent TSS, mg/l	386	828	640	940	250	657	640	700
MLSS, mg/l	9,246	2,430	5,520	3,108	10,300	2,025	9,761	4,572
HRT, d	16.8	16.7	15.6	7.7	14.9	14.6	6.7	6.5
SRT, d	50	50	50	50	30	30	30	30
PAC, mg/l	1,500	—	500	—	2,000	—	2,000	—
Feed time, h	4	4	4	4	4	4	4	4
Aeration time, h	23	23	23	23	23	23	23	23
Settling time, h	1	1	1	1	1	1	1	1
SVI (ml/g)	19	157	32	74	65	75	19	74
F/M (COD basis)	0.11	0.3	0.19	0.19	0.21	0.60	0.51	0.68

**EXAMPLE 7.5.** Design a batch activated sludge plant for the following wastewater:

$$Q = 50,000 \text{ gal/d (190 m}^3\text{/d)}$$

$$\text{BOD}(S_0) = 500 \text{ mg/l}$$

$$\text{TKN} = 2 \text{ mg/l}$$

$$a = 0.6$$

$$a' = 0.55$$

$$b = 0.1 \text{ d}^{-1}$$

$$F/M = 0.1 \text{ d}^{-1}$$

$$S = 10 \text{ mg/l (soluble)}$$

The plant will be operated with 20-h aeration, 2-h sedimentation, and 2-h decant.

**Solution.**

The BOD removal will be

$$S_r Q = (500 - 10) \text{ mg/l} (8.34) \frac{\text{lb/million gal}}{\text{mg/l}} (0.05) \frac{\text{million gal}}{\text{d}} = 204 \text{ lb/d} \quad (93 \text{ kg/d})$$

At an  $F/M$  of  $0.1 \text{ d}^{-1}$ , the required MLVSS is

$$\begin{aligned} X_v V &= \frac{Q S_o}{F/M} = \frac{0.05 \times 500 \times 8.34}{0.1} \\ &= 2085 \text{ lb VSS} \quad (946 \text{ kg}) \end{aligned}$$

and at 85 percent volatile solids the MLSS is

$$\frac{2085}{0.85} = 2453 \text{ lb SS} \quad (1113 \text{ kg})$$

Assuming the sludge has an SVI of 100 ml/g, the sludge volume will be

$$\frac{100 \text{ ml}}{\text{g SS}} \times \frac{454 \text{ g}}{\text{lb}} \times 3.53 \times 10^{-5} \frac{\text{ft}^3}{\text{ml}} = 1.6 \text{ ft}^3/\text{lb}$$

and the volume required for the settled sludge is

$$2453 \text{ lb} \times 1.6 \text{ ft}^3/\text{lb} = 3925 \text{ ft}^3 \text{ or } 29,360 \text{ gal} \quad (111 \text{ m}^3)$$

If sludge is to be wasted twice per month, storage must be provided for accumulated sludge.

At an estimated degradable fraction of the VSS of 0.4, the daily accumulation of VSS is

$$\begin{aligned} \Delta X_v &= a S_r Q - b X_d X_v V \\ &= 0.6(204) - 0.1 \times 0.4 \times 2085 \\ &= 39 \text{ lb VSS/day} \quad (18 \text{ kg/d}) \end{aligned}$$

Storage for 15 d will be

$$\frac{39 \text{ lb VSS/d}}{0.85 \text{ VSS/SS}} \times 15 \text{ d} \times 1.6 \text{ ft}^3/\text{lb SS} = 1100 \text{ ft}^3 \text{ or } 8240 \text{ gal} \quad (31 \text{ m}^3)$$

The total volume of basin (excluding freeboard) will be  $50,000 + 29,360 + 8240 = 87,600 \text{ gal}$  ( $332 \text{ m}^3$ ). This will be a basin 35.25 ft (10.7 m) in diameter and 12 ft (3.7 m) deep. If 3 ft (0.9 m) is provided for freeboard, the operational basin dimensions will be 35.25 ft (10.7 m) in diameter by 15 ft (4.6 m) depth.

The oxygen requirements can be calculated:

$$\begin{aligned} \text{O}_2/\text{d} &= a' S_r Q + 1.4 b \times X_d X_v V \\ &= 0.55(204) + 1.4 \times 0.1 \times 0.4 \times 2085 \\ &= 229 \text{ lb/d or } 9.54 \text{ lb/h} \quad (4.3 \text{ kg/h}) \end{aligned}$$

The required power at 1.5 lb O<sub>2</sub>/(hp · h) is

$$\frac{9.54}{1.6} = 6.4 \text{ hp (use 7.5 hp)} \quad [0.91 \text{ kg}/(\text{kW} \cdot \text{h})]$$

This is equivalent to 86 hp/million gal (17 W/m<sup>3</sup>) of basin volume, which should provide adequate mixing. The nutrient requirement will be

$$\begin{aligned} N &= 0.123 \frac{X_d}{0.8} \Delta X_v + 0.07 \left( \frac{0.8 - X_d}{0.8} \right) \Delta X_v \\ &= 0.123 \times \frac{0.4 \times 39}{0.8} + 0.07 \times \frac{0.8 - 0.4}{0.8} \times 39 \\ &= 3.8 \text{ lb/d as N} \quad (1.7 \text{ kg/d}) \\ P &= 0.026 \times \frac{0.4 \times 39}{0.8} + 0.01 \times \frac{0.8 - 0.4}{0.8} \times 39 \\ &= 0.7 \text{ lb/d as P} \quad (0.32 \text{ kg/d}) \end{aligned}$$

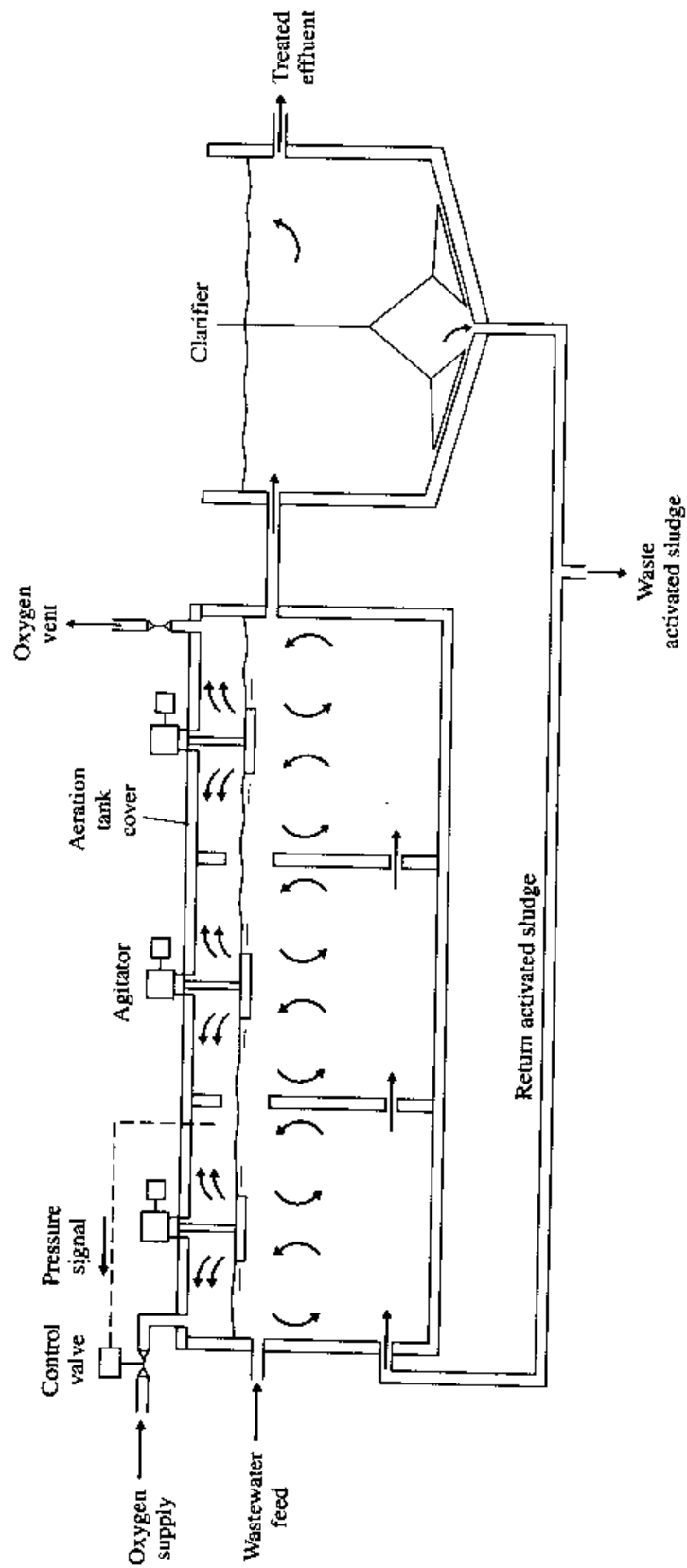
### Oxygen Activated Sludge

The high-purity oxygen system is a series of well-mixed reactors employing concurrent gas-liquid contact in a covered aeration tank, as shown in Fig. 7.25. The process has been used for the treatment of municipal, pulp and paper mill, and organic chemical wastewaters. Feed wastewater, recycle sludge, and oxygen gas are introduced into the first stage. Gas-liquid contacting can be done by submerged turbines or surface aeration.

Oxygen gas is automatically fed to either system on a pressure demand basis with the entire unit operating, in effect, as a respirator; a restricted exhaust line from the final stage vents the essentially odorless gas to the atmosphere. Normally the system will operate most economically with a vent gas composition of about 50 percent oxygen. For economic considerations, about 90 percent of oxygen utilization with on-site oxygen generation is desired. Oxygen may be generated by a traditional cryogenic air-separation process for large installations (75 million gal/d) ( $2.8 \times 10^5 \text{ m}^3/\text{d}$ ) or a pressure-swing adsorption (PSA) process for smaller installations. The power requirements for surface or turbine aeration equipment vary from 0.08 to 0.14 hp/thousand gal (0.028 kW/m<sup>3</sup>). At peak load conditions, the oxygen system is usually designed to maintain 6.0 mg/l dissolved oxygen in the mixed liquor.

Since high dissolved oxygen concentrations are maintained in the mixed liquor, the system can usually operate at high *F/M* levels (0.6 to 1.0) without filamentous bulking problems. The maintenance of an aerobic floc with high zone settling velocities also permits high MLSS concentrations in the aeration tank. Solids levels will usually range from 4000 to 9000 mg/l, depending on the BOD of the wastewater and design volume of the system.

Pure oxygen also is employed in open aeration basins in which oxygen under high pressure is mixed with the influent wastewater. When introduced into the aer-

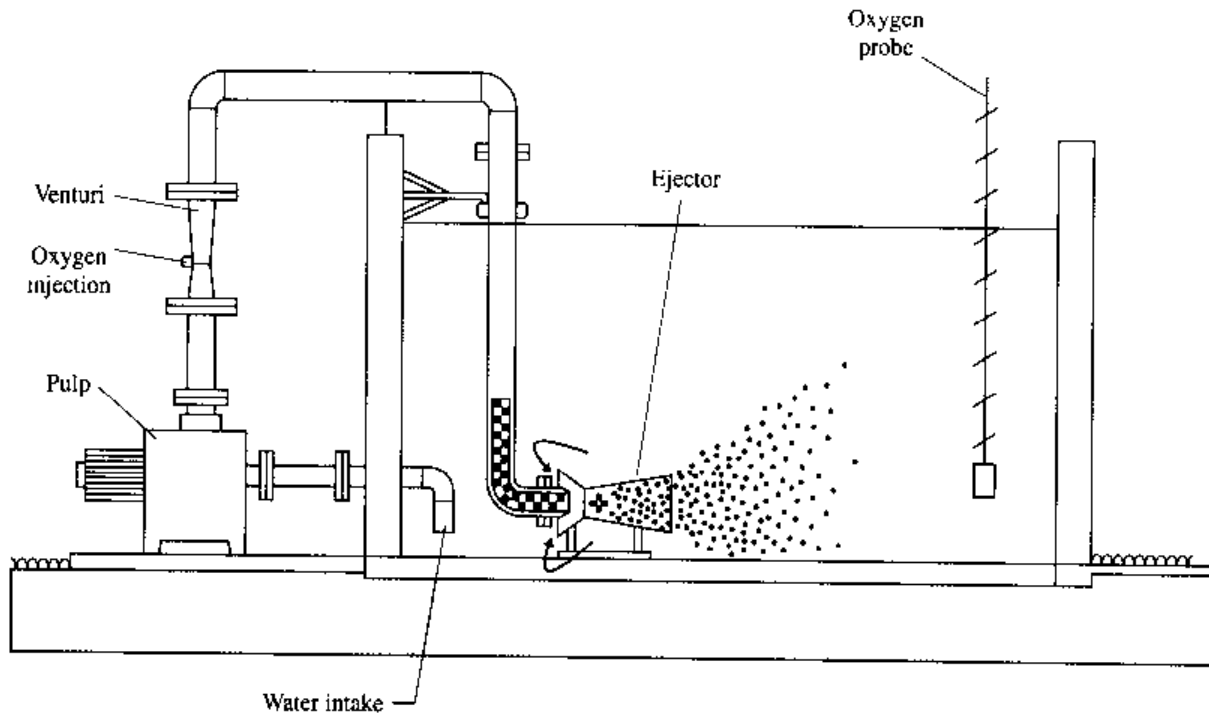


**FIGURE 7.25**  
Schematic diagram of three-stage oxygen system.

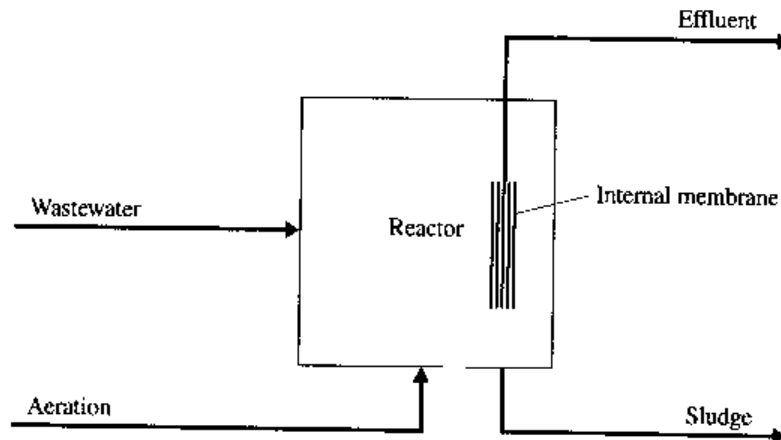
ation basin, the supersaturated gas comes out of solution in the form of microscopic bubbles. This process is shown in Fig. 7.26.

A membrane filtration unit, shown in Fig. 7.27, permits operation at high MLSS (10,000 to 40,000 mg/l) and is relatively independent of sludge quality. It also produces a high-quality effluent that can be readily disinfected and is frequently suitable for process recycle. This type of system with pure oxygen can have an exceptionally small footprint.

Yamamoto,<sup>16</sup> using hollow fiber membranes, used the following specifications: pore size of  $0.1 \mu$ , suction of 13k Pa (1.3 m of water head), and an organic loading



**FIGURE 7.26**  
OXY-DEP™ process for biological wastewater treatment using pure oxygen.



**FIGURE 7.27**  
Diagram of membrane biological reactor with ZeeWeed membranes.

of 3 to 4 kg COD/(m<sup>3</sup> · d) for nitrogen removal. Membrane clogging was inevitable to some extent but intermittent suction and low-pressure operation could prevent unrecoverable clogging without cleaning. Design data for an MBR process is shown in Table 7.7.

### Deep-Shaft Activated Sludge

The deep-shaft activated sludge process operates at an  $F/M$  of 1 to 2 d<sup>-1</sup> (BOD basis) using a mixing energy level of 800 to 1500 hp/million gal of aeration basin volume. The shaft depth varies from 150 to 400 ft. The operating mixed liquor dissolved oxygen concentration varies from 10 mg/l to 20 mg/l since the increasing shaft depth increases the saturation concentration. The MLSS levels vary from 8000 to 12,000 mg/l. Solids-liquid separation is provided by dissolved air flotation at high MLSS concentrations (greater than 10,000 mg/l) and by vacuum degasification and conventional gravity clarification at lower MLSS levels. A block flow diagram for the deep-shaft process is shown in Fig. 7.28. Performance data for a brewery wastewater is shown in Table 7.8.

### Biohoch Process

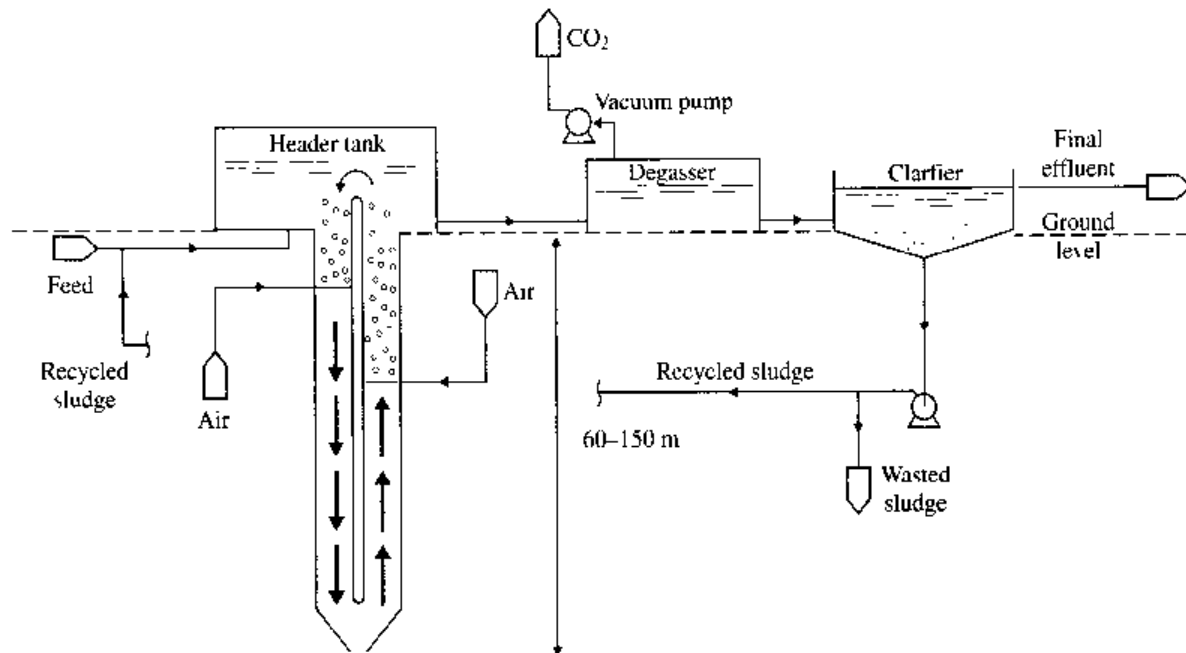
The Biohoch<sup>®</sup> reactor consists of an aeration section divided by a perforated plate into lower and upper zones and a cone-shaped final clarifier surrounding the aera-

TABLE 7.7  
GM Windsor full-scale MBR system design criteria<sup>17</sup>

Operating and Performance Criteria	Design Value
<b>Feed and Reactor Operating Conditions</b>	
Mean wastewater flow, m <sup>3</sup> /d	864
Mean feed COD, mg/l	6000
Reactor HRT, d	1.47
Reactor SRT, d	63
Reactor VSS, g/l	23.5
COD volumetric load, kg/m <sup>3</sup> d	4.1
TOG volumetric load, kg/m <sup>3</sup> d	0.80
Net solids yield coefficient, g VSS/g COD	0.11
<b>Performance Expectations</b>	
Effluent values, mg/l	
COD	≤700
TSS	≤10
TOG	≤45
THOG <sup>a</sup>	≤5
Membrane flux, l/m <sup>2</sup> h	51

<sup>a</sup>THOG represents total hydrocarbon oil and grease.





**FIGURE 7.28**  
Flowsheet for deep-shaft activated sludge process.

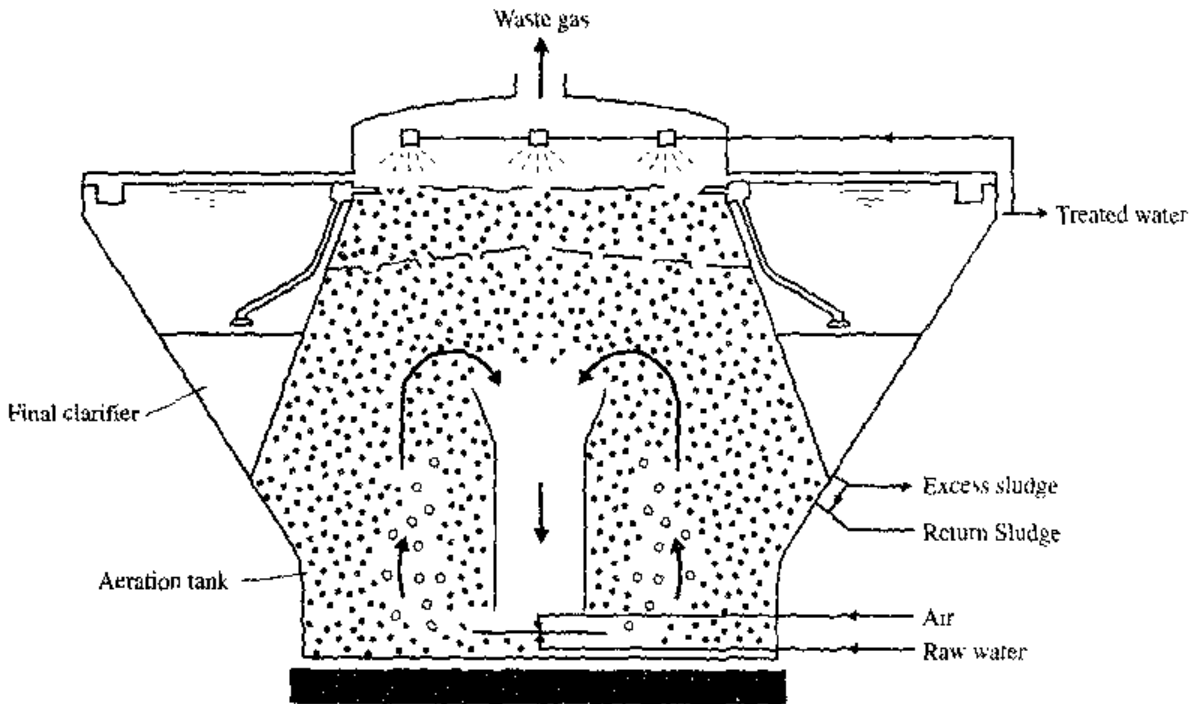
**TABLE 7.8**  
**Brewery wastewater treatment in the deep-shaft process<sup>18</sup>**

Parameter	Performance
Average flow	0.65 million gal/d
Average BOD <sub>5</sub>	2,400 mg/l
MLSS	12,000 mg/l
MLVSS	7,920 mg/l
<i>F/M</i>	1.51
Hydraulic detention time	0.2 d
Clarifier loading	618 gal/(d · ft <sup>2</sup> )
Recycle solids	4 percent
Effluent BOD <sub>5</sub>	78 mg/l
TSS	91 mg/l

tion section. The air is supplied to the reactor by means of radial flow jets installed at the reactor bottom.

The untreated wastewater is pumped into the reactor through the radial flow jets or through separate pipes. Turbulence in the lower zone is sufficient to provide completely mixed conditions. In the upper chamber, the stabilizing and degassing zone, bubbles adhering to the activated sludge are removed, since they impede sedimentation in the final clarifier. The depth of the aeration zone is approximately 65 ft.

The Biohoch reactor is illustrated in Fig. 7.29 and performance data for treatment of an organic chemicals wastewater are shown in Table 7.9.



**FIGURE 7.29**  
Flow scheme of a Biohoch reactor.

**TABLE 7.9**  
**Treatment of an organic chemicals  
wastewater in the Biohoch reactor**

Parameter	Value
Flow rate	0.63 million gal/d
Influent BOD	5,000 mg/l
Effluent BOD	40 mg/l
Influent COD	6,000 mg/l
Effluent COD	750 mg/l
<i>F/M</i> (BOD basis)	0.43 lb/(lb MLSS · d)
MLSS	3,500 mg/l
SRT	5.4 d
HRT	80 h
Temperature	95°F

### Integrated Fixed Film Activated Sludge (IFAS)

An innovation that has been implemented in recent years is the integration of fixed film media into activated sludge reactors to improve performance and in some cases to minimize expansion of existing facilities. In plants where nitrification and denitrification is practiced, nitrification is usually the rate-limiting step and the media is placed in the aerobic zone to enhance nitrification at low temperatures.

The most common media is Ringlace® ropelike media and small floating plastic sponges such as Captor® and Linpur®.

Randall<sup>19</sup> reviewed performance data of IFAS systems. In one case, using Ringlace nitrification was three times greater than the control reactor and denitrification was 2.5 times greater. The integration of media also decreased the SVI and the solids loading to the final clarifier. Floating sponges have been used in several ways. In one case the sponges were placed before the activated sludge zone. Sponges have also been used after the activated sludge aeration basin for enhanced nitrification. Randall added sponges to the activated sludge aeration basin and reduced the volume requirements for nitrification by 20 percent. Sponges may be used for refractory organics requiring long sludge ages as a second stage treatment.

### Thermophilic Aerobic Activated Sludge

Thermophilic aerobic activated sludge offers the advantages of rapid degradation rates and low sludge yield. The optimal temperature for thermophilic oxidation is 55 to 60°C, but common terminology generally includes any process operating at temperatures of 45°C or higher. The reaction rate has been reported to be 3 to 10 times greater than mesophilic operation and the endogenous rate 10 times greater, thereby greatly reducing the net sludge yield. A COD removal of 20,000 to 40,000 mg/l coupled with an oxygen transfer efficiency of 10 to 20 percent are necessary for autoheating to thermophilic temperatures. One disadvantage is that thermophilic bacteria fail to flocculate, making biomass separation in the effluent a problem.

### Final Clarification

The final clarifier is a key element in the activated sludge process, and failure to consider major design concepts will result in process upset. Activated sludge exhibits zone settling, which is discussed on p. 494. Batch settling of activated sludge can be characterized by the relationship:

$$V_z = V_o e^{-KX} \quad (7.14)$$

where  $V_z$  = zone settling velocity  
 $X$  = sludge concentration at  $V_z$   
 $V_o$  and  $K$  = empirical constants

The settling properties of activated sludge are commonly related to the sludge volume index (SVI). Daigger and Roper,<sup>20</sup> among others, showed that the zone settling velocity (Eq. 7.14) of municipal activated sludges could be related to SVI:

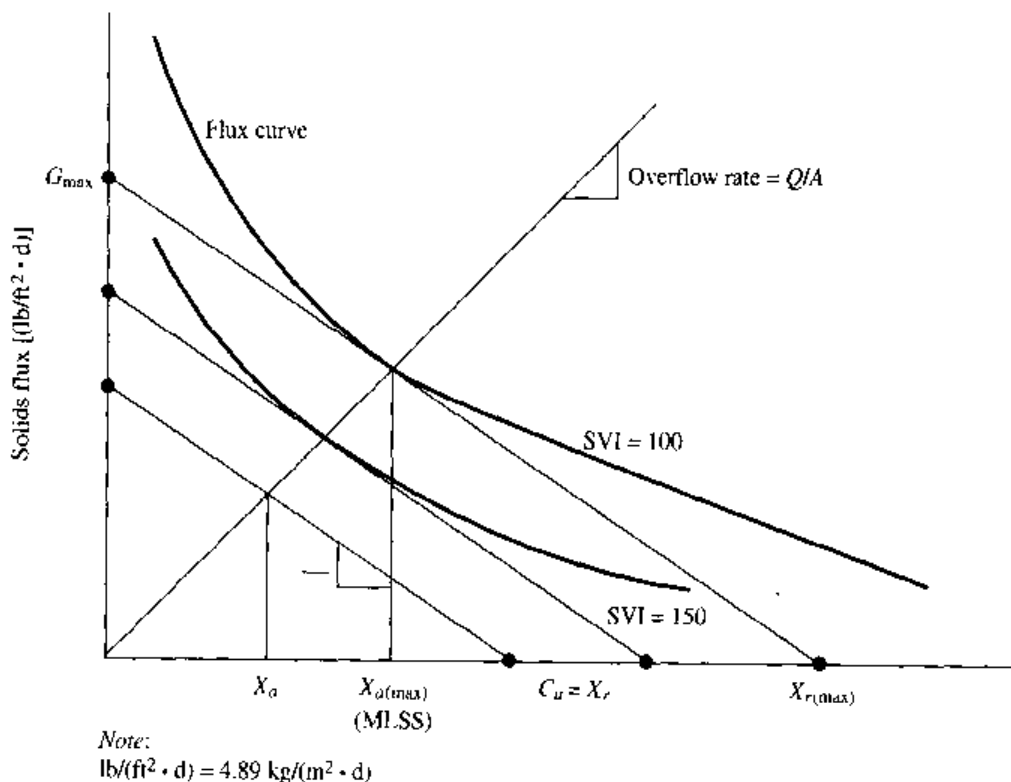
$$V_z = 7.80e^{-(0.148 + 0.0021SVI)X} \quad (7.14a)$$

In Eq. (7.14a),  $V_z$ ,  $X$ , and SVI are in meters per hour, grams per liter, and milliliters per gram, respectively. The clarifier functions primarily as a thickener in which the flux to the clarifier is related to the MLSS concentration, the influent flow rate, the underflow rate, the available clarifier surface area, and the sludge settling characteristics (see p. 494). Figure 7.30 illustrates these relationships.

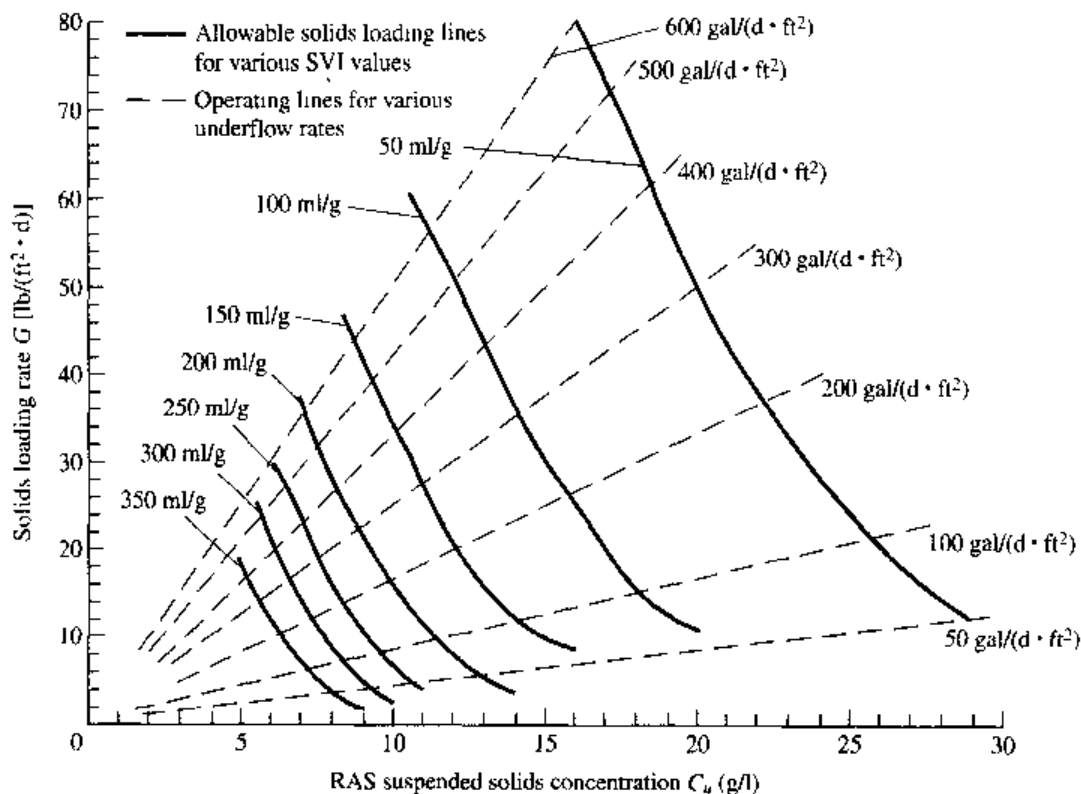
In Fig. 7.30 the overflow line has a slope equal to the overflow rate,  $Q/A$ . The underflow rate operating line has a slope equal to  $-R/A$ . The intersection of these two lines occurs at the mixed liquor suspended solids concentration  $X_u$ . The applied flux  $G_A$  (equal to the solids loading rate) is indicated where the underflow rate operating line intersects the solids flux axis. The return sludge concentration  $X_r$  is indicated where this line intersects the solids concentration axis.

The maximum flux  $G_{\max}$  that can be successfully transmitted to the bottom of the clarifier and out in the return sludge stream is determined by drawing the underflow rate operating line tangent to the settling flux curve. The maximum return sludge solids concentration that can be achieved,  $X_{r(\max)}$ , is indicated where this line intersects the solids concentration axis. When the underflow rate operating line is tangent to the settling flux curve, the system is said to be underloaded with respect to thickening. Operation below this limit is desired; prolonged operation above this limit will fill the clarifier with solids, which may result in a gross loss of solids in the effluent.

The amount of solids that can be processed through a clarifier is dictated by the sludge settling characteristics. This relationship is shown in Fig. 7.30; as the sludge settleability decreases (SVI rises from 100 to 150 ml/g), the maximum flux decreases ( $G_{\max 1} < G_{\max 2}$ ); the maximum return sludge solids concentration also decreases ( $X_{r(\max)1} < X_{r(\max)2}$ ). Repeating the calculation procedure for various underflow concentrations results in a series of clarifier underflow, i.e., recycle, concentrations with their corresponding maximum solids flux rates in which each represents a limiting design or operating condition. Figure 7.31 represents these calculations for a range of SVI sludges for municipal wastewater. Acceptable operating



**FIGURE 7.30**  
 Final clarifier relationships.



Note:

lb/(ft<sup>2</sup> · d) = 4.89 kg/(m<sup>2</sup> · d)

gal/(ft<sup>2</sup> · d) = 4.07 × 10<sup>-2</sup> m<sup>3</sup>/(m<sup>2</sup> · d)

**FIGURE 7.31**

Clarifier design and operation diagram (After Daigger and Roper<sup>17</sup>).

points on Fig. 7.31 are those which lie below the line for the particular SVI. The dashed lines or operating lines are derived from clarifier mass balances assuming effluent suspended solids and sludge wastage are small relative to the clarifier solids feed. The state point on a given operating line is defined by the solids flux  $G$  and the corresponding clarifier underflow or recycle solids concentration  $X_u$ . The clarifier will not be solids-limiting, provided the state point lies below the limiting solids flux line for the particular SVI. This is denoted as  $X_{u(max)}$  in Fig. 7.30. This analysis is illustrated by Example 7.6. A clarifier design procedure is shown in Example 7.7.

**EXAMPLE 7.6.** A final clarifier is operating under the following conditions:

Surface area  $A = 2000$  ft<sup>2</sup> (186 m<sup>2</sup>)

Influent flow  $Q = 1.2$  million gal/d (4540 m<sup>3</sup>/d)

Sludge recycle  $R = 0.6$  million gal/d (2270 m<sup>3</sup>/d)

Mixed liquor suspended solids  $X_u = 3000$  mg/l

Compute:

The overflow rate  $Q/A$

The underflow rate  $R/A$

The solids flux  $G$

The recycle suspended solids  $X_r$

The maximum SVI for clarifier operation

**Solution.**

The overflow rate is

$$\frac{1.2 \times 10^6}{2000} = 600 \text{ gal}/(\text{d} \cdot \text{ft}^2) \quad [24.4 \text{ m}^3/(\text{m}^2 \cdot \text{d})]$$

The underflow rate is

$$\frac{0.6 \times 10^6}{2000} = 300 \text{ gal}/(\text{d} \cdot \text{ft}^2) \quad [12.2 \text{ m}^3/(\text{m}^2 \cdot \text{d})]$$

The solids flux is

$$G = \frac{X_a(Q + R)}{A} = \frac{3000(1.2 + 0.6)8.34}{2000} = 22.5 \text{ lb}/(\text{ft}^2 \cdot \text{d}) \quad [110 \text{ kg}/(\text{m}^2 \cdot \text{d})]$$

The recycle suspended solids is

$$\frac{R}{Q} = \frac{X_a}{X_r - X_a}$$

or

$$X_r = \frac{X_a(1 + R/Q)}{R/Q} = \frac{3000(1 + 0.6/1.2)}{0.6/1.2} = 22.5 \text{ lb}/(\text{ft}^2 \cdot \text{d}) \quad [110 \text{ kg}/(\text{m}^2 \cdot \text{d})]$$

From Fig. 7.31, with a recycle suspended solids of 9000 mg/l and a solids flux of 22.5 lb/(ft<sup>2</sup> · d) [110 kg/(m<sup>2</sup> · d)], the maximum permissible SVI is 200 ml/g.

**EXAMPLE 7.7.** State point analysis. Given the following data from an activated sludge plant:

- Influent flow  $Q = 12$  million gal/d
- Number of clarifiers = 2
- Surface area of each,  $A = 9000$  ft<sup>2</sup>
- Raw activated sludge (RAS) flow from each,  $R = 3.5$  million gal/d
- MLSS concentration = 3 gal/l
- $V_o$  settling parameter = 564 ft/d
- $K$  settling parameter = 0.41/g

Compute (a) the overflow rate operating line and (b) the underflow operating line. (c) Construct the solids flux curve. (d) Find the maximum loading to the clarifier.

**Solution.**

- (a) The slope of the overflow rate operating line equals the surface overflow rate  $Q/A$ . The overflow rate is

$$\frac{Q}{A} = \frac{12 \text{ million gal/d}}{2 \times 9000} = 666 \text{ gal}/(\text{d} \cdot \text{ft}^2)$$

Converting  $Q/A$  to ft/d gives

$$\frac{666}{7.48} = 89 \text{ ft/d}$$

But the overflow rate in ft/d is equal to

$$\frac{16 \cdot G \text{ lb}/(\text{ft}^2 \cdot \text{d})}{\text{MLSS (g/l)}}$$

Therefore, for an MLSS of 3 g/l,  $G$  can be computed:

$$\frac{16 \cdot G}{3} = 89$$

$$G = 16.7 \text{ lb}/(\text{ft}^2 \cdot \text{d})$$

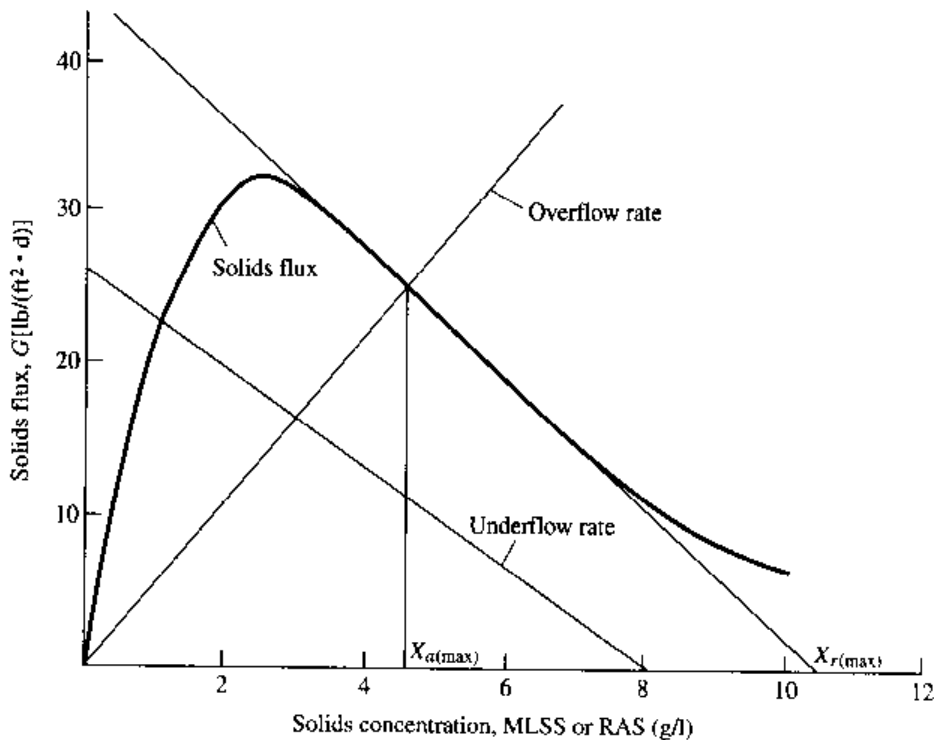
In Fig. 7.32, the overflow rate operating line is the line passing through the origin and the point defined by  $G = 16.7 \text{ lb}/\text{d}$ ,  $\text{MLSS} = 3 \text{ g/l}$ .

- (b) The slope of the underflow rate operating line equals the underflow rate. The underflow rate is

$$\frac{2R}{2A} = \frac{2 \times 3.5 \text{ million gal/d}}{2 \times 9000 \text{ ft}^2} = 389 \text{ gal}/(\text{d} \cdot \text{ft}^2)$$

Converting the underflow rate to ft/d gives

$$\frac{389}{7.48} = 52 \text{ ft/d}$$



**FIGURE 7.32**

Plot of overflow and underflow operating lines and solids flux curve.

The underflow rate in ft/d is equal to

$$\frac{16G \text{ (lb/d} \cdot \text{ft}^2\text{)}}{\text{RAS (g/l)}}$$

The flux  $G$  to the clarifier is

$$\begin{aligned} G &= \frac{(Q + R)X_a}{2A} \\ &= \frac{(12 + 7)3 \cdot 8.34 \cdot 10^3}{18,000} = 26.4 \text{ lb}/(\text{ft}^2 \cdot \text{d}) \end{aligned}$$

The RAS concentration is computed

$$\begin{aligned} \frac{16 \cdot 26.4 \text{ lb}/(\text{ft}^2 \cdot \text{d})}{\text{RAS(g/l)}} &= 52 \text{ ft/d} \\ \text{RAS} &= 8.1 \text{ g/l} \end{aligned}$$

The underflow rate operating line is now plotted on Fig. 7.32 as the line extending from 8.1 g/l on the RAS axis to 26.4 lb/(ft<sup>2</sup> · d) on the  $G$  axis.

- (c) The solids flux curve can be constructed by modifying Eq. (7.14)

$$V_r X = G = V_o X e^{-KX}$$

For  $V_o = 564$  ft/d and  $K = 0.4$  l/g, the solids flux curve is plotted on Fig. 7.32.

- (d) The maximum loading to the clarifier is obtained by drawing a tangent to the inflection point of the solids flux curve as shown in Fig. 7.32. This yields a flux of 44 lb/(ft<sup>2</sup> · d) with an underflow RAS of 10.4 g/l. The MLSS as shown in Fig. 7.32 is 4500 mg/l. The underflow rate is increased from 389 gal/(d · ft<sup>2</sup>) to 563 gal/(d · ft<sup>2</sup>).

## Flocculation and Hydraulic Problems

Wahlberg et al.<sup>21</sup> devised a series of tests, called the dispersed suspended solids (DSS) and flocculated suspended solids (FSS) tests, to differentiate between flocculation and hydraulic problems in secondary clarifiers. DSS is operationally defined as the supernatant suspended solids concentration after 30 minutes of settling in a Kemmerer sampler. The use of a Kemmerer sampler allows the sample to be collected and settled in the same container, thereby sparing the biological flocs any unquantifiable aggregation or breakup effects during an intermediate transfer step.

FSS is operationally defined as the supernatant suspended solids concentration after 30 minutes of flocculation and 30 minutes of settling. The FSS concentration is particularly useful because it is a measure of the effluent TSS concentration that would be possible if the mixed liquor entering a secondary clarifier is optimally flocculated and the flow characteristics in the clarifier are ideal. Differences between the FSS concentration and the effluent TSS concentration reflect any inefficiencies caused by poor flocculation or poor hydraulics. Most activated sludges will produce an effluent less than 10 mg/l in TSS if properly flocculated and ideally settled.

The existence of density currents in secondary clarifiers is well known. These currents result from the underwater waterfall that results when the solids-laden



mixed liquor enters the relatively solids free secondary clarifier. High velocity jets also can occur as a result of improperly designed secondary clarifier inlets that fail to dissipate the kinetic energy of the influent flow. Poor secondary clarifier designs resulting in chronic hydraulic problems have plagued the wastewater treatment industry. Hydrodynamic models are being used successfully to identify hydraulic problems and to design modifications to correct them. Increasingly, these models are being used to design new secondary clarifiers as well.

### **Treatment of Industrial Wastewaters in Municipal Activated Sludge Plants**

Municipal wastewater is unique in that a major portion of the organics are present in suspended or colloidal form. Typically, the BOD in municipal sewage will be 50 percent suspended, 10 percent colloidal, and 40 percent soluble. By contrast, most industrial wastewaters are almost 100 percent soluble. In an activated sludge plant treating municipal wastewater, the suspended organics are rapidly enmeshed in the flocs, the colloids are adsorbed on the flocs, and a portion of the soluble organics are adsorbed. These reactions occur in the first few minutes of aeration contact. By contrast, for readily degradable wastewaters, i.e., food processing, a portion of the BOD is rapidly sorbed and the remainder removed as a function of time and biological solids concentration. Very little sorption occurs in refractory wastewaters. These phenomena are shown in Fig. 7.15. The kinetics of the activated sludge process will therefore vary, depending on the percentage and type of industrial wastewater discharged to the municipal plant, and must be considered in the design calculations.

The percentage of biological solids in the aeration basin will also vary with the amount and nature of the industrial wastewater. For example, municipal wastewater without primary clarification will yield a sludge that is 47 percent biomass at a 3-d sludge age. Primary clarification will increase the biomass percentage to 53 percent. Increasing the sludge age will also increase the biomass percentage as volatile suspended solids undergo degradation and synthesis. Soluble industrial wastewater will increase the biomass percentage in the activated sludge.

As a result of these considerations, there are a number of phenomena that must be considered when industrial wastewaters are discharged to municipal plants:

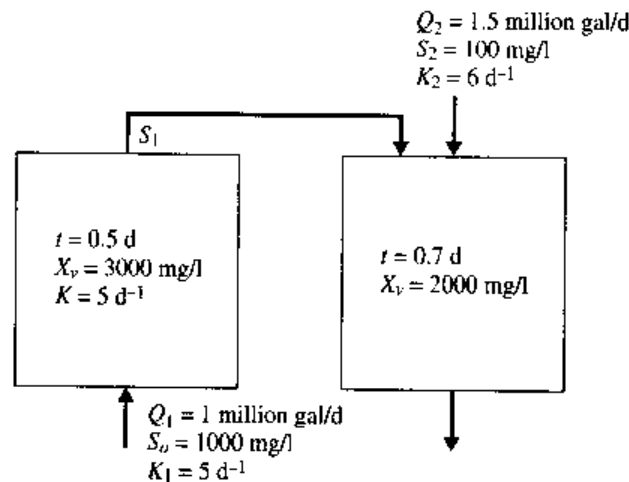
1. *Effect on effluent quality.* Soluble industrial wastewaters will affect the reaction rate  $K$ , as shown in Table 6.5. Refractory wastewaters such as tannery and chemical will reduce  $K$ , while readily degradable wastewaters such as food processing and brewery will increase  $K$ .
2. *Effect on sludge quality.* Readily degradable wastewaters will stimulate filamentous bulking, depending on basin configuration, while refractory wastewaters will suppress filamentous bulking.
3. *Effect of temperature.* An increased industrial wastewater input, i.e., soluble organics, will increase the temperature coefficient  $\theta$ , thereby decreasing efficiency at reduced operating temperatures.
4. *Sludge handling.* An increase in soluble organics will increase the percentage of biological sludge in the waste sludge mixture. This generally will decrease

dewaterability, decrease cake solids, and increase conditioning chemical requirements. An exception is pulp and paper mill wastewaters, in which pulp and fiber serves as a sludge conditioner and will enhance dewatering rates.

It should be noted that most industrial wastewaters are nutrient deficient; i.e., they lack nitrogen and phosphorus. Municipal wastewater, with a surplus of these nutrients, will provide the required nutrient balance. However, wastewaters from industries such as poultry processing can be very high in both nitrogen and phosphorus relative to organic matter, and substantially increase the costs of nutrient removal at municipal plants.

Pretreatment of an industrial wastewater in a municipal plant is shown in Example 7.8.

**EXAMPLE 7.8.** A wastewater is to be pretreated in an activated sludge process and then blended with a domestic wastewater for final treatment in a second activated sludge basin as shown below:



**Solution.**

The effluent SBOD from the first aeration basin is, from Eq. (6.24),

$$\begin{aligned} (S_e)_1 &= \frac{1000^2}{1000 + (5)(3000)(0.5)} \\ &= 118 \text{ mg/l} \end{aligned}$$

The reaction rate  $K_2$  of the pretreated industrial wastewater in the second basin is, from Eq. (6.29),

$$K_2 = 5 \left( \frac{118}{1000} \right) = 0.59 \text{ d}^{-1}$$

The influent concentration to the second basin is

$$\begin{aligned} (S_o)_2 &= \frac{(118)(1.0) + (100)(1.5)}{(1.0 + 1.5)} \\ &= 107 \text{ mg/l} \end{aligned}$$

The average rate coefficient,  $\bar{K}$ , after blending the two wastewaters is, from Eq. (6.28),

$$\frac{1}{\bar{K}} = \frac{\frac{1}{0.59}(118)(1.0) + \frac{1}{6}(100)(1.5)}{(118)(1.0) + (100)(1.5)}$$

$$\bar{K} = 1.2 \text{ d}^{-1}$$

The SBOD from the second basin will be

$$\begin{aligned} (S_e)_2 &= \frac{107^2}{107 + (1.2)(2000)(0.7)} \\ &= 6.5 \text{ mg/l} \end{aligned}$$

### Effluent Suspended Solids Control

Carryover of suspended solids in the secondary clarifier effluent can have several causes:

- Floc shear due to high aeration basin power levels
- Poor clarifier hydraulics
- High wastewater TDS concentration
- Low or high mixed liquor temperature
- Rapid change in mixed liquor temperature
- Low mixed liquor surface tension

High mixed liquor turbulence levels created by turbine-type or mechanical surface aerators can cause floc breakup that results in high-effluent suspended solids. This problem can frequently be solved by reducing the aeration basin power level and/or by installing a flocculation zone between the aeration basin and the final clarifier. Results of flocculation of mixed liquor from an activated sludge plant treating a pulp and paper mill wastewater at two aeration basin power levels are shown in Table 7.10. These data indicate that flocculation times of 1 to 3 min were

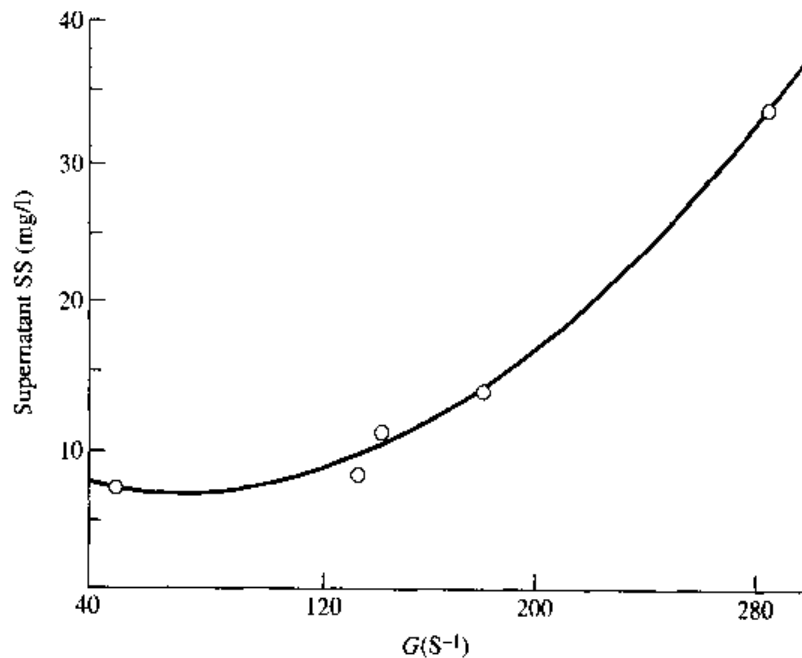
TABLE 7.10  
Floc shear test results for pulp and paper mill wastewaters

Flocculation time, min	Settled TSS, <sup>†</sup> mg/l at	
	690 hp/million gal	360 hp/million gal
0	81	64
1	30	28
3	28	22
5	26	19
7	27	21

<sup>†</sup> Supernatant TSS following flocculation and 15-min settling period.

effective at reducing the settled effluent TSS concentration. The effect of turbulence on effluent suspended solids when fine bubble diffusers are used is shown in Fig. 7.33.

High-effluent suspended solids levels will frequently result from a poor clarifier hydraulic design that causes density currents and/or short-circuiting. These conditions result in an upwelling of floc solids at the clarifier peripheral weir. This problem can be minimized by installing a Stamford baffle, which redirects the upflow of solids away from the effluent weir. A Stamford baffle and its performance are illustrated by Fig. 7.34.



$G$  is defined as the mean velocity gradient, which is a measure of the mixing intensity. For example what is  $G$  for an air flow of 20 scfm/1,000 ft<sup>3</sup> in an aeration basin of 0.5 mg, a 26 ft SWD at 20°C

$$G = \sqrt{\frac{Qa\gamma h}{V\mu}}$$

in which  $Qa$  = air flow, m<sup>3</sup>/sec

$\gamma$  = liquid specific weight, N/m<sup>3</sup>

$h$  = liquid depth, m

$V$  = aeration basin volume, m<sup>3</sup>

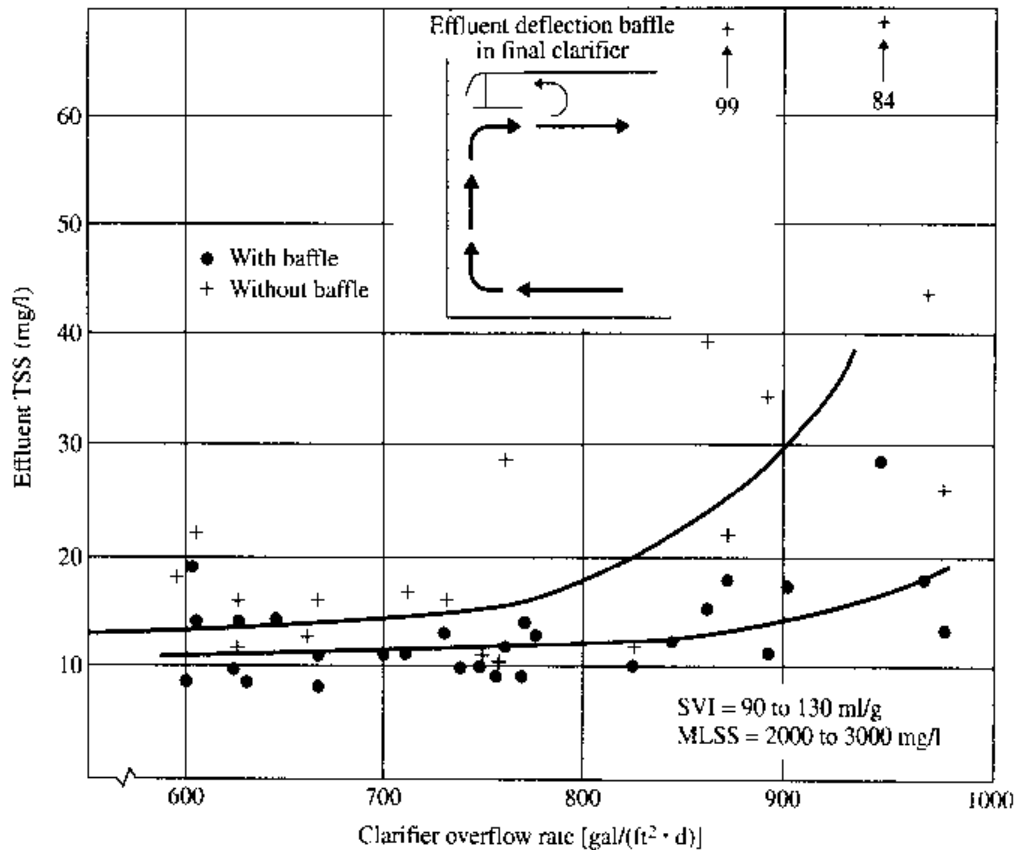
$\mu$  = absolute viscosity, N sec/m<sup>2</sup>

$$G = \sqrt{\frac{0.63 \text{ m}^3/\text{sec} \cdot 9,790 \text{ N/m}^3 \cdot 7.47 \text{ m}}{1,894 \text{ m}^3 \cdot 1.003 \times 10^{-3} \frac{\text{N} \cdot \text{sec}}{\text{m}^2}}}$$

$$= 155 \text{ sec}^{-1}$$

**FIGURE 7.33**

The effect of  $G$  on effluent SS concentration for fine-bubble aerated plants.<sup>22</sup>

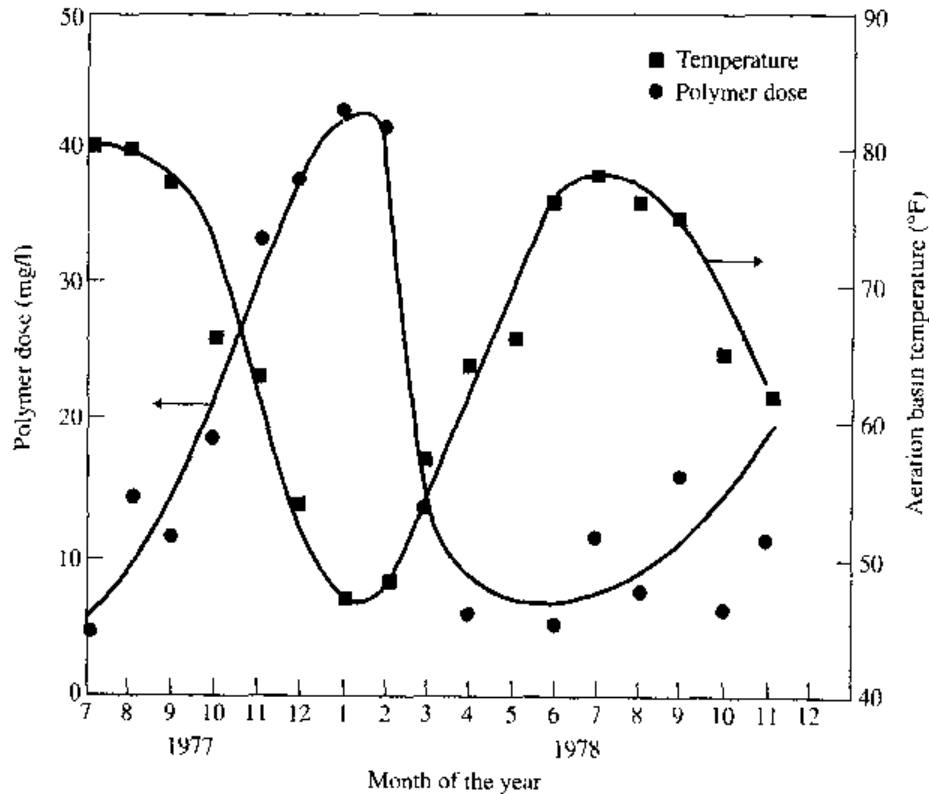


**FIGURE 7.34**

Effect of Stamford baffle on clarifier effluent TSS concentration.

In the case of industrial wastewaters, however, high effluent suspended solids of a dispersed character can result from one of several causes:

1. High total dissolved salt (TDS) may cause an increase in nonsettleable suspended solids. While the specific cause of floc dispersion has not been defined, increasing the TDS has generally resulted in an increase in nonsettleable, dispersed solids. High TDS will also increase the specific gravity of the liquid, thereby reducing the settling rate of the biological sludge. The salt content appears to have little effect on the kinetics of the process under acclimated conditions.
2. Dispersed suspended solids increase as the aeration basin temperature decreases. For example, an aerated sludge plant in West Virginia treating an organic chemicals wastewater had an effluent suspended solids concentration of 42 mg/l during summer operation and 104 mg/l during winter operation. The change in coagulant dosage with respect to temperature at a Tennessee organic chemicals plant is shown in Fig. 7.35.
3. Dispersed suspended solids increase with a decrease in surface tension. At one deinking mill the effluent suspended solids was directly related to the surfactant usage in the mill.
4. The nature of the organic content may increase the effluent suspended solids. While this effect is ill-defined, some plants will consistently generate high effluent suspended solids.



**FIGURE 7.35**  
Polymer addition for effluent suspended solids control.<sup>23</sup>

The effluent suspended solids can be reduced by the addition of a coagulant prior to the final clarifier. It is important that there be sufficient time for flocculation to occur. This can be achieved by a flocculation chamber between the aeration basin and the clarifier or by a flocculation well within the clarifier, as shown in Fig. 7.36.

Cationic polyelectrolytes, or alum or iron salts, may be used as a coagulant. Choice of coagulant depends on a test program to select the most economical solution. Data reported by Paduska<sup>23</sup> for a cationic polyelectrolyte are shown in Fig. 7.35. It is important when using a cationic polymer to avoid overdosing, which will cause a charge reversal and a redispersion of the solids. The temperature effect as previously noted is also shown in Fig. 7.35. An activated sludge design is illustrated by Example 7.9.

**EXAMPLE 7.9.** Given the following data:

$$Q = 4 \text{ million gal/d (15,140 m}^3\text{/d)}$$

$$S_o = 610 \text{ mg/l}$$

$$S_e = 40 \text{ mg/l}$$

$$SS_{em} = 40 \text{ mg/l}$$

$$\text{mg BOD/mg SS} = 0.3$$

$$K = 3.0 \text{ d}^{-1} \text{ at } 20^\circ\text{C}$$

$$b = 0.1 \text{ d}^{-1} \text{ at } 20^\circ\text{C}$$

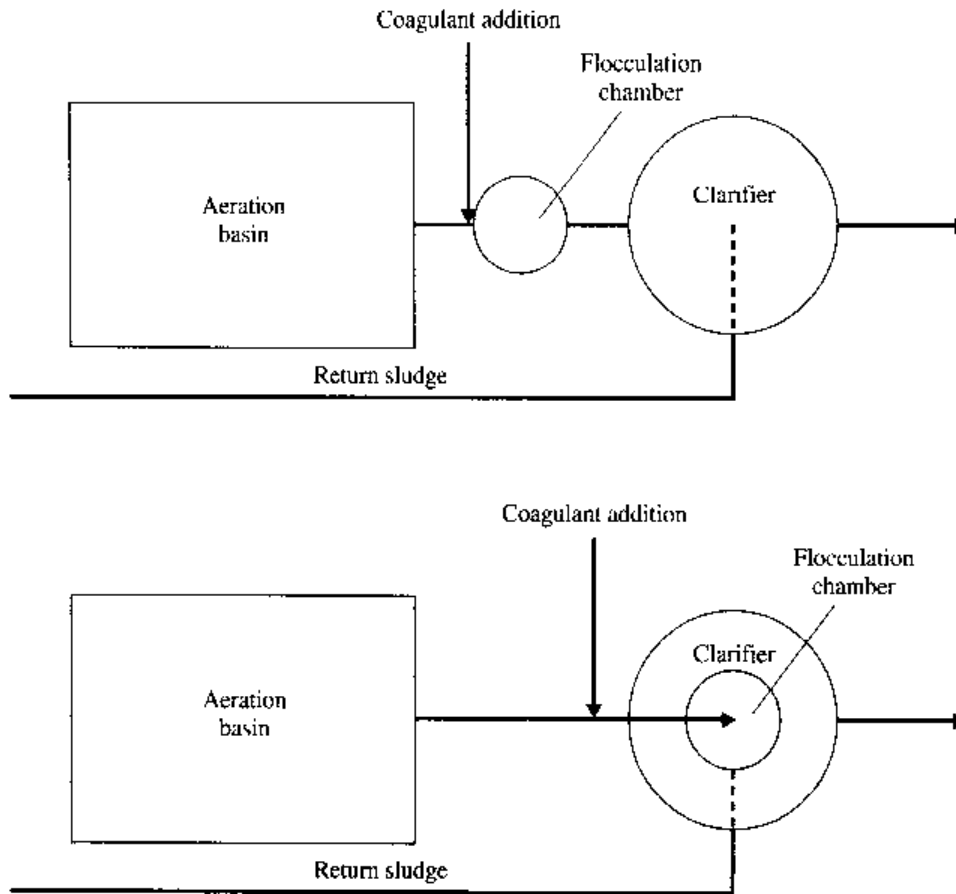
$$X_v = 3000 \text{ mg/l}$$

$$a = 0.55$$

$$a' = 0.50$$

$$\theta_b = 1.04$$

$$\theta_K = 1.065$$



**FIGURE 7.36**  
Coagulant addition for suspended solids control.

Compute:

- The sludge age and  $F/M$  to meet this effluent quality
- The N and P requirements at 20°C
- The MLVSS at 10°C to meet the same effluent quality
- The excess sludge at 10°C
- The oxygen requirements at 30°C

**Solution.**

- Food to microorganisms ratio  $F/M$  and sludge age  $\theta_c$ :

$F/M$ : The effluent soluble BOD is

$$S = S_e - 0.3SS_{\text{eff}} = 40 - 0.3 \times 40 = 28 \text{ mg/l}$$

The detention time is obtained by rearranging Eq. (6.24):

$$t = \frac{(S_o - S)S_o}{KX_v S} = \frac{(610 - 28) \text{ mg/l} \times 610 \text{ mg/l}}{3.0/\text{d} \times 3000 \text{ mg/l} \times 28 \text{ mg/l}}$$

$$= 1.41 \text{ d}$$

$$F/M = \frac{S_o}{(X_v t)} = \frac{610 \text{ mg/l}}{3000 \text{ mg/l} \times 1.41 \text{ d}} = 0.144/\text{d}$$

Sludge age: The BOD removed is

$$S_r = S_o - S = 610 - 28 = 582 \text{ mg/l}$$

The degradable fraction is given by

$$\begin{aligned} (*)X_d &= \frac{aS_r + bX_v t - [(aS_r + bX_v t)^2 - (4bX_v t)(0.8aS_r)]^{1/2}}{2bX_v t} \\ &= 0.47 \end{aligned}$$

The sludge age can be calculated from Eq. (6.11).

$$\begin{aligned} \theta &= \frac{X_v t}{aS_r - bX_d X_v t} \\ &= \frac{3000 \text{ mg/l} \times 1.41 \text{ d}}{0.55 \times 582 \text{ mg/l} - 0.1/\text{d} \times 0.47 \times 3000 \text{ mg/l} \times 1.41 \text{ d}} \\ &= 34.9 \text{ d} \approx 35 \text{ d} \end{aligned}$$

Note that  $\theta_c$  could have been calculated first using the following equation [obtained by combining Eqs. (6.5) and (6.11)]:

$$\theta_c = \frac{-(aS_r - bX_v t) + [(aS_r - bX_v t)^2 + 4(abX'_n S_r)(X_v t)]^{1/2}}{2abX'_n S_r}$$

with  $X'_n = 0.2$ , this equation gives  $\theta_c = 35 \text{ d}$ ; then  $X_d$  can be computed from Eq. (6.5):

$$\begin{aligned} X_d &= \frac{X'_d}{(1 + bX'_n \theta_c)} \\ &= \frac{0.8}{1 + 0.1 \times 0.2 \times 35} = 0.47 \end{aligned}$$

(b) Nitrogen N and phosphorus P requirements:

The excess volatile sludge produced at 20°C is computed from Eq. (6.10):

$$\begin{aligned} \Delta X_{v,20} &= (aS_r - bX_d X_v t)Q \\ &= (0.55 \times 582 \text{ mg/l} - 0.1/\text{d} \times 0.47 \times 3000 \text{ mg/l} \\ &\quad \times 1.41 \text{ d}) (4 \text{ million gal/d}) \times [8.34 \text{ (lb/million gal)/(mg/l)}] \\ &= 4046 \text{ lb/d} \quad (1837 \text{ kg/d}) \end{aligned}$$

The nitrogen and phosphorus requirements are given by Eqs. (6.19) and (6.20), therefore

$$\begin{aligned} N &= 0.123 \left( \frac{X_d}{0.8} \right) \Delta X_v + 0.07 \left( \frac{0.8 - X_d}{0.8} \right) \Delta X_v \\ &= \left[ 0.123 \left( \frac{0.47}{0.8} \right) + 0.07 \left( \frac{0.8 - 0.47}{0.8} \right) \right] (4046) \text{ lb/d} \\ &= 409 \text{ lb/d} \quad (186 \text{ kg/d}) \end{aligned}$$



$$\begin{aligned}
 P &= 0.026 \left( \frac{X_d}{0.8} \right) \Delta X_v + 0.01 \left( \frac{0.8 - X_d}{0.8} \right) \Delta X_v \\
 &= \left[ 0.026 \left( \frac{0.47}{0.8} \right) + 0.01 \left( \frac{0.8 - 0.47}{0.8} \right) \right] (4046) \text{ lb/d} \\
 &= 79 \text{ lb/d} \quad (36 \text{ kg/d})
 \end{aligned}$$

(c) Mixed liquor volatile suspended solids at 10°C,  $X_{v10}$ :  
The kinetic coefficients at 10°C are computed:

$$\begin{aligned}
 K_{10^\circ\text{C}} &= K_{20^\circ\text{C}} \theta_K^{10-20} = 3.0/\text{d} \times 1.065^{-10} \\
 &= 1.6/\text{d} \\
 b_{10^\circ\text{C}} &= b_{20^\circ\text{C}} \theta_b^{10-20} = 0.1/\text{d} \times 1.04^{-10} \\
 &= 0.068/\text{d}
 \end{aligned}$$

From Eq. (6.26), rearranged,

$$\begin{aligned}
 X_{v10} &= \frac{S_r S_o}{K_{10^\circ\text{C}} S t} = \frac{582 \text{ mg/l} \times 610 \text{ mg/l}}{1.6/\text{d} \times 28 \text{ mg/l} \times 1.41 \text{ d}} \\
 &= 5624 \text{ mg/l}
 \end{aligned}$$

(d) Excess sludge at 10°C,  $\Delta X_{v10}$ :

With the new values of  $K$ ,  $b$ , and  $X_v$  in Eq. (6.12), the degradable fraction at 10°C is

$$X_{d10} = 0.40$$

The excess sludge is computed from Eq. (6.10):

$$\begin{aligned}
 \Delta X_{v10} &= (0.55 \times 582 - 0.068 \times 0.40 \times 5624 \times 1.41) \times (4)(8.34) \text{ lb/d} \\
 &= 3483 \text{ lb/d} \quad (1581 \text{ kg/d})
 \end{aligned}$$

(e) Oxygen requirements at 30°C,  $R_{30}$

The kinetic coefficients at 30°C are

$$\begin{aligned}
 K_{30^\circ\text{C}} &= 3.0/\text{d} \times 1.065^{30-20} \\
 &= 5.6/\text{d} \\
 b_{30^\circ\text{C}} &= 0.1/\text{d} \times 1.04^{10} \\
 &= 0.15/\text{d}
 \end{aligned}$$

Then

$$\begin{aligned}
 X_{v30} &= \frac{582 \times 610}{5.63 \times 28 \times 1.41} \\
 &= 1597 \text{ mg/l}
 \end{aligned}$$

and

$$X_{d30} = 0.54$$

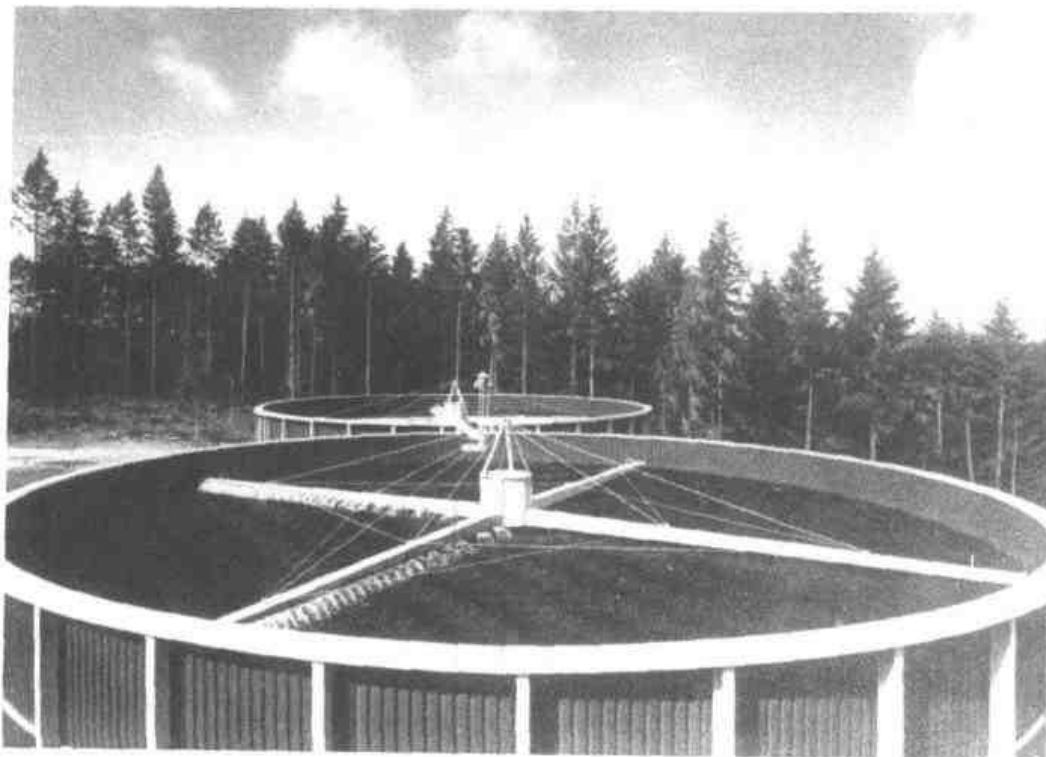
$$\begin{aligned} R_{30} &= (a'S_r + 1.4b_{30^\circ\text{C}} X_{d30}X_{v30}t)Q \\ &= (0.50 \times 582 \text{ mg/l} + 1.4 \times 0.15/\text{d} \times 0.54 \times 1597 \text{ mg/l} \\ &\quad \times 1.41 \text{ d})(4 \text{ million gal/d})[8.34(\text{lb/million gal})/(\text{mg/l})] \\ &= 18,226 \text{ lb/d} \quad (8275 \text{ kg/d}) \end{aligned}$$

## 7.4

### TRICKLING FILTRATION

A trickling filter is a packed bed of media covered with slime growth over which wastewater is passed. As the waste passes through the filter, organic matter present in the waste is removed by the biological film.

Plastic packings are employed in depths up to 40 ft (12.2 m), with hydraulic loadings as high as 4.0 gal/(min · ft<sup>2</sup>) [0.16 m<sup>3</sup>/(min · m<sup>2</sup>)]. Depending on the hydraulic loading and depth of the filter, BOD removal efficiencies as high as 90 percent have been attained on some wastewaters. In one industrial plant, a minimum hydraulic loading of 0.5 gal/(min · ft<sup>2</sup>) [0.02 m<sup>3</sup>/(min · m<sup>2</sup>)] was required in order to avoid the generation of filter flies (psychoda). Figure 7.37 shows an installation of a plastic-packed filter.



**FIGURE 7.37**  
Plastic-packed trickling filter.

## Theory

As wastewater passes through the filter, nutrients and oxygen diffuse into the slimes, where assimilation occurs, and by-products and  $\text{CO}_2$  diffuse out of the slime into the flowing liquid. As oxygen diffuses into the biological film, it is consumed by microbial respiration, so that a defined depth of aerobic activity is developed. Slime below this depth is anaerobic, as shown in Fig. 7.38.

As in BOD removal by activated sludge, BOD removal through a trickling filter is related to the available biological slime surface and to the time of contact of wastewater with that surface.

The mean time of contact of liquid with the filter surface is related to the filter depth, the hydraulic loading, and the nature of the filter packing:

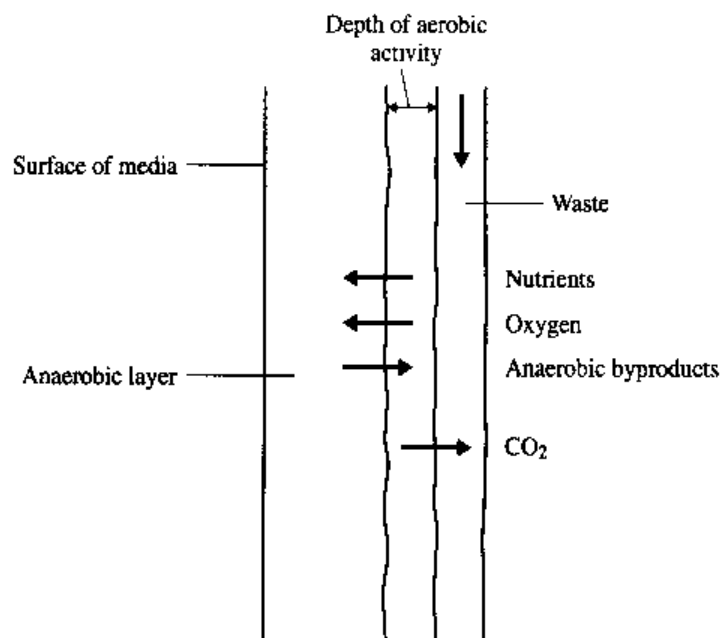
$$t = \frac{CD}{Q^n} \quad (7.15)$$

where

- $t$  = mean detention time
- $D$  = filter depth, ft
- $Q$  = hydraulic loading, gpm/ft<sup>2</sup>
- $C$  and  $n$  = constants related to the specific surface and the configuration of the packing

There are a number of commercial packings available. These include vertical-flow, random-packed, and cross-flow media. The properties of these media are summarized in Table 7.11. Investigations of several types of packings showed that

$$C = C' A_s^m \quad (7.16)$$



**FIGURE 7.38**  
Mode of operation of a trickling filter.

TABLE 7.11  
Comparative physical properties of common trickling filter media

Medium type	Nominal size, in	Unit weight, lb/ft <sup>3</sup>	Specific surface area, ft <sup>2</sup> /ft <sup>3</sup>	Void space, %	Application
Bundle	24 × 24 × 48	2–5	27–32	>95	C, CN, N
(sheet)	24 × 24 × 48	4–6	42–45	>94	N
Rock	1–3	90	19	50	N
Rock	2–4	100	14	60	C, CN, N
Random	Varies	2–4	25–35	>95	C, CN, N
(Dump)	Varies	3–5	42–50	>94	N
Wood	48 × 48 × 1 $\frac{1}{8}$	10.3	14		C, CN

C = CBOD<sub>5R</sub>

1 in = 25.4 mm

CN = CBOD<sub>5R</sub> and NOD<sub>R</sub>

1 lb/ft<sup>3</sup> = 16.05 kg/m<sup>3</sup>

N = tertiary NOD<sub>R</sub>

1 ft<sup>2</sup>/ft<sup>3</sup> = 0.305 m<sup>2</sup>/m<sup>3</sup>

in which  $A_v$  is the specific surface expressed in square feet per cubic foot (*note*: ft<sup>2</sup>/ft<sup>3</sup> = 3.28 m<sup>2</sup>/m<sup>3</sup>). For spheres, rock, and Polygrid plastic media without slime,  $C'$  has a value of 0.7 and  $m$  a value of 0.75. This relationship will vary for others that have a different general configuration.

The exponent  $n$  in Eq. (7.15) has been observed to decrease with decreasing specific surface  $A_v$ . Equations (7.15) and (7.16) can be combined to yield a general expression for the mean retention time through any type of filter packing:

$$\frac{t}{D} = \frac{C'A_v^m}{Q^n} \quad (7.17)$$

The mean retention time increases considerably in the presence of filter slime, in some cases being as much as 4 times that prevailing with the nonslimed surface.

In order to avoid filter plugging, a maximum specific surface of 30 ft<sup>2</sup>/ft<sup>3</sup> (98 m<sup>2</sup>/m<sup>3</sup>) is recommended for the treatment of carbonaceous wastewaters. Specific surfaces in excess of 100 ft<sup>2</sup>/ft<sup>3</sup> (328 m<sup>2</sup>/m<sup>3</sup>) can be used for nitrification because of the low yield of biological cellular material.

Recent data have shown improved performance with cross-flow media with the same specific surface as other media because of the increased time of contact of the wastewater passing through the filter.

In Chap. 6 it is shown that soluble BOD removal in the plug flow activated sludge process could be expected to follow the relationship

$$\frac{S}{S_o} = e^{-K_d X_d / S_o}$$

These equations may be analogously applied to trickling filters under the following conditions:

1. The specific surface must remain constant. This is true for any specific filter medium but varies from medium to medium.

- The medium must have a uniform, thin slime cover. This does not always occur, particularly in the case of rock filters. It is essential therefore, that the entire surface be wetted. A minimum hydraulic loading of 0.50 gal/(min · ft<sup>2</sup>) is recommended.

The second condition also requires uniform distribution of the hydraulic loading to the filter. Albertson<sup>24</sup> has shown the dosing cycle should be optimized to ensure media wetting and flushing of excessive slime growth. Albertson and Eckenfelder<sup>25</sup> have shown that, with adequate hydraulic loading for media wetting, the BOD removal efficiency is independent of depth and that the value of  $K$  is depth-dependent as follows:

$$K_2 = K_1 \left( \frac{D_1}{D_2} \right)^{0.5} \quad (7.18)$$

This condition is violated when heavy slime buildup short-circuits the filter.

For the retention time as defined by Eq. (7.15) and assuming that the available bacterial surface to be proportional to the specific surface  $A_v$ ,

$$\frac{S}{S_o} = e^{-KA_v D/Q^* S_o} \quad (7.19)$$

In Eq. (7.18) the hydraulic loading of  $q$  includes both the forward flow and the recirculated flow. It has been shown that in many cases BOD removal can be increased by recirculation of filter effluent around the filter. The recirculated flow serves as a diluent to the influent waste. When recirculation is used, the applied BOD to the filter,  $S_o$ , becomes

$$S_o = \frac{S_a + NS}{1 + N} \quad (7.20)$$

where  $S_o$  = BOD of waste applied to the filter after mixing with the recirculated flow

$S_a$  = BOD of the influent

$S$  = BOD of filter effluent

$N$  = recirculation ratio,  $R/Q$ .

Filter performance in accordance with Eq. (7.19) is shown in Fig. 7.39. Combining Eqs. (7.19) and (7.20) yields the BOD removal relationship:

$$\frac{S}{S_a} = \frac{e^{-KA_v D/Q^* S_o}}{(1 + N) - N e^{-KA_v D/Q^* S_o}} \quad (7.21)$$

When the BOD of the waste exhibits a decreasing removal rate with decreasing concentration, the BOD in the recirculated flow will be removed at a lower rate than that prevailing in the influent. In this case, one must apply a coefficient of retardation to the recirculated flow.

It has been shown that BOD removal through the filter can be related to the applied organic loading expressed as lb BOD/(1000 ft<sup>3</sup> · d):

$$\frac{S}{S_o} = e^{-kA_v/L} \quad (7.22)$$