



# Fire Alarm Control Panel IFC-3030

Programming Manual

Document 52025  
08/05/2005

C

P/N 52025:C • ECN 05-126

# Fire Alarm System Limitations

*While a fire alarm system may lower insurance rates, it is not a substitute for fire insurance!*

**An automatic fire alarm system**—typically made up of smoke detectors, heat detectors, manual pull stations, audible warning devices, and a fire alarm control panel with remote notification capability—can provide early warning of a developing fire. Such a system, however, does not assure protection against property damage or loss of life resulting from a fire.

The Manufacturer recommends that smoke and/or heat detectors be located throughout a protected premise following the recommendations of the current edition of the National Fire Protection Association Standard 72 (NFPA 72), manufacturer's recommendations, State and local codes, and the recommendations contained in the Guide for Proper Use of System Smoke Detectors, which is made available at no charge to all installing dealers. A study by the Federal Emergency Management Agency (an agency of the United States government) indicated that smoke detectors may not go off in as many as 35% of all fires. While fire alarm systems are designed to provide early warning against fire, they do not guarantee warning or protection against fire. A fire alarm system may not provide timely or adequate warning, or simply may not function, for a variety of reasons:

**Smoke detectors** may not sense fire where smoke cannot reach the detectors such as in chimneys, in or behind walls, on roofs, or on the other side of closed doors. Smoke detectors also may not sense a fire on another level or floor of a building. A second-floor detector, for example, may not sense a first-floor or basement fire.

**Particles of combustion or "smoke"** from a developing fire may not reach the sensing chambers of smoke detectors because:

- Barriers such as closed or partially closed doors, walls, or chimneys may inhibit particle or smoke flow.
- Smoke particles may become "cold," stratify, and not reach the ceiling or upper walls where detectors are located.
- Smoke particles may be blown away from detectors by air outlets.
- Smoke particles may be drawn into air returns before reaching the detector.

The amount of "smoke" present may be insufficient to alarm smoke detectors. Smoke detectors are designed to alarm at various levels of smoke density. If such density levels are not created by a developing fire at the location of detectors, the detectors will not go into alarm.

Smoke detectors, even when working properly, have sensing limitations. Detectors that have photoelectronic sensing chambers tend to detect smoldering fires better than flaming fires, which have little visible smoke. Detectors that have ionizing-type sensing chambers tend to detect fast-flaming fires better than smoldering fires. Because fires develop in different ways and are often unpredictable in their growth, neither type of detector is necessarily best and a given type of detector may not provide adequate warning of a fire.

Smoke detectors cannot be expected to provide adequate warning of fires caused by arson, children playing with matches (especially in bedrooms), smoking in bed, and violent explosions (caused by escaping gas, improper storage of flammable materials, etc.).

**Heat detectors** do not sense particles of combustion and alarm only when heat on their sensors increases at a predetermined rate or reaches a predetermined level. Rate-of-rise heat detectors may be subject to reduced sensitivity over time. For this reason, the rate-of-rise feature of each detector should be tested at least once per year by a qualified fire protection specialist. Heat detectors are designed to protect property, not life.

**IMPORTANT! Smoke detectors** must be installed in the same room as the control panel and in rooms used by the system for the connection of alarm transmission wiring, communications, signaling, and/or power. If detectors are not so located, a developing fire may damage the alarm system, crippling its ability to report a fire.

**Audible warning devices** such as bells may not alert people if these devices are located on the other side of closed or partly open doors or are located on another floor of a building. Any warning device may fail to alert people with a disability or those who have recently consumed drugs, alcohol or medication. Please note that:

- Strobes can, under certain circumstances, cause seizures in people with conditions such as epilepsy.
- Studies have shown that certain people, even when they hear a fire alarm signal, do not respond or comprehend the meaning of the signal. It is the property owner's responsibility to conduct fire drills and other training exercise to make people aware of fire alarm signals and instruct them on the proper reaction to alarm signals.
- In rare instances, the sounding of a warning device can cause temporary or permanent hearing loss.

**A fire alarm system** will not operate without any electrical power. If AC power fails, the system will operate from standby batteries only for a specified time and only if the batteries have been properly maintained and replaced regularly.

**Equipment used in the system** may not be technically compatible with the control panel. It is essential to use only equipment listed for service with your control panel.

**Telephone lines** needed to transmit alarm signals from a premise to a central monitoring station may be out of service or temporarily disabled. For added protection against telephone line failure, backup radio transmission systems are recommended.

**The most common cause** of fire alarm malfunction is inadequate maintenance. To keep the entire fire alarm system in excellent working order, ongoing maintenance is required per the manufacturer's recommendations, and UL and NFPA standards. At a minimum, the requirements of NFPA 72 shall be followed. Environments with large amounts of dust, dirt or high air velocity require more frequent maintenance. A maintenance agreement should be arranged through the local manufacturer's representative. Maintenance should be scheduled monthly or as required by National and/or local fire codes and should be performed by authorized professional fire alarm installers only. Adequate written records of all inspections should be kept.

Precau-L-1-2005.fm

# Installation Precautions

*Adherence to the following will aid in problem-free installation with long-term reliability:*

**WARNING - Several different sources of power can be connected to the fire alarm control panel.** Disconnect all sources of power before servicing. Control unit and associated equipment may be damaged by removing and/or inserting cards, modules, or interconnecting cables while the unit is energized. Do not attempt to install, service, or operate this unit until manuals are read and understood.

**CAUTION - System Re-acceptance Test after Software Changes:** To ensure proper system operation, this product must be tested in accordance with NFPA 72 after any programming operation or change in site-specific software. Re-acceptance testing is required after any change, addition or deletion of system components, or after any modification, repair or adjustment to system hardware or wiring. All components, circuits, system operations, or software functions known to be affected by a change must be 100% tested. In addition, to ensure that other operations are not inadvertently affected, at least 10% of initiating devices that are not directly affected by the change, up to a maximum of 50 devices, must also be tested and proper system operation verified.

**This system** meets NFPA requirements for operation at 0-49° C/32-120° F and at a relative humidity (non condensing) of 85% at 30°C (86°F) per NFPA, and 93% ± 2% at 32°C ± 2°C (89.6°F ± 1.1°F) per ULC. However, the useful life of the system's standby batteries and the electronic components may be adversely affected by extreme temperature ranges and humidity. Therefore, it is recommended that this system and its peripherals be installed in an environment with a normal room temperature of 15-27° C/60-80° F.

**Verify that wire sizes are adequate** for all initiating and indicating device loops. Most devices cannot tolerate more than a 10% I.R. drop from the specified device voltage.

**Like all solid state electronic devices,** this system may operate erratically or can be damaged when subjected to lightning induced transients. Although no system is completely immune from lightning transients and interference, proper grounding will reduce susceptibility. Overhead or outside aerial wiring is not recommended, due to an increased susceptibility to nearby lightning strikes. Consult with the Technical Services Department if any problems are anticipated or encountered.

**Disconnect AC power and batteries** prior to removing or inserting circuit boards. Failure to do so can damage circuits.

**Remove all electronic assemblies** prior to any drilling, filing, reaming, or punching of the enclosure. When possible, make all cable entries from the sides or rear. Before making modifications, verify that they will not interfere with battery, transformer, or printed circuit board location.

**Do not tighten screw terminals** more than 9 in-lbs. Overtightening may damage threads, resulting in reduced terminal contact pressure and difficulty with screw terminal removal.

**This system contains static-sensitive components.**

Always ground yourself with a proper wrist strap before handling any circuits so that static charges are removed from the body. Use static suppressive packaging to protect electronic assemblies removed from the unit.

**Follow the instructions** in the installation, operating, and programming manuals. These instructions must be followed to avoid damage to the control panel and associated equipment. FACP operation and reliability depend upon proper installation.

Precau-L-4-2005.fm

## FCC Warning

**WARNING:** This equipment generates, uses, and can radiate radio frequency energy and if not installed and used in accordance with the instruction manual may cause interference to radio communications. It has been tested and found to comply with the limits for class A computing devices pursuant to Subpart B of Part 15 of FCC Rules, which is designed to provide reasonable protection against such interference when devices are operated in a commercial environment. Operation of this equipment in a residential area is likely to cause interference, in which case the user will be required to correct the interference at his or her own expense.

## Canadian Requirements

This digital apparatus does not exceed the Class A limits for radiation noise emissions from digital apparatus set out in the Radio Interference Regulations of the Canadian Department of Communications.

Le présent appareil numérique n'émet pas de bruits radioélectriques dépassant les limites applicables aux appareils numériques de la classe A prescrites dans le Règlement sur le brouillage radioélectrique édicté par le ministère des Communications du Canada.

HARSH™, NIS™, Notifier Integrated Systems™, NOTI•FIRE•NET™, and ONYXWorks™ are all trademarks; and FlashScan®, NION®, NOTIFIER®, ONYX®, UniNet®, VeriFire®, and VIEW® are all registered trademarks of Honeywell International Inc. Echelon® is a registered trademark and LonWorks™ is a trademark of Echelon Corporation. ARCNET® is a registered trademark of Datapoint Corporation. Microsoft® and Windows® are registered trademarks of the Microsoft Corporation. LEXAN® is a registered trademark of GE Plastics, a subsidiary of General Electric Company.

©2005 by Honeywell International Inc. All rights reserved. Unauthorized use of this document is strictly prohibited.

# Documentation Feedback

Your feedback helps us keep our documentation up-to-date and accurate. If you have any comments or suggestions about our online Help or printed manuals, you can email us.

Please include the following information:

- Product name and version number (if applicable)
- Printed manual or online Help
- Topic Title (for online Help)
- Page number (for printed manual)
- Brief description of content you think should be improved or corrected
- Your suggestion for how to correct/improve documentation

Send email messages to:

**FireSystems.TechPubs@honeywell.com**

Please note this email address is for documentation feedback only. If you have any technical issues, please contact Technical Services.

# Table of Contents

<b>Section 1: General Information.....</b>	<b>9</b>
1.1: About This Manual .....	9
1.2: Supplemental Information .....	10
1.3: Introduction to the Control Panel .....	11
1.3.1: Features.....	11
1.4: Navigating Menu and Programming Screens .....	11
1.5: Basic Procedure .....	12
1.6: Getting Started .....	12
1.6.1: Password Change.....	12
<b>Section 2: Main Menu .....</b>	<b>15</b>
2.1: Event Counts Display .....	15
2.2: Multiple Event List .....	15
2.3: History Display (History Select Screen).....	15
2.4: Read Status .....	16
2.5: Program/Alter Status.....	16
2.6: Printer Functions.....	16
<b>Section 3: Program .....</b>	<b>17</b>
3.1: General Information.....	17
3.2: Panel Program.....	18
3.2.1: Panel Program Menu (1).....	18
3.2.2: Network Parameters .....	19
3.2.3: Panel Settings .....	21
3.2.4: Panel Timers (Menu 1).....	23
3.2.5: Panel Timers (Menu 2).....	25
3.2.6: LCD Programming .....	26
3.2.7: ACS Programming .....	26
3.2.8: Supervision .....	30
3.3: Panel Program Menu (2).....	31
3.3.1: Password Change.....	31
3.3.2: Weekly Occupancy Schedule .....	31
3.3.3: Remote Display Menu .....	32
3.3.4: Loop Configuration .....	33
3.3.5: Custom Action Message.....	35
3.3.6: Event Logging .....	36
3.3.7: Holiday Menu .....	36
3.4: Point Program .....	37
3.4.1: Detector Point.....	38
3.4.2: Module Point .....	43
3.4.3: Panel Circuit Module.....	47
3.4.4: General Zone .....	51
3.4.5: Releasing Zone .....	51
3.4.6: Logic Zone.....	52
3.4.7: Trouble Zone .....	55
3.4.8: Annunciator Board Label .....	56
3.5: Delete Program .....	56
3.6: Autoprogram Menu .....	58
3.6.1: To Create a New Program .....	58
3.6.2: To Add/Delete Devices from the Program .....	58
3.6.3: Confirmation Screens .....	59
<b>Section 4: Alter Status.....</b>	<b>65</b>
4.1: Disable/Enable Point Selection.....	65
4.2: Disable/Enable .....	66

4.3: Detector Sensitivity .....	67
4.3.1: Sensitivity Select .....	67
4.4: Clear Verify Counters .....	69
4.5: Clear History .....	69
4.6: Walk Test.....	70
4.6.1: Walk Test Menu .....	72
4.6.2: Walk Test Loops Parameters .....	73
4.6.3: Advanced Walk Test Activation.....	73
4.6.4: Devices Test Selection.....	74
4.7: Program Time/Date .....	75
4.8: Control On/Off Point Select.....	76
4.8.1: Control Off.....	76
4.8.2: Control On .....	77
<b>Section 5: Service Screens .....</b>	<b>79</b>
5.1: Version Information .....	79
5.2: Power-up Screen .....	80
5.3: Bootloader Screen .....	81
5.3.1: LCD-160 Download Menu .....	81
5.3.2: Loop Download Menu .....	82
5.4: Download Screen .....	83
5.5: Application Corrupt Screen .....	83
<b>Appendix A: Menu Hierarchy.....</b>	<b>85</b>
A.1: Screens Overview .....	85
<b>Appendix B: Releasing Applications .....</b>	<b>89</b>
B.1: Releasing Zones .....	89
B.2: NFPA Releasing Applications.....	90
B.3: Abort Switches .....	90
B.3.1: ULI Abort Switch.....	92
B.3.2: IRI Abort Switch.....	93
B.3.3: NYC Abort Switch.....	94
B.3.4: AHJ Abort Switch.....	96
B.3.5: Cross Zones.....	97
B.3.6: Using Type Codes for Releasing Zones.....	98
B.4: Miscellaneous.....	112
B.4.1: Initiating Devices .....	112
B.4.2: Warning Sounders.....	112
B.4.3: Auxiliary Control Functions .....	112
B.4.4: ACS Annunciation .....	112
<b>Appendix C: Special Zone Outputs.....</b>	<b>113</b>
C.1: Presignal and Positive Alarm Sequence (PAS) .....	113
C.1.1: What is Presignal and PAS?.....	113
C.1.2: Selecting Presignal and PAS Outputs .....	113
C.2: Coding Functions for Panel Circuit Outputs .....	114
<b>Appendix D: AWACSTM Applications .....</b>	<b>115</b>
D.1: AWACS Overview .....	115
D.2: AWACS Features .....	115
D.2.1: Drift Compensation and Smoothing .....	115
D.2.2: Maintenance Warnings – Three Levels .....	116
D.2.3: Self-Optimizing Pre-Alarm.....	117
D.2.4: Detector Sensitivity.....	117
D.2.5: Cooperative Multi-Detector Sensing .....	118
D.3: Pre-Alarm.....	118
D.3.1: Definition .....	118

D.3.2: Alert Level .....	118
D.3.3: Action Level .....	119
D.4: Detector Sensitivity Settings.....	119
D.4.1: How to Select Pre-Alarm and Alarm Sensitivity.....	119
D.4.2: To Test Detectors Set Below 0.50% Obscuration per Foot.....	121
D.5: Detector Status Display.....	121
D.5.1: Detector Maintenance Display .....	121
D.5.2: Print a Detector Maintenance Report .....	122
D.5.3: To Interpret a Detector Status Display or Maintenance Report .....	122
<b>Appendix E: CBE: Zones and Equations.....</b>	<b>125</b>
E.1: Zones .....	125
E.2: Equations.....	126
E.2.1: Arguments.....	126
E.2.2: Logic Equations .....	126
E.2.3: Trouble Equations.....	129
<b>Appendix F: Detector Initialization.....</b>	<b>131</b>
F.1: Overview.....	131
F.2: To Replace a Detector with a Different Type of Detector .....	131
<b>Appendix G: Type Codes .....</b>	<b>133</b>
G.1: What are Type Codes?.....	133
G.2: How to Select a Type Code .....	133
G.3: Type Codes for Input Devices .....	134
G.3.1: Overview.....	134
G.3.2: Type Codes for Intelligent Detectors.....	134
G.3.3: Type Codes for Monitor Modules .....	135
G.4: Type Codes for Output Devices .....	136
G.5: FlashScan Codes.....	137
<b>Appendix H: System Troubles.....</b>	<b>139</b>
<b>Appendix I: Local Settings.....</b>	<b>141</b>
I.1: Singapore.....	141
I.2: Chicago.....	142
<b>Glossary.....</b>	<b>143</b>
<b>Index.....</b>	<b>147</b>





# Section 1: General Information

## 1.1 About This Manual

The following graphics appear in the manual to indicate a caution, a warning, or a note.



**WARNING:** Information about procedures that could cause irreversible damage to the control panel, irreversible loss of programming data or personal injury.

---



**CAUTION:** Information about procedures that could cause programming errors, runtime errors, or equipment damage.

---



**NOTE:** Information that highlights an important part of the preceding or subsequent text or illustration.

---

## 1.2 Supplemental Information

The table below provides a list of document sources (manuals) containing additional information regarding the IFC-3030 and optional peripherals.

For information on...	Refer to...	Part No.
Installation	IFC-3030 Installation Manual	52024
Operation	IFC-3030 Operations Manual	52026
Main Power Supply	AMPS-24/E	51907
SLC Wiring Instructions	Johnson Controls SLC Wiring Manual	51870
Off-line programming utility	VeriFire™ Tools CD help file	JVERIFIRE-TCD
Compatible Devices	Device Compatibility Document Compatible Listings Chart Device Compatibility Technical Bulletin	51922 51364 LIT-445180
Annunciators	Annunciator Control System Annunciator Fixed Module ACM-8R Annunciator Control Module ACM-8R Annunciator Control Module Technical Bulletin LCD-80 Manual LCD-80 Liquid Crystal Display Technical Bulletin LCD-160 Liquid Crystal Display Manual LDM Series Lamp Driver Annunciator LDM Lamp Driver Modules Technical Bulletin SCS Smoke Control System JNCA Network Control Annunciator RPT-485W/RPT-485WF EIA-485 Annunciator Loop Repeater	15842 15048 15342 LIT-445125 15037 LIT-445151 51850 15885 LIT-445161 15712 51868 15640
Auxiliary Power Supply,Charger	ACPS-2406 Installation Manual APS-6R Instruction Manual APS-6R Auxiliary Power Supply Technical Bulletin CHG-120 Battery Charger Manual CHG-120 Battery Charger Technical Bulletin FCPS-24 Field Charger/Power Supply Manual Field Charger/Power Supply FCPS-24 Technical Bulletin	51304 50702 LIT-445205 50641 LIT-445210 50059 LIT-445111
Cabinets & Chassis	CAB-3/CAB-4 Series Cabinet Installation Instructions	15330
Transponders & Transmitters	DPI-232 Manual RFX Wireless Transmitter Manual TM-4 Instructions (Reverse Polarity Transmitter) UDACT Manual (Universal Digital Alarm Communicator/Transmitter) XP Transponders XP Transponder Technical Bulletin XP5 Series Manual XP5 Series Transponders Technical Bulletin	51499 51012 51490 50050 15888 LIT-448180 50786 LIT-445230
Universal Zone Coder	UZC-256 Universal Zone Coder UZC-256 Programming	15216 15976
Voice Alarm Systems & Voice Evacuation	XPIQ Manual XPIQ Quad Intelligent Audio Transponder Technical Bulletin VEC 25/50 Manual Johnson Controls Voice Alarm System Manual RM-1 Series Remote Microphone Installation Document RM-1 Series Remote Microphone Technical Bulletin ACT-2 Instructions ACT-2 Audio Coupling Transformer Technical Bulletin	51013 LIT-445235 50686 51869 51138 LIT-445212 51118 LIT-445225
Networking	Noti•Fire•Net Version 4.0 Manual and Higher NCM-W/F Instructions IFW Internet Fire Workstation, Network Version 4.0 & Higher	51584 51533 52028

**Table 1 Supplemental Documentation**

## 1.3 Introduction to the Control Panel

The IFC-3030 is an intelligent Fire Alarm Control Panel (FACP) with features suitable for most applications.

There are two basic configuration options for the IFC-3030. It can be ordered with:

- a front display/keypad, which allows programming and viewing options at the panel, or
- no display/keypad.

This manual gives programming instructions using the front display/keypad.

### Displayless Mode

When there is no keypad/display at the panel, it is controlled by remote annunciators. VeriFire™ Tools programming is required. The displayless panel has four buttons on its circuit board that are service-level switches for local operation should it become necessary. They are the only buttons, and are clearly marked with ACK for Acknowledge, SIGSIL for Signal Silence, SYSRST for System Reset, and LAMP TEST. These buttons are mainly for installer use: the operator should utilize a remote annunciator for these functions, if possible. The status indicator LEDs on the circuit board are the same as on the display/keypad (refer to the IFC-3030 Operating Manual for LED descriptions).

Refer to VeriFire™ Tools for information on programming without an IFC-3030 display/keypad. A PC is required when using VeriFire™.

Canadian applications must conform to ULC requirements for displays and network control. Refer to the Canadian Applications appendix in this panel's installation manual.

### 1.3.1 Features

Programming features include the following:

- Ease of use - Field program the control panel without special software skills.
- Local programming - program directly from the control panel keypad to reduce installation time.
- PC programming - input long data entry programming information on a PC; transfer programming data between a PC and the control panel.
- Autoprogram option - automatically detect newly installed, addressable devices, allowing quicker installation.
- Security - use passwords to control access to the control panel and protect programming.
- Large display option - 640 character screen, 16 lines x 40 characters

## 1.4 Navigating Menu and Programming Screens

The Main Menu (refer to Figure 2.1) leads to screens with various menu and programming options. Choices may be made from the menu screens by pressing the soft key closest to the menu option. Appendix A, "Menu Hierarchy" gives the programming menu hierarchy: refer to this appendix for an overall view of the layout of the screens.

Field information may be added/modified using the keyboard and special function keys.

Arrow keys on the keyboard can be used to navigate between fields on a screen if there are no soft keys to select the fields.

Scrolling through a list of selections in a screen field can be performed either by repeatedly pressing the associated soft key, or by pressing the Next Selection/Previous Selection special function keys on the Display/Keypad.

Pressing a BACK soft key on a screen returns the programmer to the previous screen without saving the information entered.

Pressing an ACCEPT soft key will save the information entered on the screen. It may also return to the previous screen and/or perform other functions as described in the soft key section for each screen.

When the FACP can not read an address (that is, if the point entered on the screen for processing does not exist) it will display an error screen for several seconds, then return to the screen where the address was entered. The user must check his input and investigate the state of the point.

## 1.5 Basic Procedure

For initial programming of the panel, or for major changes and additions, the following basic procedure is recommended to prevent errors resulting in reprogramming and wasted time.

- Use work sheets to record the exact information for every detector, module, annunciator point and software zone in the system. Pay close attention to the Software Type IDs. For voice systems, pay close attention to AMG annunciator point commands. The panel program may also be created using VeriFire™ Tools and downloaded to the panel after assembly and power-up.
- Assemble and apply power to the control panel as described in this panel's installation manual. All system boards must be physically installed.
- Read this manual before programming.
- Enter/change master and user passwords.
- Enter panel and network parameters.
- Program all devices and thoroughly test the entire system. The Walk Test feature can be used to test devices and their programming.
- Make a hard-copy record of the program on the printer.
- Save the program by uploading it using VeriFire™ Tools.

## 1.6 Getting Started

Once the system has been physically installed, programming may begin. The user may program at any time except while there is an unacknowledged alarm present.

To ensure security, passwords should be entered at this time to replace the factory default settings.

### 1.6.1 Password Change

The IFC-3030 has two password levels; master and user. There is one master password, which grants access to all system programming. There are nine user passwords, each of which may be assigned access to the programming change menus, the alter status menus, or both. A user password does not give access to or allow change to any password parameters, not even its own. Only the master password will allow access to password change screens.

The panel arrives with factory default settings of 00000000 for the master password, and 11111111 for one user password.

Follow the steps below to change the factory settings:

1. Press PROGRAM/ALTER STATUS at the Main Menu screen.
2. Using the keyboard, enter eight zeroes (00000000) after ENTER PASSWORD .
3. Press the ACCEPT soft key.
4. Press the PANEL PROGRAM MENU soft key.
5. Press the MORE soft key.
6. Press the PASSWORD CHANGE soft key.

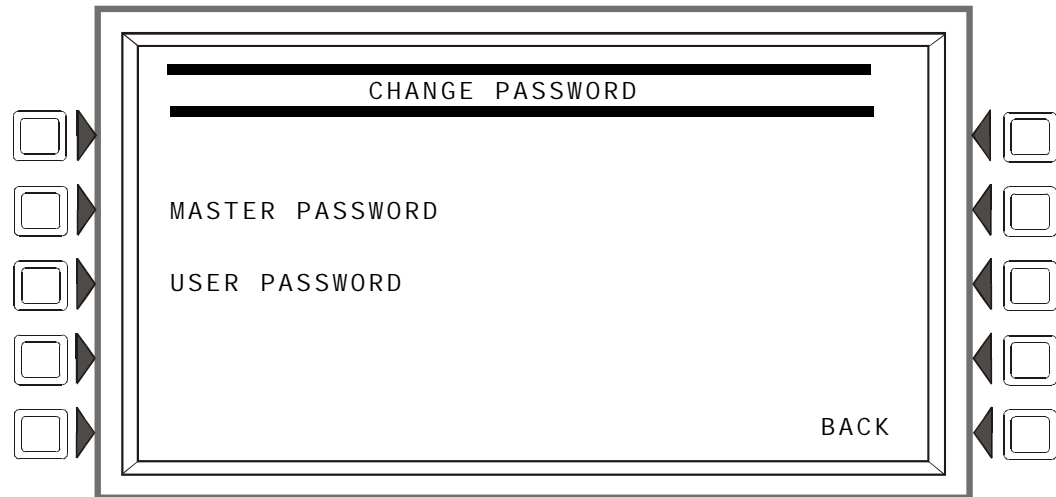

**Figure 1.1 Change Password Screen**

#### Soft Keys

MASTER PASSWORD - Press to change the master password

USER PASSWORD - Press to change the user password.





---

**NOTE:** Only a master can change another password.

---

#### Master Password

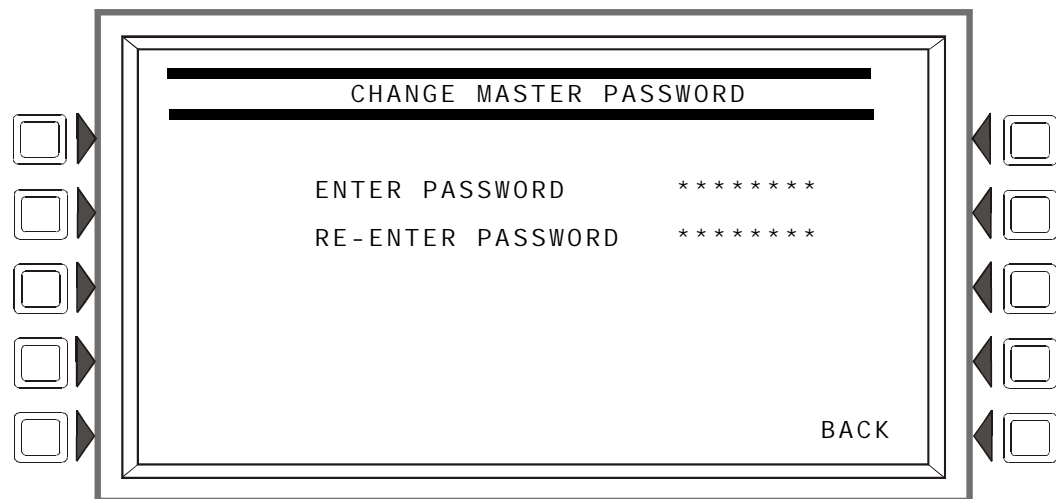
Press the MASTER PASSWORD Soft Key to display the following screen. Type in the new password that will replace the factory default password: there can be up to eight alphanumeric characters. Press the enter key on the keyboard. RE-ENTER PASSWORD will appear. Retype the password for verification. Press enter to save the new password.



**Figure 1.2 Change Master Password Screen**

#### User Password

Press the USER PASSWORD soft key to display the following screen.

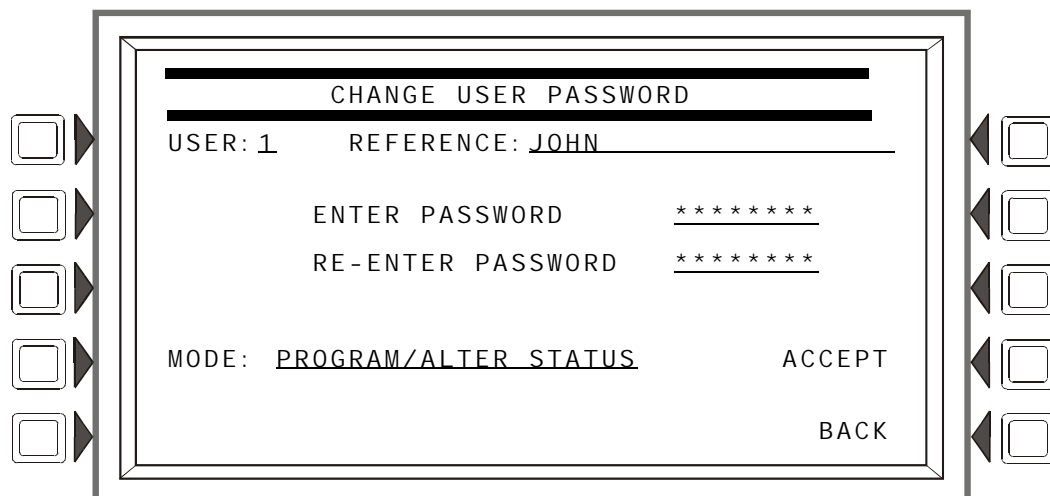

**Figure 1.3 Change User Password Screen**

### Soft Keys

**USER:** Press this soft key to scroll through the nine user password numbers. When this key is pressed, the rest of the display will update to reflect information for each new record. Stop at the password number that requires entering.

**MODE:** Press this soft key to select the user's level of access. Levels are as follows:

- PROGRAM/ALTER STATUS Gives access to the Program Change Menu and Alter Status Menu.
- ALTER STATUS Gives access to the Alter Status Menu
- NONE Gives no access.

**REFERENCE:** Press this key to enter a maximum 20-character alphanumeric label that identifies the user. Press the enter key on the display/keyboard to enter the information.

**ENTER PASSWORD -** Press to enter a new password. Type in up to eight alphanumerics on the keyboard, then press enter. RE-ENTER PASSWORD will appear. Retype the password for verification.

**ACCEPT:** After entering all password information and retyping the password at the prompt, press this soft key to save all the password information.

### Incorrect or Forgotten Password

If a password is entered incorrectly, the panel will respond by displaying an INVALID PASSWORD message and a code. The programmer may hit the escape key and re-enter the password correctly. However, if the password has been forgotten, record the code and contact NOTIFIER. After proper authentication, the master password can be determined by deciphering the code. An example of the message that would appear on the display follows:

INVALID PASSWORD:

```

  9066-21FS-7D78-5FA4-6163
  ┌──────────────────────────┐
  Code ───────────┘
  
```

## Section 2: Main Menu

The Main Menu screen is the means by which the programmer can access displays, history information, printing and programming menus. This screen is accessible from the System Normal Screen, and from most other screens by pressing the BACK soft key until it displays.

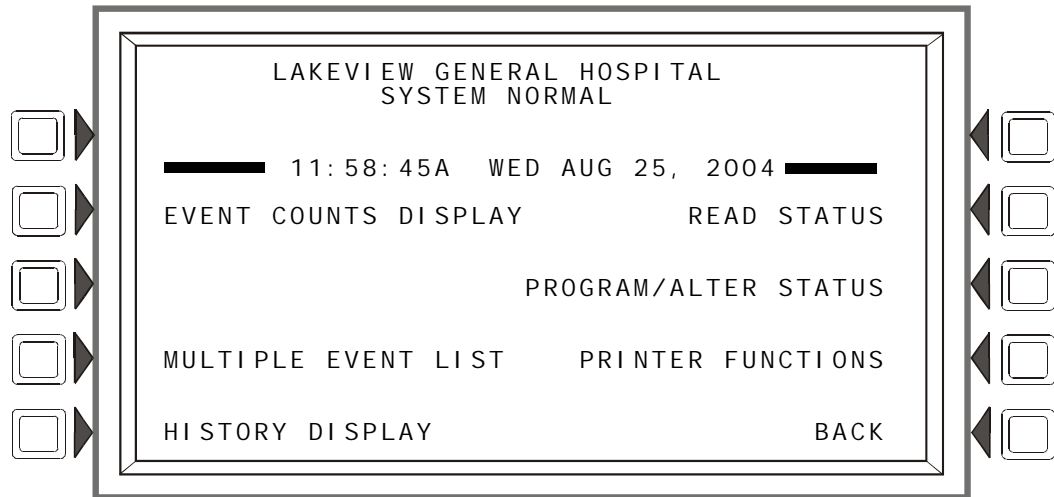

Figure 2.1 Main Menu Screen

### Soft Keys

Pressing the soft keys brings the user to the screens described below.

## 2.1 Event Counts Display

Pressing the EVENT COUNTS DISPLAY soft key on the Main Menu brings up the EVENT COUNTS screen. This screen will automatically display if an off-normal event requiring acknowledgement occurs. The display consists of current counts of off-normal events in six categories: the counts include both acknowledged and unacknowledged events.

Refer to this panel's operations manual for an illustration and description of the Event Counts Display.

## 2.2 Multiple Event List

Pressing the Multiple Event List soft key shows off-normal events simultaneously in groups of eight. It displays automatically for off-normal events when the Canada event order has been selected. (Refer to Event Ordering in "Panel Settings" on page 21 for information on display order.)

Refer to this panel's operations manual for an illustration and description of the Multiple Event List.

## 2.3 History Display (History Select Screen)

The History Select screen allows the user to select a type of history file to view, and to set time/date or point range viewing parameters.

Refer to this panel's operations manual for an illustration and description of History Display.

## 2.4 Read Status

Pressing the Read Status soft key brings up screens to view the present status of points, zones, and other system information. Refer to this panel's operations manual for a full description of Read Status.

## 2.5 Program/Alter Status

Pressing the Program/Alter Status soft key brings up screens for panel programming, point programming, autoprogramming, clear programming, altering the status of points, walk test, and other information. Refer to Sections 3, and 4 for a full description of Program/Alter Status.

## 2.6 Printer Functions

Pressing the Printer Functions soft key brings up screens to print reports. Refer to this panel's operations manual for a description of Printer Functions. This key will appear only if a printer operation has been selected. Refer to "Supervision" on page 30 for selection information.



# Section 3: Program

## 3.1 General Information

The IFC-3030 operates with two levels of programming: Program, and Alter Status.

Program level allows change to the essential control panel functions such as point functions, system functions, and passwords. Program level change requires the master password, or a user password that allows access to the Program level. All password information can be changed with a master password only.

Alter Status level allows change to operating parameters, such as detector sensitivity, or time/date, or Walk Test. The master password, or a user password that allows access to the Alter Status level, is required.



---

**NOTE:** All events except troubles are annunciated during programming. When an annunciated event occurs, the panel will automatically exit the programming screen and the Event Counts menu screen will appear.

---

To access the Program level, press the Program/Alter Status soft key on the Main Menu and at the prompt enter a master password, or a user password that allows access to the Program level. The following screen will display.



---

**NOTE:** No program menus will display if a user password is entered that has access to Alter Status level only: the Alter Status menu will be the sole menu choice

---

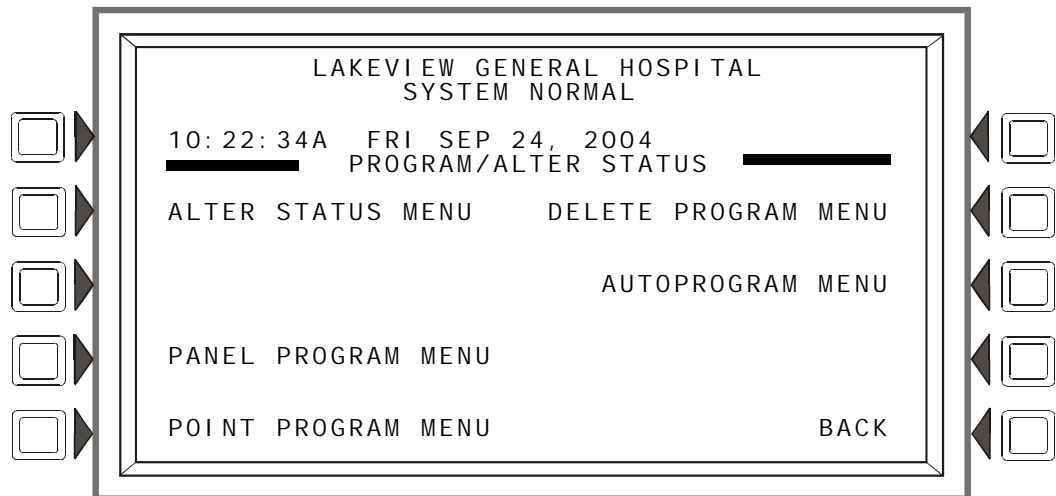

**Figure 3.1 Program/Alter Status Screen**

Press a soft key with the word “program” in its menu to bring up the associated program menu.

When programming the panel for the first time, press the DELETE PROGRAM MENU soft key, which brings up the Delete Program Menu screen (Refer to Figure 3.46). Press the CLEAR ALL PROGRAMMING button, then ACCEPT, to ensure that the panel is set to defaults and clear of programs.



**NOTE:** Clearing all programs is not necessary when initial programming with a database downloaded from VeriFireVeriFire™ Tools.

The logical sequence for initial programming is to program the panel parameters first, then to program the individual points through autoprogramming and/or point programming.

## 3.2 Panel Program

Panel programming provides the means to change settings for the panel system as a whole, as well to address and program annunciator points.

### 3.2.1 Panel Program Menu (1)

Press the Panel Program Menu for the following choices.

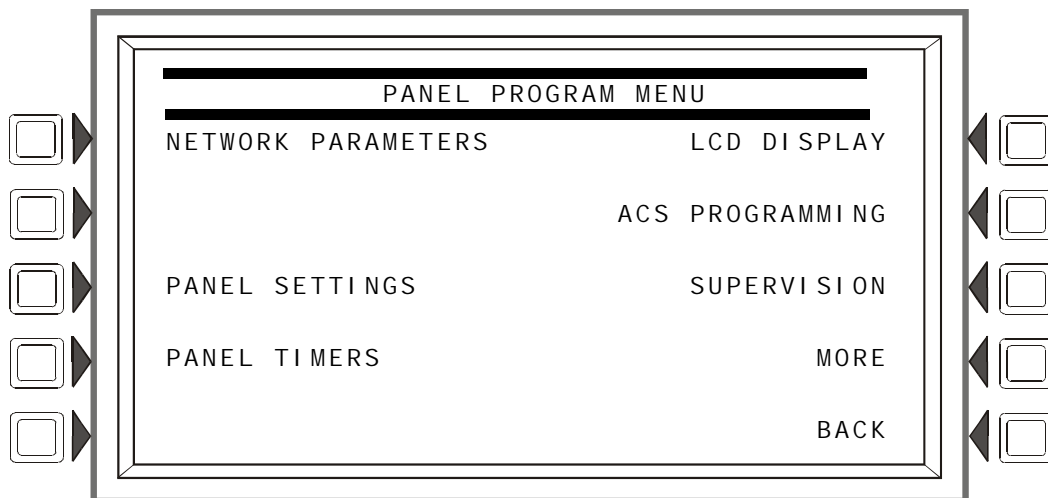

Figure 3.2 Panel Program Menu 1 Screen

## 3.2.2 Network Parameters

Press the Network Parameters soft key on Panel Program Menu 1 to bring up the following screen. If the panel will operate as a standalone unit and not part of a network, the node label is the only field that needs to be entered: it is the label that appears as part of the System Normal message.

The screenshot shows a rectangular screen with a double-line border. At the top, the text "NETWORK PROGRAMMING" is centered between two horizontal bars. Below this, the screen is divided into several sections by horizontal lines. The first section contains "NODE NUMBER: 000". The second section contains "NODE LABEL: LAKEVIEW GENERAL HOSPITAL". The third section contains "STYLE: STYLE 7" on the left and "IP ACCESS" on the right. The fourth section contains "CH A. THRESHOLD: HI GH" on the left and "ACCEPT" on the right. The fifth section contains "CH B. THRESHOLD: LOW" on the left and "BACK" on the right. On the left and right sides of the screen, there are five square soft key icons, each with a right-pointing arrow on the left and a left-pointing arrow on the right, corresponding to the five rows of text.

**Figure 3.3 Network Programming Screen**

### Soft Keys

**NODE NUMBER:** Enter the network node number of this panel. For standalone IFC-3030, the network node number will be 000. A valid network node number range is 1-240. Once the soft key has been pressed, the number may be typed in from the keypad, or the Next/Previous Selection special function key on the keypad may be used to toggle through online node numbers. The network node number may be viewed by pressing the Lamp Test special function key longer than five seconds. (Refer to “Version Information” on page 79 ). Default: 000

**NODE LABEL:** Enter the network node label for this panel. This is the label that appears in the System Normal message. Default: <blank>

**STYLE:** Select the wiring style as 4 or 7. Default: style 4

**CHANNEL A THRESHOLD, CHANNEL B THRESHOLD:** Enter HI GH or LOW, for high or low threshold setting for channel A or B on the NCM module. Default: HI GH

**IP ACCESS:** Press this soft key to bring up the IP ACCESS screen.

**ACCEPT:** Press this soft key to save the information entered on this screen.

## IP ACCESS Screen



**NOTE:** Use of the IP ACCESS feature is subject to the approval of the local AHJ.

This screen allows the programmer to set the IP Access. This setting allows the disabling/enabling of commands, downloads and programming from the Wide Area Network (WAN).

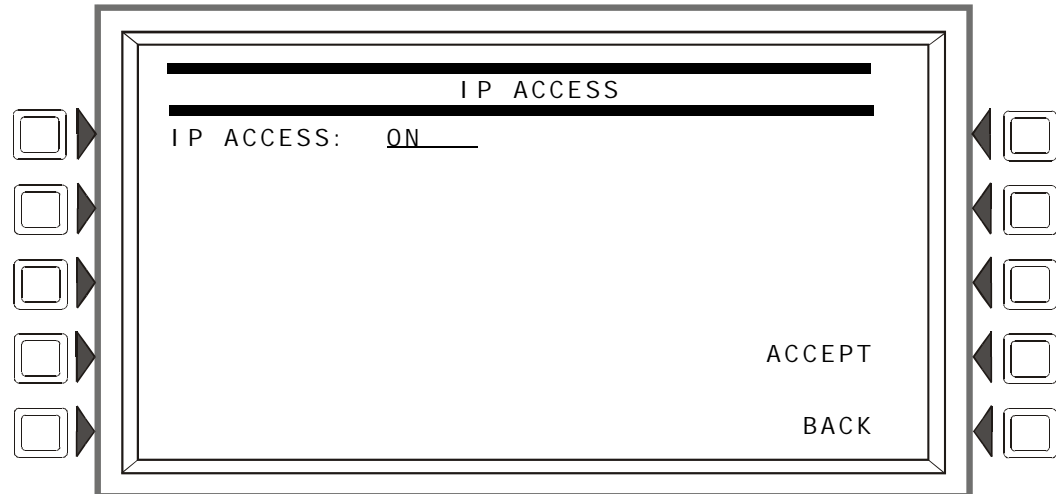

**Figure 3.4 IP Access Screen**

### Soft Keys

IP ACCESS: Press the soft key to scroll through the choices. Press ACCEPT at the desired setting.

Settings are:

ON - IP commands, downloads and programming are allowed.

OFF - IP commands, downloads and programming are *NOT* allowed. (default)

TI MED - IP commands, downloads and programming are allowed for a two-hour period, after which the setting will revert to OFF.



**NOTE:** Enabling IP ACCESS allows downloads over a local area network (LAN) or the internet (Wide Area Network - WAN) using VeriFire Tools through a Noti•Fire•Net™ Web Server (NWS), or a wide-area enabled NCS through a PC version of Noti•Fire•Net™ Gateway.

Always verify system operation after programming changes are made in this manner.

### 3.2.3 Panel Settings

Press the Panel Settings soft key on the Panel Program Menu 1 screen to choose panel settings.

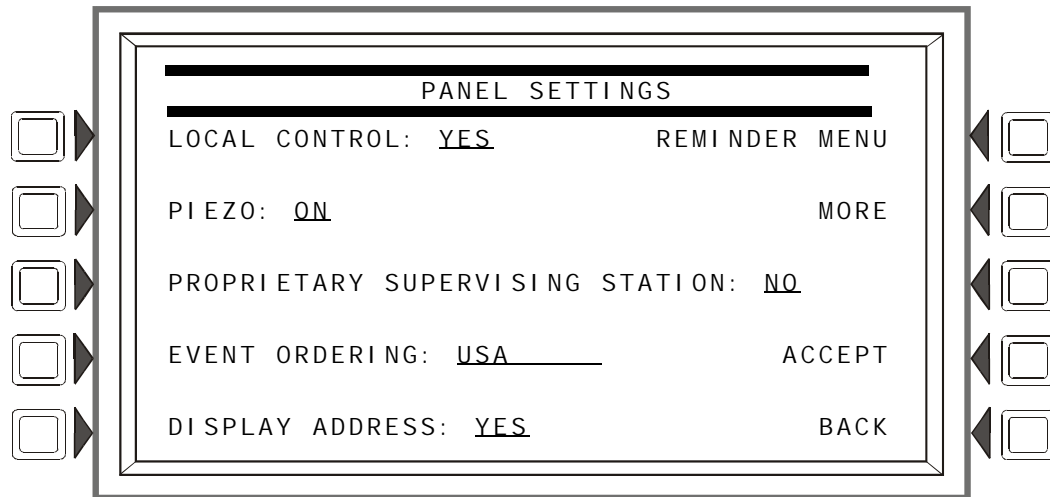

**Figure 3.5 Panel Settings (1) Screen**

#### Soft Keys

**LOCAL CONTROL:** Press this soft key to toggle between Yes and No. This option disables (No) or enables (Yes) local panel control of the Signal Silence, System Reset, and Drill Fixed Function keys, as well as SIGNAL SILENCE, SYSTEM RESET, and ACKNOWLEDGE soft keys. A setting of No (disable) turns the panel piezo sounder off, overriding the next field if PIEZO is set to ON. Default: Yes



**NOTE:** A setting of NO (disable) will disable key switch operation.



**NOTE:** ACS devices programmed for acknowledge, signal silence, system reset and drill are not affected by this setting: these commands will still function at the devices if LOCAL CONTROL is set to No.

**PIEZO:** Press this soft key to toggle between Off and On. This option enables (On) or disables (Off) the panel piezo from sounding when alarms or troubles occur. A setting of On is overridden if LOCAL CONTROL is set to No. Default: On

**PROPRIETARY SUPERVISING STATION:** Press this soft key to enable (Yes) or disable (No) Local Receive mode. When enabled, events and the clearing of events must be handled one at a time: each must be acknowledged. Latching events require a system reset. The panel will override a setting of Yes if the Node Number is greater than zero. Default: No

**EVENT ORDERING:** Press this soft key to toggle between USA and Canada ordering priorities. This order is applied to events shown in the Multiple Events List screen. Default: USA

USA Event Order	Canada Event Order
Fire	Fire
Security	Supervisory
Supervisory	Trouble
Trouble	Prealarm
Prealarm	Disabled
Disabled	

DI SPLAY ADDRESS: Press this soft key to toggle between Yes and No. Choose Yes to display all point address information at the top of event screens and in printouts. Choose No to suppress address information display and printing. Default: Yes

REMI NDER MENU: Press this soft key to bring up the Reminder Menu screen.

ACCEPT: Press this soft key to save the information entered on this screen.

MORE: Press this key to progress to the second Panel Settings screen.

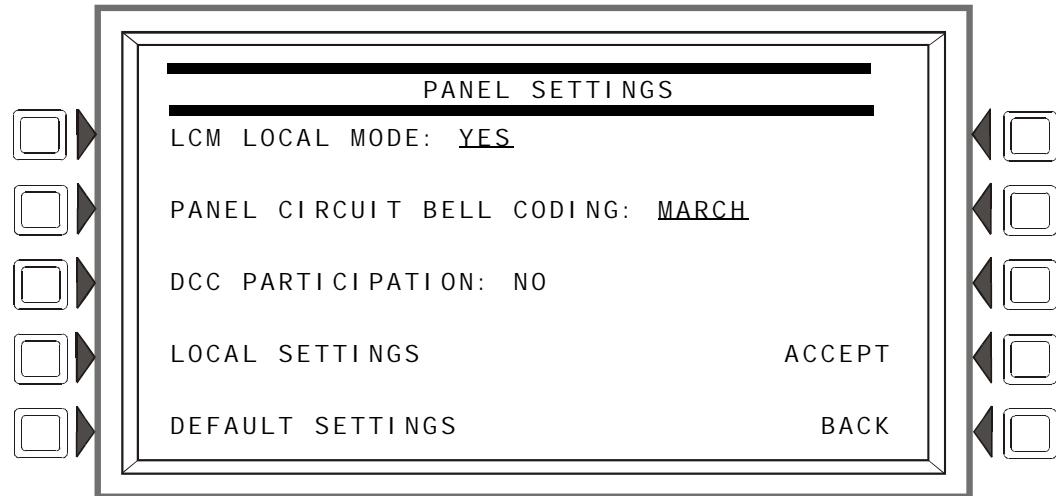

**Figure 3.6 Panel Settings (2) Screen**

### Soft Keys

LCM LOCAL MODE: Press this soft key to toggle between Yes and No. Enter Yes to enable all SLCs to participate in local mode. When enabled, all LCMs will operate together in a limited fashion when communication is lost with the IFC-3030 CPU. Inputs on LCM loops (and associated LEM loops, if installed) will activate outputs on all loops

- for those inputs and outputs that have been set with point programming to participate in local mode, and
- when type codes are the same point type: that is, an input with a fire type code will activate an output with a fire type code. (Refer to Appendix G, “Type Codes”, on page 133 for point types).

Default: NO

PANEL CI RCUI T BELL CODI NG: Press to toggle between MARCH and TEMPORAL. This is a global setting: ZF8 must be entered in the zone map of any panel circuit point that will participate in this coding. Refer to “Coding Functions for Panel Circuit Outputs” on page 114 for more information. Default: MARCH

DCC PARTI CI PATI ON: Press this key to program the panel for DCC (Display and Control Center) participation. This network function ensures that one location at a time is in command of the Acknowledge, System Reset, Signal Silence and Drill functions. Default: NO



### CAUTION:

On systems utilizing the DCC function, all locations that can participate in DCC should be set to YES.

**LOCAL SETTINGS:** Press this soft key to proceed to the Local Settings screen. Press the soft key to scroll through the selections. The default is that there are no special local settings. Other settings are explained in Appendix I, "Local Settings".

**DEFAULT SETTINGS:** Press this soft key to activate default settings for the following:

Program setting for:	Default:
Local Control	Yes
Piezo	On
Proprietary Supervising Station	No
Event Ordering	USA
Display Address	Yes
LCM Local Mode	No
Panel Circuit Bell Coding	March
DCC Participation	No

### Reminder Menu

Press the Reminder Menu soft key on the Panel Program Menu 1 screen to set the trouble reminder.

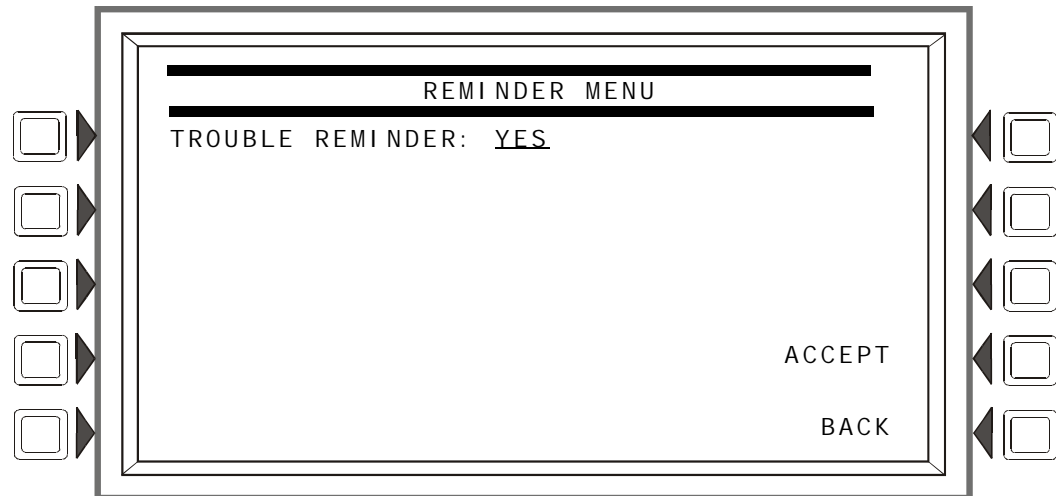

**Figure 3.7 Reminder Menu Screen**

#### Soft Keys

**TROUBLE REMI NDER:** Press this soft key to toggle between the two possibilities:

**YES:** Choose this to initiate a daily 11:00AM reminder that there are uncleared troubles in the system. The reminder will appear on the screen and will sound a piezo (if the piezo is enabled).

**NO:** Choose this if no reminder is desired. Default: YES

**ACCEPT:** Press this soft key to save the information entered on this screen.

### 3.2.4 Panel Timers (Menu 1)

Press the Panel Timers soft key on the Panel Program Menu 1 screen to display the following screen.

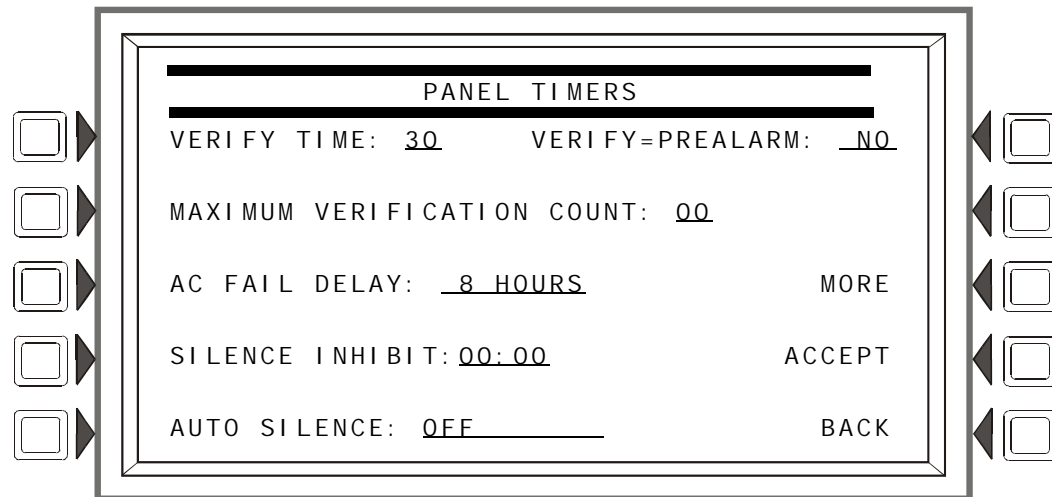

**Figure 3.8 Panel Timers (Menu 1) Screen**

**Soft Keys**

**VERI FY TI ME:** Press this soft key to set the Alarm Verification timer. Type in a value of 0-60 (seconds), which will delay initiating devices set for Alarm Verification from signaling for the amount of time entered. If a second alarm occurs while the alarm verification timer is counting, the timer will stop and the alarm will signal immediately. Default: 30



**NOTE:** This value may not exceed 30 seconds for ULC installations.

**MAXI MUM VERI FI CATI ON COUNT:** Press and enter a value from 0-20 for a maximum verification count threshold value that applies to detectors set to participate in Alarm Verification. A value of zero produces no verification trouble. When the counter exceeds the threshold value entered, a trouble is generated to the panel. Default: 20

**AC FAI L DELAY:** Press this soft key to set the timing for the time delay from AC Failure to when the trouble is reported. Type in a value of 6-12 (hours), or 0 (zero). A value of zero will cause immediate notification. Default: 8

The onboard trouble relay ( TB3 on the CPU-3030 ) will activate and TM-4s will report according to this setting.

UDACTs are notified immediately of AC failure by the panel, regardless of the panel’s delay setting. Once the UDACT receives notification, it operates according to its own programmed AC Fail Delay reporting schedule.

Example: AC Failure occurs at 1:00 p.m. on a panel with an AC FAIL DELAY setting of 8 hours. The UDACT is set for notification after 6 hours.

Time	Event
1:00 p.m.	AC Failure. Panel notifies UDACT. Panel and UDACT timers begin countdown to report time.
7:00 p.m.	UDACT reports.
9:00 p.m.	TM-4 reports, TB3 trouble relay activates.

The AMPS-24, ACPS-2406, and XPIQ power supplies must be set to an AC Delay value of 0 (zero) when used with this panel.

**SI LENCE I NHI BI T:** Press to enter a value from 0 (disabled) to 5 minutes. This software timer disables the SIGNAL SILENCE key function for the time entered when a fire alarm occurs. The timer starts at the first alarm only; it does not restart with each new alarm. Default: 0



AUTO SILENCE: Press to enter a value of OFF (no Auto Silence Timer), or a value of 10, 15 or 20 minutes. This global software timer functions like pressing the SIGNAL SILENCE key. For example, if a value of 10 is entered, the control panel will silence all active outputs programmed as silenceable after ten minutes. Default: OFF



**NOTE:** This value must be 20 minutes for ULC installations.

VERIFY=PREALARM: Press this soft key to enter Yes or No for displaying Prealarm during alarm verification. Default: NO

### 3.2.5 Panel Timers (Menu 2)

Press the MORE soft key on the Panel Timers Menu 1 screen to display the following screen.

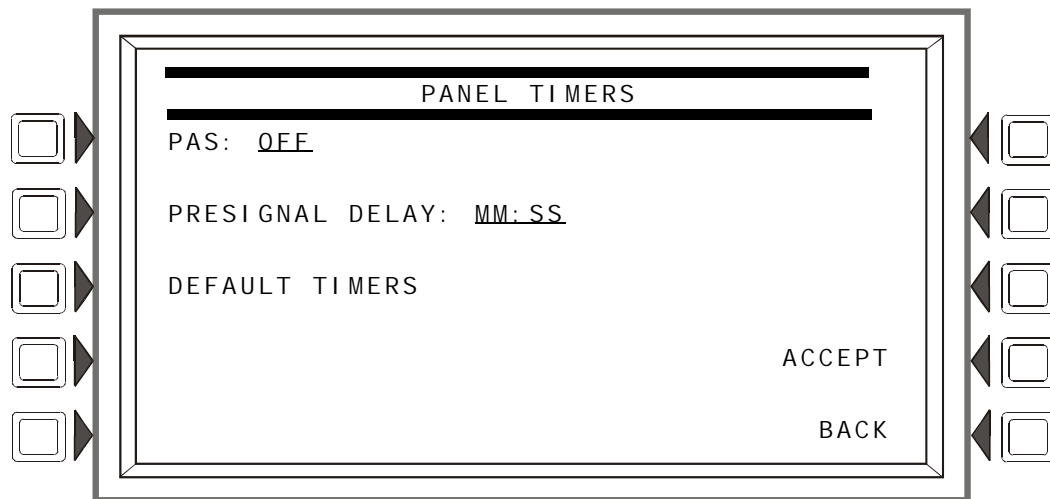

**Figure 3.9 Panel Timers (Menu 2) Screen**

#### Soft Keys

PAS: Press to toggle between the choices of OFF or ON for PAS (Positive Alarm Sequence). Refer to Appendix C, “Special Zone Outputs” for an explanation of this option. Default: OFF

PRESIGNAL DELAY: Press to enter a value of 00:00 (OFF) or a value of 1:00 to 3:00 minutes (in the format MM:SS, where MM= minutes, SS=seconds). This feature initially causes alarm signals to sound only in specific areas, monitored by qualified personnel. This allows delay of the alarm for up to 3 minutes after the start of alarm processing. Refer to Appendix C, “Special Zone Outputs” for further explanation of this option. Default: 3: 00

DEFAULT TIMERS: Press this soft key to activate default settings for the following:

Program setting for:	Default:
Verify Time	30 seconds
Max. Verify	20
AC Fail Delay	8 hours
Silence Inhibit	0 (disabled)
Auto Silence	Off
Verify=Prealarm	No
PAS	OFF
Presignal Delay	3 minutes

ACCEPT: Press this soft key to save the information entered on this screen and return to the previous screen.

### 3.2.6 LCD Programming

The LCD Programming screen allows the user to vary the contrast of the display and turn the backlight on or off.

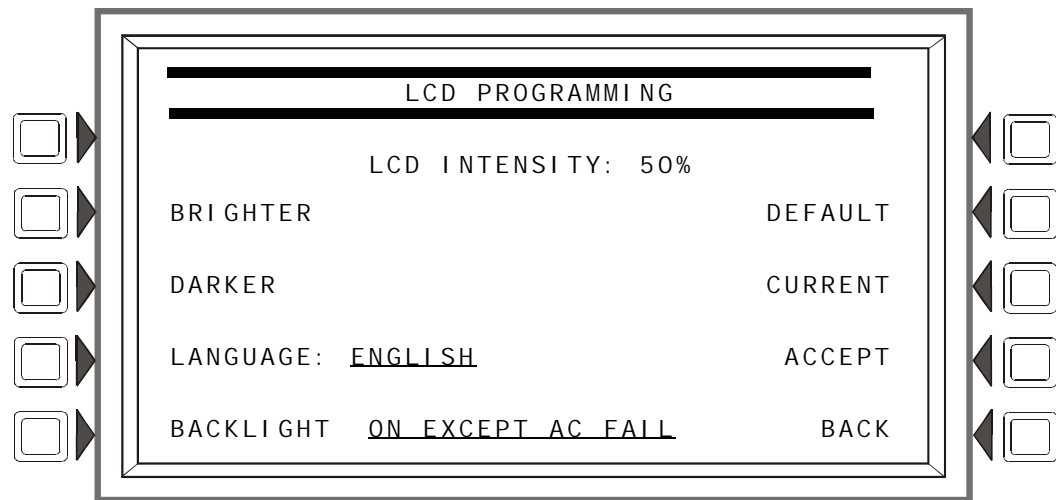

**Figure 3.10 LCD Display Screen**

#### Soft Keys

**BRIGHTER:** Press this soft key to increase contrast. The intensity will increase by approximately 5% with each press of the key.

**DARKER:** Press this soft key to decrease contrast. The intensity will decrease by approximately 5% with each press of the key.

**LANGUAGE:** Press this soft to choose the language that will display on the LCD. Menu choices are ENGLISH, HEBREW, PORTUGUESE and SPANISH.

To change the language display on an LCD-160, refer to “LCD-160 Download Menu” on page 81.

**BACKLIGHT:** Press this soft key to select one of the following backlighting options: ON EXCEPT AC FAIL, OFF, or ON. When ON EXCEPT AC FAIL is selected, the backlight will turn off when the power supply designated as the main power supply experiences AC failure. (The designation is made at the Supervision screen using the MAIN POWER SUPPLY AC FAIL ADDRESS field. Refer to “Supervision” on page 30.)

Default: ON

**DEFAULT:** Press to select the factory default setting (60%).

**CURRENT:** Press to select the intensity that was in effect when the screen was accessed..

**ACCEPT:** Line 5 (which displays LCD INTENSITY: 50% in the figure above) will change value when the INTENSITY soft keys are pressed. Press ACCEPT to save the desired setting.

### 3.2.7 ACS Programming

An ACS device is a remote device used by the panel to annunciate certain system messages, and/or to act with limited commands. A total of 32 annunciator devices may be present on the EIA-485 ACS circuit; however, some devices have associated expander devices, and an IFC-3030 ACS circuit can accommodate up to 3,072 annunciator points. The ACS Programming and ACS Point

Programming screens in this section allow the user to define the mapping and functional mode of these devices and points. Each annunciator board may be labeled using the ACS Label Menu. (Refer to “Annunciator Board Label” on page 56).

**NOTE:** Smoke Control devices must be set as FSCS or HVAC annunciator types. In addition to its 64 smoke control points, when an SCS device is operating in FSCS (Firefighters Smoke Control Station) mode, there are 32 additional points which function as alarm points. They can be mapped to a zone or point to send the SCS device into a fire alarm state when any of the additional 32 points is activated. Any of the 32 alarm points that are used must be set to MONITOR mode from the panel. Any of these points that are not used can be set to NONE. Refer to the SCS manual for further information on Smoke Control devices.

**NOTE:** When using an AMG, the address it occupies (an address of 25 through 32, typically address 32 ) must be set to annunciator type AMG, and address one must be set to annunciator type 64PT.

UDACT and TM-4 communicators, as well as the UZC Zone Coder, are installed on the same EIA-485 ACS circuit as annunciators, and so are included with annunciator programming. The TM-4 occupies one of the 32 annunciator addresses, and the UDACT can occupy one or more of these addresses. The UZC can occupy up to four annunciator addresses, each with 64 points. When the UDACT or UZC expand beyond one annunciator address, 64PT should be used for the subsequent address types, and the annunciator addresses should be sequential. Other than address assignment, there is no ACS point programming for these devices. Refer to the specific device manual for more information.

Press the ACS Programming soft key at the Panel Program screen to invoke the following screen. Press the up and down arrow keys on the keypad to navigate through the annunciator addresses. There will be a cursor highlighted at the current annunciator address position.

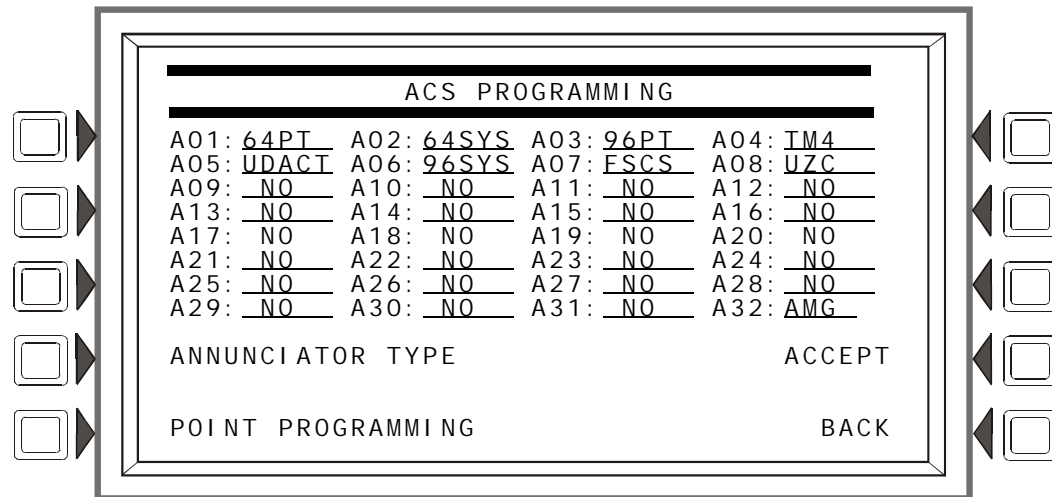

**Figure 3.11 ACS Programming Screen**

**Soft Keys**

**ANNUNCIATOR TYPE:** When the cursor is placed at the desired address, press this soft key to scroll through the following list of types. Stop at the appropriate type.

Type	Used for
64 PT	64 point annunciation
64SYS	64 point annunciation, with first 8 points reserved
96PT	96 point annunciation

96SYS	96 point annunciation, with first 8 points reserved
UDACT	UDACT, first address. Any additional UDACT annunciator addresses should be programmed as 64PT and be sequential.
TM4	TM-4
AMG	AMG
FSCS	Smoke control modules set for FSCS mode
HVAC	Smoke control modules set for HVAC mode
UZC	Universal Zone Coder, first address. Any additional UZC annunciator addresses should be programmed as 64PT and be sequential.

POI NT PROGRAMMI NG: Press this soft key to proceed to the ACS Point Programming screen.

ACCEPT: Press this soft key to save all the changes made and return to the previous screen (Panel Program).

### ACS Point Programming

ACS Point Programming can be reached by pressing POI NT PROGRAMMI NG at the ACS Programming screen. This screen allows the programmer to assign a mode and sources to each annunciator point at the annunciator address. One ACS input may be used to control multiple panel circuit or SLC output modules by listing the output points in the SOURCE fields. This feature applies to the following Types: 64PT, 64SYS, 96PT, and 96SYS.



**NOTE:** Panel circuit or SLC output modules with releasing Type IDs may not be listed in the annunciator source fields.



**NOTE:** This FACP supports ACM-24AT/ACM-48A annunciators and their expanders with either 64 or 96 points at an address, as well as ACM-16AT/ACM-32A/LDM-32 annunciators with 64 points at an address.

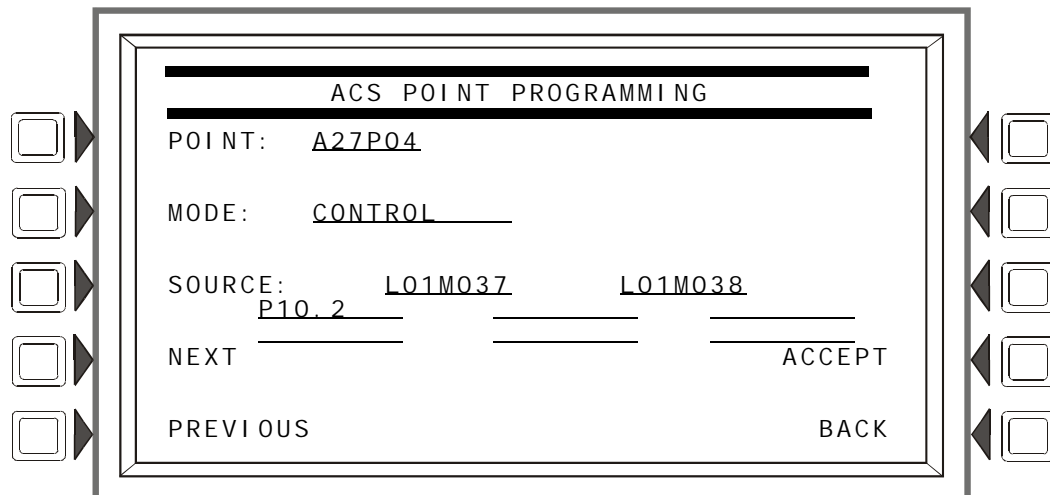

**Figure 3.12 ACS Point Programming Screen**

#### Soft Keys

POI NT: Press this soft key to enter the ACS point number. The format is AxxPyy, where A is the two-digit device address, P is the two-digit point number. Enter a leading zero for one-digit numbers.

MODE: Press this soft key to enter the ACS mapping mode. Refer to the following chart for possible mode choices and descriptions of their functions.

ACS Point Mode	Function The point...	Explanation
None	is not programmed.	No messages are sent from or received at this point. LEDs at this point do not light.
Control	will change the state of up to eight panel circuits or control modules to off or on when its button is pushed.	The Point Active LED is lit if a corresponding mapped point is active. The Status (trouble) LED is on when a point or zone is disabled or in trouble. This mode is not for use with an ACS point with no switch, or with a TM-4 or UDACT.
Monitor	will show the current status of a specified point or zone.	The Point Active LED is lit if the corresponding mapped point or zone is active. The Status (trouble) LED is on if that point or zone is disabled or in trouble. If the point has a button, it has no effect when pushed.
Telephone	supports telephone functionality when mapped to a telephone point. Press the button to connect the mapped point with the telephone station.	Both the Point Active LED and the Status (trouble) LED will flash if a telephone has been placed in the jack at the mapped telephone point. Otherwise, the Point Active LED is lit if the corresponding point or zone is active. The Status (trouble) LED is lit if that point or zone is in trouble or disabled. This mode is for use with ACS Series annunciator points configured for telephone operation.
Disable	will change the state of a point or zone specified through mapping from enabled to disabled, or from disabled to enabled, when its button is pushed. See Caution below this table.	The Point Active LED is lit if the corresponding mapped point or zone is active. The Status (trouble) LED is lit if that point or zone is disabled or in trouble. This mode is not for use with an ACS point with no switch, or with a TM-4, UDACT, or smoke control device.
Acknowledge	will act like an Acknowledge soft key or button on the panel, acknowledging an event when its button is pushed.	The Point Active LED is lit when there are any fire alarms in the system. The Status (trouble) LED is lit when there are troubles in the system.
Silence	will act like the Signal Silence button on the panel, silencing all silenceable outputs when its button is pushed.	The Point Active LED is lit if all silenceable outputs have been silenced. The Status (trouble) LED is lit if not all silenceable outputs have been silenced after the button is pushed.
Reset	will act like the System Reset button on the panel, resetting the panel when its button is pushed.	No LED will ever light at this point. This mode is not for use with an ACS point with no switch, or with a TM-4, UDACT, or smoke control device.
Drill	will act like the Drill button on the panel, initiating a fire drill when its button is pushed.	The Point Active LED lights when the button is pushed and the system has entered the drill state. The Status (trouble) LED will never light. This mode is not for use with an ACS point with no switch, or with a TM-4, UDACT, or smoke control device.



**CAUTION:** When a disabled output is enabled, it will be affected by conditions existing in the system that would normally affect it. For example, when a condition exists in the system that would normally turn the output on, the output *will* turn on when it is enabled.

**SOURCE:** Pressing this soft key will select the Source field and also toggle between display formats if a point value is allowed. Enter a point or zone, or the panel's node number if the mode type is a system function such as acknowledge or reset.

Up to eight sources are allowed when CONTROL mode is chosen.

**ACCEPT:** Press this soft key to save the changes to the point displayed. The next point address will appear.

**BACK:** Press this soft key to exit the screen without saving, and return to the ACS Programming Screen.

## 3.2.8 Supervision

From the Panel Program Menu (1), select SUPERVISION to display the following screen.

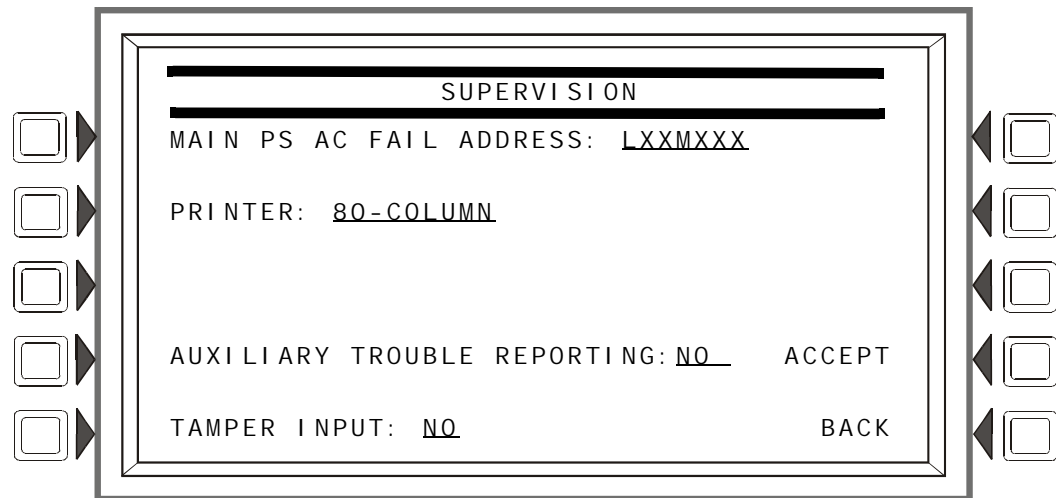

**Figure 3.13 Supervision Screen**

### Soft Keys

**MAIN POWER SUPPLY AC FAIL ADDRESS:** Press to enter the “Monitor AC Fail” (base plus one) address of the main power supply. Refer to the main power supply manual for complete addressing information. Type in the address using the keypad.

The LCD backlight will turn off when this power supply experiences AC failure (see BACKLIGHT in “LCD Programming” on page 26).

**PRINTER:** Press to scroll through the types of printer supervision: NONE, 40-COLUMN, 40-COLUMN SUPERVISED, 80-COLUMN, 80-COLUMN SUPERVISED, 40 GRAPHIC, 80 GRAPHIC, 80 GRAPHIC SUPERVISED. The printer will not be active if NONE is selected. If a SUPERVISED selection is made, the printer will be supervised. Default: NONE

---

 **NOTE:** When changing from an 80-column or 80-column supervised to an 80 graphic or 80 graphic supervised printer (or vice-versa), settings must be changed at the printer. Refer to this panel’s installation manual for the settings.

---

**AUXILIARY TROUBLE REPORTING:** Press to toggle between Yes and No. Choose Yes if a trouble bus cable has been attached at J5 of the JCPU-3030. Default: NO

**TAMPER INPUT:** Press the soft key to toggle between Yes, No, and AKS-1.

Yes/No reports (YES) or does not report (NO) a tamper situation at the panel cabinet door (as determined by an STS-1 tamper switch connected as shown in this panel’s installation manual).

AKS-1 should be selected when there is an AKS-1 key switch connected to the panel cabinet door (which allows the operator to use Signal Silence, Reset, Drill and Acknowledge functions when a key turns the lock to “Enable”). Default: NO

**ACCEPT:** Press to save changes and return to previous menu.

### 3.3 Panel Program Menu (2)

Pressing the MORE soft key at Panel Program Menu 1 displays the Panel Program Menu 2 screen.

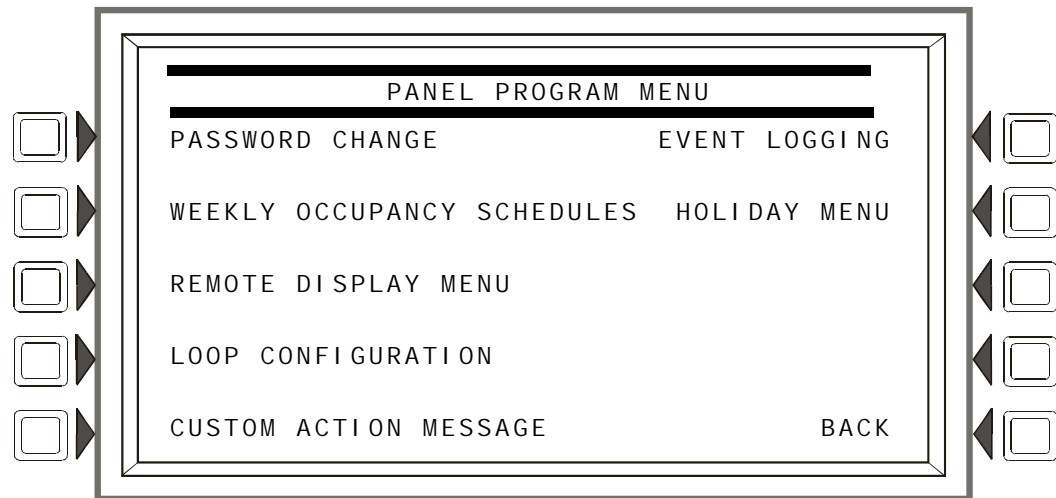

**Figure 3.14 Panel Program Menu 2 Screen**

#### Soft Keys

Press a soft key to bring up the associated menu.

#### 3.3.1 Password Change

Refer to paragraph Figure 1.6.1 on page 12 for information on password change.

#### 3.3.2 Weekly Occupancy Schedule

The user may specify up to ten different schedules; the one displayed when the screen is invoked is the one that is currently in effect.

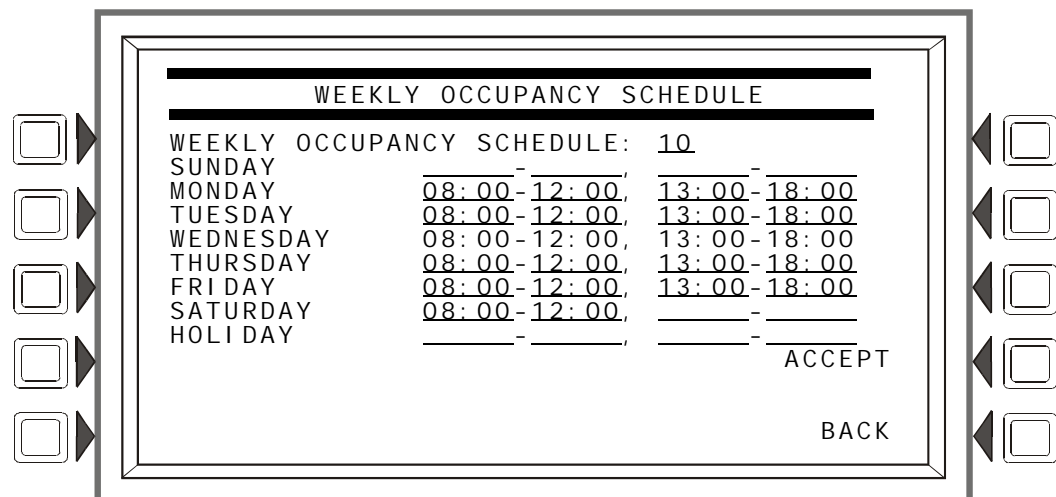

**Figure 3.15 Weekly Occupancy Schedule Screen**

Use the arrow keys on the keyboard to navigate between occupancy time fields: use the keypad to type in the time values.

## SOFT KEYS

WEEKLY OCCUPANCY SCHEDULE: Press this soft key to toggle between schedules 1 - 10. A value of zero indicates no schedule.

ACCEPT: Press this to save changes made on the screen.

### 3.3.3 Remote Display Menu

This screen displays when the REMOTE DISPLAY MENU soft key is pressed at the Panel Programming Menu 2 screen.

**NOTE:** To change the language of the remote display, or to program the panel banner to appear in the remote display, refer to "LCD-160 Download Menu" on page 81.

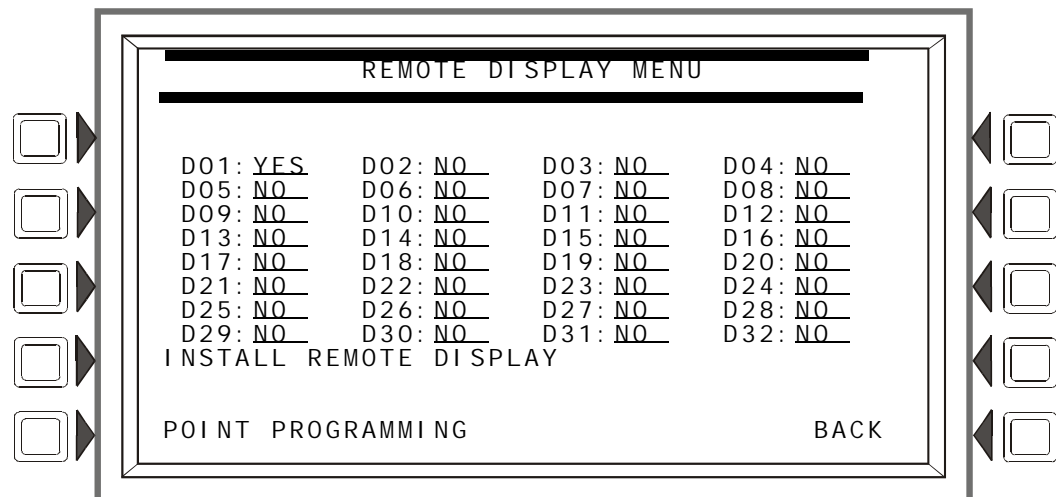

**Figure 3.16 Remote Display Menu Screen**

#### Soft Keys

INSTALL REMOTE DISPLAY: To install a remote display, press the arrow keys to place the cursor on the line next to the remote display address to be installed. Press this soft key until YES displays. Default: No

POINT PROGRAMMING: Once a display has been installed, press this soft key to program the display point.



## Remote Display Point Programming

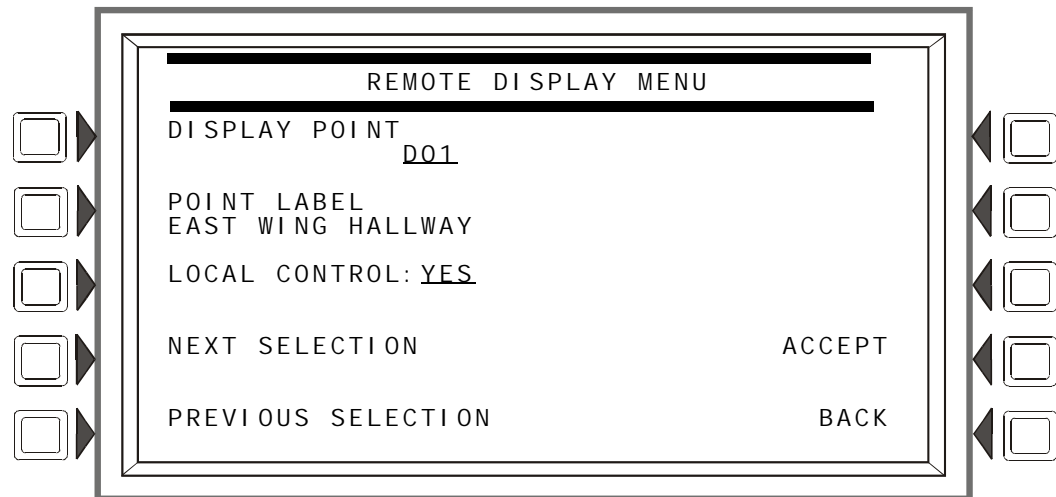

**Figure 3.17 Remote Display Point Programming Screen**

### Soft Keys

DI SPLAY POI NT: Press this soft key to bring the cursor to the underlined field. Use the keypad to type in the desired display address.

POI NT LABEL: Press this soft key to bring the cursor to the underlined label field. Type in a label of up to 40 characters that will appear in trouble messages.

LOCAL CONTROL: Press to toggle between YES and NO. A setting of YES enables local control at the remote display.

## 3.3.4 Loop Configuration

This screen displays when the LOOP CONF I GURATI ON soft key is pressed at the Panel Programming Menu 2 screen. Here the programmer chooses one of the ten possible SLC loops for further definition.

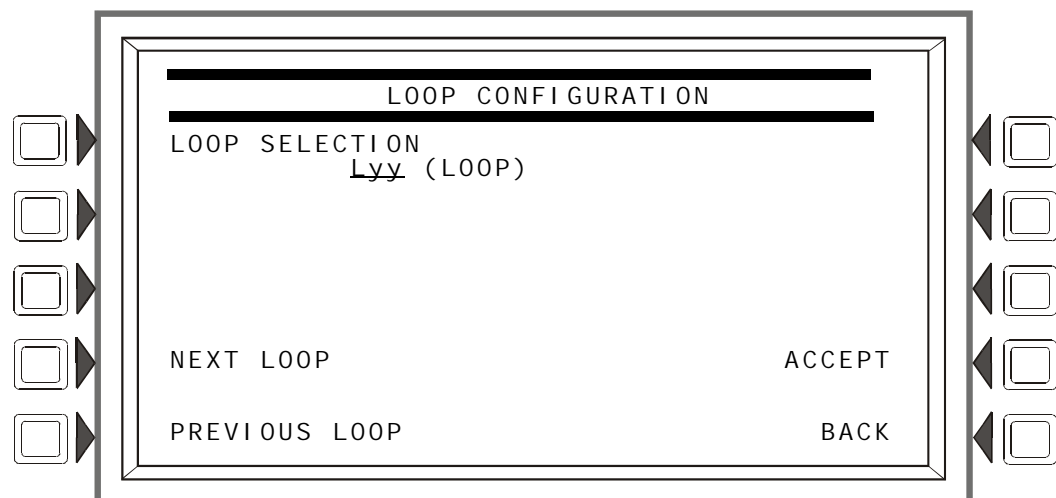

**Figure 3.18 Loop Configuration Screen**

### Soft Keys

POINT SELECT: Pressing this soft key will invoke the cursor at the underlined field. Enter the loop number desired (01 through 10) in the yy of the Lyy format.

NEXT/PREVIOUS SELECTION: Press either key to go forward or back through the loop selections.

ACCEPT: Press to proceed to the Loop Point Programming screen.

### Loop Point Programming

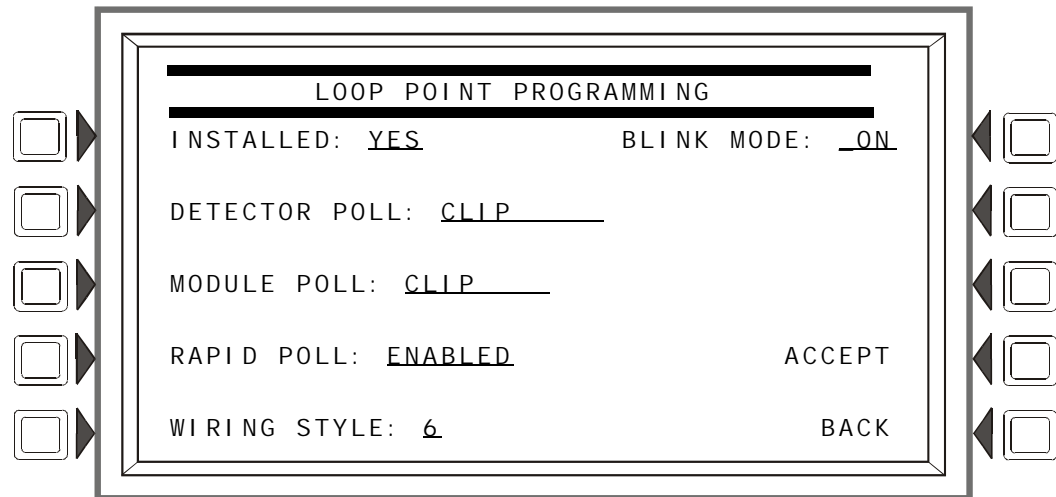

**Figure 3.19 Loop Point Programming Screen**

### Soft Keys

INSTALLED: Press this soft key to choose YES or NO, depending on whether an SLC is installed at this address.

#### FlashScan and CLIP Mode

FlashScan devices can be programmed to run in either CLIP or FlashScan mode. The types can not be mixed on a loop: for example, if Loop 1 is programmed with a FlashScan module poll, CLIP modules may not be used on that loop.

A detector's LEDs will light a steady green for several seconds while it is subjected to a detector test during FlashScan polling. Each detector is tested this way on a regular basis. During the short time the LEDs are on steady, the detector is not providing fire protection.

DETECTOR POLL: Press to select FLASHSCAN or CLIP loop polling.

MODULE POLL: Press to select FLASHSCAN or CLIP loop polling.

RAPID POLL: For CLIP mode only - enable or disable Rapid Poll for CLIP. This feature will poll the first 20 modules more often to speed response on manual pull stations.

WIRING STYLE: Press to select the NFPA wiring style (4 or 6) of the loop. If Style 6 is entered when the wiring is Style 4, a trouble message will be generated at the panel.

BLINK MODE: Press to enable (ON) or disable (OFF) detector LED blinking for this loop.

### 3.3.5 Custom Action Message

A Custom Action Message appears when the MORE I NFORMATI ON soft key is pressed when an event is displayed on the Event Counts screen. This panel supports up to 100 Custom Action Messages.

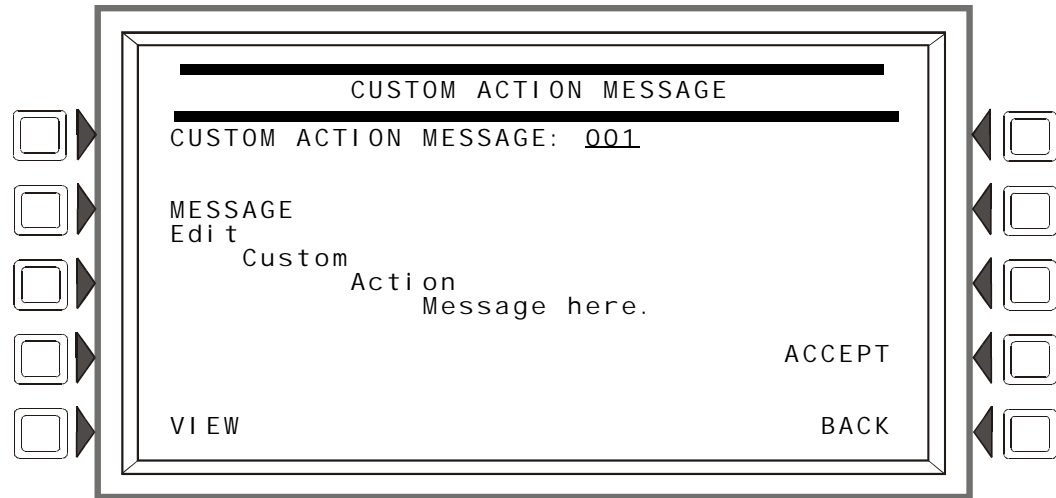

**Figure 3.20 Custom Action Message Screen**

**CUSTOM ACTION MESSAGE:** Enter a number with a value of 001 to 100 to display the corresponding Custom Action Message, or to add or edit a message.

**MESSAGE:** Enter/edit a custom message in the four lines indicated. The message may be up to 160 characters.

**VIEW:** Press this soft key to view the message that corresponds to the number entered in the underlined field.

**ACCEPT:** Press to save any change made to the message and return to the previous screen.



**NOTE:** A printout of all the messages may be obtained by entering the Print Programming Menu (2) and pressing the CUSTOM ACTION MESSAGES soft key.

### 3.3.6 Event Logging

This menu gives the option of logging Non-fire Activations and Output Activations into a history file.

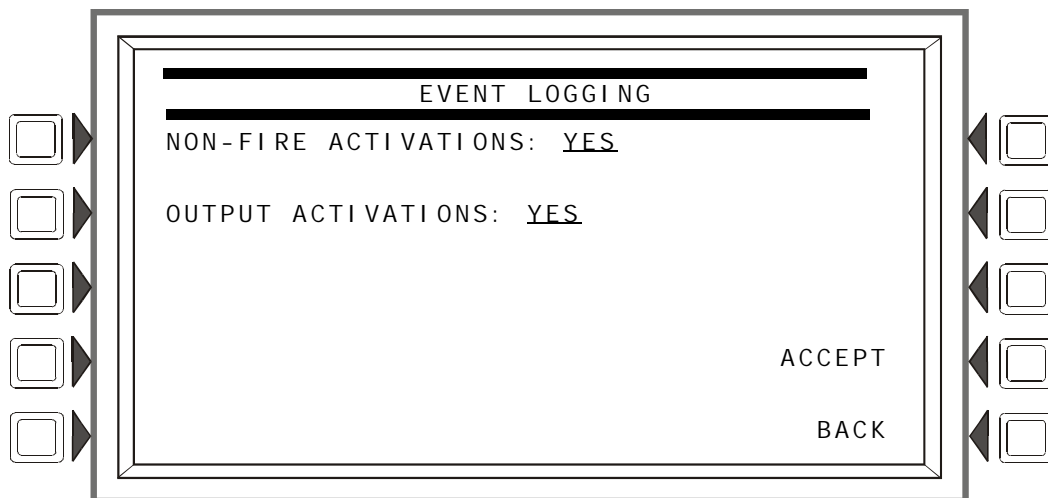

Figure 3.21 Event Logging Screen

Press the appropriate softkey to choose event logging (Yes) and no event logging (No). When Yes is chosen, the activations are logged into history and printed.

### 3.3.7 Holiday Menu

This menu is used to create a list of up to 15 holidays, which are used together with the Occupancy Schedule to determine holiday occupancy hours. For example, the schedule displayed in Figure 3.15, “Weekly Occupancy Schedule Screen” on page 31, Schedule 10, has blank fields in the Holiday row. This Occupancy Schedule defines the schedule for the dates on the Holiday Menu screen below: there will be no occupancy hours on these dates.

The Holiday Menu is displayed when the Holiday Menu soft key is pressed at the Panel Programming (2) Menu.

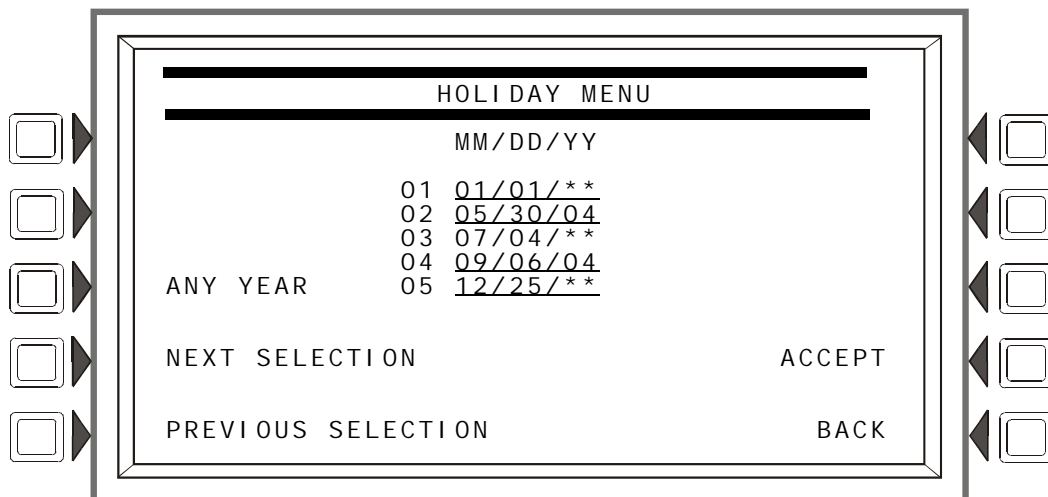

Figure 3.22 Holiday Menu Screen

The cursor will appear in the date fields, and may be moved using the keyboard arrow keys. Type to add/edit any holiday dates.

#### SOFT KEYS

ANY YEAR: Press to place asterisks in the YY section of the field. An asterisk denotes any year.

NEXT/PREVIOUS SELECTION: Press to view the next or previous group of five holidays.

ACCEPT: Press to save changes to the date fields and to return to the Panel Program Menu.

## 3.4 Point Program

The Point Program allows the programmer to enter/change point information for detectors, modules, panel circuits, and general, releasing, logic and trouble zones.

Press the Point Programming Menu soft key of the Program/Alter Status Menu to display the screen below.

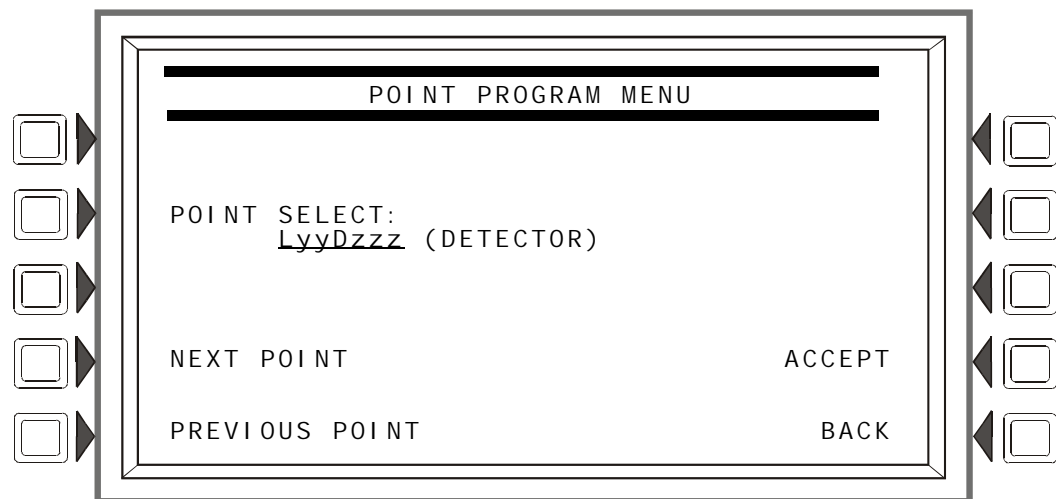

Figure 3.23 Point Program Menu

#### Soft Keys

POINT SELECT: Press until the desired point type appears. The types - detector, module, panel circuit module, general zone, logic zone, trouble zone, or ACS Board - appear in the parenthesis after the point formats. Enter the desired point address in the format field.

ACCEPT: Press to progress to the appropriate screen, based on the type of point selected.

NEXT/PREVIOUS SELECTION: Press to scroll backward or forward to the next or previously installed point.

### 3.4.1 Detector Point

This screen displays when a detector is chosen at the Point Program menu (see Figure 3.23 on page 37).

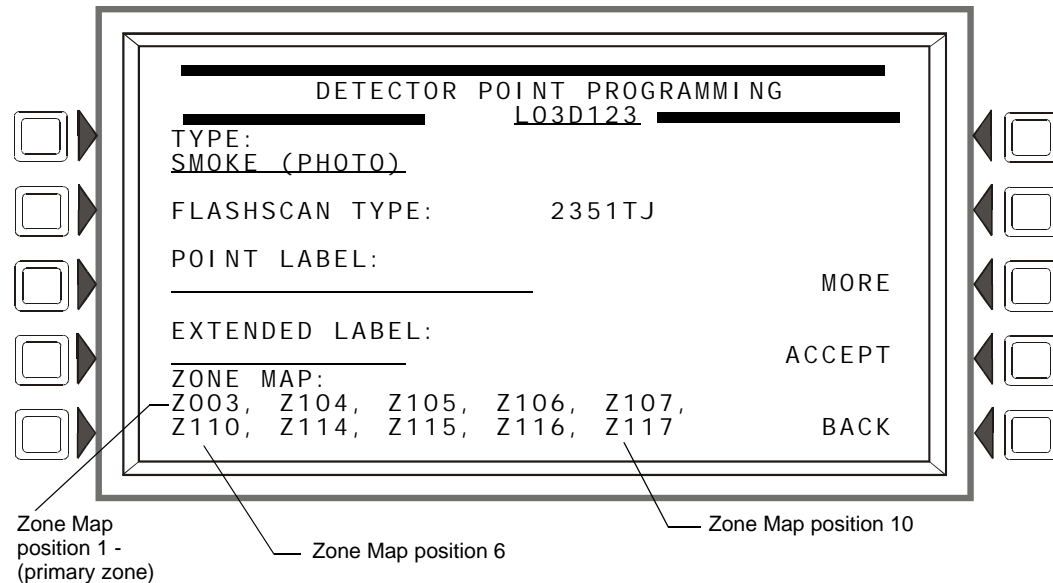

**Figure 3.24 Detector Point Programming Screen**

The point address is displayed in line 3 of this screen. Existing point information is displayed in the fields.

#### Soft Keys

**TYPE:** Press this soft key to scroll through the point type choices: stop at the appropriate selection. If a new point is being added, no other field will be displayed until TYPE: is entered and the ACCEPT soft key is pressed. At this point, the rest of the fields will appear.

**FLASHSCAN CODE LABEL:** Press to scroll through a list of FlashScan Codes. Stop when the appropriate label appears (Table G.4 on page 137 for codes and descriptions). If the detector is not a FlashScan type, choose NONE.

**POINT LABEL:** Press this soft key to place the cursor at this field. Type in a 20-character maximum point label that will appear in message formats. If no entry is made, the field will default to the point address.

**EXTENDED LABEL:** Press to place the cursor at this field. Type in a 12-character maximum extended label to further define the location or nature of the point.

**ZONE MAP:** Displays the zones mapped to this point. During initial programming, zone map position one for each detector is set to ZOYY, where YY represents the loop number where the detector resides. In Figure 3.24 above, zone position one has a value of Z003 (YY = 03). The detector in the example resides on loop 3.

To add or delete zones for this point, press this soft key to progress to the Detector Zone Map screen.

**MORE:** Press this soft key to progress to the next detector point programming screen.

**ACCEPT:** Press to accept changes. If the user is adding a point, pressing this soft key after entering the TYPE field will display all the other fields.

## Zone Map

The Detector Zone Map screen will display when the ZONE MAP soft key is pressed at the Detector Point Programming screen.

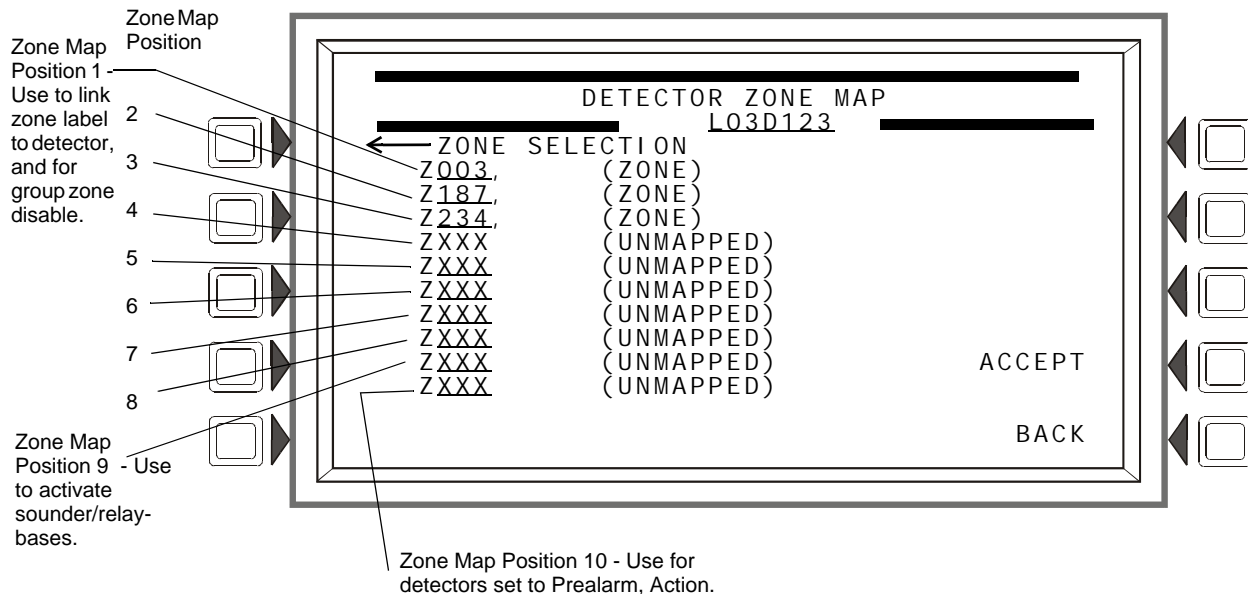

**Figure 3.25 Zone Map (Detector Point) Screen**

The point address will appear in line 3 of the screen.

Refer to “CBE: Zones and Equations” on page 125, and “Special Zone Outputs” on page 113 in this manual for more information about zones and how they apply to Control-By-Event.

### Soft Keys

**ZONE MAP:** A detector may be mapped to up to ten general, releasing, or special zones. There are ten positions available for mapping; positions 1, 9 and 10 - refer to Figure 3.25 - have additional functionality.

**Position 1 -** Use this position to link the 20-character zone label to the detector. The zone label will appear after the 20-character label and 12-character extended label, providing a total of 52 characters to describe an event.

This position is checked when a group zone disable command is issued. If the zone number in the group zone disable command matches the zone number in the first position of the zone map, the detector point will be disabled.

**Position 10 -** Use this position to map detectors with an “Action” Prealarm setting. The zone in the tenth position will activate when the detector reaches its Prealarm threshold; no other zones in this detector’s zone map will activate.

**Position 9 -**

- Use this position to activate the sounder/relay base of a detector. When this position is mapped to the same zone as Position 10, the sounder or relay base will be activated when the detector goes into prealarm (Action).
- Use this position to activate the sounder base of a detector using a general or a logic zone. When a general or logic zone activates, the panel is searched for any detector with the same zone mapped in its 9th position. The sounder base of any detector that matches the search will activate.

Move the cursor with the keyboard arrow keys to the appropriate zone map position, then select the type of type of zone by pressing the NEXT SELECTION (+) key until the desired zone type appears. Type in a zone number to map the detector to it.

ACCEPT: Press to save entries made on this screen and return to the Detector Point Programming screen.

## Detector Point Programming (2)

Press the MORE soft key on the Detector Point Programming screen to display this screen.

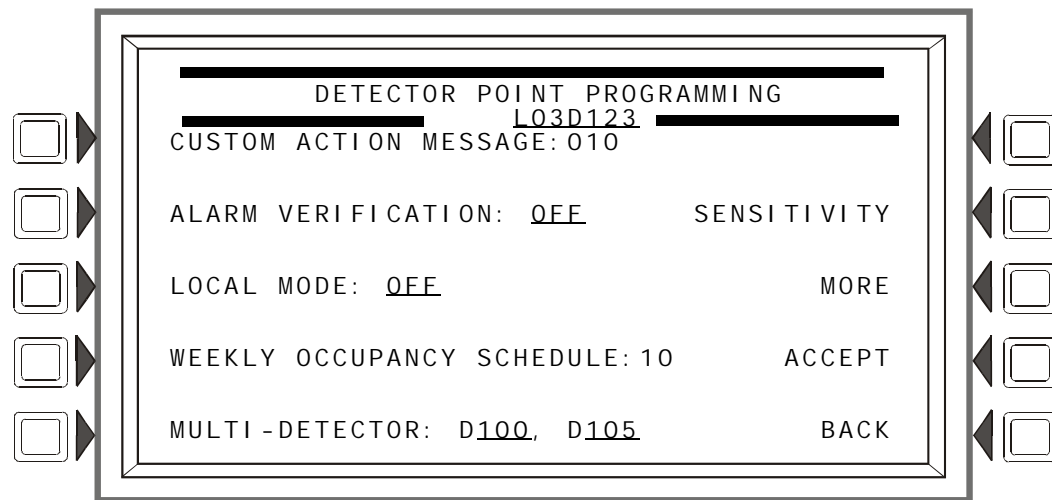

**Figure 3.26 More Detector Point Programming (2) Screen**

### Soft Keys

**CUSTOM ACTION MESSAGE:** Displays the custom action message number (a value of one through 100). The default value is 0 (no message). Press this soft key to progress to the Custom Action Message screen (Figure 3.27) to view the message or to choose a different message for viewing when this point activates. (To create a new custom action message, refer to “Custom Action Message” on page 35.)

**ALARM VERIFICATION:** Press this key to determine the device’s participation in Alarm Verification. Choosing Yes will set the device participation to the values entered at the Panel Timers screen (Figure 3.8).

**LOCAL MODE:** Press to toggle between Local Mode (ON) or no Local Mode (OFF). When there is a communication loss between the panel and its LCM/LEMs, SLC devices that have been selected for Local Mode participation (ON) will continue to function across all the panel’s SLCs in a limited manner as follows: input points will activate output points of the same Type Code point type designations. For example, SLC inputs with “fire” point types will activate SLC outputs with “fire” point types. Refer to Appendix G, “Type Codes”, on page 133 for type code point types. All SLC detector types can participate in local mode.



**NOTE:** The panel setting LCM LOCAL MODE must be set to Yes for local mode to work at the device level.

**SENSITIVITY:** Press to proceed to the Detector Sensitivity screen.

**WEEKLY OCCUPANCY SCHEDULE:** To choose an existing weekly occupancy schedule, press this soft key to proceed to the Detector Occupancy Schedule screen. Refer to “Weekly Occupancy Schedule” on page 31 for information on how to set up a schedule.

**MULTI-DETECTOR:** This detector can be linked with up to two detectors at other addresses on the same loop in cooperative multi-detector sensing if entries are made in these fields. The detectors need not be sequential in their addresses. Refer to the section on Cooperative Multi-Detector Sensing in Appendix D, “AWACS™ Applications” for a description of this function.

**MORE:** Press this soft key to progress to the next detector point programming screen.



### Custom Action Message

Press the Custom Action Message soft key on the Detector Point Programming screen to display this screen. The user may choose a Custom Action Message at this screen.

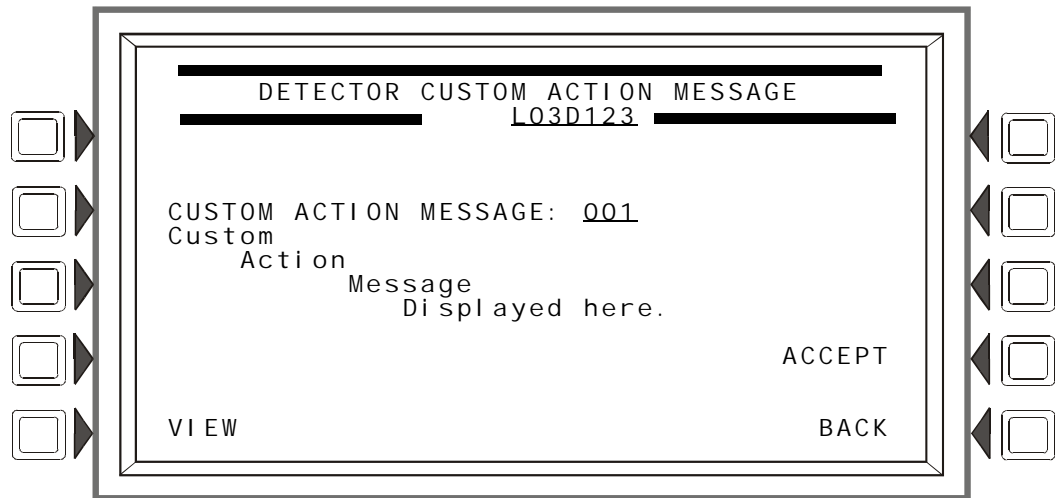

**Figure 3.27 Custom Action Message Screen**

#### Soft Keys

**CUSTOM ACTION MESSAGE:** Enter the number of the Custom Action Message to be displayed during alarm conditions for this point (refer to Figure 3.20 for an example).

**VIEW:** Press this soft key to view the message associated with the number entered.

**ACCEPT:** Press to save the entries made on this screen.

#### ■ Sensitivity

Detector sensitivity levels for alarm and prealarm are set at this screen, which displays when the SENSITIVITY soft key is pressed at the Detector Point Programming (2) screen.

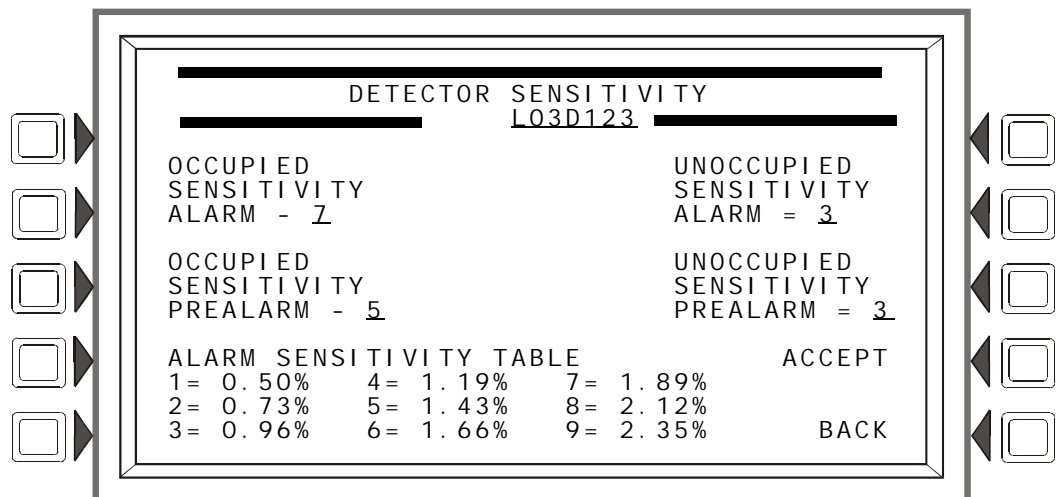

**Figure 3.28 Detector Sensitivity Screen**

The control panel provides nine levels of Prealarm and Alarm in percent per foot obscuration, with the following two exceptions:

- for heat detectors, the settings are to degrees Centigrade.
- for beam detectors, there are only six levels of Alarm. There is no Prealarm for beam detectors in CLIP mode.

Alarm sensitivity settings range from one to nine, with one representing the most sensitive alarm level and nine the least sensitive.

Prealarm sensitivity settings range from zero to nine. Zero indicates no prealarm. A value of one can be a self-optimizing setting where the control panel selects a suitable prealarm level for the detector. Values one or two through nine represent decreasing sensitivity, with nine being the least sensitive.

Refer to the section “Detector Sensitivity Settings” in Appendix D, “AWACST<sup>TM</sup> Applications” for a full description and a table of the nine sensitivity levels by detector type.

**Soft Keys**

OCCUPIED SENSITIVITY ALARM:  
 OCCUPIED SENSITIVITY PREALARM:  
 UNOCCUPIED SENSITIVITY ALARM:  
 UNOCCUPIED SENSITIVITY PREALARM:

Press the soft key next to these setting categories to enter values as described above.

ALARM SENSITIVITY TABLE: This table will toggle from ALARM to PREALARM based on which sensitivity value is being entered. The table will display the values for this type of detector.

■ **Detector Occupancy Schedule**

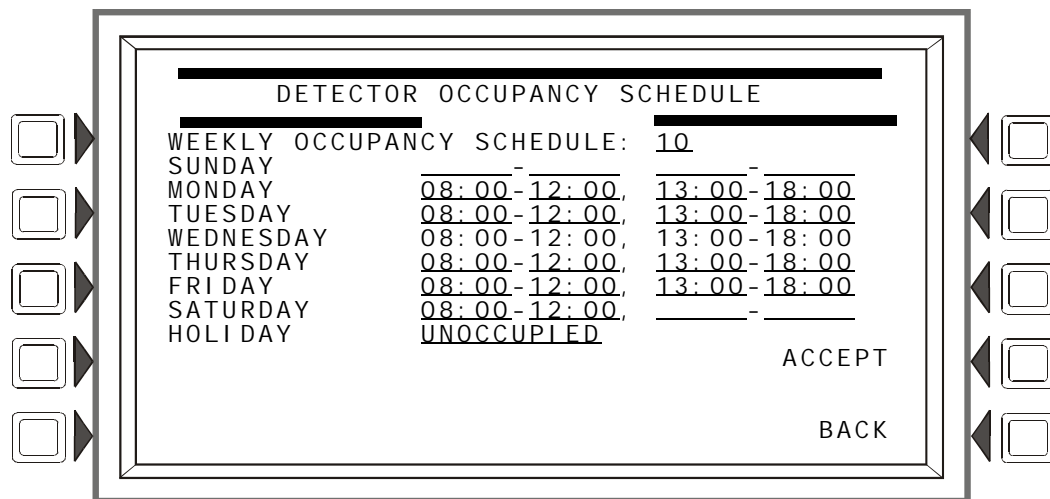

**Figure 3.29 Detector Occupancy Schedule Screen**

**Soft Keys**

WEEKLY OCCUPANCY SCHEDULE: Press this soft key to place the cursor at the underlined field. There can be up to ten Weekly Occupancy Schedules. Enter a value of zero through ten. Zero indicates no schedule is applied, and occupied detector sensitivity values are used.

ACCEPT: Press this key to accept the change made and return to the previous screen.

### Detector Point Programming (3)

Press the MORE soft key on the Detector Point Programming (2) screen to display this screen.

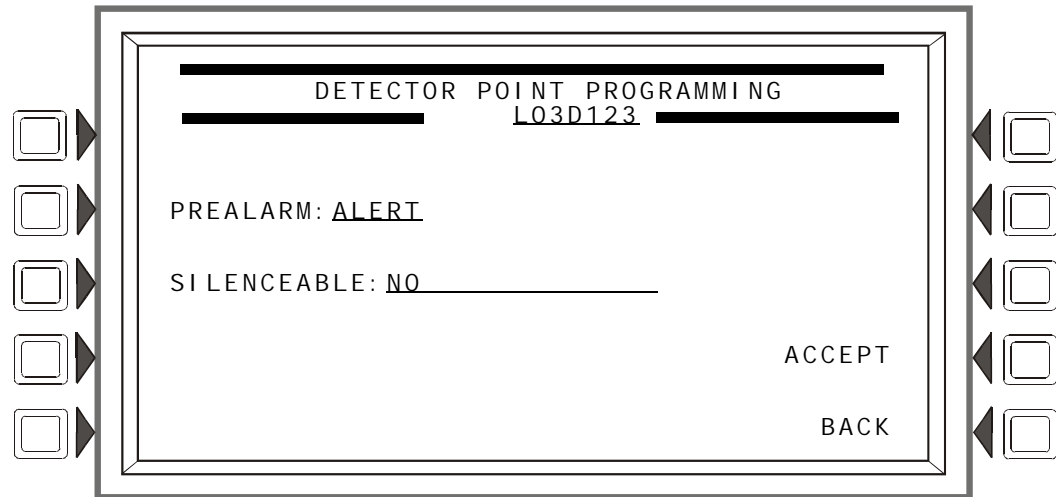

**Figure 3.30 More Detector Point Programming (3) Screen**

#### Soft Keys

**PREALARM:** Press to select ALERT or ACTION for the Prealarm function. Refer to the section on Prealarm in Appendix D, “AWACS™ Applications” for a description of Alert and Action.

**SILENCEABLE:** This field determines whether the user can manually silence a detector’s activated sounder/relay base. Values are as follows:

NO	Not manually silenceable	
YES - RESOUND FIRE	Silenceable, resound on fire alarm events	Network and Local Resound
YES - RESOUND SUPERV	Silenceable, resound on supervisory events	Network and Local Resound
YES - NO RESOUND	Silenceable, does not resound	

### 3.4.2 Module Point

Module point programming screens will display if a module point address is entered at the Point Programming Menu (see Figure 3.23 on page 37).

**Module Point Programming (1)**

```

MODULE POINT PROGRAMMING
LO3M123
MODULE TYPE: MONITOR
TYPE CODE LABEL: HEAT_DETECT
FLASHSCAN CODE LABEL: M300MJ MORE
POINT LABEL:
MONITOR LO3M123 ACCEPT
EXTENDED LABEL:
BACK

```

**Figure 3.31 Module Point Programming (1) Screen****Soft Keys**

**MODULE TYPE:** Press the soft key to toggle between CONTROL and MONI TOR.

**TYPE CODE LABEL:** Press this soft key to scroll through the point type choices: stop at the appropriate selection.

**FLASHSCAN CODE LABEL:** Press this soft key to scroll through the point type choices: stop at the appropriate selection (Table G.4 on page 137 for codes and descriptions). Choose NONE if the point type is not FlashScan.



**NOTE:** If the point is not installed, MODULE TYPE: , TYPE CODE LABEL: , and FLASHSCAN CODE LABEL: must be entered before any entries can be saved using the ACCEPT key.

**POI NT LABEL:** Press this soft key to place the cursor at this field. Type in a 20-character maximum point label that will appear in message formats. If no entry is made, the field will default to the point address.

**EXTENDED LABEL:** Press to place the cursor at this field. Type in a 12-character maximum extended label to further define the location or nature of the point.

**MORE:** Press to proceed to the next screen for more point programming.

**ACCEPT:** Press to save entries made on this screen.

**Module Point Programming (Monitor Module)**

Pressing the MORE soft key at the Module Point Programming screen will display this screen if the module type was monitor.

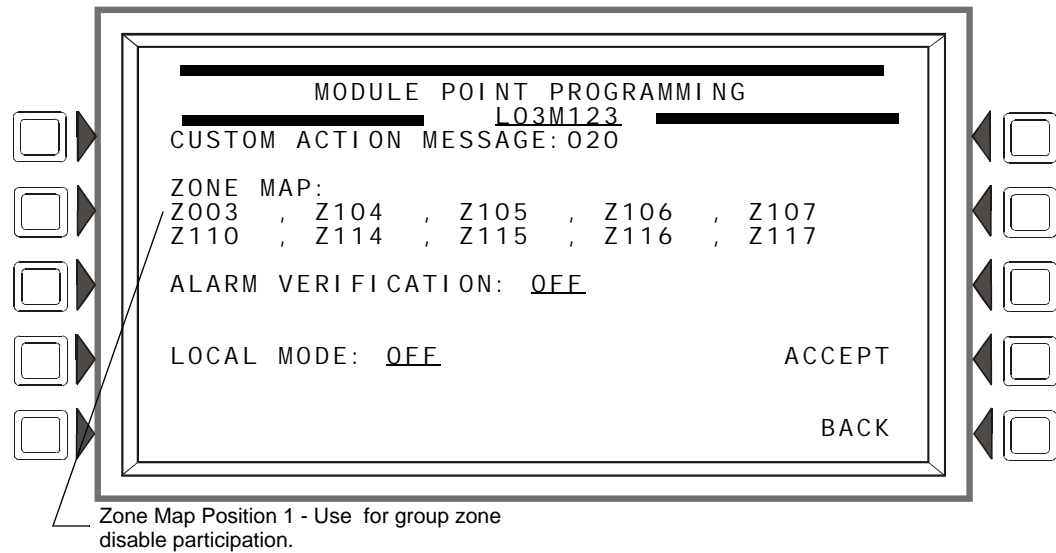

**Figure 3.32 Module Point Programming Screen 2 (Monitor)**

### Soft Keys

**CUSTOM ACTION MESSAGE:** Displays the custom action message number (a value of one through 100). The default value is 0 (no message). Press this soft key to progress to the Custom Action Message screen (shown in Figure 3.27) to view the message or to choose a different message for viewing when this point activates. (To create a new custom action message, refer to “Custom Action Message” on page 35.)

**ZONE MAP:** Displays the zones mapped to this point. During initial programming, zone map position one for each monitor module is set to Z0YY, where YY represents the loop number where the module resides. In Figure 3.32 above, zone position one has a value of Z003 (YY = 03). The module in the example resides on loop 3.

To add or delete zones, press this soft key to proceed to the Module Zone Map screen. Refer to “Zone Map” on page 39 for an illustration and explanation of the Detector Zone Map screen. The Module Zone Map screen is the same except that Module replaces Detector in the title and the module address appears instead of the detector address. Up to ten general, releasing or special zones may be mapped to a monitor module: none of the zone map positions are fixed. Position 1 has additional functionality.

**Position 1 -** This position is checked when a group zone disable command is issued. If the zone number in the group zone disable command matches the zone number in the first position of the zone map, the module point will be disabled.

**ALARM VERIFICATION:** Press this key to determine participation in Alarm Verification. Choosing Yes will set the device participation to the value entered at the Panel Timers screen (Figure 3.8). The only module type that can participate in alarm verification is the M302MJ.

**LOCAL MODE:** Press to toggle between Local Mode (ON) or no Local Mode (OFF). When there is a communication loss between the panel and its LCM/LEMs, SLC devices that have been selected for Local Mode participation (ON) will continue to function across all the panel’s SLCs in a limited manner as follows: input points will activate output points of the same Type Code point type designations. For example, SLC inputs with “fire” point types will activate SLC outputs with “fire” point types. Refer to “Type Codes for Input Devices” on page 134 for Type Code point types. Default: OFF



**NOTE:** The panel setting LCM LOCAL MODE must be set to Yes for local mode to work at the device level.

**ACCEPT:** Press to save entries made on this screen and to return to the previous screen.

### Module Point Programming (Control Module)

Pressing the MORE soft key at the Module Point Programming screen will display this screen if the module type was control.

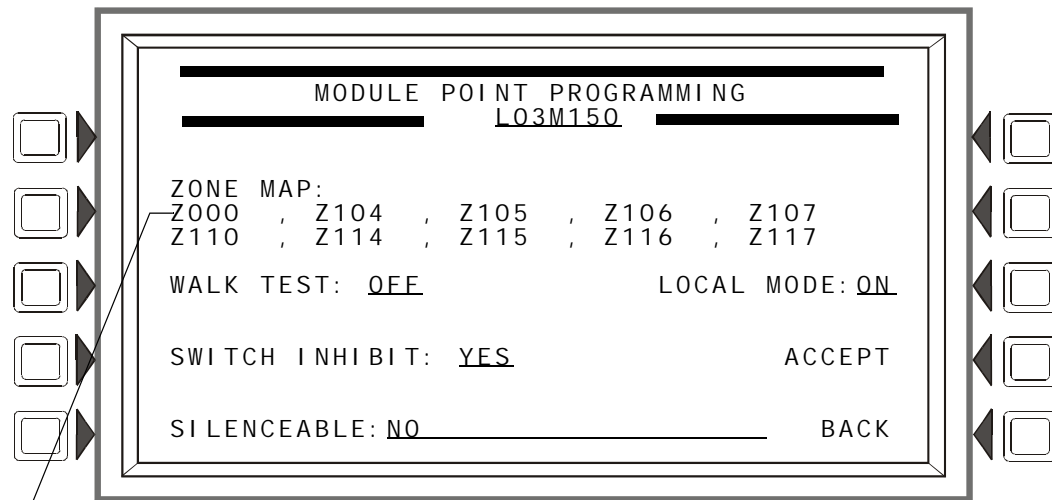

Zone Map Position 1 - Use for group zone disable participation.

**Figure 3.33 Module Point Programming Screen 2 (Control)**

#### Soft Keys

**ZONE MAP:** Displays the zones mapped to this point. The default value assigned to control modules during initial programming is Z000 at Position 1 (refer to Figure 3.33), with the exception of control modules with the following Type IDs: Telephone, Gen Alarm, Gen Supervis, Gen Trouble, and Trouble Pend.

To add or delete zones, press this soft key to proceed to the Module Zone Map screen. Refer to “Zone Map” on page 39 for an illustration and explanation of the Detector Zone Map screen. The Module Zone Map screen is the same except that Module replaces Detector in the title and the module address appears instead of the detector address. Up to ten general, logic, release, special or trouble zones may be mapped to a control module. Position 1 has additional functionality.

**Position 1** - This position is checked when a group zone disable command is issued. If the zone number in the group zone disable command matches the zone number in the first position of the zone map, the module point will be disabled.

Note that the group zone disable command has no effect on general alarm zone Z000.

**WALK TEST:** This field determines if the output will activate during Walk Test. Values are ON (the output will activate) and OFF (the output will not activate). Default: OFF.



**NOTE:** The following Type ID codes do not participate in Walk Test, and the WALK TEST soft key will not appear when the screen displays: REL END BELL, RELEASE CKT, REL CKT ULC, REL. FORM C, REL AUDIBLE, INST RELEASE, NONRESET CTL, TELEPHONE, and FORM-C RESET. The M300MJmodule with SMOKE CONV, HEAT DETECT, or SMOKE DETECT does not participate in Walk Test.

**SWI TCH I NHI BI T:** This field determines whether a user can manually activate an output. Values are YES (can not be activated manually) or NO (can be activated manually). Default: NO

**SI LENCEABLE:** This field determines whether the user can manually silence an activated output. Values are as follows:

<b>NO</b>	<b>Not manually silenceable</b>	
YES - RESOUND FIRE	Silenceable, resound on fire alarm events	Network and Local Resound

YES - RESOUND SUPERV	Silenceable, resound on supervisory events	Network and Local Resound
YES - RESOUND SECURITY	Silenceable, resound on security events	Network and Local Resound
YES - RESOUND TROUBLE	Silenceable, resound for trouble	Local Resound
YES - NO RESOUND	Silenceable, does not resound	



**NOTE:** This soft key will not appear for modules with Type ID codes where silence is not optional.

LOCAL MODE: Press to toggle between Local Mode (ON) or no Local Mode (OFF). When there is a communication loss between the panel and its LCM/LEMs, SLC devices that have been selected for Local Mode participation (ON) will continue to function across all the panel’s SLCs in a limited manner as follows: input points will activate output points of the same Type Code point type designations. For example, SLC inputs with “fire” point types will activate SLC outputs with “fire” point types. Refer to “Type Codes for Input Devices” on page 134 for Type Code point types. Default: OFF



**NOTE:** The panel setting LCM LOCAL MODE must be set to Yes for local mode to work at the device level.

### 3.4.3 Panel Circuit Module

There are three panel circuits on the FACP, and each circuit can accommodate up to four panel circuit modules that have eight push-button switches apiece. The switches can be programmed as input or output points, depending on the module type.



**WARNING:** When using alarm verification, do not mix fire alarm points with non-fire alarm points on the same IZM-8RK/IZE-A Initiation Zone Module.

The point information is displayed onscreen in the format Pyy.z, where P means panel circuit point, yy is the panel circuit module number (1 through 12), and z is the module push-button number (1-8). Each panel circuit point is assigned an address by the panel depending on its location. Refer to Figure 3.34 below for an illustration of how the panel assigns addresses.

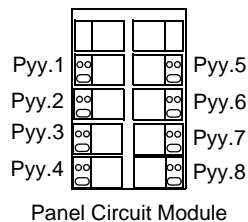

JCPU-3030 Panel Circuit Connection	1st position* module addresses	2nd position module addresses	3rd position module addresses	4th position module addresses
Panel Circuit #1 (J10)	P1.1 - P1.8	P2.1 - P2.8	P3.1 - P3.8	P4.1 - P4.8
Panel Circuit #2 (J11)	P5.1 - P5.8	P6.1 - P6.8	P7.1 - P7.8	P8.1 - P8.8
Panel Circuit #3 (J12)	P9.1 - P9.8	P10.1 - P10.8	P11.1 - P11.8	P12.1 - P12.8

\* The first position is the position closest to the JCPU-3030 connection, the fourth position is the furthest from this connection. These address assignments are fixed; if a panel module is not installed in position 3 of panel circuit #1, the fourth position module still has an address of P4.yy.

**Figure 3.34 Panel Circuit Point Addresses**

## Point Programming (1)

The Panel Circuit Point Programming screen will display if a panel circuit point address is entered at the Point Programming Menu (see Figure 3.23 on page 37 ).

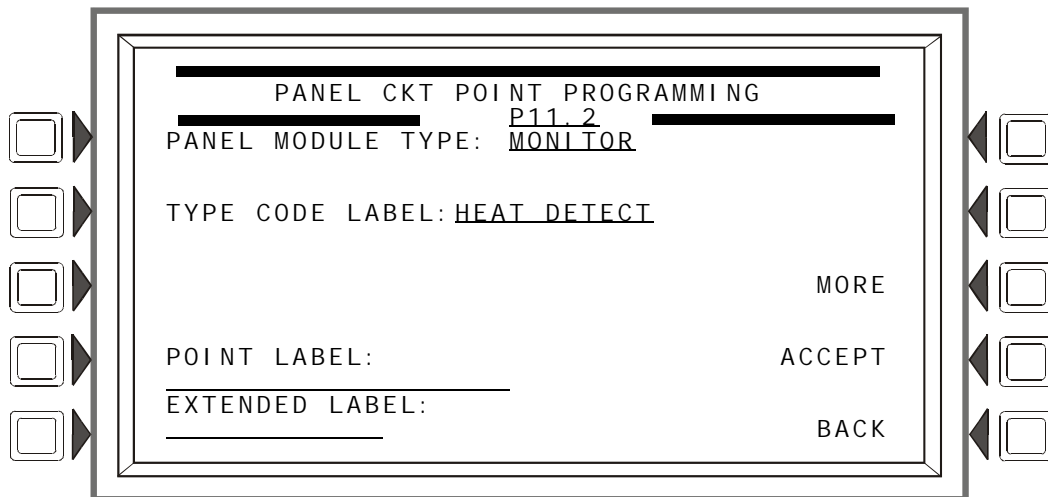

**Figure 3.35 Panel Circuit Point Programming (1) Screen**

### Soft Keys

**PANEL MODULE TYPE:** Press the soft key to toggle between MONI TOR, CONTROL -CRM, CONTROL -I CM. Select MONI TOR for IZM-8RK/IZE-A modules, CONTROL -CRM for CRM-4RK/CRE4 modules, and CONTROL -I CM for ICM-4RK/ICE-4 modules.

**TYPE CODE LABEL:** Press this soft key to scroll through the point Type Code choices: stop at the appropriate selection.

**POI NT LABEL:** Press this soft key to place the cursor at this field. Type in a 20-character maximum point label that will appear in message formats. If no entry is made, the field will default to the point address.

**EXTENDED LABEL:** Press to place the cursor at this field. Type in a 12-character maximum extended label to further define the location or nature of the point.

**MORE:** Press to proceed to the next screen for more point programming.

**ACCEPT:** Press to save entries made on this screen.



## Point Programming (2) - Monitor

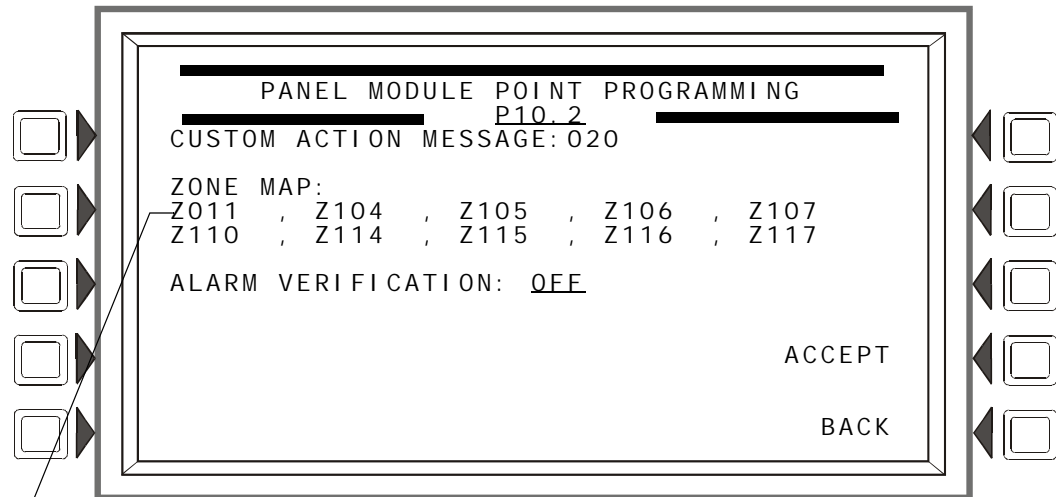

Position 1 - Use for group zone disable participation.

**Figure 3.36 Panel Module Point Programming (2) -Monitor - Screen**

### Soft Keys

**CUSTOM ACTION MESSAGE:** Displays the custom action message number (a value of one through 100). The default value is 0 (no message). Press this soft key to progress to the Custom Action Message screen (shown in Figure 3.27) to view the message or to choose a different message for viewing when this point activates. (To create a new custom action message, refer to “Custom Action Message” on page 35.).

**ZONE MAP:** Displays the zones mapped to this point. The default value assigned to panel circuit input modules during initial programming is Z011 in the first zone map position.

To add or delete zones, press this soft key to proceed to the Panel Module Zone Map screen. Refer to “Zone Map” on page 39 for an illustration and explanation of the Detector Zone Map screen. The Panel Module Zone Map screen is the same except that Panel Module replaces Detector in the title and the module address appears instead of the detector address. Up to ten general, releasing or special zones may be mapped to a panel monitor module. Position 1 has additional functionality.

Position 1 - This position is checked when a group zone disable command is issued. If the zone number in the group zone disable command matches the zone number in the first position of the zone map, the module point will be disabled.

**ALARM VERIFICATION:** Press this key to determine participation in Alarm Verification. Choosing Yes will set the device participation to the value entered at the Panel Timers screen (Figure 3.8).

**ACCEPT:** Press to save entries made on the screen and return to the previous screen.

## Point Programming (2) - Control

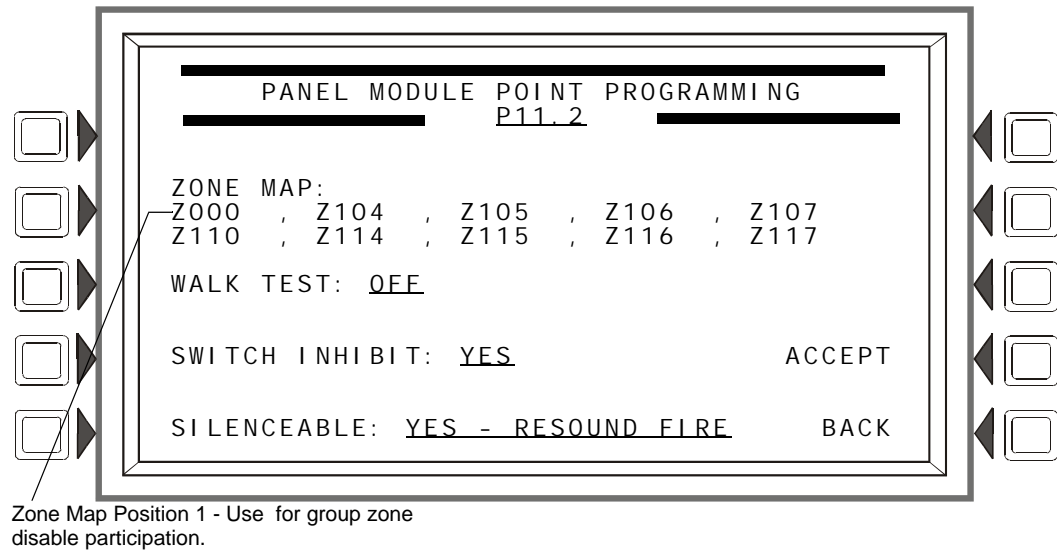

**Figure 3.37 Panel Module Point Programming (2) -Control - Screen**

### Soft Keys

**ZONE MAP:** Displays the zones mapped to this point. The default value assigned to panel circuit output modules during initial programming is Z000, with the exception of control modules with the following Type IDs: Telephone, Gen Alarm, Gen Supervis, Gen Trouble, and Trouble Pend. . To add or delete zones, press this soft key to proceed to the Panel Module Zone Map screen. Refer to “Zone Map” on page 39 for an illustration and explanation of the Detector Zone Map screen. The Panel Module Zone Map screen is the same except that Panel Module replaces Detector in the title and the module address appears instead of the detector address. Up to ten general, logic, release, special or trouble zones may be mapped to a panel control module. Position 1 has additional functionality.

Position 1 - This position is checked when a group zone disable command is issued. If the zone number in the group zone disable command matches the zone number in the first position of the zone map, the module point will be disabled.

Note that the group zone disable command has no effect on general alarm zone Z000.

**WALK TEST:** This field determines if the output will activate during Walk Test. Values are ON (the output will activate) and OFF (the output will not activate). The default is OFF.

---

**NOTE:** The IZM-8RK module does not participate in Walk Test. Also, the following Type ID codes do not participate in Walk Test, and the WALK TEST soft key will not appear when the screen displays: REL END BELL, RELEASE CKT, REL CKT ULC, RELEA.FORM C, REL AUDIBLE, INSTANT RELE, NONRESET CTL, and TELEPHONE.

---

**SILENCEABLE:** This field determines whether the user can manually silence an activated output. Values are YES - RESOUND FIRE (manually silenceable, resounds on fire alarm) and NO (not manually silenceable). The default is YES.

---

**NOTE:** This soft key will not appear for modules with Type ID codes where silence is not optional.

---

**SWITCH INHIBIT:** This field determines whether a user can manually activate an output. Values are YES (can not be activated manually) or NO (can be activated manually). The default is NO.

### 3.4.4 General Zone

This screen displays when a general zone is chosen at the Point Program menu (see Figure 3.23 on page 37).

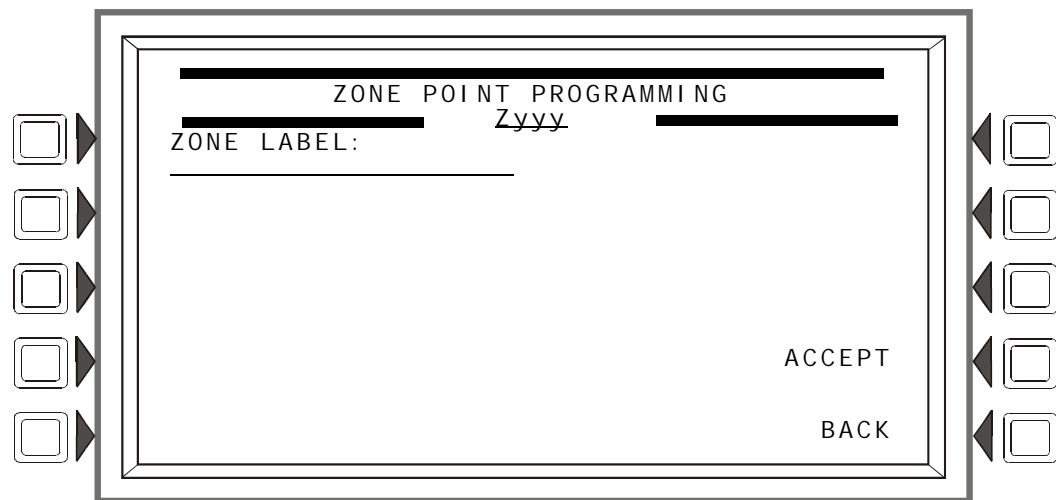

**Figure 3.38 Zone Point Programming Screen**

#### Soft Keys

**ZONE LABEL:** Press to type in a 20-character maximum zone description that will appear in the zone's display messages.

**ACCEPT:** Press to save the message and return to the previous screen.

### 3.4.5 Releasing Zone

#### Releasing Zone Programming

This screen displays when a releasing zone is chosen at the Point Program menu (see Figure 3.23 on page 37).

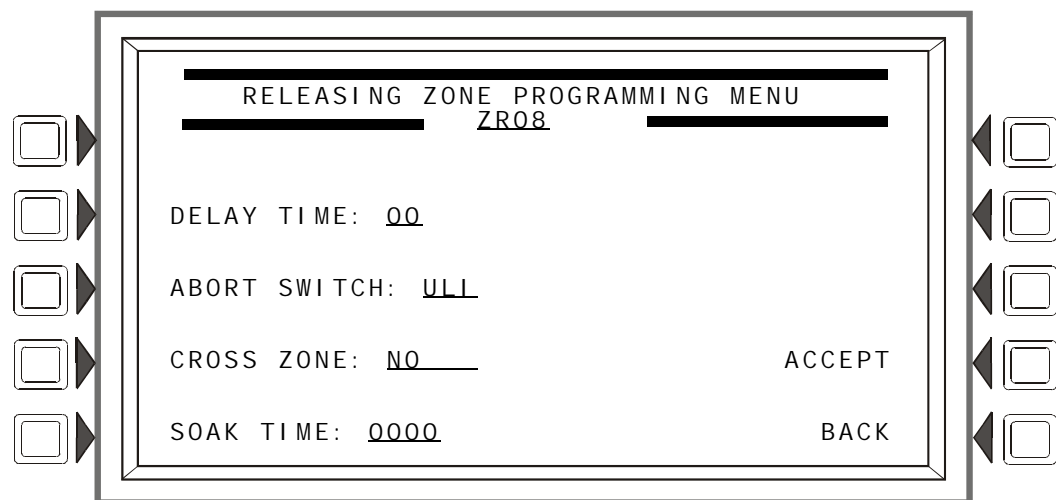

**Figure 3.39 Releasing Zone Programming Menu Screen**

Refer to Appendix B, “Releasing Applications” for a full explanation of the fields below.

### Soft Keys

DELAY TIME: Press this soft key to type a value from 0 to 60 (seconds). Default 00

ABORT SWITCH: Press this soft key to scroll through the selection list of ULI, IRI, NYC, or AHJ. Default:ULI

CROSS ZONE: Press to scroll through the selection list of YES, NO, ZONE, HEAT. Default: NO.

SOAK TIME: Press to type a value from 0 to 9999 (seconds). Default: 0000

## 3.4.6 Logic Zone

### Logic Zone Programming

This screen displays when a logic zone is entered at the Point Programming Menu (see Figure 3.23 on page 37).

The logic equation for that zone will display in line 6. Line 4 indicates the current state of the logic zone (ON or OFF). If there is no equation at the logic zone number entered, nothing will display in lines 4 and 6, and the user must press the EDIT EQUATION soft key to proceed to the next screen and enter an equation.

Refer to Appendix E, “CBE: Zones and Equations” for information on how to create a logic equation, and how logic equations operate.

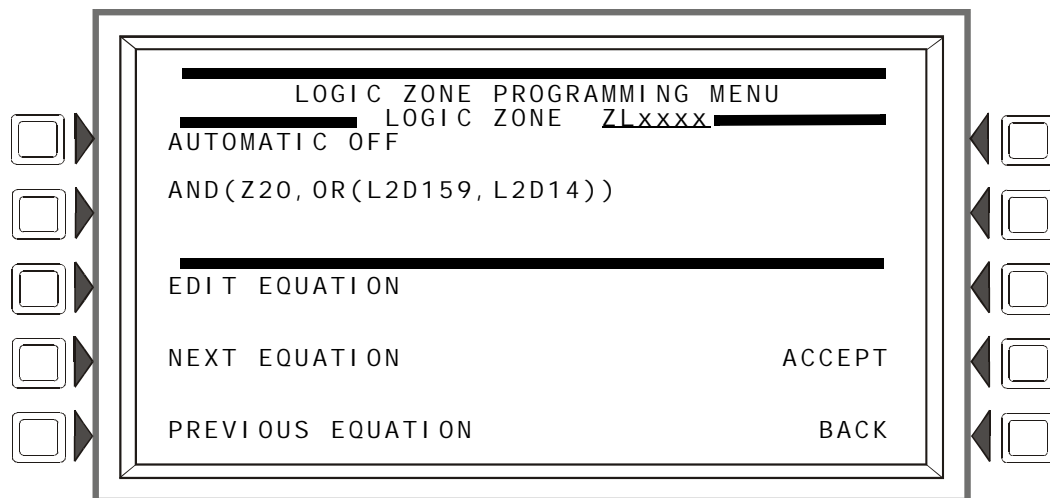

**Figure 3.40 Logic Zone Programming Menu Screen**

### Soft Keys

EDIT EQUATION: Press to proceed to the edit screen to add or edit a logic equation.

NEXT/PREVIOUS EQUATION: Press to view the next or previous logic equation.

## Edit Logic Equation

This screen displays when the EDIT EQUATION soft key is pressed on the Logic Zone Programming Menu.

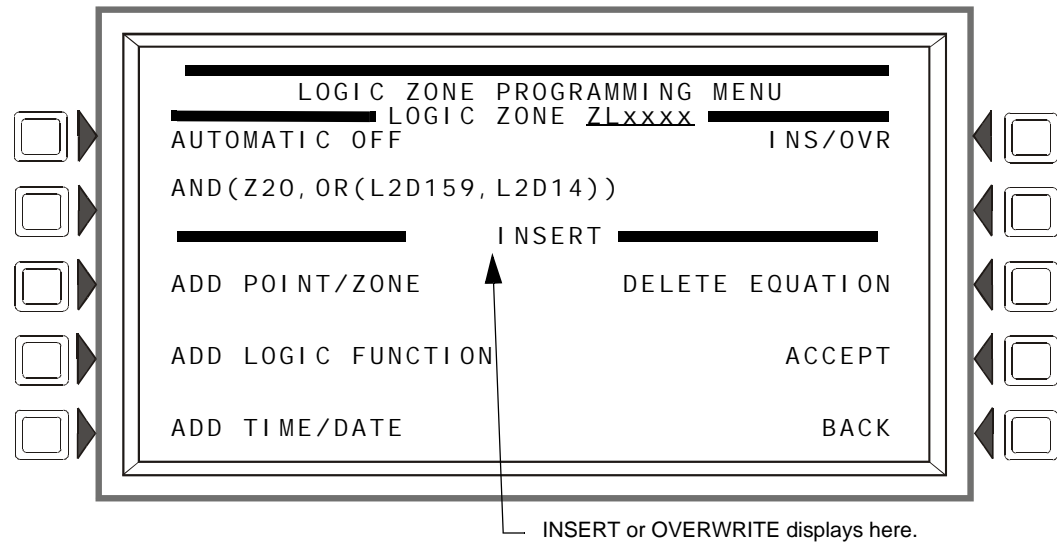

**Figure 3.41 Edit Logic Equation Screen**

The cursor will be present in the equation, and can be moved by pressing the left/right arrow keys on the keyboard. To add or delete information, use the INS/OVR soft key function described below. Use the keypad to type in an equation. The ADD POINT/ZONE and ADD LOGIC FUNCTION soft keys may be used to facilitate creating a logic equation; however, commas must be added by using the keypad.

### Soft Keys

**INS/OVR:** Press to toggle between insert and overwrite. Stop at the appropriate mode, which displays in line 8 of the screen. Insert will add information to the equation, overwrite will write over information already in the equation.

**ADD POINT/ZONE:** Press to proceed to the Add Point/Zone screen. This screen is an alternative to typing in the information at this screen; it provides point and zone formats that make it less likely for typographical errors to occur.

**ADD LOGIC FUNCTION:** Press to proceed to the Add Logic Function screen. This screen is an alternative to typing in the information at this screen; it provides logic function formats that make it less likely for typographical errors to occur.

**ADD TIME/DATE:** Press to proceed to the Add Time/Date screen.

**DELETE EQUATION:** Press to delete the entire equation.

**ACCEPT:** Press to save changes made on this screen and return to the previous screen.



**NOTE:** When the ACCEPT soft key is pressed to save an equation, the panel checks the equation for errors. If there is an error in the equation, the previous screen will not appear, and the cursor will appear at the error point. Correct the equation, and re-press the ACCEPT soft key.

### Add Point/ Zone

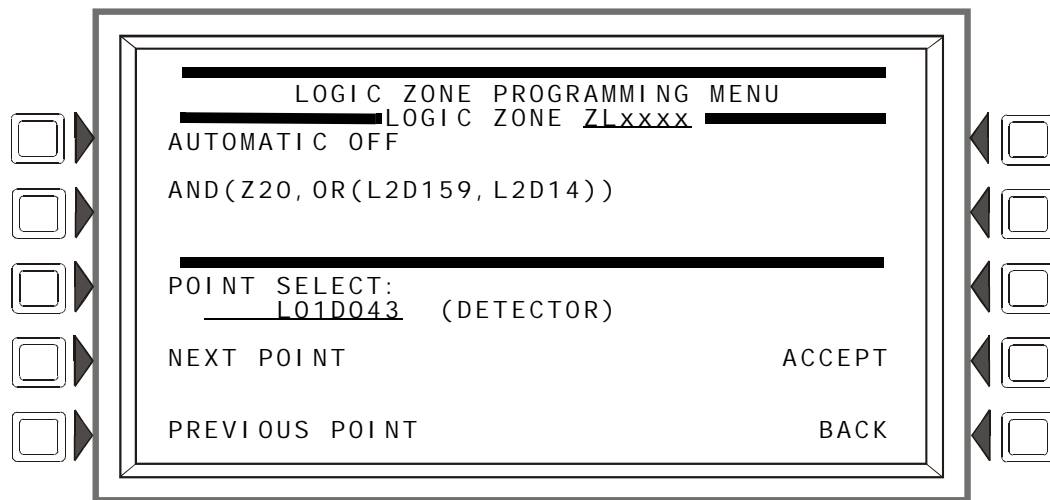

**Figure 3.42 Add Logic Point/Zone Screen**

The cursor will be present in the logic equation. Place it, using the arrow keys on the keyboard, at the place where the additional point should be inserted.

#### Soft Keys

**POINT SELECT:** Press to scroll through the list of possible formats (detector, module, etc.). Stop at the desired format. Type in the address for the additional point.

**ACCEPT:** Press to insert the point into the equation where the cursor is blinking, and to return to the previous screen.

**NEXT/PREVIOUS POINT:** Press these soft keys to scroll forward or backward from the displayed point to the next installed point.

#### Add Logic Function

This screen appears when the ADD LOGIC FUNCTION soft key is pressed at the Logic Zone Programming Menu screen.

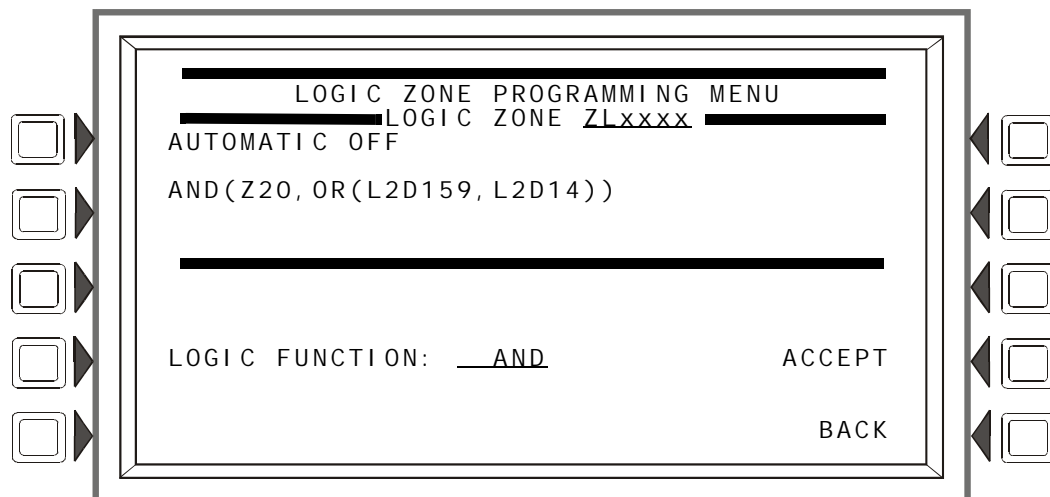

**Figure 3.43 Add Logic Function Screen**

The cursor will be present in the logic equation. Place it, using the arrow keys on the keyboard, at the place where the logic function should be inserted.

**Soft Keys**

LOGIC FUNCTION: Press to scroll through the list of possible logic functions.

ACCEPT: Press to insert the logic function into the equation where the cursor is blinking, and to return to the previous screen.

**Add Time/Date**

This screen appears when the ADD TIME/DATE soft key is pressed at the Logic Zone Programming Menu screen

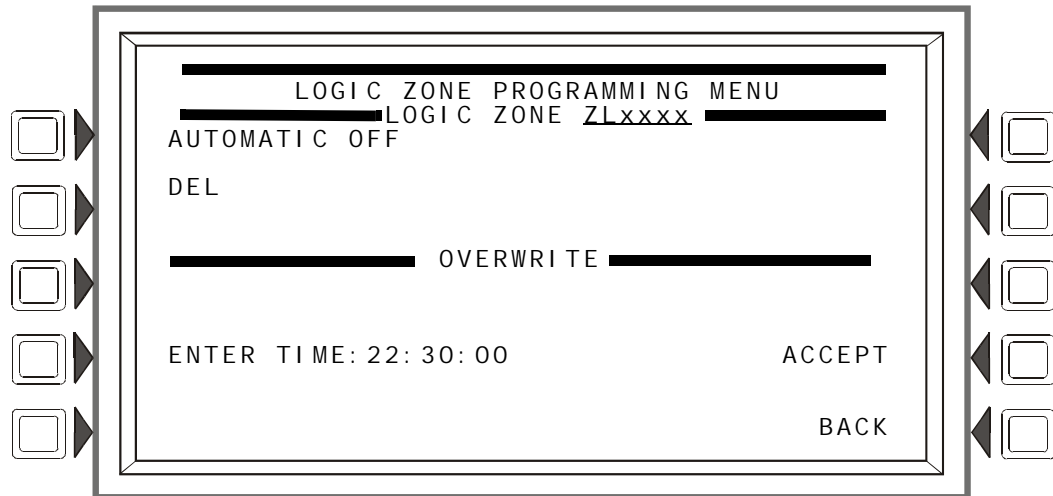

**Figure 3.44 Add Time/Date to Logic Zone Screen**

**Soft Keys**

ENTER TIME: \_\_:\_\_:\_\_ Press this soft key to toggle between the time/date formats. Choose one based on the type of time-based function used.

**Table 3.1**

Time-based function	Screen Field	Time/date format
DEL, SDEL, TIM	ENTER TIME:__:__:__	HH:MM:SS, entered as military time (22:30:00 = 10:30 P.M.)
TIM	ENTER DATE:__-__-__	(MM-DD-YY)
TIM	ENTER DAY: <u>MO</u>	(Use the TOGGLE DAY soft key that appears to scroll through and choose a day of the week.

**3.4.7 Trouble Zone**

**Trouble Zone Programming**

Trouble zones provide a means of using a system trouble input to effect an output. For instance, an annunciator trouble can be used to activate an output device.

The trouble zone format is ZTxxx, where xxx is a number from one through one hundred. When a trouble zone format is entered at the Point Select screen, the same programming screens and choices appear as for logic zones, except the zone format is a trouble zone format. (Refer to paragraphs “Logic Zone Programming” on page 52 and the paragraphs following “Add Time/Date”).

Refer to Appendix E, “CBE: Zones and Equations” for information on how to create a trouble equation, and how they operate.

### 3.4.8 Annunciator Board Label

When ACS BOARD is selected from the Point Program Menu, the ACS Label Menu appears.

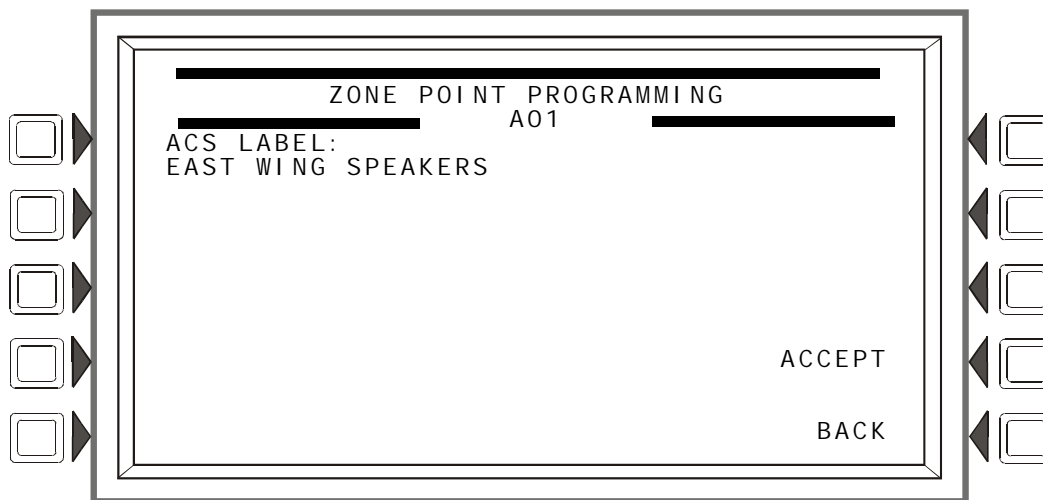

Figure 3.45 ACS Label Menu Screen

#### Soft Keys

ACS LABEL: Type a label for the selected annunciator. The label can have up to 40 characters.

## 3.5 Delete Program

Press the DELETE PROGRAM MENU at the PROGRAM/ALTER STATUS MENU menu to display the screen below.

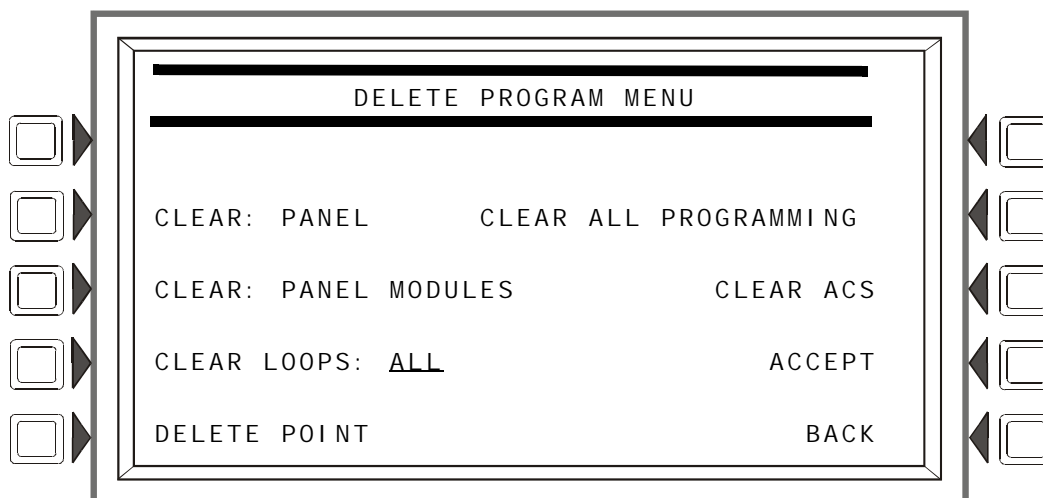

Figure 3.46 Delete Program Menu Screen



### Soft Keys

**CLEAR ALL PROGRAMMING:** Press to remove all panel, panel module, loop, point and ACS programming information, as well as logic and trouble zone equations. Pressing this key removes everything except passwords. A confirmation screen will display asking the user to confirm the deletion command. Pressing this key causes a reboot.

**CLEAR: PANEL** Press to remove all programmed panel setting information from control panel memory. This does not remove ACS programming. A confirmation screen will display asking the user to confirm the deletion command. Pressing this key causes a reboot.

**CLEAR: PANEL MODULES** Press to remove all panel module programming information. A confirmation screen will display asking the user to confirm the deletion command. Pressing this key causes a reboot.

**CLEAR LOOPS** Press to scroll through the options: ALL, LOOP 1, LOOP 2,....., LOOP 10. Stop at the desired option. Press **ACCEPT** to delete all loop programming for the selected option. Pressing this key causes a reboot.

**DELETE POINT** To delete a point, press this soft key to display the Delete Point screen. Pressing this key may cause a reboot.

**CLEAR ACS:** Press to remove all ACS programming from panel memory. A confirmation screen will display asking the user to confirm the deletion command. Pressing this key causes a reboot.

**ACCEPT:** Press to clear all programming for the selected loop option for **CLEAR LOOPS**. A confirmation screen will display asking the user to confirm the deletion command.

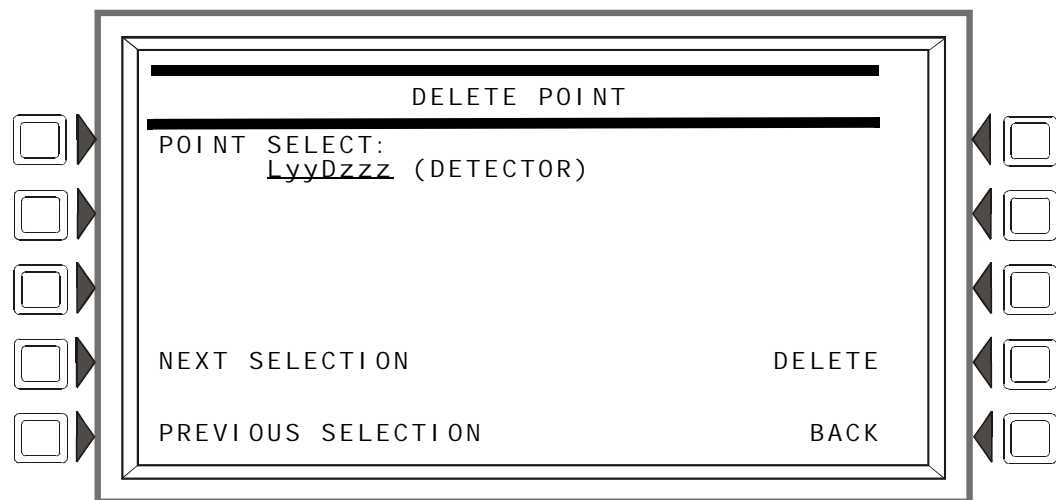

**Figure 3.47 Delete Point Screen**

**POINT SELECT:** Press to scroll through the options: detector, module, or panel module. Stop at the desired option. Press the **DELETE** soft key to delete the point from programming. A confirmation screen will display asking the user to confirm the deletion command.



**NOTE:** Deleting points that are active or in trouble will cause a reboot.

**NEXT/PREVIOUS SELECTION** Press to scroll sequentially to the next or previous point.

## 3.6 Autoprogram Menu

The Autoprogram option identifies addressable devices connected to the control panel. Devices include addressable detectors and modules connected to the panel's SLCs and Panel Circuits. The Autoprogram can be used to create a new program, or to add or remove devices from an existing program. When the points are accepted, they are added to the panel's database with the defaults described in the "Point Programming" section of this manual.

### 3.6.1 To Create a New Program

To successfully create a new program, the FACP must either be new, or have no existing program in memory for the loops or panel circuits involved.

1. Use the Delete Program Menu screen (refer to Figure 3.46) to clear any applicable programming from the panel. For example, if loops one and two are to be autoprogrammed, clear the programming that exists by entering 1+2 at the Delete Program Menu screen.
2. Install SLCs (loops 1+2 in this example) using the Loop Programming screen (Figure 3.19) (panel circuits do not require this step).
3. Press the AUTOPROGRAM LOOPS soft key and enter the desired SLCs (loops 1+2 in this example), or select AUTOPROGRAM PANEL MODULES in the Autoprogram Menu screen (Figure 3.48)
4. Press the ACCEPT soft key to run the Autoprogram.

### 3.6.2 To Add/Delete Devices from the Program

When using the Autoprogram option with an existing program, the control panel does not change program information for installed and programmed devices.

5. If devices are to be added to a new SLC (an SLC that is not in the program), that SLC must be installed using the Loop Programming screen (Figure 3.19).
6. Physically install/uninstall the SLC devices or panel circuit modules.
7. Press the AUTOPROGRAM LOOPS or the AUTOPROGRAM PANEL CIRCUITS soft key to run the Autoprogram. Existing information will not be changed.

Autoprogram will find the devices/modules on the selected installed SLCs/panel circuits. It will compare the information it finds during autoprogramming against any point information that may already be in the database, and it will look for any addressing errors, such as two detectors with the same address. If it finds a discrepancy or error, a screen will be displayed with the discrepant or incorrect information and the programmer will be given the option of changing it.

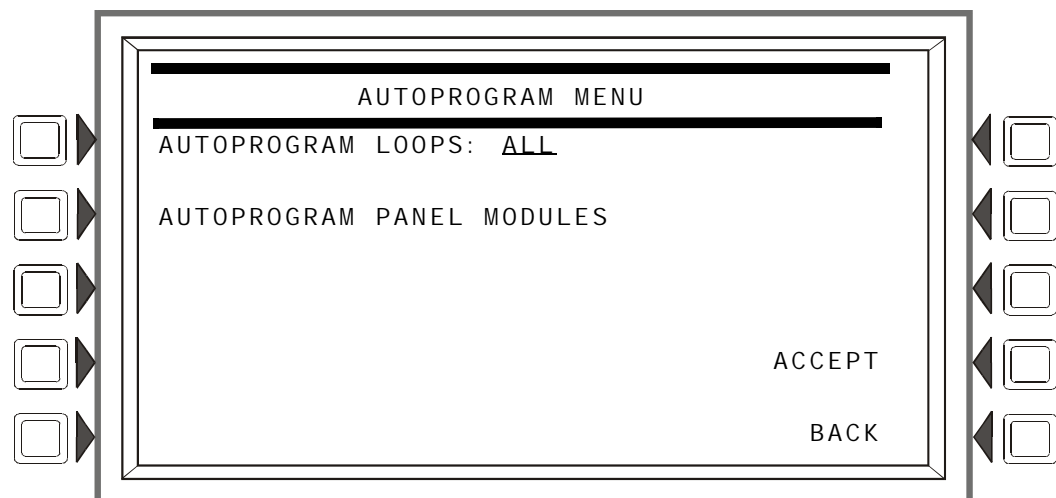

Figure 3.48 Autoprogram Menu Screen

**Soft Keys**

AUTOPROGRAM LOOPS: Press to scroll through the options: ALL, 1+2, 3+4, 5+6, 7+8, 9+10. Stop at the desired option to select it.

AUTOPROGRAM PANEL MODULES: Press to select panel modules for autoprogramming.

ACCEPT: Press to autoprogram the selection. A confirmation screen will display asking the programmer to confirm the autoprogram choice made (press the YES soft key to confirm). A screen with the message AUTOPROGRAM I N PROGRESS will display until autoprogramming is complete.

**3.6.3 Confirmation Screens****SLC and Panel Circuit Statistics**

When autoprogramming is complete, the panel will display a list of the number of modules and detectors found on each SLC, or it will display the number of inputs or outputs found on each panel module. Refer to Figure 3.49 and Figure 3.50 for examples of these screens.

AUTOPROGRAM CONFIRMATION			
LOOP	DETECTORS	MODULES	
1	011	087	
2	030	129	
3	NOT INSTALLED		
4	NOT INSTALLED		
5	NOT INSTALLED		
6	NOT INSTALLED		
7	NOT INSTALLED		
8	NOT INSTALLED		
9	NOT INSTALLED		ACCEPT
10	NOT INSTALLED		ALL
			REVIEW
			BACK

**Figure 3.49 Autoprogram Confirmation Screen (SLCs)**

**Soft Keys**

REVIEW: Press this soft key to review the new devices found (with the option of adding them to the program one by one), devices that are in the database that the autoprogram did not find, devices that have data base and autoprogram information that differs, and devices that are incorrectly doubled up on a single address. Devices will display in the following order:

- L01M001 through L01M159
- L01D001 through L01D159
- L02M001 through L02M159, etc.

Depending on what information was found, different screens may appear for different points. Refer to Figure 3.51 through Figure 3.54 for examples of the screens.

ACCEPT ALL: Press to accept all the new devices that have been found by the autoprogram. Errors and discrepancies will still be displayed the same as if the REVIEW soft key had been pressed: however, new devices will not individually display for review and acceptance.

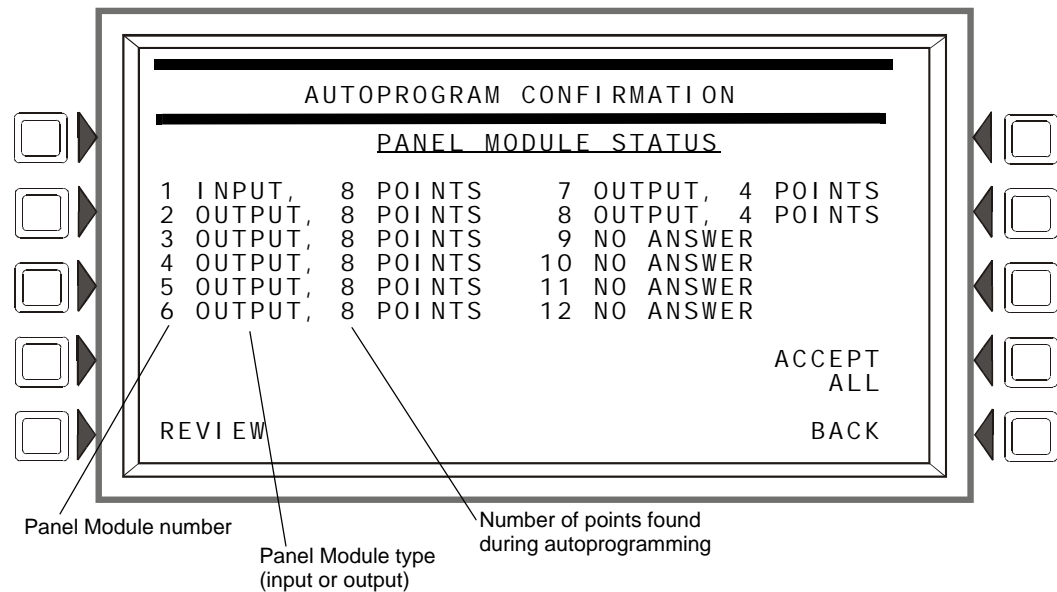

**Figure 3.50 Autoprogram Confirmation Screen (Panel Circuits)**

### Soft Keys

**REVIEW:** Press this soft key to review the new panel modules found (with the option of adding them to the program one by one), modules that are in the database that the autoprogram did not find, and modules that have data base and autoprogram information that differs. Devices will display in the following order: P01 through P12.

Depending on what information was found, different screens may appear for different points. Refer to Figure 3.51 through Figure 3.53 for examples of the screens.



**NOTE:** If panel circuit points have been added, Autoprogram will add them. Pressing the REVIEW soft key does not give the option to review panel circuit points.

**ACCEPT ALL:** Press to accept all the new modules and devices that have been found by the Autoprogram. Discrepancies will still be displayed the same as if the REVIEW soft key had been pressed: however, new devices will not individually display for review and acceptance.

### Add New Points

When the REVI EW soft key is pressed, the panel will individually display each new SLC or panel circuit point found during autoprogramming. The screen below uses an SLC detector point as an example. A new panel circuit point will display “NEW PANEL MODULE FOUND AT PXX” instead of the message below.

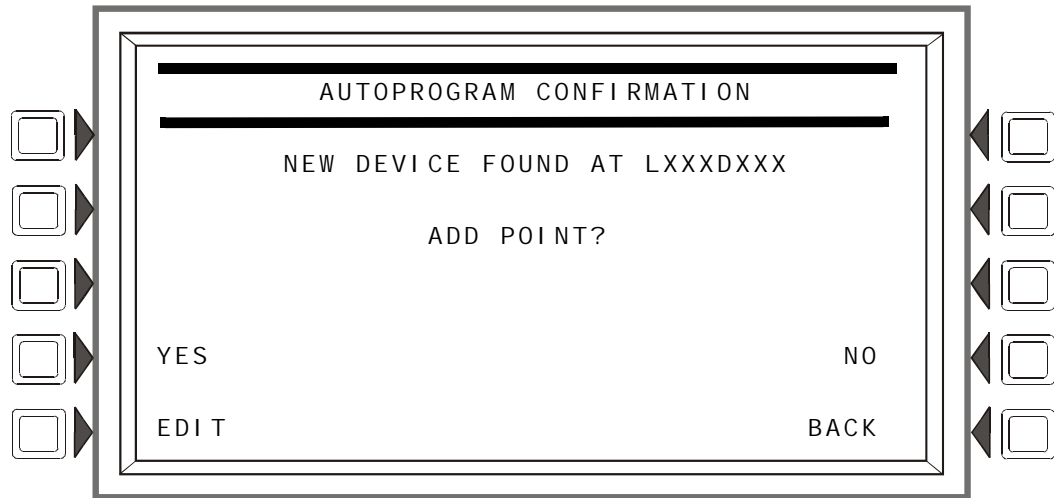

**Figure 3.51 Autoprogram Confirmation Screen (New SLC Point)**

### Soft Keys

YES: Press this soft key to install the new point into the panel’s database.

EDI T: Press this soft key to advance to the point programming menu for the new point. (This option is available for SLC points only, not for panel points. The EDI T soft key will not appear for panel modules).

NO: Press if the point will not be installed.

### Error and Discrepancy Resolution

Pressing the REVI EW soft key will bring up screens that provide the means to resolve any errors or discrepancies found during autoprogram.

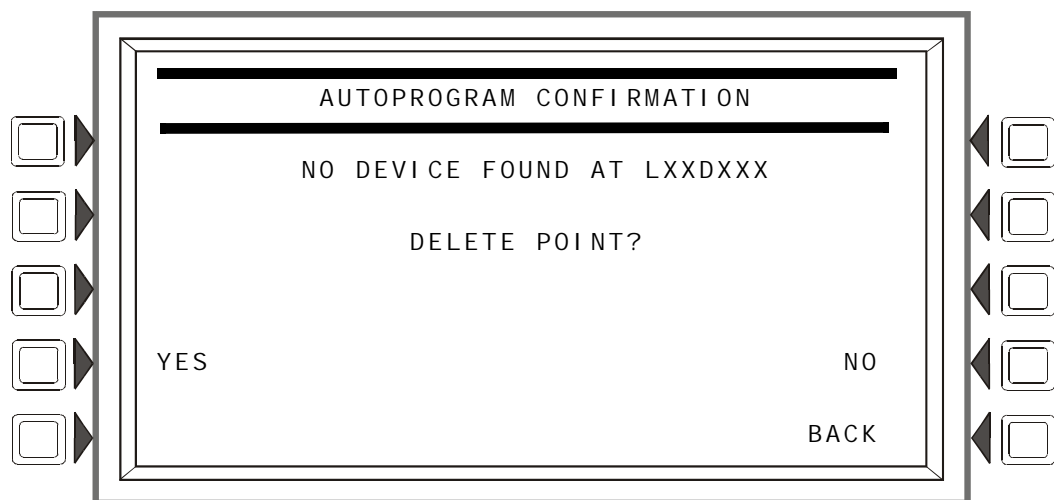

**Figure 3.52 Autoprogram Confirmation Screen (Missing Point)**

**Display**

This screen will display either the SLC device address or the panel circuit module address when a previously installed/programmed point does not respond during a subsequent Autoprogram.

**Soft Keys**

YES: Press to delete the point information from the panel's database.

NO: Press to leave the point information in the panel's database.

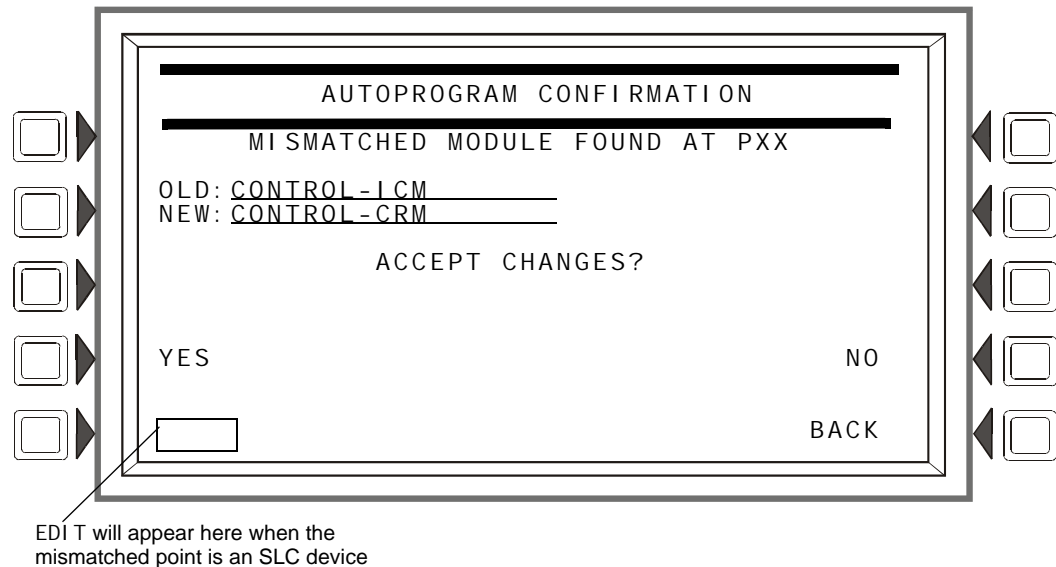

**Figure 3.53 Autoprogram Confirmation Screen (Mismatched Point)**

**Display**

The OLD field contains the information currently in the panel's programming database. The NEW field contains the information found during autoprogramming. The fields contain the FlashScan Type ID codes if the device is FlashScan, or they will contain the device type if CLIP.

**Soft Keys**

YES: Press this soft key to accept the new device type.

EDIT: This soft key will appear only when SLC devices are mismatched. It will not appear for panel modules. Press it to advance to the point programming screen for this point.

NO: Press if the new information should not be installed over the existing information in the database.

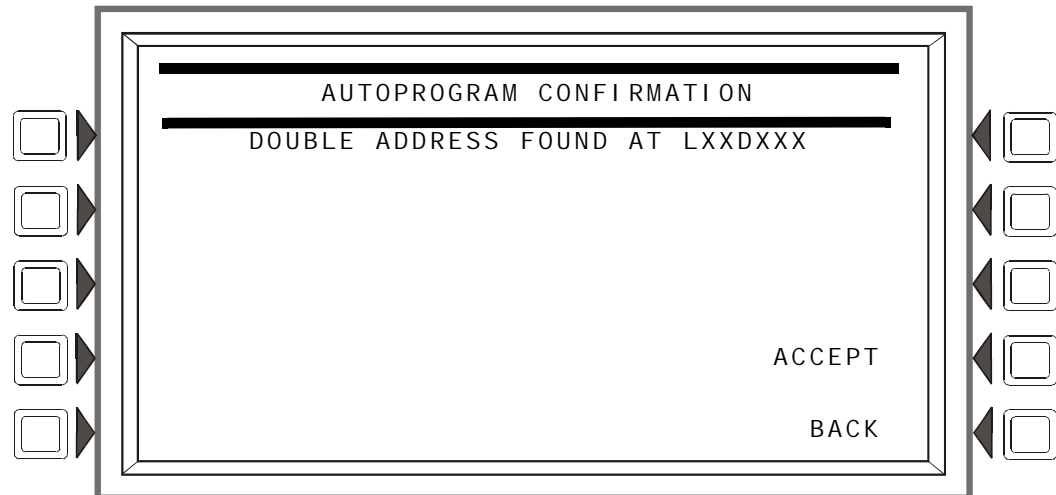

**Figure 3.54 Autoprogram Confirmation Screen (Double Address)**

**Display**

The SLC loop number and device address are displayed where the Autoprogram has found more than one detector or module with the same address.

**Soft Keys**

**ACCEPT:** Pressing this soft key acknowledges that the programmer has been informed of the double address. Autoprogram will not make a modification to the database for this point. The installer must correct this problem.





## Section 4: Alter Status

Alter Status provides a programming level for changing operating parameters such as detector sensitivity, Walk Test, changing system time/date and disabling/enabling points. Alter Status is accessible with the Master Password and with User Passwords programmed for Alter Status.

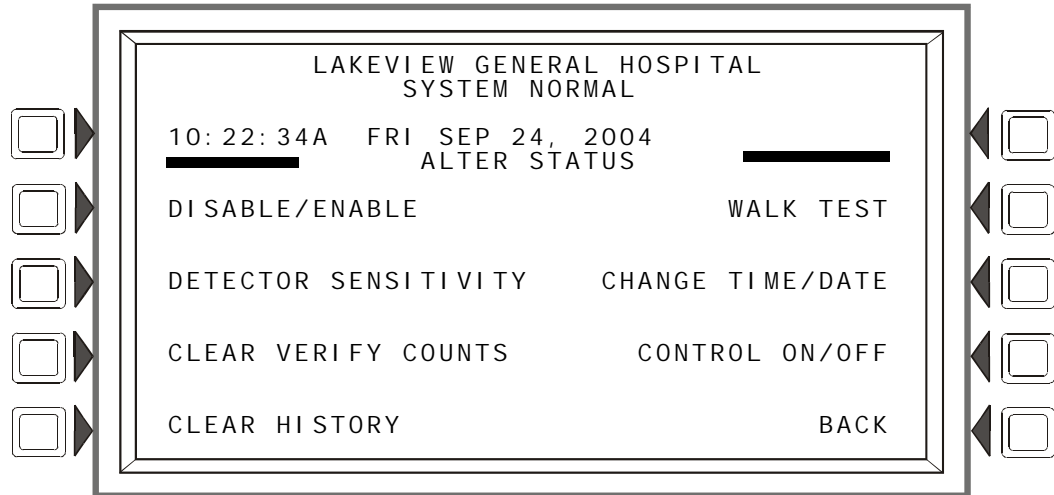

Figure 4.1 Alter Status Screen

### Soft Keys

All soft key selections (except BACK) are menu selections. Press to display the desired menu.

## 4.1 Disable/Enable Point Selection

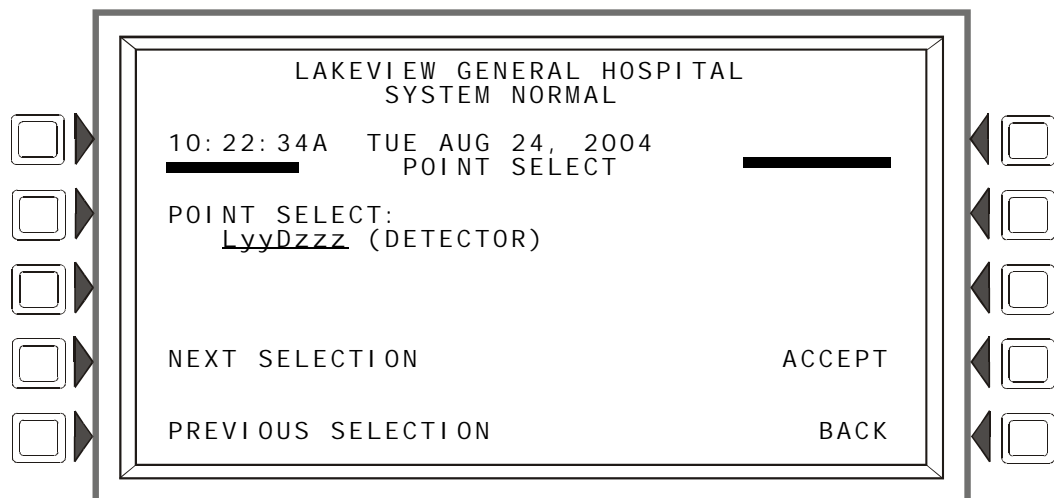

Figure 4.2 Point Select for Disable/Enable Screen

### Soft Keys

POINT: Press this soft key to identify the type of point to disable/enable: the choices that will appear in parentheses next to the point format are DETECTOR, MODULE, PANEL CKT, or GENERAL ZONE. Enter the address of the point using the keyboard. If there is an event in the display area, that address will be the default. If no event is present, the default format will be that of a detector.

## 4.2 Disable/Enable

A point can be disabled or enabled using this screen. Press the DI SABLE/ENABLE soft key at the Alter Status screen to display the following.

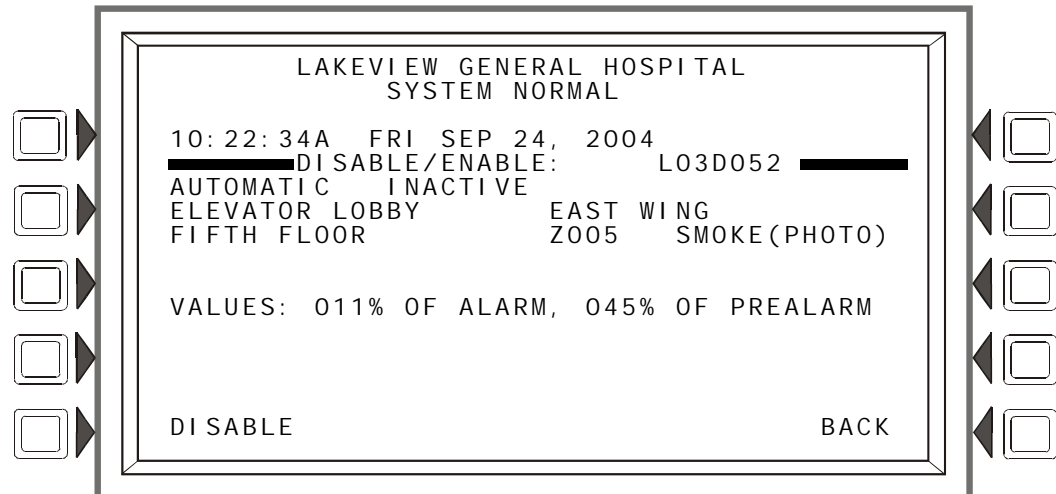

Figure 4.3 Disable/Enable Screen

### Soft Keys

DI SABLE/ENABLE Only the applicable command will display. Press to disable an installed, programmed point, or to enable a disabled one.



**CAUTION:** When a disabled output is enabled, it will be affected by conditions existing in the system that would normally affect it. That is, if a condition exists that would have turned the output on were it enabled, it *will* turn on when it is enabled.

Group Zone Disable - This term refers to the disabling (or enabling) of a general zone. If the first position in a device's zone map matches the general zone number entered at this screen, that device will be disabled (or enabled).



**WARNING:** Do not rely on Disable to disable releasing points during testing. Releasing points must be physically disconnected.

### 4.3 Detector Sensitivity

This screen is displayed when the “Detector Sensitivity” soft key is pressed on the Alter Status Menu screen.

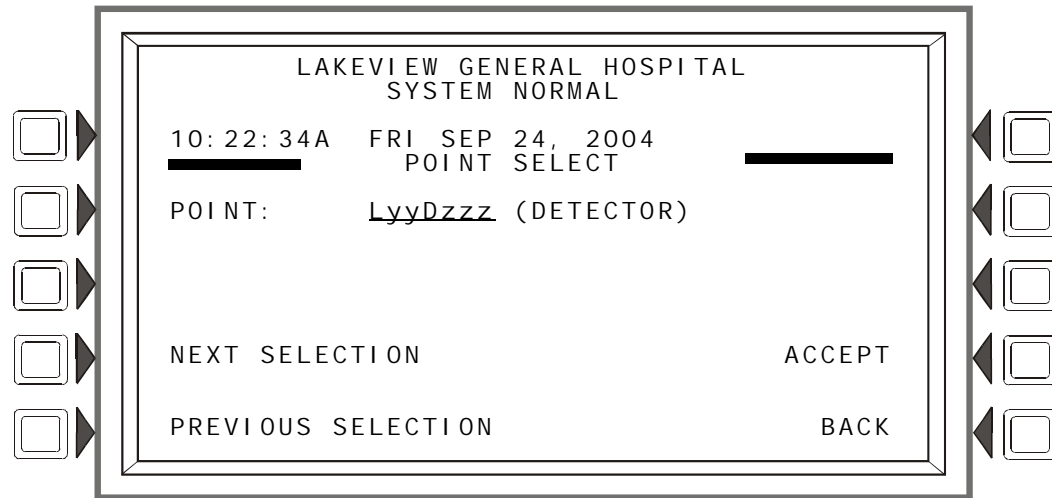

**Figure 4.4 Sensitivity Select Point Screen**

**Soft Keys**

POINT: Press to place the cursor in the format field. Type the address using the keyboard.

NEXT/PREVIOUS SELECTION: Press these soft keys to scroll sequentially through the detector addresses on the loop. The screen will display the next loop when the last device on this loop is passed.

ACCEPT: Press to proceed to the Detector Sensitivity screen.

#### 4.3.1 Sensitivity Select

Detector sensitivity levels, set during initial programming, may be changed through accessing the Detector Sensitivity Select screen and the command screen that follows. The Detector Sensitivity Select screen is displayed when the ACCEPT: soft key is pressed at the Sensitivity Select Point screen.

The current sensitivity values displayed are described in Detector Point Programming (Refer to the paragraph “Sensitivity” on page 41 ) and in Appendix D, “AWACS™ Applications”

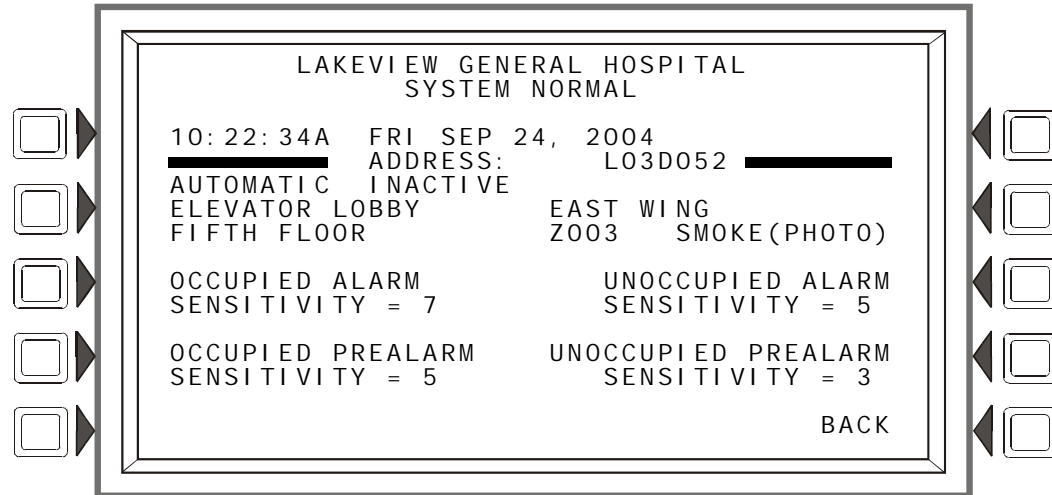

**Figure 4.5 Detector Sensitivity Select Screen**

**Soft Keys**

- OCCUPIED ALARM SENSITIVITY:
- OCCUPIED PREALARM SENSITIVITY:
- UNOCCUPIED ALARM SENSITIVITY:
- UNOCCUPIED PREALARM SENSITIVITY:

Press the soft key next to one of these setting categories to proceed to the next screen, where the setting value may be changed.

**Change Alarm/Prealarm Sensitivity**

This screen displays when any of the soft keys is pressed on the Detector Sensitivity Select screen. The user can change detector sensitivity values using this screen.

The settings (1-9) displayed below the soft key are unique to the type of detector.

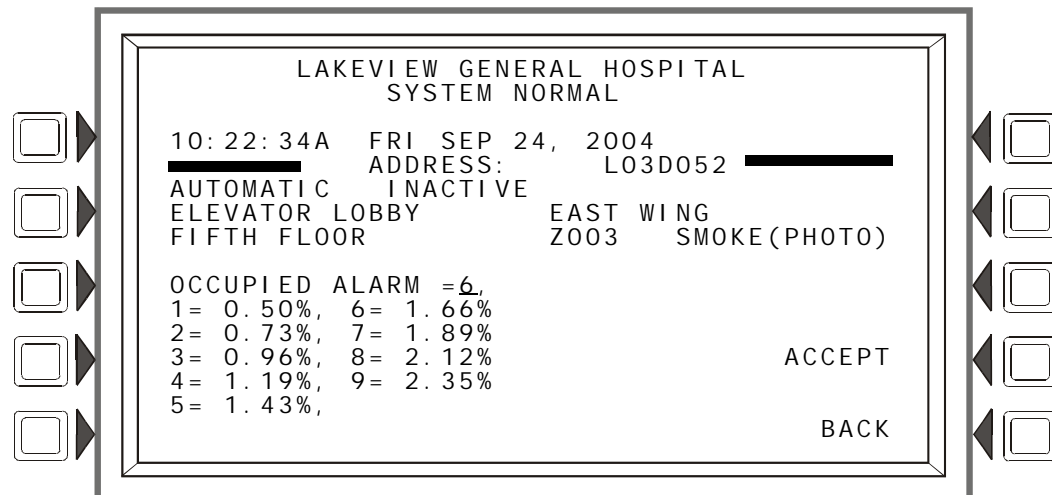

**Figure 4.6 Change Alarm Sensitivity Screen**

**Soft Keys**

OCCUPI ED ALARM: The type of alarm/prealarm will display based on which soft key was pressed in the previous screen. For example, in the screen above, OCCUPI ED ALARM displays because the OCCUPI ED ALARM SENSITIVITY: soft key was pressed.

The detector sensitivity values display below the soft key. Select a value by pressing the soft key until the desired value appears in the underlined field.

ACCEPT: Press to accept the change made on this screen, and to return to the previous screen.

## 4.4 Clear Verify Counters

The Clear Verify Counters screen lets you clear all counters for detectors selected for Alarm Verification on the FACP. It displays when the “CLEAR VERIFY COUNTERS” soft key is pressed on the Alter Status Menu screen.

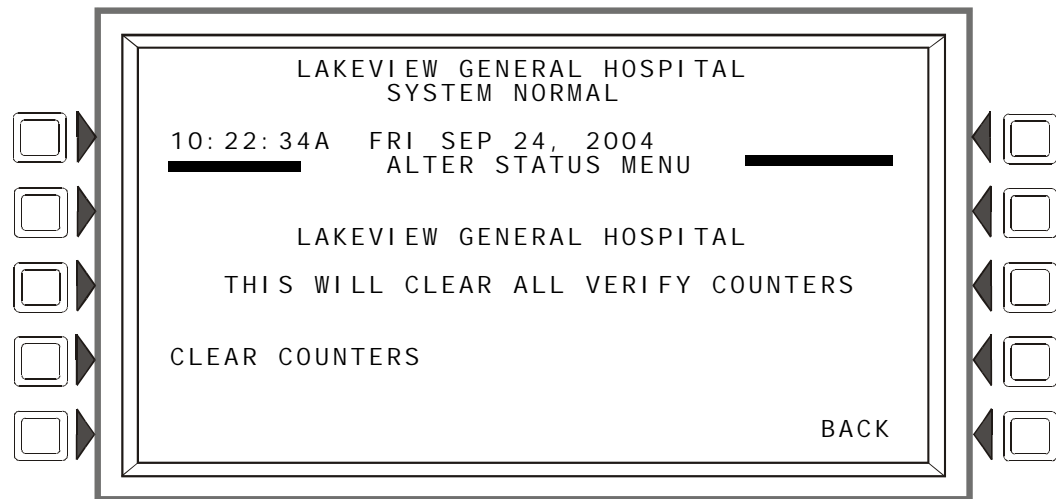

**Figure 4.7 Clear Verify Counters Screen**

### Soft Keys

CLEAR COUNTERS: Press this soft key to clear all verification counters.

## 4.5 Clear History

This screen is displayed when the CLEAR HISTORY soft key is pressed on the Alter Status Menu screen. It brings the user to a command screen, where the type of history may be selected for clearing.

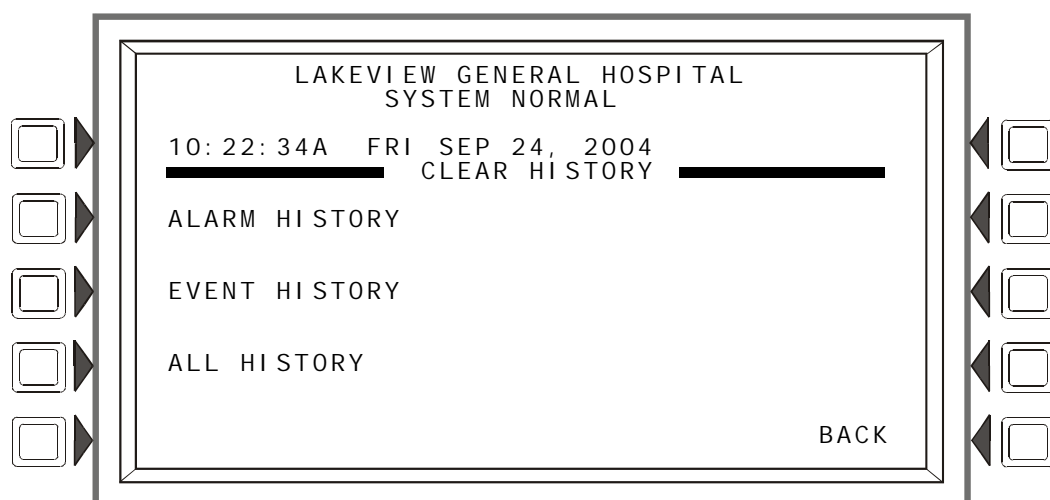

**Figure 4.8 Clear History Screen**

#### Soft Keys

ALARM HI STORY: Press to clear Alarm history.

EVENT HI STORY: Press to clear Event history.

ALL HI STORY: Press to clear both Alarm and Event history.

## 4.6 Walk Test

Walk Test allows the user to test the entire fire alarm system while away from the control panel. There are two types of Walk Test - Basic and Advanced - and each type operates in audible mode.

Walk Test results are sent to the printer and to Event History as “Test”.



**WARNING:** Physically disconnect all releasing devices before starting Walk Test. It is not sufficient to disable in any other manner.



**WARNING:** Walk Test mode can deactivate fire protection. Observe the following important precautions.

#### IMPORTANT!

- Prior to Walk Test, secure all protected buildings, and notify the building owner/operator, fire department, and other pertinent personnel that testing is in progress.
- Immediately after Walk Test is completed, notify the same people that testing is complete and the system is restored to normal operation. Reconnect releasing devices.
- Walk Test will “time out” and return to normal operation after one hour when no Walk Test activations have occurred during that time.
- Walk Test may be exited at any time by pressing the ABORT soft key on the screen



**NOTE:** Walk Test will not start if any devices are active (i.e., fire alarms, security, supervisories or pre-alarms.) To perform a walk test while a device is active, disable the device and press the System Reset button.

**Basic Walk Test** - The basic test allows a single operator to run audible tests on the panel. All logic equation automation is suspended during the test. All ACS devices will default to Disable. They may be enabled by selecting NO at the DISABLE ACS BOARDS soft key on the Walk Test Menu screen (Figure 4.9 ).

**Advanced Walk Test** - The advanced test allows field-supplied output point programming that will react to input stimuli such as CBE and logic equations. When points are activated in advanced testing, each initiating event will latch the input. Release of the latch and subsequent activation of the next point is controlled through use of the NEXT TEST soft key. All ACS devices default to disable. They may be enabled by selecting NO at the DISABLE ACS BOARDS soft key on the Walk Test Menu screen (Figure 4.9 ).

An advanced test is audible. An audible test is intended for pull station verification, magnet-activated tests on input devices, input and output device and wiring operation/verification. Only devices previously configured to participate and designated as part of the test through the following screens will make sound.

### Walk Test Activation Indications

FlashScan poll mode - Once the START TEST soft key has been pressed:

- each intelligent addressable input device will blink its address in red, and each intelligent addressable output device will blink its address in green. Pattern examples are given below.

**Table 4.1**

Address	Blink Pattern
8	8 blinks, long stop, 8 blinks, long stop,....
37	3 blinks, stop, 7 blinks, long stop, 3 blinks, stop, 7 blinks, long stop,....
152	15 blinks, stop, 2 blinks, long stop, 15 blinks, stop, 2 blinks, long stop....

- an input device activated in Walk Test latches on steady green for the duration of the test. If the device is put in trouble (for instance, the detector head is removed, then replaced), the LED will be latched on for the duration of the test.
- an output device activated in Basic Walk Test will remain active and the LED will glow steady green for
  - 4 seconds for alarms
  - 8 seconds for troubles.
- an output device activated in Advanced Walk Test will remain active and the LED will glow steady green until the NEXT TEST soft key is pressed.

CLIP poll mode - Once the START TEST soft key has been pressed:

- intelligent addressable input and output devices continue to blink red as usual until activated.
- an input device activated in Walk Test latches on steady red during activation. If the device is put in trouble (for instance, the detector head is removed, then replaced), the LED will be latched on for the duration of the test.
- an output device activated during Basic Walk Test will remain active and the LED will glow steady green (if a FlashScan module) or steady red (if a CLIP module) for
  - 4 seconds for alarms
  - 8 seconds for troubles.
- an output device activated in Advanced Walk Test will remain active and the LED will glow steady green (if a FlashScan module) or steady red (if a CLIP module) until the NEXT TEST soft key is pressed.

Conventional Devices - Monitor modules with the Type Codes SMOKE CONV, HEAT DETECT, and SMOKE DETECT, and outputs with the Type Code FORM C RESET do not participate in Walk

Test other than blinking their addresses if they are polled in FlashScan mode. To prevent the occurrence of false alarms for conventional devices, 24 volt power will be interrupted for up to a minute after Walk Test has been exited.

### 4.6.1 Walk Test Menu

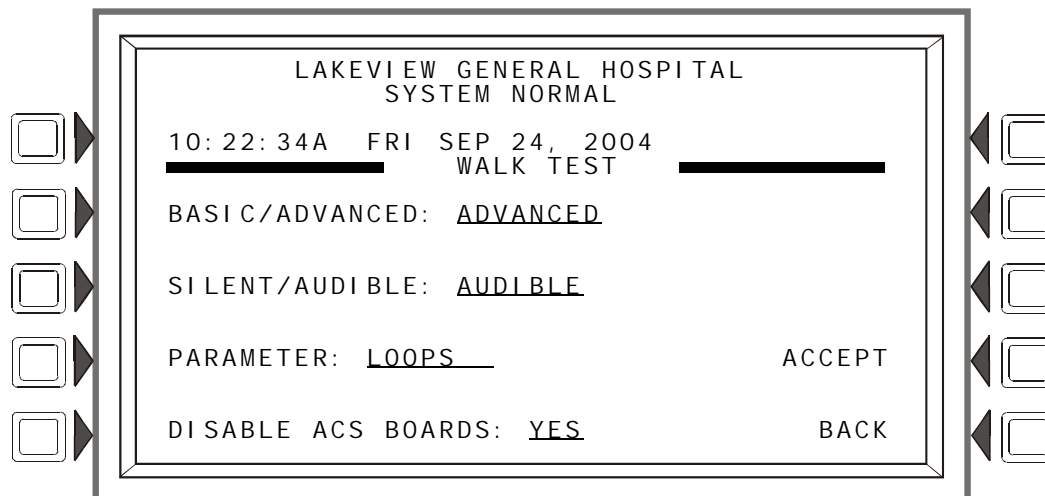

**Figure 4.9 Walk Test Menu Screen**

#### Soft Keys

BASIC/ADVANCED: Press to toggle between the two choices. Stop at the desired test.

SILENT/AUDIBLE: This soft key is for future use. Walk test is audible.

PARAMETER: Press to scroll through the choices. Stop at the desired parameter. Choosing the loops parameter will bring up the Walk Test loops programming screen (Refer to Figure 4.10)

Choosing the panel parameter will bring up the panel Walk Test screen (Refer to Figure 4.13)

Choosing the Devices parameter will bring up the Devices Walk Test screen (Refer to Figure 4.11.)

If this parameter is chosen...	The participating devices/points in Basic Test will be...	The participating devices/points in Advanced Test will be...
LOOPS	All devices/points on all the FACP SLCs that are set to participate in Walk Test with the exception of logic equations, whose activation is suspended.	All devices/points on all the FACP SLCs, as well as panel circuit outputs that are set to participate in Walk Test.
PANEL	The entire panel - all devices/points set to participate in Walk Test - will participate with the exception of logic equations, whose activation is suspended.	The entire panel - all devices/points set to participate in Walk Test including panel circuit outputs - will participate.
DEVICES	Individual detectors tested one at a time.	Detectors only.

**Table 4.1 Walk Test Parameters**

DISABLE ACS BOARDS: This soft key allows the operator to disable ACS devices during Walk Test. Press to toggle between the two choices, YES (disable) and NO (enable). Default: YES



## 4.6.2 Walk Test Loops Parameters

This screen appears when LOOPS is chosen as a parameter at the Walk Test Menu.

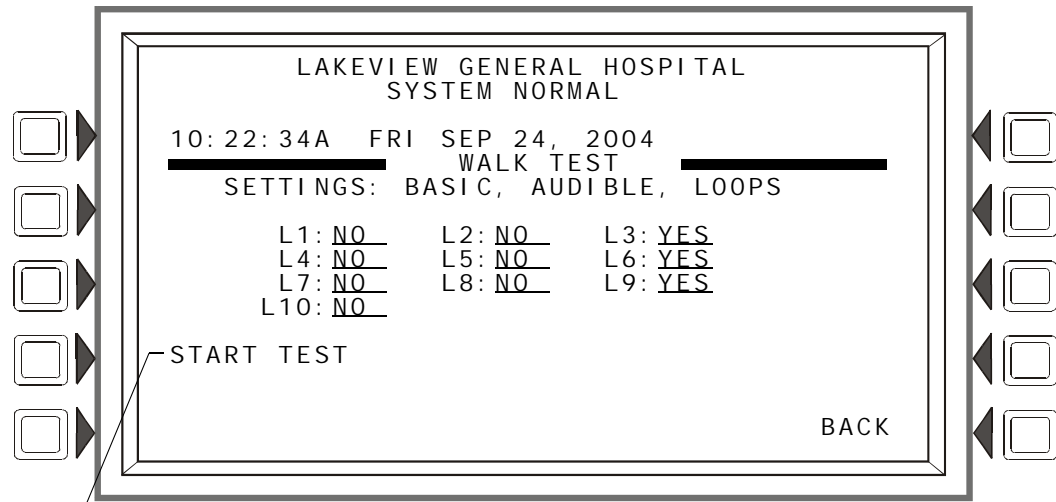

Once the START TEST soft key has been pressed and the test begun, this message changes to ABORT

**Figure 4.10 Walk Test Loops Programming Screen**

The chosen settings are displayed (BASIC, AUDIBLE in Figure 4.10), and installed loops will display with a participation field. The up and down arrow keys on the keypad navigate through the fields. Choose YES for participation, NO for no participation, using the NEXT SELECTION(+)/PREVIOUS SELECTION(-) keys on the keypad.

### Soft Keys

**START TEST:** Press to begin Walk Test using the chosen parameters. Once Walk Test has begun, this soft key becomes ABORT, and can be pressed at any time to exit Walk Test.

**NEXT TEST:** This key appears for Advanced Walk Tests when the panel parameter is chosen at the Walk Test Menu Screen. Refer to Figure 4.13 for the location of this key. Press it to progress from one activation to the next, latching the new point and releasing the latch on the previous point.

## 4.6.3 Advanced Walk Test Activation

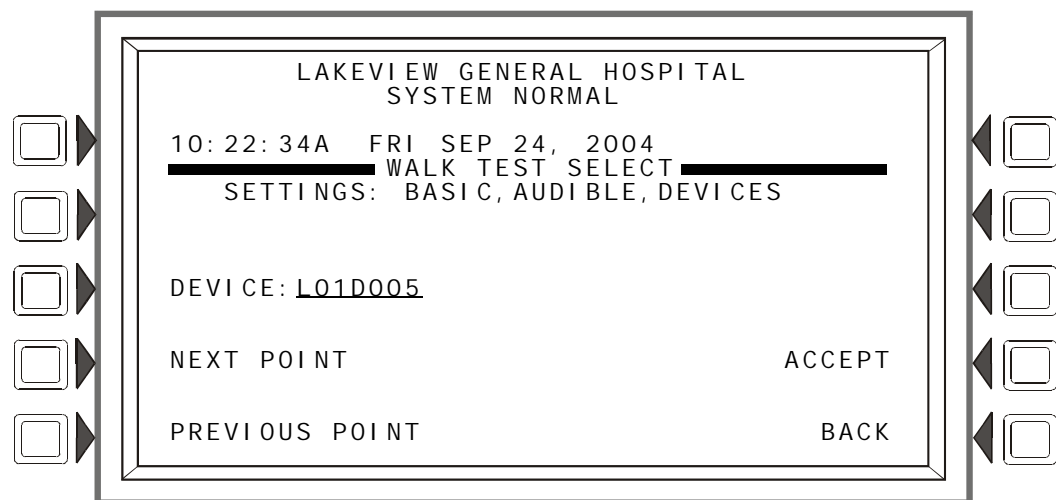

**Figure 4.11 Walk Test Devices Programming Screen**

This screen appears when DEVI CES is chosen as a parameter at the Walk Test Menu. The chosen settings are displayed (BASI C, AUDI BLE in Figure 4.11).

### Soft Keys

DEVI CE: Press this key to type the desired detector address into the underlined field.

NEXT POI NT: Press this key to bring up the next installed address for an addressable detector into the DEVI CE field.

PREVI OUS POI NT: Press this key to bring up the previous installed address of an addressable detector into the DEVI CE field.

ACCEPT: Press this key to begin Walk Test, and to proceed to the Devices Test Selection screen (Figure 4.12).

## 4.6.4 Devices Test Selection

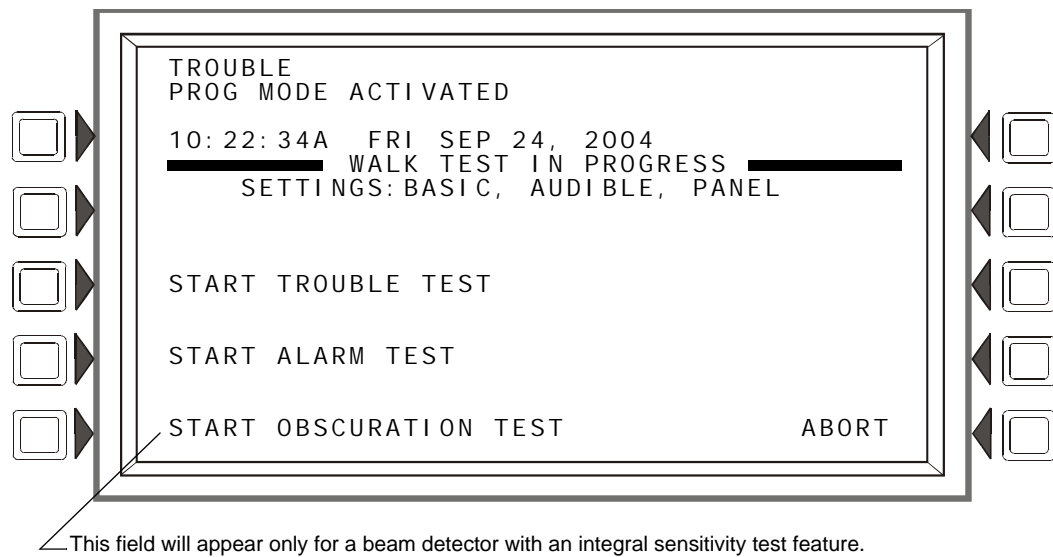

**Figure 4.12 Devices Test Selection Screen**

### Soft Keys

START TROUBLE TEST: Press this key to generate a Trouble on the selected detector.

START ALARM TEST: Press to generate an Alarm on the selected detector.

START OBSCURATI ON TEST: Press to perform an Obscuration Test on the selected Beam detector. (Beam detectors only.)

ABORT: Press to stop the Walk Test.



**NOTE:** The Trouble, Alarm and Obscuration tests described above are additional tools provided to ascertain the functionality of a detector. They are *not* a substitute for periodic maintenance and sensitivity verification per NFPA 72.

### Advanced Walk Test In Progress Screen

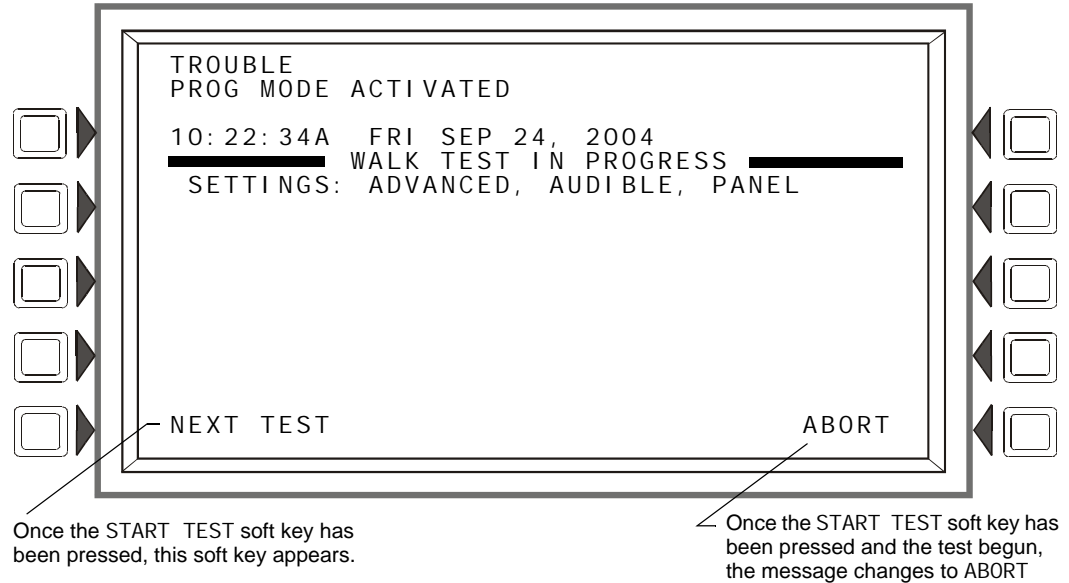

Figure 4.13 Advanced Walk Test In Progress Screen.

## 4.7 Program Time/Date

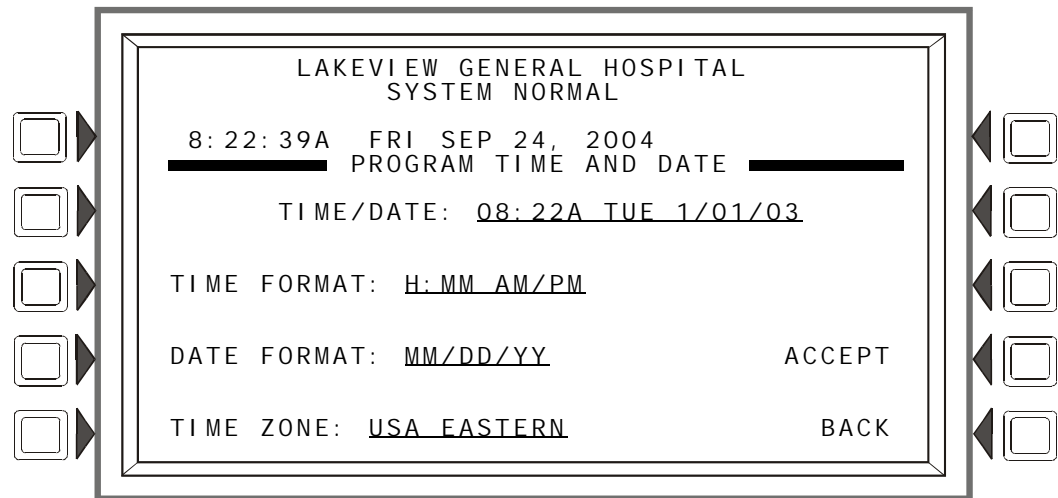

Figure 4.14 Program Time and Date Screen

#### Soft Keys

**TIME/DATE:** Press to bring the cursor to the time/date field. The current time and date will be displayed using the current format. Change the values using the keypad.

**TIME FORMAT:** Press to scroll through a list of formats as follows; HH:MM AM/PM; H:MM AM/PM; HH:MM; and H:MM. Stop at the desired format.

**DATE FORMAT:** Press to toggle between MM/DD/YY and DD/MM/YY formats. Stop at the desired format.

**TIME ZONE:** Press to scroll through a list of 34 time zone selections. Stop at the appropriate zone.

ACCEPT: Press to save changes made on this screen and to return to the previous screen.

## 4.8 Control On/Off Point Select

This screen may be used to force a control module (SLC or panel circuit) off if it is on, or on if it is off.

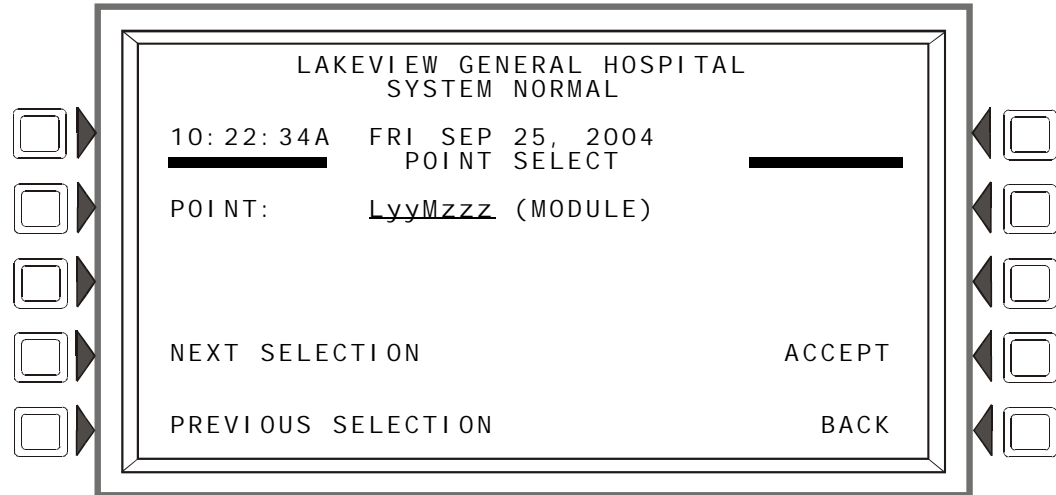

**Figure 4.15 Control On/Off Point Select Screen**

### Soft Keys

POINT: Press this soft key to enter the point address to be forced on or off.



**NOTE:** A module with a releasing Type ID can not be forced.

NEXT/PREVIOUS SELECTION: Press to progress to the next or previous point on the loop.

ACCEPT: Press to continue to the Control On or Control Off screen.

### 4.8.1 Control Off

One of the following two screens will display when a point is selected and accepted in the previous screen.

If the selected point is active, the Control Off screen will appear.

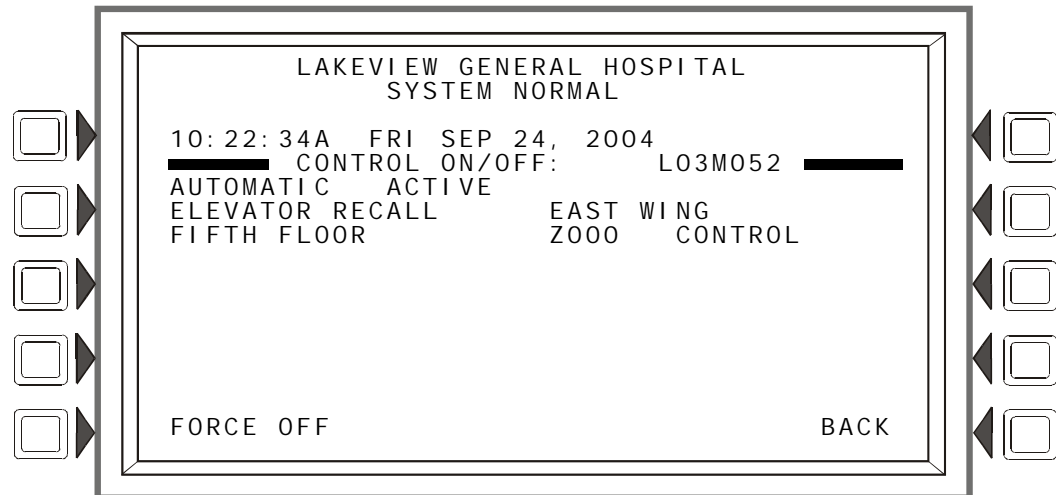

**Figure 4.16 Control Off Screen**

#### Soft Keys

**FORCE OFF:** Press this soft key to change the state of the control module from AUTOMATIC ACTIVE to AUTOMATIC INACTIVE.



A module with a releasing Type ID cannot be forced.

## 4.8.2 Control On

If the selected point is inactive, the Control On screen will appear

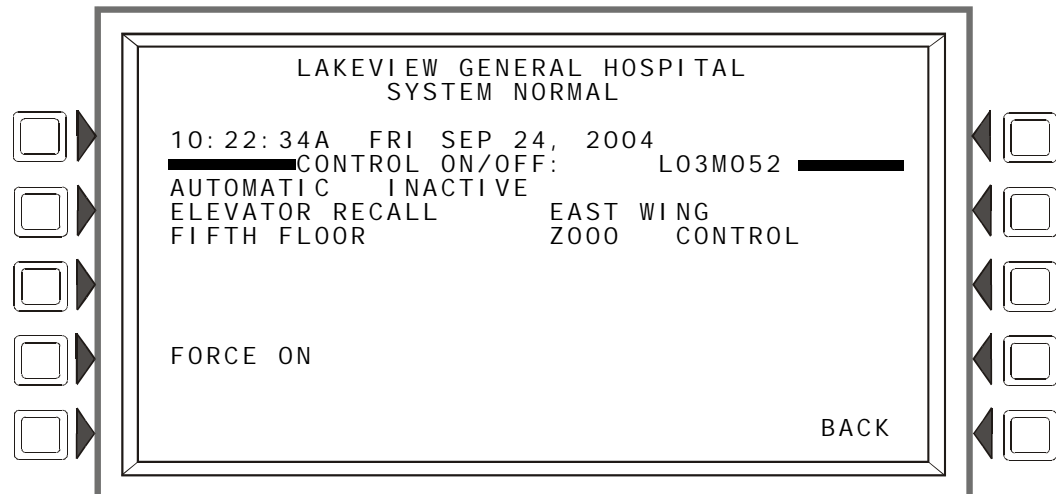

**Figure 4.17 Control On Screen**

#### Soft Keys

**FORCE ON:** Press this soft key to change the state of the control module from AUTOMATIC INACTIVE to AUTOMATIC ACTIVE.



# Section 5: Service Screens

## 5.1 Version Information

Software version information may be displayed by pressing the Lamp Test special function key on the keyboard for more than 5 seconds. The following three screens will appear in succession while the Lamp Test key is pressed.

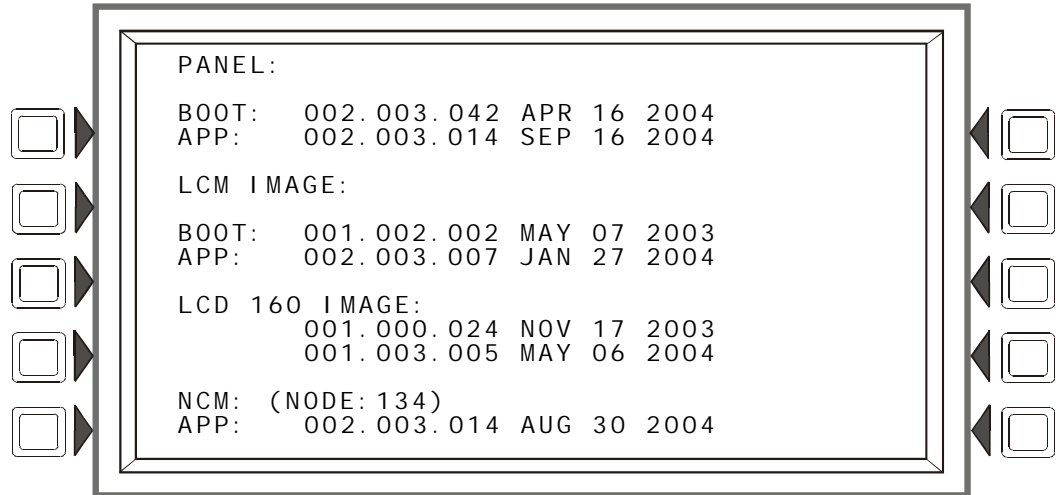
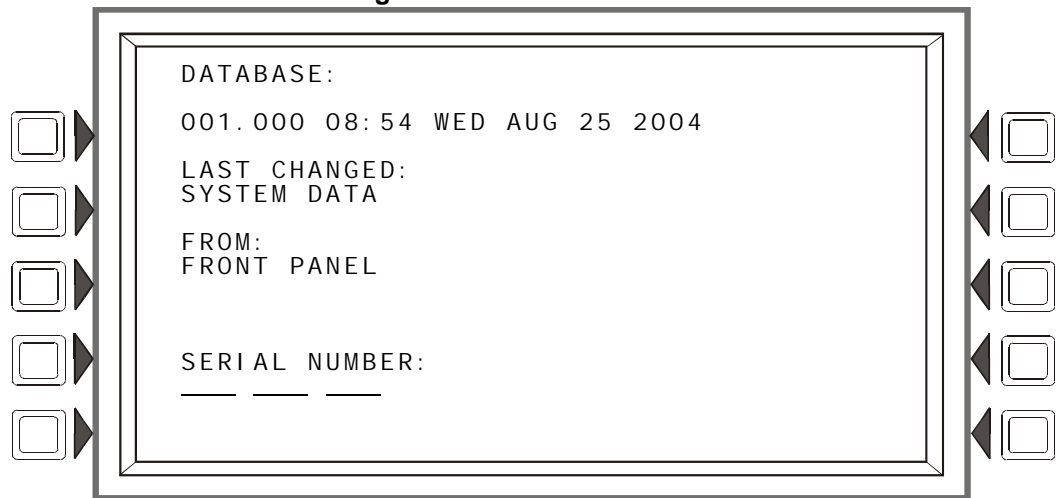
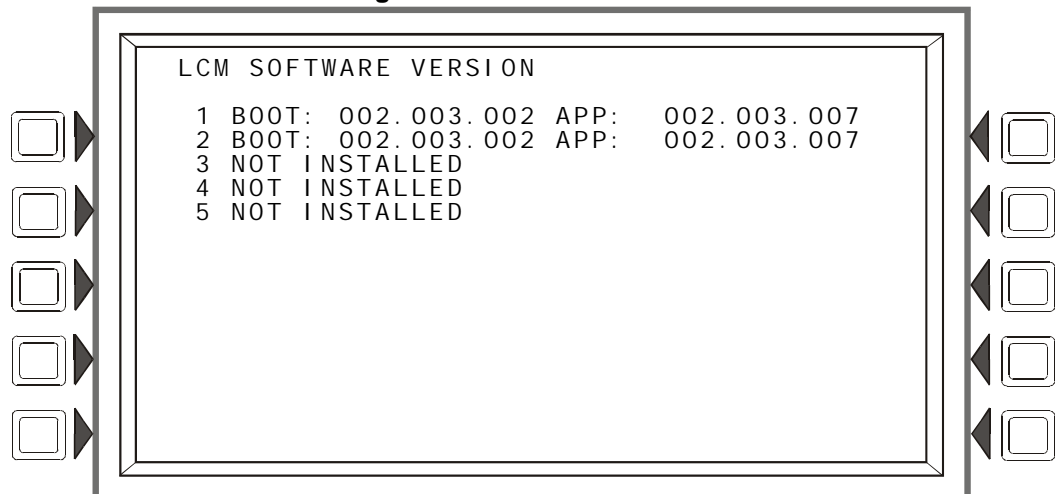

Figure 5.1 Version Screen 1.



**Figure 5.2 Version Screen 2.**



**Figure 5.3 Version Screen 3**

## 5.2 Power-up Screen

The Power-up screen appears when the panel is powering up. A series of self-tests are performed internally: the tests and the results of the tests appear on the screen as they are completed.

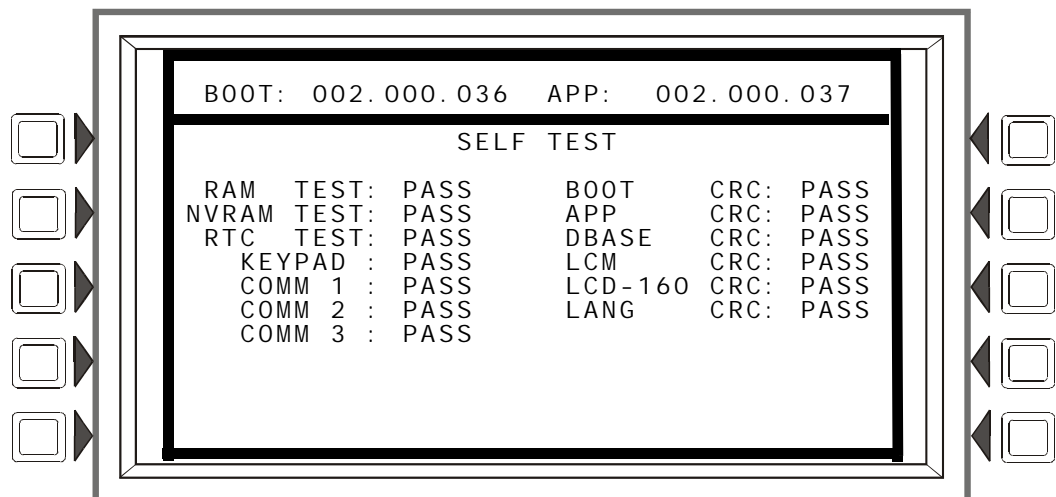

**Figure 5.4 Self Test Screen**



**NOTE:** "LCM" refers to the code resident in the JCPU-3030, not the code that is programmed into the LCM.



**NOTE:** "LCD-160" refers to the code resident in the JCPU-3030, not the code that is programmed into the LCD-160.



### 5.3 Bootloader Screen

This screen is used for LCD-160 and Loop downloads. To display this screen, press the RESET key during the entire power-up self-testing process, then release the key.

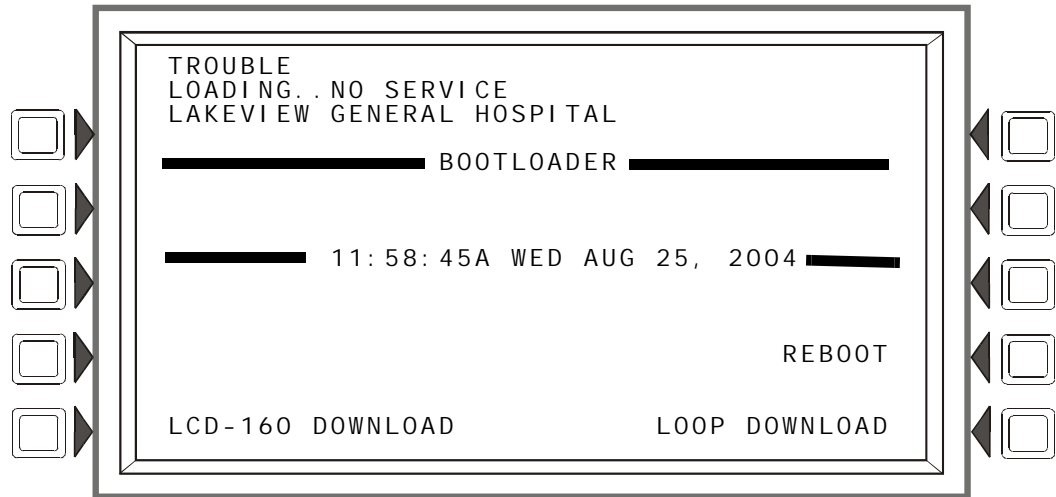

**Figure 5.5 Bootloader Menu Screen**

LCD-160 DOWNLOAD: Press this soft key to display the LCD-160 Download menu screen.

REBOOT: Press this soft key to reboot the panel, and exit the bootloader screen.

LOOP DOWNLOAD: Press this soft key to display the Loop Download Menu screen.

#### 5.3.1 LCD-160 Download Menu

The language and banner displayed on LCD-160s can be programmed at this screen.

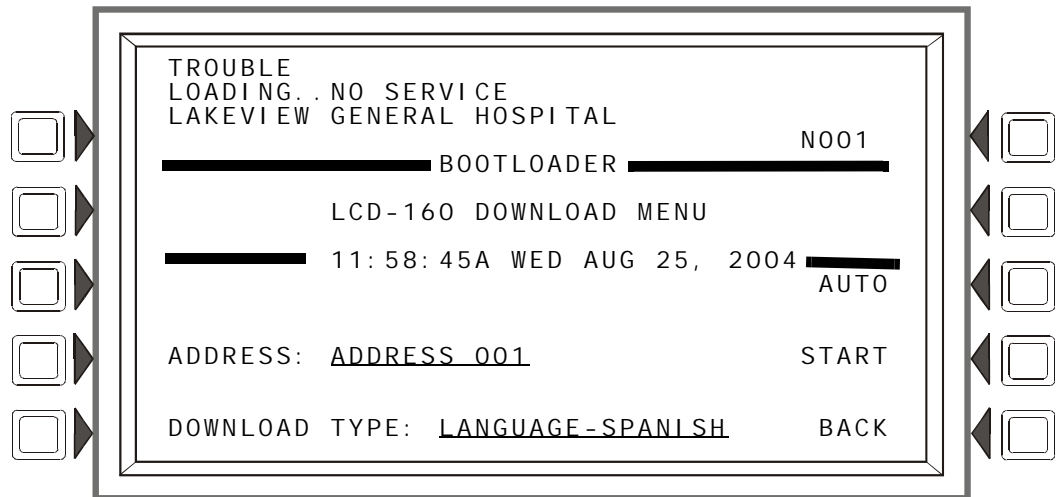

**Figure 5.6 LCD-160 Download Menu Screen**

ADDRESS: Press this soft key to scroll through to the desired LCD-160 address. “All” means all addresses. Default: ADDRESS 001.

Shortcut: Type 1 on the keyboard, which jumps to address 10, or type 2 for twenty, 3 for thirty, 0 to reset back to 1. Type an asterisk (\*) to select all addresses.

DOWNLOAD TYPE: Press this soft key to scroll through the languages (LANGUAGE-ENGLISH, LANGUAGE-HEBREW, LANGUAGE-PORTUGUESE, LANGUAGE-SPANISH), BANNER, APP and BOOT. Stop at the desired selection.

Choose a language to change LCD-160s selected at the ADDRESS field to display in that language.

Choose BANNER to add the panel banner to those LCD-160 displays selected at the ADDRESS field.

Select APP to download an application file to the selected LCD-160(s).

Select BOOT to download a boot file to the selected LCD-160(s).

AUTO: Press this soft key to automatically download to the LCD-160 the most up-to-date language, bootloader, and application from the panel.

START: Press this soft key to begin the download.

### 5.3.2 Loop Download Menu

This screen allows the programmer to select loops for downloading applications and/or boot programming.

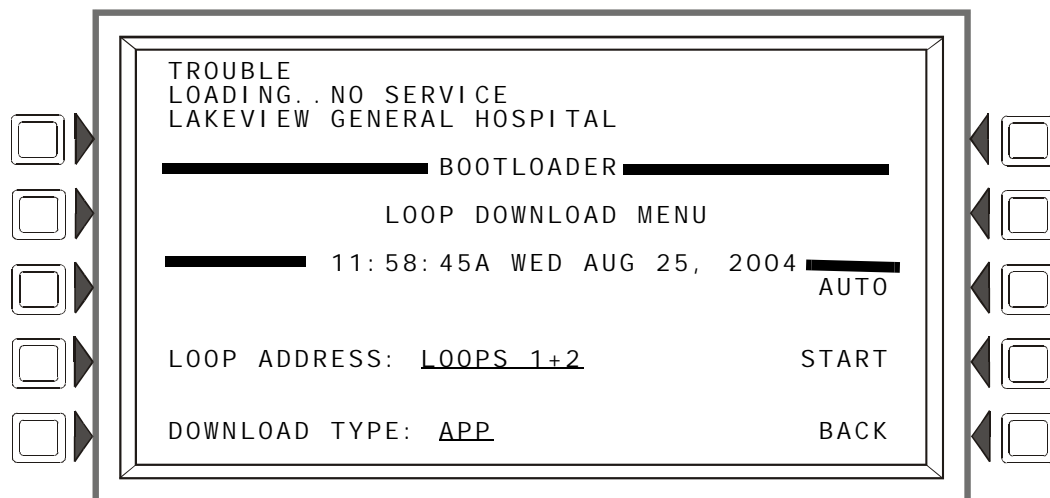

**Figure 5.7 Loop Download Menu Screen**

LOOP ADDRESS: Press this soft key to scroll through the Loops. Stop at the appropriate pair, or select ALL.

DOWNLOAD TYPE: Press this soft key to scroll through the download types. Stop at the appropriate type. Selections are: APP, BOOT, or APP/BOOT.

Select APP to download an application file to the selected loops.

Select BOOT to download a boot file to the selected loops.

Select APP/BOOT to select both for downloading.

AUTO: Press this soft key to automatically download to the selected loop(s) the most up-to-date applications or boot programming from the panel.

START: Press this soft key to begin the download.

## 5.4 Download Screen

This screen is displayed during application/database/loop/LCD-160 downloads. The progress meter shows the current download type and progress.

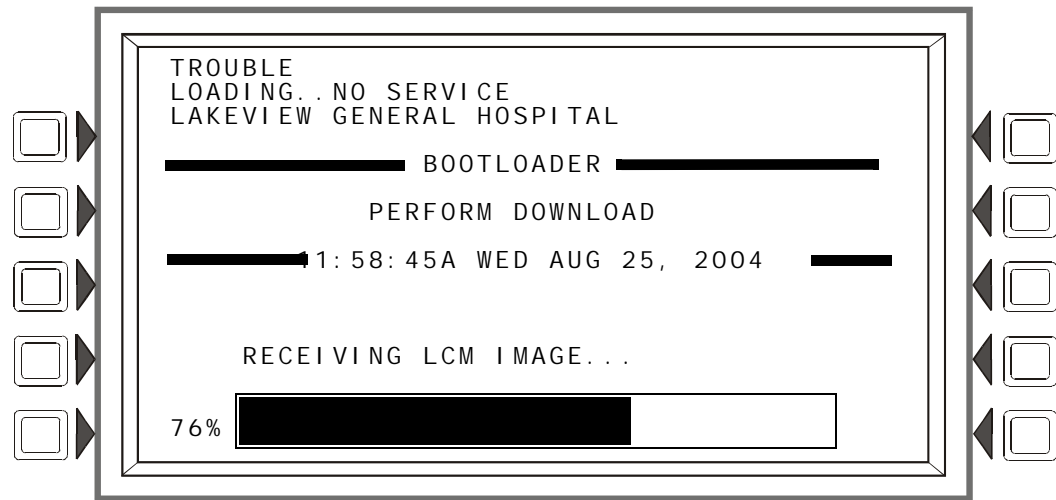

Figure 5.8 Download Screen

## 5.5 Application Corrupt Screen

During power-up, the panel checks the image integrity of the application code. If the code is corrupt, the panel cannot proceed, and the following screen is displayed. The user must use VeriFire™ Tools to download the application code. Usually this screen results from a power interrupt during a critical period of application download. The trouble LED will flash and the piezo (if enabled) will pulse while this screen is in effect.

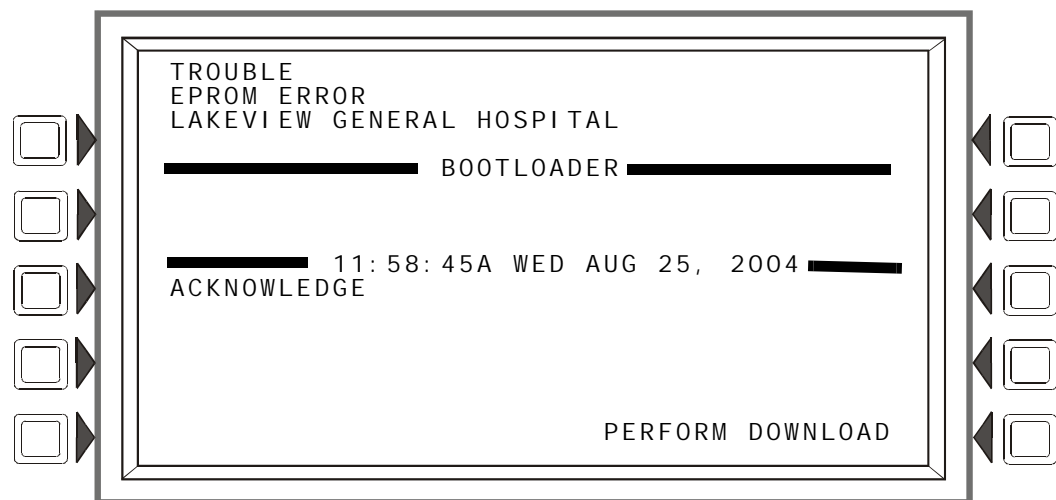

Figure 5.9 Application Corrupt Screen



# Appendix A: Menu Hierarchy

## A.1 Screens Overview

### MAIN MENU

#### **Event Counts Display**

- More Information

#### **Multiple Event List**

#### **History Select**

- All Events
- Alarms Only
- Troubles Only
- Supervisory Only
- Security/Other
- Time/Date Interval
  - Time & Date Range Select
- Point Range
  - Point Range Select

#### **Read Status**

- Smoke Detector
- Heat Detector
- Monitor Module
- Control Module
- General Zone
- Releasing Zone
- Logic Zone
- Trouble Zone
- Panel Input
- Panel Output
- Annunciator

#### **Program/Alter Status**

- Panel Program
  - Network Parameters
    - IP Access
  - Panel Settings (Panel Settings (1) Screen
    - Reminder Menu
    - More (Panel Settings (2) Screen
  - Panel Timers
    - More
  - LCD Programming
  - ACS Programming
    - ACS Point Programming
  - Supervision
  - More
    - Password Change
      - Master Password
      - User Password
    - Weekly Occupancy Schedule
    - Remote Display Menu
      - Remote Display Point Programming
    - Loop Configuration
      - Loop Point Programming
    - Custom Action Message
    - Event Logging

- Holiday Menu
- Point Program
  - Detector Point Programming (1)
    - Zone Map
    - More (Detector Point Programming (2))
      - Custom Action Message
      - Weekly Occupancy Schedule
      - Sensitivity
      - More (Detector Point Programming (3))
  - Module Point Programming
    - More
      - Zone Map
      - Custom Action Message
  - Panel Module Point Programming
    - More
      - Zone Map
      - Custom Action Message
  - General Zone Point Programming
  - Releasing Zone Programming
  - Logic Zone Programming
    - Edit Logic Equation
      - Add Point/Zone
      - Add Logic Function
      - Add Time/Date
  - Trouble Zone Programming
  - Annunciator Board Label
- Delete Program Menu
  - Delete Point
- Autoprogram Menu
  - Confirmation Screens
- Alter Status
  - Disable/Enable
  - Detector Sensitivity
    - Sensitivity Select
      - Change Alarm/Prealarm Sensitivity
  - Clear Verify Counters
  - Clear History
  - Walk Test Menu
    - Walk Test Loop Parameters
    - Advanced Walk Activation
    - Device Test Selection
    - Walk Test in Progress
  - Program Time/Date
  - Control On/Off Point Select
    - Control Off
    - Control On

**Printer Functions**

- Programming
  - Print Programming Menu
    - Print Programming Menu (2)
- Active Points
  - Active Points Menu
- Walk Test
  - Detector Maintenance Report
- Installed Points
  - Installed Points Menu
    - Installed Points Menu (Range)







# Appendix B: Releasing Applications



**WARNING:** Do not rely on Disable to disable releasing points during testing. Releasing points must be physically disconnected.

## B.1 Releasing Zones

The control panel includes ten releasing zones (ZR00-ZR09) that can be used to control up to ten releasing operations. Each zone operates independently, and is fully programmable. To program a releasing zone, refer to “Releasing Zone” on page 51.

There are four releasing functions, outlined below, that can be defined by entering values in the associated fields during programming.

Function/Field	Explanation
Delay Time	<p>Delay Time is the time that elapses between activation of an initiating device and activation of all outputs mapped to the initiating device through a releasing zone. Delay Time can have a value of 0 to 60 (seconds). A value of 0 will result in immediate output activation upon activation of the initiating device.</p> <p>Following is a graphic representation of what happens when a delay timer is set to 15 seconds for releasing zone ZR02.</p> <p><b>NOTE:</b> If cross-zoning is in effect, the delay time will not begin until the cross-zoning conditions are met. Refer to “Cross Zones” on page 97 for more information.</p>
Abort Switch	<p>Selection of a 3-letter abort switch type code (ULI, IRI, NYC, or AHJ) defines the operation of an Abort Switch in that releasing zone. Refer to the specific abort switch type code heading in this appendix for details on how each functions.</p>
Cross Zone	<p>Select one of three Cross Zone types (Yes, Zone, or Heat), or No (not used). A Cross Zone requires tripping two or more initiating devices to activate the outputs mapped to a releasing zone. Refer to the Section B.3.5 on page 97 section of this appendix for details and examples.</p>
Soak Time (NFPA 16 Applications only)	<p>Soak Time specifies the length of time to dump releasing agents when a releasing zone activates. When the Soak Time expires, the control panel automatically shuts the releasing solenoids for the active releasing zone. Soak Time can have a value of 0 to 9999 seconds. If Soak Time is set to 0, the releasing solenoids will remain active until system reset.</p> <p>Following is a graphic representation of what happens when soak time is set to 300 seconds for releasing zone ZR02.</p>

## B.2 NFPA Releasing Applications

This control panel can be used for agent release or preaction/deluge control applications. In a properly configured system with compatible, listed actuating and initiating devices, this control panel complies with the following NFPA standards for installation in accordance with the acceptable standard:

Standard	Covers
NFPA 13	Sprinkler Systems
NFPA 15	Water Spray Systems
NFPA 16	Foam-water Deluge and Foam-water Spray Systems
NFPA 17	Dry Chemical Extinguishing Systems
NFPA 17A	Wet Chemical Extinguishing Systems
NFPA 2001	Clean Agent Fire Extinguishing Systems

**Table B.1 NFPA Standards for Releasing Applications**

## B.3 Abort Switches

The control panel provides for four types of abort switches - ULI, IRI, NYC, and AHJ - each of which will affect the operation of the delay timer in the releasing zone. For example, an NYC Abort Switch for releasing zone ZR05 affects only the delay timer in ZR05.

When an initiating device activates, pressing and holding the abort switch will prevent the control panel from sending the command to dump releasing agents when the Delay Time expires.

Requirements for using an abort switch include the following:

- A monitor module must be connected to a UL-listed abort station, such as the NBG-12LRA shown below.
- The monitor module must be programmed with the Type Code ABORT SWITCH.
- An abort switch shall not be used with a preaction system.

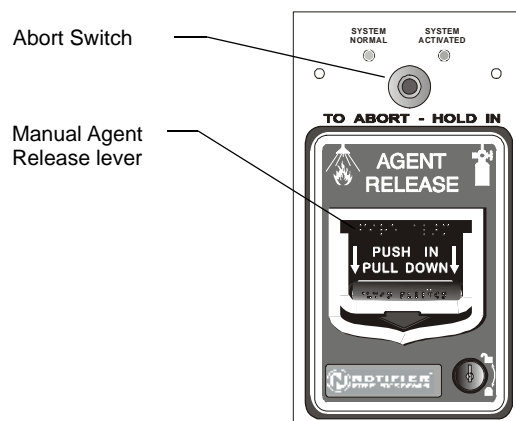

NBG-12LRA station with Abort Switch

**Figure B.1 UL-listed Abort Station**

This section contains information on each type of abort switch.

### Example of an Abort Switch Application

The figure below contains an illustration for an abort switch application configuration using releasing zone ZR05 as an example. The configuration includes:

- A monitor module wired to an abort station and programmed with the Type Code ABORT SWITCH
- All initiating devices and outputs with a common releasing zone in their zone maps - ZR05 in the example shown
- A fully programmed releasing zone - releasing zone ZR05 in the example shown. (Refer to “Releasing Zone” on page 51 for programming information.)

In the following example, when an initiating device activates (one of the two detectors or the pull station), pressing and holding the abort switch while the delay time is in effect will prevent the control panel from sending the command to dump releasing agents when the delay time expires. The abort switch selection (ULI, IRI, NYC, or AHJ) determines the function of the abort switch.

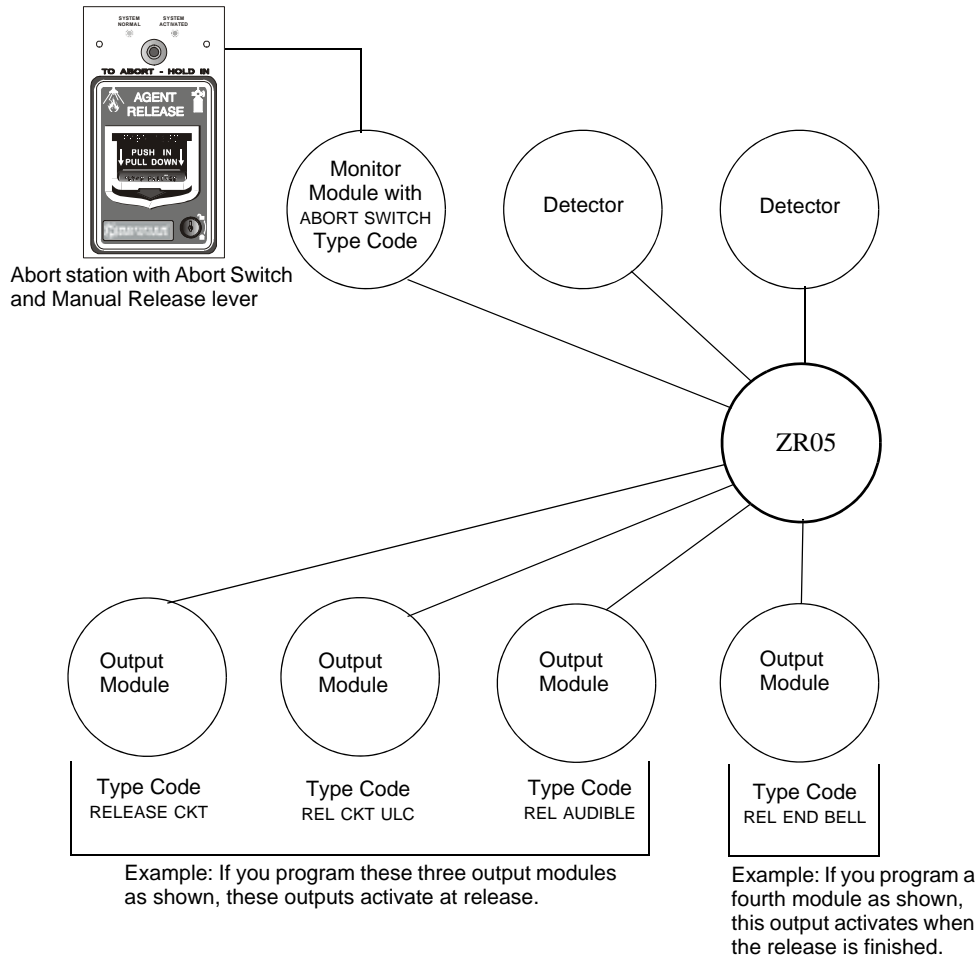

**Figure B.2 Example of a Basic Configuration for an Abort Switch**

### B.3.1 ULI Abort Switch

A ULI Abort Switch has a standard UL-type delay timer that complies with UL Standard 864.

When an alarm initiates in the programmed releasing zone, the abort switch can be pressed while the delay timer continues to count down, and held for as long as necessary. (If the abort switch is pressed after the delay timer has expired, the abort switch has no effect.) Releasing the abort switch starts a countdown by a 10-second ULI timer. When the 10-second ULI timer expires, the control panel activates the releasing zone outputs.

Program selections for this releasing zone

Delay Time: 15 seconds  
 Abort Switch: ULI  
 Cross Zone: N  
 Soak Time: 0

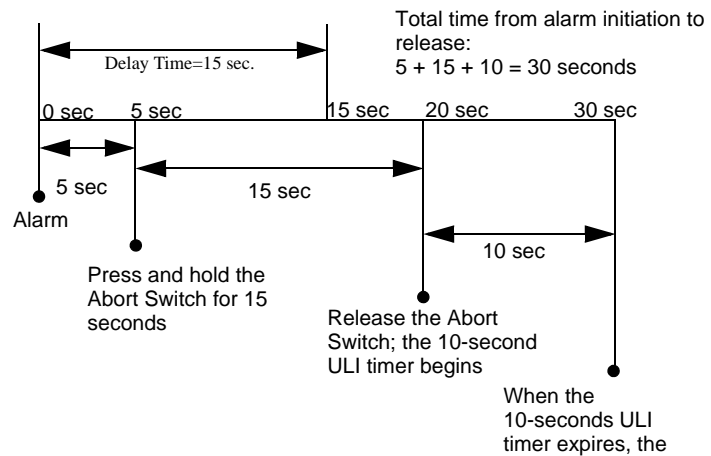

Figure B.3 ULI Abort Switch

### B.3.2 IRI Abort Switch

An IRI Abort Switch has a standard UL-type delay timer that complies with UL Standard 864, operating like ULI but with additional functions for Cross Zones. Refer to “How Cross Zones Work” on page 98 in this appendix for more information on cross zones.

When the first alarm occurs in a releasing zone programmed with a cross-zone code, pressing the abort switch will prevent activation of the releasing zone should a second alarm occur while the switch is held.

When the abort switch is released, if a second alarm has occurred while the switch was held, the ten-second IRI timer activates immediately, and the control panel activates the releasing zone outputs at the end of the IRI timer countdown.

When the abort switch is released and a second alarm has not occurred while the switch was held, the panel waits for the cross-zone conditions to be met before activating the releasing zone.



**WARNING:**

The IRI abort switch will only work if it is pushed before the second alarm occurs. If it is pushed after the second alarm, the releasing zone will already have been activated, and the switch will have no effect.

Program selections for this releasing zone

- Delay Time: 15 seconds
- Abort Switch: IRI
- Cross Zone: Z
- Soak Time: 0

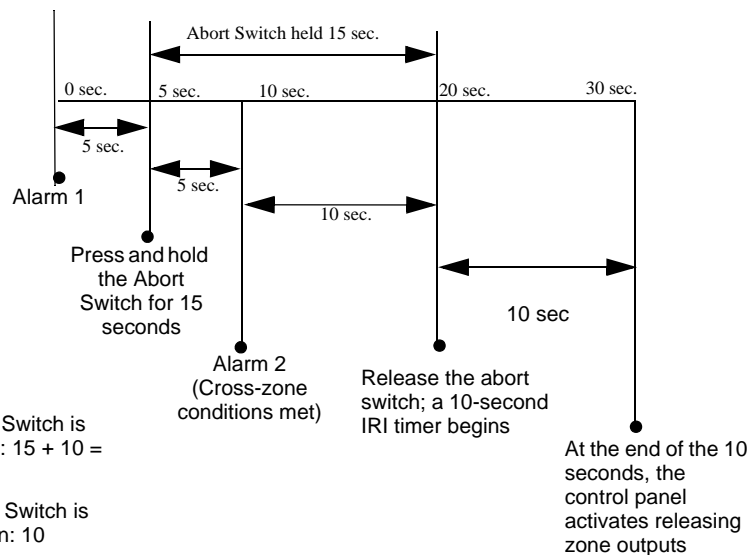

Total time from when Abort Switch is pressed to output activation: 15 + 10 = 25 seconds

Total time from when Abort Switch is released to output activation: 10 seconds

**Figure B.4 IRI Abort Switch**

### B.3.3 NYC Abort Switch

An NYC Abort Switch has a standard NYC delay timer that adds 90 seconds to the programmed Delay Time.



**NOTE:** An NYC timer does not comply with UL Standard 864.

When an alarm initiates in the programmed releasing zone, pressing and holding the abort switch stops the delay timer countdown. The delay timer restarts at the beginning of its countdown when the abort switch is released. When the Delay Time expires, the 90-second NYC timer starts counting down. When both timers expire, the control panel activates releasing zone outputs.



**NOTE:** 120 seconds is the maximum delay after the abort switch is released. If the Delay Time plus the NYC delay time of 90 seconds exceeds 120 seconds, the releasing zone outputs will still be activated at 120 seconds after the abort switch is released.

#### Example 1 - Delay Time Does Not Exceed 120 Seconds

Program a Delay Time of 15 seconds and an Abort Switch type of NYC. The releasing zone activates and the 15-second delay timer starts. Ten seconds into the delay timer countdown, press and hold the abort switch for 30 seconds, then release the abort switch. The control panel restarts the delay timer at 15 seconds and adds the NYC delay of 90 seconds. The delay timers will both expire at 105 seconds, and releasing zone outputs will begin releasing at that time. Following is a graphic example of a NYC Abort Switch and a delay timer programmed to a releasing zone.

Program selections for this releasing zone

Delay Time: 15 seconds  
 Abort Switch: NYC  
 Cross Zone: N  
 Soak Time: 0

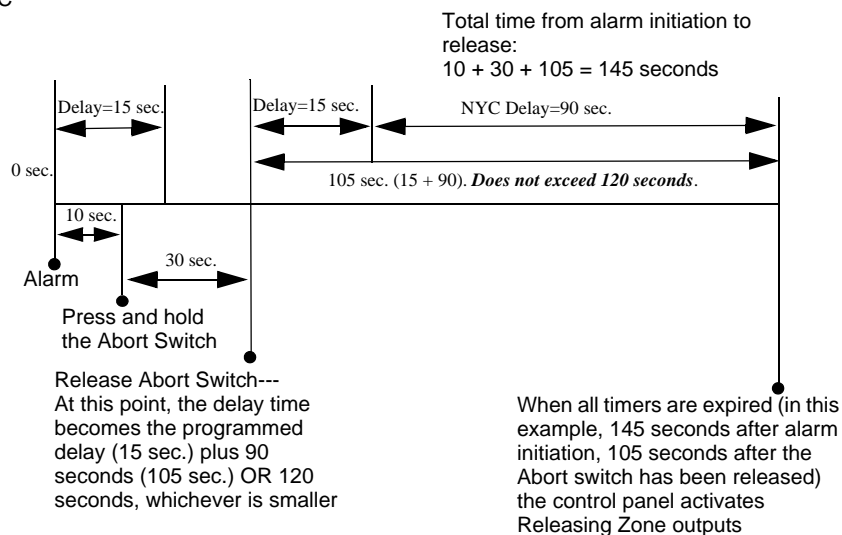

Figure B.5 NYC Abort Switch -Example 1

#### Example 2 - Delay Time Exceeds 120 Seconds

Program a Delay Time value of 60 seconds and an Abort Switch type of NYC. The releasing zone activates and the 60-second delay timer starts. Ten seconds into the Delay Time countdown, press and hold the abort switch for 30 seconds, then release the abort switch. The control panel restarts the delay timer at 60 seconds and adds the the NYC delay of 90 seconds. The delay timers will both

expire at 150 seconds: however, this time exceeds the maximum of 120 seconds, so the releasing zone outputs will begin releasing at 120 seconds, not at 150. Following is a graphic example of an NYC Abort Switch and a delay timer programmed to a releasing zone.

Program selections for this releasing zone

- Delay Time: 60 seconds
- Abort Switch: NYC
- Cross Zone: N
- Soak Time: 0

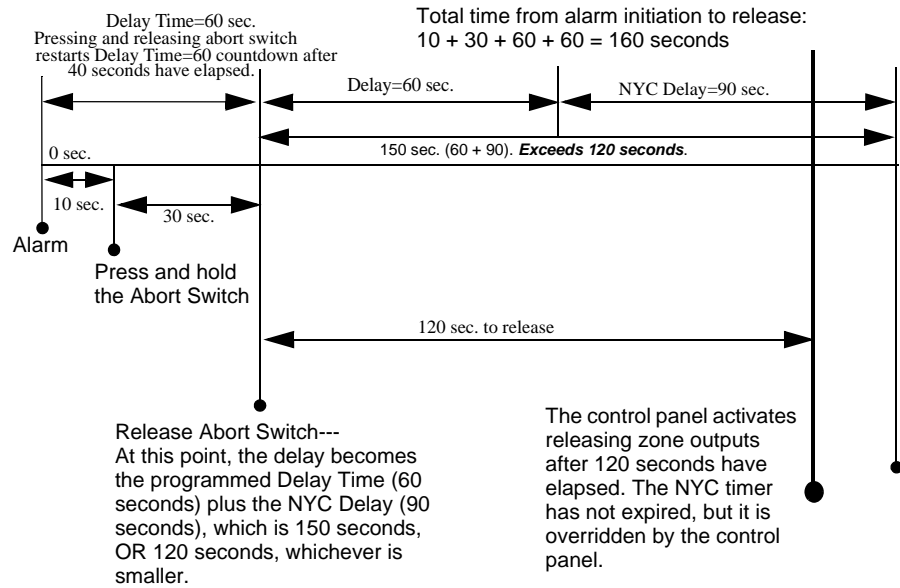

**Figure B.6 NYC Abort Switch -Example 2**

## B.3.4 AHJ Abort Switch

An AHJ (Authority Having Jurisdiction) Abort Switch has a delay timer that restores the programmed Delay Time.



**NOTE:** An AHJ timer does not comply with UL Standard 864.

When an alarm initiates in the programmed releasing zone, the programmed Delay Time starts. Pressing and holding the abort switch suspends the delay timer. When the abort switch is released, the control panel restores the value of the programmed Delay Time and the delay timer counts down. When the Delay Time expires, the control panel activates releasing zone outputs.

Program selections for this releasing zone

Delay Time: 60 seconds  
 Abort Switch: AHJ  
 Cross Zone: N  
 Soak Time: 0

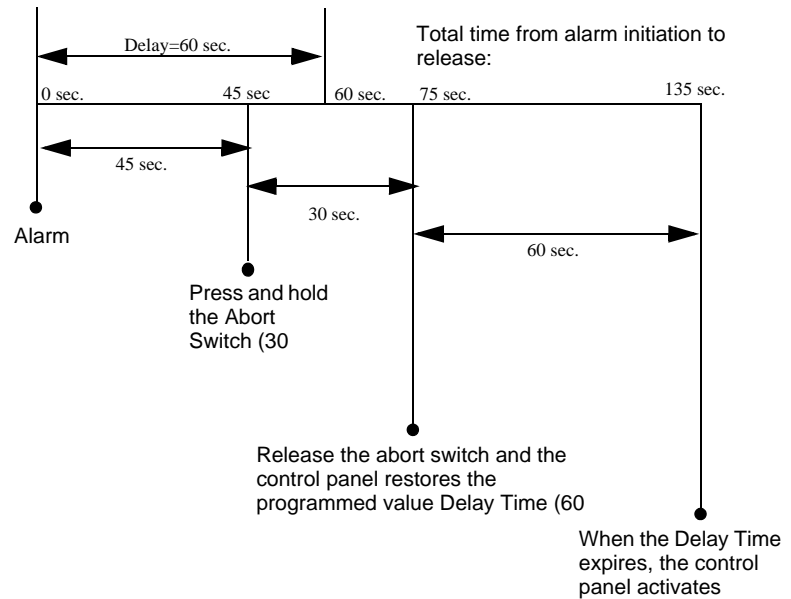

Figure B.7 AHJ Abort Switch



## B.3.5 Cross Zones

### Purpose of Cross Zones

Programming the Cross Zone releasing function can set the control panel to activate a releasing zone and any output mapped to that releasing zone only after a predetermined sequence of events occurs.



**NOTE:** The FACP considers only the primary zone (the first zone in a point's zone map) to determine whether conditions have been met for Cross Zone type Z.

A summary of the types of Cross Zones and the conditions for activating a releasing zone:

**Table 3:**

Type	Activates when
No	A Cross Zone has not been selected. An alarm from any detector mapped to the releasing zone activates it.
Yes	Two or more initiating devices are in alarm that are mapped to the same releasing zone.
Zone	Two or more initiating devices are in alarm that are mapped to two different primary zones and that are also mapped to the same releasing zone. Note that the FACP considers only primary zones to determine whether releasing zone activation should occur.
Heat	At least one smoke detector mapped to a releasing zone is in alarm and at least one heat detector mapped to the same releasing zone is in alarm.

### How Cross Zones Work

Below is an illustrated example of how Cross Zones work, using five Cross Zone selections (four detectors and an SLC output module mapped to Releasing Zone ZR01):

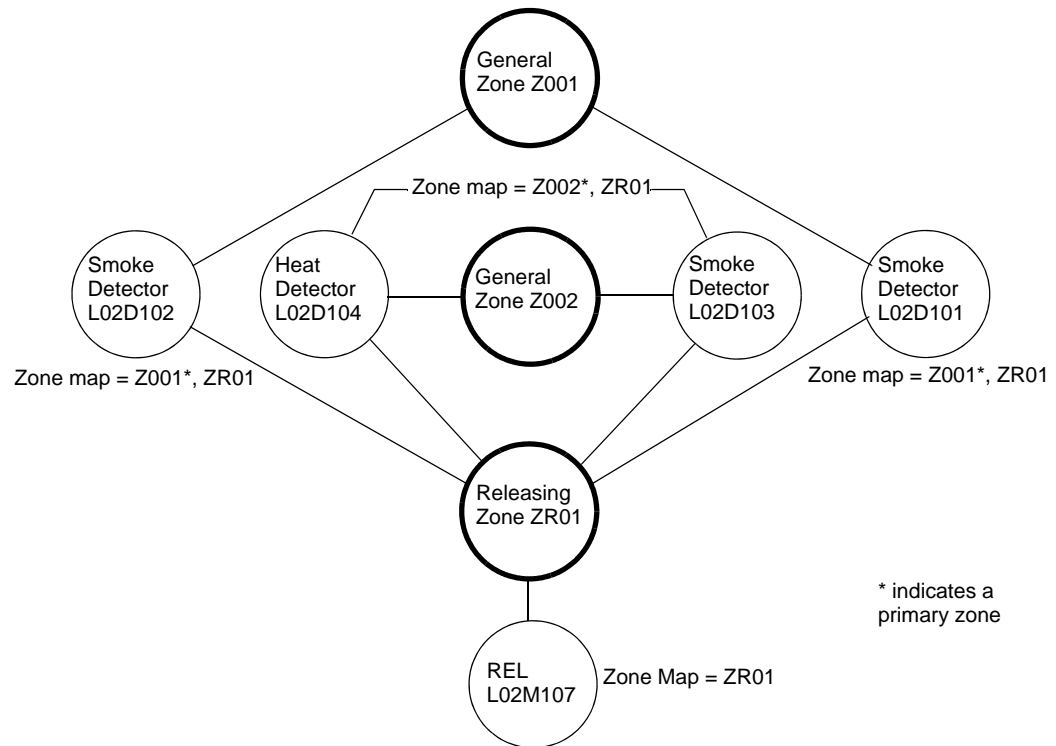

**Figure B.8 Illustrated Example of Cross Zone Programming**

Each Cross Zone option and the conditions required to activate releasing zone ZR01 are shown in the table below, according to the example in Figure B.8.

**Table 4**

Cross Zone Selection (Cross=)	Condition(s) Required to Activate the Releasing zone
Cross= <b>No</b>	An alarm from any initiating device activates the releasing zone.
Cross= <b>Yes</b>	An alarm from any two initiating devices activates the releasing zone.
Cross= <b>Zone</b> For example:	An alarm from two initiating devices mapped to different primary general zones, but mapped to the same releasing zone. <ul style="list-style-type: none"> <li>• An alarm from L02D101 and L02D103</li> <li>• An alarm from L02D102 and L02D104</li> <li>• An alarm from L02D101 and L02D104</li> <li>• An alarm from L02D102 and L02D103</li> </ul> The two detectors listed in each set above are each mapped to different primary general zones, but both list ZR01 in their zone maps.
Cross= <b>Heat</b>	Activation of heat detector L02D104 and one smoke detector (L02D101, L02D102, or L02D103).

### B.3.6 Using Type Codes for Releasing Zones

The control panel provides a set of Type Codes designed for releasing applications for inputs and outputs. This section details how to program each of these Type Codes.



**NOTE:** Panel circuit modules are not suitable for the release of agents.

Type Codes designed for releasing zone **inputs** (SLC monitor modules).

**Table 5:**

Type Code	What the Type Code does	Refer to
ABORT SWITCH (tracking)	Provides an abort function through a monitor module (connected to a UL-listed abort station) for a releasing zone.	"How to Program an Abort Switch" on page 100
MAN. RELEASE (latching)	Provides a manual release through a monitor module (connected to a UL-listed pull station) for a releasing zone.	"How to Program a Manual Release Switch" on page 101
MAN REL DELAY (latching)	Provides a manual release with a 10-second delay through a monitor module (connected to a UL-listed pull station) for a releasing zone.	"How to Program a Manual Release Delay Switch" on page 102
SECOND SHOT (latching)	Provides a second manual release through a monitor module (connected to a UL-listed pull station) for a releasing zone.	"How to Program a Second Shot Switch" on page 104

Type Codes designed for releasing zone **outputs** (SLC control modules).

**Table 6:**

Type Code	What the Type Code does	Refer to
REL END BELL	Activates an NAC audio or visual device when releasing circuits shut off.	"How to Program a Release End Bell Circuit" on page 105
REL CKT ULC	Directs outputs to perform a release function as required by ULC.	"How to Program a ULC Release Circuit" on page 106
RELEASE CKT	Directs outputs to perform a releasing function.	"How to Program a Release Circuit" on page 107
REL. FORM C	Directs relay outputs to perform a releasing function.	"How to Program a Release Form-C Circuit" on page 108
REL AUDIBLE	Activates audio or visual devices steady when releasing starts.	"How to Program a Release Audible Circuit" on page 109
INST RELEASE	Activates non-releasing output (SLC modules) with no delay time.	"How to Program an Instant Release Circuit" on page 110

## How to Program an Abort Switch

The following contains information needed to program an Abort Switch for a monitor module.

**Description** A monitor module, connected to a UL-listed abort station (such as the Notifier NBG-12LRA), used to monitor an abort switch for a releasing zone. Multiple monitor modules can be programmed with the ABORT SWITCH Type Code. They will work like multiple conventional abort switches on a conventional zone.

**Program** Select a monitor module for use as an Abort Switch. While programming this module (refer to “Module Point” on page 43 for instructions),

1. Select the ABORT SWITCH Type Code.
2. Enter the number of the desired releasing zone into the module’s zone map. The releasing zone must be fully programmed, with the Abort Switch type code included (refer to “Releasing Zone” on page 51).

**Example** A programming example of a monitor module programmed as an Abort Switch for Releasing Zone ZR05.

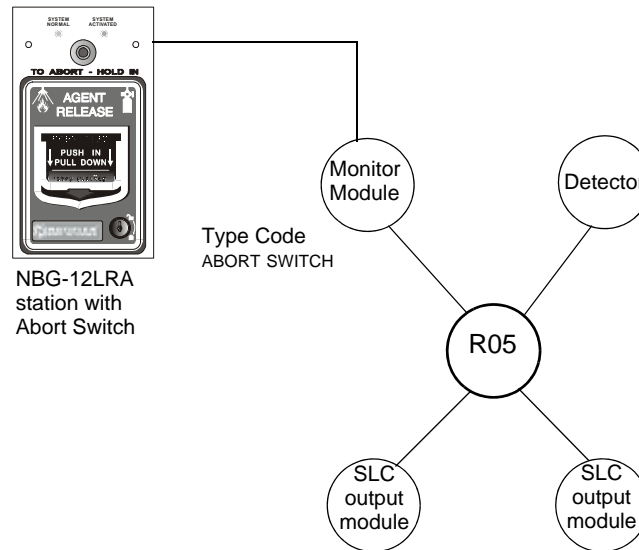

**Figure B.9 Monitor Module Configured as an Abort Switch**

## How to Program a Manual Release Switch

The following contains information needed to program a Manual Release switch for a monitor module.

**Description** A monitor module—connected to a UL-listed manual station (such as the Notifier NBG-12LRA)—used to monitor a pull station for the manual release of agents. A Manual Release switch overrides all timers, such as Delay Time or a Soak Time. Multiple monitor modules can be programmed with a MAN. RELEASE type code. They work like multiple conventional manual release switches on a conventional zone.

**Program** Select a monitor module for the manual release function. While programming this module (refer to “Module Point” on page 43 for instructions),

1. Select the MAN. RELEASE type code.
2. Enter the number of the desired releasing zone into the module’s zone map. The releasing zone must be fully programmed (refer to “Releasing Zone” on page 51).

**Example** A programming example of a monitor module programmed as an manual release switch for releasing zone ZR05.

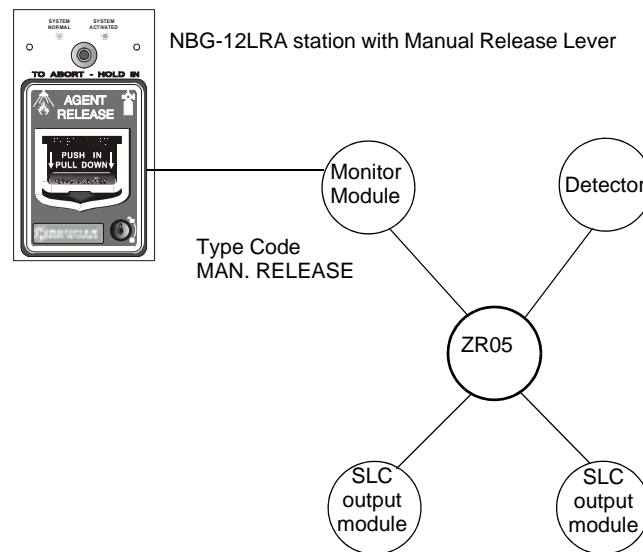

**Figure B.10 Monitor Module Configured as a Manual Release Switch**

## How to Program a Manual Release Delay Switch

The following contains information needed to program a Manual Release Delay switch for a monitor module.

### Description

A monitor module—connected to a UL-listed manual station (such as the Notifier NBG-12LRA)—used to initiate a manual release with 10-second delay time.

A Manual Release Delay switch overrides the FACP programmed Delay Time, but not Soak Time.

Multiple monitor modules can be programmed with a MAN REL DELAY type code. They work like multiple conventional manual release switches on a conventional zone.

### Program

Select a monitor module for the manual release function. While programming this module (refer to “Module Point” on page 43 for instructions),

1. Select the MAN REL DELAY type code.
2. Enter the number of the desired releasing zone into the module’s zone map. The releasing zone must be fully programmed (refer to “Releasing Zone” on page 51).

### Example

A programming example of a Monitor module programmed for MAN REL DELAY switch for Releasing Zone ZR05.

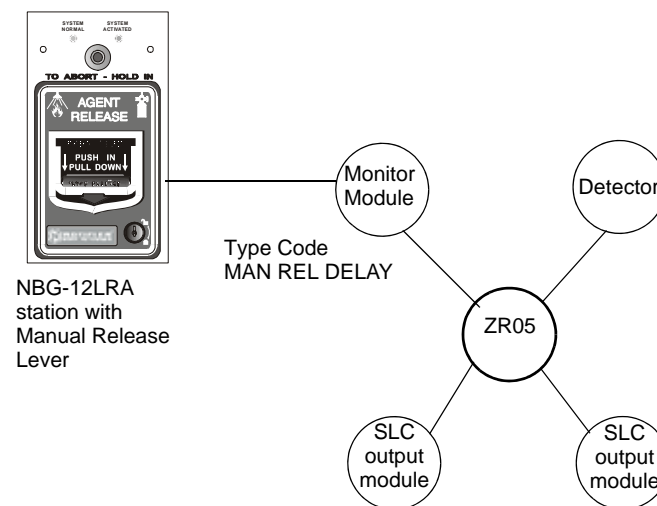

**Figure B.11 Monitor Module Configured as a Manual Release Delay Switch**

For example, program releasing zone ZR05 with a Manual Release Delay switch for the following releasing selections: Delay Time = 15, Abort Switch = ULI, Cross Zone = NO, Soak Time = 30.

When the Manual Release Delay Switch activates, the control panel replaces the remainder of the 15-second Delay Time, if running, with a 10-second timer.

Examples:

1. The FACP programmed Delay Time begins its 15 second countdown. The Manual Release Delay switch is pulled when the FACP delay timer has counted down to 12 seconds. The 12 seconds remaining in the countdown are overridden by the 10-second delay initiated by the Manual Delay switch. In this example, the total time elapsing from FACP countdown initiation to agent release is 13 seconds, less than the original 15 second FACP Delay Timer countdown.

2. The FACP programmed Delay Time begins its 15 second countdown. The Manual Release Delay switch is pulled when the FACP Delay Timer has counted down to 8 seconds. The 8 seconds remaining in the countdown are overridden by the 10-second delay initiated by the Manual Delay switch. In this example, the total time elapsing from FACP countdown initiation to agent release is 17 seconds, more than the original 15 second FACP Delay Timer countdown.
3. The FACP programmed Delay Time is not running (as would happen if the releasing station were pulled before an alarm registered). The Manual Release Delay Switch is activated by the pull station. Agent release will occur in 10 seconds.

## How to Program a Second Shot Switch



**NOTE:** The Second Shot switch can only be used with the MAN REL DELAY Type Code

The following contains information needed to program a Second Shot switch for a monitor module.

**Description** A monitor module—connected to a UL-listed manual station (such as the NBG-12LRA)—used as for a second release of agents. A Second Shot switch overrides a Delay Timer programmed to the same Releasing Zone.

**Program** Select a monitor module for the manual release function. While programming the module (refer to “Module Point” on page 43 for instructions)

1. Select the SECOND SHOT Type Code.
2. Enter the number of the desired releasing zone into the module’s zone map. The releasing zone must be fully programmed (refer to “Releasing Zone” on page 51).

**Example** A programming example of a monitor module programmed as a MAN REL DELAY switch for the first shot and a SECOND SHOT switch for the second shot.

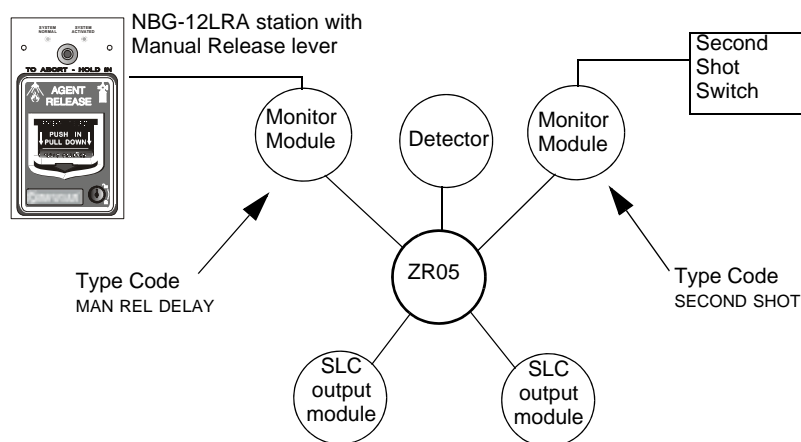

**Figure B.12 Monitor Module Configured as a Second Shot Switch**

With two monitor modules configured as shown above, program releasing zone ZR05 for the following releasing selections: Delay Time = 15, Abort Switch = ULI, Cross Zone = Y, Soak Time = 30

ZR05 can be activated in one of two ways, as described in the examples given below.

**Example 1:** If the detector initiates the alarm, ZR05 activates. Releasing begins after the delay timer has expired (15 seconds). Releasing will continue for the soak timer duration (30 seconds). The Second Shot switch can then be activated, and will remain activated for as long as the switch is held on. Second Shot releasing will end when the switch is no longer held on (behaving like a tracking function).

**Example 2:** If the NBG-12LRA (Type Code MAN REL DELAY) lever is pulled, the delay timer begins its 15 second countdown. Releasing will begin after the delay timer has expired, and will continue for the soak timer duration (30 seconds). The Second Shot switch can then be activated, and will remain activated for as long as the switch is held on. Second Shot releasing will end when the switch is no longer held on (behaving like a tracking function).



## How to Program a Release End Bell Circuit



**NOTE:** A releasing circuit with this Type Code requires the following selections: a Releasing Zone; an output circuit mapped to the same Releasing Zone; Switch Inhibit; Non-Silenceable; No Walk Test.

The following contains information needed to program a Release End Bell circuit for an SLC or Panel Circuit output module.

**Description** An SLC or panel circuit output module to activate an audible or visual device when releasing devices shut off. Multiple outputs with the REL END BELL Type Code can also be mapped to the same Releasing Zone. When all the Releasing Zone functions are complete, all outputs with the REL END BELL Type Code activate at the same time. A REL END BELL circuit remains on until the system is reset.

**Program** Select an SLC or panel circuit output module to use as a Release End Bell circuit. While programming the point (refer to the Point Programming section of this manual for instructions),

1. Select the REL END BELL Type Code,
2. Enter the number of the desired releasing zone into the module's zone map. The releasing zone must be fully programmed (refer to "Releasing Zone" on page 51).

**Example** A programming example of a control module programmed as a Release End Bell for Releasing Zone ZR05.

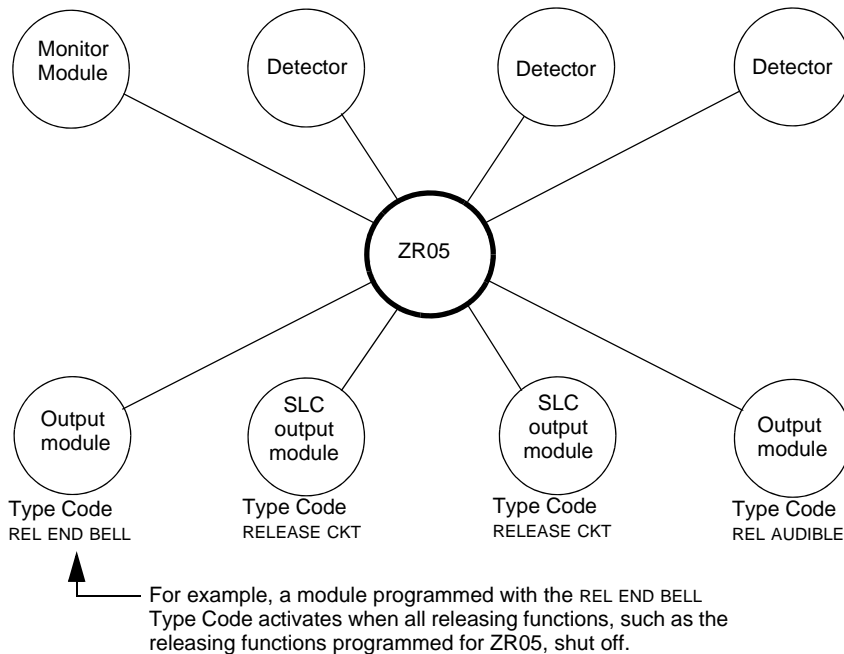

**Figure B.13 Output Module Configured as a Release End Bell Circuit**

## How to Program a ULC Release Circuit



**NOTE:** A ULC Release Circuit with this Type Code requires the following selections: a Releasing Zone; an output circuit mapped to the same Releasing Zone; Switch Inhibit ; Non-Silenceable; No Walk Test.

The following contains information needed to program a ULC Release Circuit for an SLC output module.

**Description**

An SLC output module used to activate a releasing solenoid or other releasing device. Multiple outputs with the REL CKT ULC Type Code can also be mapped to the same Releasing Zone. When the Releasing Zone activates, all outputs with the REL CKT ULC Type Code also activate at the same time. A ULC Release Circuit activates when:

- An initiating device programmed to the same Releasing Zone activates (two devices if using the Cross Zone option)
- The Delay Timer for the Releasing Zone (if used) expires
- No Abort Switch for the Releasing Zone (if used) is active

A ULC Release Circuit —and all wiring to the release device—is fully supervised and usable with power-limited energy cable.

**Program**

Select an SLC output module to use for a ULC Release Circuit. While programming the point (refer to the Point Programming section of this manual for instructions),

1. Select the REL CKT ULC Type Code,
2. Enter the number of the desired Releasing Zone into the module’s zone map. The releasing zone must be fully programmed (refer to “Releasing Zone” on page 51).

**Example**

A programming example of a control module programmed as a ULC Release Circuit for Releasing Zone ZR05.

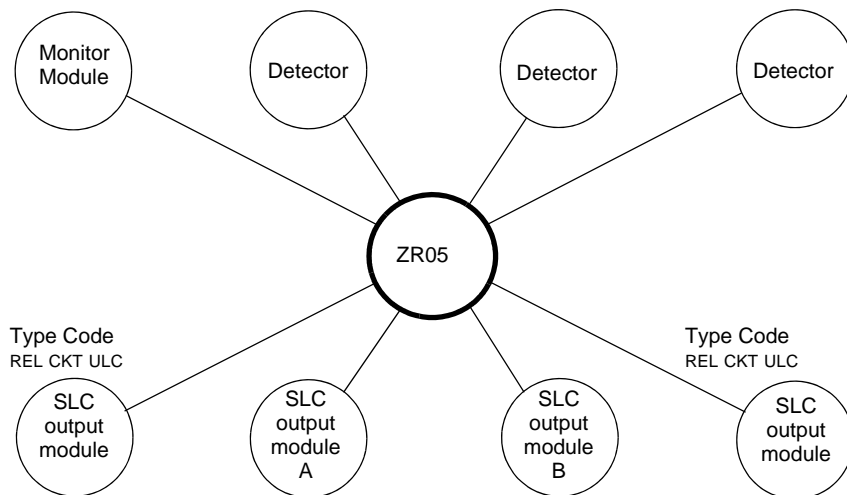

**Figure B.14 Output Module Configured as a ULC Release Circuit**

## How to Program a Release Circuit



**NOTE:** A Release Circuit with this Type Code requires the following selections: a Releasing Zone; an output circuit mapped to the same Releasing Zone; Switch Inhibit; Non-Silenceable; No Walk Test.



**NOTE:** Do not use a Release Circuit for the following: An application requiring ULC Listing; An application requiring power-limited energy cable.

The following contains information needed to program a Release Circuit for an SLC output circuit module.

### Description

An SLC output module used to activate a releasing solenoid or other releasing device. Multiple outputs with the RELEASE CKT Type Code can be mapped to the same Releasing Zone. When the Releasing Zone activates, all outputs associated with the releasing zone and with the RELEASE CKT Type Code also activate at the same time. A Release Circuit activates when:

- An initiating device programmed to the same Releasing Zone activates (two devices if using the Cross Zone option)
- The Delay Timer for the releasing zone (if used) expires
- The Abort Switch for the releasing zone (if used) is not active

### Program

Select an SLC output module to use as a Release Circuit. While programming the point (refer to the Point Programming section of this manual for instructions),

1. Select the RELEASE CKT Type Code
2. Enter the number of the desired Releasing Zone into the module's zone map. The releasing zone must be fully programmed (refer to "Releasing Zone" on page 51).

### Example

A programming example of a control module programmed as a Release Circuit for Releasing Zone ZR05.

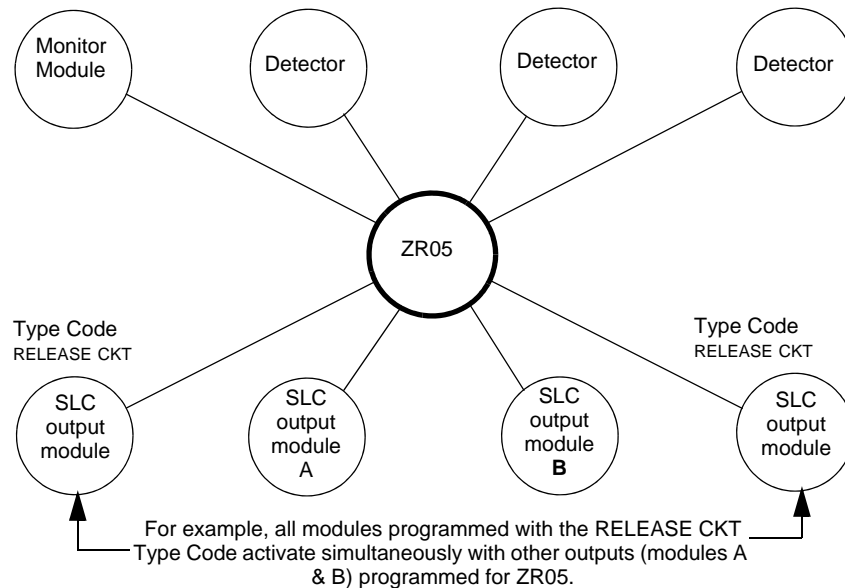

**Figure B.15 Output Module Configured as a Release Circuit**

## How to Program a Release Form-C Circuit



**NOTE:** An output with a REL. FORM C Type Code requires the following selections: a Releasing Zone; an output circuit mapped to the same Releasing Zone; Switch Inhibit; Non-Silenceable; No Walk Test.

The following contains information needed to program a Release Form-C circuit for an SLC Form-C relay output module.

**Description** An SLC output module, configured as a relay, programmed to activate an output by opening or closing a switch. Typical applications include closing doors and air handlers.

**Program** Select an SLC output module to use as a Releasing Form-C Circuit. While programming the point (refer to the Point Programming section of this manual for instructions),

1. Select the REL. FORM C Type Code,
2. Enter the number of the desired Releasing Zone into the module's zone map. The releasing zone must be fully programmed (refer to "Releasing Zone" on page 51).

**Example** A programming example of a control module programmed as a Release Form-C circuit for Releasing Zone ZR05.

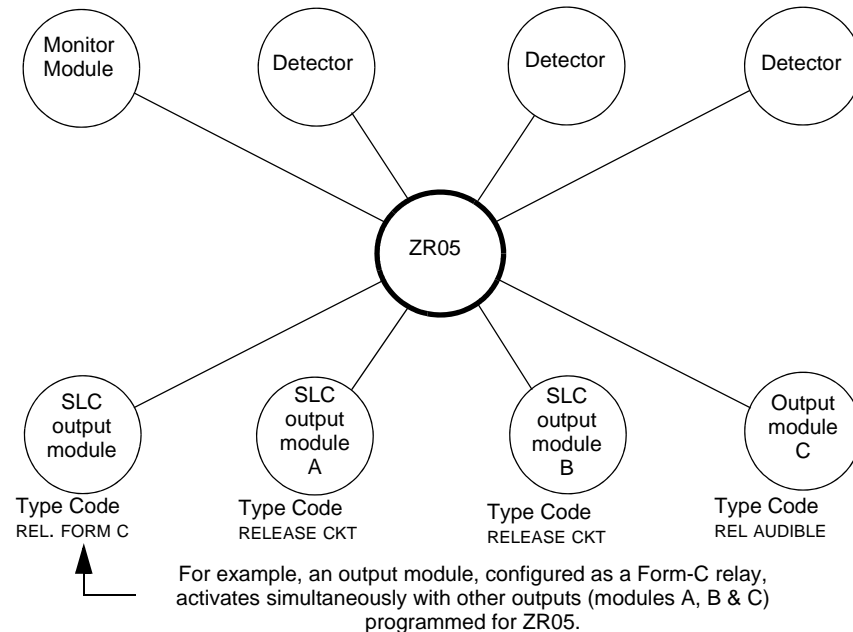

**Figure B.16 Control Module Configured as a Release Form-C Circuit**

## How to Program a Release Audible Circuit



**NOTE:** An output with a REL AUDIBLE Type Code requires the following selections: a Releasing Zone; an output circuit mapped to the same Releasing Zone; Switch Inhibit.

The following contains information needed to program a Release Audible circuit for an SLC or Panel Circuit output module.

**Description** An output module programmed to activate an audio or visual device when all releasing outputs, programmed to the same Releasing Zone, turn on. Multiple outputs with the REL AUDIBLE Type Code can be mapped to the same Releasing Zone. When the Releasing Zone activates, all outputs with the REL AUDIBLE Type Code activate at the same time.

**Program** Select a control module or panel circuit module to use as a releasing circuit. While programming the point (refer to the Point Programming section of this manual for instructions),

1. Select the REL AUDIBLE Type Code,
2. Enter the number of the desired Releasing Zone into the module's zone map. The releasing zone must be fully programmed (refer to "Releasing Zone" on page 51).

**Example** A programming example of a control module programmed as a Release Audible circuit for Releasing Zone ZR05.

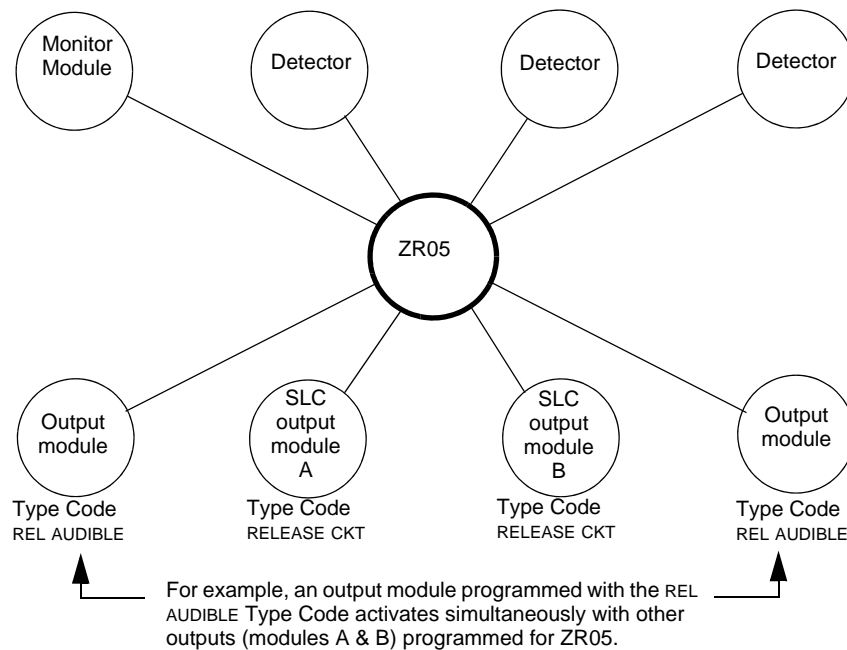

**Figure B.17 Output Module Configured as a Release Audible Circuit**

## How to Program an Instant Release Circuit



**NOTE:** An output with an INST RELEASE Type Code requires the following selections: a zone selection (a releasing zone may be used, but is not required); an output circuit mapped to the same zone; Switch Inhibit; Non-Silenceable; No Walk Test.

The following contains information needed to program an Instant Release circuit for an SLC output module.

- Description** An SLC output circuit module programmed to activate non-releasing devices, such as door openers or warning sounders, without counting down delay timers. A device programmed with the INST RELEASE Type Code device is supervised for open circuits and ground faults.
- Program** Select an SLC output module to use with a releasing circuit. While programming the point (refer to the Point Programming section of this manual for instructions),
1. Select the INST RELEASE Type Code,
  2. Enter the number of the desired Releasing Zone into the module's zone map. The releasing zone must be fully programmed (refer to "Releasing Zone" on page 51).

**Example** A programming example of a control module programmed as an Instant Release circuit for Releasing Zone ZR05.

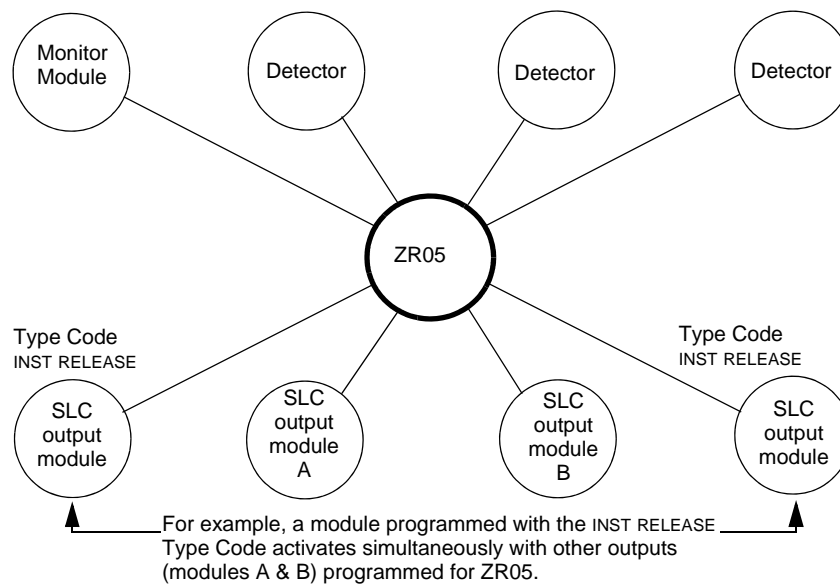

**Figure B.18 Output Module Configured as an Instant Release Circuit**

## How to Program a Release Code Bell Circuit

When coded output is desired to indicate different phases of a releasing operation, the panel can be programmed using Control-By-Event (CBE) to turn on outputs set to provide the chosen codes.

### Example Description

In the following example, programming is shown that will

1. Turn on an output when the first alarm activates in a releasing zone, but Cross Zone conditions are not met. Turn it off when the Delay Timer starts.
2. Turn on a different output when Cross Zone conditions are met and the Delay Timer activates, and turn it off when releasing starts.
3. Turn on a different output when releasing starts, and turn it off when the system is reset.

The outputs are each set to a code appropriate for one of the three releasing phases: for example, one code for the first alarm, a faster code when the Delay Timer activates, and a continuous tone during releasing.

### Program

Program releasing zone ZR1 as follows:

ZR1 = Delay Time:15, Abort Switch:ULI, Cross Zone:YES, Soak Time:120

Map ZR1 to all inputs and outputs shown in this example.

Program logic zones as follows:

ZL1 = AND(OR(L1D1,L1D2,L1D3,L1D4,L1D5,L1D6),NOT(L1M30))

When conditions are met for ZL1, a first alarm has occurred in the releasing zone, but the Delay Timer has not yet started. Map ZL1 to an output set to the code chosen for a first alarm (L1M31 in this example).

ZL2 = AND(L1M30,NOT(L1M20))

When conditions are met for ZL2, the Delay Timer has started, but releasing has not begun. Map ZL2 to the output set to the code chosen for when the Delay Timer activates (L1M32 in this example).

ZL3 = OR(L1M20)

When conditions are met for ZL3, the 120 second releasing operation has begun. Map ZL3 to the output that produces a continuous tone (L1M33 in this example).

Program output Type Codes as follows:

L1M20 = RELEASE CKT , L1M30 = INST RELEASE , L1M31 = CONTROL, L1M32 = CONTROL,  
L1M33 = CONTROL

### Illustration

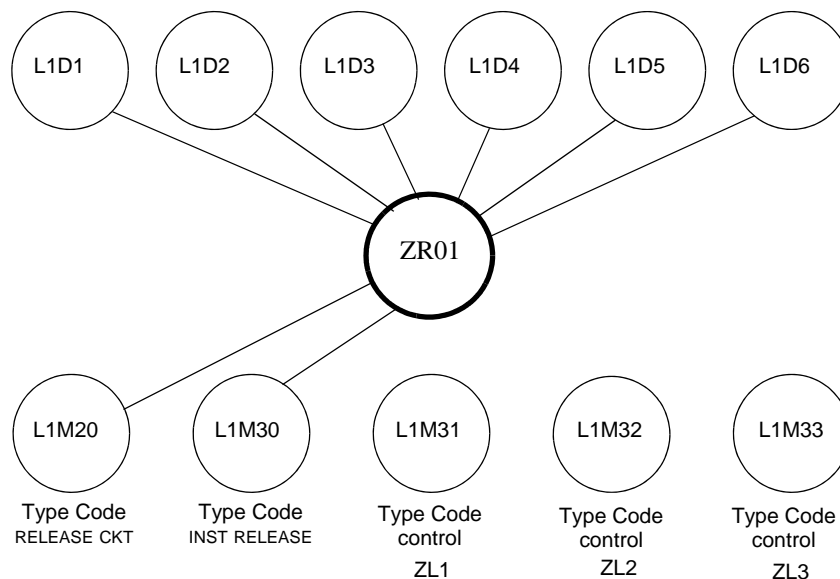

Figure B.19 A Release Code Bell Circuit Configuration

## B.4 Miscellaneous

### B.4.1 Initiating Devices

Releasing zone initiating devices include the following:

- 5351J intelligent heat detectors
- 1351J, 2351J, 2351TMJ, 7351J intelligent smoke detectors
- Conventional detection UL-listed devices connected to monitor modules

Multiple zone initiating devices can be used for the same releasing hazard. Map zone initiating devices to the same Releasing Zone. Factory Mutual and certain Local Authorities Having Jurisdiction require using redundant wiring (NFPA 72 Style 6 or Style D) for initiating devices in releasing applications.

### B.4.2 Warning Sounders

Warning sounders connect to SLC or Panel Circuit output module circuits (refer to this panel's installation manual). Note the following:

- If selecting Cross Zones, a warning sounder only activates when two zones alarm.
- Warning sounders—unlike release solenoids—do not wait for a Delay Timer.
- If Coding Functions are required for warning sounders, use an SLC output module.
- The same releasing hazard can activate multiple NACs.

Instructions for activating warning sounders:

To activate a sounder	Do this
When the Delay Timer starts, when the releasing device activates, or both	Map the SLC or Panel Circuit to a releasing hazard zone (R0-R9).
Immediately when one of the initiating devices activate	Map the SLC or Panel Circuit output to a separate zone (not R0-R9) that is also mapped to all initiating devices of the hazard.

### B.4.3 Auxiliary Control Functions

Instructions for using control functions:

Function	Do this
A releasing application requires control relays	Use control modules set for dry contact operation. Program the control relays for different functions by following the instructions in "To activate a sounder" above.
Providing control functions	Use an ACM-8R remote relay module mapped to the software zones of the control panel.

### B.4.4 ACS Annunciation

Releasing points may be mapped to annunciators using annunciator point programming (Refer to "ACS Point Programming" on page 28).



# Appendix C: Special Zone Outputs

## C.1 Presignal and Positive Alarm Sequence (PAS)

### C.1.1 What is Presignal and PAS?

#### Purpose

Presignal is a feature that initially causes alarm signals to only sound in specific areas, monitored by qualified persons. This allows delay of the alarm up to 180 seconds after the start of alarm processing. The control panel Presignal feature provides two selections:

- A **Presignal Delay Timer** (1:00 to 3:00 minutes) that delays activation of all outputs with a CBE that includes Special Zone ZF0.
- A **PAS** (Positive Alarm Sequence) selection, in addition to the Presignal Delay Timer, that allows a 15-second time period for acknowledging an alarm signal from a fire detection/initiating device. If the alarm is not acknowledged within 15 seconds, all local and remote outputs activate immediately and automatically.

An illustration of Presignal and PAS timing.

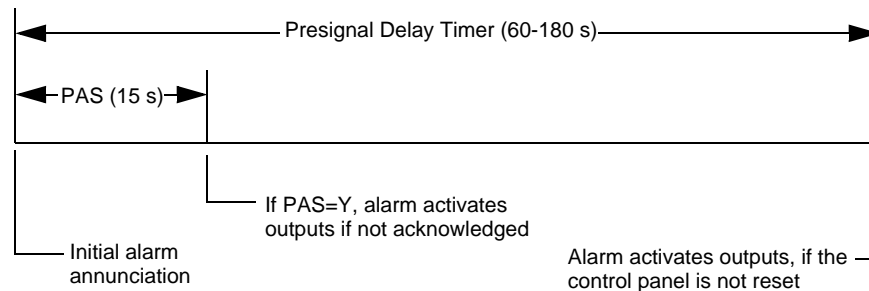

**Figure C.1 Presignal and PAS Time**

The control panel delays activation of outputs containing ZF0 in their zone maps for all alarm initiating devices that contain ZF0 in their CBE list. A subsequent alarm will abort the Presignal Delay Timer and execute CBE lists.

#### Notes on using ZF0

- NFPA 72 requires installation of a PAS Inhibit switch, that can be used to turn off the PAS delay timer when the control panel is unattended. Do so by programming a monitor module with the Type Code, PAS INHIBIT.
- The Presignal Delay timer countdown can be stopped by pressing the SYSTEM RESET key before the timer expires.
- Program zone ZF0 to participating inputs and outputs.

#### Restrictions on using ZF0

- Do not include ZF0 in the CBE list for a releasing device.
- Do not include ZF0 in the CBE list for any monitor module that connects to a device other than an automatic fire detector.

### C.1.2 Selecting Presignal and PAS Outputs

#### Presignal

The Presignal Delay Timer can be set to a value between 60 and 180 seconds. A Presignal Delay Timer does not apply to the following:

- System Alarm relay

- TM-4 polarity reversal alarm output
- TM-4 municipal box output
- UDACT

### Positive Alarm Sequence (PAS)

Outputs selected for PAS delay for 15 seconds. Acknowledgement within the 15-second delay will set the Presignal Delay Timer to the full programmed value (60-180 seconds, including the PAS delay of 15 seconds). When an alarm comes from an initiating device with a CBE list that includes ZF0, the control panel delays the following outputs:

- System Alarm relay
- TM-4 polarity reversal alarm output
- TM-4 municipal box output
- UDACT

## C.2 Coding Functions for Panel Circuit Outputs

Coding Functions are selectable pulsed signals that energize Panel Circuit outputs when a fire alarm occurs.



**NOTE:** Do not include ZF8 in the zone map of Panel Circuits used for releasing or zone coding applications.

Select Coding Functions on a global basis by setting the Panel Circuit Bell Coding field to March or Temporal. (Refer to “Panel Settings (2) Screen” on page 22). Select individual panel circuit output points for coding participation by entering ZF8 in the point’s zone map. All Panel Circuit outputs with ZF8 in their zone maps will sound the same code when activated. The table below contains descriptions of each Coding Function selection:

Coding Function Selection	Signal
March Time (default)	120 PPM (pulses per minute)
Temporal	0.5s on, 0.5s off, 0.5s on, 0.5s off, 0.5s on, 1.5s off, repeats

**Table C.1 Coding Function Selections**

# Appendix D: AWACS™ Applications

## D.1 AWACS Overview

AWACS™ (Advanced Warning Addressable Combustion Sensing) is a set of software algorithms that provide the IFC-3030 with industry-leading smoke detection capability. The user can program AWACS functions on a global or on a per-detector basis.

AWACS topics covered in this appendix:

Topic	Page
<b>AWACS features</b> – Descriptions of AWACS features, such as Drift Compensation, Sensitivity Adjust, programmable on a per-detector basis.	115
<b>Pre-Alarm</b> – Alert and Action settings, programming (global settings).	118
<b>Detector Sensitivity Settings</b> – Pre-Alarm and Alarm sensitivity settings for photo, ion, laser, and multisensor detectors programmable on a per-detector basis.	119
<b>Detector Maintenance Features</b> – Instructions for viewing and printing detector maintenance information.	121

## D.2 AWACS Features

AWACS features include the following:

- Drift Compensation and Smoothing
- Maintenance Warnings - Three Levels
- Self-optimizing Pre-Alarm
- Detector Sensitivity
- Cooperative Multi-Detector Sensing

### D.2.1 Drift Compensation and Smoothing

Drift compensation uses algorithms (U.S. patent pending) that identify and compensate for long-term changes in the analog readings from each smoke detector. (Typically, dirt and dust accumulation inside the smoke chamber causes long-term changes in detector readings.) Drift compensation does the following:

- Allows a detector to retain its original ability to detect actual smoke, and resist false alarms, even as dirt and dust accumulates.
- Reduces maintenance requirements by allowing the control panel to automatically perform the periodic sensitivity measurements required by NFPA Standard 72.

The software also provides smoothing filters to remove transient noise signals, usually caused by electrical interference. Different smoothing algorithms are used, depending on the sensitivity selection of each detector. Refer to “Detector Sensitivity Settings” on page 119 for more information on detector sensitivity levels.

A graphic representation of a detector analog reading using drift compensation and smoothing:

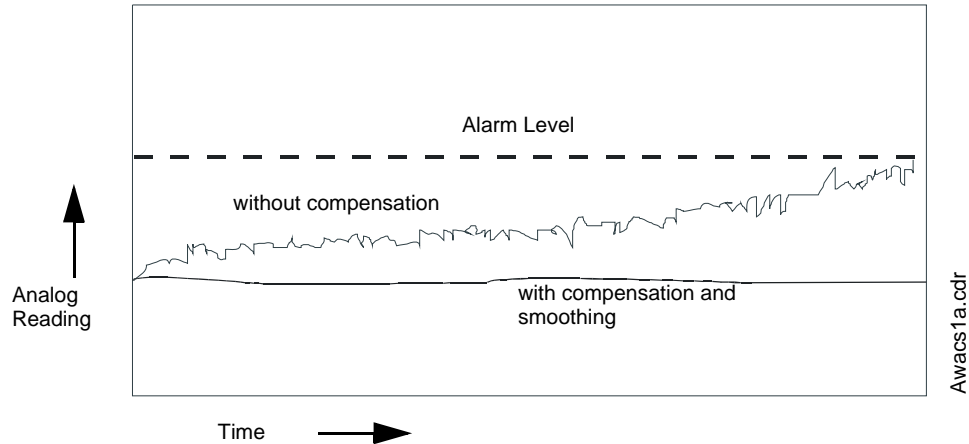

**Figure D.1 Graphic Representation of Drift Compensation**

### D.2.2 Maintenance Warnings – Three Levels

The software determines when the drift compensation for a detector reaches an unacceptable level that can compromise detector performance. When a detector reaches an unacceptable level, the control panel indicates a maintenance warning. The table below summarizes the three levels of AWACS maintenance warnings:

Detector Trouble Message	Indicates	Detector Compensation Percentage Range		
		Ion	Photo or Photo with Heat	Laser
N/A	Compensation is within acceptable range.	6 - 80	6 - 45	3 - 50
LOW THRESHOLD	A hardware problem in the detector.	0 - 5	0 - 5	0 - 2
MAINTENANCE REQ	Dust accumulation that is near but below the allowed limit. The Maintenance Required is an alert level that indicates the need for maintenance before the performance of the detector is compromised.	92 - 99	92 - 99	83 - 99
MAINT.URGENT	Dust accumulation above the allowed limit.	100	100	100

**Table D.1 Definitions of AWACS Maintenance Levels**

A graphic representation of the maintenance levels:

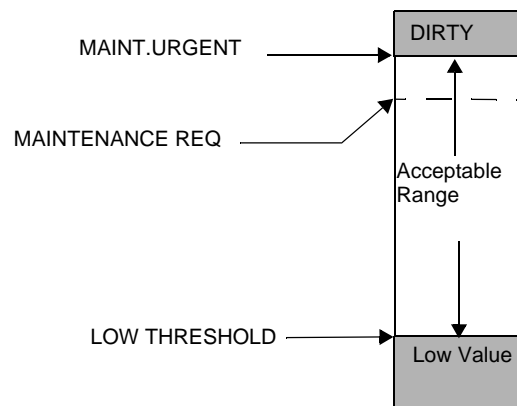

**Figure D.2 Diagram of Maintenance Levels**

### D.2.3 Self-Optimizing Pre-Alarm

You can set each detector, except 5351J (Heat), for Self-Optimizing Pre-Alarm (PA=1). In this Self-Optimizing mode, the software measures the normal peak analog readings and sets the Pre-Alarm level just above these normal peaks. This allows extremely sensitive Pre-Alarm capability with reasonable protection against non-fire signals. The figure below shows a graphical representation of the Self-Optimizing Pre-Alarm level:

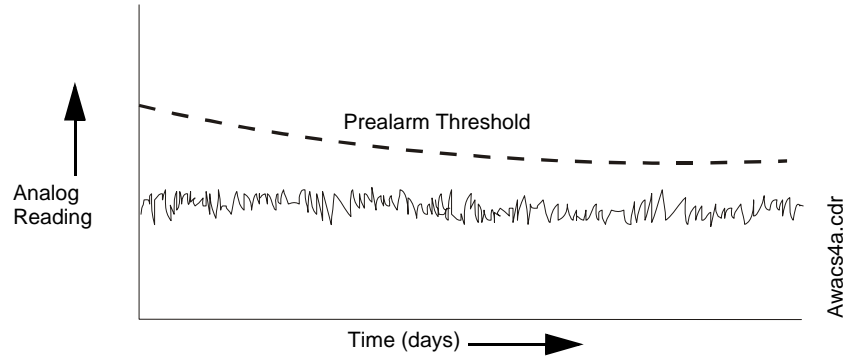

Figure D.3 Self-optimizing Pre-Alarm Level

### D.2.4 Detector Sensitivity

The control panel provides nine Sensitivity Levels (Table D.2 on page 120) for alarm detection and pre-alarm as follows:

- **Alarm Sensitivity Levels** You can select the sensitivity of a detector from 1-9 (1=highest sensitivity; 9=lowest sensitivity).
- **Pre-Alarm Sensitivity Levels** You can select one of nine levels from 1 to 9 (0=no Pre-Alarm, 1=self-optimizing, 2=highest sensitivity, 9=lowest sensitivity). You can set Pre-Alarm operation to Action (latching) or Alert (non-latching) and to activate Special Zones. For instructions on programming, refer to “Pre-Alarm” on page 118.

You can set the sensitivity levels as fixed or programmed for day and night operation. For details, refer to “Coding Functions for Panel Circuit Outputs” on page 114.

A sample sensitivity window for a laser detector:

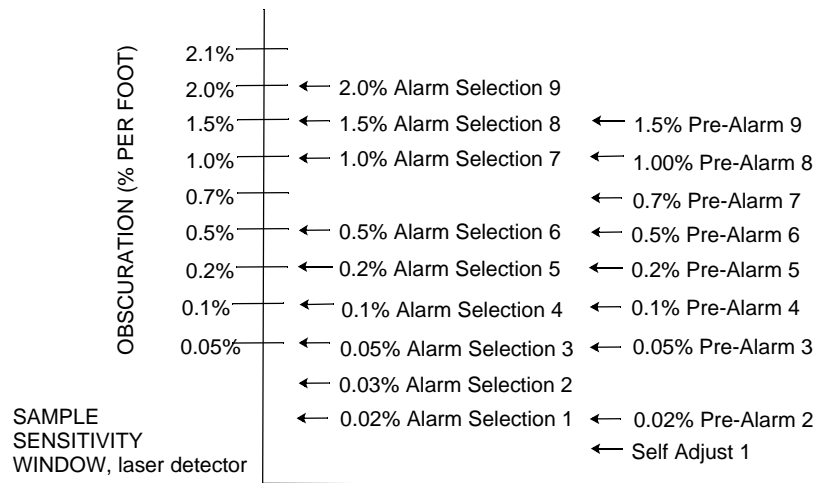

Figure D.4 Sample Sensitivity Levels for a FlashScan View Laser Detector

## D.2.5 Cooperative Multi-Detector Sensing

Cooperative Multi-Detector Sensing is the ability of a smoke detector to consider readings from nearby detectors in making alarm or pre-alarm decisions. Each detector can include up to two other detectors in its decision. Without statistical sacrifice in the ability to resist false alarms, Cooperative Multi-Detector Sensing allows a detector to increase its sensitivity to actual smoke by a factor of almost 2 to 1. Ion, photo and laser detector types can participate. Cooperative Multi-Detector Sensing also allows the combination of ionization with photoelectric technology in reaching an alarm decision. The figure below shows a graph representing Cooperative Multi-Detector Sensing:

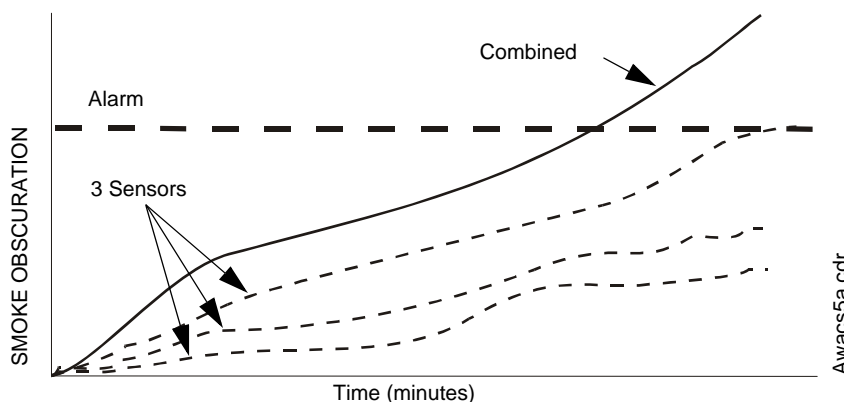

Figure D.5 Cooperative Multi-Detector Sensing

## D.3 Pre-Alarm

### D.3.1 Definition

The Pre-Alarm function is a programmable option which determines the system's response to real-time detector sensing values above the programmed setting. Use the Pre-Alarm function to get an early warning of incipient or potential fire conditions. There are two levels of Pre-Alarm:

- Alert (Refer to "Alert Level" below)
- Action (Refer to "Action Level" on page 119)

Alert and Action Pre-Alarm settings are set with point programming. Unique Pre-Alarm sensitivity levels (PA) for individual detectors are listed in "Detector Sensitivity Settings" on page 119.

The LEDs on detectors polled in FlashScan mode will light steady green when in pre-alarm.

### D.3.2 Alert Level

#### Alert Functions

The control panel software, in addition to checking for alarm levels, checks for Pre-Alarm thresholds for each addressable, intelligent smoke detector programmed for Pre-Alarm. If a detector's real-time sensing level exceeds the programmed Alert threshold, the control panel indicates a Pre-Alarm condition for the detector. The control panel does the following functions when a detector reaches pre-alarm level:

- The Pre-Alarm message is sent to the History buffer and to installed printers. The message is sent (and time stamped) at the time that it first occurred. This historical data could provide valuable information about the progress of a fire.
- The PRE-ALARM LED flashes and the panel sounder pulses until acknowledged.
- Zone Z000 (general alarm) or any other zone and the System Trouble and System Alarm relays do not activate.

- The Pre-Alarm indication for this detector will restore automatically to normal if its sensitivity, programmable to one of nine settings, drops below pre-alarm level.
- A subsequent alarm for this detector also clears the Pre-Alarm indication.

### D.3.3 Action Level

#### Action Functions

If you program a detector for Action Pre-Alarm and the detector reaches a level that exceeds the programmed Pre-Alarm level, the control panel indicates an Action condition. The control panel does the following functions when a detector reaches the programmed pre-alarm level:

- The Action message is sent to the History buffer and installed printers. The message is sent (and time stamped) only at the time that it first occurred. This historical data could provide valuable information about the progress of a fire.
- The PRE-ALARM LED and panel sounder pulse until acknowledged.
- The zone that is in the tenth position of the zone map for this detector activates. The tenth zone is the right-most entry on line two of the detector zone map list in the Point Programming screen. (For more information on detector zone positions, refer to Figure 3.25 and the accompanying text). The tenth zone can be used to control functions of a detector or group of detectors once the pre-alarm level is reached. Tenth zone activations also allow ACS annunciation by a detector or group of detectors in Action Pre-Alarm condition.
- Zone Z000 (general alarm) or any other zone and the System Trouble and System Alarm relays do not activate.
- The Pre-Alarm condition and the zone programmed will latch until system reset, even if the sensitivity drops below the pre-alarm level.
- A subsequent alarm condition for this detector clears the Action indication from the LCD display alarm list.

## D.4 Detector Sensitivity Settings

### D.4.1 How to Select Pre-Alarm and Alarm Sensitivity

Each detector provides a host of selectable intelligent options. The control panel provides nine levels of Pre-Alarm (PA:1–PA:9) and Alarm (AL:1–AL:9) in percent per foot obscuration:

- **PA:0** no Pre-Alarm selection.
- **PA:1** the self-optimizing setting where the control panel selects a suitable Pre-Alarm level for a detector.
- **PA:2–PA:9** the detector Pre-Alarm sensitivity level - with PA:2 the most sensitive and PA:9 the least sensitive.
- **AL:1–AL:9** the detector Alarm sensitivity level - with AL:1 the most sensitive and AL:9 the least sensitive.

Detector Type	Alarm (FlashScan)	Pre-Alarm	
Photo Electric SMOKE (PHOTO) (See note * )	AL:1=0.50 % AL:2=0.73 % AL:3=0.96 % AL:4=1.19 % AL:5=1.43 % AL:6=1.66 % AL:7=1.89 % AL:8=2.12 % <sup>~</sup> AL:9=2.35 %	PA:1=Auto PA:2=0.30 % PA:3=0.47 % PA:4=0.64 % PA:5=0.81 % PA:6=0.99 % PA:7=1.16 % PA:8=1.33 % <sup>~</sup> PA:9=1.50 %	
Ion SMOKE (ION) (See notes * , † and ‡ )	AL:1=0.50 % AL:2=0.75 % AL:3=1.00 % AL:4=1.25 % AL:5=1.50 % AL:6=1.75 % <sup>~</sup> AL:7=2.00 % AL:8=2.25 % AL:9=2.50 %	PA:1=Auto PA:2=0.40 % PA:3=0.50 % PA:4=0.75 % PA:5=1.00 % PA:6=1.25 % <sup>~</sup> PA:7=1.50 % PA:8=1.75 % PA:9=2.00 %	
FlashScan View Laser See Note ‡ )	AL:1=0.02 % AL:2=0.03 % AL:3=0.05 % AL:4=0.10 % AL:5=0.20 % AL:6=0.50 % <sup>~</sup> AL:7=1.00 % AL:8=1.50 % <sup>**</sup> AL:9=2.00 %	PA:1=Auto PA:2=0.02 % PA:3=0.05 % PA:4=0.10 % PA:5=0.20 % PA:6=0.50 % <sup>~</sup> PA:7=0.70 % PA:8=1.00 % PA:9=1.50 %	
Acclimate Multi-Sensor	AL:1=0.50 % AL:2=1.00 % AL:3=1.00 to 2.00 % AL:4=2.00 % AL:5=2.00 to 3.00% <sup>~</sup> AL:6=3.00 % AL:7=3.00 to 4.00 % AL:8=4.00 % AL:9=thermal 135°F	Alarm (CLIP) AL:1=1.00 % AL:2=1.00 % AL:3=1.00 to 2.00 % AL:4=2.00 % AL:5=2.00 to 4.00% <sup>~</sup> AL:6=2.00 to 4.00% AL:7=2.00 to 4.00% AL:8=4.00 % AL:9=4.00%	PA:1=0.50% PA:2=1.00 % PA:3=1.00 % PA:4=1.00 to 2.00% PA:5=1.00 to 2.00 % <sup>~</sup> PA:6=2.00 % PA:7=2.00 % PA:8=2.00 to 3.00 % PA:9=2.00 to 3.00 %
Heat (Adjustable Threshold)	AL:1=43 °C AL:2=57 °C AL:3=63 °C <sup>~</sup> AL:4=68 °C AL:5=74 °C AL:6=88 °C AL:7=88 °C AL:8=88 °C AL:9=88 °C	PA:1=40 °C PA:2=43 °C PA:3=57 °C <sup>~</sup> PA:4=65 °C PA:5=70 °C PA:6=75 °C PA:7=75 °C PA:8=75 °C PA:9=75 °C	
Beam Detector See Note †† )	AL:1=25% AL:2=30% AL:3=40% AL:4=50% AL:5=30 - 50% AL:6=40 - 50%	PA:1=50% PA:2=55% PA:3=60% PA:4=65% PA:5=70% PA:6=75% PA:7=80% PA:8=85% PA:9=90%	

<sup>~</sup>Signifies the factory default setting.

\* Detectors are suitable for open area protection within the listed air velocity range. Typically, this range is 0 - 4,000 ft/min for photoelectric detectors and 0 - 1,200 ft/min for ionization detectors. Be sure to confirm this range before installing the detector by referring to the manufacturer's installation instructions.

† Use only alarm sensitivity setting of AL=1, AL=2 or AL=3 for ION detectors installed in Canada.

‡ The use of alarm sensitivities below 0.50% obscuration per foot requires a 90 day test to ensure that the environment for the detectors is suitable for the higher sensitivity setting. (Refer to "To Test Detectors Set Below 0.50% Obscuration per Foot" on page 121.)

\*\* 1% max. on CLIP. Larger figures may display.

†† Refer to the beam detector manual to determine the alarm settings: they are a function of the distance between the detector and its reflector. There is no Prealarm for beam detectors in CLIP mode.

**Table D.2 Detector Sensitivity Settings**



## D.4.2 To Test Detectors Set Below 0.50% Obscuration per Foot

Using alarm sensitivities below 0.50% obscuration per foot requires a 90-day test to ensure that the detector environment is suitable for the higher sensitivity setting. To meet Notifier and Underwriters Laboratory requirements, test each detector planned to operate below 0.50%/ft obscuration as follows:

1. Set the detector as follows:

Step	Action
1	Initially set to the 0.50% obscuration per foot Alarm level.
2	Set the Pre-Alarm level to the desired final Alarm sensitivity.
3	Set the Pre-Alarm to Alert mode (non-latching).

2. Operate detectors continuously for 90 days with all environmental factors (such as, temperature, humidity, air flow, occupancy, and so on) similar to the intended application for the detectors. Record all events for each tested detector with an electronic History buffer or a printout.
3. At the end of the 90-day test: An authorized Notifier representative, or an end user trained by an authorized Notifier representative must inspect the results of the test. If the test results show no alarms or pre-alarms for the tested detectors, reprogram the fire alarm system to set the Alarm sensitivity to the more sensitive Pre-Alarm level of the test.

## D.5 Detector Status Display

### D.5.1 Detector Maintenance Display

Should the panel detect a low chamber value or maintenance condition with a detector, it will generate a point trouble as described in the operations manual for this panel. The following Read Status screen displays detector information that applies to the state of the smoke detector. It can be reached with the following commands, starting at the Main Menu screen:

- Press MAI N MENU
- Press READ STATUS
- Press READ STATUS POI NT SELECT (enter the detector point address)
- Press ACCEPT

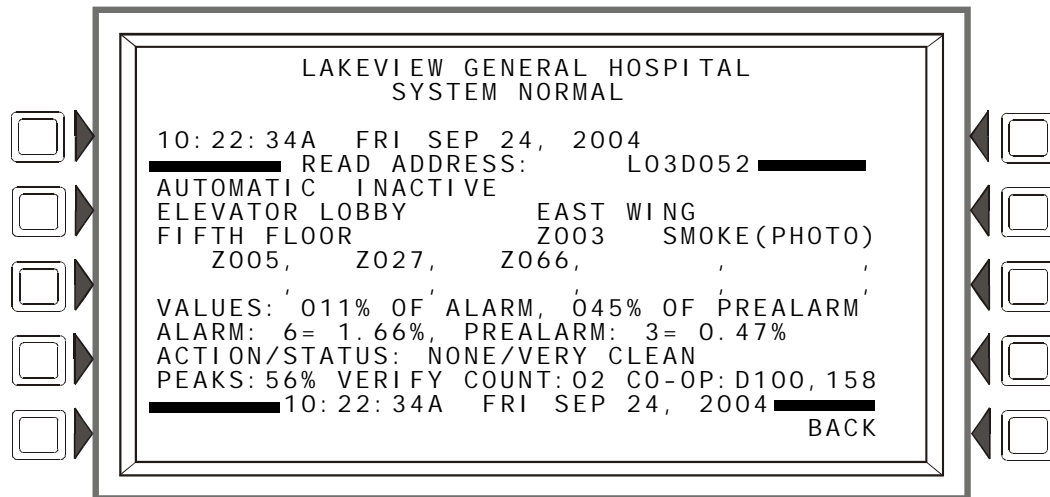

Figure D.6 Smoke Detector Screen - Read Status

## D.5.2 Print a Detector Maintenance Report

A Detector Maintenance Report lists detector maintenance status for each installed addressable detector [except 5551J/5551JR (analog heat detector)].

To print this report, press the Printer Function soft key at the Main Menu, then press the Detector Maintenance Report soft key sends a Detector Maintenance Report (Figure D.7) to the printer connected to the control panel.

```
*****DETECTOR MAINTENANCE*****
NORMAL SMOKE(LASER) Detector      L01D001 000330us 000340us  Comp: 000% Pk: 002%
AI arm: 000% PreAI arm: 000% A6P6 V000                                L01D001

NORMAL SMOKE ACCLIM Detector      L01D002 000030us 000000us  Comp: 000% Pk: 000%
AI arm: 000% PreAI arm: 000% A8P8 V000                                L01D002
```

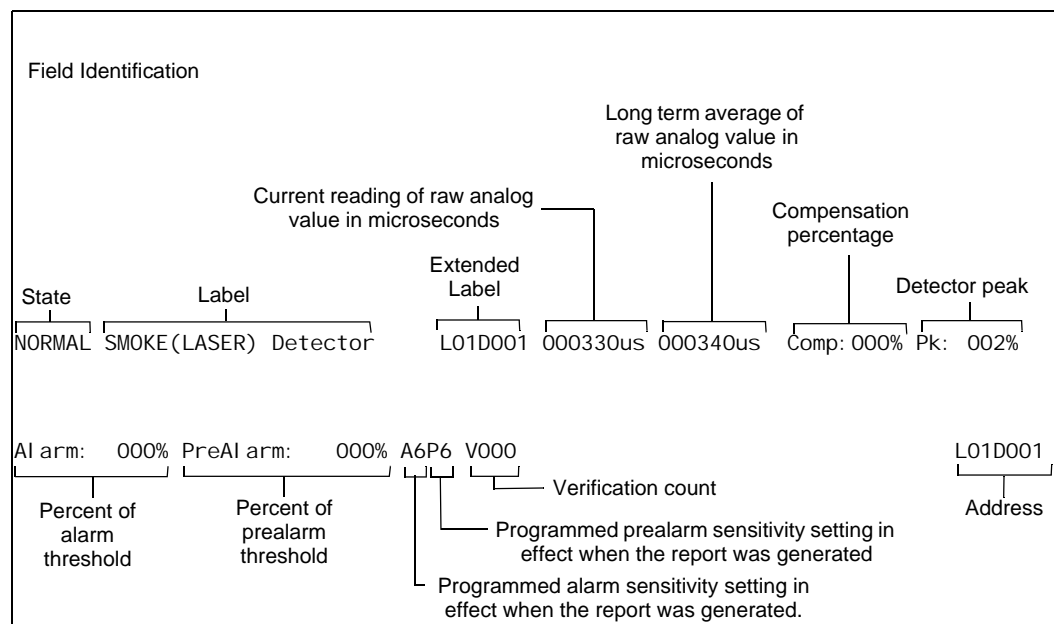

Figure D.7 Sample Detector Maintenance Report

## D.5.3 To Interpret a Detector Status Display or Maintenance Report

The Detector Read Status Screen and Detector Maintenance Report provides the same information (such as Device Status, Peak Value) about a detector. This section contains descriptions of each item that appears in a Detector Read Status Screen or a Detector Maintenance Report.

### Display Information

Lines 1- 4 - This could display any current event message, or, as in this example, the System Normal message

Line 5 - Screen title and the address of the point being read

The area between the separator lines, lines 6-14, shows all information concerning the selected point, which is L03D052 in the above example.

Line 6 - Line 6 displays two statistics that display for inputs (detectors and modules) and zones; in the above example they are:

```
AUTOMATI C      I NACTI VE
```

The first field displays the point control. There are three designations that could appear in this field

Point Control Designation	Description
AUTOMATI C	The point is being controlled automatically by the panel.
DI SABLED	The point has been forced into a disabled state by an outside source.
TROUBLE	The point is in a trouble state and is no longer functioning automatically.

The second field displays the point status. There are two designations that could appear in this field.

Point Status Designation	Description
I NACTI VE	The point is currently reporting no events.
ACTI VE	The point is currently in an off-normal status.
PREALARM	The point is currently in a prealarm status.

The device is a detector (an input device) so by referring to the descriptions below, it can be determined that the point is in a normal state.

**Inputs: (detectors, monitor modules, zones)**

If the point is not in trouble or disabled, and the point is automatically controlled by the panel, the display will be one of the following:

AUTOMATI C I NACTI VE  
 AUTOMATI C ACTI VE  
 AUTOMATI C PREALARM

If the point is disabled, the display will be one of the following. The Trouble Status field will appear if the point is in trouble.

DI SABLED I NACTI VE <Trouble Status>\*  
 DI SABLED ACTI VE <Trouble Status>\*  
 DI SABLED PREALARM <Trouble Status>\*

If the point is in trouble, the display will read:

TROUBLE I NACTI VE <Trouble Status>\*  
 TROUBLE ACTI VE <Trouble Status>\*  
 TROUBLE PREALARM <Trouble Status>\*

\*The field <Trouble Status> will contain a device trouble message. Refer to this panel’s Operations manual for information on these messages.

Line 7 - The custom label for this point

Line 8 - Continuation of the point’s custom label, first zone, and device type

Lines 9,10 - a display of all the zones that contain the current point being read.

Lines 11through 14 -These lines will have values in them only if the device is a detector. They will not display for wireless detectors.

Line 11

**VALUES:**

The screen displays the Alarm and Prealarm values that are in effect when read status is requested. For example, if occupied settings are in effect, occupied values will display

121% OF ALARM - This field gives the detector reading as it relates to its preprogrammed alarm level value (indicated in the next line on the screen). The example above shows the detector exceeding the alarm level by 21%.

145% OF PREALARM - This field gives the detector reading as it relates to its preprogrammed prealarm level value (indicated in the next line on the screen). The example above shows the detector exceeding the prealarm level by 45%.

If the detector is an Alert heat detector, the value is indicated by a temperature reading (example: 148 DEGREES F).

#### Line 12

The screen displays the Alarm and Prealarm levels that are in effect when read status is requested. For example, if unoccupied settings are in effect, they will display.

ALARM: 6=1.66% - Six is the preprogrammed alarm level value for this detector: its value is 1.66%, indicating the percent per foot obscuration value assigned to level 6.

PREALARM: 3=0.47% - Three is the preprogrammed alarm level value for this detector: its value is 0.47%, indicating the percent per foot obscuration value assigned to level 3.

#### Line 13

ACTI ON/STATUS: NONE/VERY CLEAN - This displays the maintenance status of the device. The message that appears in this field depends on the drift compensation value. A detector will automatically compensate for environmental contaminants and other factors over time, until the tolerance value has been exceeded. The FACP will signal a trouble condition when this level has been reached. Refer to the following table for messages and required action.

Message	Description
Replace/Malfunction	Replace the defective detector. The detector may not operate properly.
None/Very Clean	No action necessary. The detector readings are near ideal.
None/Clean	No action necessary. Although not ideal, the detector will activate at the selected sensitivity level.
None/Fairly Clean	No action necessary. The detector will activate at the selected sensitivity level.
Needs Cleaning	Clean the detector soon. The detector may cause a false alarm because it has reached the drift compensation tolerance value.
Needs Immediate Cleaning	Clean immediately! The detector is a false alarm risk. The drift compensation tolerance value has been exceeded.

Line 13 will not display for Acclimate detectors.

#### Line 14

PEAKS: 56% - This value represents the highest percent per foot obscuration reading taken by this detector. It can be a historical figure, and does not necessarily represent the highest reading for this particular alarm. Re-initializing the detector would reset this value to zero.

VERI FY COUNT: 02 - This displays the number of times the detector has gone into alarm. This count aids in differentiating false alarms from actual alarms by showing repeated alarm events that have come into the device. In this example, the detector has gone into alarm two times since the verification count was begun. The FACP will signal a trouble condition when the verify count exceeds 20.

CO-OP: D100, 158 - Indicates the address(es) of any detector(s) linked with the detector that's in alarm for Co-operative Multi-Alarm Sensing. This field will not display for Acclimate detectors.

Line 15 - The current time and date are displayed in this line.

# Appendix E: CBE: Zones and Equations

CBE (Control-By-Event) is a software function that provides a means to program a variety of output responses based on various initiating events. The control panel operates CBE through lists of zones. A zone becomes listed when it is added to a point's zone map through point programming.

- Each input point (detector, monitor module, Panel Circuit module) can list up to ten zones. Allowable zone types are general zone, releasing zone, and special zone.
- Each output point (control module, Panel Circuit module) can list up to ten zones. Allowable zone types are general zone, logic zone, releasing zone, special zone, and trouble zone.
- Output points can list zone Z000 (general alarm). Non-Alarm or Supervisory points do not activate zone Z000 (general alarm).

Networked CBE, or CCBE (Cooperative Control-By-Event), provides CBE initiating-event/output-response relationships over the network through general, logic, and/or trouble zones. One of these zones, programmed into the zone maps of points on this panel and points on other nodes, will create network cause-and-effect relationships based on the type and content of the zone.

## E.1 Zones

There are five types of zones that may be listed to a point for CBE purposes.

Zone Type	Description/Function	
General Zone	<p>A general zone is used to link input and output devices. When an input device activates, any general zone in its zone map will be active, and any output device that has an active general zone in its map will be active. General zones can be used as arguments in logic equations.</p> <p>Zone Z000 is a general alarm zone: those points listing Z000 in their zone map participate in a general alarm.</p> <p>The panel will support up to 1000 general zones, designated as Z0 through Z999. General zones can be used in CCBE applications when a node number is entered before the zone number.</p>	
Logic Zone	<p>A logic zone consists of a logic equation. Whenever the logic equation becomes true, all output points mapped to the logic zone will activate.</p> <p>The panel will support up to 1000 logic zones, designated as ZL1 through ZL1000. Logic zones can be used in CCBE applications when a node number is entered before the zone number.</p>	
Trouble Zone	<p>A trouble zone consists of a trouble equation. Whenever the trouble equation becomes true, all output points mapped to the trouble zone will activate.</p> <p>The panel will support up to one hundred trouble zones, designated as ZT001 through ZT100. Trouble zones can be used in CCBE applications when a node number is entered before the zone number.</p>	
Releasing Zone	<p>A releasing zone is used to control a releasing operation.</p> <p>The panel will support up to ten releasing zones, designated as ZR00 through ZR09.</p>	
Special Zone	<p>ZF0</p> <p>ZF1 (Trouble less AC)</p> <p>ZF2 (AC Trouble)</p> <p>ZF3 (Security)</p> <p>ZF4 (Supervisory)</p> <p>ZF5 Alternate Sensitivity Activation</p> <p>ZF8</p> <p>ZF9</p>	<p>An output participates in Presignal with this special zone in its zone map.</p> <p>An output programmed to turn on/off if a system trouble - other than an AC power loss - occurs.</p> <p>An output programmed to turn on/off if an AC power loss or a brownout condition occurs.</p> <p>An output programmed to turn on/off if a Security input activates.</p> <p>An output programmed to turn on/off if a Supervisory input activates.</p> <p>An input programmed to switch from the active detector alarm sensitivities to the alternate alarm sensitivities when a non-fire point with ZF5 in its CBE activates.</p> <p>A panel output participates in March or Temporal time coding (depending on the global setting) with this special zone in its zone map.</p> <p>An output programmed to turn on/off if a PreAlarm is active (ALERT, ACTION).</p>
<p>Time, date and holiday functions, which were formerly determined through special zones, are now defined in the panel programming section of this manual.</p>		

**Table E.1 Zone Table**

## E.2 Equations

Logic and Trouble Equations can define complex relationships between input and output devices.

The FACP supports up to 1000 Logic Equations, each designated with a Logic Zone number of ZL1 through ZL1000. It also supports up to ten Trouble Equations, each designated with a Trouble Zone number of ZT001 through ZT100. Once created, these equations can be included in input/output zone mapping.

1. Equations will always begin with a logic function. The function set is listed below.
2. Equations will be a maximum of 80 characters long, including parentheses and commas.
3. Logic and Trouble Equations can have a maximum of 10 logic functions unless a time delay function is used: a time delay function must be the only function in its equation.
4. Equations are evaluated after all other devices have been evaluated.
5. One logic equation can be used as an argument in another logic equation, or one trouble equation can be used in another trouble equation, only if the equation used has previously been evaluated; that is, only zones with a lower number than the zone currently being edited can be used as arguments.
6. A logic function can have a maximum of 20 arguments (inclusive start and stop address).
7. Maximum for the delay timer is 23 hours, 59 minutes, 59 seconds (23:59:59).

Equations are entered using Point Programming for logic or trouble zones. Refer to these sections in this manual for instruction. The panel will check for errors after the user has entered the complete equation. Possible errors are too many or too few parentheses, too many or too few arguments inside the parentheses, unknown function and unknown device type.

Equations are made up of two basic components: functions (either logic or time delay) and arguments.

### E.2.1 Arguments

Arguments are discrete parts of a logic or time delay function used in a logic or trouble equation. They can consist of another function, another equation, or any of the the devices listed below.

LxxD1 - LxxD159	detectors loop xx	(159 per loop)
LxxM1 - LxxM159	modules loop xx	(159 per loop)
P(1-12).(1-8)	panel circuit modules	(96)
(Nxxx)Z0 - (Nxxx)Z999*	general zones	(1000)
ZF1, ZF2, ZF3, ZF4, ZF5, ZF9	special zones	(6)
T0 - T510	system troubles (trouble equations only)	(511)
(Nxxx)ZT001 - (Nxxx)ZT100	trouble zones	(100)
(Nxxx)ZL1 - (Nxxx)ZL1000	logic zones	(1000)
xx = loop number (01 through 10) (Nxxx) = Node number, necessary for CCBE programming. The node number identifies what node the panel will watch for a particular zone activation.		

Table E.2 Table of Arguments

### E.2.2 Logic Equations

#### Logic Functions

##### The “AND” Operator

Requires that each argument be active.

Example: AND(Z02,Z05,L2D12)

All three arguments in the equation must be active for the logic zone to be activated.

##### The “OR” Operator

Requires that any argument be active

Example: OR(Z02,Z05,L2D12)

If any one of the three arguments in the equation is active the logic zone will be activated.

#### **The “NOT” Operator**

Inverts the state of the argument (activated to deactivated OR deactivated to activated).

Example: NOT(Z02)

The logic zone will remain activated until the argument activates.

If the argument activates the logic zone will deactivate.

#### **The “ONLY1” Operator**

Requires that only one argument be active.

Example: ONLY1(Z02,Z05,Z09)

If only one of the arguments activates the logic zone will be activated.

#### **The “ANYX” Operator**

Requires that the amount of arguments specified by the number preceding the arguments be active.

Example: ANYX(2,Z02,Z05,Z09)

If any two or more of the arguments are in alarm the output point will be activated.

The X amount may be a value from 1 through 9.

#### **The “XZONE” Operator**

Requires that any combination of two or more input devices programmed to a zone be active.

Example: XZONE(Z02)

If any combination of two or more initiating devices that have been mapped to this software zone come into alarm, then outputs mapped to this zone will activate.

#### **The “RANGE” Operator**

Each argument within the range must conform to the requirements of the governing function. The range limit is 20 consecutive arguments.

Example: AND(RANGE(Z1,Z20))

Zone 1 through Zone 20 must all be active to activate the logic zone.

### **Time-based Functions**

The panel supports three time-based functions: DEL, SDEL, and TIM. Special rules apply to an equation containing a time-based function:

- Only one time-based function may be used in an equation.
- The time-based function must appear only once, as the first entry of the equation.
- It may not be nested within parentheses in the equation.
- Logic functions may be used in an equation that begins with a DEL or SDEL time-based function: however, they must appear within parentheses following the time-based function.

Delay and duration times are in 24-hour format (HHMMSS); the allowable range is 00:00:00 to 23:59:59.

#### **The “DEL” Function**

Used for delayed operation.

Example: DEL(HH.MM.SS, HH.MM.SS,AND(L1M1,L1M140))

- The first HH.MM.SS is the delay time, the second HH.MM.SS is the duration time. If the argument - AND(L1M1,L1M140) - in the example above activates, the function becomes true after the argument has been active for the delay time, and continues to be true for the duration time as long as the argument stays active. If the argument goes inactive during the delay time or the duration time, the function reverts to false and the timing would begin all over again if reactivated.

- If duration time of zero is entered (00.00.00), the equation will evaluate true when the delay time expires if the argument remains active throughout the delay time period.
- If no duration or delay is specified, then the function will follow the input argument, indicating true while it is active and false when it is inactive. DEL assumes a value of false on reset.

#### The “SDEL” Function

A latched version of the DEL function.

Example: SDEL(HH.MM.SS, HH.MM.SS,L1M140)

- The first HH.MM.SS is the delay time, the second HH.MM.SS is the duration time. If the argument (L1M140 in the example above) activates, the function becomes true after the delay time, and will remain active for the duration even if the argument becomes inactive during either the delay or duration time.
- If delay time of zero is entered (00.00.00), the equation will evaluate true as soon as the argument (L1M140) activates and will remain that way for the specified duration, even if the argument becomes inactive during that time.
- If no duration or delay time is specified, then the argument will not deactivate until reset, even if the argument becomes inactive.

#### The “TIM” Operator

The TIM function is used to specify activation on specific days of the week or year.

Examples:

TIM(7-11-04) will evaluate as true for 24 hours starting at midnight (00:00:00) on July 11, 2004.

TIM(MO,TU,WE,TH,FR,08:00:00,23:00:00) will evaluate as true at 8:00 AM and remain true until 11:00 PM (23:00) for the list of days supplied.

TIM(MO,TU,WE,TH,FR,08:00:00) will evaluate as true at 8:00 AM and remain true until 23:59:59 of the current day for the list of days supplied.

TIM(TU,07:45:00,18:30:00) will evaluate as true every Tuesday between 7:45 AM until 6:30 PM.

TIM(MO,TU,WE,TH,FR) will evaluate as true from Monday morning at 12:01 AM until Friday evening at 11:59:00 PM.

#### Logic Equation Syntax Example

**OR(AND(L1D1,L1D4),AND(L2D6,L2M3,NOT(L2M4)),ANY2(L1M13,L1M14,L1M15))**

Equation begins with a logic function - OR

67 *Characters* (maximum of 80) - includes parentheses and commas.

5 *Logic Functions* (maximum of 10) - OR, AND, AND, NOT and ANY2.

8 *Arguments* (maximum of 20 per logic function) - L1D1,L1D4,L2D6,L2M3,L2M4....

The equation contains no spaces.

#### Evaluating an Equation

To evaluate an equation, start from the innermost part of the equation and work outwards. For this equation to evaluate TRUE and thus turn on any output mapped to it, the following conditions must be met:



OR(AND(L1D1,L1D4),AND(L2D6,L2M3,NOT(L2M4)),ANY2(L1M13,L1M14,L1M15))

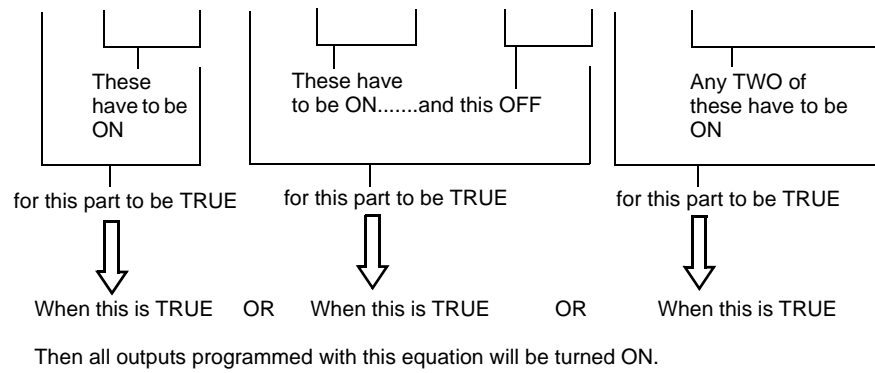

### E.2.3 Trouble Equations

A trouble equation follows the same syntax rules as the logic equation. The system allows up to a hundred trouble equations, ZT001 through ZT100. It differs from a logic equation in the following manner:

- Equations evaluate as true when the arguments go into trouble.
- Argument entries may consist of system trouble codes. Refer to Appendix H, "System Troubles" for a listing of these codes.

Examples:

`AND(L1M149,L2M110)` will evaluate as true when both arguments go into trouble.

`OR(ZT049,ZT050)` will evaluate as true when either argument goes into trouble.



# Appendix F: Detector Initialization

## F.1 Overview

The control panel automatically performs a detector initialization routine when a detector is added or changed.

The detector initialization routine takes approximately 2.5 minutes. During this time, the detector being initialized does not perform fire protection functions. The LEDs of detectors polled in FlashScan mode will latch a steady green while initializing, and return to blinking green when initialization is over.

While initializing a detector, follow these guidelines:

- Make sure the detector is free of residual smoke during detector initialization.
- Do not test a detector during detector initialization.



---

**NOTE:** The control panel only performs detector initialization if it senses that a detector was removed for at least 15 seconds.

---



---

**WARNING:**

If any detector is replaced with a different type of detector (for example, a laser detector is replaced with a photoelectric detector), the control panel must be programmed immediately with the new detector Type Code. Failure to do so can cause incorrect control panel operation, including false alarms.

---

## F.2 To Replace a Detector with a Different Type of Detector

If one type of detector is replaced with a different type of detector, the control panel must immediately be programmed for the new detector type. To replace a detector, follow these steps:

Step	Action
1	Delete the old detector point from FACP programming using the "Delete Point" screen on page page 57.
2	Physically remove the old detector.
3	Enter point programming for this point and change the Type and FlashScan Code Label to the values appropriate for the new detector. (Refer to "Detector Point" on page 38 for programming instructions).
4	Physically install the new detector. Initialization will occur automatically



# Appendix G: Type Codes

## G.1 What are Type Codes?

Type Codes are software selections for initiating devices (detectors and monitor modules) and output devices (control modules, NACs, and Panel Circuits). Some Type Codes are self-explanatory; that is, the Type Code matches the function of the device, such as a “Monitor” for a monitor module, “Smoke(photo)” for a photoelectric detector, and so on. Type codes also provide special functions, such as activating switches, solenoids, and control panel functions. FlashScan devices are assigned a special FlashScan code.

## G.2 How to Select a Type Code

Type Codes are selected at the Point Programming screens. Refer to the Point Program section of this manual for instructions.

This appendix contains detailed descriptions of Type Codes for input and output devices, as listed below:

Type of Device	Refer to page
G.3.2, "Type Codes for Intelligent Detectors" Intelligent Detectors	page 134
Monitor Modules G.3.3, "Type Codes for Monitor Modules"	page 135
SLC and Panel Circuit Outputs	page 136
FlashScan Codes	page 137

## G.3 Type Codes for Input Devices

### G.3.1 Overview

This section provides a list of Type Codes for intelligent detectors and for monitor modules. The following Point Types light an LED at the panel when activated.

- fire alarm - lights the FIRE ALARM LED
- supervisory - lights the SUPERVISORY LED
- security - lights the SECURITY LED
- trouble - lights the TROUBLE LED

### G.3.2 Type Codes for Intelligent Detectors

Following is a list of intelligent detector Type Codes, which specify the type of detector installed at an SLC address.

Type Code	Point Type	Latching (Y=yes N=no)	Point Characteristics	
			Activates CBE	Device/Point Function
SMOKE (ION)	fire	Y	Y	Ionization smoke detector
SUP L(ION)*	supervisory	Y	Y	Ionization smoke detector
SUP T(ION)*†	supervisory	N	Y	Ionization smoke detector
SMOKE(DUCTI)	fire	Y	Y	Duct Ionization smoke detector
SUP L(DUCTI)	supervisory	Y	Y	Duct ionization smoke detector
SUP T(DUCTI)†	supervisory	N	Y	Ionization smoke detector used as a duct detector to report supervisory condition rather than alarm.
SMOKE(PHOTO)	fire	Y	Y	Photoelectric smoke detector
SUP L(PHOTO)*	supervisory	Y	Y	Photoelectric smoke detector
SUP T(PHOTO)*†	supervisory	N	Y	Photoelectric smoke detector
SMOKE(DUCTP)	fire	Y	Y	Duct Photoelectric smoke detector
SUP L(DUCTP)	supervisory	Y	Y	Photoelectric smoke detector used as a duct detector to report supervisory condition rather than alarm
SUP T(DUCTP)†	supervisory	N	Y	Photoelectric smoke detector used as a duct detector to report supervisory condition rather than alarm.
RFSMOKE(PHOTO)	fire	Y	Y	Wireless Photoelectric smoke detector
SMOKE(HARSH)	fire	Y	Y	HARSH smoke detector
SMOKE(LASER)	fire	Y	Y	Laser smoke detector
SUP T (LASER)*†	supervisory	N	Y	Laser Smoke Detector
SUP L (LASER)*	supervisory	Y	Y	Laser Smoke Detector
AIR REF	fire	Y	Y	Assign to one or more 7351J detectors used to monitor the quality of air entering the protected area. The air quality measurement allows the VIEW® system to compensate for vehicle fumes, fog, or other particles brought into the protected area through the ventilation system. Poor air quality will lower the sensitivity of all 7351J detectors on the SLC. The detector sensitivity, however, remains within approved limits (always less than 1% obscuration per foot).
Note: A reference detector still functions as a smoke detector, but the detector sensitivity level should be set to the least sensitive level—AL:9 and PA:9 Alarm and Pre-Alarm sensitivity. Refer to "Detector Sensitivity Settings" on page 119 for a complete list of detector sensitivity settings.				
HEAT	fire	Y	Y	190°F heat detector
HEAT+	fire	Y	Y	190°F heat detector with low temperature warning
HEAT(FIXED)	fire	Y	Y	135°F intelligent thermal sensor
HEAT (ROR)	fire	Y	Y	15°F per minute rate-of-rise detector
SMOKE ACCLIM	fire	Y	Y	Combination Photoelectric/heat detector
SMOKE(ACCLI+)	fire	Y	Y	Combination Photoelectric/heat detector with low temperature warning
SMOKE(MULTI)‡	fire	Y	Y	Multisensor smoke detector
SMOKE(BEAM)	fire	Y	Y	Beam Smoke Detector

\* Use only with approval of AHJ

† Not suitable for Canadian applications

‡ CLIP Mode only

**Table G.1 Intelligent Detector Type Codes**

### G.3.3 Type Codes for Monitor Modules

Following is a list of monitor module Type Codes, which can be used to change the function of a monitor module point.



**NOTE:** Do not assign Releasing Type Codes to Panel Circuit module points.

Type Code	Point Type	Point Characteristics		
		Latching (Y=yes N=no)	Activates CBE	Device Function
MONITOR	fire alarm	Y	Y	Alarm-monitoring device
NC MONITOR	fire alarm	Y	Y	Alarm monitoring device, where an open circuit=active. SLC only.
PULL STATION	fire alarm	Y	Y	Manual fire-alarm-activating device
SMOKE CONVEN	fire alarm	Y	Y	Indicates activation of a conventional smoke detector. An M302MJ must be used for alarm verification of a two-wire conventional detector.
SMOKE DETECT	fire alarm	Y	Y	Indicates activation of a conventional smoke detector. An M302MJ must be used for alarm verification of a two-wire conventional detector
WATERFLOW	fire alarm	Y	Y	Monitor for waterflow alarm switch
WATERFLOW S	supervisory	Y	Y	Indicates supervisory condition for activated waterflow switch
ACCESS MONTR	non-alarm security	N	Y	Used for monitoring building access
AREA MONITOR	security	Y	Y	Monitors building access
AUDIO SYSTEM	trouble	N	N	Used for monitoring audio equipment (use trouble zones for activations)
EQUIP MONITR	non-alarm security	N	Y	Used for monitoring equipment
SECURITY L	security	Y	Y	Indicates activation of security alarm
LATCH SUPERV	supervisory	Y	Y	Indicates latching supervisory condition
NC SUP L	supervisory	Y	Y	Indicates latching supervisory conditon, where an open circuit=active. SLC only.
TRACK SUPERV	supervisory	N	Y	Monitors for waterflow tamper switches for alarm points
NC SUP T	supervisory	N	Y	Indicates tracking supervisory conditon, where an open circuit=active. SLC only.
SPRINKLR SYS	supervisory	Y	Y	Monitors a waterflow device
SYS MONITOR	security	Y	Y	Monitors equipment security
TAMPER	supervisory	Y	Y	Indicates activation of tamper switch
ACK SWITCH	non-alarm	N	N	Emulates panel Acknowledge switch
ALLCALL PAGE	non-alarm	N	Y	Emulates AMG-1 All-call switch and telephone page
DRILL SWITCH	non-alarm	N	N	Emulates panel Drill switch, activates silenceable fire outputs
EVACUATE SWITCH	non-alarm*	N	N	Emulates panel Drill Switch, activates silenceable fire outputs
FIRE CONTROL	non-alarm	N	Y	Monitors non-fire activations
NON FIRE	non-alarm	N	Y	Monitors non-fire activations
NC NON FIRE	non-alarm	N	Y	Monitors non-fire activations, where an open circuit=active. SLC only.
PAS INHIBIT	non-alarm	N	N	Inhibits Positive Alarm Sequence
POWER MONITR	trouble†	N	N	Monitors main and auxiliary power supplies (use trouble zones for activations)
RESET SWITCH	non-alarm	N	N	Emulates keypad Reset switch
SIL SWITCH	non alarm	N	N	Emulates keypad Signal Silence switch
TELE PAGE	non-alarm	N	Y	Emulates Page Button on FFT-7. Allows remote paging to a fire area
TROUBLE MON	trouble	N	N	Monitors trouble inputs (use trouble zones for activations)
Blank	fire alarm	Y	Y	Monitors for a device with no description
HEAT DETECT	fire alarm	Y	Y	Monitors for conventional heat detector
RF MON MODUL	fire alarm	Y	Y	Wireless alarm-monitoring device
RF PULL STA	fire alarm	Y	Y	Wireless manual fire-alarm-activating device
RF SUPERVSRY	supervisory	N	Y	Wireless supervisory-monitoring device
ABORT SWITCH	non-alarm	N	Y	Provides an abort function through a monitor module (connected to a UL-listed abort station) for a releasing zone.
MAN RELEASE	fire alarm‡	Y	Y	Provides a manual release through a monitor module (connected to a UL-listed pull station) for a releasing zone
MAN REL DELAY	fire alarm†	Y	Y	Provides a manual release with a 10-second delay through a monitor module (connected to a UL-listed pull station) for a releasing zone
SECOND SHOT	fire alarm†	Y	Y	Provides a second manual release through a monitor module (connected to a UL-listed pull station) for a releasing zone

\* Local Mode treats this point as a fire alarm point.

† Does not participate in Local Mode

‡ Local Mode activation of NACs only. No releasing.

**Table G.2 Type Codes for Monitor Modules**

## G.4 Type Codes for Output Devices

This section provides a list of Type Codes for SLC control module points and panel circuit output module points. Select from these codes to define the type of point..



**NOTE:** Do not assign Releasing Type Codes to Panel Circuit module points.

Type Code	Silenceable (Y=yes N=no)*	Switch Inhibit (Y=yes, N=No)*	Walk Test (Y=yes, N=No)*	SLC or Panel Circuit Output Point	Local Mode Group Point Types	Device Function
CONTROL	Y	N	Y	NAC	n/a	Supervised NAC
RELAY	Y	N	Y	Relay	n/a	Relay output
BELL CIRCUIT	Y	N	Y	NAC	fire	Supervised NAC
STROBE CKT	Y	N	Y	NAC	fire	Supervised NAC
HORN CIRCUIT	Y	N	Y	NAC	fire	Supervised NAC
AUDIBLE CKT	Y	N	Y	NAC	fire	Supervised NAC
SPEAKER	Y	N	Y	NAC	fire	Supervised NAC for speaker circuits
blank	Y	N	Y	NAC	n/a	Supervised NAC for undefined device
NONRESET CTL	N	N	N	Relay or NAC	n/a	Supervised output, unaffected by "System Reset" command
TELEPHONE	N	N	N	Relay	fire	Supervised Telephone circuit
CONTROL NAC	Y	N	Y	NAC	fire	Supervised NAC
ISOLATED NAC	Y	N	Y	NAC	fire	Supervised NAC for notification appliance, used with audio isolators. Activates even if there is a short on its NAC circuit. For ULC installations only.
ISOLATED SPK	Y	N	Y	NAC	fire	Supervised NAC for speaker circuits, used with audio isolators. Activates even if there is a short on its audio circuit. For ULC installations only.
GEN ALARM	N	Y	Y	NAC	fire	Control Module, XPC-8, or an XP5-C (in NAC mode) configured as a Municipal Box Transmitter for NFPA 72 Auxiliary Fire Alarm Systems applications (MBT-1 required). This Type ID can also be used for general alarm activation.
GEN SUPERVIS	N	Y	Y	NAC	supervisory	Control Module, XPC-8, or an XP5-C (in NAC mode) activated under any Supervisory condition (includes sprinkler type).
GEN TROUBLE	N	Y	Y	NAC	trouble	Control Module, XPC-8, or an XP5-C (in NAC mode) activated under any System Trouble condition. This device will not turn ON when it is in trouble (short or open).
GENERAL PEND	N	Y	Y	NAC	trouble	Control Module XPC-8 circuit, or an XP5-C (in NAC mode) that will activate upon receipt of an alarm and/or trouble condition, and remain in the ON state until all events have been ACKNOWLEDGED. This device will not turn ON when it is in trouble (short or open)
TROUBLE PEND	N	Y	Y	NAC	trouble	Control Module or an XP5-C (in NAC mode) that will activate upon receipt of a trouble condition, and remain in the ON state until all troubles have been ACKNOWLEDGED. This device will not turn ON when it is in trouble (short or open).
ALARMS PEND	N	Y	Y	NAC	fire	Control module/panel circuit or NAC for output that will activate upon receipt of an alarm condition, and remain in the alarm state until all alarms have been acknowledged.
INST RELEASE	N	Y	N	NAC (SLC only)	fire	Supervised for open circuits and ground faults. Short = normal
REL. FORM C	N	Y	N	Form-C relay (SLC only)	n/a	Directs relay outputs to perform a releasing function.
RELEASE CKT	N	Y	N	NAC (SLC only)	n/a	Directs outputs to perform a releasing function.
REL CKT ULC	N	Y	N	NAC (SLC only)	n/a	Directs outputs to perform a release function as required by ULC.
REL END BELL	N	Y	N	NAC	n/a	Activates NAC audio or visual device when releasing circuits shut off.
REL AUDIBLE	Y	Y	N	NAC	n/a	Activates audio or visual devices steady when releasing starts.
FORM C RESET	N	Y	N	Form-C Relay (SLC only)	n/a	Control module used to interrupt 24V power to four-wire conventional detectors for 30 seconds upon reset. Used in conjunction with a monitor module with a conventional detector Type ID

\* Values represent program defaults

**Table G.3 SLC Control Module and Panel Circuit Output Module Type Codes**



## G.5 FlashScan Codes

This section provides a list of FlashScan Codes for FlashScan SLC devices. Select from these codes to define the type of point:

Label	Device/Point
HEAT	5351J/RJ, 5951J/RJ
ION	1351J, 1951J
PHOTO	2351J, DH300P/RP, 2951J, DH300PL/RPL, FTX-P2J
BEAM	FSB-200,FSB-200S
RFX SMOKE	SDRF-751
LASER	7351J
PHOTO/HEAT	2351TJ, 2951TJ
ACCLIMATE	2351TMJ, 2951TMJ
HIGH HEAT	5951HJ
MONITOR	M300MJ
MINI/DUAL MONITOR	M301MJ, M300DJ
MANUAL STATION	M300SMJ (pull station monitor module)
ZONE MONITOR	M302MJ
CONTROL	M300CJ
RELAY	M300RJ
TELEPHONE	M500FPJ
XPIQ BATTERY	XPIQ BAT MON
XPIQ GND FLT	XPIQ EF MON
XPIQ AC	XPIQ AC MON
XPIQ TROUBLE	XPIQ GEN MON
XPIQ STROBE	XPIQ STROBE
XPIQ SPEAKER	XPIQ SPEAKER
XPIQ TELEPHONE	XPIQ TELEPHONE
XPIQ MUSIC	XPIQ MUSIC
PS MON	PS MON
PS CONTROL	ACPS CONTROL
PS RELAY	ACPS RELAY
RFX MON	RFX MON
RFX SUP	RFX SUP

**Table G.4 FlashScan Codes**



# Appendix H: System Troubles

Table H.1 is a list of System Troubles that could occur during the course of FACP operation. The System Trouble Name column is the text that displays in the system trouble message. The System Trouble Index is the number associated with the trouble in FACP memory. It is the number that can be used as an argument in a Trouble Equation.

System Trouble Index	System Trouble Name	System Trouble Index	System Trouble Name	System Trouble Index	System Trouble Name	System Trouble Index	System Trouble Name
0	GROUND FAULT	61	ANNUN 24 TROUBLE	197	STYLE 6 POS LOOP 8	400	REMOTE DISPLAY 9 TROUBLE
1-2	RESERVED	62	ANNUN 24 NO ANSWER	198	STYLE 6 POS LOOP 9	401	REMOTE DISPLAY 9 NO ANSWER
3	STYLE 6 POS LOOP 1	63	ANNUN 25 TROUBLE	199	STYLE 6 POS LOOP 10	402	REMOTE DISPLAY 10 TROUBLE
4	STYLE 6 POS LOOP 2	64	ANNUN 25 NO ANSWER	200-205	RESERVED	403	REMOTE DISPLAY 10 NO ANSWER
5	CORRUPT LOGIC EQUAT	65	ANNUN 26 TROUBLE	206	PRINTER PAPER OUT	404	REMOTE DISPLAY 11 TROUBLE
6	RESERVED	66	ANNUN 26 NO ANSWER	207	PRINTER OFF LINE	405	REMOTE DISPLAY 11 NO ANSWER
7	EPROM ERROR	67	ANNUN 27 TROUBLE	208-209	RESERVED	406	REMOTE DISPLAY 12 TROUBLE
8	INTERNAL RAM ERROR	68	ANNUN 27 NO ANSWER	210	MANUAL MODE ENTERED	407	REMOTE DISPLAY 12 NO ANSWER
9	EXTERNAL RAM ERROR	69	ANNUN 28 TROUBLE	211	NCM COMM LOSS	408	REMOTE DISPLAY 13 TROUBLE
10	PROGRAM CORRUPTED	70	ANNUN 28 NO ANSWER	212	STYLE 4 SHORT A LOOP 1	409	REMOTE DISPLAY 13 NO ANSWER
11	NO DEV INST ON L1	71	ANNUN 29 TROUBLE	213	STYLE 4 SHORT B LOOP 1	410	REMOTE DISPLAY 14 TROUBLE
12	PANEL DOOR OPEN	72	ANNUN 29 NO ANSWER	214	STYLE 4 SHORT A LOOP 2	411	REMOTE DISPLAY 14 NO ANSWER
13	AUXILIARY TROUBLE	73	ANNUN 30 TROUBLE	215	STYLE 4 SHORT B LOOP 2	412	REMOTE DISPLAY 15 TROUBLE
14	RESERVED	74	ANNUN 30 NO ANSWER	216	STYLE 4 SHORT A LOOP 3	413	REMOTE DISPLAY 15 NO ANSWER
15	ANNUN 1 TROUBLE	75	ANNUN 31 TROUBLE	217	STYLE 4 SHORT B LOOP 3	414	REMOTE DISPLAY 16 TROUBLE
16	ANNUN 1 NO ANSWER	76	ANNUN 31 NO ANSWER	218	STYLE 4 SHORT A LOOP 4	415	REMOTE DISPLAY 16 NO ANSWER
17	ANNUN 2 TROUBLE	77	ANNUN 32 TROUBLE	219	STYLE 4 SHORT B LOOP 4	416	REMOTE DISPLAY 17 TROUBLE
18	ANNUN 2 NO ANSWER	78	ANNUN 32 NO ANSWER	220	STYLE 4 SHORT A LOOP 5	417	REMOTE DISPLAY 17 NO ANSWER
19	ANNUN 3 TROUBLE	79	NETWORK FAIL PORT A	221	STYLE 4 SHORT B LOOP 5	418	REMOTE DISPLAY 18 TROUBLE
20	ANNUN 3 NO ANSWER	80	NETWORK FAIL PORT B	222	STYLE 4 SHORT A LOOP 6	419	REMOTE DISPLAY 18 NO ANSWER
21	ANNUN 4 TROUBLE	81	RESERVED	223	STYLE 4 SHORT B LOOP 6	420	REMOTE DISPLAY 19 TROUBLE
22	ANNUN 4 NO ANSWER	82	ADV WALK TEST	224	STYLE 4 SHORT A LOOP 7	421	REMOTE DISPLAY 19 NO ANSWER
23	ANNUN 5 TROUBLE	83	RESERVED	225	STYLE 4 SHORT B LOOP 7	422	REMOTE DISPLAY 20 TROUBLE
24	ANNUN 5 NO ANSWER	84	GROUND FAULT LOOP 2	226	STYLE 4 SHORT A LOOP 8	423	REMOTE DISPLAY 20 NO ANSWER
25	ANNUN 6 TROUBLE	85	STYLE 6 NEG LOOP 1	227	STYLE 4 SHORT B LOOP 8	424	REMOTE DISPLAY 21 TROUBLE
26	ANNUN 6 NO ANSWER	86	STYLE 6 NEG LOOP 2	228	STYLE 4 SHORT A LOOP 9	425	REMOTE DISPLAY 21 NO ANSWER
27	ANNUN 7 TROUBLE	87	GROUND FAULT LOOP 1	229	STYLE 4 SHORT B LOOP 9	426	REMOTE DISPLAY 22 TROUBLE
28	ANNUN 7 NO ANSWER	88 - 89	RESERVED	230	STYLE 4 SHORT A LOOP 10	427	REMOTE DISPLAY 22 NO ANSWER
29	ANNUN 8 TROUBLE	90	PROG MODE ACTIVATED	231	STYLE 4 SHORT B LOOP 10	428	REMOTE DISPLAY 23 TROUBLE
30	ANNUN 8 NO ANSWER	91	LOADING.NO SERVICE	232	RESERVED	429	REMOTE DISPLAY 23 NO ANSWER
31	ANNUN 9 TROUBLE	92	BASIC WALK TEST	233	STYLE 6 SHORT LOOP 1	430	REMOTE DISPLAY 24 TROUBLE
32	ANNUN 9 NO ANSWER	93	NFPA 24HR REMINDER	234	STYLE 6 SHORT LOOP 2	431	REMOTE DISPLAY 24 NO ANSWER
33	ANNUN 10 TROUBLE	94	NVRAM BATT TROUBLE	235	STYLE 6 SHORT LOOP 3	432	REMOTE DISPLAY 25 TROUBLE
34	ANNUN 10 NO ANSWER	95-104	RESERVED	236	STYLE 6 SHORT LOOP 4	433	REMOTE DISPLAY 25 NO ANSWER
35	ANNUN 11 TROUBLE	105	STYLE 6 ON LOOP 3	237	STYLE 6 SHORT LOOP 5	434	REMOTE DISPLAY 26 TROUBLE
36	ANNUN 11 NO ANSWER	106-107	RESERVED	238	STYLE 6 SHORT LOOP 6	435	REMOTE DISPLAY 26 NO ANSWER
37	ANNUN 12 TROUBLE	108	MAN EVAC INITIATED	239	STYLE 6 SHORT LOOP 7	436	REMOTE DISPLAY 27 TROUBLE
38	ANNUN 12 NO ANSWER	109	MAN EVAC RECEIVED	240	STYLE 6 SHORT LOOP 8	437	REMOTE DISPLAY 27 NO ANSWER
39	ANNUN 13 TROUBLE	110-175	RESERVED	241	STYLE 6 SHORT LOOP 9	438	REMOTE DISPLAY 28 TROUBLE
40	ANNUN 13 NO ANSWER	176	GROUND FAULT LOOP 3	242	STYLE 6 SHORT LOOP 10	439	REMOTE DISPLAY 28 NO ANSWER
41	ANNUN 14 TROUBLE	177	GROUND FAULT LOOP 4	243-249	RESERVED	440	REMOTE DISPLAY 29 TROUBLE
42	ANNUN 14 NO ANSWER	178	GROUND FAULT LOOP 5	250	SELF TEST FAILED	441	REMOTE DISPLAY 29 NO ANSWER
43	ANNUN 15 TROUBLE	179	GROUND FAULT LOOP 6	251	NETWORK INCOMPATIBILITY	442	REMOTE DISPLAY 30 TROUBLE
44	ANNUN 15 NO ANSWER	180	GROUND FAULT LOOP 7	252-383	RESERVED	443	REMOTE DISPLAY 30 NO ANSWER
45	ANNUN 16 TROUBLE	181	GROUND FAULT LOOP 8	384	REMOTE DISPLAY 1 TROUBLE	444	REMOTE DISPLAY 31 TROUBLE
46	ANNUN 16 NO ANSWER	182	GROUND FAULT LOOP 9	385	REMOTE DISPLAY 1 NO ANSWER	445	REMOTE DISPLAY 31 NO ANSWER
47	ANNUN 17 TROUBLE	183	GROUND FAULT LOOP 10	386	REMOTE DISPLAY 2 TROUBLE	446	REMOTE DISPLAY 32 TROUBLE
48	ANNUN 17 NO ANSWER	184	STYLE 6 NEG LOOP 3	387	REMOTE DISPLAY 2 NO ANSWER	447	REMOTE DISPLAY 32 NO ANSWER
49	ANNUN 18 TROUBLE	185	STYLE 6 NEG LOOP 4	388	REMOTE DISPLAY 3 TROUBLE	448	SYSTEM INITIALIZATION
50	ANNUN 18 NO ANSWER	186	STYLE 6 NEG LOOP 5	389	REMOTE DISPLAY 3 NO ANSWER	449-502	RESERVED
51	ANNUN 19 TROUBLE	187	STYLE 6 NEG LOOP 6	390	REMOTE DISPLAY 4 TROUBLE	503	SOFTWARE MISMATCH
52	ANNUN 19 NO ANSWER	188	STYLE 6 NEG LOOP 7	391	REMOTE DISPLAY 4 NO ANSWER	504	NO POWER SUPPLY INST
53	ANNUN 20 TROUBLE	189	STYLE 6 NEG LOOP 8	392	REMOTE DISPLAY 5 TROUBLE	505	LOOP 1-2 COMM FAILURE
54	ANNUN 20 NO ANSWER	190	STYLE 6 NEG LOOP 9	393	REMOTE DISPLAY 5 NO ANSWER	506	LOOP 3-4 COMM FAILURE
55	ANNUN 21 TROUBLE	191	STYLE 6 NEG LOOP 10	394	REMOTE DISPLAY 6 TROUBLE	507	LOOP 5-6 COMM FAILURE
56	ANNUN 21 NO ANSWER	192	STYLE 6 POS LOOP 3	395	REMOTE DISPLAY 6 NO ANSWER	508	LOOP 7-8 COMM FAILURE
57	ANNUN 22 TROUBLE	193	STYLE 6 POS LOOP 4	396	REMOTE DISPLAY 7 TROUBLE	509	LOOP 9-10 COMM FAILURE
58	ANNUN 22 NO ANSWER	194	STYLE 6 POS LOOP 5	397	REMOTE DISPLAY 7 NO ANSWER	510	TEST PROGRAM UPDATE
59	ANNUN 23 TROUBLE	195	STYLE 6 POS LOOP 6	398	REMOTE DISPLAY 8 TROUBLE		
60	ANNUN 23 NO ANSWER	196	STYLE 6 POS LOOP 7	399	REMOTE DISPLAY 8 NO ANSWER		

**Table H.1 System Trouble Names and Codes**

Table H.2 gives a description of each system trouble.

SYSTEM TROUBLES	
TROUBLE MESSAGE TYPE	TROUBLE DESCRIPTION
ADV WALK TEST	There is an Advanced Walk Test in progress.
ANNUN $\underline{x}$ NO ANSWER	The annunciator at address $\underline{x}$ is not responding.
ANNUN $\underline{x}$ TROUBLE	The annunciator at address $\underline{x}$ is in trouble.
AUXILIARY TROUBLE	Auxiliary device connected to the JCPU-3030 at J5 is in trouble or the cable is missing.
BASIC WALK TEST	A Basic Walk Test is in progress.
CORRUPT LOGIC EQUAT	The database that houses the panel's logic equations is corrupt. It must be re-downloaded, or all programming must be cleared and re-entered.
DRILL INITIATED	Drill has been initiated locally.
DRILL RECEIVED	Drill has been initiated remotely.
EPROM ERROR	The application and/or boot code is corrupt. Service required.
EXTERNAL RAM ERROR	The external RAM test failed. Service required.
GROUND FAULT	A ground fault has occurred within the panel.
GROUND FAULT LOOP $\underline{x}$	There is a ground fault on loop $\underline{x}$ .
INTERNAL RAM ERROR	The internal RAM test failed. Service required.
LOADING.NO SERVICE	A program or database download is in progress. The panel is NOT providing fire protection during the download. Proper authorities should be notified while a download is in progress so that other means of fire protection can be supplied.
LOOP $\underline{x}$ - $\underline{x}$ COMM FAILURE	Loops $\underline{x}$ and $\underline{x}$ are not responding. The LCM and LEM for those loops must be serviced.
MAN EVAC INITIATED	Local initiation of DRILL
MAN EVAC RECEIVED	Network initiation of DRILL
MANUAL MODE ENTERED	An annunciator has been placed in manual mode.
NCM COMM LOSS	Communication lost between JCPU-3030 and NCM
NETWORK FAIL PORT $x$	Communication lost between NCM Port $x$ and corresponding node.
NETWORK INCOMPATIBILITY	The brand of this panel is incompatible with this network.
NFPA 24HR REMINDER	This message occurs every day at 11 am if any troubles exist.
NVRAM BATT TROUBLE	Battery backup and/or clock backup is low. Replace battery.
NO DEV. INST ON L1	No devices are installed on the system.
NO POWER SUPPLY INST	The address of the main power supply has not been entered.
PANEL DOOR OPEN	The panel door is open.
PRINTER OFF LINE	Communication loss with printer. Restore power and/or printer's online status.
PRINTER PAPER OUT	Add paper.
PROGRAM CORRUPTED	The database that houses the panel's programming is corrupt. It must be re-downloaded, or all programming must be cleared and re-entered. Service required.
PROG MODE ACTIVATED	A user is currently using the panel's programming menus.
REMOTE DISPLAY $\underline{x}$ NO ANSWER	The remote display at address $\underline{x}$ is not responding.
REMOTE DISPLAY $\underline{x}$ TROUBLE	The remote display at address $\underline{x}$ is in trouble.
SELF TEST FAILED	Diagnostic test failed. Service required.
SOFTWARE MISMATCH	One or more LCM software revisions do not match other LCMs, and/or the NCM is not network version 5.0, or LCD-160 software is incompatible.
STYLE 4 SHORT $\underline{x}$ LOOP $\underline{x}$	Service required.
STYLE 6 POS. LOOP $\underline{x}$	There is a short circuit on the positive side of loop $\underline{x}$ . Style 6 and Style 7 are supervised methods of communicating with addressable devices. If the control panel detects a trouble (open or short), it will drive both ends of the loop, maintaining communication in an unsupervised method. The latching trouble will display on the panel as a Style 6 trouble until you correct the condition and press reset. Style 7 configuration of the SLC requires the use of M500XJ modules.
STYLE 6 NEG. LOOP $\underline{x}$	There is a short circuit on the negative side of loop $\underline{x}$ . Style 6 and Style 7 are supervised methods of communicating with addressable devices. If the control panel detects a trouble (open or short), it will drive both ends of the loop, maintaining communication in an unsupervised method. The latching trouble will display on the panel as a Style 6 trouble until you correct the condition and press reset. Style 7 configuration of the SLC requires the use of M500XJ modules.
STYLE 6 SHORT LOOP $\underline{x}$	Style 6 and Style 7 are supervised methods of communicating with addressable devices. If the control panel detects a trouble (open or short), it will drive both ends of the loop, maintaining communication in an unsupervised method. The latching trouble will display on the panel as a Style 6 trouble until you correct the condition and press reset. Style 7 configuration of the SLC requires the use of M500XJ modules.
SYSTEM INITIALIZATION	One or more devices (detectors or modules) can not report activation. This can occur following system startup, when exiting Walk Test, or following a device trouble of No Response.

**Table H.2 System Trouble Descriptions**

# Appendix I: Local Settings

The panel programming LOCAL SETTING choices, available through the Panel Settings (2) screen (refer to page 22) are described below. The Local Settings screen (Refer to Figure I.1) allows scrolling through the available choices by pressing the soft key. Choices are Chicago, Singapore, or Default (no special local settings).

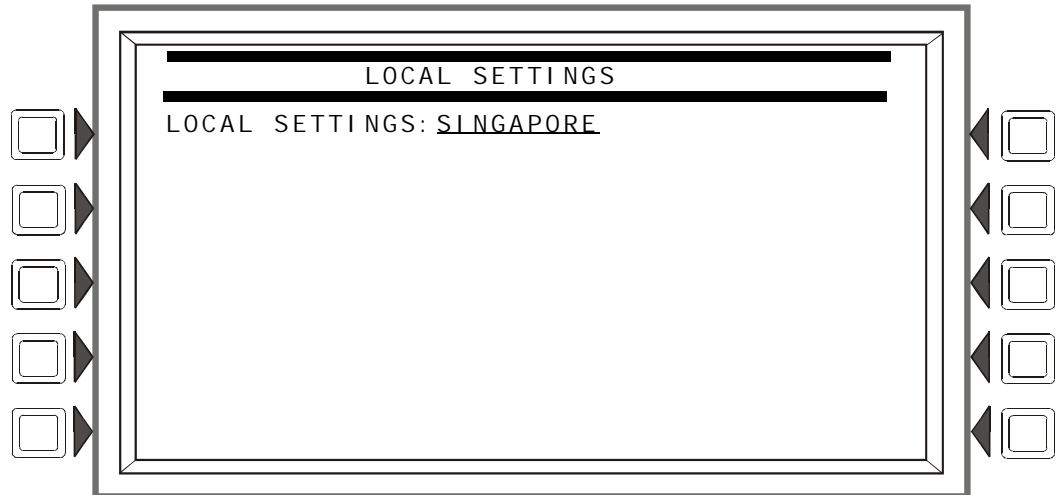
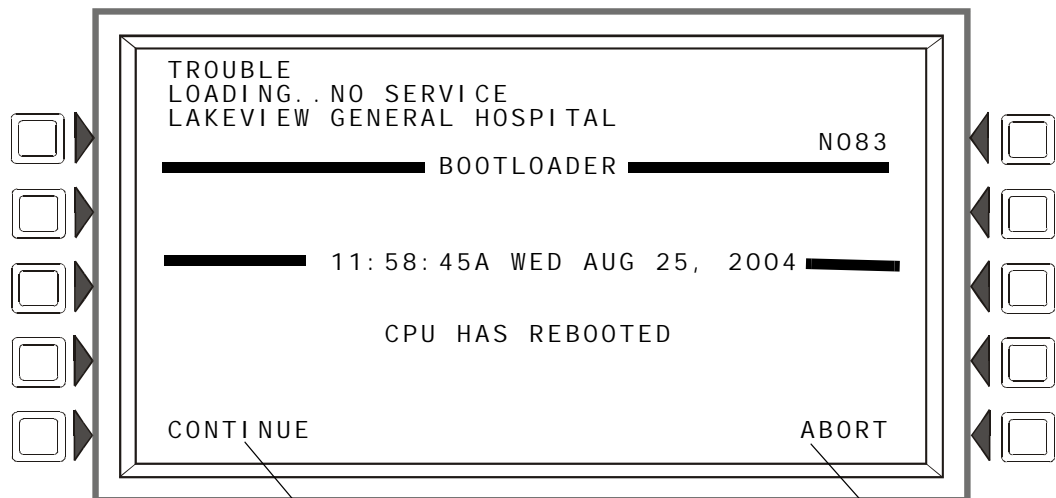

Figure I.1 Local Settings Screen

## I.1 Singapore

The LOCAL SETTING choice of SINGAPORE:

- Does not allow the disabling of a bell circuit either locally or via the network.
- Does not turn ON the System Trouble LED or the System Trouble relay for disabled points.
- Does not turn ON the System Trouble LED, the System Trouble relay, or the piezo when Drill is initiated.
- Turns ON keypad LEDs, PCB LEDs, Panel Circuit LEDs, and all ACM-24/48 LEDs during Lamp Test.
- Requires the user to initiate the start of the application when the panel boots/reboots. The CPU Failure LED will be ON until the user initiates startup. (Refer to Figure I.2.)



User should select CONTINUE to initiate applications.

User should select ABORT to abort applications.

Figure I.2 Singapore Application Initiation

## I.2 Chicago

The LOCAL SETTING choice of CHICAGO disallows local drill or signal silence.

- The DRILL and SIGNAL SILENCE keys at the panel will not function.
- Annunciator Control Modules, SLC modules, and panel circuits given a drill or signal silence Mode or Type Code will not allow local drill or signal silence initiation.

# Glossary

This section contains descriptions of terms essential to know when programming the control panel.

**Alarm History** See History buffer.

**Alarm Verification Timer** A user-defined global software timer function that can reduce the number of nuisance alarms. When you select Alarm Verification for a detector, the control panel delays an alarm signal for a user-specified time period. (The control panel ignores the Alarm Verification Timer if it detects another alarm during the verification period.)

**Argument** An argument is a discrete part of a logic function used in a CBE logic or trouble equation. It can consist of panel/SLC addresses for detectors, modules, panel modules, zones, special function zones, logic or trouble equations.

**Auto Silence Timer** A user-defined global software timer that functions like pressing the signal silence key. The control panel silences all active outputs programmed as silenceable once the timer has reached the selected time. For example, if 20 minutes is selected, when the timer reaches 20 minutes the control panel turns off all active outputs programmed as silenceable.

**Autoprogram** A software routine that directs the control panel to identify and automatically load SLC-connected devices into the program with default values for all parameters. The Autoprogram Finds and displays all new or missing intelligent detectors and modules--while ignoring devices already installed in memory--so you can edit default option selections. Typically, you Autoprogram the control panel as a first step in a new installation, or to add devices.

**Control module** An addressable module that a) switches power to a Style Y or Style Z NAC; or b) functions as a Form-C control relay.

**CBE (Control-by-Event)** A programming method that lets you map inputs and outputs to provide a variety of output responses based on various initiating conditions (events).

**CLIP poll** - Classic Loop Interface Protocol - CLIP - is standard polling of each intelligent device (as differentiated from FlashScan poll, a method of group polling described below).

**DCC (Display and Control Center)** - Term for a display location, programmed to participate in DCC, when it has control of Acknowledge, Signal Silence, System Reset and Drill functions.

**Drift Compensation** An algorithm which permits the maintenance of a constant smoke detector sensitivity by accounting for environmental contaminants and other factors.

**Download** A function for loading a system program from a file on a personal computer and storing the program in system memory of the control panel. Also see Veri•Fire.

**FlashScan poll** - a patented system (US Patent Number 5,539,389) that enhances the speed of communication between analog intelligent devices. Communication is in a grouped fashion. When one of the devices within the group has new information, the panel CPU stops the group poll and concentrates on single points.

**History buffer** The control panel maintains a history buffer of the last 4000 events, each with a time and date stamp. History events include all alarms, troubles, operator actions, and programming entries. The control panel also maintains a 1000-event Alarm History buffer, which consists of the 1000 most recent alarm events from the 4000-event history buffer.

**latching** An attribute of a device that keeps it in an active state until the condition causing the activation is corrected and the panel is reset.

**Missing device** A device that exists in a program, but is not found by the control panel during Autoprogram, typically because the device is disconnected.

**NAC** (Notification Appliance Circuit) A circuit or path directly connected to a notification appliance device (a fire alarm system component--such as a bell, speaker, strobe, and so on--that produces an audible output, a visual output, or both). On this panel, NACs can be panel circuits, control modules or transponder points.

**New device** A device connected to the control panel, but not in program memory.

**Non-latching** An attribute of a device that follows the state of the fire alarm system. That is, if a device is non-latching, it returns to its normal state automatically when the condition clears.

**Notification Appliance Circuit** see NAC.

**Obscuration** A reduction in the atmospheric transparency caused by smoke, usually expressed in percent per foot.

**Output circuit** A control module connected to the SLC, a device connected to one of the four NACs, or a Panel Circuit, such as an ICM-4.

**Panel Circuit** A circuit on a module connected to the control panel through connectors on the control panel. The control panel identifies a Panel Circuit with the addressing convention Px.x. For example P1.4, indicates Panel Circuit 4 on the first-position module connected to the control panel.

**Point** A system memory address occupied by an addressable SLC device, Software Zone, or annunciator. For example, the control panel considers "L01M102", a module on loop 1 at address 102, as a point.

**Panel sounder** The piezo sounder on control panel, that pulses when troubles and alarms occur.

**Primary zone** The zone in the first position of a point's zone map. The FACP looks at this zone for certain functions, such as some Cross Zone activations or Walk Test participation.

**Silence Inhibit Timer** A user-defined timer that disables the signal silence key function for the programmed time (0-300 seconds) when a fire alarm occurs. All subsequent alarms can be silenced immediately.

**SLC** (Signaling Line Circuit) A physical wire loop used to connect addressable detectors and modules to the control panel.

**General Zone** A label, internal to the fire alarm system, assigned to a group of addressable devices.

**Switch Inhibit** A software function that allows the programming of control modules, NACs, and Panel Circuits so an operator cannot manually activate NACs. With Switch Inhibit enabled, an operator cannot manually activate the NACs from the control panel.

**System Normal message** A message that displays on the second line of the LCD display during normal operation of the control panel.

**System Reset** Pressing the System Reset fixed function key will clear all latched alarms and other events if the initiating condition is gone. LEDs associated with these events will turn off. Unacknowledged events will not prevent reset from functioning. If alarms or other off-normal events exist after reset, they will resound the system. The System Reset key will not function if the programmable Silence Inhibit timer is running.

The System Reset key will not immediately silence active outputs. If the Control-by-event programming for the output evaluates false after reset, the output will deactivate. (Typically this is 30 seconds local, 60 seconds network.)

**Terminal Interface** EIA-232 bidirectional serial port used for upload and download functions.

**Tracking** An attribute of a device that allows it to enter an active state when a condition causes its activation, then to return from an active to an inactive state when the condition causing its activation is corrected.



**Type Code** A Type Code is a software function that specifies the function of a detector, control module, monitor module, transponder point, NAC, or Panel Circuit point. (You can select a Type Code while programming a point). The Type Code specifies what action the control panel takes when the point activates. For example, when a monitor module with evacuate as a Type Code activates, the control panel activates all outputs, as if someone pressed the drill key.

**Upload** A function for making a copy of a system program and storing the program as a file on a personal computer. Also see VeriFire™ Tools Programming Utility.

**VIEW®** (Very Intelligent Early Warning) System A smoke detection system, consisting of the IFC-3030 control panel and intelligent laser detectors, that provides very early warning of smoldering fires.

**VeriFire™ Tools Program Utility** A software utility for uploading and downloading a system program between a personal computer and the control panel through the EIA-232 port.

**Walk Test** A feature that lets a single (qualified) maintenance person to test a fire alarm control panel and initiating devices without causing the control panel to enter into an alarm state.

**Zone Map** SLC and panel circuit inputs (detectors and monitor modules) and outputs (control modules) provide for up to ten zone selections for CBE.



# Index

## Numerics

5351J 117

## A

Abort Switch 90

AHJ 96

Basic configuration example 91

Configuration example with monitor module 100

IRI 93

NYC 94

To program 100

Type Code (ULI, IRI, NYC, AHJ) 52, 89

ULI 92

AC Fail Delay 24

ACCEPT soft key, about 12

Acclimate, detector sensitivity settings 120

Acknowledge

AKS-1 30

Local control 21

ACPS-2406 24

ACS

Annunciation, releasing applications 112

Number of annunciator devices per circuit 26

Point Programming 28

Programming

Mode 29

Point 28

Source 29

Smoke control devices 27

TM-4 27

Type 27

UDACT 27

UZC Zone Coder 27

Action level, prealarm 119

Address

To display 22

Advanced Warning Addressable Combustion Sensing

See AWACS Applications 115

AHJ Abort Switch 96

AKS-1 keyswitch, functions 30

Alarm Sensitivity

Levels 117

Alarm, to set 41

Prealarm, to set 41

Table, displayed on screen 41

To select 68, 119

Alarm Verification 24, 40, 45, 49, 143

Alert Level, pre-alarm 118

Alter Status 65–77

Clear History 69

Alarm, Event or All History 70

Clear Verify Counters 69

Control On/Off 76

Force On/Off 77

Point select 76

Detector Alarm Sensitivity 67

Occupied & Unoccupied Alarm & Prealarm Sensitivity 68

Point Select 67

Disable/Enable 66

Point selection for disable/enable 66

Program Time/Date 75

Walk Test

Advanced 71

Audible 71

Disable ACS Boards 72

Panel test screen 75

Parameter 72

AMG 12, 27

AMPS-24 24

Annunciator, See ACS 27

Application Corrupt Screen 83

Argument 126, 143

Arrow keys 11

Auto Silence 25, 143

Autoprogram 58–63, 143

Auxiliary Control Functions, releasing applications 112

Auxiliary trouble reporting 30

AWACS Applications 115–124

Cooperative Multi-Detector Sensing 118

Detector Sensitivity 117

Drift Compensation 115

Maintenance Warnings, 3 levels 116

Self-Optimizing Prealarm 117

Smoothing 115

## B

BACK soft key, about 11

Beam detector sensitivity settings 42, 120

Bell coding 22, 114

Blink Mode 34

Bootloader Screen 81

## C

Canada

Auto Silence Value 25

Event ordering 21

ULC installation Alarm Verification timer value 24

Caution

- On systems utilizing the DCC function... 22
  - CBE (Control-by-Event) 125, 143
  - CCBE (Cooperative Control-By-Event) 125
  - Channel A,B thresholds 19
  - Clear
    - ACS programming 57
    - All programming 57
    - History 69
    - Loop programming 57
    - Panel modules programming 57
    - Panel programming 57
    - Verify Counters 69
  - CLIP Mode 34
  - Coding 22, 114
  - Communication loss, panel & SLC 40
  - Control Module 143
    - See Module, SLC or Panel Circuit
  - Control On/Off 76
  - Cooperative Multi-Detector Sensing 40, 118
  - CRM-4RK/ICE-4 48
  - Cross Zone 89
    - Programming example 98
    - To activate a Releasing Zone 97
    - Types 97, 98
  - Custom Action message
    - Detector 40, 41
    - Module 45
    - Panel module 49
    - To create 35
    - To view 35
    - To view, point 41
- D**
- DCC Participation 22
  - Default settings soft key 23
  - Default Timers soft key 25
  - Delay Time 89
  - Delete point 57
  - Delete Program 56
    - Clear
      - ACS programming 57
      - All programming 57
      - Loop programming 57
      - Panel 57
      - Panel module programming 57
    - Delete point 57
  - Delete Program Menu, when programming panel the first time 18
  - Detector
    - Alarm Sensitivity Levels 41, 67, 117
    - Alarm Verification 40
    - Custom action message 40
    - Drift Compensation 115
    - Extended label 38
    - FlashScan code label 38
  - Label 38
  - Local Mode 40
  - Maintenance Level messages 116
  - Maintenance Warning 116
  - Multi-Detector (Coop) 40
  - Occupancy Schedule 42
  - Point programming 38
  - Poll 34
  - Pre-Alarm Sensitivity Level 117
  - Print a Detector Maintenance Report 122
  - Sensitivity 40
  - To replace 131
  - To test detectors set below 0.50% obscuration per foot 121
  - Type Codes 38
  - Weekly Occupancy Schedule 42
  - Zone map 38, 39
- Disable/Enable Point Selection 65
- Displayless Mode
  - Service-level switches, ACK, SIG-SIL, SYSRST, LAMP 11
- Do not assign Releasing Type Codes to Panel... 135, 136
- Download 143
- Download screen 83
- Drift Compensation 115, 143
  - Graphic representation 116
- Drill
  - AKS-1 30
  - Local control 21
- E**
- Equations
  - Arguments 126
  - Editing 52
  - Logic 126
    - Functions 126
  - Time-based functions 127
  - Trouble 129
- Event Counts Display 15
- Event logging 36
- Event ordering
  - Canada Event Order 21
  - USA Event Order 21
- Extended label 38, 44, 48
- F**
- Factory default settings
  - Password 12
- Field information, how to enter 11
- Fixed position, detector zone map 39
- FlashScan code label 38, 44
- Force On/Off (point) 77

**G**

General Zone 51, 144  
Group Zone Disable 66

**H**

Heat (Adjustable Threshold), detector sensitivity settings 120  
History buffer 143  
History Display 15  
Holiday menu 36

**I**

ICM-4RK/ICE-4 48  
IFC-3030  
    Displayless Mode 11  
    Two basic configurations 11  
Initial programming  
    Basic procedure 12  
Initiating Devices for releasing zones 112  
Insert (Logic equation screen) 53  
Instant Release Circuit  
    Control module configuration example 110  
    To program 110  
Ion FSI-751, detector sensitivity settings 120  
IP Access 20  
IRI Abort Switch 93  
IZM-8RK/IZE-A 47, 48, 50

**J**

J5 of CPU-3030 30  
JCPU-3030 30

**L**

Label, point 38, 44, 48  
Language selection 26  
    LCD-160 82  
latching 143  
LCD Programming 26  
LCD programming  
    Backlight 26  
    Current setting 26  
    Factory default setting 26  
    Intensity down 26  
    Intensity up 26  
    Language 26  
LCD-160 Download Menu  
    Address 81  
    Language 82  
LCM Download Menu 82  
LCM Local Mode, See Local mode 22  
Local control 21  
Local mode 22, 40, 45, 47  
Local Receive mode 21

Local Settings 23  
Logic equations, editing 52  
Logic Zone 52, 125  
Loop Download Menu  
    Download Type 82  
    Loop Address 82  
Loop programming 34  
    CLIP 34  
    Configuration 33  
    Detector poll 34  
    FlashScan 34  
    Module poll 34  
    Rapid poll 34  
    Wiring style 34

**M**

M302MJ  
    & alarm verification 45  
M500XJ module 140  
Main Menu 11, 15  
Main Power Supply Address 30  
Maintenance Warnings 116  
Major changes and additions  
    Basic procedure 12  
Manual Release Delay Switch  
    Monitor module configuration example 102  
    To program 102  
Manual Release Switch  
    Monitor module configuration example 101  
    To program 101  
March Time coding 22, 114  
Master password, see Password 13  
Maximum verification count 24  
Menu Hierarchy 85  
Module poll 34  
Module, Panel Circuit  
    Coding 22  
    Control 50  
        Silenceable 50  
        Switch Inhibit 50  
        Walk Test 50  
        Zone map 50  
    Extended label 48  
    Label 48  
    Module Type (Control/Monitor) 48  
    Monitor 49  
        Alarm Verification 49  
        Custom Action message 49  
        Zone map 49  
    Point addresses 47  
    Type Codes 48  
Module, SLC  
    Control 46  
        Custom action message 45

- Local mode 47
- Silenceable 46
- Switch inhibit 46
- Walk test 46
- Zone map 46
- Extended label 44
- FlashScan Code label 44
- Label 44
- Module Type (Control/Monitor) 44
- Monitor 45
  - Alarm verification 45
  - Local control 45
  - Zone map 45
- Type Codes 44
- Monitor Module, see Module, SLC or Panel Circuit
- Multiple Event List 15
- Multiple Events List screen
  - order of events 21

## N

- NAC (Notification Appliance Circuit) 144
- Navigating Menu and Programming Screens 11
- NBG-12LRA 90, 100, 101, 102, 104
- Network Parameters 19
  - Channel threshold 19
  - Node
    - Label 19
    - Number, range 19
    - Standalone 19
    - To view 19
  - Wiring style 19
- NFPA Standards for Releasing Applications 90
- Node label 19
- Node number 19
  - For standalone panel 19
  - Range 19
  - To view 19
- Non-fire activations
  - Event logging 36
- Non-latching 144
- Note
  - 120 seconds is the maximum delay after...(NYC timer) 94
  - A module with a releasing Type ID cannot be forced off. 77
  - A printout of all the messages.... (Custom Action messages) 35
  - A releasing circuit with this Type Code requires...(REL END BELL) 105
  - A setting of NO (disable) will disable key-switch operation. 21
  - A ULC Release circuit with this Type Code requires...(REL CKT ULC) 106
  - All events except troubles are annunciated during programming... 17

- An AHJ timer does not comply with UL Standard 864. 96
- An NYC timer does not comply with UL Standard 864. 94
- Clearing all programs is not necessary when...(VeriFire) 18
- Deleting points that are active or in trouble... 57
- Do not include ZF8 in the zone map of Panel Circuits used for...(releasing, zone coding) 114
- If the point is not installed...(saving entries) 44
- No program menus will display if a user password...(Alter status level) 17
- The IZM-8RK module does not participate in Walk Test... 50
- The panel setting LCM LOCAL MODE must be set to Yes... 40, 45
- The second shot switch can only be used...(MAN REL DELAY) 104
- This soft key will not appear for modules with Type ID...(silence option) 50
- This value may not exceed 30 seconds for ULC... 24
- This value may not exceed 30 seconds for ULC.... 24
- This value must be 20 minutes for ULC... 25
- To change the language of the remote display 32
- When changing from an 80-column or 80-column supervised... 30
- When the ACCEPT soft key is pressed to save an equation... 53
- NYC Abort Switch 94

## O

- Obscuration 144
- Occupancy Schedule 31, 42
  - Holidays 36
- Output activations
  - Event logging 36
- Output circuit 144
- Overwrite (logic equation screen) 53

## P

- Panel Circuit 144
  - See Module, Panel Circuit
  - See Point Program
- Panel circuit modules are not suitable for... 99
- Panel programming, see Programming, Panel settings
- Panel settings 21
  - AC Fail Delay 24

- Alarm Verification timer 24
  - Auto Silence 25
  - Auxiliary trouble reporting 30
  - Custom Action message 35
  - Default Settings 23
  - Default Timers 25
  - Display Address 22
  - Event logging 36
  - Event Ordering 21
  - Holiday menu 36
  - Local Control 21
  - Local mode 22
  - Local Receive mode 21
  - Loop configuration 33
  - Loop programming 34
  - Maximum verification count 24
  - Panel circuit bell coding 22
  - PAS 25
  - Password 31
  - Piezo 21
  - Poll types 34
  - Presignal delay 25
  - Proprietary Supervising Station 21
  - Reminder Menu 22, 23
  - Remote Display Menu 32
  - Silence Inhibit 24
  - Supervision 30
    - Main power supply address 30
    - Printer 30
  - Tamper input 30
  - Timers 23
  - Trouble reminder 23
  - Verify-Prealarm 25
  - Weekly occupancy schedule 31
  - Panel sounder 144
  - Panel Timers 24
  - PAS (Positive Alarm Sequence) 113
    - Inhibit switch 113
    - Setting 25
  - Password 12, 31
    - Factory default settings 12
    - Incorrect or forgotten 14
    - Master 12, 13
    - User 12, 13
      - Level of access 14
  - Piezo 21
  - Point 144
    - Selection for programming 37
  - Point Program 37
    - Autoprogram 58
    - Delete Point 57
    - Detector point 38
      - See also Detector
    - Disable/Enable Point 65
    - Module Point, SLC 43
      - See also Module, SLC
    - Panel Circuit Module Point 47
      - See also Module, Panel Circuit
    - Point select 37
    - Zones 51–56
  - Poll types 34
  - Position 10 in zone map 39
  - Position 9 in zone map 39
  - Position one in zone map 38, 45, 46
  - Power-up Screen 80
  - Pre-Alarm 118
    - Action Level 119
    - Alert Level 118
    - See also Alarm Sensitivity 117
    - Self-optimizing 117
    - Sensitivity Levels 117
      - To select sensitivity 119
  - Prealarm (Action), fixed position zone 39
  - Presignal delay 25
  - Presignal Delay Timer/PAS 113
  - Primary zone 38, 97, 144
  - Printer Functions 16
  - Printer supervision 30
  - Program Time/Date 75
  - Program/Alter Status 16
  - Programming
    - ACS 26
    - Alter Status 65–77
    - Autoprogram 58
    - Delete program 56
    - Detector point 38–42
    - First time, Delete Program Menu 18
    - LCD screen 26
    - Module point 43–50
      - Control 46, 50
      - Monitor 44, 49
      - See also Module
    - Panel 18–37
      - See also Panel settings
    - Point 37–63
      - See also Point Program
    - Presence of unacknowledged alarm 12
    - See also Point Program, Panel settings
    - Two levels
      - Alter Status 17
      - Program 17
    - Zones 51–56
  - Proprietary Supervising Station 21
- ## R
- Rapid poll 34
  - Read Status 16
  - Receiving Station, see this panel's installation manual. 21
  - Release Audible Circuit
    - Output module configuration example 109
    - To program 109

- Release Circuit
    - Output module configuration example 107
    - To program 107
  - Release Code Bell Circuit
    - Configuration example 111
    - To program 111
  - Release End Bell Circuit
    - Output module configuration example 105
    - To program 105
  - Release Form-C Circuit
    - Output module configuration example 108
    - To program 108
  - Releasing Applications 89–112
    - Abort Switch 89
    - ACS Annunciation 112
    - Auxiliary Control Functions 112
    - Cross Zones 89
      - Types 97
    - Delay Time 89
    - Initiating Devices 112
    - Soak Time 89
    - Switches & Circuits, programming & configuration 100–111
    - Warning sounders 112
  - Releasing Zones (R0-R9) 125
    - Type codes for inputs/outputs 98
  - Reminder Menu Screen 23
  - Remote Display Menu 32
  - Removed /E from IFC-3030, global. 10
  - Reset 144
    - AKS-1 30
    - Local control 21
- S**
- Scrolling 11
  - Second Shot Switch
    - Monitor module configuration example 104
    - To program 104
  - Self Test 80
  - Self-Optimizing Pre-Alarm 117
  - Sensitivity, see Alarm Sensitivity Levels, Detector
  - Service Screens 79
    - Application Corrupt Screen 83
    - Download screen 83
    - LCM Download Menu 82
    - Power-up screen 80
    - Version Information 79
  - Signal Silence
    - AKS-1 30
    - Disabling with Silence Inhibit timer 24
    - Local control 21
  - Silence Inhibit Timer 24, 144
  - Silenceable 46, 50
  - SLC (Signaling Line Circuit) 144
  - Smoke Control devices 27
  - Smoothing 115
  - Soak Time 89
  - Special Zone F0, notes and restrictions 113
  - Special Zone Outputs 113–114
  - Special Zones 125
  - STS-1 tamper switch 30
  - Supervision 30
  - Switch Inhibit 46, 50, 144
  - Switches, service level, displayless mode 11
  - System Troubles 139
- T**
- Tamper input 30
  - Temporal coding 22, 114
  - Threshold, Channel A & B 19
  - Time control, special zones 113
  - Time-based functions 55
    - Equations 127
  - Timers 24
  - TM-4 24, 27, 114
  - Trouble bus cable, for auxiliary trouble reporting 30
  - Trouble Equations 129
  - Trouble Zone 55, 125
  - Trouble, Point - see this panel's Operations manual
  - Trouble, System 139
  - Type Codes 44, 48, 145
    - Explanation 133
    - For Intelligent Detectors 134
    - For Monitor Modules 135
    - For releasing zone inputs/outputs 98
    - For SLC & panel circuit output modules 136
    - See also Point Program 38
    - To select 133
- U**
- UDACT 24, 27
  - UL Standard 864 92, 93, 94, 96
  - ULC Release Circuit
    - Output module configuration example 106
    - To program 106
  - ULC, auto silence value 25
  - ULI Abort Switch 92
  - User password, see Password 13
  - UZC Zone Coder 27
- V**
- VeriFire™ Tools Program Utility 145



Use with displayless mode 11  
Verify-Prealarm 25  
Version Information 79

## W

Walk Test 46, 50, 70–75, 145  
Advanced  
Audible 71  
Basic 71  
See also Alter Status 70  
Type IDs, modules, that do not participate 46

### Warning

Do not rely on Disable to disable releasing points during.... 66, 89  
If you replace any detector with a different type... 131  
The IRI abort switch will only work if it is pushed before.... 93  
When using alarm verification, do not mix ....(IZM-8RK) 47

Warning Sounders, releasing applications 112

Weekly occupancy schedules 31, 40, 42

Wiring Style 34

wiring style, network 19

## X

XLS-3030/E  
Displayless Mode 11  
XPIQ power supply 24

## Z

Z000 general alarm 118

### Zone map

Control module 46, 50  
Detector 38, 39  
Monitor module 45, 49

### Zones

CBE 125  
Fixed positions in map  
Detectors, position one 39  
Detectors, position ten 39  
primary zone 38, 97  
Sounder/relay bases, position nine 39

General Zone 51  
Zone label 51

### Logic 52

Add logic function 53  
Add point 53  
Add Time/Date 53  
Delete equation 53  
Edit Equation 52  
Enter time 55  
Logic function 55  
Point select 54

Position layout 38, 39

Position one, initial programming 38, 45, 46

Releasing 51, 89–112

Abort Switch 52  
Cross Zone 52  
Delay Time 52  
Soak Time 52

Special Zones 125

Trouble 55

Z000 general alarm 46, 50, 119, 125





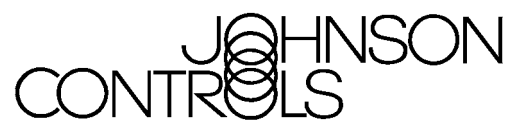

**Controls Group**

507 E. Michigan Street

P.O. Box 423

Milwaukee, WI 53201

[www.johnsoncontrols.com](http://www.johnsoncontrols.com)

Release C

Printed in U.S.A.