

ELECTRICAL DISTRIBUTION SYSTEMS

By

Dr Kyaw Naing

Section 1 – Distribution System

1.1 Describe the common system for electrical distribution	5
Distribution	5
System of Distribution	5
Relative Merits of Overhead and Underground Systems	5
Standard Voltages	7
Distribution Systems	7
Spacing of Substations	7
Single Phase Systems	7
Types of Feeders	8
Radial Feeders (Figure 3)	8
Parallel Feeders (Figures 4 and 5)	9
Ring Main Feeders	10
Substation Busbar Arrangements	10
Electrical Power System Considerations	11
Reserve, diversity, and economical dispatch	12
Industrial Heating	12
Electric Furnaces	12
Electronic Loads	13
Power Factor	13
Consumer Classification	13
Consumer Factors	13
Maximum Demand	13
Diversity Factor	13
Coincidence Factor	14
Utilisation Factor	14
Review questions for Section 1	15
2.1 Identify relevant components use in over head line design	16
Conductor Supports	16
Arcing Horns	20
Insulator Ties	20
2.2 Outline relevant factors related to installation, maintenance, cross arms, stays, pole types and choice of conductors sizes for commonly used configuration	21
Limiting Size of Aerial Conductors	21
Regulation 28.(1)	22
Regulation 28.(2)	22
SAGS	22
SAG Calculations	23
Table 1	23
Erection Sags	24
Sag Measurement	24
Sometimes the approximate formula is used	24
Wave Timing Chart	25
Figure 11	25
Wood Poles	28
AAC (All Aluminium Conductor)	28
2.3 Determine mechanical limitations and physical dimensions of lines – Part 1	31
Overhead Line Conductors	31
Material	31
Conductor Current Rating	31
Heating	32
Conditions Affecting Maximum Conductor Temperature	32
Fault Conditions	32
Voltage Drop	33
Power Losses	34
Pin Insulator Designation	34
Pin insulators are designated by a series of letters and numbers	34
Shackle Insulators	34
Disc Insulators	34
Stay Insulators	35
Insulator Pins	35
Causes of Insulator Failure	37
Mechanical Properties of Overhead Conductors	37
Reference	37
Working Strengths	37
Maximum Tensions	37

Section 1 – Distribution System

2.3 Determine mechanical limitations and physical dimensions of lines – Part 2	38
Armour Rods and Vibration Dampers	38
Helically Formed Fittings.....	38
Armour Rods.....	38
Line Guards	38
Vibration Dampers	38
Terminations or Dead Ends	39
Insulating Materials for Electrical Conductors	39
Polyvinyl Chloride (P.V.C).....	39
Cross-Linked Polyethylene (XLPE).....	39
Ethylene Propylene Rubber (EPR)	40
Impregnated Paper	40
2.4 Determine leading limitation using design schedules and calculations (Part 1)	42
Wood Poles.....	42
Table 7.2 Wood Pole Strength Tables	45
Steel Poles.....	46
Main Street Feeder Conversion	51
2.4 Determine leading limitation using design schedules and calculations (Part 2)	53
Criteria	53
Poles.....	53
Stresses.....	53
The cross sectional area at the top of a class 5 pole is	54
Bending Moment.....	55
Maximum Fibre Stress	55
So that	55
Wind Pressure	55
The pressure on the rectangle (P_x) will be	55
The pressure on the triangle (P_τ) will be	55
And its moment about the base will be	56
And the load pressure on the pole (P_2) will be	56
And the total moment on the pole (M_2) will be	56
Examples 5-2.....	56
$M = \frac{4}{144} (34 \times 12)^2 \times \left(\frac{8}{3} + \frac{12}{6} \right) = 21,580 \text{ in lb or } 1798 \text{ ft lb}$	56
Say 700 lb/in^2	56
Assume long leaf yellow pine, $f = 7400 \text{ lb/in}^2$, is used	57
Table 5-2 Resisting Moments and Data for 40ft Poles	57
Example 5-4.....	58
For the three no. 4/0 conductors,	58
$= \sqrt{\frac{3790 \times 420 \times 10^2}{7400}} = 59,91 \text{ in at ground line}$	59
Check for the possibility of using a wallaba pole, $f = 11,000 \text{ lb/in}^2$	59
2.4 Determine leading limitation using design schedules and calculations (Part 3)	60
Example 5-5.....	60
$X = \sqrt{150^2 - 30^2} = 146.96 \text{ ft}$	60
$C = \sqrt[2]{\frac{3790 \times 416,000}{7400}} = 59.73 \text{ in at ground line}$	61
Check for possible use of a wallaba pole, $f = 11,000 \text{ lb/in}^2$	61
Example 5-6	61
Total moment on pole $= \sqrt{996.3^2 + 5.694^2} \times 10^2 = 996,316 \text{ ft-lb}$	61
Equipment on Poles.....	61
Cross Arms	62
Bending Moment.....	62
Example 5-7.....	63
Double Arms	64

Section 1 – Distribution System

Cross Arm Brace.....	65
Table 5-3 – Ultimate Bearing Strength of Wood.....	66
Pins.....	66
Loading.....	66
Double Pins.....	67
Pins in Lieu of Cross Arms.....	67
Insulators.....	69
Loadings.....	69
Pin Type.....	69
Post Type.....	69
Suspension or Strain Type.....	69
Strain Ball Type.....	69
Spool Type.....	69
Guys and Anchors.....	70
Stresses.....	70
Anchor Guy.....	71
Span Guy.....	71
Loading.....	71
If T is the total tension caused by all the conductors, and a is the angle of.....	71
And the total stress handled by the guy is twice that, or.....	71
$L_x = L_y \tan b$ or $L_x + L_c \sin b$.....	73
And the fibre stress in the pole at the point of attachment of the guy will be.....	73
Where d is the diameter of the pole at this point.....	73
Guy Wires.....	73
Anchors.....	74
2.4 Determine leading limitation using design schedules and calculations (Part 5).....	75
Table 5-5A Classification of Soils.....	75
Straightaway Poles.....	76
Angle Poles.....	76
Dead End Poles.....	77
Guying Requirements.....	77
General.....	77
Straightaway Poles.....	77
Table 5-20 Multipliers for determining tension in guy wire when tension in line wire is known.....	76
Applicable to conditions A to D inclusive; see illustrations below.....	78
Table 5-21 Allowable Guy Tensions.....	80
Construction.....	80
Concrete Poles.....	80
2.5 State pole and line installation techniques.....	81
11.3.2 Structure construction procedures.....	81
11.6.1 Tension definition.....	81
Wire and Temperature Limits for ACSR & 6201 AAAC.....	82
Line Planning.....	82
11.10.1 Plan-profile Drawings.....	83
11.10.7 Final Drawings.....	85
2.6 Recall regulations pertaining to over head lines.....	115
Notes and comments on some of the overhead line construction and maintenance regulations.....	115
Regulation 12 - Protection against corrosion.....	115
Example.....	116
Maximum angle of deviation = 15.6°.....	116
Regulation 18 – Supports.....	117
Regulation 19 – Earthing and Insulating of Metalwork.....	117
Regulation 20 – Prevention of Unauthorised Climbing.....	120
Regulations 21 – 26 – Overhead Service Lines.....	120
Regulation 28 – Size of Conductors.....	120
Regulation 33 – Separation of Conductors.....	121
2.7 Measure ground levels, deviation angles and compass bearings.....	126
Basic Survey Methods.....	126
Method 3 – Polar Co-ordinates/radiation.....	127
Site Surveying and levelling.....	129
Chain lines: AB, BC, CD, DA, DB, and AC.....	131
2.1.2 Survey Stations.....	131
2.1.3 The Base Line.....	131

Section 1 – Distribution System

2.3.6 Tapes	132
2.4.4 Laying-down the Chain	133
2.8 Perform basic survey of short distribution line extension to produce field notes.....	136
Re-Engineering the Transmission Line Design Process	140
INTRODUCTION	151
SURVEYING.....	151
ENGINEERING.....	153
DRAFTING.....	158
PROCUREMENT.....	159
CONCLUSIONS.....	160
REFERENCES	160
Review questions for Section 2.....	161
Label	164
3.1 Describe the construction features and insulation abbreviations of under ground cable..	168
Cables.....	168
The conductor.....	168
The conductor is made of either copper or aluminium	168
Types of Cables	169
Current Rating of Cables.....	170
Sheath Currents.....	170
3.2 Calculate cable voltage drop in relation to length of cable run (Part 1)-----	173
Calculation of voltage drop, Calculation of unit voltage drop, Single & 3 phase voltage drop, Maximum Voltage drop, Cable size selected, Practical exercises, Selection of cable based on voltage drop	
3.3 Recall techniques to reduce electrical stress on cables-----	183
Cable stand, Bending of cable, Temperature rating, Enclosure of cable, Type of conductor	
3.4 Recall cable rating factors, method of cable joining-----	187
Stripping cable, Basic terminating method, Soldering	
3.5 Apply cable schedules for underground cable installation scheme-----	190
Underground cable, Types of cables, Laying, Insulation resistance, Effect of inter-sheath on stress Capacitance grading, PF of single core cable, Capacitance of 3 core cable, Breakdown voltage and mechanical breakdown	
3.6 Describe techniques used to install cable and associate equipments-----	219
Ducts, Service box, Cable manhole, Transformer manhole, Design loading on manhole, Underground equipments	
3.7 Recall cable testing techniques and methods used to find the location -----	226
of cable fault	
Sectionalizing, Time domain reflectory method, Megger test	
4.1 Recall Terminology used in relation to voltage profile-----	231
Voltage regulation, Off load tap changer, On load tap changer, Booster transformer, Quadrature booster Induction voltage regulator	
4.2 Describe the reasons effects and limitation of voltage variation-----	232
Voltage control, Voltage drop, SAA Rules, Power loss	
4.3 Recall methods used in controlling voltage level Part 1-& 2-----	233
Method of voltage control, Voltage control equipments, Induction Voltage regulator, Constant ratio transformer, Voltage regulation by control current, Voltage profile	
Review Questions for section 3 and 4-----	245
References-----	260

Section 1 – Distribution System

1.1 Describe the common system for electrical distribution

The major electrical items encountered in most types of industrial commercial plants are listed below.

1. Power generation equipment, or purchased power switching, or substation.
2. Primary and secondary distribution systems, including feeders, transformers, switchgear, protective equipment and standby generating plant.
3. Motor drives, heaters, ovens and the associated wiring and control equipment.
4. Lighting equipment and lighting wiring circuits.
5. Electrical and electronic control and instrumentation systems.
6. Auxiliary systems (fire alarms, electric clocks, burglar alarms).
7. Communication equipment (paging, intercommunication).
8. Special items peculiar to processes such as welding, batteries, rectifiers, electroplating apparatus, elevators and lifts, industrial trucks, cranes and hoists, ventilation and air-conditioners.
9. Yard, roadway, and protective lighting.

Distribution

The limit of distribution is usually to be from substations to consumer's service lines and distribution within the consumer's premises.

System of Distribution

The systems of distribution may be classified as follows:

- Overhead distribution.
- Underground distribution
- Combined overhead and underground distribution

Relative Merits of Overhead and Underground Systems

Overhead lines are less expensive than the underground cables throughout the whole range of system voltages, the difference being extreme at the higher voltages encountered in the field of transmission.

Overhead lines operate under continual stress and exposure to varying climatic conditions. This results in progressive deterioration because of both mechanical wear and corrosion. Line components must therefore be periodically replaced.

The greater spacing of overhead line conductors enables higher current ratings to be used but this produces higher circuit inductance.

The load capacity of an overhead feeder can be readily increased at relatively low cost by replacing it with larger conductors, or by using parallel feeders; however the

Section 1 – Distribution System

swamping effect of inductive reactance should be considered for low voltage conductors greater than 100mm² aluminium.

Poles and lines are considered unsightly, especially in built up areas.

Section 1 – Distribution System

Standard Voltages

The Australian Standard C1 1969 – *Standard Voltage and Frequency for a.c. Transmission and Distribution Systems* sets out the voltages which are to be regarded as standard. These are shown in the following tables:

Standard Voltages for Three Phase Systems

415 volts (voltage to neutral 240 volts)

11 kV

22 kV

33 kV

66 kV

Voltages of 3.3 kV and 6.6kV previously used for distribution are not considered satisfactory with the greater use of electricity. Such existing installations tend to be replaced by 11 kV and 22 kV.

Distribution Systems

Electricity supply systems follow a relatively uniform pattern.

The voltages vary with different authorities, and spacing and size of substations are dependent on the density of population.

A typical distribution system illustrated in Figure 1 Comprises:

Sub-transmission circuits operating at 33 kV or above which deliver energy to the zone substations.

Spacing of Substations

For a residential area the zone substations may be spaced at intervals of about 3-10 km and have a capacity of 7.5 MVA to 30 MVA.

The distribution centres would be spaced 400 – 600 metres apart and each would need to have a capacity of 500 kVA. The sizes and spacings are appropriate only, and in city areas one building may need in excess of 5 MVA.

Single Phase Systems

For rural systems economical distribution is usually accomplished by means of single phase systems.

The high voltage distribution can be of the standard three phase type for rural areas adjacent to suburban areas, but as the distance from such areas increases, the single wire earth return (SWER) system proves the most economical method. This involves only one high voltage conductor at 12.7 kV or 19.1 kV above earth potential. The low voltage system can then be a two wire system at 240 volts or three wire system at 480 volts – 240 volts to neutral. A typical distribution is shown in Figure 2.

Section 1 – Distribution System

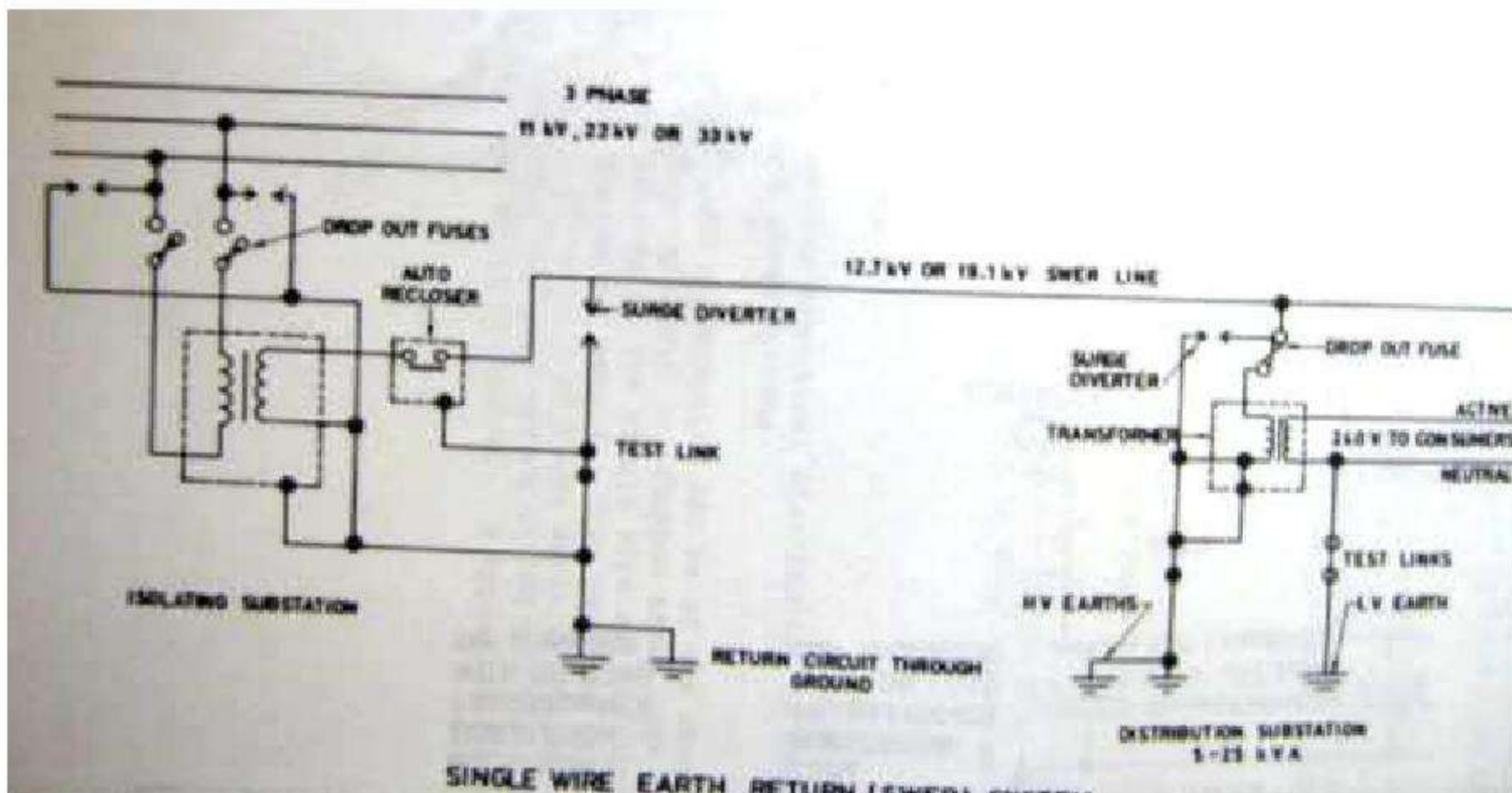
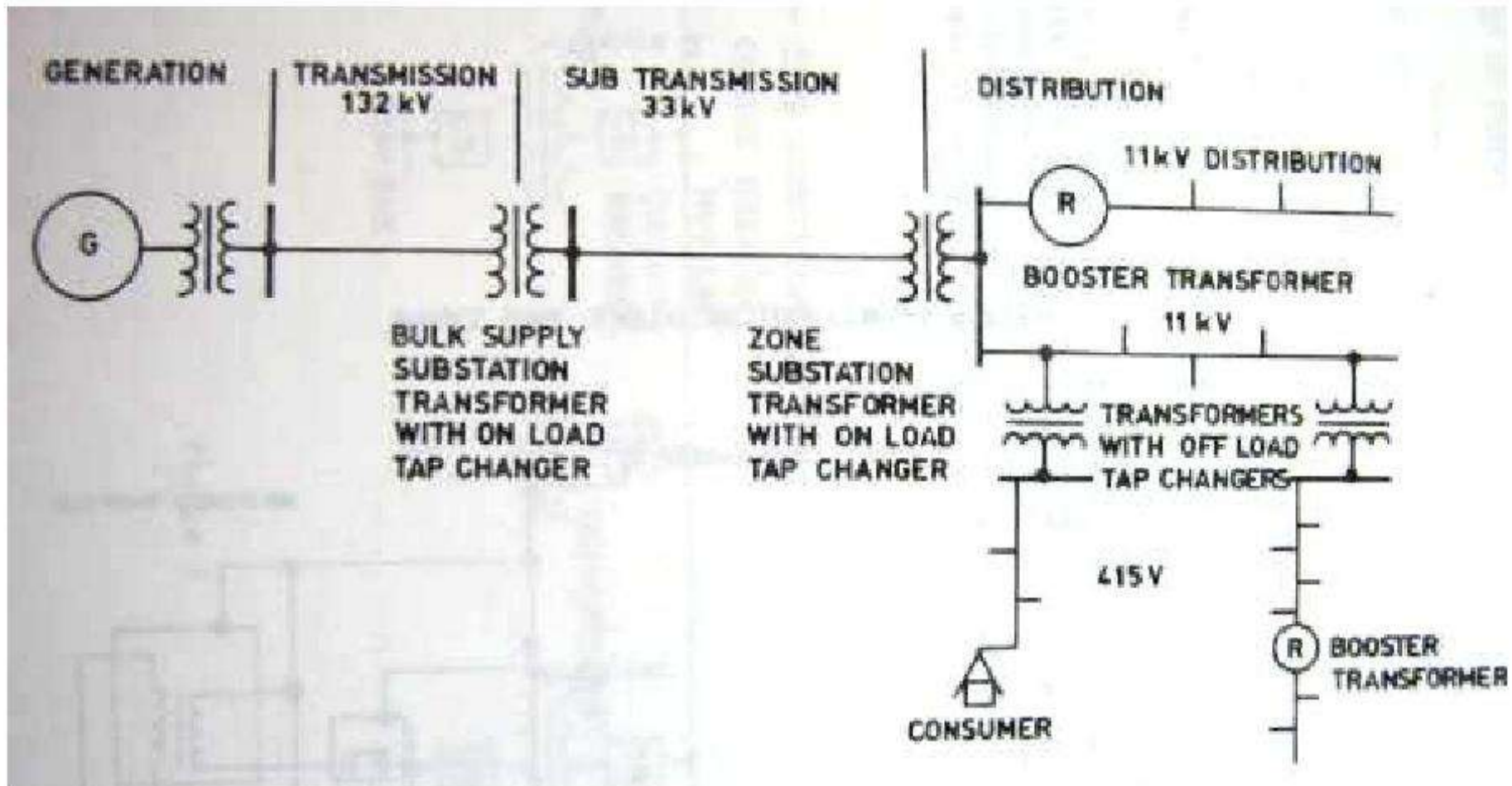

Types of Feeders

Three types of feeders are commonly used for distribution systems.

These are:

- Radial feeders
- Parallel feeders
- Ring main feeders

Radial Feeders (Figure 3)

These are the simplest and least expensive both to construct and protect, particularly in overhead areas. The occurrence of faults results in a number of customers being without service until the fault has been located and cleared. To minimise interruptions to customers, reclosing breakers and sectionalisers are used, but if the fault is not self clearing all customers will be affected.

Section 1 – Distribution System

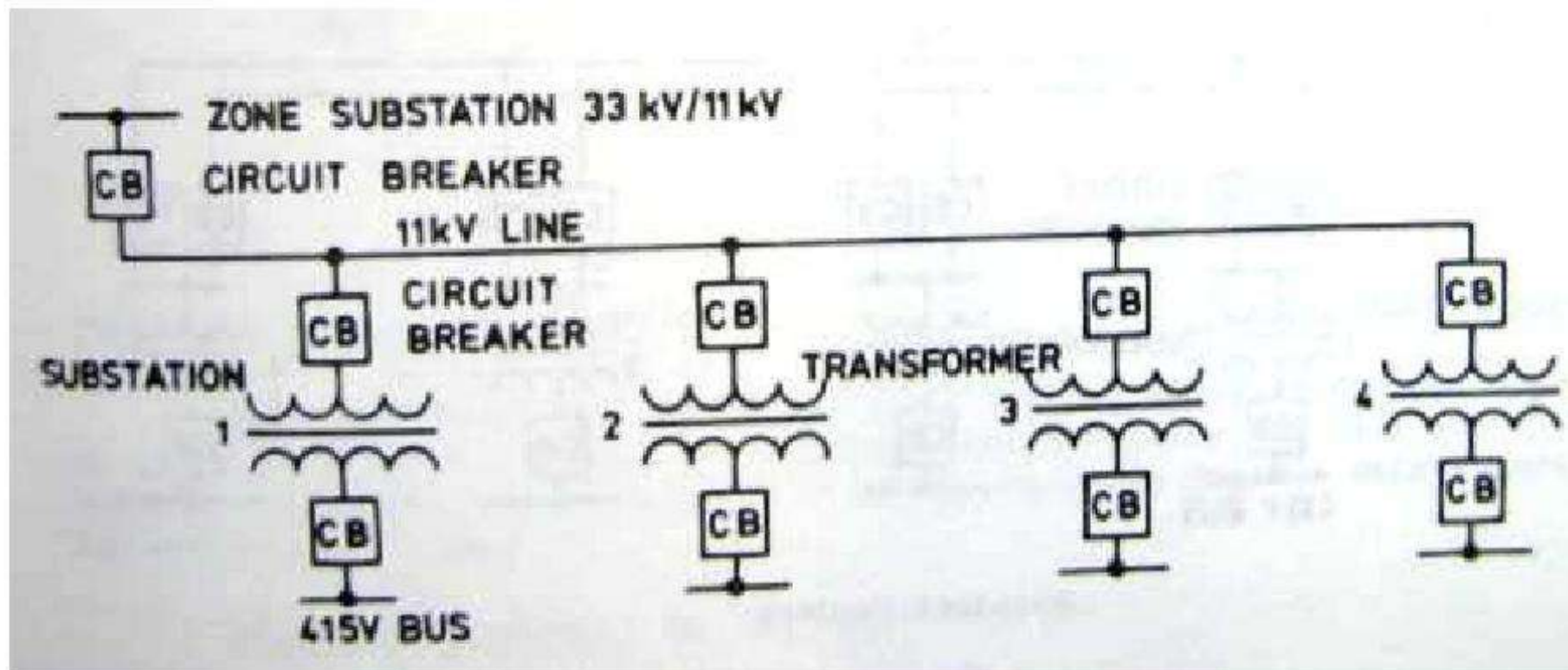

Parallel Feeders (Figures 4 and 5)

If separate routes are taken in either underground or overhead construction, the capital cost is double that of a radial feeder. If, however, the two cables are laid in the one trench or a double circuit overhead line is built, the first cost is about 140 per cent of that of radial construction. Protection is more complicated.

The big advantage of this system is that it ensures a firm supply to distribution centres with underground high voltage systems.

With overhead systems the reliability of a double circuit line is considerably below that of two separate routes since both circuits are likely to be affected by lightning, storm damage or structural failures. There is great advantage, however, in the maintenance of lines and circuit breakers.

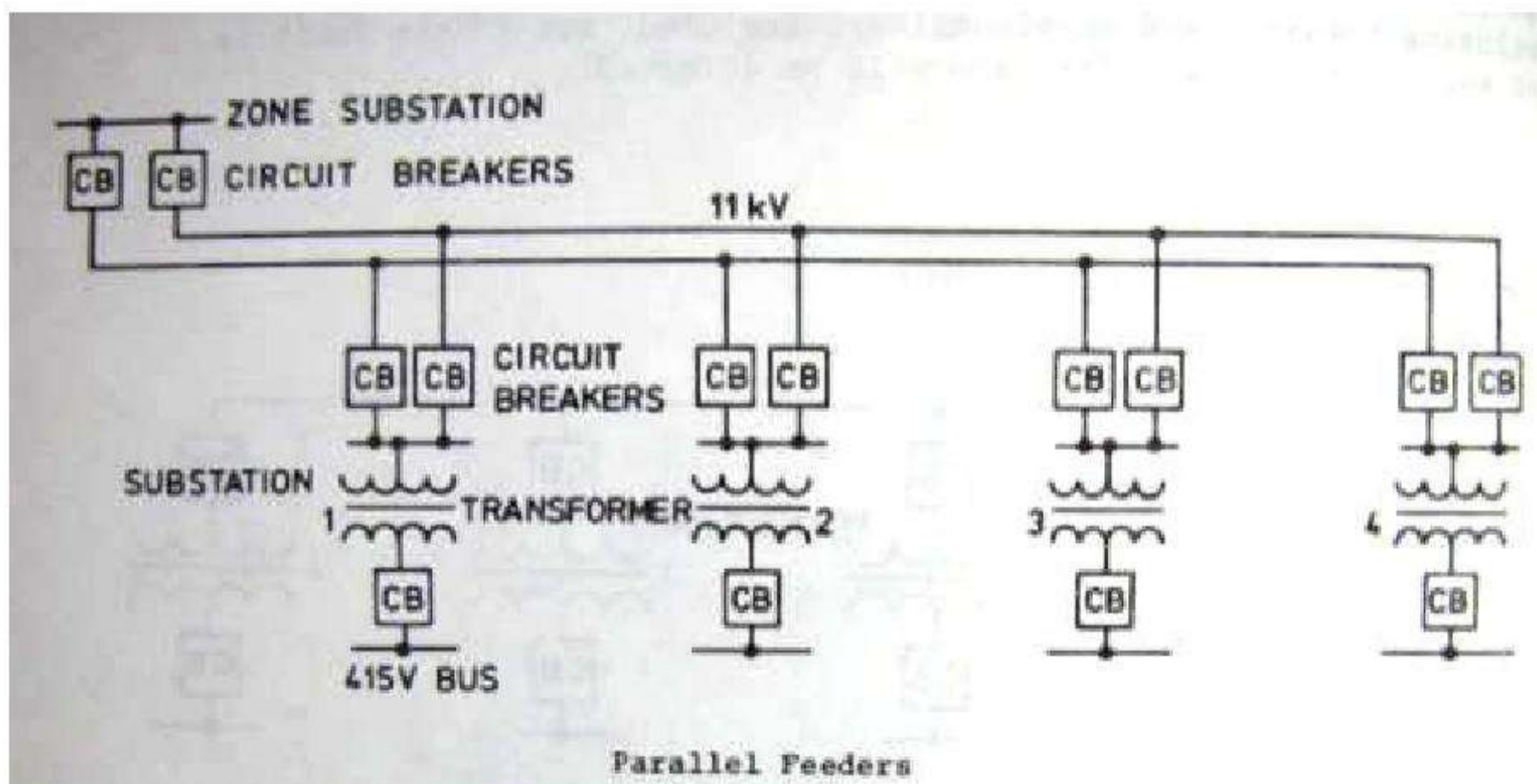

Section 1 – Distribution System

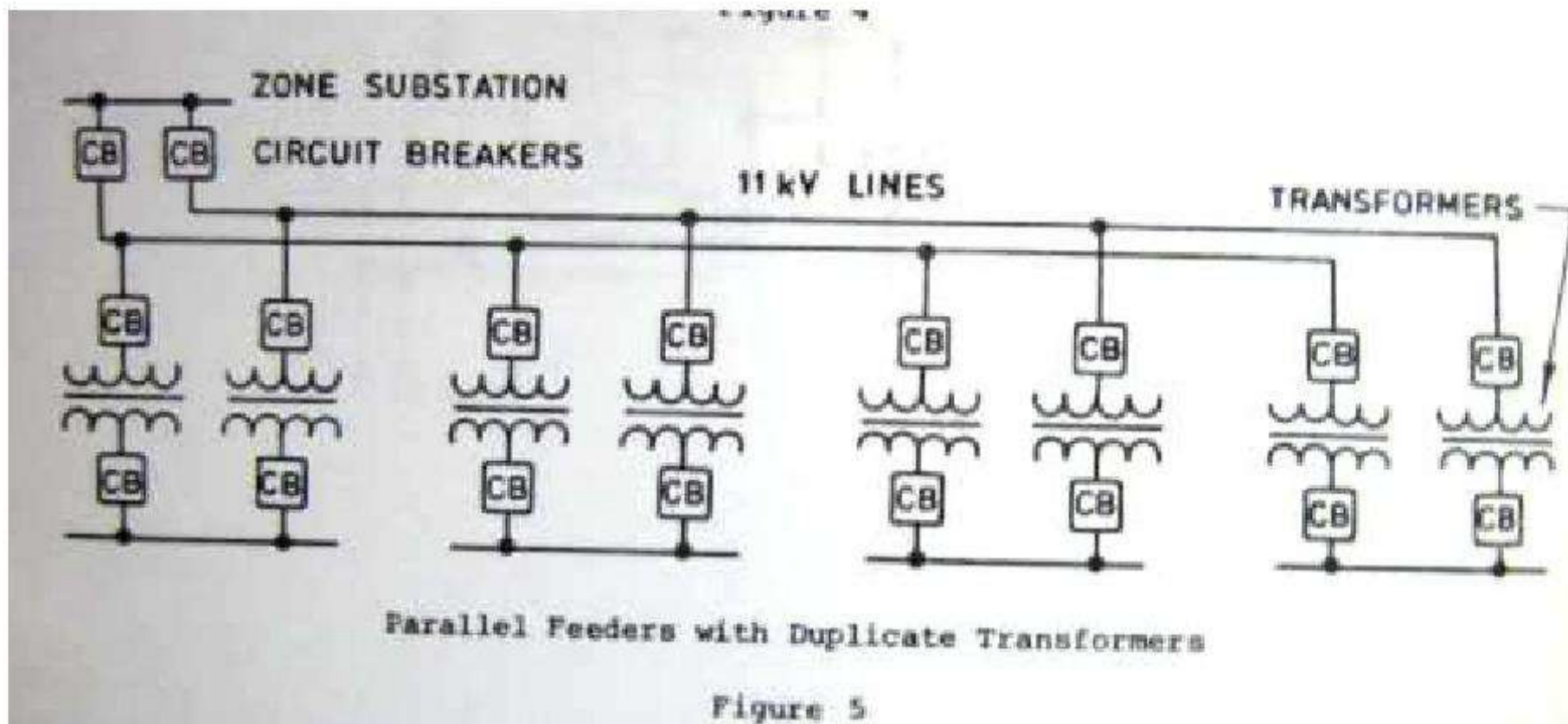

Ring Main Feeders

Feeders are usually taken by different routes and the system gives a firm supply to all distribution centres. The feeders are usually designed to allow supply of the total load from either end of the ring.

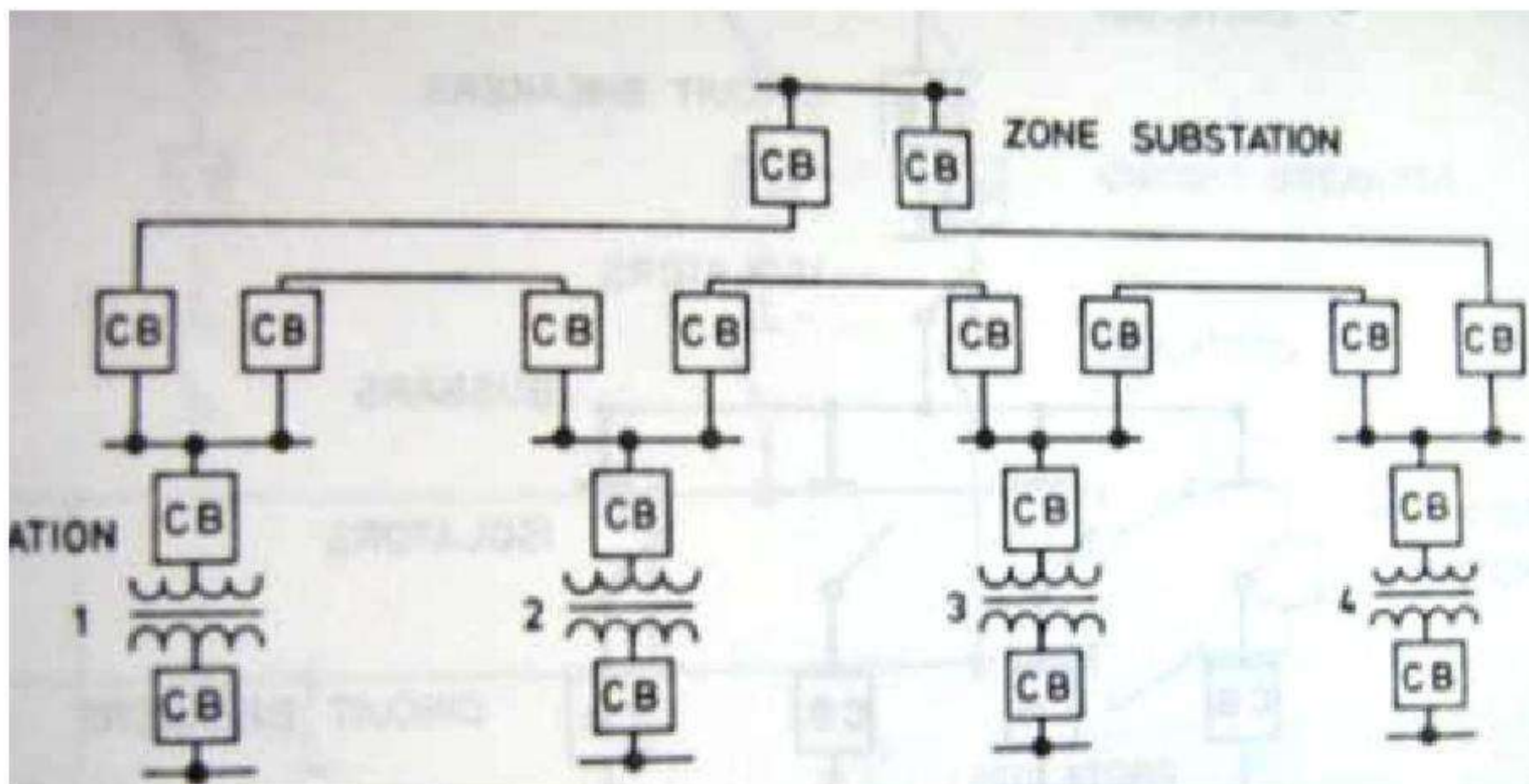

Substation Busbar Arrangements

The form of busbar layout selected for any application must depend on the flexibility of operation required, and the price the user is prepared to pay for this flexibility of operation as regards maintenance and continuity of supply.

Busbar arrangement may be classified as:

- Single busbar systems
- Sectionalised busbar systems
- Ring busbar systems
- Duplicate busbar systems
- Duplicate ring busbar systems

Section 1 – Distribution System

The most common systems are shown below in single line form for three phase systems. It is important in all systems to be able to isolate circuit breakers and transformers so that maintenance can be carried out. Means must be provided for isolators for circuit breakers, and earthing switches for the earthing of high voltage equipment during maintenance.

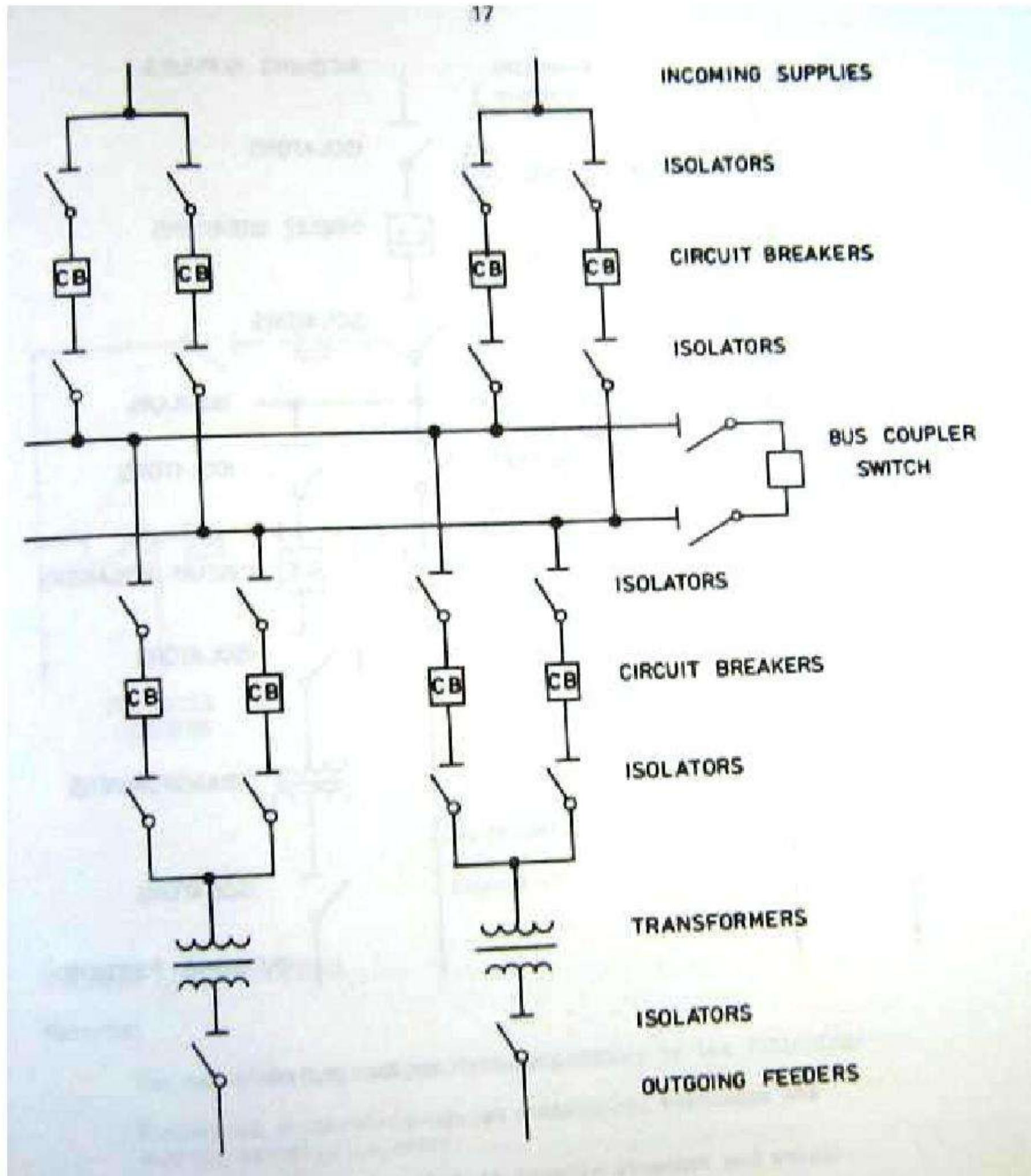

Electrical Power System Considerations

Societies must use energy resources in the form in which they appear, whether as water, wind, oil, coal, or uranium, to accomplish the tasks the societies consider desirable. The desirable tasks may be heating, cooling, lighting, manufacturing, or transportation of people and materials. Finding and converting the raw energy that allows the raw energy resources and the equipment that converts energy to work to be separated by great distances.

Section 1 – Distribution System

Electricity does exist in nature as lightning and static electricity, but it cannot be controlled well enough to be put to practical use. Thus electricity must be generated by converting another raw energy resource. Electricity can be stored in batteries, but only in relatively small quantities. Therefore, at least for the present time, electricity must be produced at the same time it is used.

Reserve, diversity, and economical dispatch

Reserve is that portion of an electric utility's available generating capacity that is not producing electricity at a given time. *Spinning reserve* is the generating capacity that is being driven at the proper speed to provide proper voltage, but is not producing power. Spinning reserve can provide power to the system almost instantaneously if the system load is increased or a generator must be taken out of service. The FERC established a requirement that each electric power company construct sufficient excess capacity that it can supply its largest normal load with its largest generating plant off line. This rule has been modified for some circumstances, as will be discussed later. Spinning reserve should be sufficient to meet any sudden load changes anticipated by the utility.

Diversity is the term used to refer to load changes during a period of time. Load varies during the day because people get up, go to work, and return in the evening using different amounts of electricity to support their various activities. Similarly, industrial and commercial power use will vary during the day. There are also weekly and seasonal variations in electricity usage. In warm climate such as that along the Gulf Coast air conditioning results in high electricity consumption in the summers that peaks daily in the late afternoon. Figure 1.2 shows a 24 hour diversity curve for electric power consumption. The result of diversity is that the electric utility must supply varying amounts of power depending on the time of day, day of the week, and season.

Industrial Heating

Industrial heating may include large space heaters, ovens (baking, heat treating, enamelling, etc), furnaces (steel, brass, etc.), welders and high frequency heating devices. The first two are resistance type loads and operate much as the smaller residential devices, with operation at 120 or 240 V, single phase, and at unity power factor. Ovens, however, may be operated almost continuously for reasons of economy, and some may be three phase units.

Electric Furnaces

Furnaces may draw heavy currents more or less intermittently during part of the heat process and a fairly steady lesser current for the rest; on the whole, the power factor will be fairly high since continuous operation is indicated for economy reasons. The power factor of a furnace load varies with the type of furnace from as low as 60 percent to as high as 95 percent; with the greater number about 75 or 80 percent. Sizes of furnaces vary widely; smaller units with a rating of several hundred kilowatts, are usually three phase. Voltage regulation, while not critical, should be fairly close because of its possible effect on material in the furnace.

Section 1 – Distribution System

Electronic Loads

The electronic load category includes radio, television, x-rays, laser equipment, computers, digital time and timing devices, rectifiers, oscillators for high frequency current production, and many other electronically operated devices such as transistors semiconductors, etc. Practically all of these devices operate at voltages lower than the commercial power sources and employ transformers or other devices to obtain their specific voltages of operation. They are all affected by voltage variations.

Power Factor

The ratio of power (in watts) to the product of the voltage and current (in volt amperes) is called the power factor. It is a measure of the relation between current and voltage out of phase with each other brought about by reactance in the circuit (including the device served). Since facilities must be designed to carry the current and provide for losses which vary as the square of the current, it is necessary that current values be known. The power factor enables loads and losses designated in watts to be converted to amperes. Transformer sizes, wire and cable sizes, fuses, switch ratings, etc., are all based on values of current they must carry safely and economically.

Consumer Classification

As aids in planing, consumers may be conveniently classified into certain categories and certain ranges of load densities expressed in kVA per square mile (where this unit is too broad to be useful, watts per square foot for specific occupancies may be used).

Consumer Factors

It is obvious that an individual consumer is not apt to be using all of the electrical devices that constitute his or her "connected load" at the same time, or to their full capacity. It would evidently be unnecessary to provide facilities to serve such a total possible load, and much more economical to provide only for a probable load, the load creating the demand on the distribution facilities.

Maximum Demand

The actual load in use by a consumer creates a demand for electric energy that varies from hour to hour over a period of time but reaches its greatest value at some point. This may be called the consumer's instantaneous maximum demand in practice, however, the maximum demand is taken as that which is sustained over a more definite period of time, usually 15, 30, or 60 min. These are referred to as 15-, 30-, or 60-min integrated demands, respectively.

Diversity Factor

The diversity factor is the ratio of the sum of maximum demands of each of the component loads to the maximum demand of the load as a whole (or the coincident maximum demand). For example, each of the loads mentioned above may have a

Section 1 – Distribution System

maximum demand of 100 kW, while the coincident maximum demand on the system supplying the three may be only 150 kW. The diversity factor is then 300 (100 + 100 + 100) divided by 150, or 2, or 200 percent. Such diversity exists between consumers, between transformers, and between feeders, substations, etc. Note that the *demand factor* is defined so that it is always less than 1 or 100 percent, while the *diversity factor* is the reciprocal of the demand factor and is always greater than 1 or 100 percent. This is a most important factor in the economical planning and design of distribution facilities.

Coincidence Factor

The coincidence factor is the ratio of the maximum coincident total demand of a group of consumers to the sum of the maximum demands of each of the consumers.

Utilisation Factor

The ratio of the maximum demand of a system to the rated capacity of the system is known as the utilisation factor. Both the maximum demand and the rated capacity are expressed in the same units. The factor indicates the degree to which a system is being loaded during the load peak with respect to its capacity. The rated capacity of a system is usually determined by its thermal capacity, but may also be determined by voltage drop limitations, the smaller of the two determining the capacity.

Section 1 – Distribution System

Review questions for Section 1

1 State **three** classifications of distribution system.

-
-
-

2 State the standard voltages for three phase distribution systems.

3 Sketch and describe a single wire earth return (SWER) system.

4 Sketch the three types of feeders that are commonly used for distribution system.
Describe the merit of each type.

5 Sketch the following busbar arrangements:

- Single busbar
- Sectionalise busbar
- Ring busbar
- Duplicated busbar

Section 2 – Overhead Lines and Installation

2.1 Identify relevant components use in over head line design

Conductor Supports

The types of supports for overhead conductors can be listed as follows;

- Wood poles
- Steel poles
- Concrete poles
- Steel Towers

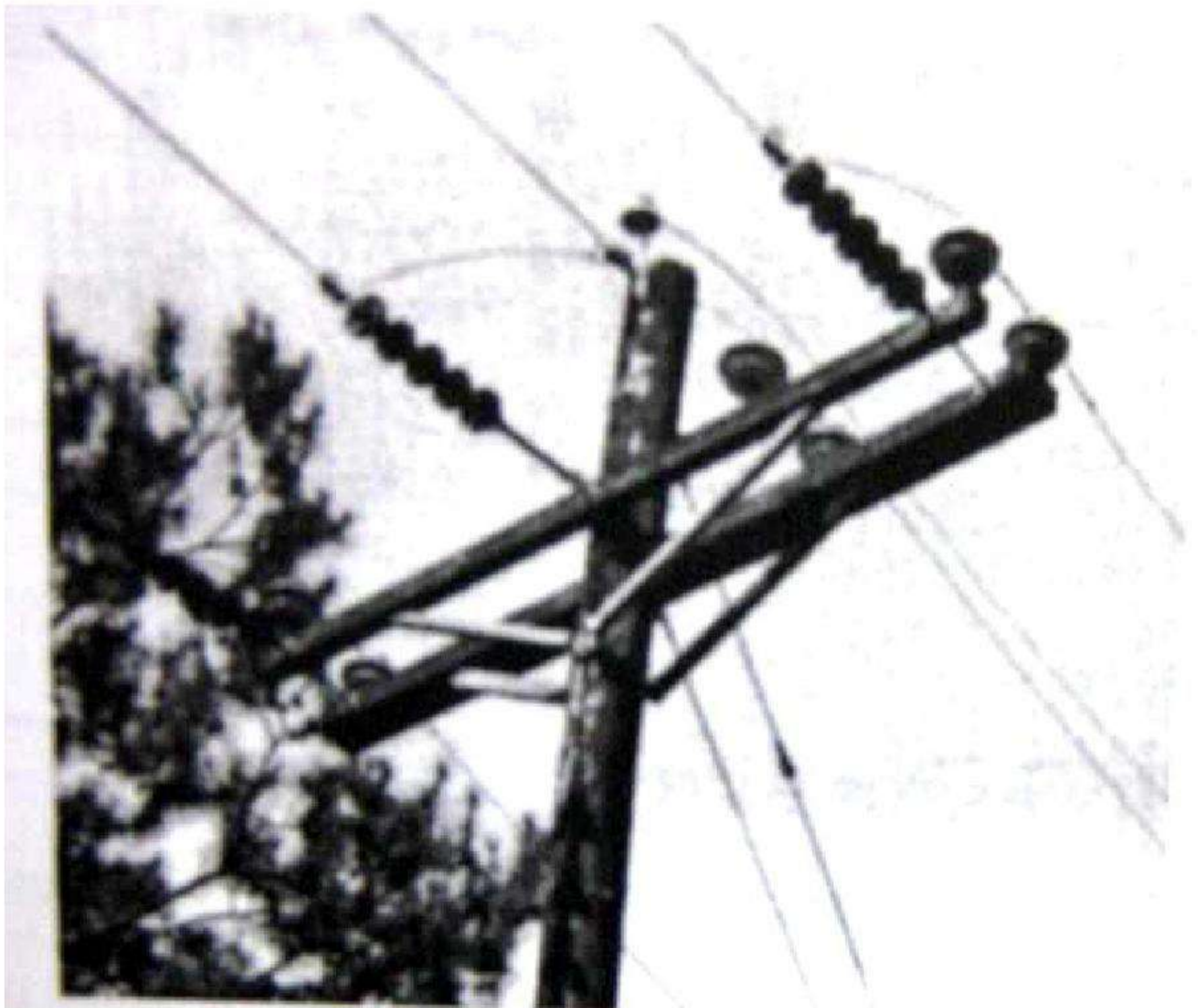

Section 2 – Overhead Lines and Installation

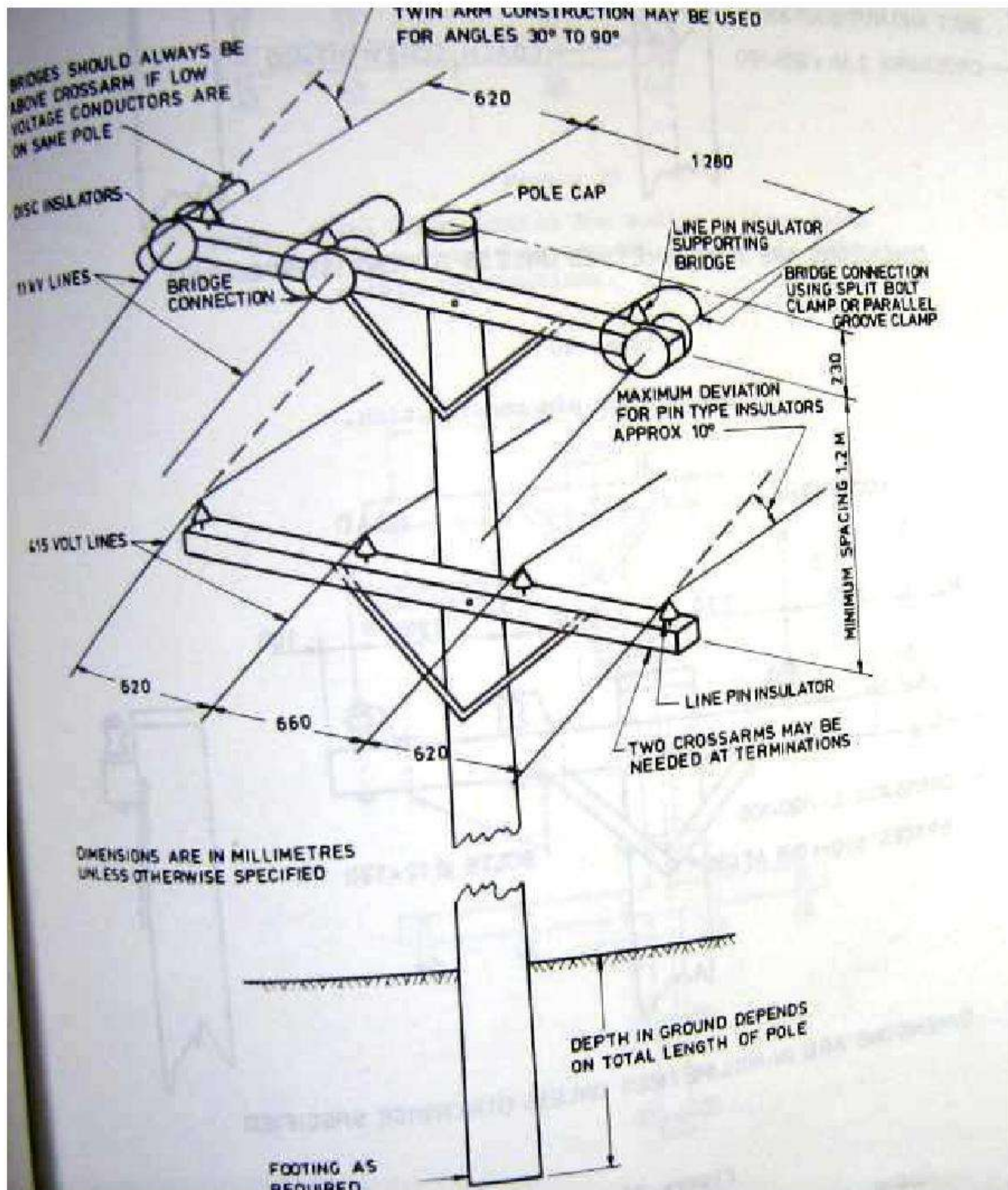

Section 2 – Overhead Lines and Installation

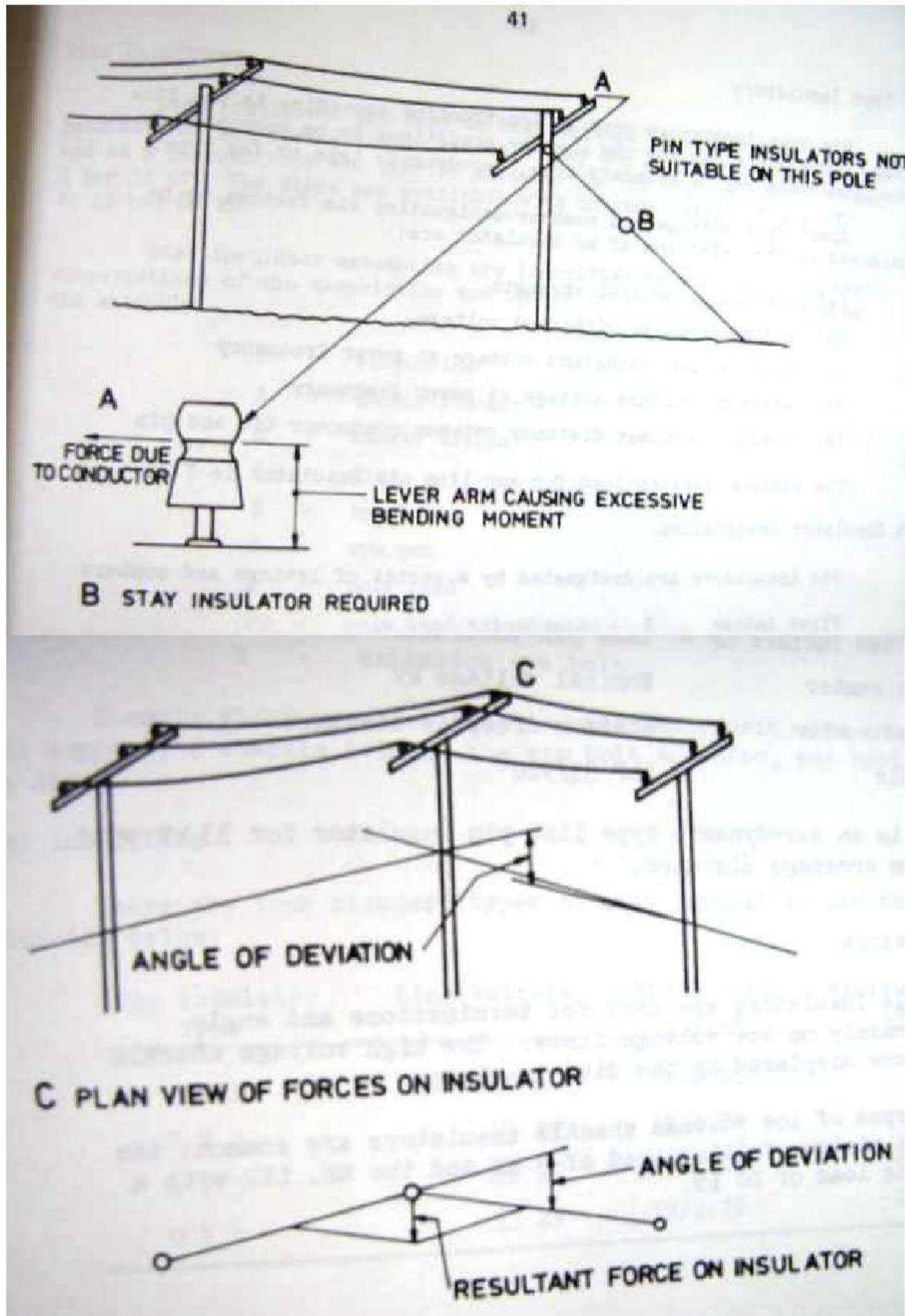

Section 2 – Overhead Lines and Installation

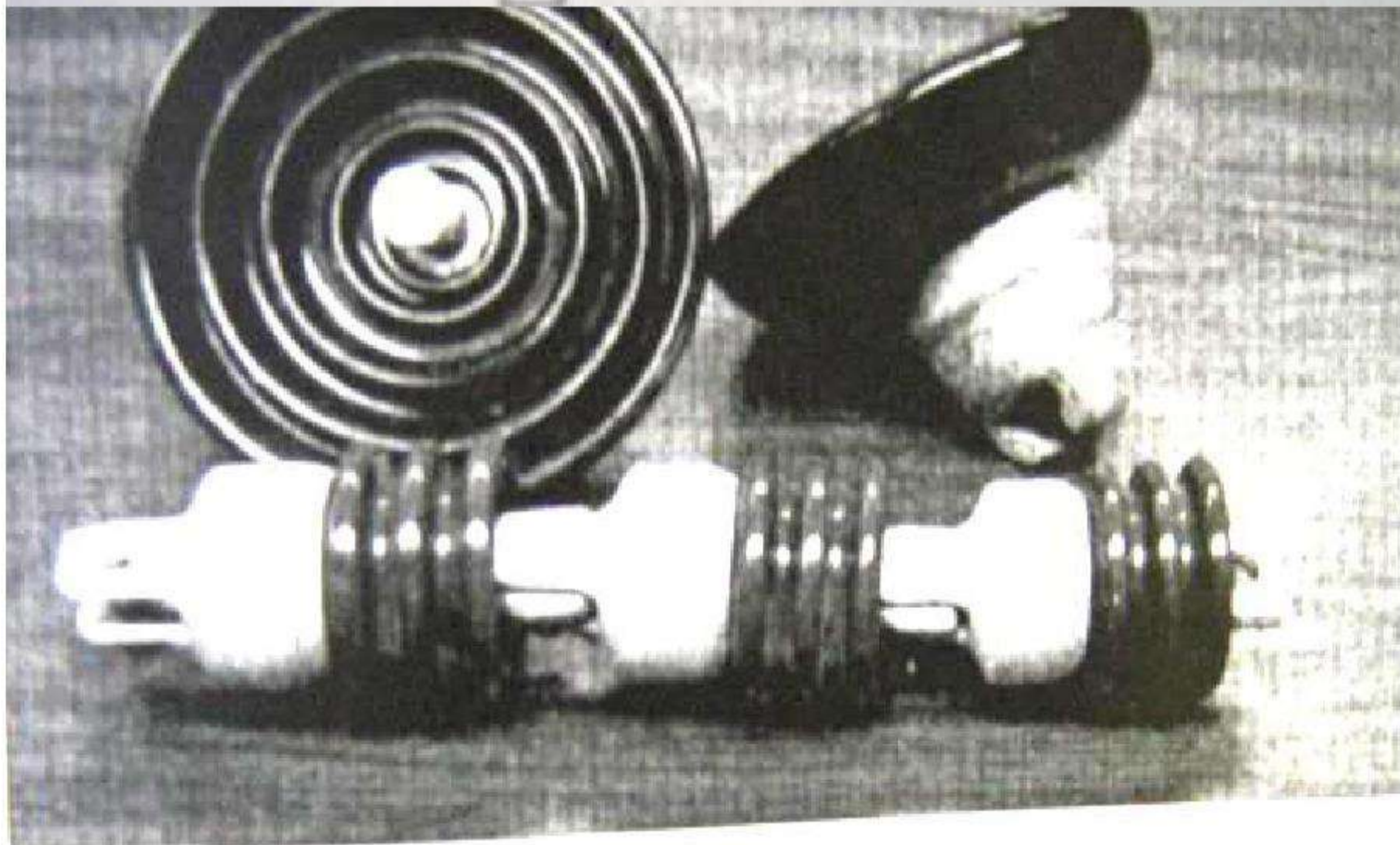
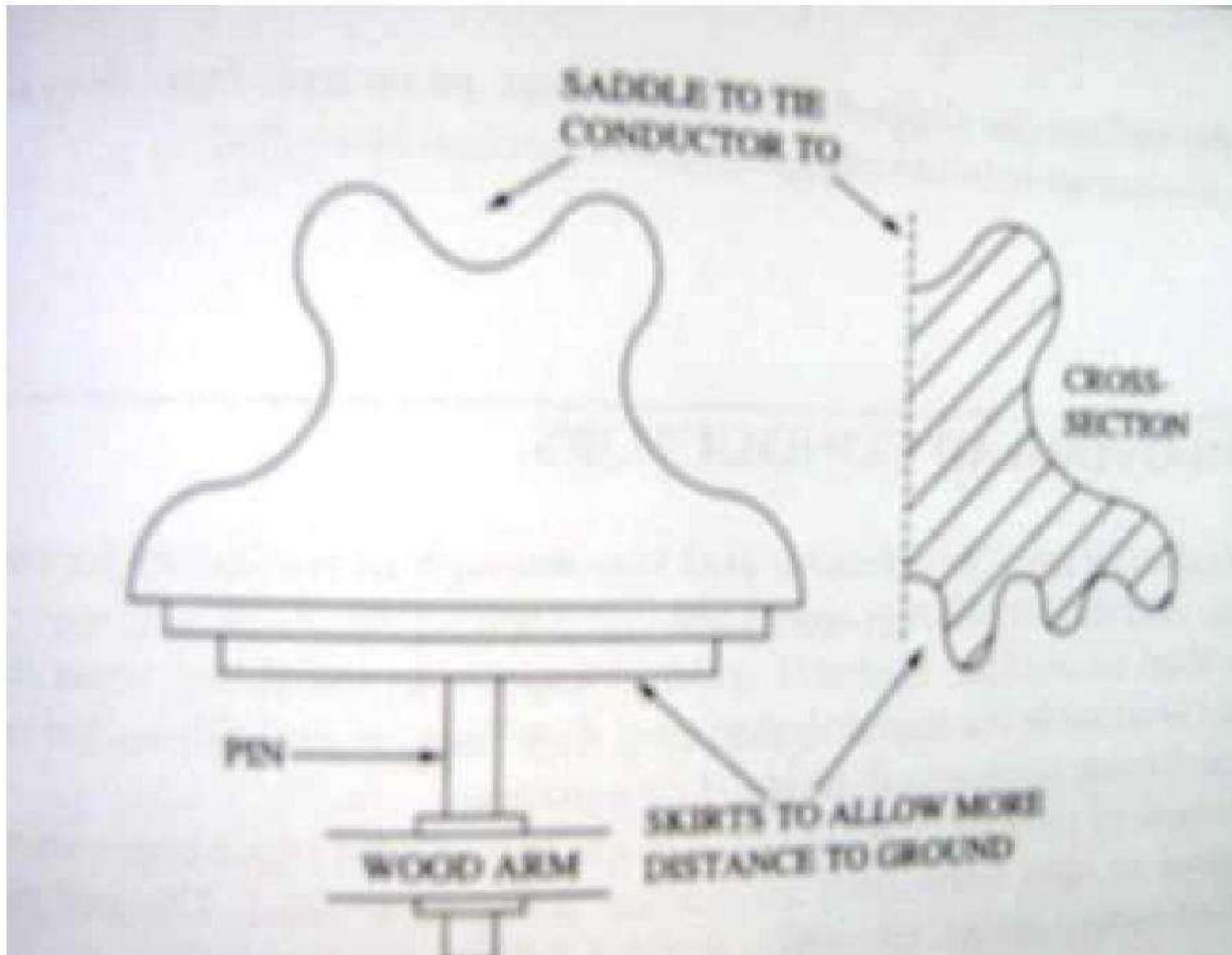

www.enr.com

Section 2 – Overhead Lines and Installation

Arcing Horns

In the case of insulator flashover due to lightning, the porcelain is often cracked or broken by the power arc that follows the initial discharge.

To protect against this trouble arcing horns or rings are installed on many overhead systems. These operate so that the arc is taken up by the electrodes and held at sufficient distance from the porcelain to prevent damage by the heat of the arc.

The advantage of the ring design lies in the front that the arc can form at any point around the insulator, and in case of formation at the windward side it may be blown around without damage to the insulator. With horns, the arc may be blown under the insulator and damage it.

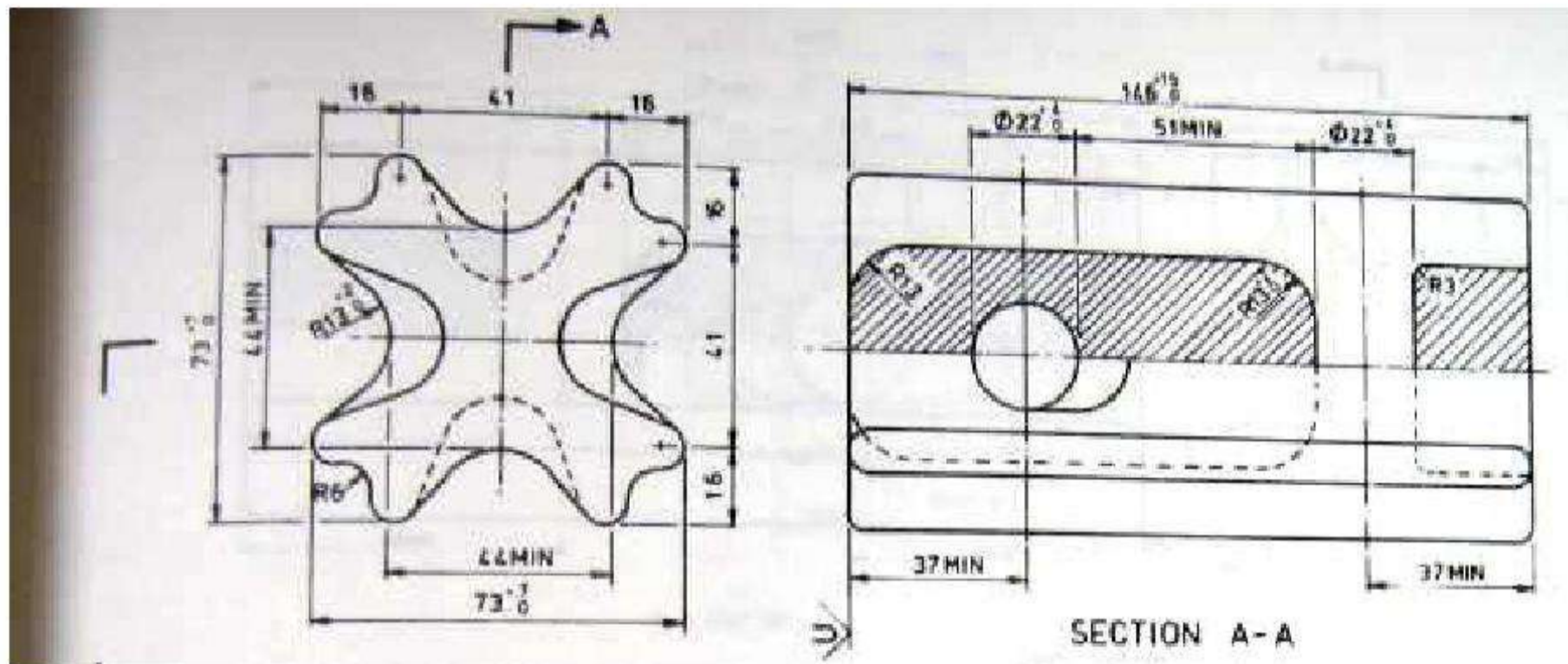

Insulator Ties

These consist of a number of helically formed rods, the central portions of which are shaped to provide attachment of the conductor to a line pin insulator.

Some illustrations of insulator ties, line reinforcement at disc insulators, and armour rods are shown in Figures.

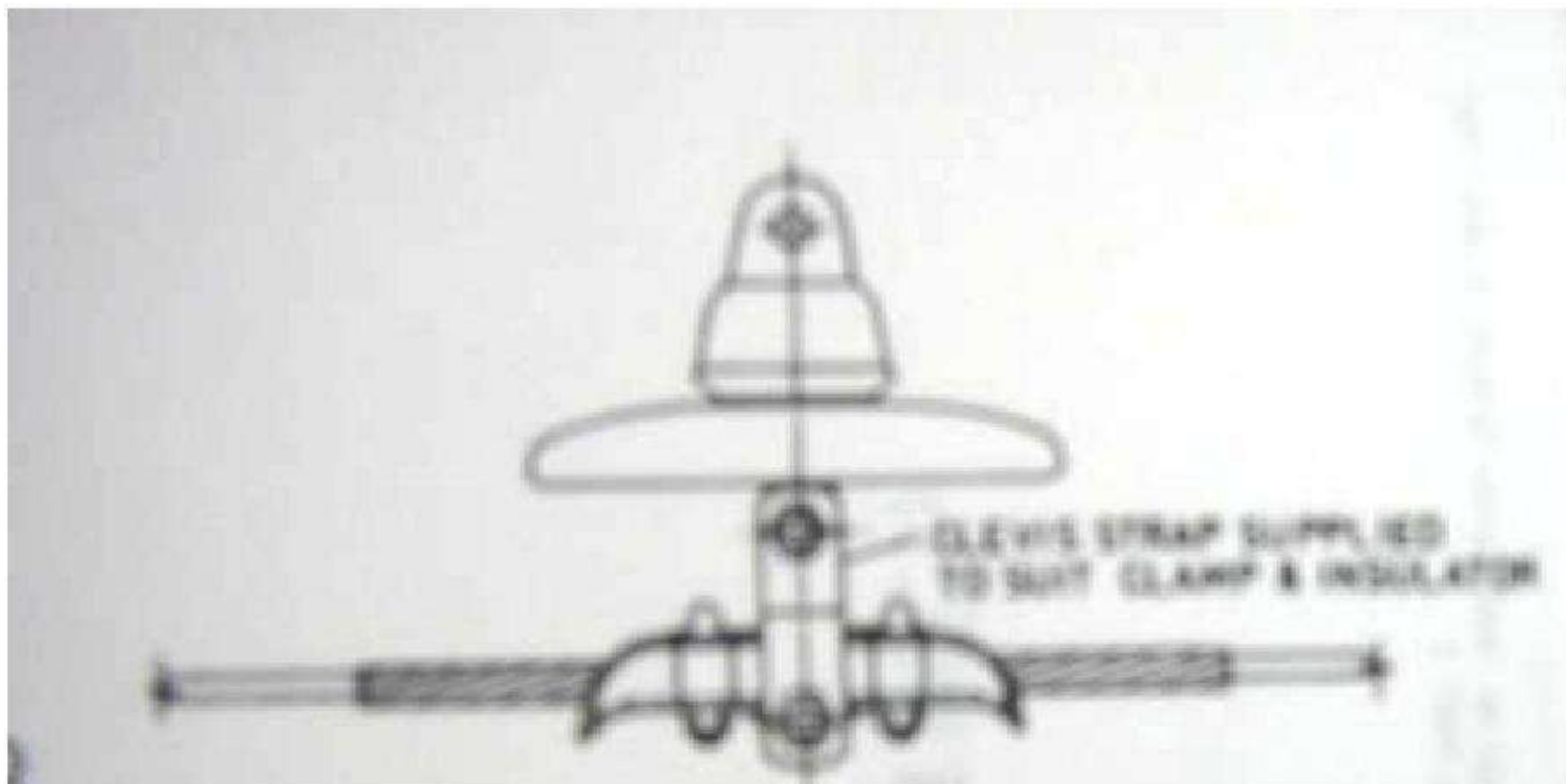

Section 2 – Overhead Lines and Installation



2.2 Outline relevant factors related to installation, maintenance, cross arms, stays, pole types and choice of conductors sizes for commonly used configuration

Limiting Size of Aerial Conductors

Both the SAA Wiring Rules and the Overhead Line Construction and Maintenance Regulations impose limits on the smallest size of conductor that can be used for aerial conductors.

The SAA Wiring Rules state that the minimum size of conductors and the maximum length of spans for various conductors are as follows:

Rule 3.13.2 Every conductor installed as an aerial conductor shall have not less than seven strands and shall not be smaller than 4 mm^2 copper or 16 mm^2 aluminium.

Rule 3.13.19 The length of span of copper aerial conductors shall not exceed the values given below

Type of Conductor	Size mm^2	Maximum Span Metres
Bare hard drawn	4	25
Conductors	6	30
	16 or over	60

Section 2 – Overhead Lines and Installation

Regulation 28.(1)

The ultimate tensile strength of an aerial conductor operating at a voltage of 650 volts or less shall not be less than 3000 N.

This makes the smallest size:

Copper	7/1.25	at	3610 N	Ultimate Strength
All Aluminium	7/1.75	at	3010 N	Ultimate Strength
Aluminium Alloy	7/1.75	at	4710 N	Ultimate Strength

Regulation 28.(2)

The ultimate tensile strength of an aerial conductor operating at a voltage of 650 volts or less shall not be less than 5000 N.

This makes the smallest size:

Copper	7/1.75	at	6890 N	Ultimate Strength
All Aluminium	7/2.50	at	5750 N	Ultimate Strength
Aluminium Alloy	7/2.25	at	7780 N	Ultimate Strength

SAGS

When distribution lines are erected, the sag allowed in a conductor at the time of erection must be such that the maximum tension allowable for the particular conductor is not exceeded under the conditions specified in the regulations.

Four sag conditions are of particular interest.

These are:

- The sag and tension in the conductor at 15°C with a wind loading of 500 Pascals on the projected area of conductors.
- The sag and tension in the conductor under conditions of no wind, at an ambient temperature of 5°C
- The sag at 50°C which determines the support height to maintain the statutory clearance above the ground.
- The sag of erection which will ensure that the above conditions are fulfilled.

On short spans condition (a) is usually the determining factor while the longer spans, particularly for aluminium conductors fitted with armour rods, condition (b) is the determining factor.

Section 2 – Overhead Lines and Installation

SAG Calculations

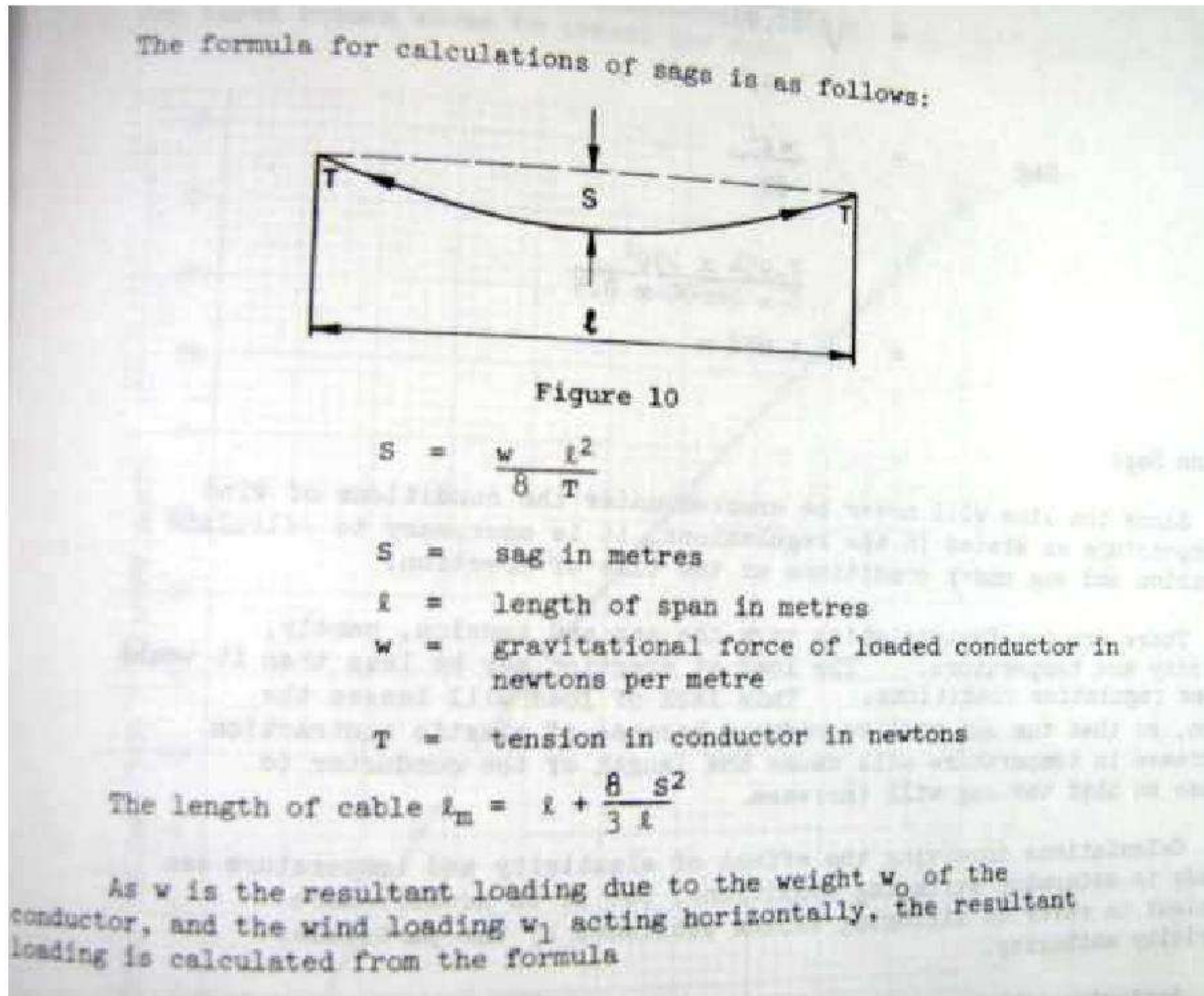

Calculate the allowable sag for a 7/3.50 hard drawn copper overhead conductor with a span of 150 metres. The wind loading is 500 Pascals and the maximum conductor tension is to be 50 per cent of the ultimate tensile strength.

Table 1

Ultimate tensile strength	=	26600 N
Gravitational Force	=	5.949 N/m
Diameter of conductor	=	10.5 mm
Wind loading per metre	=	Diameter in metres x wind loading in Pascals
	=	$10.5 \times 10^{-3} \times 500$
	=	5.25 Pa

Combined load due to wind and weight of conductor

$$\begin{aligned}
 W &= \sqrt{w_0^2 + w_1^2} \\
 &= \sqrt{5.949^2 + 5.25^2} \\
 &= \sqrt{62.95} \\
 &= 7.934 \text{ N/m}
 \end{aligned}$$

Section 2 – Overhead Lines and Installation

$$\begin{aligned} &= \frac{wl^2}{8T} \\ &= \frac{7.934 \times 150^2}{8 \times 26600 \times 0.5} \\ &= 1.678\text{m} \end{aligned}$$

Erection Sags

Since the line will never be erected under the conditions of wind and temperature as stated in the regulations, it is necessary to calculate the tension and sag under conditions at the time of erection.

There are two factors which vary the sag and tension, namely, elasticity and temperature. The load at erection may be less than it would be under regulated conditions. This lack of load will lessen the tension, so that the sag will be reduced because of elastic contraction. An increase in temperature will cause the length of the conductor to increase so that the sag will increase.

Sag Measurement

Sags may be measured by the following methods:

1. Sight Boards

The sight boards are fixed to two poles of the span at the appropriate height for the desired sag. The conductor is then pulled up to line with a sight taken between the two boards.

2. Wave Timing

For this method the conductor is struck at one end of the span and the time taken for the wave to travel the span six times is measured. The sag is then calculated from the formula

$$t = \sqrt{\frac{\text{Sag in metres}}{0.03408}}$$

$$t = \text{time in seconds for 3 return waves}$$

Sometimes the approximate formula is used

$$t = 5.42 \times \sqrt{\text{Sag in metres}}$$

Section 2 – Overhead Lines and Installation

Figure 11 illustrates the relationship between sag, and the time for three return waves to travel the span.

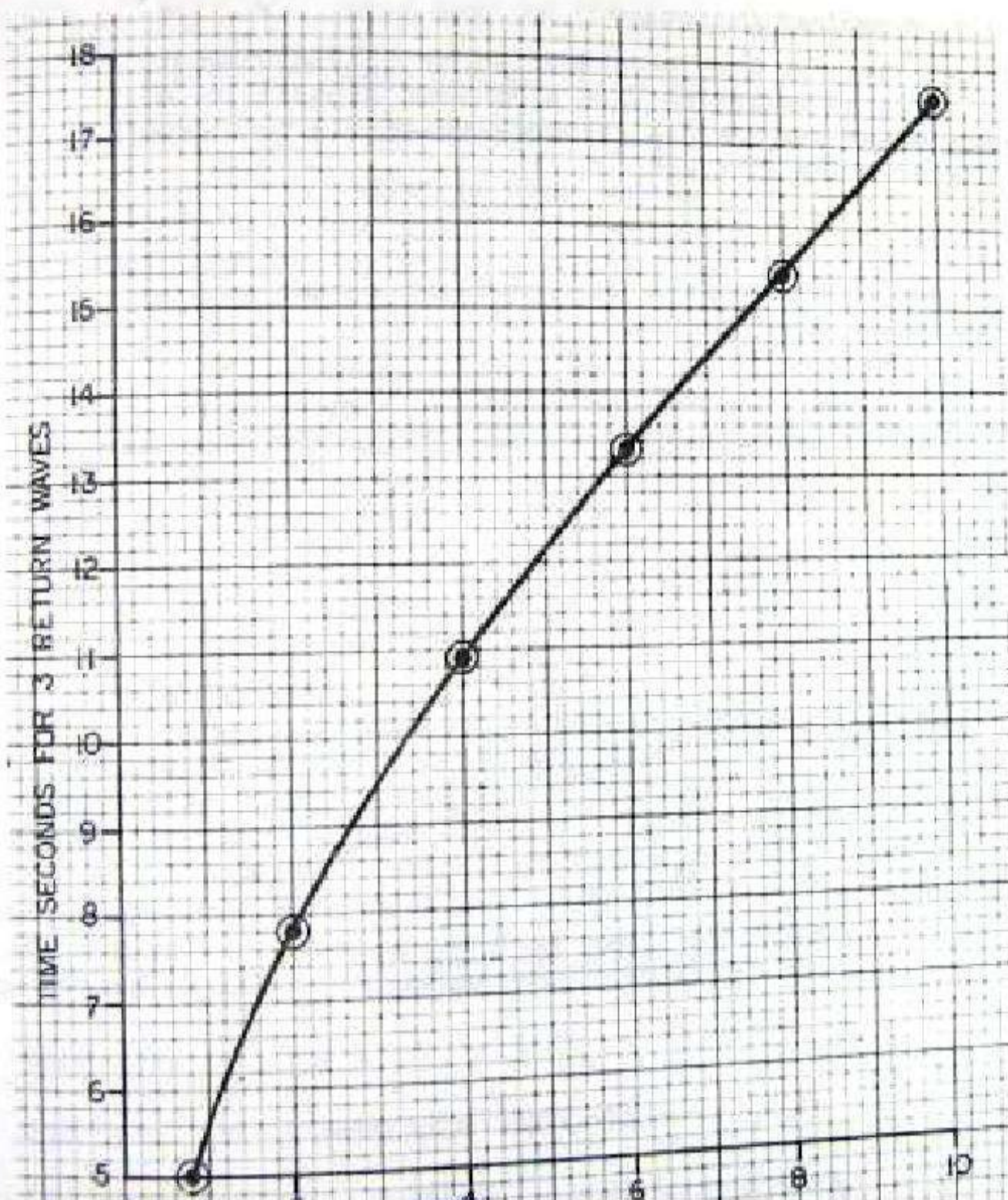

Wave Timing Chart
Based on Formula

$$\text{Time (seconds) for 3 Return Waves} = \sqrt{\frac{\text{Sag in metres}}{0.03408}}$$

Figure 11

3. Optical Range Finders

Optical range finders are available for measuring the height of the conductor at the pole and the height of the conductor at mid span, while standing on the ground. From these readings the sag can be obtained from the difference, provided allowance can be made for any variations in ground level.

Section 2 – Overhead Lines and Installation

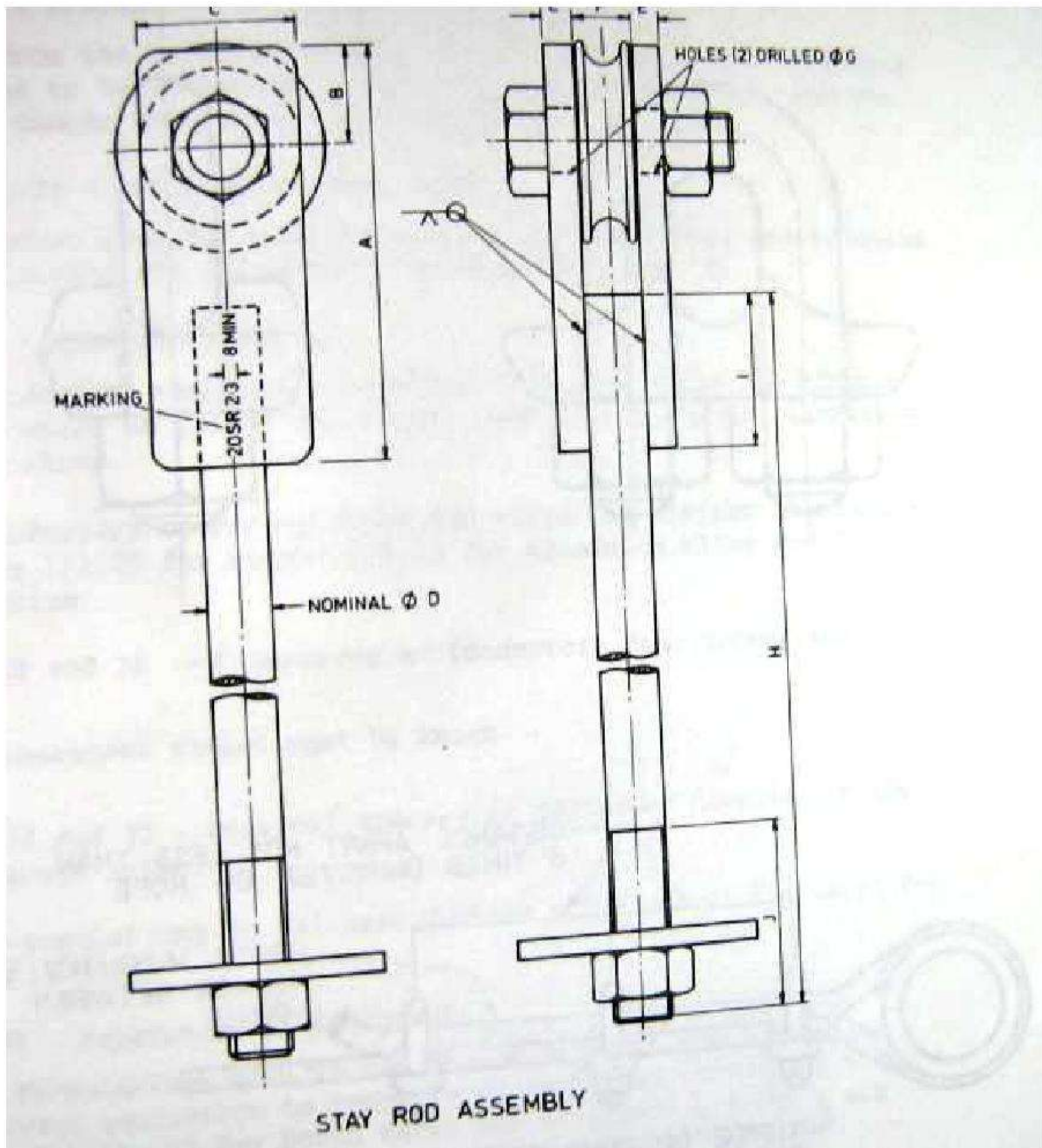

Section 2 – Overhead Lines and Installation

From Table 1 – Open Supply Lines

	Voltage		
	0 to 750	750 to 15,000	15,000 to 50, 000
	Required clearance over specified items		
Railroad Tracks	27	28'	30
Public streets, alleys or roads	18	20	22
Driveways to residential garages	10	20	22
Areas accessible to pedestrians only	10	15	17
Parallel to streets	18	20	22
Parallel to rural roads	15	18	20

From Table 4 – Clearance of supply lines from buildings

Voltage of supply conductors	Horizontal clearance	Vertical clearance
300 to 8,700	3	8
8,700 to 15,000	8	8
15,000 to 50,000	10	10

From Table 8 – Separation in inches required for line conductors #2 AWG or larger versus span sag

Voltage between conductor	Span sag in inches				
	36	48	72	96	120
2,400	14.5	16.5	20.5	23.5	26.0
7,200	16.0	18.0	22.0	25.0	27.5
13,200	18.0	20.0	23.5	26.5	29.5
34,500	24.0	26.5	30.0	33.0	35.5
69,000	36.6	36.5	40.5	43.5	46.0

Section 2 – Overhead Lines and Installation

Wood Poles

The simplest and cheapest support structures are wood poles. These were the first extensively used electrical conductor support structures. Wood poles have been made from larch, spruce, cedar pine, and fir trees, selected for height and straightness. The most commonly used trees for poles are Southern Yellow Pine (SYP) about 70%, and Douglas Fir, about 25%. All of the others comprise only about 5% of the wood poles used. Poles from 25 to 65 feet are generally SYP while poles over 65 feet are generally Douglas Fir. Wood poles are available in heights from 25 to 130 feet (or more on special order) in 5 foot increments.

Wood pole heights and strengths have been codified from tests, and tables prepared to make distribution design easier. A reliable average for maximum longitudinal fibre stress in both pine and fir is 8000 psi. That is the psi at which the wood fibres will start to split or slide past each other. So all design strengths have been calculated from this value. As force is gradually increased, a pole will fail first by splitting along the pole and then by breaking.

Poles are designated by strength and degree of straightness as class 1 (best through 5 (worst). Larger poles have their own classification as extra heavy duty classes 0,00,000, and 0000, with more zeros being heavier duty. The zeros are usually written as H1, H2, H3, H4.

AAC (All Aluminium Conductor)

All aluminium conductor is available in 7, 19, 37, 61, and 91 strands of #1350 aluminium wire. AAC has slightly better conductivity at low voltages than ACSR, but it has less strength and more sag per span length. It is used for lines with short spans. AAC costs about the same as ACSR.

Distribution spans are generally short because the lines are built on public roads, streets, and easements. It is not permissible to serve a building with service drops across streets or across property of another land owner. This means two lot widths is the general span for residential and light commercial and business districts. This is typically between 120 and 200 feet.

Section 2 – Overhead Lines and Installation

TABLE 9.1 Electrical characteristics of bare aluminum conductors steel-reinforced (ACSR)*

Code Word	Aluminum area, cmil	Stranding Al/St	Layers of aluminum	Outside diameter, in	Resistance			GMR D_g , ft	Reactance per conductor 1-ft spacing, 60 Hz	
					D_c , 20°C, $\Omega/1,000$ ft	Ac, 60 Hz			Inductive X_L , Ω/mi	Capacitive X_C , MI/mi
						20°C, Ω/mi	50°C, Ω/mi			
Waxwing	266,800	18/1	2	0.609	0.0646	0.3488	0.3831	0.0198	0.476	0.1090
Partridge	266,800	26/7	2	0.642	0.0640	0.3452	0.3792	0.0217	0.465	0.1074
Ostrich	300,000	26/7	2	0.680	0.0569	0.3070	0.3372	0.0229	0.458	0.1057
Merlin	336,400	18/1	2	0.684	0.0512	0.2767	0.3037	0.0222	0.462	0.1055
Linnet	336,400	26/7	2	0.721	0.0507	0.2737	0.3006	0.0243	0.451	0.1040
Oriole	336,400	30/7	2	0.741	0.0504	0.2719	0.2987	0.0255	0.445	0.1032
Chickadee	397,500	18/1	2	0.743	0.0433	0.2342	0.2572	0.0241	0.452	0.1031
Ibis	387,500	26/7	2	0.783	0.0430	0.2323	0.2551	0.0264	0.441	0.1015
Pelican	477,000	18/1	2	0.814	0.0361	0.1957	0.2148	0.0264	0.441	0.1004
Flicker	477,000	24/7	2	0.846	0.0359	0.1943	0.2134	0.0284	0.432	0.0992
Hawk	477,000	26/7	2	0.858	0.0357	0.1931	0.2120	0.0289	0.430	0.0988
Hen	477,000	30/7	2	0.883	0.0355	0.1919	0.2107	0.0304	0.424	0.0980
Osprey	556,500	18/1	2	0.879	0.0309	0.1679	0.1843	0.0284	0.432	0.0981
Parakeet	556,500	24/7	2	0.914	0.0308	0.1669	0.1832	0.0306	0.423	0.0969
Dove	556,500	26/7	2	0.927	0.0307	0.1663	0.1826	0.0314	0.420	0.0965
Rook	636,000	24/7	2	0.977	0.0269	0.1461	0.1603	0.0327	0.415	0.0950
Grosbeak	636,000	26/7	2	0.990	0.0268	0.1454	0.1596	0.0335	0.412	0.0946
Drake	795,000	26/7	2	1.108	0.0215	0.1172	0.1284	0.0373	0.399	0.0912
Tern	795,000	45/7	3	1.063	0.0217	0.1188	0.1302	0.0352	0.406	0.0925
Rail	954,000	45/7	3	1.165	0.0181	0.0997	0.1092	0.0386	0.395	0.0897
Cardinal	954,000	54/7	3	1.196	0.0180	0.0988	0.1082	0.0402	0.390	0.0890
Ortolan	1,033,500	45/7	3	1.213	0.0167	0.0924	0.1011	0.0402	0.390	0.0885
Bluejay	1,113,000	45/7	3	1.259	0.0155	0.0861	0.0941	0.0415	0.386	0.0874
Finch	1,113,000	54/19	3	1.293	0.0155	0.0856	0.0937	0.0436	0.380	0.0866
Bittern	1,272,000	45/7	3	1.345	0.0136	0.0762	0.0832	0.0444	0.378	0.0855
Pheasant	1,272,000	54/19	3	1.382	0.0135	0.0751	0.0821	0.0466	0.372	0.0847
Bobolink	1,431,000	45/7	3	1.427	0.0121	0.0684	0.0746	0.0470	0.371	0.0837
Plover	1,431,000	54/19	3	1.465	0.0120	0.0673	0.0735	0.0494	0.365	0.0829
Lapwing	1,590,000	45/7	3	1.502	0.0109	0.0623	0.0678	0.0498	0.364	0.0822
Falcon	1,590,000	54/19	3	1.545	0.0108	0.0612	0.0667	0.0523	0.358	0.0814
Bluebird	2,156,000	84/19	4	1.762	0.0080	0.0476	0.0515	0.0586	0.344	0.0776

*Most used multilayer sizes.

Section 2 – Overhead Lines and Installation

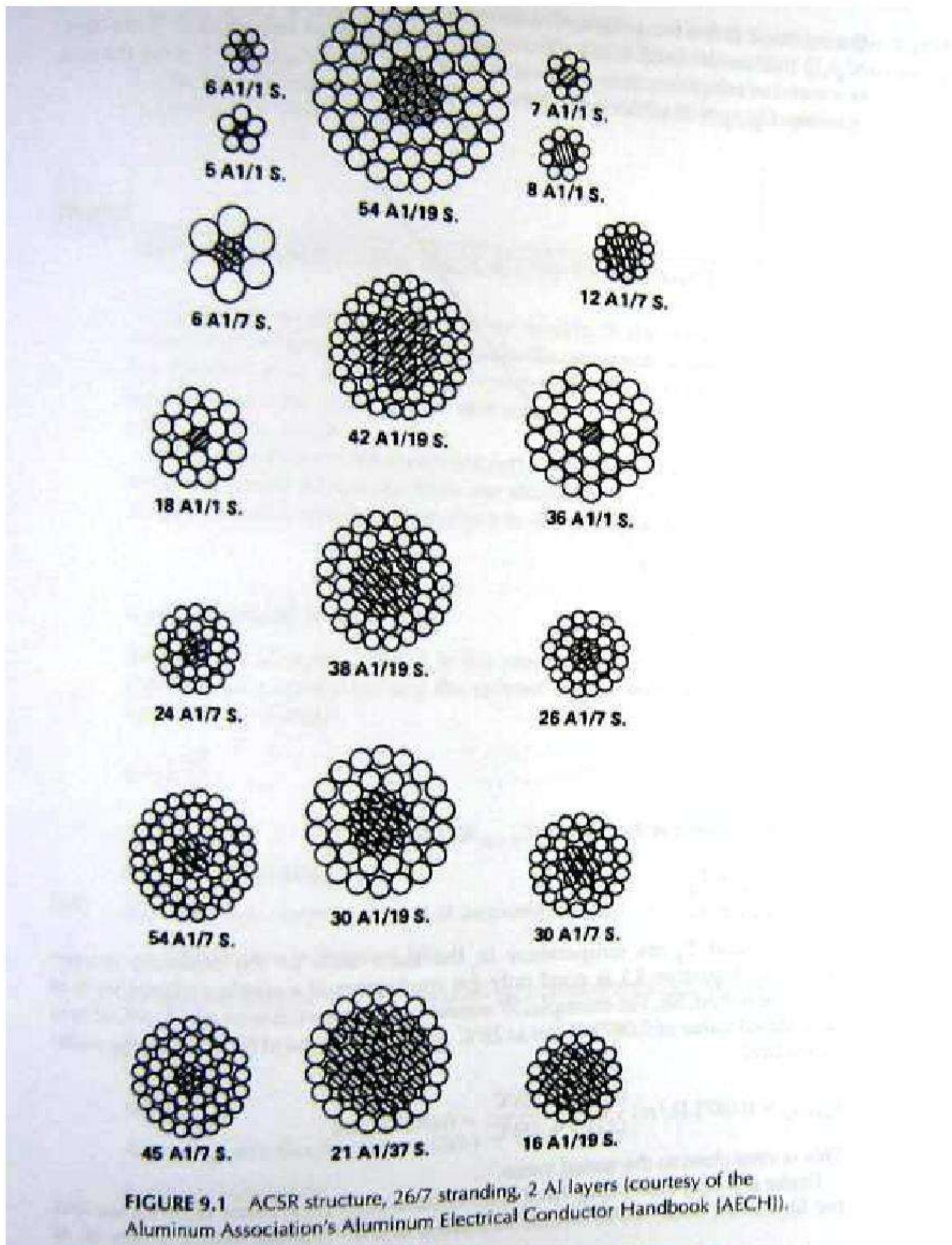

Section 2 – Overhead Lines and Installation

2.3 Determine mechanical limitations and physical dimensions of lines – Part 1

Overhead Line Conductors

Material

The material for conductors is determined by the following:

- Electrical properties such as resistance, reactance and current carrying capacity.
- Mechanical properties such as tensile strength and weight.
- Price of the material in relation to the return in the investment.

The following range of materials is suitable for overhead lines.

- Hard drawn copper conductors
- All aluminium conductors (AAC)
- All aluminium alloy conductors (AAAC)
- Aluminium conductors steel reinforced (ACSR)
- Steel conductors galvanised (SC/GZ)
- Steel conductors aluminium clad (SC/AC)
- Cadmium copper

When steel is used as reinforcement or as a conductor or stay it must be protected against corrosion. The standard methods are galvanising or coating with aluminium – aluminium clad. An aluminium conductor, steel reinforced should have some indication of the corrosion prevention method; ACSR/GZ indicates that the steel core is galvanised, whereas an ACSR/AC indicates an aluminised steel core.

Of the above, the aluminium alloy conductors have a financial saving over copper, particularly in suburban work where span lengths are relatively short allowing for lower line tension.

Aluminium conductors require more precautions during erection than copper conductors because they are softer and more easily damaged. Aluminium tape is required at each tie, and joints must be cleaned and greased.

Conductor Current Rating

The current rating of overhead conductors depends upon:

- Heating
- Voltage drop
- Power losses

Section 2 – Overhead Lines and Installation

Heating

The current carrying capacity of an overhead conductor is limited by:

- The annealing temperature of the conductor;
- The expansion due to temperature rise which causes a reduction of statutory clearance.
- A temperature rise which might occasion injury to any insulation.

For installations covered by the SAA Wiring Rules a table of maximum current values is given in the appendix of these rules.

For installations outside the scope of the SAA Wiring Rules the above table is still used as a guide, but various authorities have their own formula for current rating based on the maximum allowable operating temperature.

Reasonably accepted values for the maximum operating temperatures are:

- 75°C for continuous rating
- 100°C for one hour rating

Conditions Affecting Maximum Conductor Temperature

The factors which determine the maximum conductor temperature are:

- The ambient temperature
- Wind velocity
- Heat absorbed from solar radiation
- Heat lost by convection
- Heat lost by radiation

For this course it is not necessary to be able to calculate maximum allowable current ratings on a basis of the above factors as the information is usually available from the Energy Authority of NSW in the form of graphs.

Fault Conditions

Overhead line conductors may be overheated under fault conditions unless satisfactory protection is provided.

The graphs, figures 11 and 12 show the relationship between short circuit current and maximum time duration which this current can be allowed to flow without damage to the conductor.

The calculation of prospective fault currents will be dealt with later in this subject

Section 2 – Overhead Lines and Installation

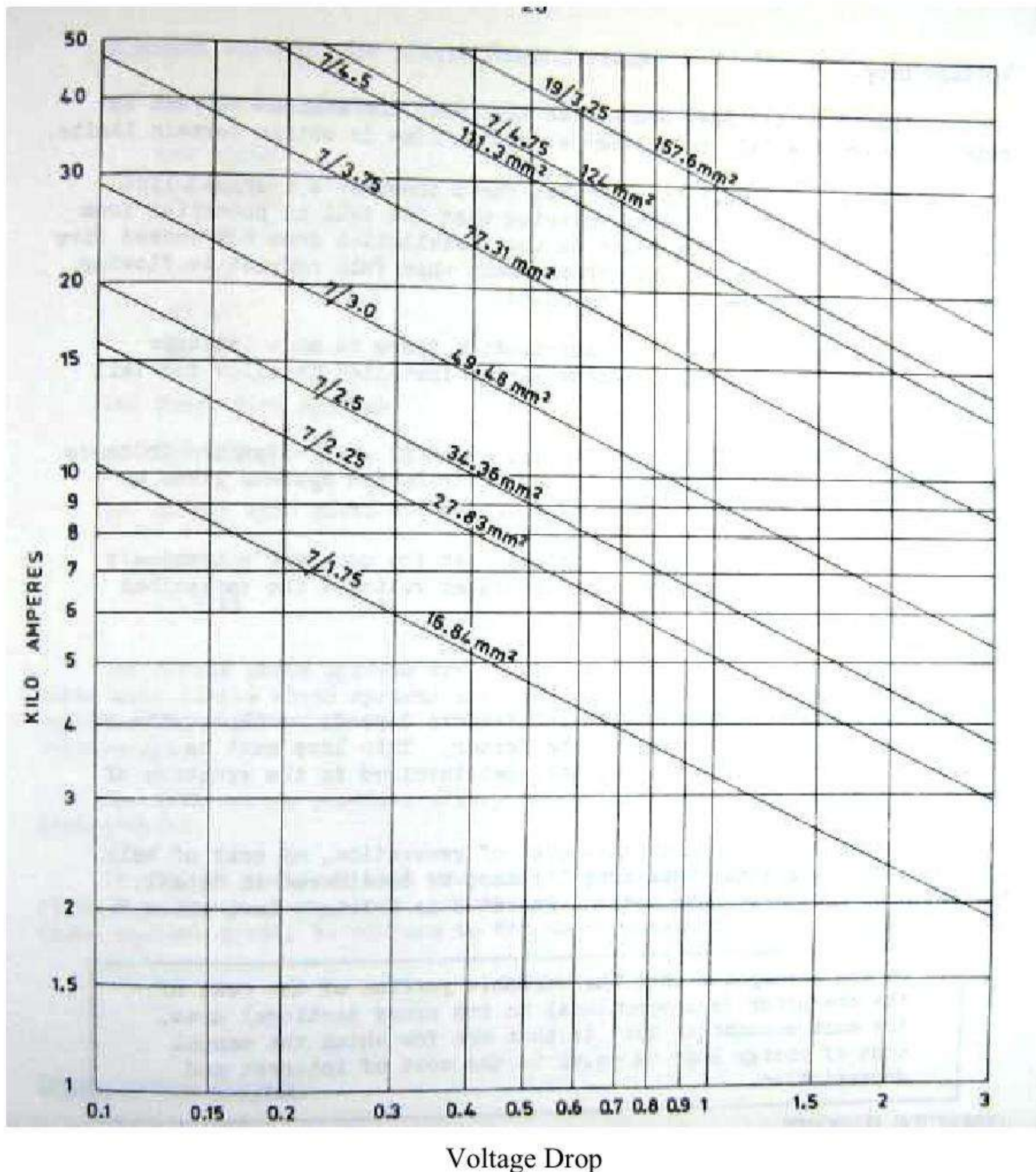

The conductor must operate so that when the maximum current is being conveyed the fall in voltage along the line is within certain limits.

The value of fall in potential for a consumer's overhead line must be taken into account when ensuring that the fall in potential from the consumers mains to any point on the installation does not exceed five per cent of the voltage at the commencement when full current is flowing. This is required by the SAA Wiring Rules.

For supply authorities distribution there is more latitude because voltage regulating equipment can be installed to allow for fall in voltage.

The Australian Standards specification AS – C1 Standard Voltages and Frequencies for AC Transmission and Distribution Systems gives an indication of the limits to be aimed for.

Section 2 – Overhead Lines and Installation

For medium voltages, the variation at the consumer's terminals should not exceed six per cent and for higher voltages the variations should not exceed ten per cent.

Power Losses

The power lost in distribution feeders depends on the square of the current and the resistance of the feeder. This loss must be considered in relation to the capital cost involved in the erection of the distribution line.

Apart from voltage and weather designation the factors to be considered in the selection of an insulator are:

- a. Minimum mechanical strength
- b. Minimum impulse withstand voltage at power frequency
- c. Minimum wet withstand voltage at power frequency
- d. Minimum puncture voltage at power frequency
- e. Minimum creepage distance between conductor tie and pin

Pin Insulator Designation

Pin insulators are designated by a series of letters and numbers

First letter	S	-	Standard
	F	-	Fog Type
	A	-	Aerodynamic
Next two letters	LP	-	Line Pin Insulator
First number			Nominal voltage kV
Second number			Minimum creepage distance
Example			ALP 33/920

This is an aerodynamic type line pin insulator for 33 kV with 920 mm creepage distance.

Shackle Insulators

Shackle insulators are used for terminations and angle construction mainly on low voltage lines. The high voltage shackle insulator is now displaced by the disc insulator.

Two types of low voltage shackle insulators are common: the SH, LVI with a minimum failing load of 9 kN and the SH. LV2 with a minimum failing load of 20 kN.

Disc Insulators

Disc insulators are used on high voltage lines for both intermediate and strain constructions. They may be used in combination and as a general rule one disc is suitable for 11kV, two for 22 kV and 3 for 33kV. The discs are available with minimum failing loads of 44 kN and 66 kN.

Disc insulator assemblies are identified by the use of suitable abbreviations of the description and number of the components forming the assembly.

Section 2 – Overhead Lines and Installation

S	-	Suspension
A	-	Anchor shackle
B	-	Hanger bracket
D	-	Disc
E	-	Eye bolt
N	-	Eye nut
P	-	Pole band
P1	-	Pole band termination
P2	-	Pole band through construction
S	-	Straight tongue

Example EA/2D represents a disc insulator unit with an eye bolt support, a shackle between the eye bolt and disc, and having two discs.

Stay Insulators

There are four standard types of stay insulators and these are tabulated below:

Stay Insulator Type	Line Voltage	Steel Wire Size	Minimum Failing Load kN
G Y 1	LV + 11 kV	7/2.75	27
G Y 2	11 kV	19/2.00	71
G Y 3	22 kV	19/2.75	222
G Y 4	33 kV	19/2.75	222

Insulator Pins

Insulator pins are made from hot rolled carbon steel and galvanised as shown in Figure 23

These pins are fitted with lead alloy heads composed of 95 per cent lead and 5 per cent antimony which are threaded to one of four standard forms. These are shown in Figure 24 and are designated as A, B and C.

Pattern B is used mainly for insulators of voltages up to 600 volts while pattern C is used mainly for high voltage insulators. Pattern A may be used for both medium and high voltage insulators.

The pin is designated by a reference number which gives the lead head pattern, as denoted by the letter representing the thread type, the stem length in millimetres, and the failing load for the pin kilonewtons. This reference number is usually stamped on the collar. The recommended working load for the pin is one third the failing load.

Section 2 – Overhead Lines and Installation

Standard pins are as follows:

Pin Type	Shank Size
B / 100 / 3.5	140 x 16 mm
A / 130 / 7	165 x 20 mm
C / 150 / 7	165 x 20 mm
C / 150 / 11	165 x 24 mm
C / 200 / 11	165 x 24 mm
C / 300 / 7	165 x 24 mm

For example, a C/300/7 insulator pin would have a C type thread, stem length would be 300mm and the transverse failing load for pin would be 7 kN.

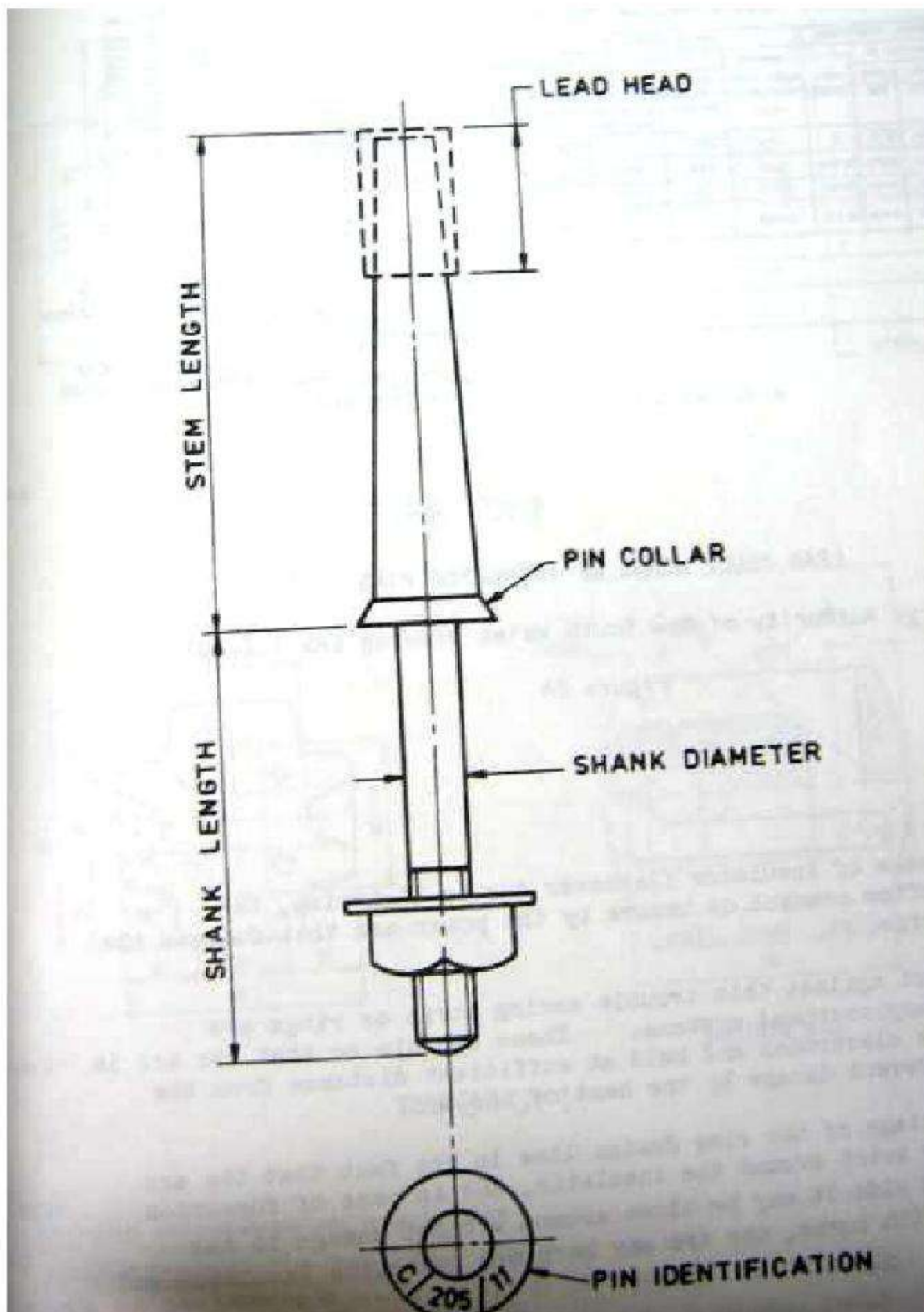

Section 2 – Overhead Lines and Installation

Causes of Insulator Failure

The following is a list of some of the causes of insulator failure:

1. Deterioration by cracking of the porcelain
2. Porosity of the porcelain
3. Puncture of weak porcelain
4. Shattering of insulator caused by power arc
5. Flashover of insulator caused by dust or salt deposits
6. Failure of insulator from excessive mechanical stress
7. Short circuits caused by birds or animals

Mechanical Properties of Overhead Conductors

Reference

Overhead lines must be erected in accordance with the Overhead Line Construction and Maintenance Regulations set out under the Electricity Development Act and published by the Energy Authority of NSW. A copy of these regulations is necessary for the course.

Working Strengths

The ultimate strengths of copper, all aluminium, and all aluminium alloy conductors are given in Australian Standards publications AS 1746, AS 1531 Part 1 and AS 1531 Part 2 respectively and the values listed in these publications must be used in conjunction with the working conditions laid down in the Overhead Line Construction and Maintenance Regulations. Tables 1, 2 and 3 give the properties of these conductors.

Maximum Tensions

The maximum tension to be allowed on a conductor is specified for two conditions, namely:

1. The maximum conductor tension shall not be more than fifty per cent of the ultimate tensile strength under a wind loading of 500 pascals at 15°C, and
2. The maximum conductor tension in still air at 5°C is not to exceed the following:

25 per cent	UTS	for hard drawn copper conductor
18 per cent	UTS	for hard drawn all aluminium, steel cored aluminium and hard drawn cadmium copper conductors, and
18 per cent	UTS	for aluminium alloy conductors

If vibration dampers are fitted the percentages rise to 33 1/3 per cent for hard drawn copper conductors and 25 per cent for hard drawn aluminium, steel cored aluminium and hard drawn cadmium copper.

Vibration dampers are fitted to transmission lines rather than distribution feeders.

Section 2 – Overhead Lines and Installation

2.3 Determine mechanical limitations and physical dimensions of lines – Part 2

Armour Rods and Vibration Dampers

Overhead conductors are subjected to mechanical vibrations caused by change of wind pressure. This may take the form of swinging of the conductors, or of high frequency vibrations caused by the formation of eddies on the leeward side of the conductor. These high frequency vibrations can cause metal fatigue at the points where the conductor is supported at the insulator, thus ultimately causing failure of the conductor.

Such failure is reduced greatly where the conductor is reinforced at the point of support, and by carefully designed conductor clamps.

Such reinforcing takes the form of armour tape or armour rods. Aluminium armour tape should be applied in aluminium and aluminium alloy conductors.

Helically Formed Fittings

At various points on overhead lines it is necessary to fix conductors and stay wires in position. For example, conductors must be fixed to line pin insulators, at terminations, conductors must be fixed to the shackle or disc insulators, and stay wires must be fixed to the pole and stay anchorages. For these purposes various methods of splicing or the use of wire rope grips have in the past been main methods.

Helically formed fittings are now common for these applications. These consist of elastic rods which have been formed into an open helix and are wrapped around a conductor or stay having a diameter somewhat greater than the internal diameter of the helix. The rods then firmly grip the conductor or stay.

Helically formed fittings are sometimes called preformed fittings. The following gives some types of fittings available.

Armour Rods

These are helically formed rods of relatively large diameter wire and are applied to sheath a conductor at support points. The reason for using armour rods was given in an earlier paragraph.

Line Guards

These are shorter in length and of smaller diameter wire than armour rods. They are used at conductor supports to protect the conductor against chafing or flash over burns

Vibration Dampers

A helically formed vibration damper is manufactured which has somewhat similar properties to the Stockbridge damper

Section 2 – Overhead Lines and Installation

Terminations or Dead Ends

These are helically formed wires, bent at the centre to form a hairpin shape. The free ends are interleaved on to the conductor or stay wire during application, leaving a loop to which tension is applied.

Insulating Materials for Electrical Conductors

In distribution networks the purpose of an electrical conductor is to carry the current from one point to another and the purpose of the insulating material is to confine the current to the conductor. A variety of insulating materials has been processed and developed to withstand the conditions under which conductors operate, such as

1. Temperature extremes – high and low
2. Moisture
3. Gaseous, dirty and abrasive environments
4. Mechanical vibration and impact
5. Transient high voltages

The electrical insulation of cables is protected by the addition of a sheath and, where required, by the further addition of serving, armouring bitumen and inhibitors as referred to in the section on cables to follow.

Insulating materials that are at present most commonly used for cables are:

Polyvinyl Chloride (P.V.C)

Vinyl chloride is a colourless gas derived from acetylene and hydrochloric acid, the basic raw materials being lime, salt and coke. At low temperatures the gas becomes liquid and can be distilled to obtain the desired degree of purity. On polymerisation a white powder is formed, this being the basic material or polymer to which a number of chemicals is added to obtain the thermoplastic known as polyvinyl hydrochloride (P.V.C). The additives have a marked effect on the physical and electrical properties of the finished product. Properties such as flexibility, abrasion resistance, embitterment at low temperatures, tear ability, oil resistance, termite resistance and colour are readily controlled.

Thermoplastic insulants are less tolerant than other materials to overload and short circuit conditions. Fuses and other protective devices must be sufficiently sensitive to prevent the P.V.C approaching softening point, even for a few seconds.

Black compounds are always recommended for aerial use and exposed installations. This is due to the screening effect on ultraviolet rays which would cause deterioration of coloured compounds.

As with physical, electrical properties are controlled to a marked extent by the nature and quantity of the additives. Variations in temperature and frequency cause marked changes in electrical characteristics.

Cross-Linked Polyethylene (XLPE)

This material is one of the most commonly used insulants for power cables. It is a thermosetting material and, as such, possesses extremely good thermal and electricity stability.

Section 2 – Overhead Lines and Installation

This material is one of the most commonly used insulants for power cables. It is a thermosetting material and, as such, possesses extremely good thermal and electrical stability.

Low cost, ease of fabrication and excellent mechanical and chemical resistant properties have led to its wide use as cable insulation for all types of applications.

Because of its excellent resistance to heat, XLPE cables are suitable for continuous operation at 90°C , short time operation at 130°C and short circuit performance up to 250°C . These characteristics, combined with high continuous and short circuit current ratings, lightness, robustness and ease of use have been responsible for their world wide use acceptance and use. The cross linking of polyethylene is achieved by chemical means. XLPE has a very small power factor and dielectric constant when compared to other insulants. It also shows good resistance to chemicals such as ordinary acids, greases and oils.

Compacted conductors are generally used for 1.9 / 3.3kV cables and above. High voltage XLPE cables are compacted to reduce the size of the interstices which in turn tends to prevent the semi conductive screen material moving into the air spaces. Compacting is achieved by passing the stranded cable through a tight die. Reducing its overall diameter by approximately 10%. Material is not removed from the metallic conductor, thus maintaining the same resistance, but the small amount of cold working of the material tends to increase its tensile strength and makes the cable a little stiffer.

Ethylene Propylene Rubber (EPR)

EPR insulation is a thermosetting material and possesses excellent thermal and electrical properties. Although EPR has a higher dielectric constant and power factor than XLPE, it has greater resistance to corona, ozone and fire and has more flexibility than XLPE. Because of high raw material costs EPR is used in preference to XLPE only where EPR's greater flexibility is required.

Impregnated Paper

The paper used is of uniform texture and long fibre and is free from any imperfections. It does not contain chemical impurities or loading materials and has low ash content. It has been selected to give high dielectric strength when impregnated, and to last without any deterioration of electrical properties. It is generally cheaper than other forms of insulants and has an exceptionally long life span. Further information on this type of material is provided in the next section on cables.

Section 2 – Overhead Lines and Installation

Insulation	Specific Gravity	Relative Permittivity	Thermal Resistivity $\delta_{cm/W}$	Volume Resistivity At 20°C Ωm	Dielectric Loss Factor At 20°C	Maximum Conductor Temperature °C	Maximum Short Circuit Temperature °C
PVC	1.47	5.0-8.0	5.0-6.0	10^{12}	0.08	75	15-160
PE	0.92	2.3	3.5	10^{14}	0.0001	70	130
XLPE	0.92	2.5	3.5	10^{14}	0.0008	90	250
EPR	1.20	3.0	3.5-5.0	10^{13}	0.004	90	250
Impregnated Paper	1.10	3.3-3.9	6.0	10^{13}	0.004	65-80	160-250

Section 2 – Overhead Lines and Installation

2.4 Determine leading limitation using design schedules and calculations (Part 1)

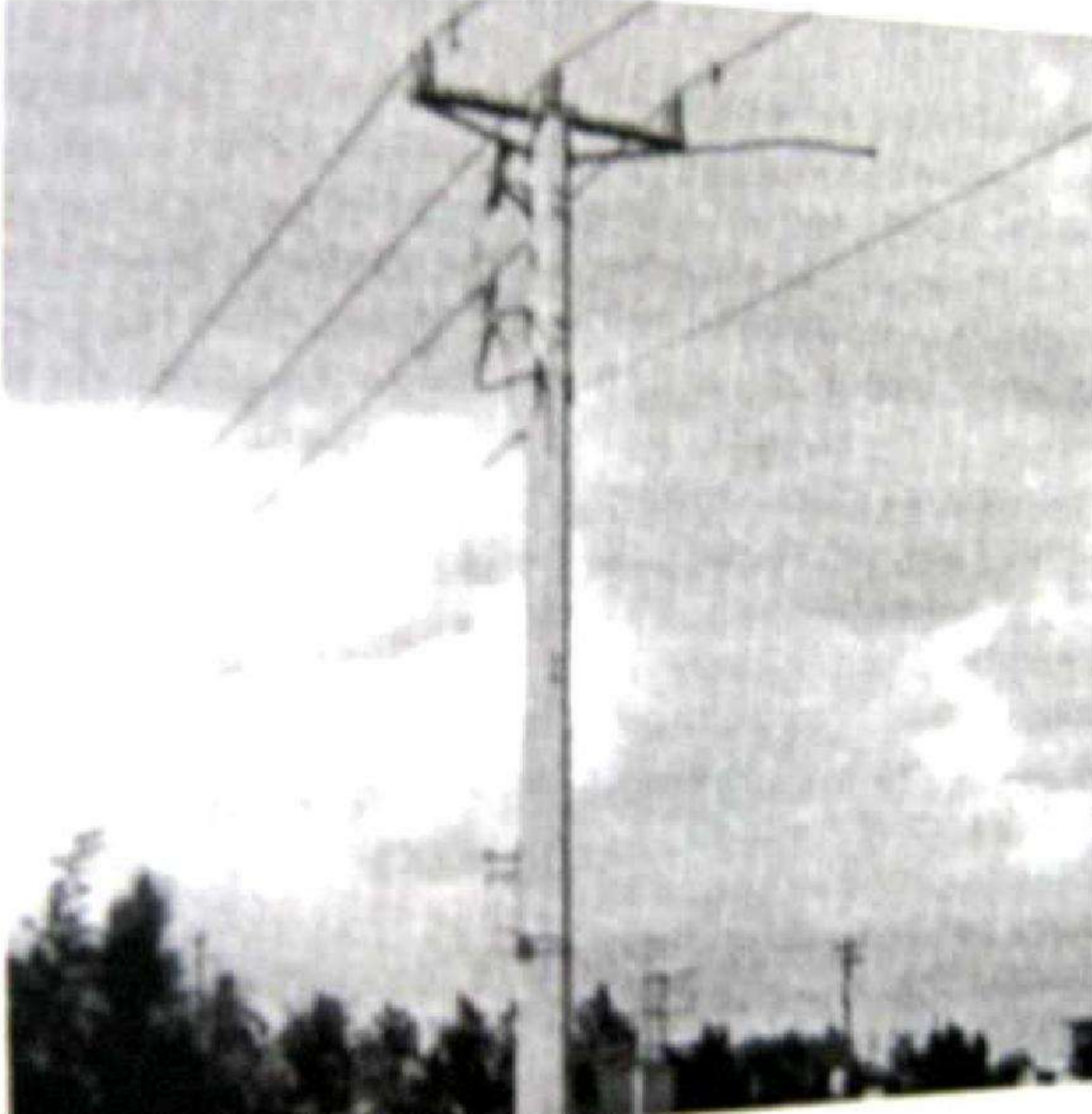

Wood Poles

The simplest and cheapest support structures are wood poles. These were the first extensively used electrical conductor support structures. Wood poles have been made from larch, spruce, cedar pine, and fir trees, selected for height and straightness. The most commonly used trees for poles are Southern Yellow Pine (SYP) about 70%, and Douglas Fir, about 25%. All of the others comprise only about 5% of the wood poles used. Poles from 25 to 65 feet are generally SYP while poles over 65 feet are generally Douglas Fir. Wood poles are available in heights from 25 to 130 feet (or more on special order) in 5 foot increments.

Wood pole heights and strengths have been codified from tests, and tables prepared to make distribution design easier. A reliable average for maximum longitudinal fibre stress in both pine and fir is 8000 psi. That is the psi at which the wood fibres will start to split or slide past each other. So all design strengths have been calculated

Section 2 – Overhead Lines and Installation

from this value. As force is gradually increased, a pole will fail first by splitting along the pole and then by breaking.

Poles are designated by strength and degree of straightness as class 1 (best through 5 (worst). Larger poles have their own classification as extra heavy duty classes 0,00,000, and 0000, with more zeros being heavier duty. The zeros are usually written as H1, H2, H3, H4.

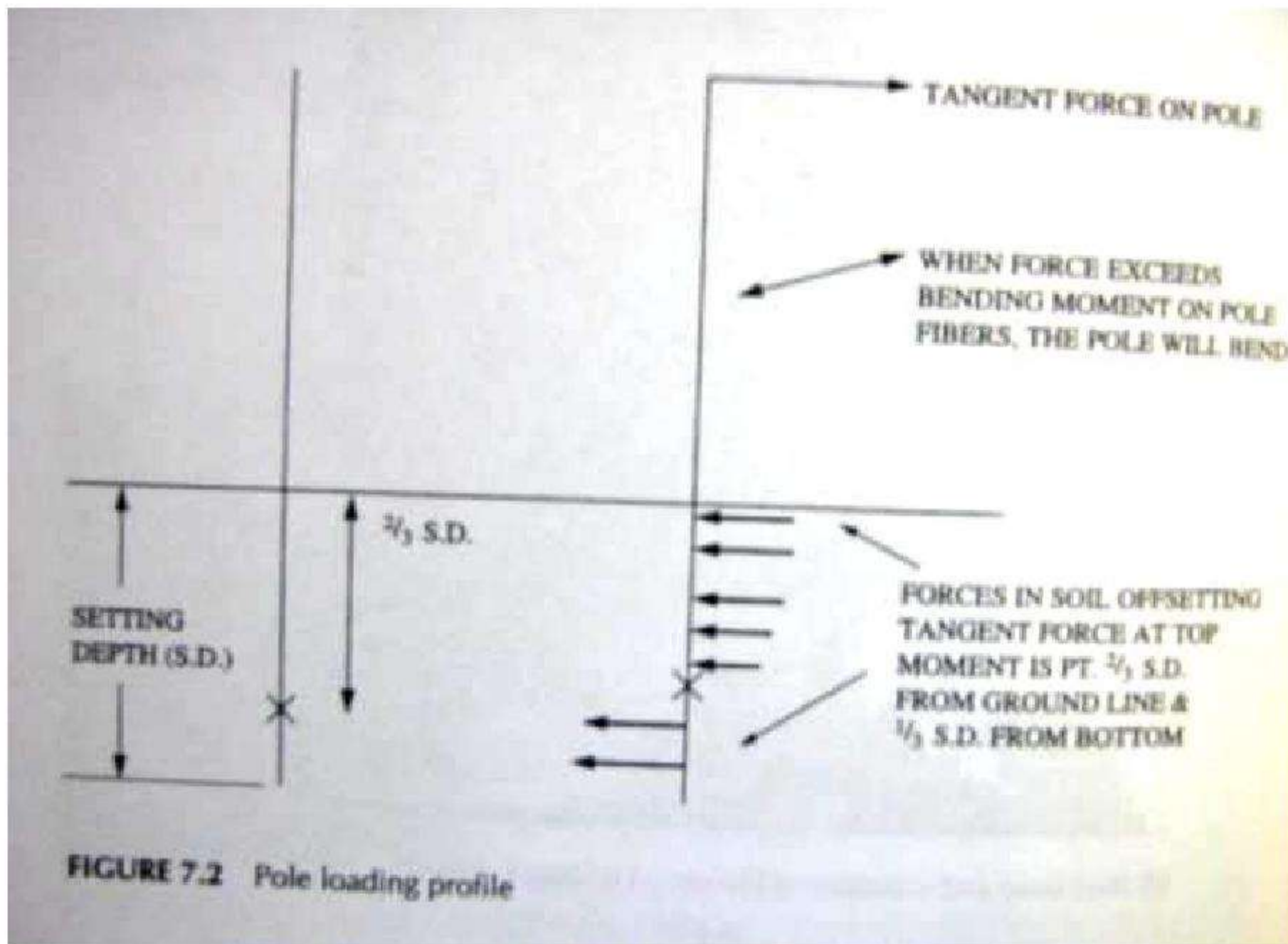

Section 2 – Overhead Lines and Installation

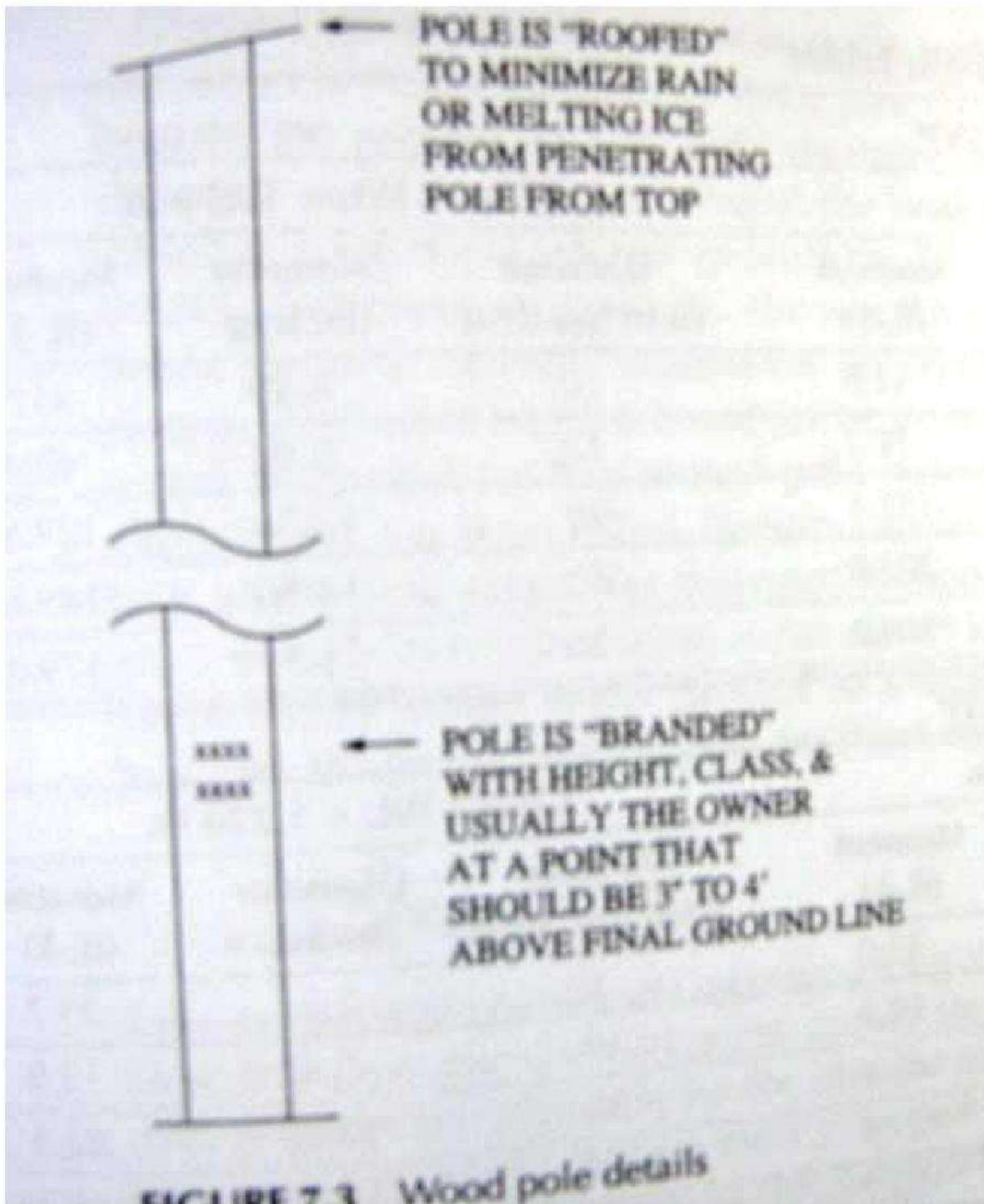

Section 2 – Overhead Lines and Installation

Table 7.2 Wood Pole Strength Tables

50 Ft. Pole, Douglas Fir or SYP

Class H1, WL = 2,200 lb.			Class 1, WL = 1,970 lb.		
Distance From top (feet)	Diameter (inches)	Moment (ft.-k)	Distance From top (feet)	Diameter (inches)	Moment (ft.-k)
0	9.23	51.5	0	8.59	41.5
10	10.57	77.3	10	9.90	63.4
30	13.28	152.1	30	12.50	127.9
40	14.58	203.0	40	13.80	149.6
50	15.92	264.2	50	15.11	179.2

50 Ft. Pole, Douglas Fir or SYP

Class 2, WL = 1,700 lb.			Class 3, WL = 1,220 lb.		
Distance From top (feet)	Diameter (inches)	Moment (ft.-k)	Distance From top (feet)	Diameter (inches)	Moment (ft.-k)
0	7.96	33.0	0	7.32	25.7
10	9.19	50.8	10	8.48	39.9
30	11.65	103.4	30	10.79	82.3
40	12.88	139.4	40	11.95	111.7
50	14.11	183.7	50	13.11	147.4

70 Ft. Pole, Douglas Fir or SYP

Class H1, WL = 3,640 lb.			Class 1, WL = 3,225 lb.		
Distance From top (feet)	Diameter (inches)	Moment (ft.-k)	Distance From top (feet)	Diameter (inches)	Moment (ft.-k)
0	9.23	51.5	0	8.54	41.5
30	12.96	142.5	30	12.18	118.1
50	15.45	241.3	50	14.56	202.1
70	17.93	377.6	70	16.95	318.7

70 Ft. Pole, Douglas Fir or SYP

Class 2, WL = 2,840 lb.			Class 3, WL = 2,470 lb.		
Distance From top (feet)	Diameter (inches)	Moment (ft.-k)	Distance From top (feet)	Diameter (inches)	Moment (ft.-k)
0	9.23	33.0	0	7.32	25.7
30	11.00	96.7	30	10.60	78.0
50	13.68	167.5	50	12.79	137.0
70	15.97	266.3	70	14.698	220.0

Section 2 – Overhead Lines and Installation

Steel Poles

Steel poles have been used now for a long time, and are well proven. They do not have the elasticity of wood poles, nor do they have the lifetime. The life of a steel pole is governed primarily by the quality and thickness of the galvanising. There are special paints to make a steel pole look better longer, but it is impractical to paint the inside of the pole, so that galvanising sets the pole life. Steel poles typically last from 25 to 30 years.

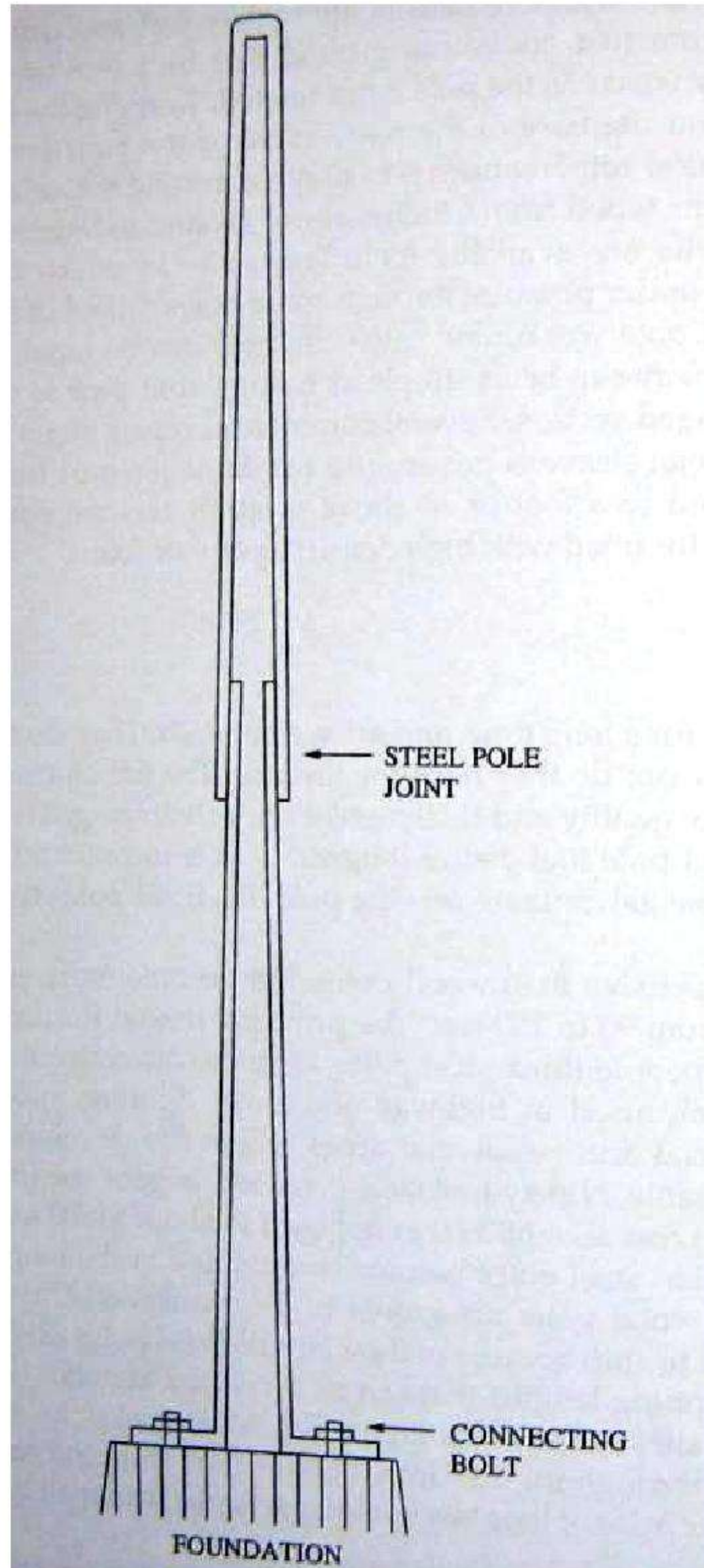

Section 2 – Overhead Lines and Installation

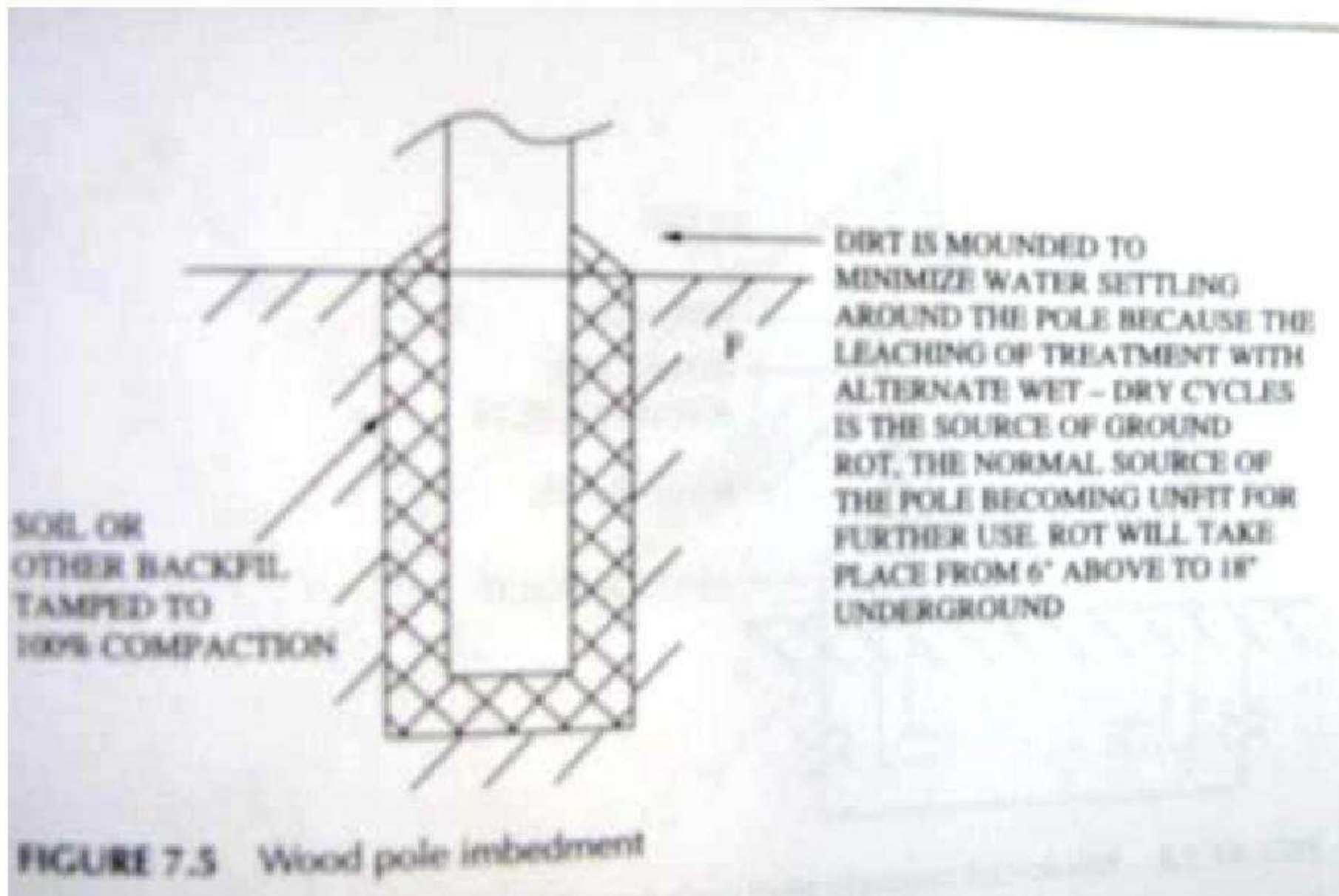

A steel pole requires an embedment depth of 10% of the height plus 2 feet for standard soil. Thus a 50 foot pole has an embedment of 7 feet while a 70 foot pole has an embedment of 9 feet. The soil must be tamped to 100% compaction, meaning to the density it was before the hole was dug. Specifications usually require two tampers for each shoveler when the soil is filled in around the pole. A pole set in soil can be loaded immediately.

Embedment can be reduced if concrete stabilised sand, rock, or concrete are used for fill. Concrete stabilised sand is a mixture of $\frac{3}{4}$ sand and $\frac{1}{4}$ concrete used for fill where the soil has too much give to support a pole well. The concrete stabilised sand essentially increases the size of the pole end so that the loading per unit area on the soil is lower. The concrete must set up before the pole can be loaded. Reinforced concrete foundations for steel poles can be very expensive, costing more than the pole for some dead end poles. They are necessary in soils that are particularly corrosive to steel. Figure 7.6 is a sketch of a reinforced concrete steel pole foundation. Anchoring is much cheaper and is used on wood and directly imbedded steel poles.

Poles and embedment are designed to support forces that are balanced on either side of the pole. Down guy wires and anchors are used to balance the forces on the pole in situations in which balanced pole loading is not possible.

Section 2 – Overhead Lines and Installation

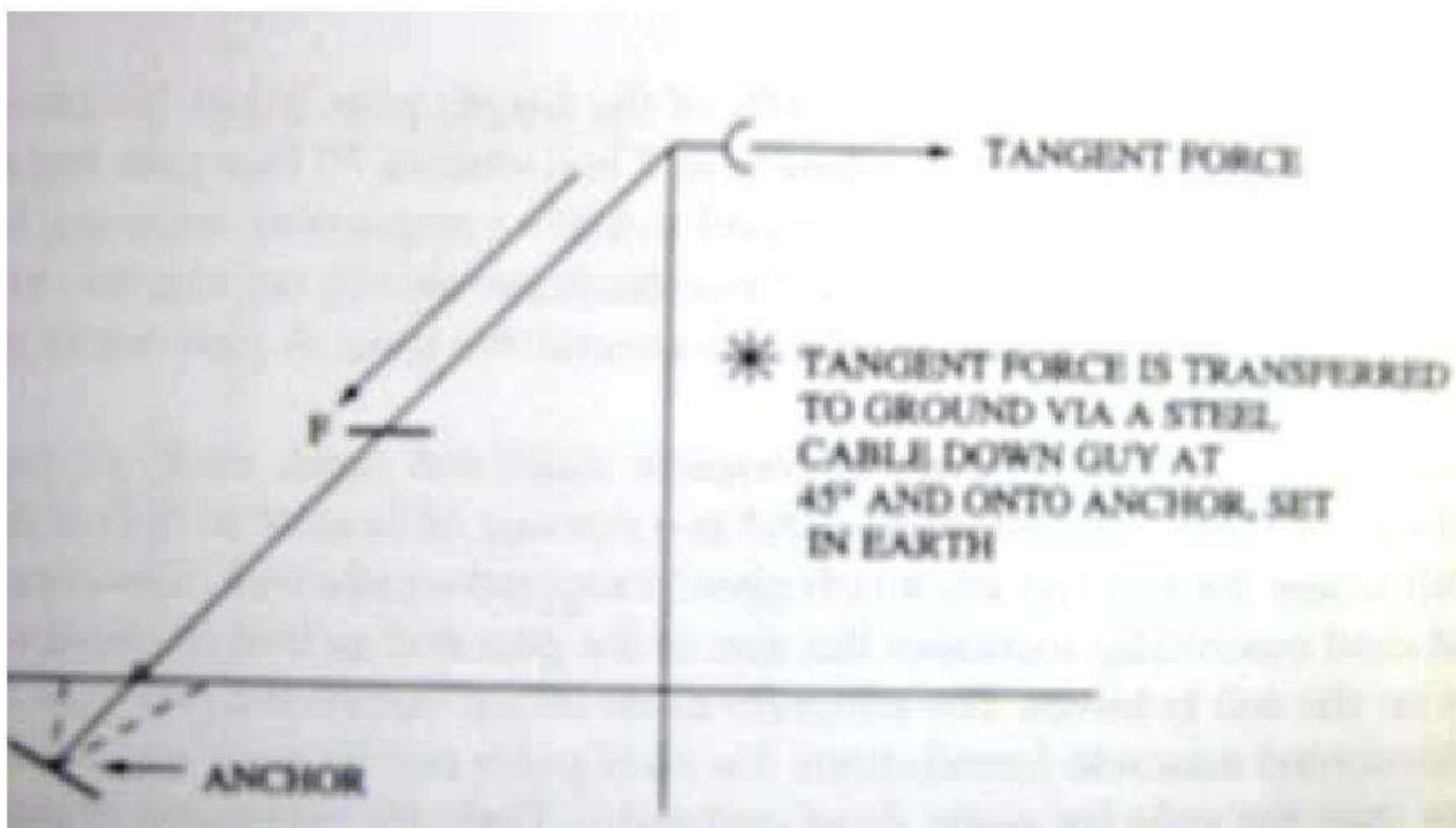
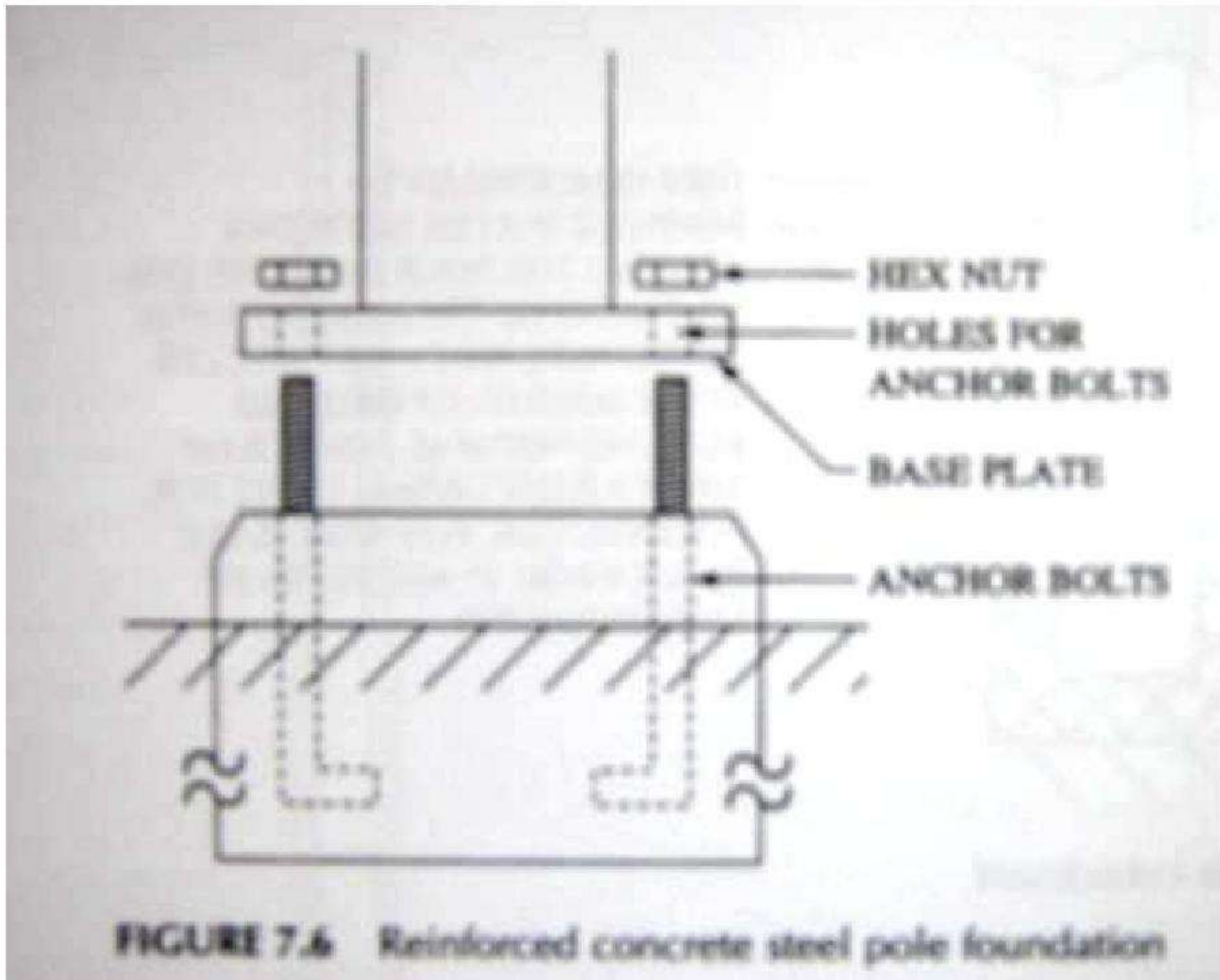

Section 2 – Overhead Lines and Installation

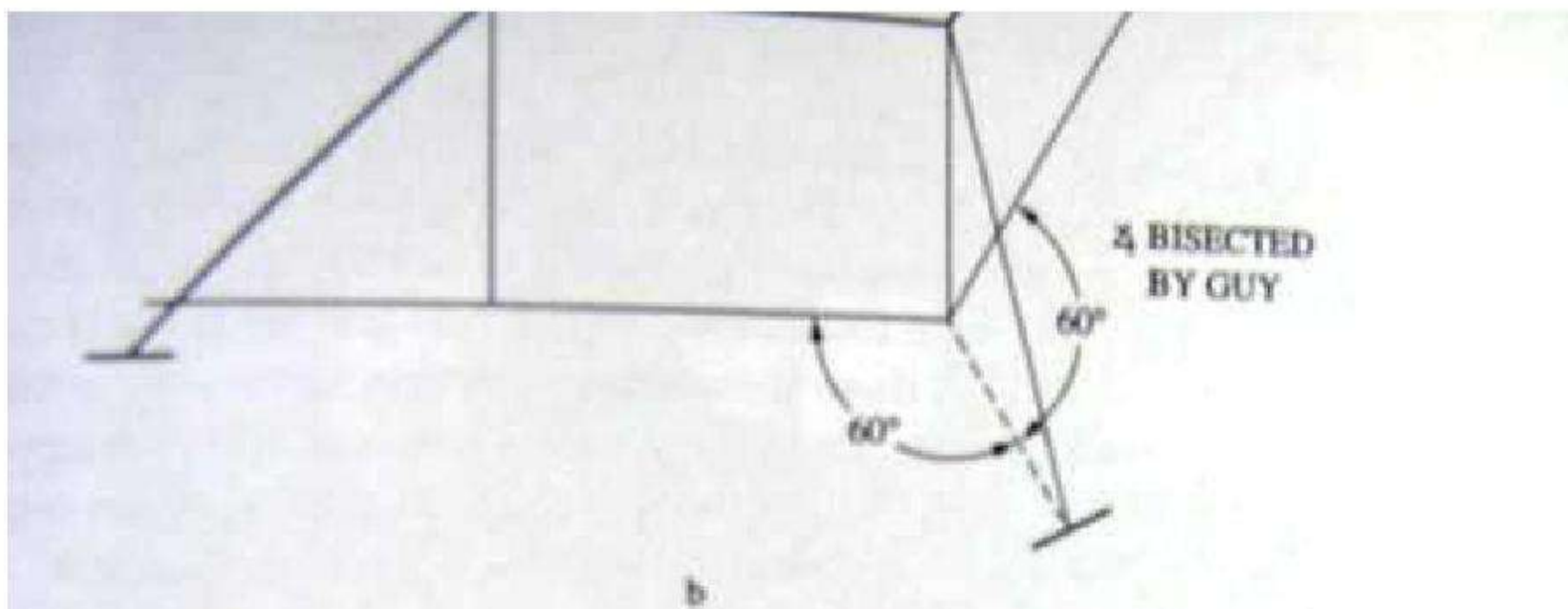
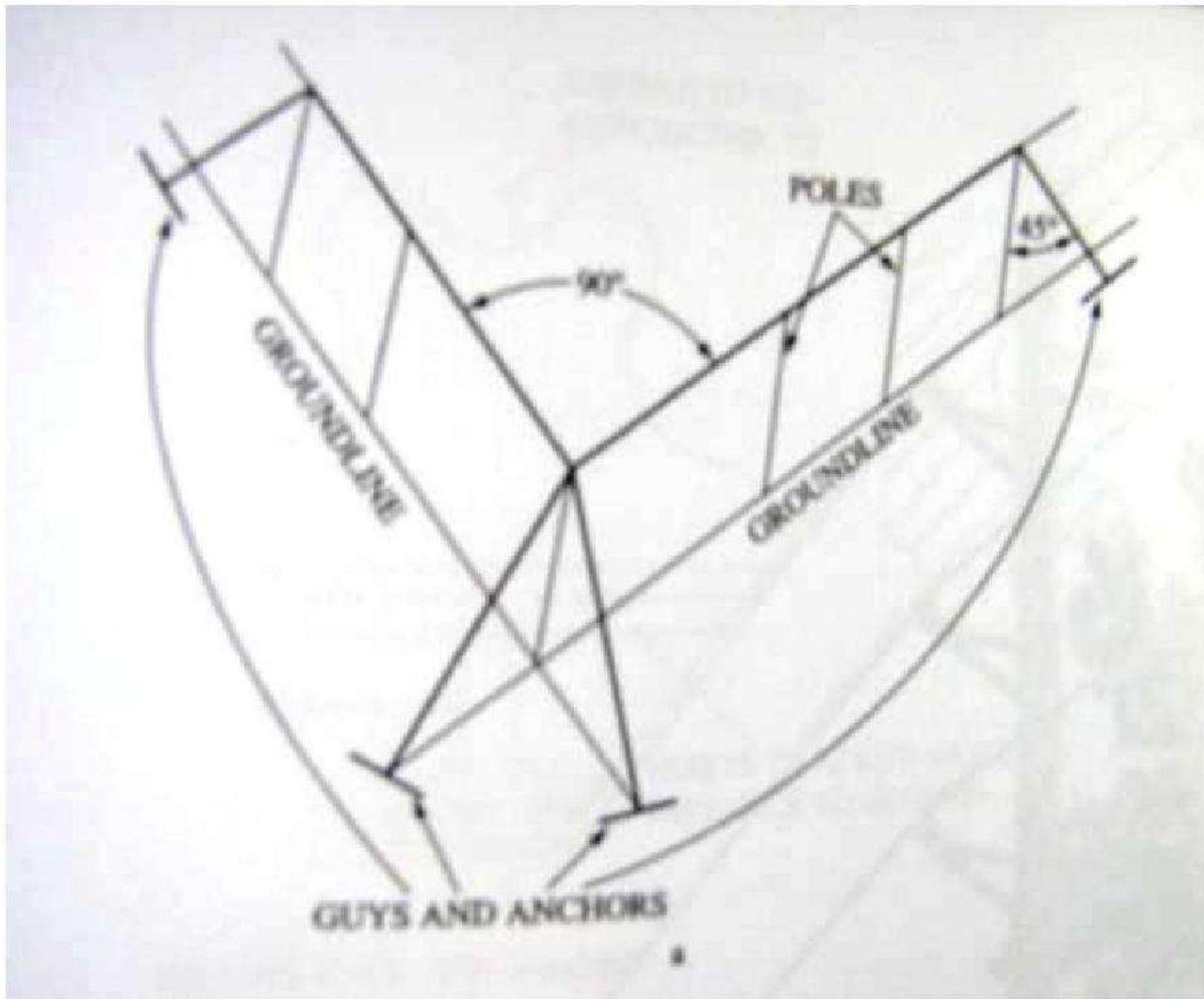
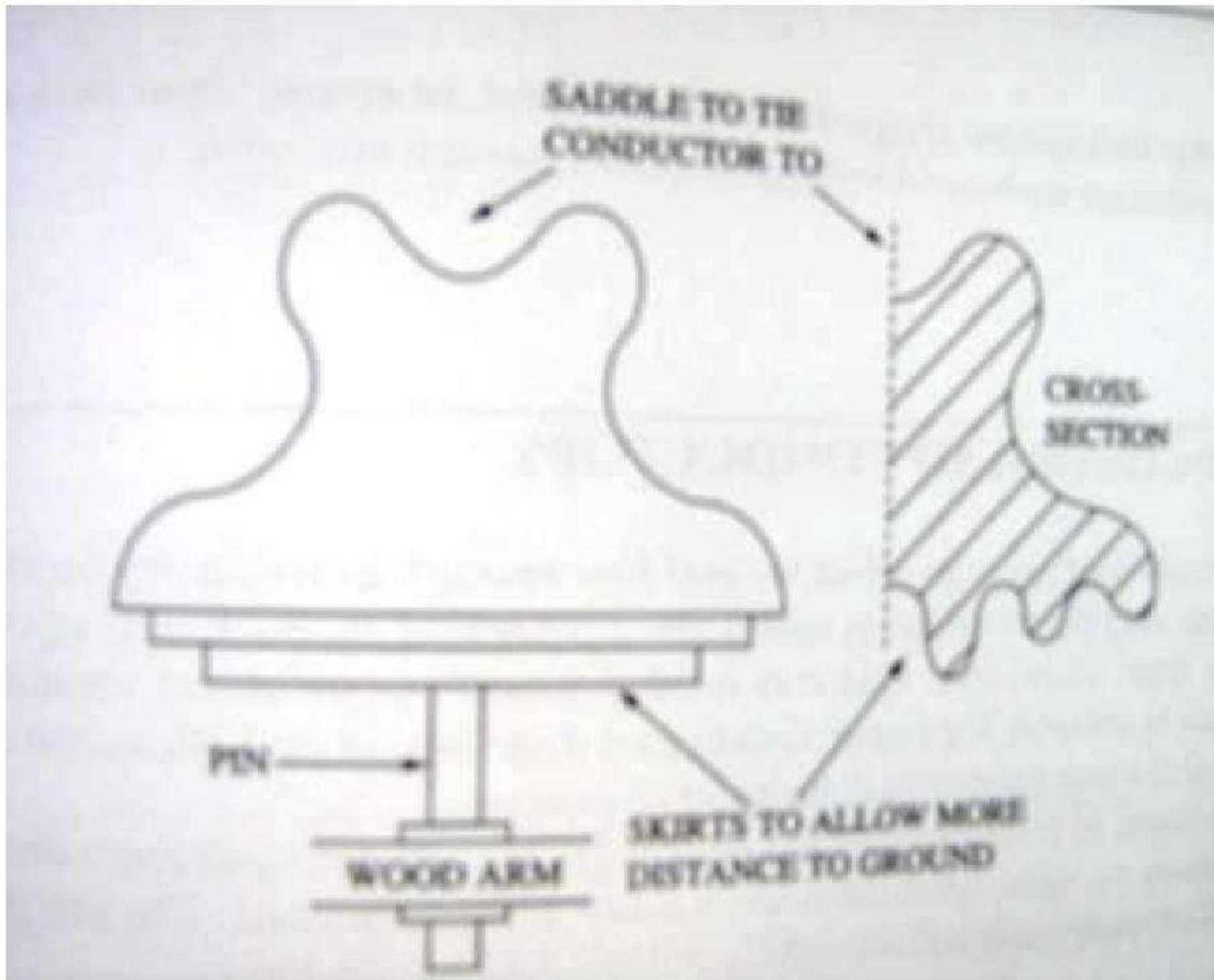
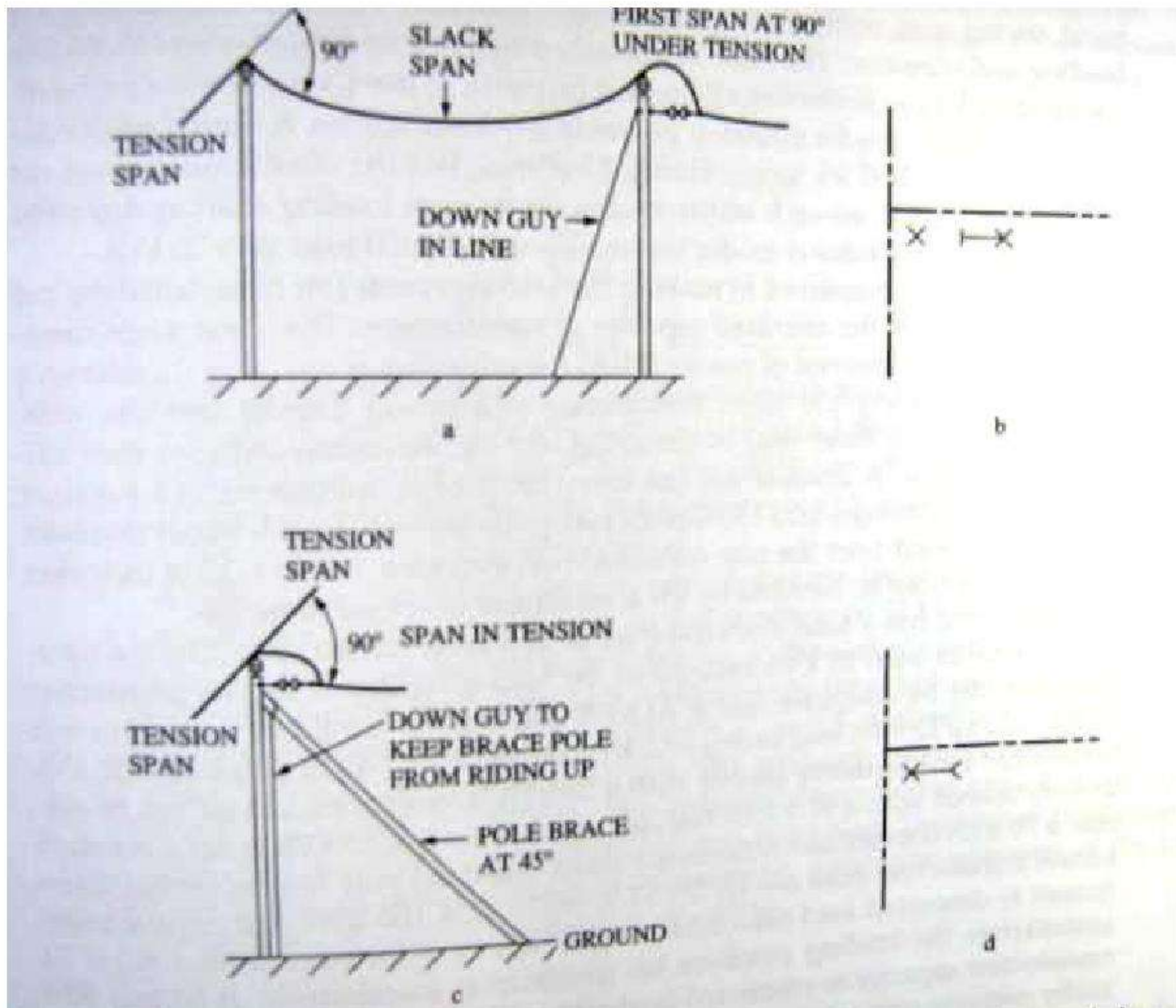

FIGURE 7.8 Pole anchors on line direction changes (a) 90° and (b) 120°

Section 2 – Overhead Lines and Installation



Section 2 – Overhead Lines and Installation



Main Street Feeder Conversion

The voltage change over for the Main Street feeder is done as follows;

Temporary framing for 12.47 kV is installed below the present line as shown in Figure 7.22. Generally a 12 to 14 foot cross arm is used for 12.47 kV lines. This can be done without killing power.

Section 2 – Overhead Lines and Installation

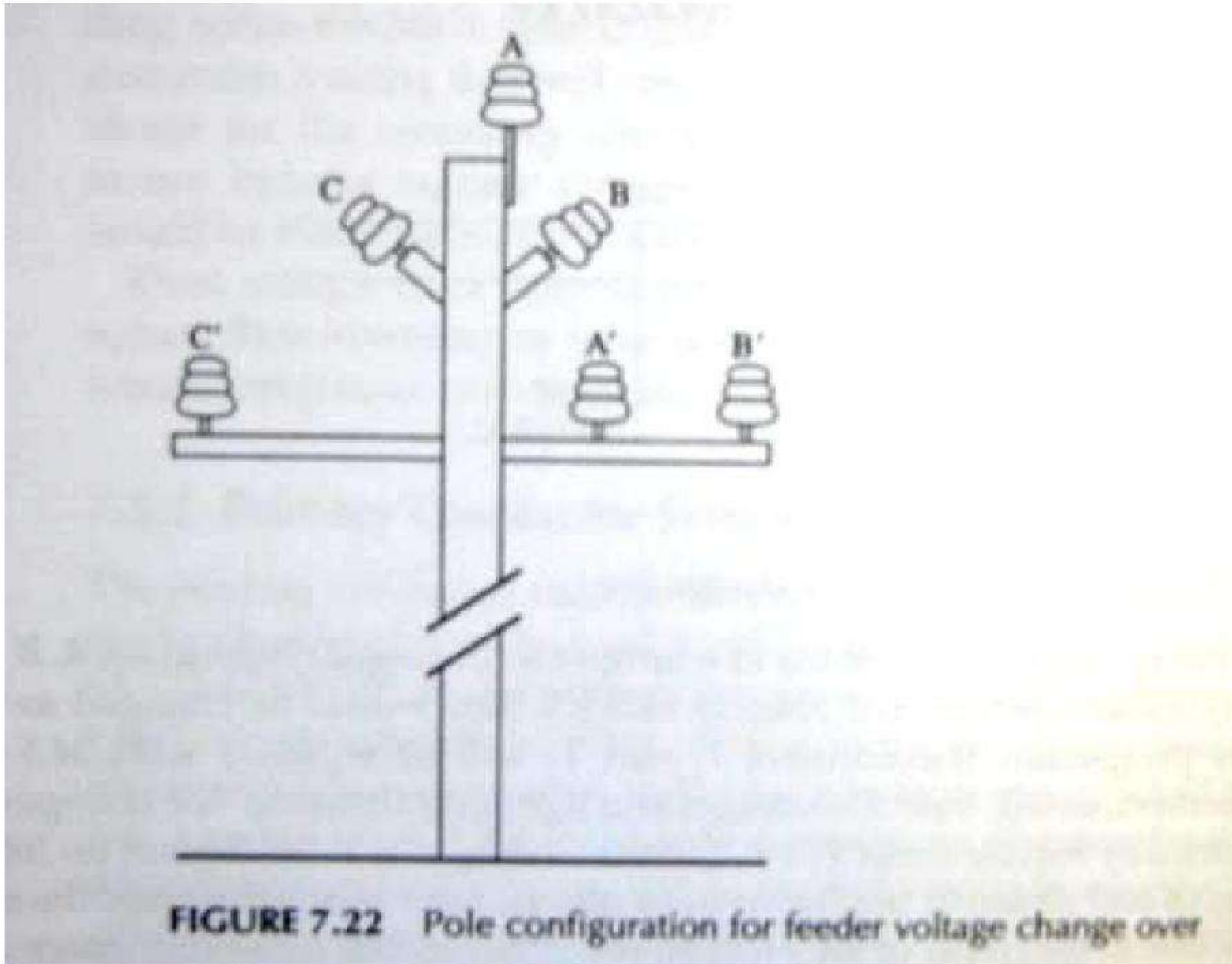

Section 2 – Overhead Lines and Installation

2.4 Determine leading limitation using design schedules and calculations (Part 2)

Criteria

The mechanical design of the distribution system, and its several parts, must not only be adequate to sustain the normal stresses and strains, but must safely sustain them during abnormal conditions brought about by the vagaries of nature and people. While design criteria for overhead systems are substantially different from those for underground systems, in both instances prudent design takes into account economic and other non technical considerations.

In general, the code specifies:

1. Clearance between conditions and surrounding structures for different operating voltages and under different local conditions.
2. Strength of materials and safety factors used in proposed structures.
3. Perhaps the most basic, the probable loading imposed on the conductors and structures based on climatic conditions, approximately defined by geographical areas.

Type of loading	Radial thickness of ice		Wind load on projected area of conductors		Temperature	
	in	cm	lb/ft ²	Kg/m ²	° F	° C
Heavy	0.5	1.27	4	20	0	-18.0
Medium	0.25	0.63	4	20	+15	-9.4
Light	0.0	0.0	9	44	+30	-1.1

Poles

Stresses

The forces acting on a pole stem from the vertical loading occasioned by the weight it has to carry and from the horizontal loadings applied near the top of the pole. These latter are exerted by the conductors as a result of uneven spans.

Both vertical and horizontal loadings include the effects of ice collecting radially about the conductors.

The vertical force on the pole is the dead weight of the conductors with their coatings of ice, cross arms, insulators, and associated hardware. This vertical force exerts a compressive stress that may be considered uniformly distributed over the cross section of the pole. This loading, however, is almost always overshadowed by the requirements of the horizontal loadings, and is usually not given further attention. Even a very light pole can safely carry the dead weight of a multi-circuit, large conductor line.

Section 2 – Overhead Lines and Installation

From wire manufacturer's tables, no. 4/0 copper wire has a diameter of 0.528 in and a weight of 640.5 lb per 1000 ft; and 397.500-cmil ACSR has a diameter of 0.806 in and a weight of 620.6 lb per 1000 ft. The total weight, including ice, for 200 ft (100 ft on each side of pole) for the copper conductors is 2120 lb plus 500 lb allowed for four cross arms, insulators, etc., or 2620 lb. For the ACSR conductors, it is 2840 lb, plus the same 500 lb, or 3340 lb.

The cross sectional area at the top of a class 5 pole is

$$A = \pi r^2 = \pi \left(\frac{19}{2\pi} \right)^2 = \frac{90.25}{3.14} = 28.7 \text{ in}^2$$

This may be rounded off to 25 in².

Conservatively, the dead weight of the copper conductors is 2750 lb divided by 25 in², or 110 lb/in²; that of the ACSR conductors is 3500 lb divided by 25 in² or 140 lb/in².

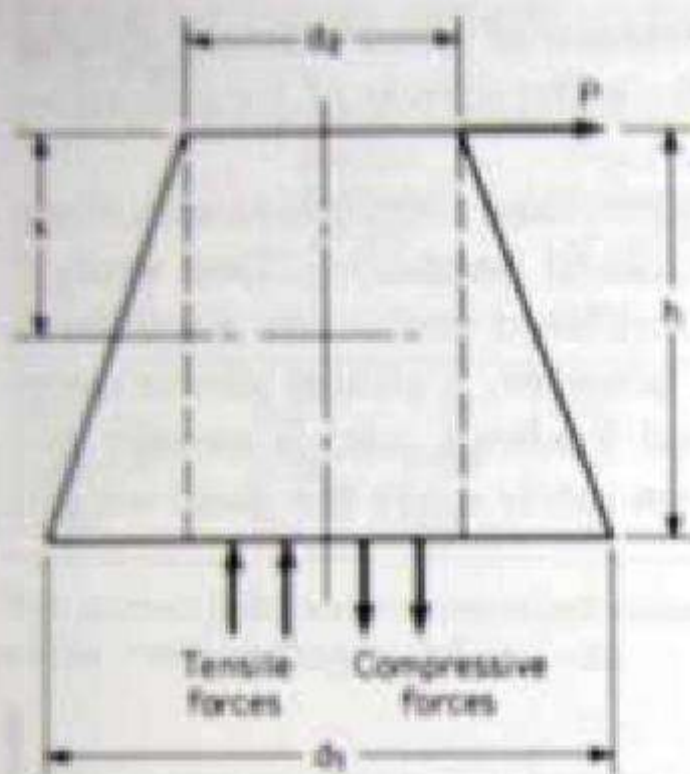

FIG. 5-2 Diagram of stresses on pole.

The maximum permissible compressive stress for wood ranges from about 500 lb/in² for western red cedar to 600 lb/in² for southern long-leaf yellow pine.

For the horizontal loading, the pole can be considered a cantilever beam anchored at one end with a load applied at the other. The bending moment produces stresses in the wood, with the maximum fiber stress occurring at the edge of the cross section farthest from the neutral axis; the stresses are compressive on the side on which the load is pulling and tensile on the opposite side. Refer to Fig. 5-2.

Section 2 – Overhead Lines and Installation

Bending Moment

The bending moment M is equal to the horizontal force applied P , multiplied by its perpendicular distance to the point where failure may occur, h , usually taken at the ground line.

$$M = Ph$$

Maximum Fibre Stress

The maximum fibre stress f at any cross section is

$$f = M \frac{c}{I}$$

Where c is the distance from the extreme fibres of cross section to the neutral axis and I is the moment of inertia of the cross section. For a circular cross section, where d is the diameter.

$$c = \frac{1}{2} d$$

$$I = \frac{\pi d^4}{64} = 0.491 d^4$$

So that

$$f = \frac{M}{0.0982 d^2}$$

$$\frac{I}{c} = \frac{\pi d^3}{32} = 0.0982 d^3 \quad (\text{called the section modulus})$$

Wind Pressure

In arriving at M , if P is the wind pressure on the length of the conductor, including its coating of ice, and h the distance or height from the ground at which the circular cross section is to be determined, the total moment for the several conductors that may be supported is the sum of the values of Ph for all the conductors.

To this must be added the wind pressure on the pole itself. Here, the longitudinal cross section of the pole may be broken down into a rectangle and a triangle, as indicated in Fig. 5.2.

The pressure on the rectangle (P_x) will be

$$P_x = P_1 d_2 h$$

Where P_1 is the unit pressure in pounds per square inch. Its moment M_x about the base will be

$$M_x = P_1 d_2 \frac{h^2}{2}$$

The pressure on the triangle (P_τ) will be

$$P_\tau = P_2 (d_2 - d_1) \frac{h}{2}$$

Section 2 – Overhead Lines and Installation

And its moment about the base will be

$$M_2 = P_2(d_2 - d_1)\frac{h^2}{6}$$

And the load pressure on the pole (P_2) will be

$$P_2 = P_2 h \frac{d_2 + d_1}{2}$$

And the total moment on the pole (M_2) will be

$$M_2 = P_2 h^2 \left(\frac{d_2}{3} + \frac{d_1}{6} \right)$$

The total moment the pole must accommodate will be the sum of the moment for the several conductors and the moment on the pole itself.

Examples 5-2

Assume a 40 ft pole (required for clearance) set 6 ft in the ground with three no. 4/0 stranded copper conductors on a cross arm with the conductors level at the top of the pole, and 150 ft balanced spans, in a heavy loading area (see Table 5-1)

The moment due to wind on the conductors when ice coated is as follows. No. 4/0 stranded copper wire has a diameter of 0.528 in; allow 1 in of ice, for a unit diameter of 1.528 in of area to the wind.

$$\begin{aligned} M &= 3 \frac{1.528 \text{ in}}{12 \text{ in/ft}} (150 \text{ ft} \times 4 \text{ lb/ft}^2) (40 - 6 \text{ ft}) \\ &= 7792.8 \text{ ft lb or } 95,513.6 \text{ in lb} \end{aligned}$$

The moment on the pole itself due to wind (for an estimated diameter at the top of 8 in, and 12 in at the bottom) is as follows;

$$M = \frac{4}{144} (34 \times 12)^2 \times \left(\frac{8}{3} + \frac{12}{6} \right) = 21,580 \text{ in lb or } 1798 \text{ ft lb}$$

Say 1800 ft lb. The total for both is 115,093 ft in lb: say 115,000 in lb, and

$$f = \frac{115,000}{0.0982 \times 12^2} = 678 \text{ lb/in}^2$$

Say 700 lb/in²

The ultimate fibre stress for several woods and the resultant factors of safety for those woods are as follows.

Section 2 – Overhead Lines and Installation

Wood	Ultimate Stress, lb/in^2	Factor of Safety
Northern White Cedar	3,600	5+
Western Red Cedar	5,600	8
Long-leaf Yellow Pine	7,400	10+
Wallaba	11,000	15+

The total moment at the pole is 9591 ft lb, say 9600, multiplied by a factor of safety of 2, it is 19,200 ft lb, say 20,000.

From the ASA Standards Table of Wood Pole Classification, for a 40 ft class 5 pole, the resisting moments at 6 ft from the butt, nearest to this value but greater, are shown in Table 5-2. Any of these poles will sustain the loading due to wind.

As a check, the pole circumference C , in inches, required to withstand a bending moment M , in foot-pounds, for a wood having a permissible fibre stress f , in pounds per square inch, is

$$C = \sqrt{\frac{5790M}{f}}$$

Assume long leaf yellow pine, $f = 7400 \text{ lb/in}^2$, is used

$$C = \sqrt{\frac{3790 \times 20,000}{7400}} = 21.71 \text{ in}$$

This is the minimum required, as opposed to the 31.5in actual circumference. The difference provides a margin which insures the performance of the pole should it rot at the ground line and reduce the cross sectional area there.

Table 5-2 Resisting Moments and Data for 40ft Poles

Wood	Class	Resisting moment, ft-lb	Circumference, in	
			Minimum, at top	6 ft from butt
Northern White Cedar	5	60,800	19	40.0
Western Red Cedar	5	60,700	19	34.5
Long-leaf Yellow Pine	5	60,900	19	31.5

From ASA Standards Table of Wood Pole Classifications

Section 2 – Overhead Lines and Installation

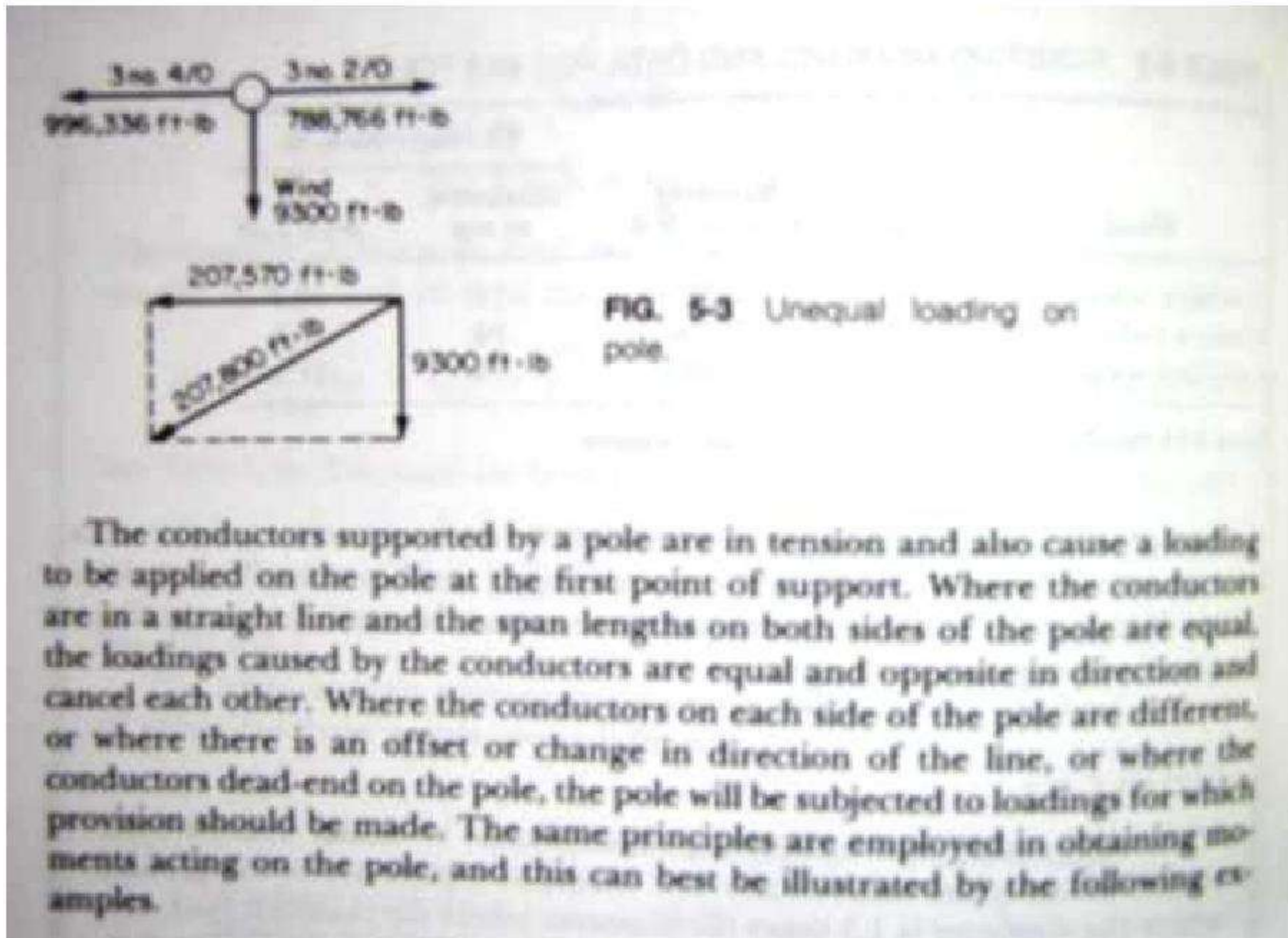

Example 5-4

Assume that the 40-ft pole in Example 5-2 supports three no. 4/0 bare stranded copper conductors in one direction and three no. 2/0 bare stranded copper conductors in the other in a straight line; there are 150 ft spans in both directions. Refer to Fig 5-3

The moment on the pole caused by the wind for the three no. 2/0 conductors is as follows;

$$M = 3 \times \frac{1.418}{12} \times \frac{150}{2} \times 4 \times 34 = 3616 \text{ ft.lb}$$

For the three no. 4/0 conductors (from example 5-2)

$$M = \frac{1}{2} \times 7792 = 3896 \text{ ft.lb}$$

Assume that the ultimate strength of the copper conductors is 37,000 lb in^2 and that they are sagged to one half their ultimate strength. The total moment on the pole caused by conductor tension, for the three no. 2/0 conductors is:

$$M = 3 \times 0.418 \times \frac{37,000}{2} \times 34 = 788766 \text{ ft.lb}$$

For the three no. 4/0 conductors,

$$M = 3 \times 0.528 \times \frac{37,000}{2} \times 34 = 996,336 \text{ ft.lb}$$

Section 2 – Overhead Lines and Installation

The difference between the two is 207,570 ft-lb (say 207,600 ft-lb). The total moment on the pole from the conductor tension and wind is:

$$M = \sqrt{M^2 + M^2} = \sqrt{207.6^2 + 9.3^2} \times 10^2 = 207.8 \times 10^2$$

Multiplied by 2 for a factor of safety, $M = 415.6 \times 10^2$; say 420,000 ft-lb.

To find the pole circumference required to withstand this bending moment, assume $f = 7400 \text{ lb/in}^2$ for long leaf yellow pine:

$$= \sqrt{\frac{3790 \times 420 \times 10^2}{7400}} = 59,91 \text{ in at ground line}$$

This is beyond the strength of a 40-ft pole of the maximum class, 00; a guy should be installed.

Check for the possibility of using a wallaha pole, $f = 11,000 \text{ lb/in}^2$

$$C = \sqrt{\frac{3790 \times 420 \times 10^2}{11,000}} = 52.50 \text{ in at ground line}$$

A 40 ft wallaha pole of maximum class 00 will not accommodate this loading; a guy is still required.

Section 2 – Overhead Lines and Installation

2.4 Determine leading limitation using design schedules and calculations (Part 3)

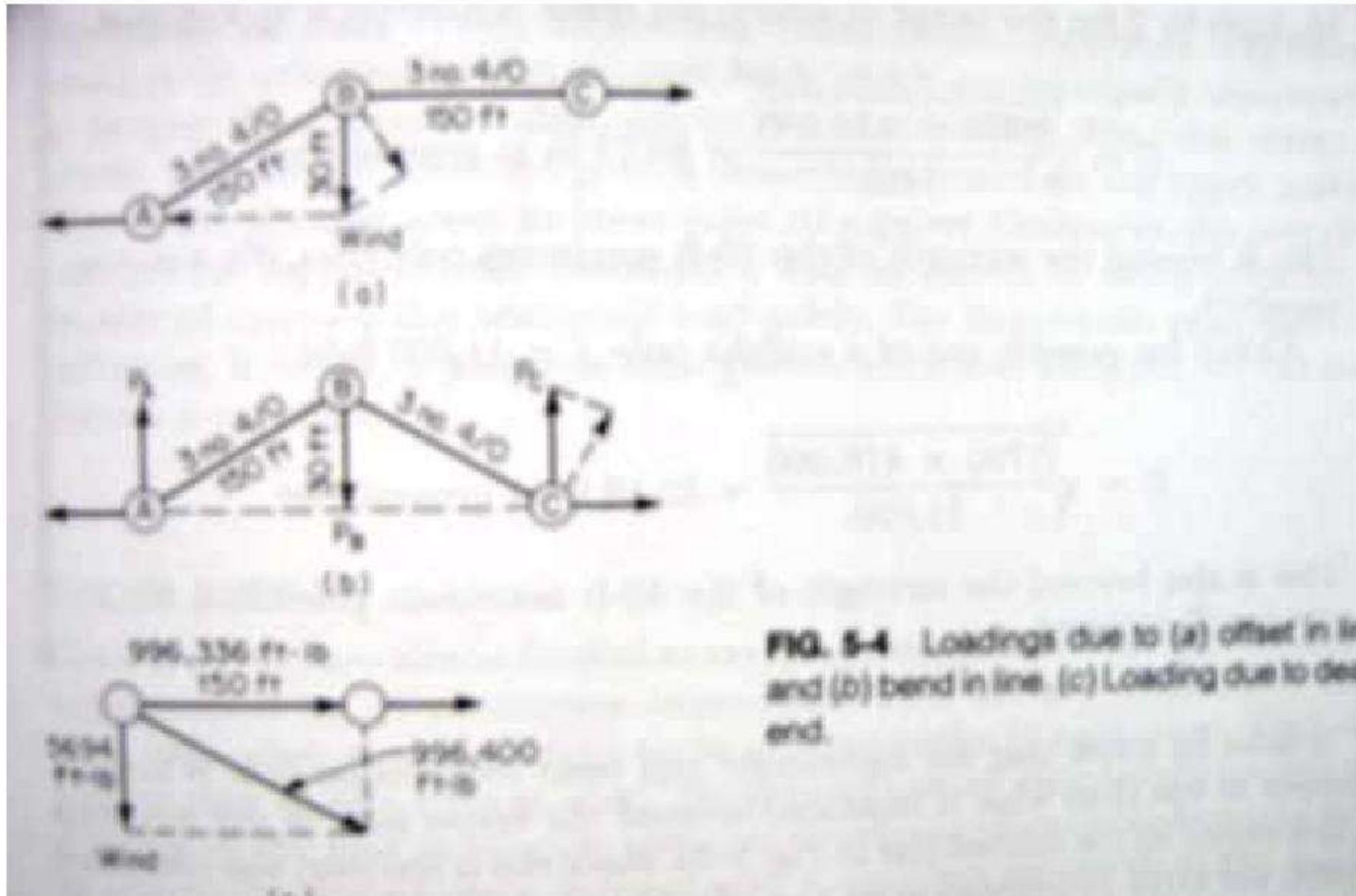

FIG. 5-4 Loadings due to (a) offset in line and (b) bend in line. (c) Loading due to dead end.

Example 5-5

Assume the same 40-ft pole and three no. 4/0 stranded copper conductors level with the top of the pole, with equal 150-ft spans on each side, as in Example 5-2, but with the line offset this time by 30 ft, as shown in Fig 5-4a. The moments on pole B due to the conductors, from Example 5-4, from A toward B, and B toward C, are 996,336 ft-lb, and;

$$X = \sqrt{150^2 - 30^2} = 146.96 \text{ ft}$$

Where X is the portion of the conductors exposed to wind. The moment on pole B, the portion in line with BC, is;

$$M_{BC} = \frac{146.96}{150} \times 996,336 = 97,144 \text{ ft-lb}$$

The moment on pole due to wind for one 150-ft span, from Example 5-4, is 3896 ft-lb, and

$$M_{BX} = 3896 + \frac{146,96}{150} \times 3896 = 7713 \text{ ft-lb}$$

The total moment on pole B, in line, is 996,336 – 976,144, or 20,192 ft-lb. At right angles, it is 199,267 ft-lb, or (30ft = 146,96 ft) x 976,144. The wind moment is 7713 ft-lb, and the total right angle moment is 206,980 ft-lb.

Section 2 – Overhead Lines and Installation

$$M_B = \sqrt{20,192^2 + 206,980^2}$$

Multiply by 2 for the factor of safety; the result is 416,000 ft-lb. For pine.

$$C = \sqrt[2]{\frac{3790 \times 416,000}{7400}} = 59.73 \text{ in at ground line}$$

This is beyond the strength of the 40-ft maximum pole class, 00; a guy is required.

Check for possible use of a wallaha pole, $f = 11,000 \text{ lb/in}^2$

$$C = \sqrt[2]{\frac{3790 \times 416,000}{11,000}} = 52.33 \text{ in at ground line}$$

This is also beyond the strength of the 40-ft maximum pole class, 00; a guy is still required.

Example 5-6

Assume that the 40-ft pole in Example 5-2 supports three no. 4/0 bare stranded copper conductors dead ended on the pole, with a span of 150 ft, as shown in fig. 5-4c.

The moment on the pole due to three no. 4/0 conductors with a 150 ft span, from Example 5-5, is 996,33 ft-lb. The moment on the pole due to wind on the conductors is 3896 ft-lb, and that due to wind on the pole is 1798 ft-lb. The total moment on the pole due to wind is 5694 ft-lb.

$$\text{Total moment on pole} = \sqrt{996.3^2 + 5.694^2} \times 10^2 = 996,316 \text{ ft-lb}$$

Multiply by 2 for a factor of safety:

$$M = 1,992,632 \text{ ft-lb}$$

For pine,

$$C = \sqrt[2]{\frac{3790 \times 1993 \times 10^2}{7400}} = \sqrt[2]{1,020,000} = 100.65 \text{ in}$$

The circumference is much beyond any 40-ft pole, pine or wallaha (from the conclusions in Example 5-5). Guying must be used or other means employed to accommodate the loading safely.

Equipment on Poles

Poles supporting transformers, capacitors, regulators, switches, or other equipment also adds to the wind loading. Since the centre of gravity projects out from the pole, a moment is created on the upper portions of the pole, pivoting about its lower point of support. Ordinarily, the pole class selected for supporting the conductors, with its factors of safety included, is capable of carrying this additional load safely. For the larger scale equipment installations, however, a pole one class greater than that adequate for the conductors is specified.

Section 2 – Overhead Lines and Installation

Cross Arms

Cross arms are now almost limited to carrying polyphase circuits in areas where appearance is not of paramount importance. They are also used where lines cross each other or make abrupt turns at large angles to each other. They are used as alley or side arms in which the greater part of their lengths extends on one side of the pole to provide adequate clearances where pole locations may be affected by limited space rights of way. Cross arms are shown in.

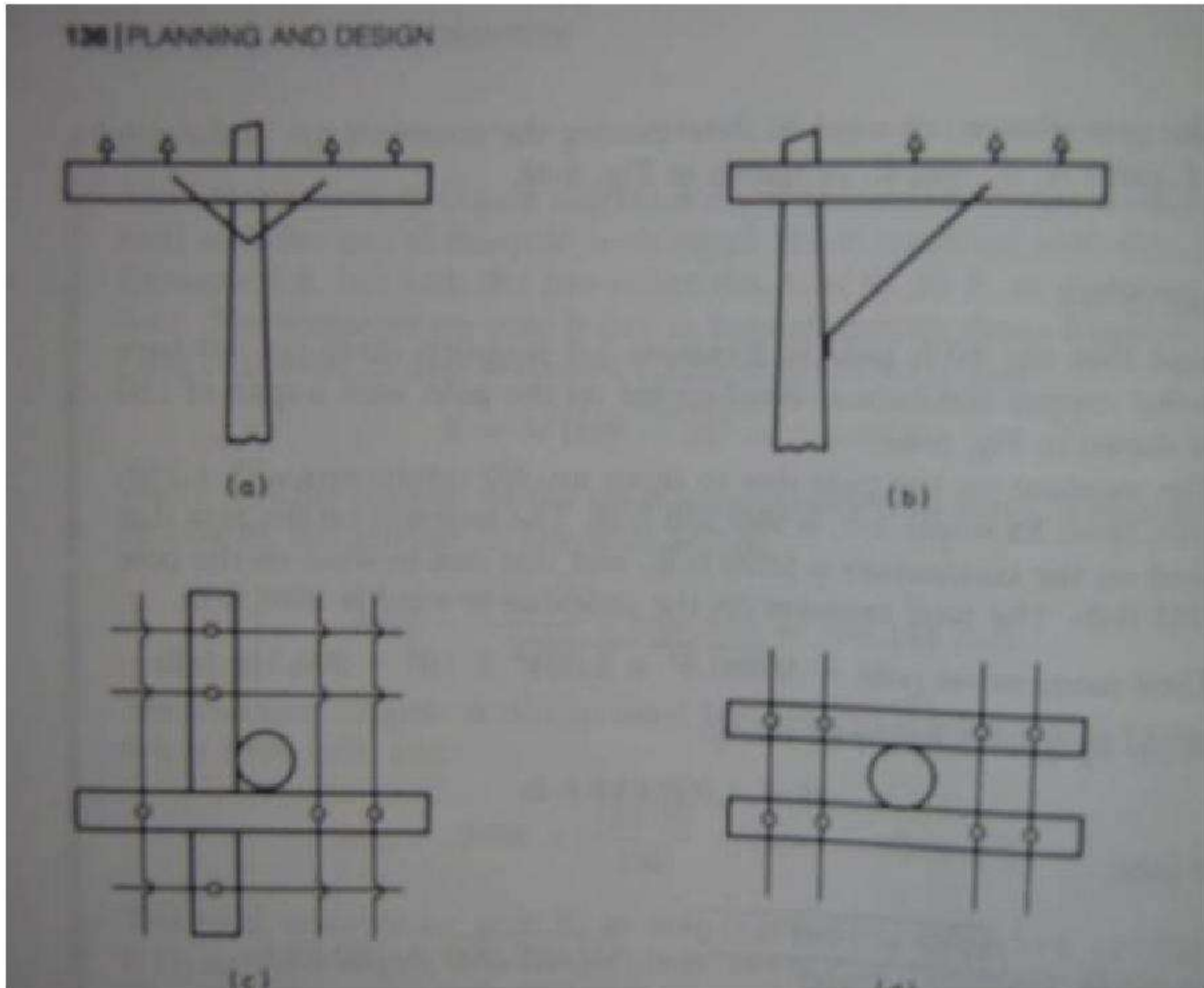

Bending Moment

The total bending moment M is equal to the sum of all the individual loads multiplied by their distances from the cross section under consideration. Ordinarily, the weakest section should be at the middle of the arm where it is attached to the pole. At the pin holes, however, the cross section of the cross arm is reduced and may, under unusual circumstances, be the weakest point in the cross arm. The determination can easily be made by computing unit fibre stress at the several points. Like the pole, the cross arm acts as a beam and the same formula for determining stresses may be employed.

Section 2 – Overhead Lines and Installation

$$f = \frac{M}{I/e}$$

Where f = maximum unit fibre stress occurring at extreme edges of cross section, lb/in^2
 M = total bending moment, in lb
 I = moment of inertia of cross section

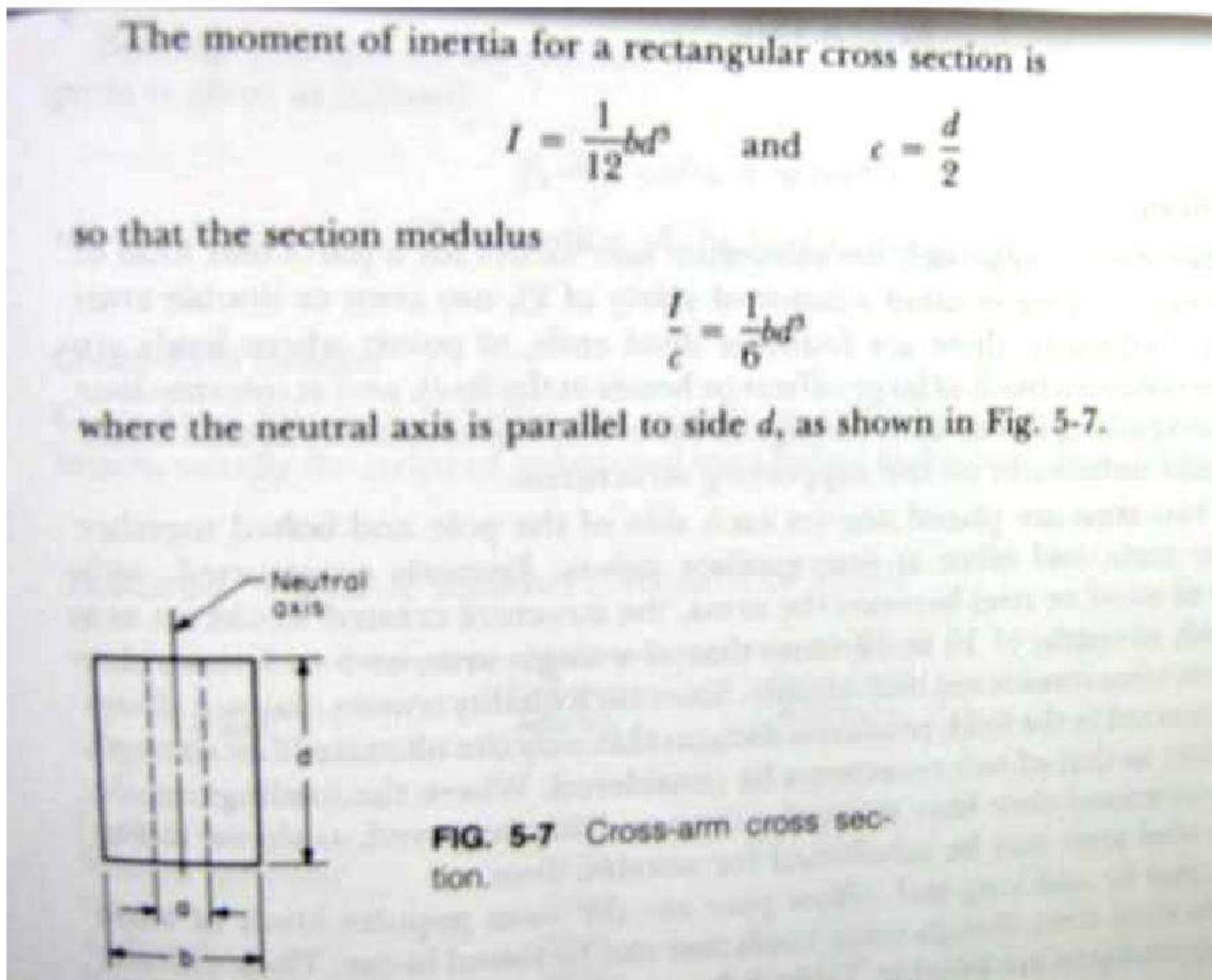

Modulus becomes;

$$\frac{I}{c} = \frac{1}{6}d \left(b^2 - \frac{a^2}{b} \right)$$

Where a is the diameter of the hole.

Example 5-7

Assume a standard 8ft six pin arm mounted at its centre on a pole, supporting six conductors, each of which, with a half inch coating of ice, has a maximum weight of 100 lb. The lengths, or moment arms, from the centre of the arm to each of the pins are respectively 15, 29 1/2, and 44 in.

The moment about the first pin hole from the pole is:

Section 2 – Overhead Lines and Installation

$$M = 100lb \times 14\frac{1}{2}in + 100lb \times 29in = 4350in.lb$$

With the 3 ½ x 4 ½-in cross section reduced by a 1-in pin hole, the section modulus at that point is;

$$\frac{I}{c} = \frac{1}{6}(3.5 - 1.0) \times 4.5^2 = 8.4375$$

And the fibre stress is:

$$f = \frac{M}{I/c} = \frac{4350}{8.4375} = 515.56lb/in^2$$

Double Arms

When fibre stresses approach the maximum safe values for a particular kind of wood (always keeping in mind a factor of safety of 2), two arms or double arms are used. Ordinarily, these are found at dead ends, at points where loads are greatly unbalanced (such as large offsets or bends in the line), and at intermediate points along a long line to limit damage in the event that conductor breaks creating severe load unbalances on the supporting structures.

The two arms are placed one on each side of the pole and bolted together near the ends, and often at intermediate points. Properly constructed, with spacers of wood or steel between the arms, the structure created would act as truss with strengths of 10 to 12 times that of a single arm, or 5 to 6 times that of the two arms considered individually. Since such quality trusses may not always be constructed in the field, prudence dictates that only the ultimate fibre strength equivalent to that of two cross arms be considered. Where the loadings on the arms may exceed their fibre strengths, the arms may be guyed, as shown in Fig 5-8, or steel arms may be substituted for wooden ones.

Douglas fir and long leaf yellow pine are the most popular kinds of wood used for cross arms, though other kinds may also be found in use. Their ultimate bearing strengths are listed in Table 5.3 .

Section 2 – Overhead Lines and Installation

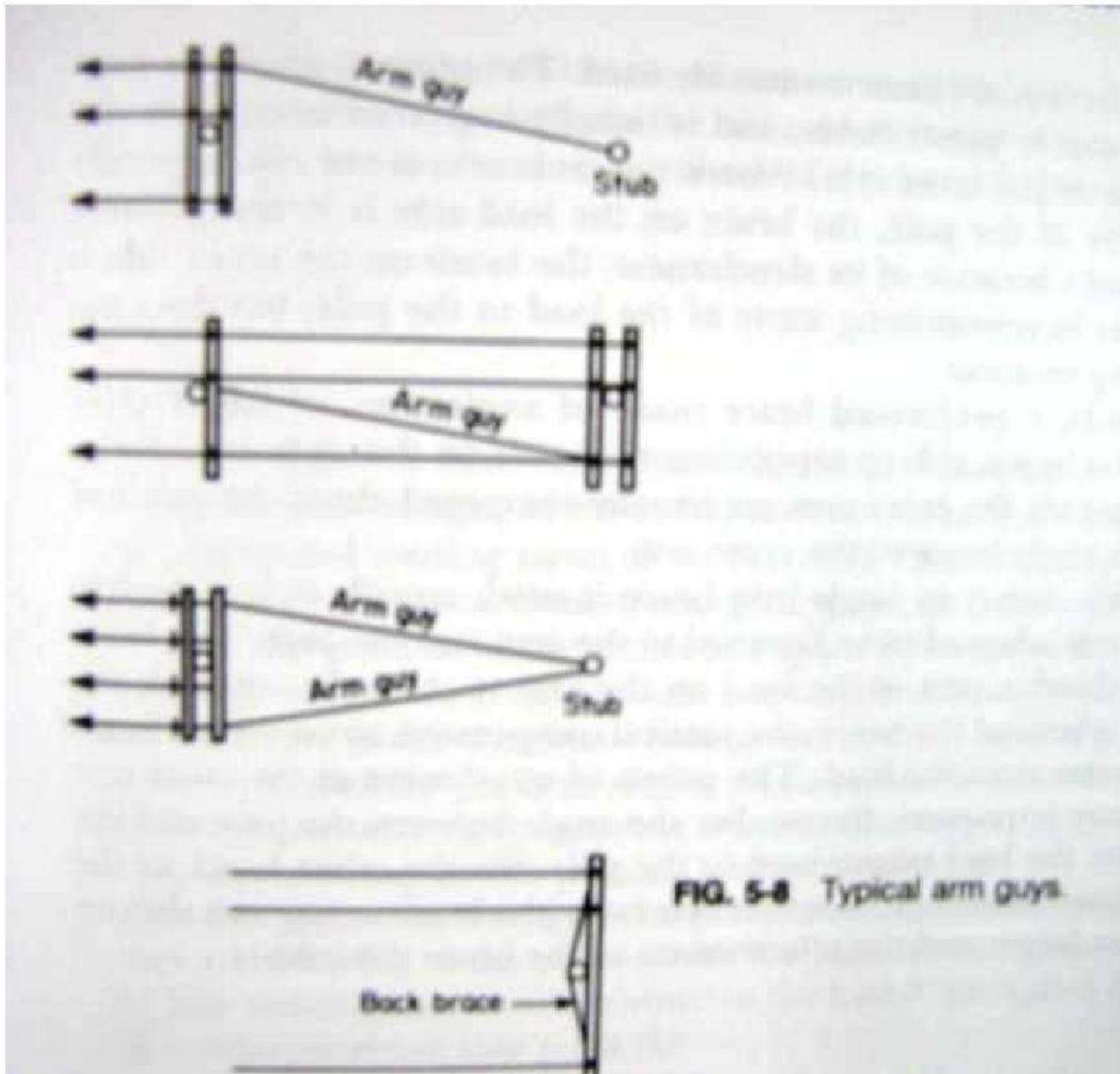

Bearing strength on an inclined surface at an angle to the direction of the grain is given as follows:

$$f_a = f \sin^2 a + n \cos^2 a$$

Where a is the angle of the inclination of the load to the direction of the grain.

Cross Arm Brace

Cross arms fastened to poles are usually steadied in position by braces. Flat braces, usually flat strips of galvanised steel bolted to the cross arm and fastened

Section 2 – Overhead Lines and Installation

Table 5-3 – Ultimate Bearing Strength of Wood

Wood	End-grain bearing f	Cross-grain bearing
Long-leaf Yellow Pine	5000	1000
Douglas Fir	4500	800
Western Red Cedar	3500	700
Cypress	3500	700
Redwood	3500	700
Northern White Cedar	3000	700

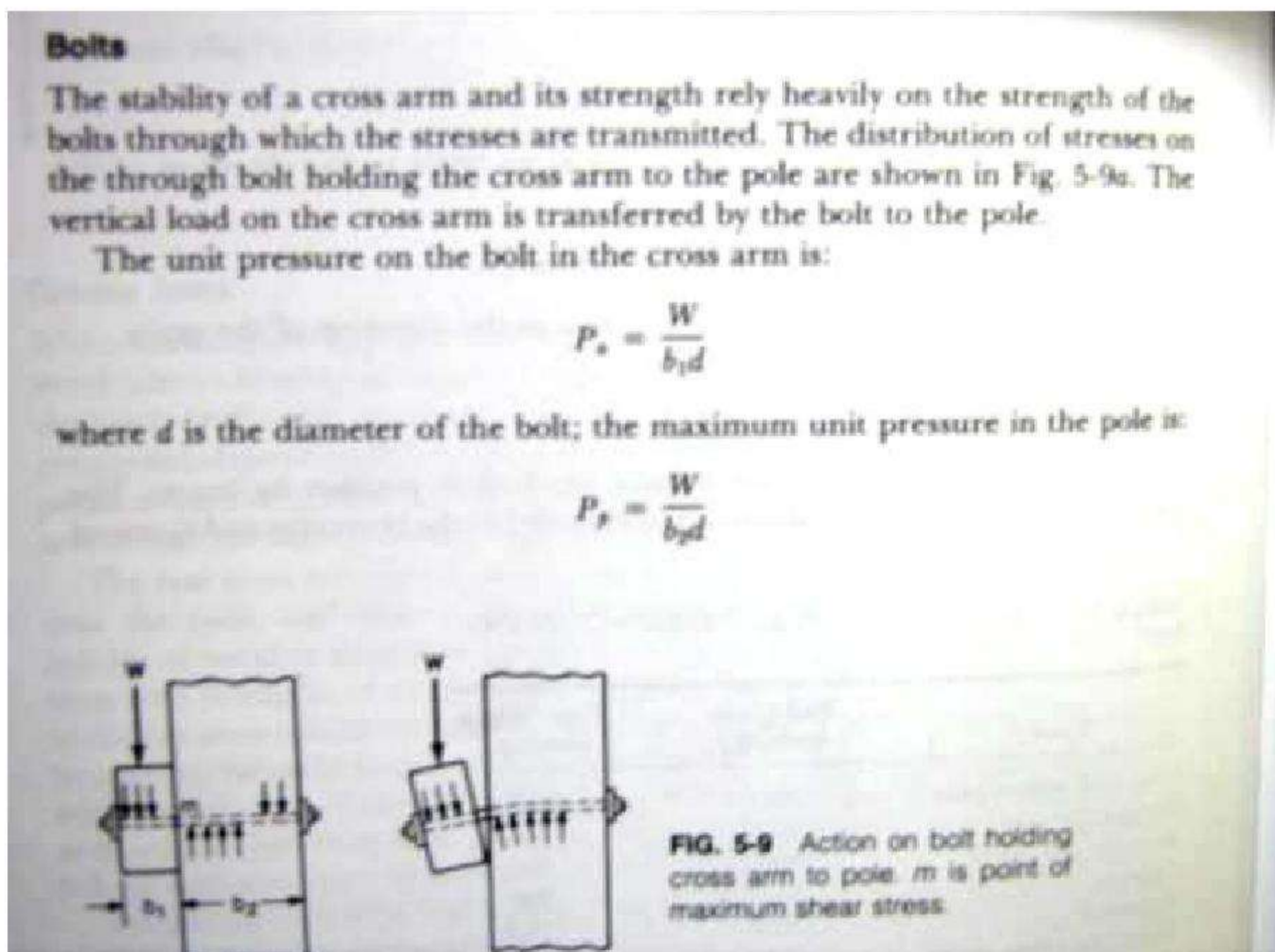

The maximum unit pressure must not exceed the bearing value of the wood, or distortion will take place. As the ultimate strength of the wood is approached, the bolt will tend to bend as the fibres of the wood begin to give way, as shown in Fig.5-9b.

Pins

Loading

Pins are subject to both vertical and horizontal loadings. The vertical loading results from the weight of the conductor and its half inch radial coating of ice. The horizontal loading stems from the wind, from differential tensions in adjacent conductors spans,

Section 2 – Overhead Lines and Installation

from nontangent spans, or from broken wire conditions in which the tensions in the conductor spans become unbalanced.

Under vertical load, the pin acts as a simple column, transmitting its load to the cross arm at the shoulders resting on the cross arm. The stress is equal to the load divided by the area under pressure, the area of the shoulder resting on the cross arm. This component is usually not large compared with the other components acting on the pin and is often neglected.

Under horizontal loadings, the pin acts as a cantilever beam, and the maximum stress occurs at the point where the pin rests on the arm. The bending moment M is equal to the load P multiplied by the distance of the conductor above that point (h):

$$M = Ph$$

The maximum fibre stress is usually considered to be at the point where the shoulder comes in contact with the cross arm. Its unit value, in pounds per square inch, may be calculated.

$$f = \frac{Ph}{0.0982d^2}$$

Where d is the diameter of the shank of the pin.

Since the balancing of moments may occur at the edge of the shoulder of the pin (for either wood or metal) rather than at the edge of the shank of the pin, some crushing effect may take place on the wood of the cross arm, which may affect its strength substantially. In such instances, the weak point may occur at the cross section of the pin above the cross arm; the value may be found by substituting the diameter of the pin at about one third of the distance down from the point of the conductor attachment, approximately the diameter at the weak point.

Double Pins

Double pins, one on each of the double arms, are used where the strength of one pin is inadequate.

Pins in Lieu of Cross Arms

The advent of wye primary systems employing a common neutral with the secondary (situated on the pole in the secondary position) allowed single phase primary conductors to be supported on a steel ridge pin, as shown in Fig 5-11. The vertical loading on the pin, the weight of the ice-coated conductor, is transmitted to the pole through the bolt by which the pin is attached to the pole. Horizontal loadings, from both wind and conductor tension, act on the pin as a cantilever beam, and the same analysis of stresses in the pin, bolt, and pole applies here as with cross arms.

In polyphase systems, the conductors may be supported on pins attached directly to the pole, eliminating the use of cross arms (this method of support is sometimes referred to as "armless construction"). This not only makes for a neater appearance, but, as indicated earlier, improves electrical performance by mitigating the voltage drop due to the reactance of the line. (The arrangement and spacing of the conductors accounts for the lessened reactance. Also, this construction employs bucket trucks or platforms for easier access to the conductors.)

Section 2 – Overhead Lines and Installation

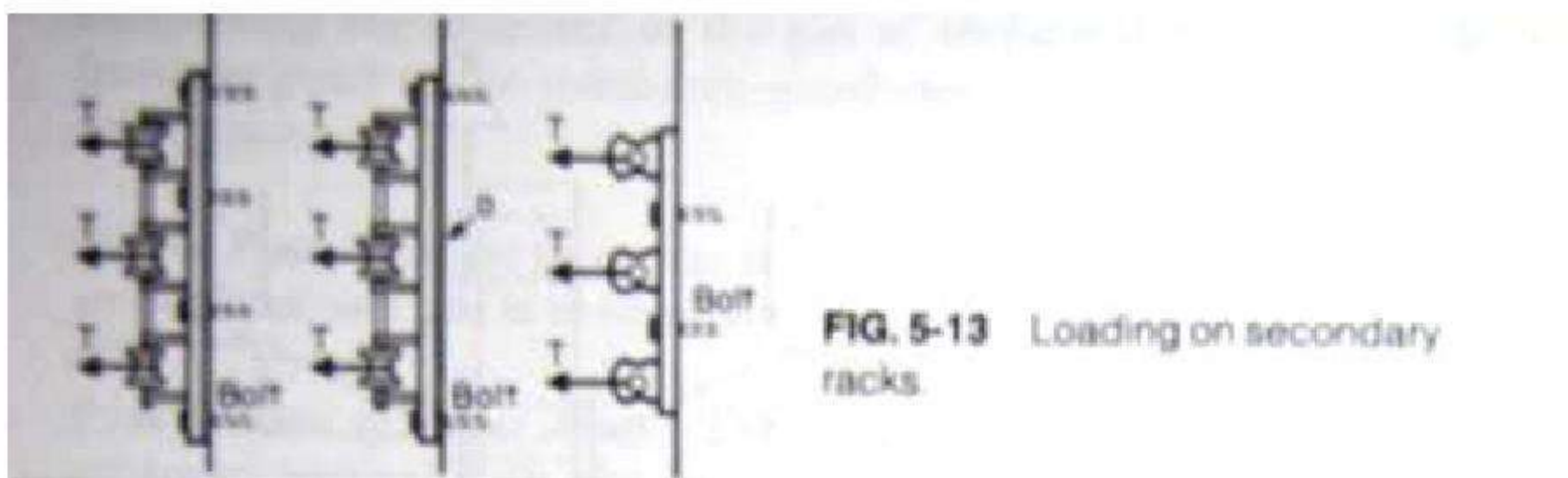
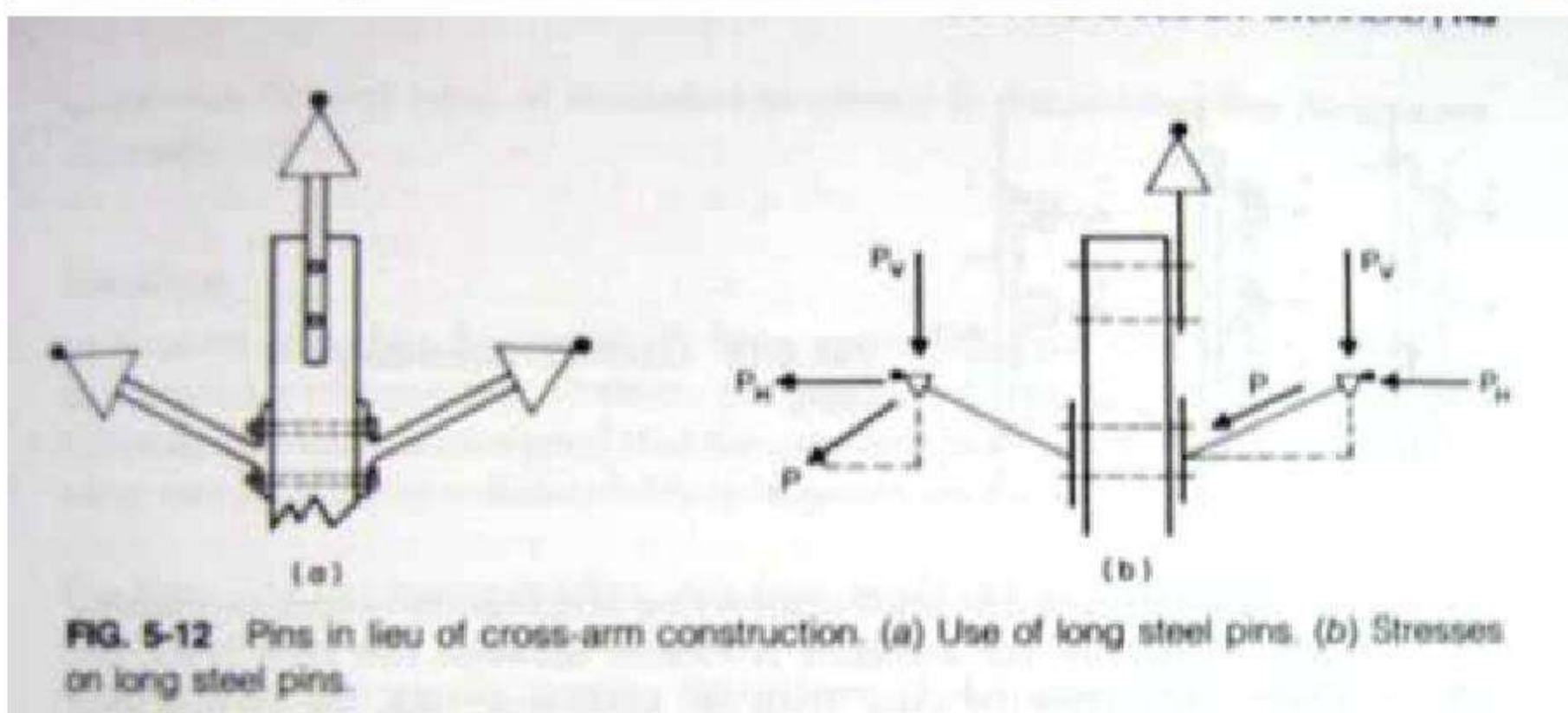
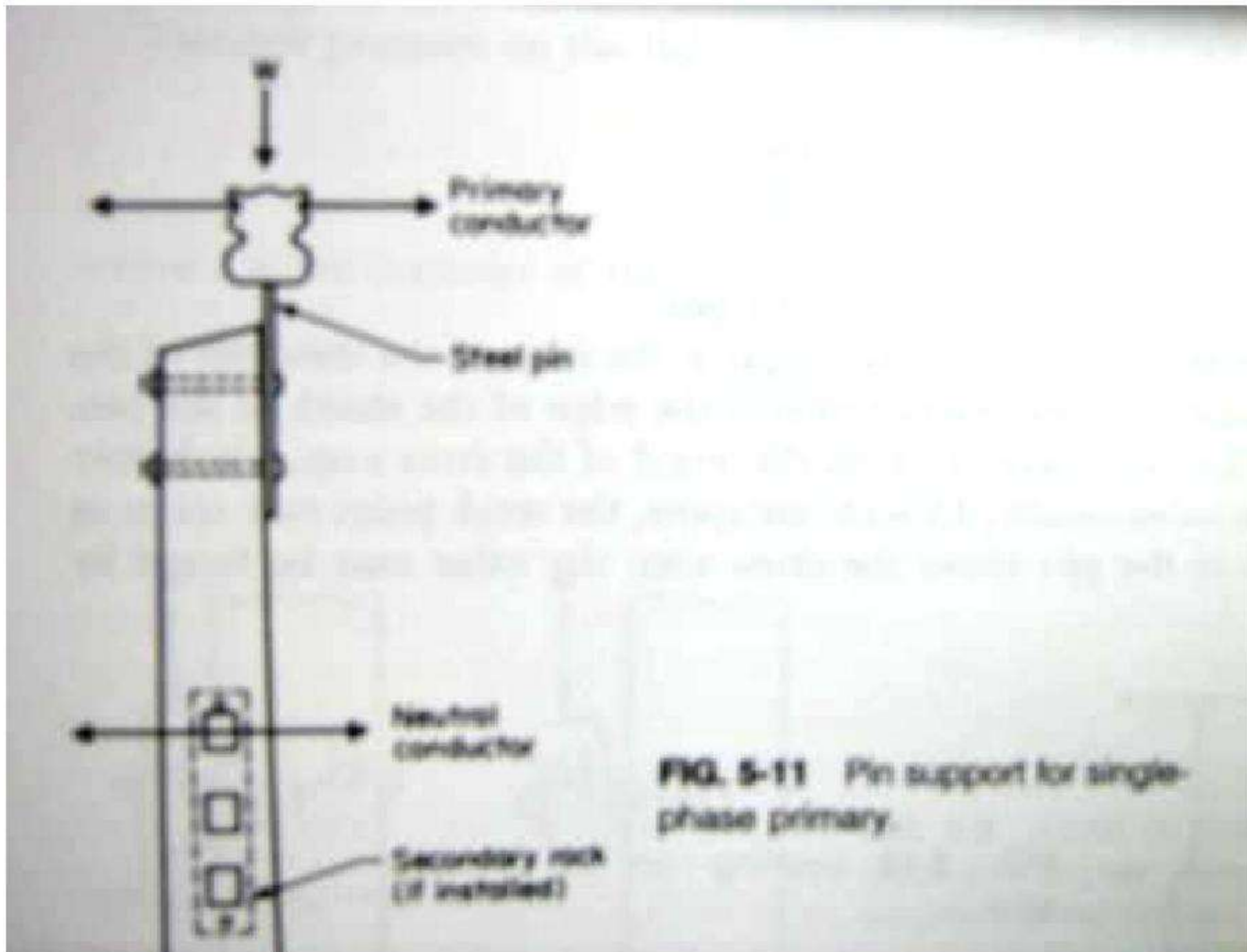

Section 2 – Overhead Lines and Installation

Insulators

Insulators used on overhead distribution systems are made of porcelain, glass, and, more recently, synthetic materials. Glass insulators, though no longer widely installed, exist in abundant numbers and will probably remain in service for.

Loadings

In general, porcelain has relatively little tensile strength but excellent strength in sustaining compressive stresses, properties substantially true also of glass. Lines are therefore so designed that the insulator materials will be in compression when carrying the (mechanical) loads imposed on them.

Pin Type

As the name implies, pin type insulators are mounted on pins (of either wood or metal) and the conductors are fastened to them. Their strengths (in compression) are usually greater than those of the pins upon which they are mounted. The dimensions of the insulating material necessary to meet the mechanical requirements are usually ample in meeting the electrical requirements, including surge voltages when wet.

Post Type

The post type insulator is essentially a pin type insulator that incorporates its own steel pin. Vertical loads are provided for by the porcelain, while horizontal loads act to create a moment about the point of attachment to the pole. Stress is transmitted by its steel core (or pin) to the cross arm or pole.

Suspension or Strain Type

The suspension or strain type insulators are also known as disk or string insulators. They are not generally used on distribution circuits except at turning points and at dead ends, where pins and pin type insulators may not provide sufficient strength; they are particularly useful in providing for the unbalance of stresses caused by broken conductors where pins, and even double pins, may be adequate and some form of insulated clamp or other means of attachment is required. Here the conductors are dead ended on each side of the pole, and the disk insulator, designed for heavy loadings of 10,000 to 20,000 lb (and similar to those used for transmission lines, but smaller in diameter), serves this purpose. Often, two or more such disks are assembled as a unit to accommodate higher operating voltages.

Strain Ball Type

The strain ball type of insulator has been used to dead end lower voltage primary and secondary conductors, and as an insulator in guy wires in older installations; many still exist. Here, the porcelain is under compression, accommodating the stresses imposed on it. Standard ratings include strengths (in compression) of 10,000, 12,000, and 15,000 lbs

Spool Type

Insulators of the spool type are associated with secondary racks, described earlier, and are standardised in design. The compressive strength of the spool porcelain is usually greater than the strength of the other parts of the rack.

Section 2 – Overhead Lines and Installation

Guys and Anchors

Stresses

When the horizontal loads imposed on poles and cross arms may exceed the safe carrying strengths of the wood involved (or holding power of the soil), guys of steel wire are usually installed to take up or counteract the excessive stress. The various types of guys are shown in Fig. 5-15. Note that the guys take up the horizontal stresses and distribute them to the other cross arms, to other poles and into the ground, or directly into the ground. The structural and environmental conditions peculiar to each situation dictate the type of guy used. Fig 5-15

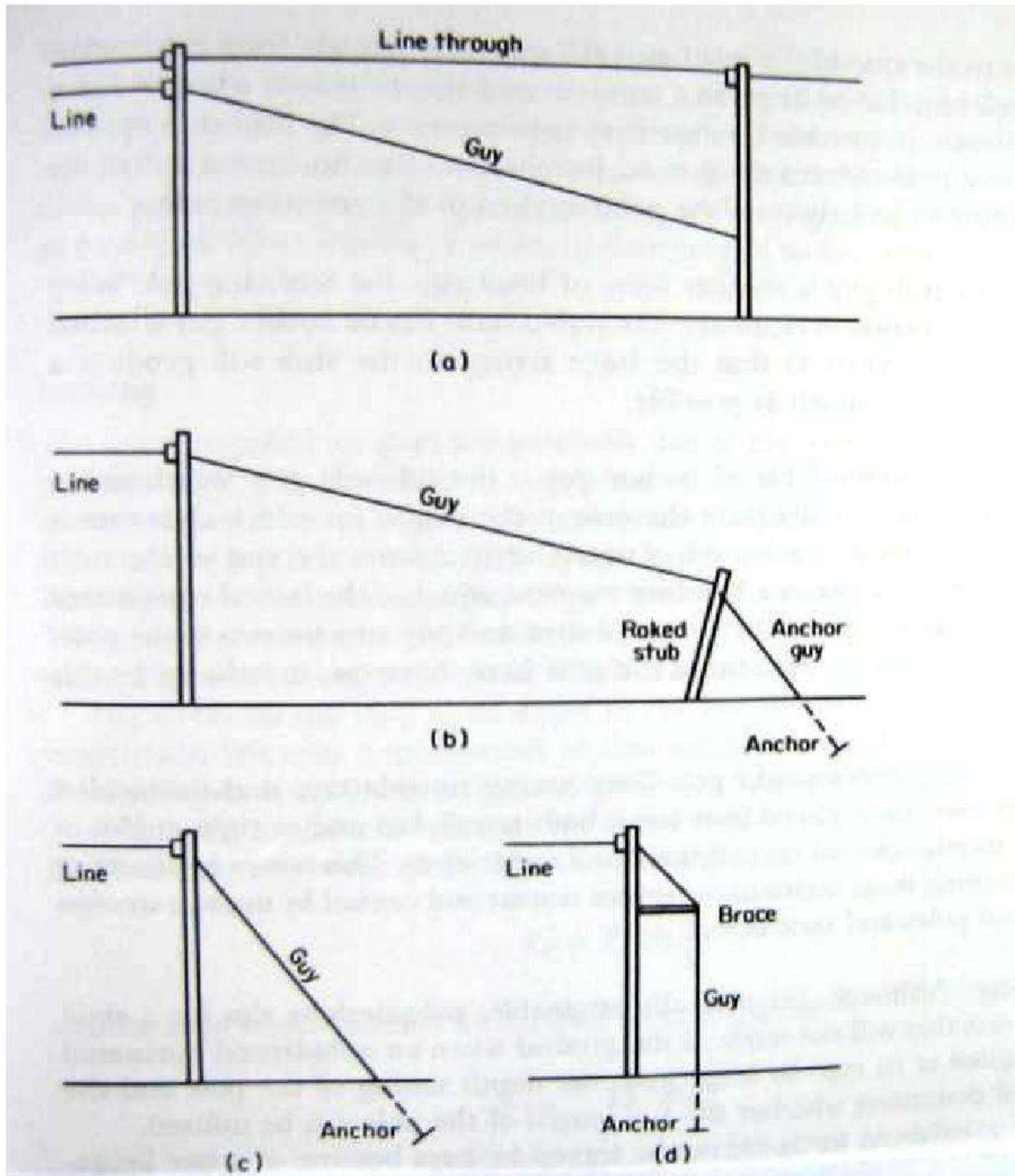

Section 2 – Overhead Lines and Installation

Anchor Guy

The most commonly used guy is the anchor guy, of which one end is fastened to the pole and the other end to a rod to which is attached an anchor that is buried in the ground. The anchor selected depends on the holding power of the soil: from poor in swamps to excellent in hard and dry earth.

Span Guy

In the span guy, the guy wire extends from the head of the pole under load horizontally to an adjacent pole; since this merely transfers the load through the guy wire to the other pole, the receiving pole must be strong enough to take the additional load, or the receiving pole must be guyed.

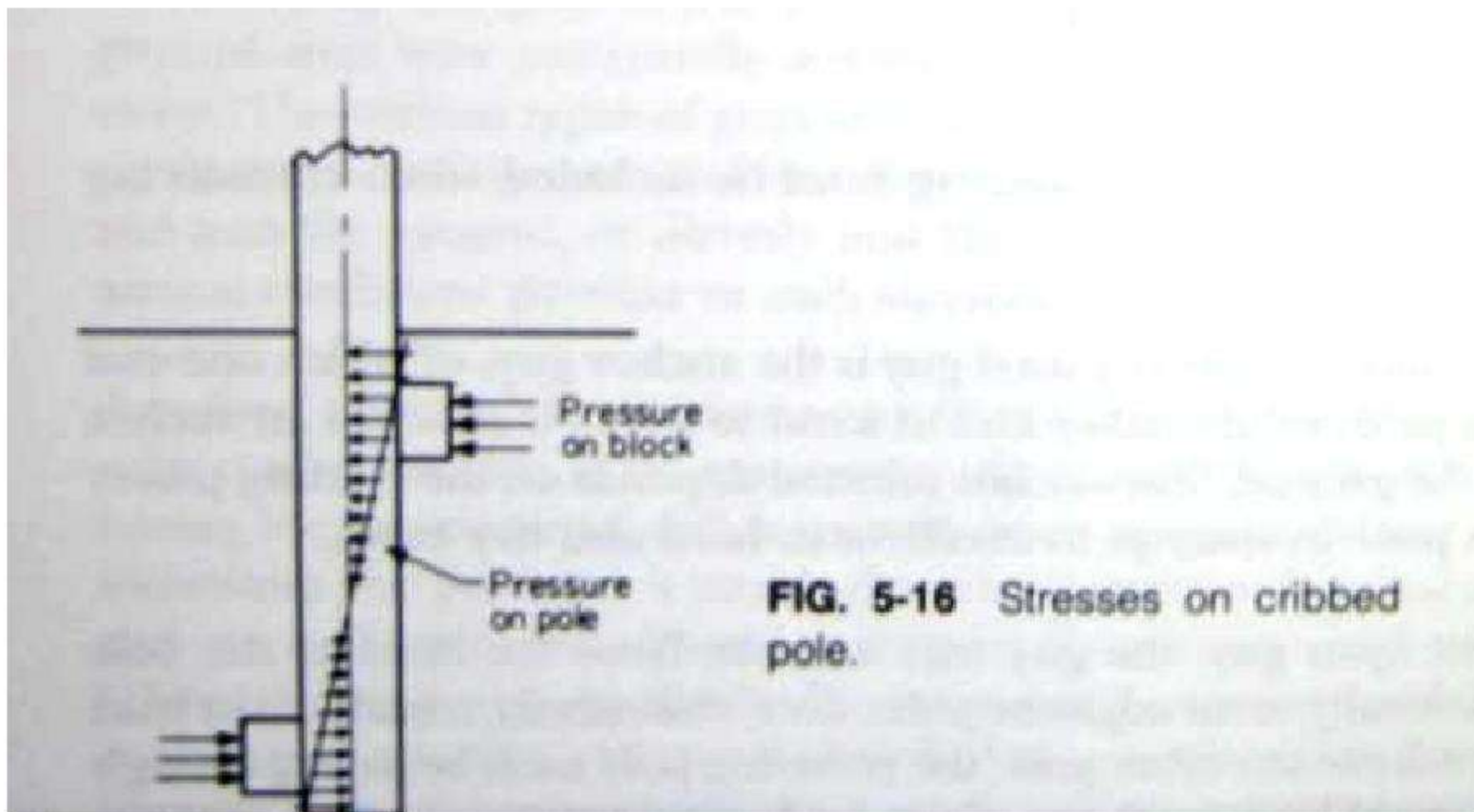

Loading

The loads imposed on guys are generally due to the tension in the conductors and the angle between adjacent conductor spans, if any; the magnitude of the tension depends on the size of the conductor, its loading (including wind and ice), and the sag in the span. The design limits are usually based on the elastic limit of the conductor s (e.g., 50 to 60 percent of the ultimate strength of copper).

The usual stress is generally less than that, as the design limits are based on the worst assumed loading conditions, which are approached only occasionally.

The stress on the pole at an angle in the line is also due to tension in the conductors, but only a component of that tension is handled by the guy; the amount depends on the size of the angle in the line. Refer to Fig. 5-17a.

If T is the total tension caused by all the conductors, and a is the angle of

$$T_a = T \sin \frac{a}{2}$$

And the total stress handled by the guy is twice that, or

Section 2 – Overhead Lines and Installation

$$Ta = 2T \sin \frac{a}{2}$$

If the tensions in the two spans are not balanced, then the resultant stress will be the vector sum of the two, and will be the stress handled by the guy. Wind pressure on the pole itself must also be taken into account in determining the total load to be handled by the guy.

If the angle is large, usually more than 60° , the loading on the guy bisecting the angle will be greater than the dead end loading of the line, and it is generally better to install two guys, considered as dead end guys, if practical.

The guy should be attached as near as practicable to the centre of loading of the loads it supports. Where the individual loads act at different elevations, they should be converted into an equivalent single load at the point of attachment of the guy. If T is the loading (say the primary) at height h , T_2 is the loading (say of the secondary) at height h_2 , P is the wind pressure on the pole assumed to be concentrated at height h , and L is the equivalent horizontal loading.

Fig 5-17a & b

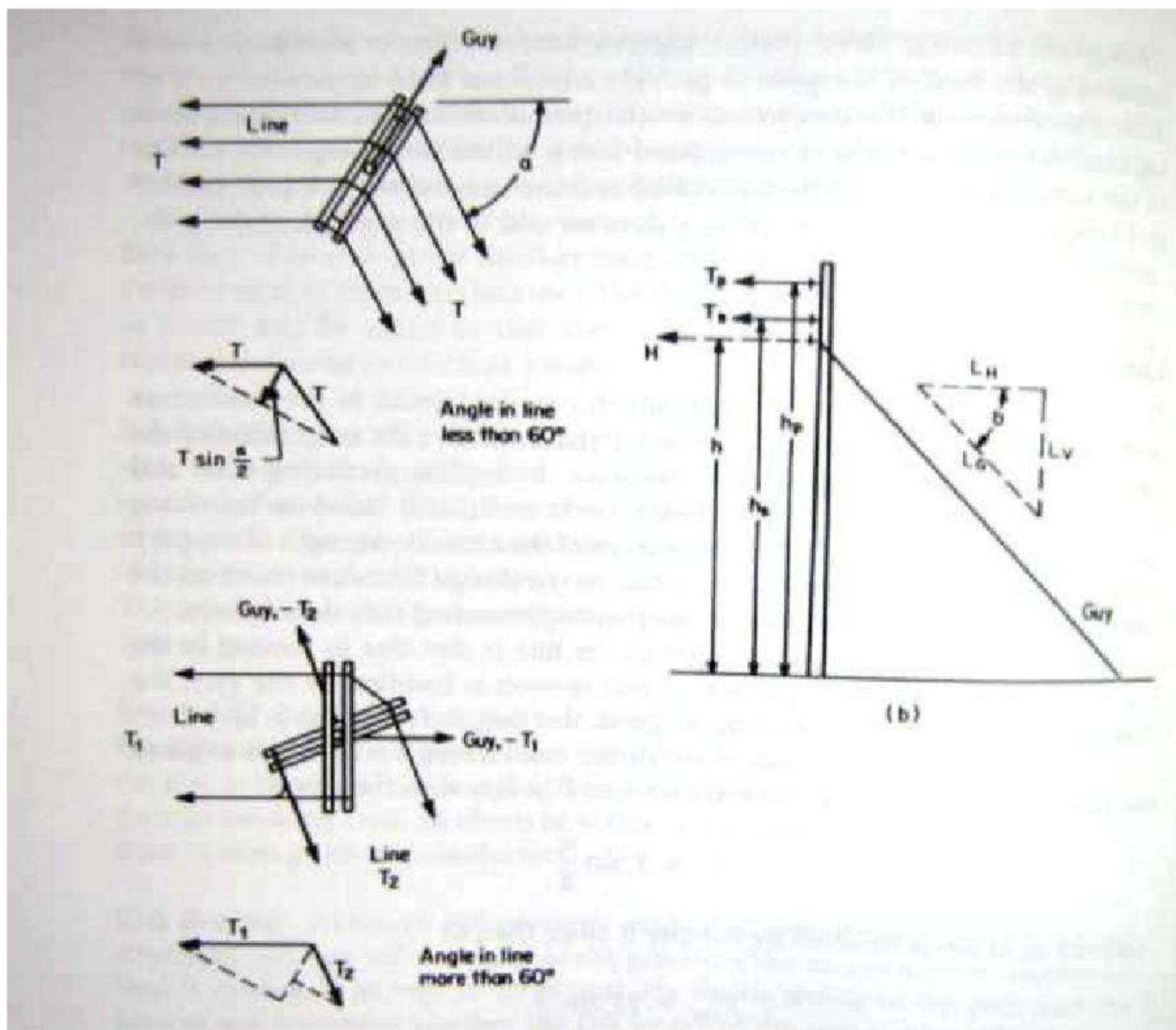

Since the guy is not usually horizontal, the actual tension in it will be greater than L . If b is the angle the guy makes with the horizontal, then the loading in the guy, L is:

$$La = \frac{La}{\cos b}$$

Section 2 – Overhead Lines and Installation

The vertical component L, is:

$$L_x = Ly \tan b \text{ or } L_x + Lc \sin b$$

Assume three no. 4 medium hard drawn copper primary conductors dead ended at the top arm 33 ft above the ground, and 4 no. 2 soft drawn copper cabled secondaries dead ended 2 ft below, or 31 ft above the ground; a pole face area of 25 ft²; and a wind pressure of 4lb/ft² applied one third the distance down from the top arm, or 22 ft above the ground. The guy is attached 30 ft above ground at an angle of 45.

$$T_p = 3 \times 950 = 2850lb$$

$$T_1 = 4 \times 990 = 3960lb$$

$$P_u = 25 \times 4 = 100lb$$

$$L_H = \frac{(2850 \times 33) + (3960 \times 31) + (100 \times 22)}{1} = 7300lb$$

$$L_G = \frac{7300}{\cos 45^\circ} = \frac{7300}{0.707} = 10,325lb$$

If the guy is attached at a point too far from the centre of the load, a significant stress may be imposed on the pole, as the section of the pole above that point acts as a beam, and the moment at that point will be approximately

$$M = T_p(h_p - h) + T_1(h - h) - P_w(h - h_w)$$

And the fibre stress in the pole at the point of attachment of the guy will be

$$f = \frac{M}{0.0982d^3}$$

Where d is the diameter of the pole at this point

Guy Wires

Guy wire is made of stranded steel cable (usually 7 or 19 strands) so that the failure of one or two strands will not cause the immediate failure of the cable. The strands are usually galvanised or copper clad to resist the effects of weather. The strands may be of mild steel or high strength steel, but must be of sufficient strength to support the loads imposed on the guy. Such steel wires usually come in four grades of strength, and standards further specify that guy wires not be stressed beyond 75 percent of their ultimate strengths. Wires are manufactured in diameter differences or steps of $\frac{1}{11}$ in, but sizes less than $\frac{1}{4}$ in or greater than $\frac{1}{2}$ in are seldom, if ever used, two or more guys being employed if stresses greater than the maximum strength of the guy wire are required. In practice, however, only three sizes are usually stocked and specified: light, medium, and heavy. They are often referred to by their maximum permissible strengths, eg 6,000lb, 10,000lb, and 20,000lb (6M, 10M, and 20M)

The characteristics of steel wire used for guys are given in Table 5-4.

Guy wires are attached to poles and cross arms by eye bolts, thimbles, clamps, clips, hooks and plates, and special guy bolts which have the eye shaped and bent at an angle to accommodate the wire.

Section 2 – Overhead Lines and Installation

Wire Class	Ultimate Strength. lb / in^2	Elastic limit lb / in^2
Standard	47,000	24,000
Regular	75,000	38,000
High strength	125,000	69,000
Extra high strength	187,000	112,000

Weight of steel wire: $0.002671 lb / in^2$

Modulus of elasticity: 29×10^2

Coefficient of linear expansion:

Within the $\frac{1}{2}$ to $\frac{1}{4}$ in range, for the four classes of wire, ultimate strengths vary from a minimum of 1,900 lb to a maximum of 27,000 lb

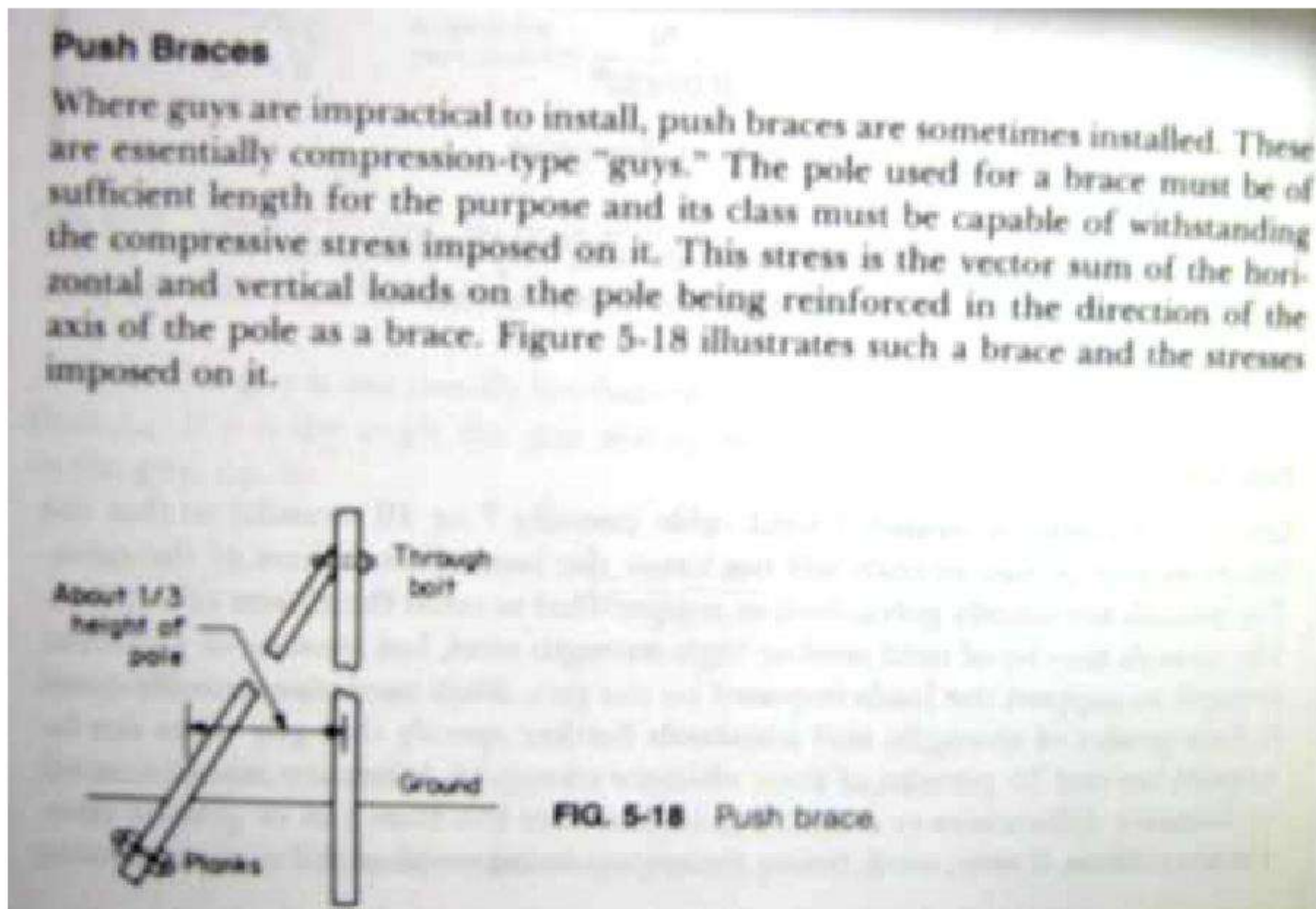

Anchors

The holding power of the anchor should obviously match the strength of its associated guy wire. In general, the holding power will depend on the area the anchor offers the soil, the depth at which it is buried as a function of the weight or resisting force of the soil, and the kind and nature of the soil.

Section 2 – Overhead Lines and Installation

2.4 Determine leading limitation using design schedules and calculations (Part 5)

Table 5-5A Classification of Soils

Class	Description
1	Hard rock; solid
2	Shale, sandstone; solid or in adjacent layers
3	Hard, dry; hardpan, usually found under class 4 strata
4	Crumbly, damp; clay usually predominating. Insufficiently moist to pack into a ball when squeezed by hand
5	Firm, moist; clay usually predominating with other soils commonly present. Sufficiently moist to pack into a firm ball when squeezed by hand (most soils in well drained areas fall into this classification)
6	Plastic, wet; clay usually predominating as in class 5, but because of unfavourable moisture conditions, such as in areas subjected to seasonally heavy rainfall, sufficient water is present to penetrate the soil to appreciable depths and, though the area be fairly well drained, the soil becomes plastic during such seasons, and when squeezed will readily assume any shape (a soil not uncommon in fairly flat areas)
7a	Loose, dry; found in arid regions, sand or gravel usually predominating (filled in or built up areas in dry regions fall into this class, and as the name implies there is very little bond to hold the particles together).
7b	Loose, wet; same as loose, dry for holding power; high in sand, gravel or loam content. Holding power in some seasons is good, but during rainy seasons soil absorbs excessive moisture readily with resultant loss of holding power, especially in poorly drained areas. This class also includes very soft wet clay
8	Swamps and marshes

Type of anchor and rod rise						
Screw		Expanding			Swamp	
Soil class	8 in 1 in x 5.5 ft	Eight way 8 in ½ x 8 ft	Eight way 10 in 1 in x 10 ft	Four way 12 in 1/1/2 in x 10 ft	13 in 2 in pipe	15 in 2 in pipe
1	NR	NR	NR	NR	NR	NR
2	NR	NR	NR	NR	NR	NR
3	NR	26,500	31,000	40,000	NR	NR
4	11,000	22,000	26,500	34,000	NR	NR
5	8,000	18,500	21,000	26,500	NR	NR
6	6,500	13,000	16,500	21,500	NR	NR
7	3,500	10,000	12,000	16,000	NR	NR
8	NR	NR	NR	NR	12,000	13,000

Section 2 – Overhead Lines and Installation

Straightaway Poles

- Step 1. Determine the grade of construction applying, B or C.
- Step 2. Determine the factor of safety required for transverse loading, and calculate the total load on the pole
- For grade B construction, the factor of safety is 4 and the total load is $4(c + d + e + f)$.
 - For grade C construction, the factor of safety is 2 and the total load is $2(c + d + e + f)$.
 - For grade C construction at crossings, the factor of safety is 2.66 and the total load is $2.66(c + d + e + f)$.
- Step 3. Calculate the total ground line moment on the pole by multiplying the total load (step 2) by the average height of the conductors or equipment.
- Step 4. Select the pole class having a ground line resisting moment at least equal to that calculated in step 3.
- Step 5. If the pole is to support equipment, determine the pole class required by the weight of the equipment. If it exceeds that selected in step 4, the larger class should be specified.
- Step 6. If the transverse loading is too great for the unsupported pole, proceed to the section Guying Requirements in this appendix.

Angle Poles

- Step 1. Determine the grade of construction applying.
- Step 2. Determine the factor of safety required for the type of loading, and calculate the total load on the pole
- For grade B construction, the factors of safety are 4 and 2 and the total load is $4(c + d + e + f) + 2b$.
 - For grade C construction, the factors of safety are 2 and 1.33 and the total load is $2(c + d + e + f) + 1.33b$.
 - For grade C construction at crossings, the factors of safety are 2.66 and 1.33 and the total load is $2.66(c + d + e + f) + 1.33b$.
- Step 3. Calculate the total ground line moment on the pole by multiplying the total load (step 2) by the average height of the conductors.
- Step 4. Select the pole class having a ground line resisting moment at least equal to that calculated in step 3
- Step 5. If the pole is to support equipment, determine the pole class required by the weight of the equipment. If it exceeds that calculated in step 4, the larger class should be specified.
- Step 6. If the calculation in step 4 results in a class 5 pole, guying or cribbing will generally not be required unless soil conditions are poor. If the

Section 2 – Overhead Lines and Installation

result is other than class 5, proceed to the section Guying Requirements.

Dead End Poles

- Step 1. Determine the grade of construction applying, B or C
- Step 2. Determine the factors of safety required for dead end loading, and calculate the total load on the pole
 - a. For grade B construction, the factor of safety is 2 and the total load is 2a.
 - b. For grade C construction, the factor of safety is 2 and the total load is 1.33a.
- Step 3. Calculate the total ground line moment on the pole by multiplying the total load (step 2) by the average height of the conductors.
- Step 4. Select the pole class having a ground line resisting moment at least equal to that calculated in step 3
- Step 5. If the pole is to support equipment, from Table 5-18 determine the pole class required by the weight of the equipment. If it exceeds that calculated in step 4, the larger class should be specified.
- Step 6. If the calculation in step 4 results in a class 5 pole, guying or cribbing will generally not be required unless soil conditions are poor. If the result is other than class 5, proceed to the section Guying Requirements.

Guying Requirements

General

Smaller poles may be specified on the assumption they will be used with guying; this is possible because the pole acts as a strut only, the horizontal load being supported by the guy wire. Poles supporting equipment, or placed at a turn angle greater than 10° , however, should not be smaller than class 4.

The steps enumerated above under Pole Class Requirements should cover all extreme cases of transverse or longitudinal loading. If the loading is too great for the unsupported pole, the following additional steps for each classification of pole, designed to determine guying requirements, should be considered.

Straightaway Poles

- Step 7. Determine the factor of safety required for transverse loading, and calculate the total load on the pole.
 - a. For grade B construction, the factor of safety is 2.66 and the total load is 2.66c.
 - b. For grade C construction, the factor of safety is 2 and the total load is 2c
- Step 8. From Table 5-20, calculate the guy tension.

Section 2 – Overhead Lines and Installation

Step 9. From table 5-21 , select the proper guy wire for the tension

Table 5-20 Multipliers for determining tension in guy wire when tension in line wire is known

Applicable to conditions A to D inclusive; see illustrations below

H.	D. ft												
	5	6	7	8	10	12	14	16	18	20	25	30	35
15	3.16	2.69	2.36	2.12	1.80	1.60	1.46	1.37	1.30	1.25	1.16	1.12	1.09
16	3.35	2.85	2.47	2.24	1.89	1.67	1.52	1.41	1.34	1.28	1.19	1.13	1.10
17	3.54	3.00	2.63	2.35	1.97	1.73	1.57	1.46	1.37	1.31	1.21	1.15	1.11
18	3.75	3.16	2.76	2.46	2.06	1.79	1.63	1.50	1.41	1.35	1.23	1.17	1.12
19	3.93	3.32	2.89	2.58	2.15	1.87	1.68	1.55	1.49	1.38	1.26	1.19	1.14
20	4.12	3.48	3.05	2.69	2.24	1.94	1.74	1.60	1.49	1.41	1.28	1.20	1.15
21	4.32	3.64	3.17	2.81	2.33	2.01	1.80	1.65	1.54	1.45	1.31	1.22	1.17
22	4.51	3.80	3.30	2.93	2.42	2.09	1.86	1.70	1.58	1.49	1.33	1.24	1.18
23	4.71	3.96	3.44	3.04	2.51	2.16	1.92	1.75	1.62	1.52	1.36	1.26	1.20
24	4.90	4.12	3.57	3.16	2.60	2.24	1.98	1.80	1.67	1.56	1.39	1.28	1.21
25	5.10	4.28	3.71	3.28	2.69	2.31	2.04	1.85	1.71	1.60	1.41	1.30	1.23
26	5.529	4.45	3.84	3.40	2.79	2.39	2.11	1.91	1.76	1.64	1.44	1.32	1.25
27	5.51	4.62	3.99	3.32	2.88	2.46	2.17	1.96	1.80	1.68	1.47	1.34	1.26
28	5.69	4.78	4.13	3.64	2.97	2.54	2.24	2.01	1.85	1.72	1.50	1.37	1.28
29	5.89	4.94	4.28	3.76	3.07	2.61	2.30	2.06	1.90	1.76	1.53	1.39	1.30
30	6.08	5.09	4.41	3.88	3.16	2.68	2.36	2.12	1.95	1.80	1.54	1.41	1.32
31	6.28	5.26	4.54	4.04	3.26	2.77	2.42	2.18	1.99	1.84	1.59	1.44	1.33
32	6.48	5.42	4.68	4.13	3.36	2.85	2.49	2.24	2.04	1.89	1.62	1.46	1.35
33	6.68	5.59	4.82	4.24	3.45	2.93	2.56	2.29	2.09	1.93	1.65	1.48	1.37
34	6.88	5.75	4.96	4.36	3.54	3.01	2.62	2.34	2.14	1.97	1.69	1.51	1.39
35	7.08	5.92	5.10	4.48	3.64	3.09	2.69	2.40	2.19	2.02	1.72	1.53	1.41
36	7.27	6.08	5.24	4.60	3.74	3.16	2.76	2.46	2.24	2.08	1.75	1.56	1.44
37	7.63	6.28	5.38	4.73	3.85	3.24	2.83	2.52	2.26	2.10	1.79	1.59	1.46
38	7.66	6.40	5.52	4.86	3.93	3.32	2.89	2.58	2.34	2.15	1.82	1.61	1.48
39	7.87	6.59	5.66	4.98	4.03	3.40	2.96	2.64	2.39	2.19	1.85	1.64	1.50
40	8.07	6.74	5.91	5.10	4.12	3.49	3.28	2.69	2.44	2.24	1.89	1.67	1.52

Section 2 – Overhead Lines and Installation

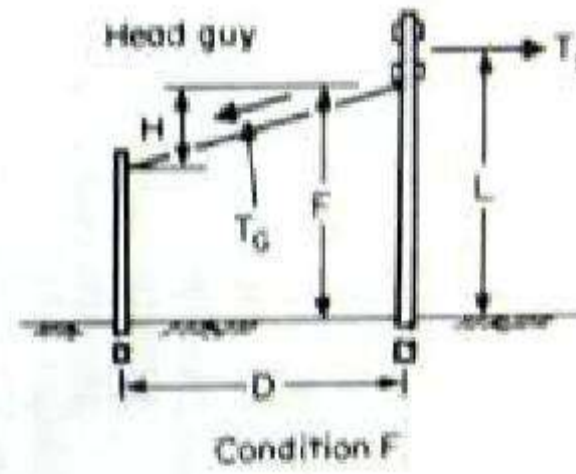
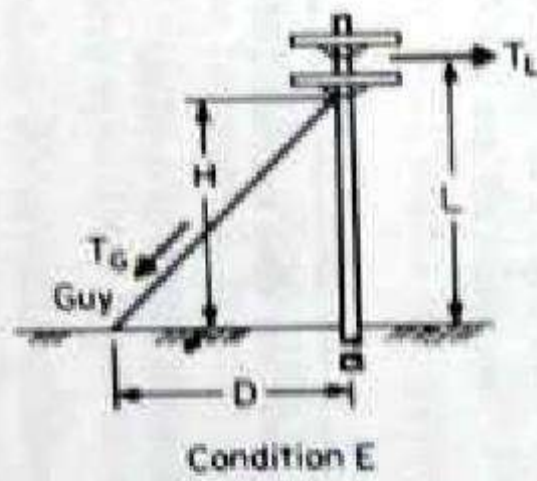
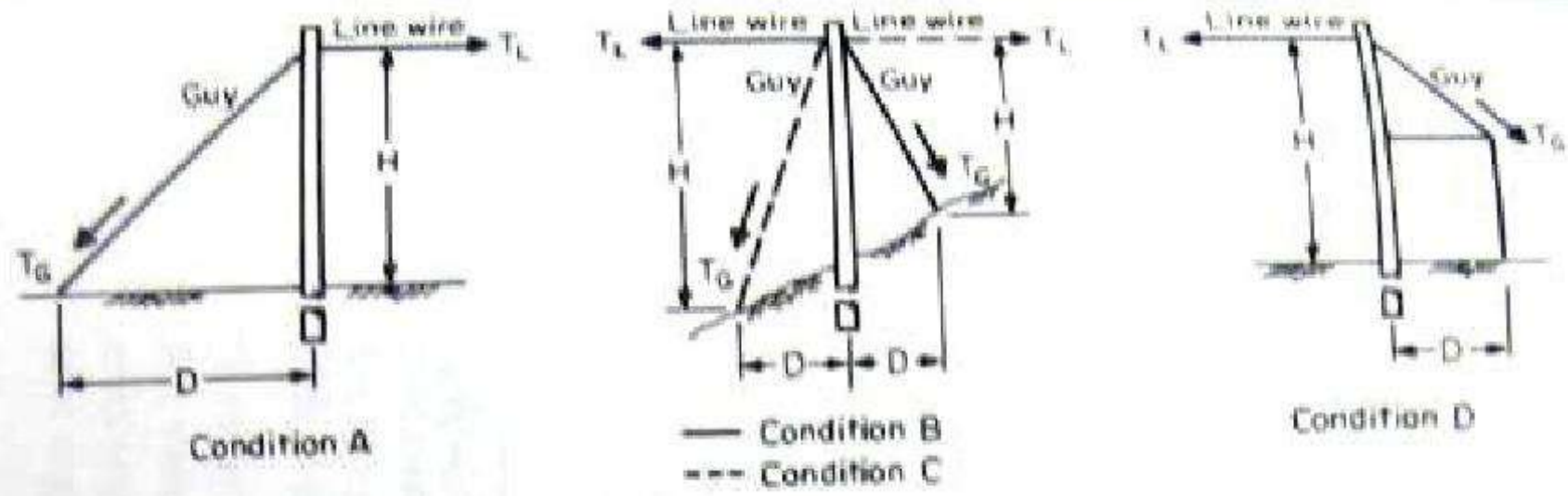

Example:

H = height of guy on pole = 25 ft
 D = distance of guy from centerline of pole = 16 ft
 T_L = tension in line wire = 2000 lb
 T_G = tension in guy wire = $T_L \times$ multiplier (from table)
 $= 2000 \times 1.85 = 3700$ lb

For condition E,

T_G = guy tension
 T_L = resultant line tension
 $T_G = \frac{LT_L D^2 + H^2}{DH}$

For condition F,

T_G = guy tension
 T_L = resultant line tension
 $T_G = \frac{LT_L D^2 + H^2}{FD}$

Section 2 – Overhead Lines and Installation

Table 5-21 Allowable Guy Tensions

Guy Wire			Ultimate strength, lb	Loading, lb			
				Dead end and angle		Transverse	
Material	Reference	Strand		Grade C, SF=1.14	Grade B, SF=1.50	Grade C, SF=2.00	Grade B, SF=2.44
Copperweld	6M	3 #8	6,280	5,500	4,100	3141	2360
	11M	11/32"	11,280	9,860	7,520	5640	4240
	17M	7/16"	7,210	6,330	4,810	3605	2710
Aluminium weld	6M	3 #8	7,210	6,330	4,810	3605	2710
	11M	11/32"	12,960	11,370	8,640	6480	4870
	17M	7/16"	19,060	16,720	12,700	9530	7160

Dead end loadings or 60° angles primary

Copper	Loading, lb	Aluminium	Loading, lb
No.6 bare	640	No.1/0 bare	1200
No.3 bare	1070	No.1/0 HDPE or PVC	1500
No.3 PVC	1230	No.3/0 bare	1450
No.1/0 bare	1550	No.3/0 HDPE or PVC	1800
No.1/0 HDPE or PVC	2000	336,400 cmil bare	2000
No.4/0 bare	1650	336,400 cmil HDPE or PVC	2000

Construction

Concrete Poles

Concrete poles are manufactured in several cross sectional shapes; round, square, and polygons (usually six or eight sides). Moreover, they may be solid or hollow. The method of pouring the hollow poles involves spinning the form while the concrete is being poured, and forcing it to the outside while leaving the centre hollow; the result is a highly uniform, compact, prestressed concrete of high strength and texture.

As concrete has a higher strength under compressive loads than under tensile loads, the overall strength of the concrete poles depends a great deal on the steel reinforcement. Its strength also depends considerably on the mixture of cement and how it is cured.

Where cross arms or other distribution devices and equipment are to be mounted directly on the pole, provision is made for the necessary bolt holes when the concrete is being poured.

Besides their appearance and greater strength, hollow poles provide a means for electrical risers to be installed inside the pole out of sight and not readily accessible to the public. Other advantages claimed include resistance to fire, birds, rot, and vandalism; also the elimination of harm and clothing damage to the public from contact with some wood preservatives. A variety of colours and finishes also is possible with concrete poles; these may contribute to their acceptance.

Section 2 – Overhead Lines and Installation

2.5 State pole and line installation techniques

11.3.2 Structure construction procedures

Each special structure and each special piece of equipment must have a particular established procedure that accounts for the capabilities of the equipment, and the requirements of the task at hand.

An “H” fixture is the principal structure in rural areas for voltages between 115 kV and 50kV. We will use a 230kV “H” structure as an example. The procedure is as follows:

1. All pole framing material must be delivered in the ROW to exact, designated positions.
 2. All structures must be assembled or framed and placed so as to be set without moving the equipment.
 3. All holes are dug.
 4. The setting rig must come by, set the pole and hold it until the tamping or back fill crew can secure it.
-
1. Prepare foundation (types of foundations and methods will follow),
 2. Deliver material to site
 3. Assemble, and
 4. Erect.

11.6.1 Tension definition

The tensions shown in Table 11.1 should be approached as closely as the special conditions will allow in order to reduce the number of structures, but rarely exceeded. There are several conditions at which maximum conductor tension limits are specified.

The initial unloaded tension refers to the state of the conductor when it is initially strung and is under no ice or wind load. After a conductor has been subject to the assumed ice and wind loads, and /or long time creep (the inelastic elongation of a conductor that occurs with time under load), it receives a permanent or inelastic stretch. The tension of the conductor in this state, when it is again unloaded, is called the *final unloaded tension*.

The loaded tension refers to the state of a conductor when it is loaded to the assumed simultaneous ice and wind loading for the National Electrical Safety Code (NESC) loading district concerned.

The vertical load on a conductor is the weight of that span of wire with its ice loading. The horizontal load is the load due to the pressure of the wind. The total loading is the vector sum of both loads. The NESC requires that a constant be added to the vector sum to reach the standard loaded tension as follows;

Section 2 – Overhead Lines and Installation

	Heavy	Medium	Light
Newton/meters	4.4	2.9	0.73
Pounds/foot	0.3	0.20	0.05

Table 11-1

Wire and Temperature Limits for ACSR & 6201 AAAC

A. Temperatures

1. Tension limits 1, 2, and 3 below must be met at the following temperatures:

Heavy loading district	17.8° C	(0° F)
Medium loading district	9.4° C	(15° F)
Light loading	1.1° C	(30° F)

2. Limit 4 must be met at the temperature at which the extreme wind is expected.

3. Limit 5 must be met at 0° C (32° F)

B. Tension Limits in Percent of Conductor Rated Strength

Tension Condition (See text for exp.)	Phase Cond.	OHW High	High
		Strength	Strength
		Steel	Steel
1. Max. initial unloaded	33.30*	25	20
2. Max. final unloaded	25.00†	25	20
3. Standard loaded (usually NESC district loading)	50.00	50	50
4. Max. extreme wind (A)	70.00⊕	80	80
5. Max. extreme ice (A)	70.00	80	80

NOTE: (A) These limits are for tension only. When conductor stringing sags are to be determined, limits 1, 2, and 3 should be considered as long as tensions at conditions 4 and 5 are satisfactory.

NOTE: Tension limits do not apply for self damping and other special conductors

* In areas prone to vibration, a value of approximately 20 percent of the average annual maximum temperature is recommended if vibration dampers or other means of controlling vibration are not used.

† For 6201 AAC, a value of 20 percent is recommended.

⊕ For ACSR only, 6201 aluminium use 60 percent.

Line Planning

The steps for planning the construction of a transmission line are discussed in the following section.

Section 2 – Overhead Lines and Installation

11.10.1 Plan-profile Drawings

Plan-profile drawings that show a topographical contour map of the terrain along and near the ROW, and a side view profile of the line, showing elevation and towers. Figure 11.6 shows a section of a plan-profile drawing.

The transmission line plan-profile drawings serve as a worksheet, and eventually an expository sheet, which shows what, is to be done and the problems involved. Initially, the drawings are prepared based on a route survey showing land ownership, the locations and elevations of all natural and man made features to be crossed or that are adjacent to the proposed line (all affect ROW), line design, and construction. The drawings are then used to complete line design work such as structure spotting. During material procurement and construction, the drawings are used to control purchase of materials and serve as construction specification drawings. After construction, the final plan-profile drawings become the permanent record of property and ROW data, which is useful in line operation and maintenance, and in planning future modifications.

Beginning with the initial preparation, accuracy, clarity, and completeness of the drawings should be maintained to ensure economical design and correct construction. All revisions made subsequent to initial preparation and transmittal of the drawings should be noted in the revision block by date and with a brief description of the revision.

Drawing preparation begins with an aerial survey followed by a ground check. The proper translation of these data to the plan-profile drawings is critical. Errors that occur during this initial stage affect line design because a graphical method is used to locate the structures and conductor. The final field check of the structure site should reveal any error. Normally, plan-profile sheets are prepared using a scale of 200 feet to the inch horizontally and 20 feet to the inch vertically. On this scale, each sheet of plan-profile can conveniently accommodate about 1 mile of line with enough overlap to connect the end span on adjacent sheets.

The sample format for a plan-profile drawing is shown by Figure 11.6 with units and stations in customary United States units. Increase in station and structure numbering usually proceeds from left to right with the profile and corresponding plan view on the same sheet.

Existing features to be crossed by the transmission line, including the height and position of power and communication line, including the height and position of power and communication lines, should be shown and noted by station and description in both the plan and profile views. The magnitude and direction of all deflection angles in the line should be given and referenced by P.I. station in plan and elevation.

Section 2 – Overhead Lines and Installation

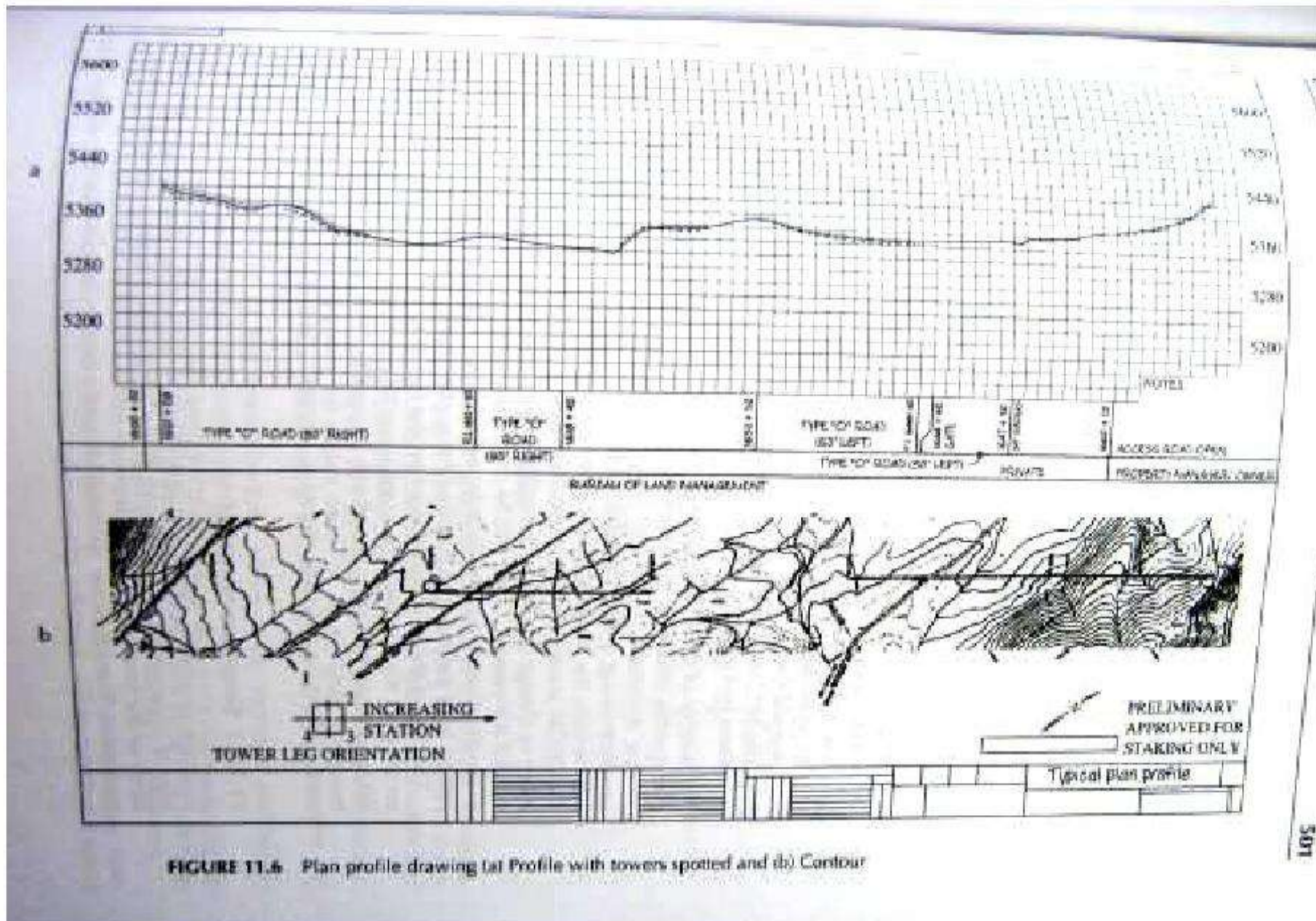

FIGURE 11.6 Plan profile drawing (a) Profile with towers spotted and (b) Contour

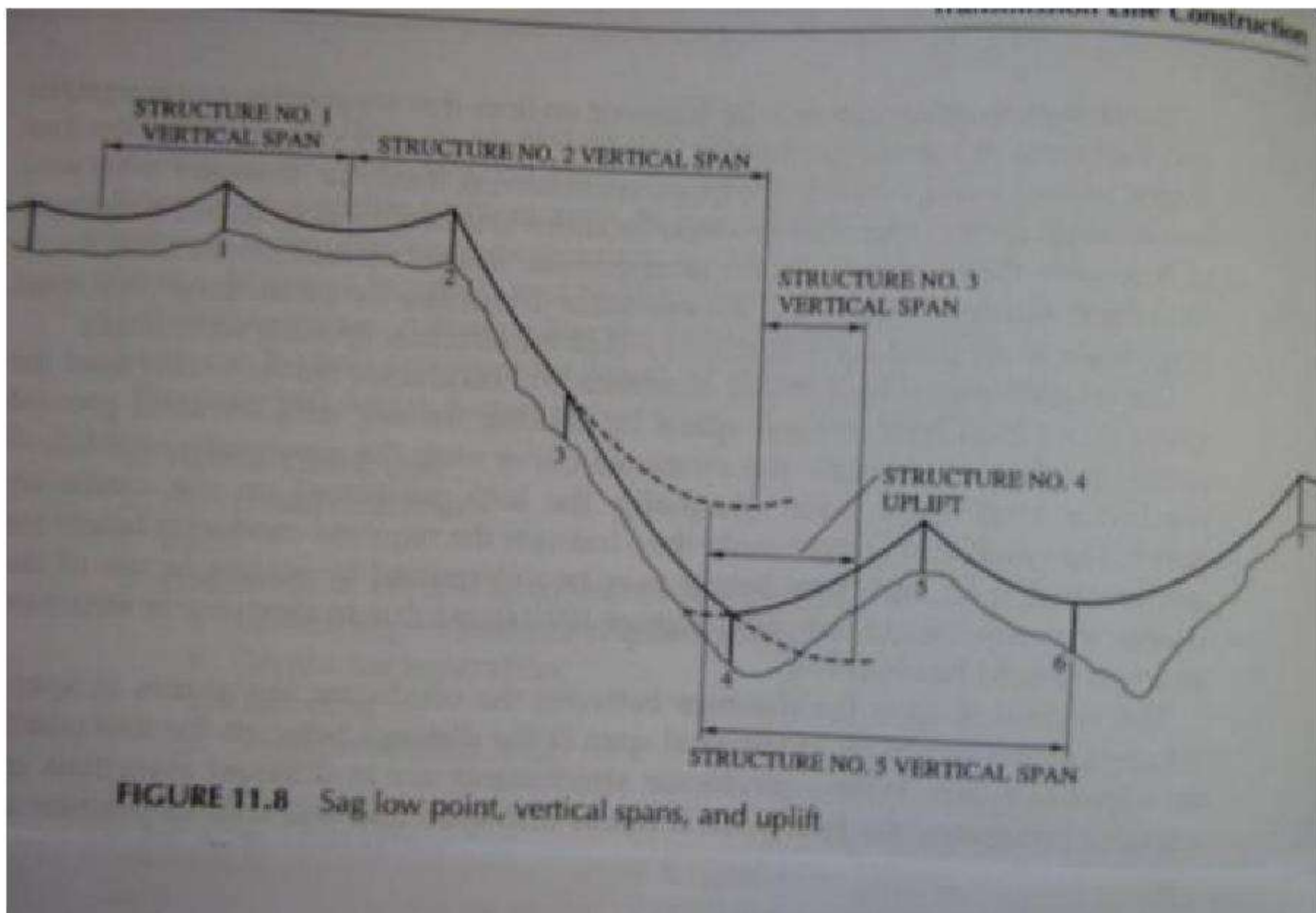

FIGURE 11.8 Sag low point, vertical spans, and uplift

Section 2 – Overhead Lines and Installation

A rapid method to determine uplift is shown by Figure 11.8. There is no danger of uplift if the cold curve passes below the point of conductor support on a given structure with the curve on the point of conductor support at the two adjacent structures.

Designing for uplift or minimising its effects is similar to the corrective measures listed for excessive insulator swing, except that adding excessive weights should be avoided. Double dead-ends and certain angle structures can have uplift as long as the total force of uplift does not approach the structure weight. If it does, hold-down guys are necessary. Care should be exercised to avoid locating structures resulting in poor line grading.

11.10.7 Final Drawings

The conductor and ground wire sizes, design tensions, ruling span, and the design loading condition should be shown on the first sheet of the plan-profile drawings. A copy of the sag template should be shown. The actual ruling spans between dead ends should be calculated and noted on the sheets.

As conductor sags and structures are spotted on each profile sheet, the structure locations are marked on the plan view and examined to ensure that the locations are satisfactory and do not conflict with existing features or obstructions. To facilitate preparation of a structure list and the tabulation of the number of construction units, the following items, where required, should be indicated at each structure station in the profile view:

1. Structure type designation
2. Pole height and class or height of tower
3. Pole top, cross arm, or brace assemblies



Section 2 – Overhead Lines and Installation

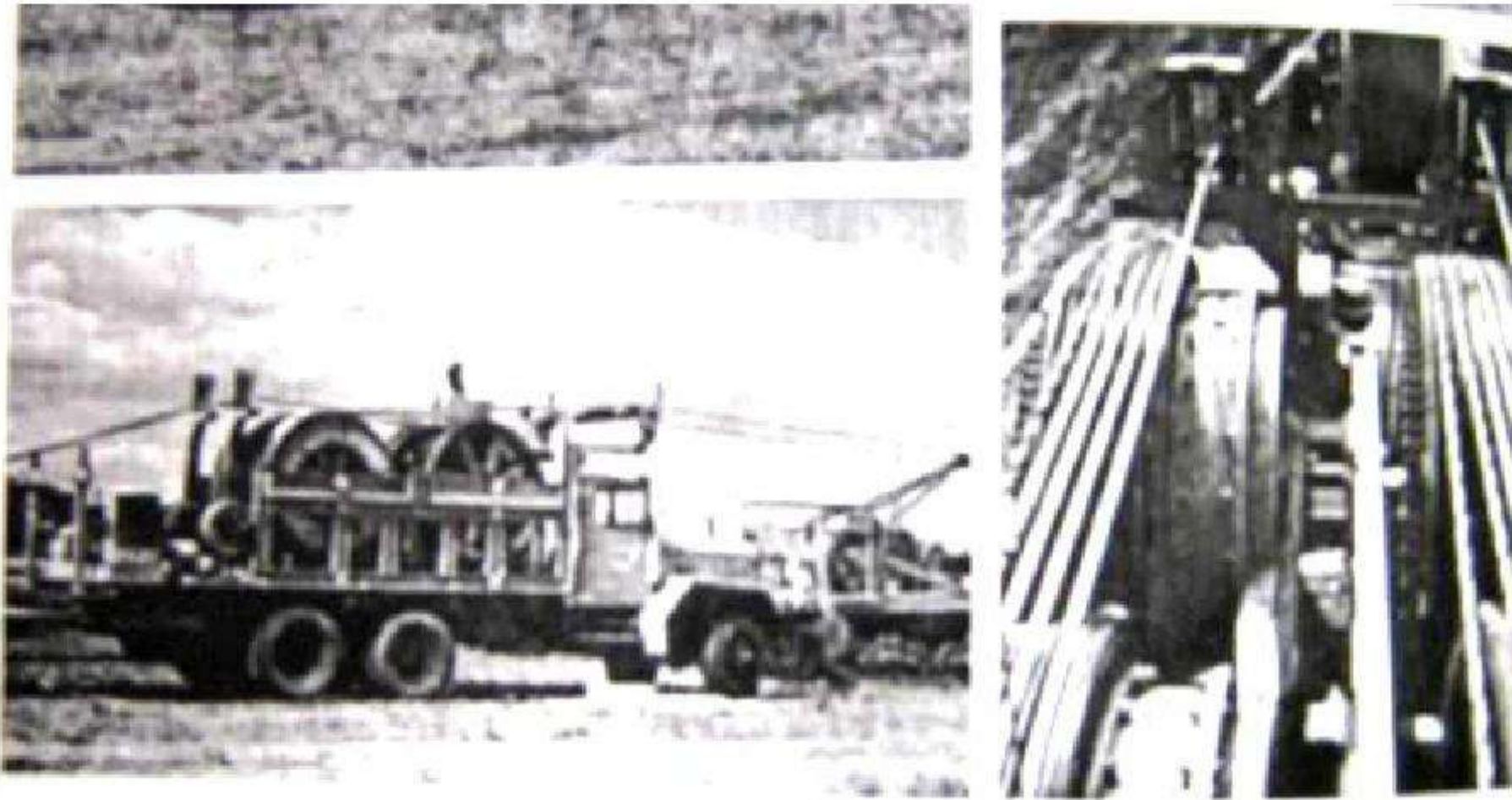

FIGURE 11.13 Views of a tensioner for bundles of two stringing

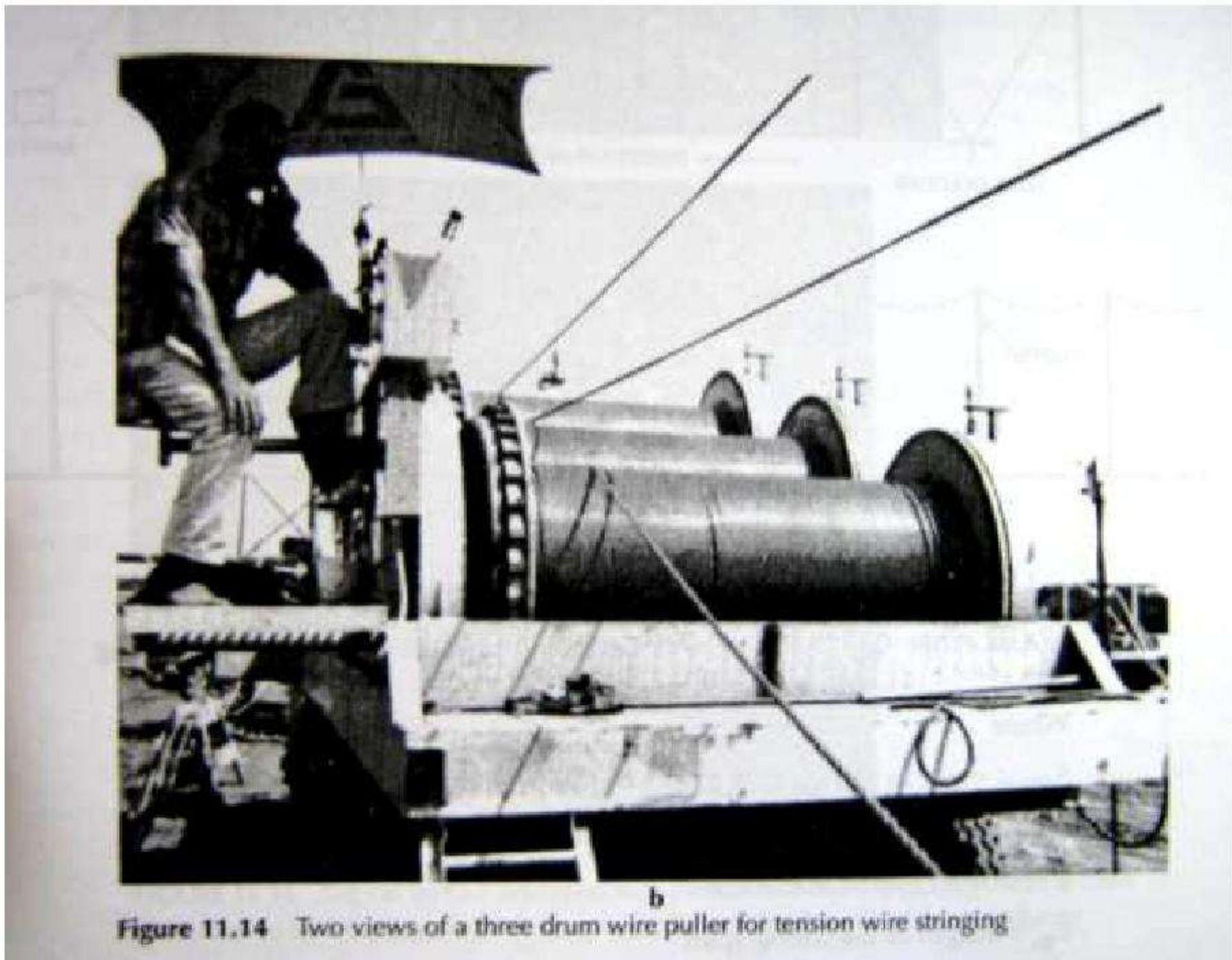
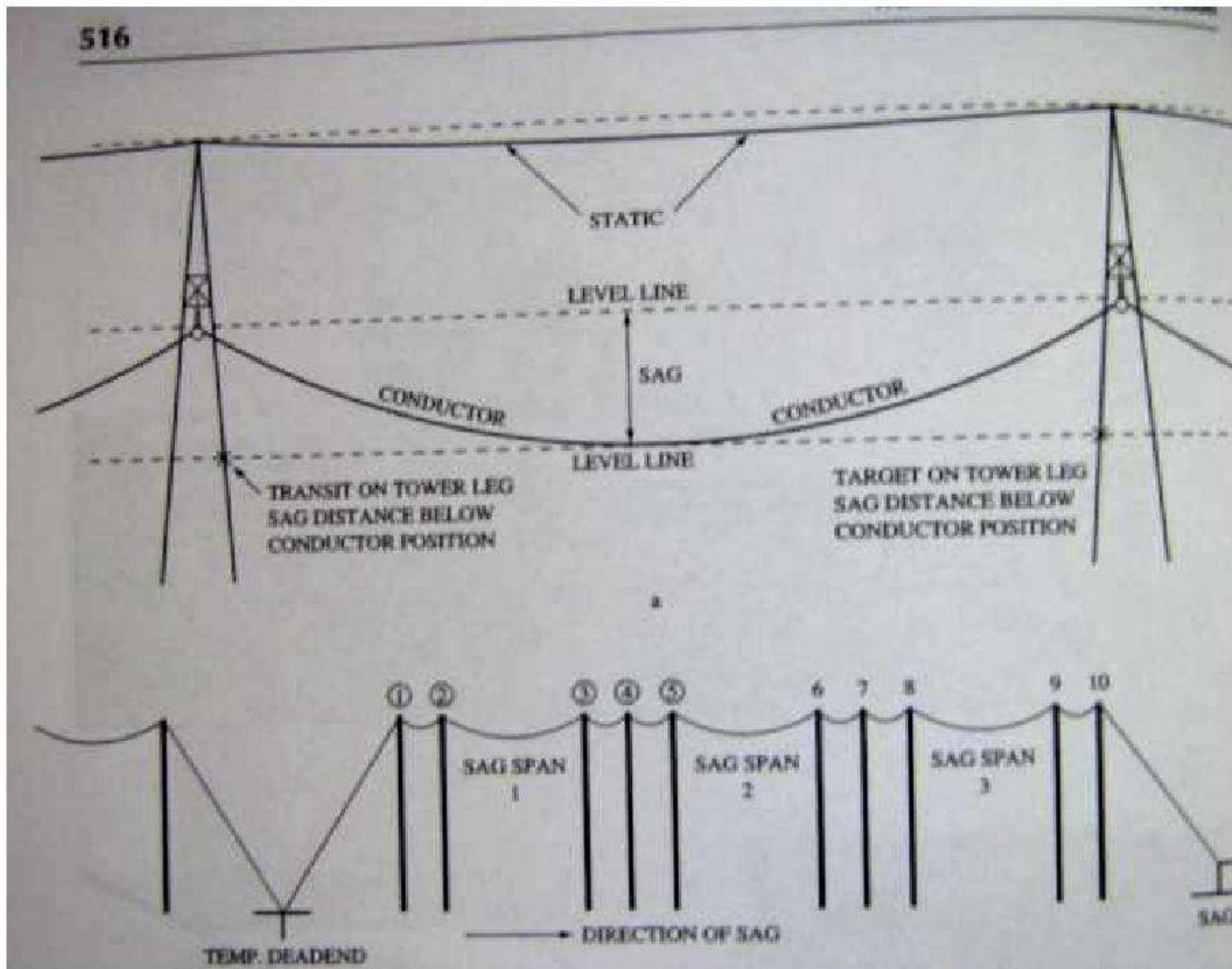

Figure 11.14 Two views of a three drum wire puller for tension wire stringing

Section 2 – Overhead Lines and Installation



Section 2 – Overhead Lines and Installation

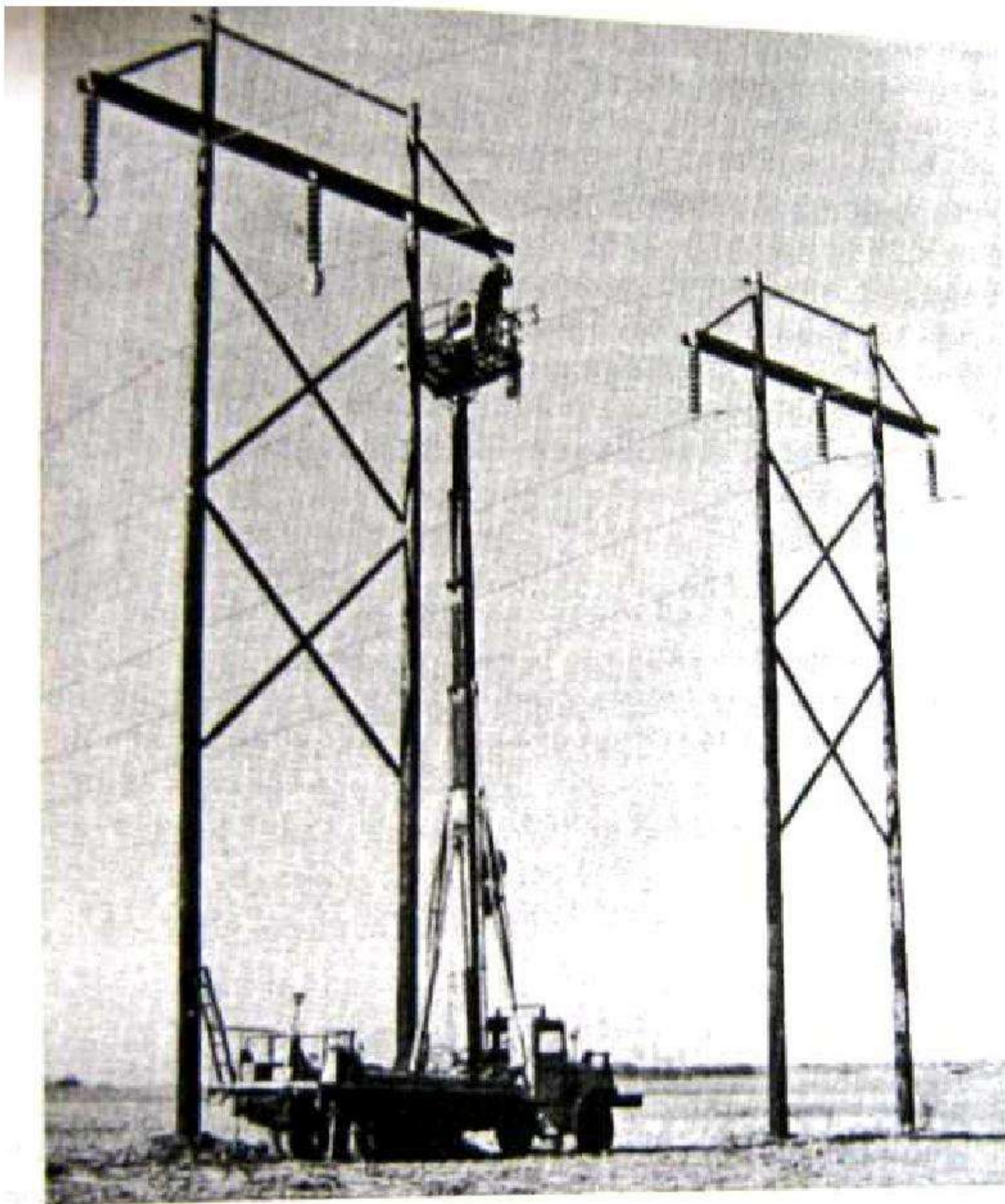
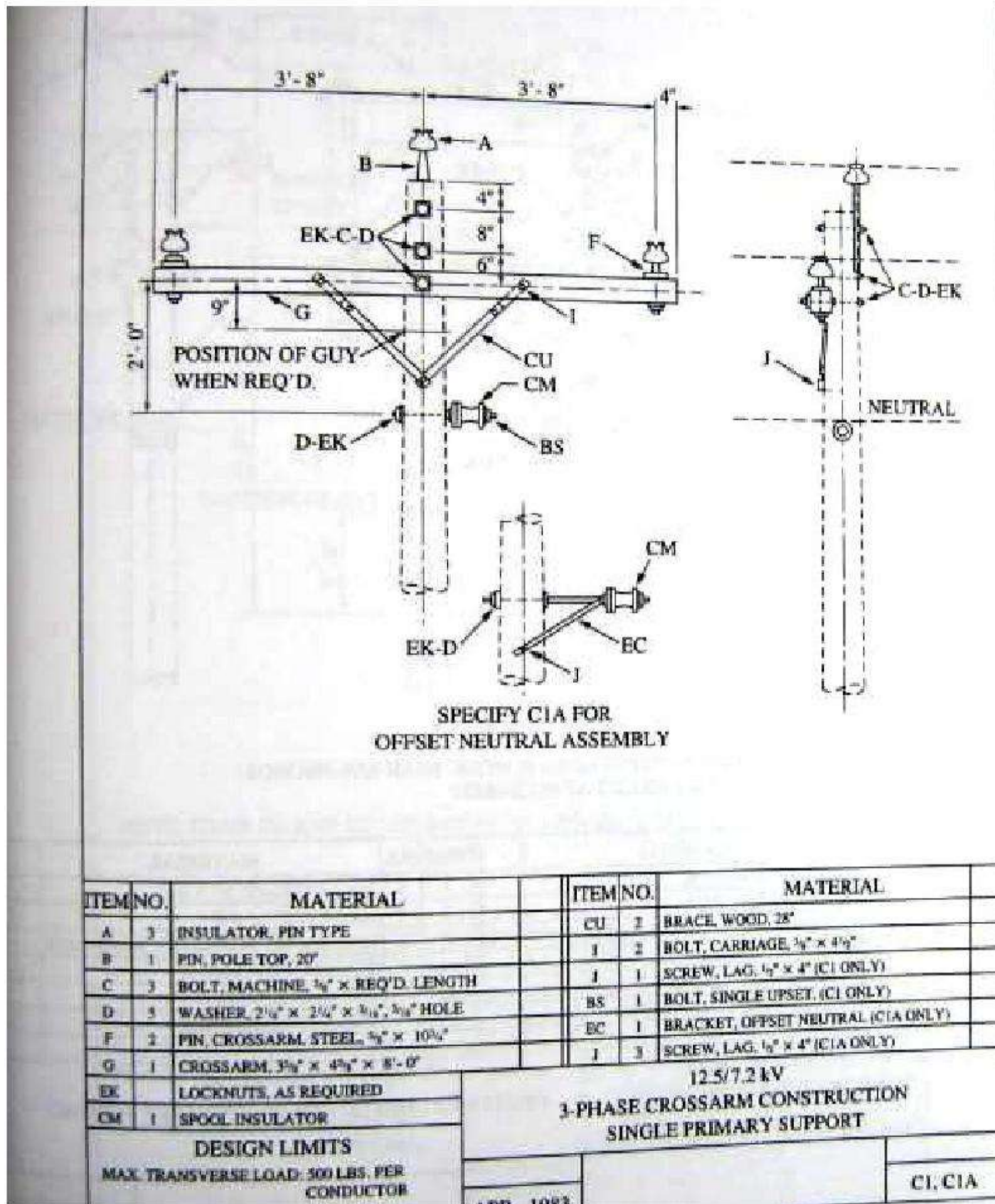
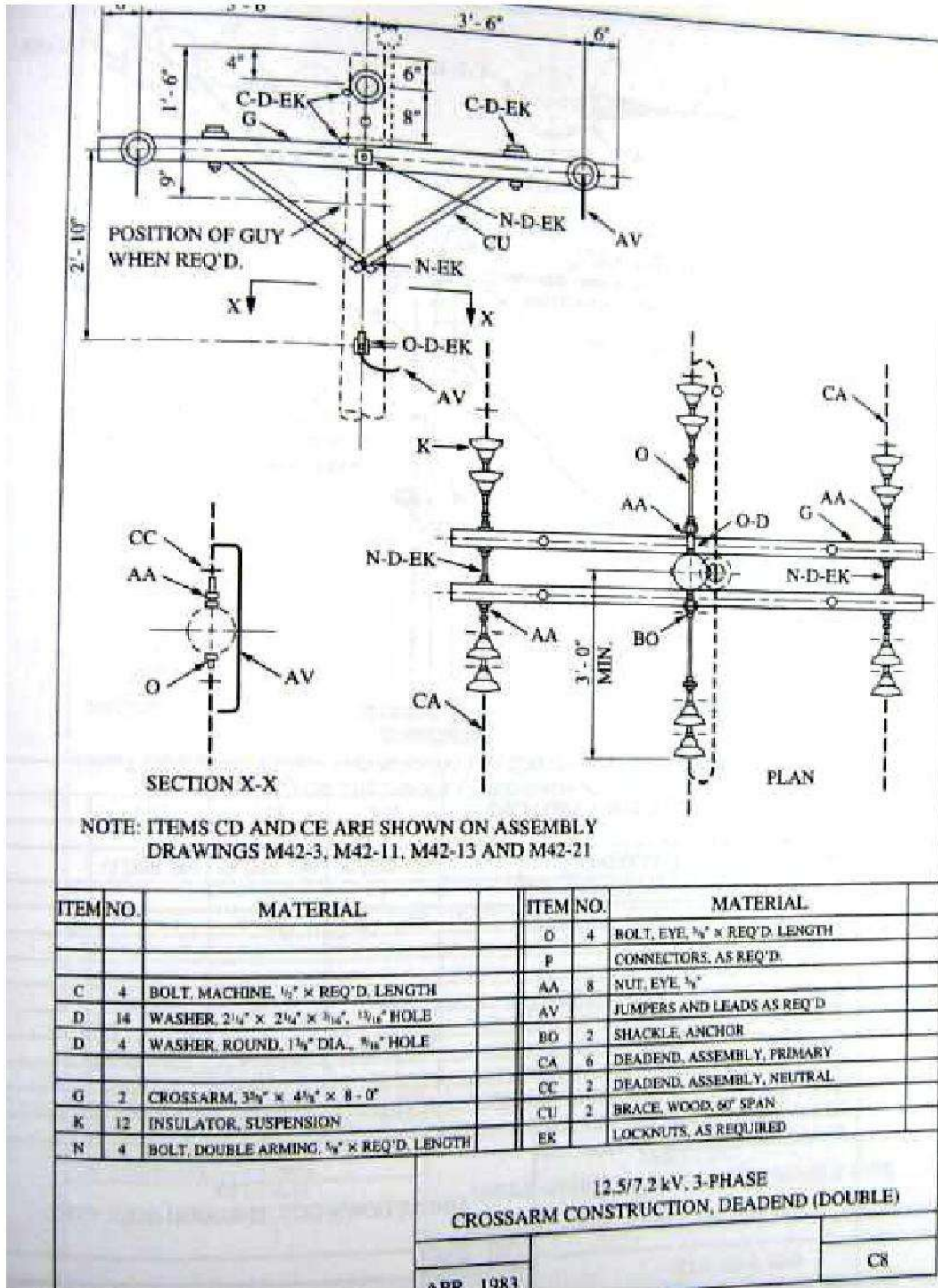

FIGURE 11.17 Conductor clipping with a high-reach

Section 2 – Overhead Lines and Installation



Section 2 – Overhead Lines and Installation



Section 2 – Overhead Lines and Installation

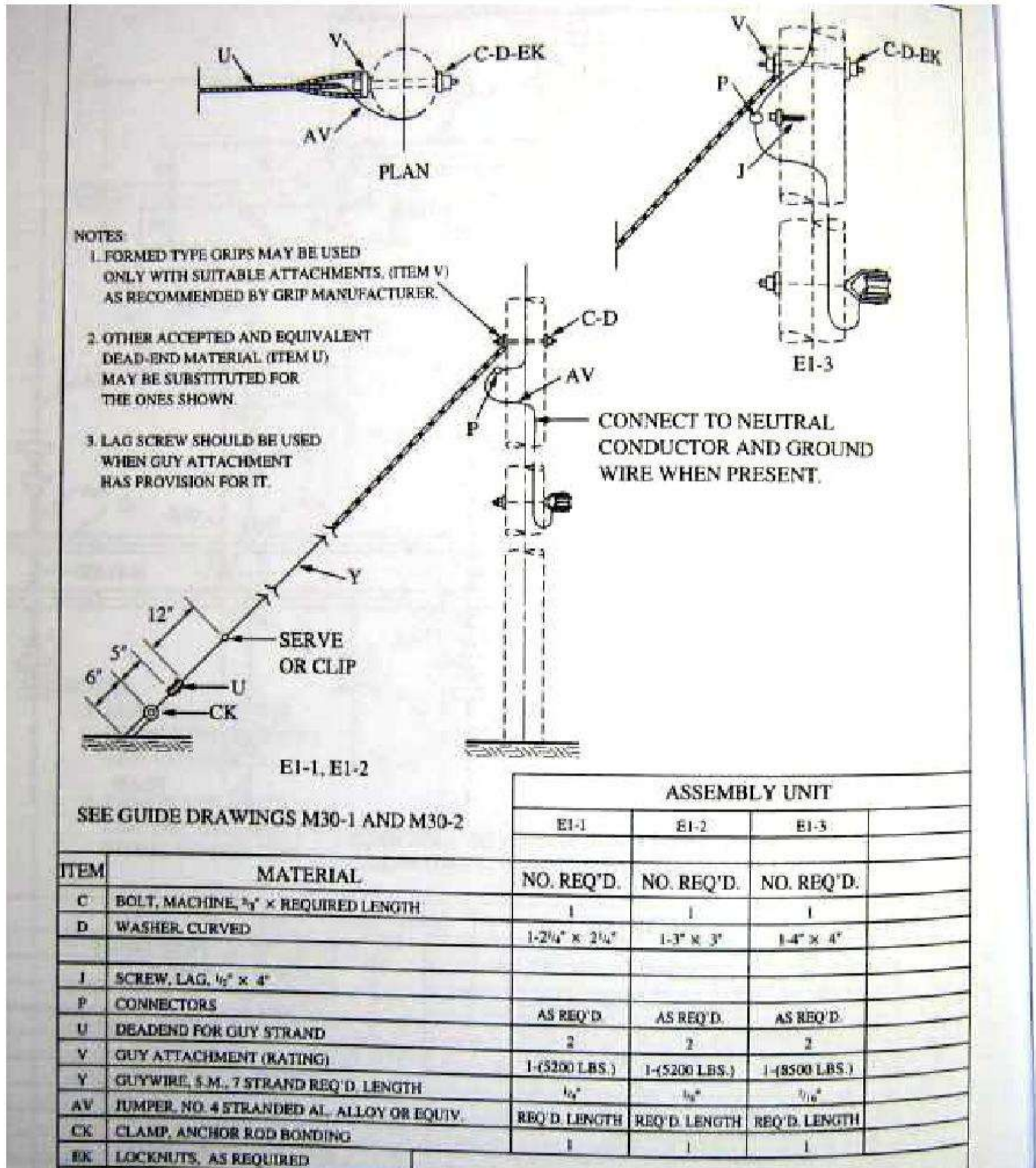

Section 2 – Overhead Lines and Installation

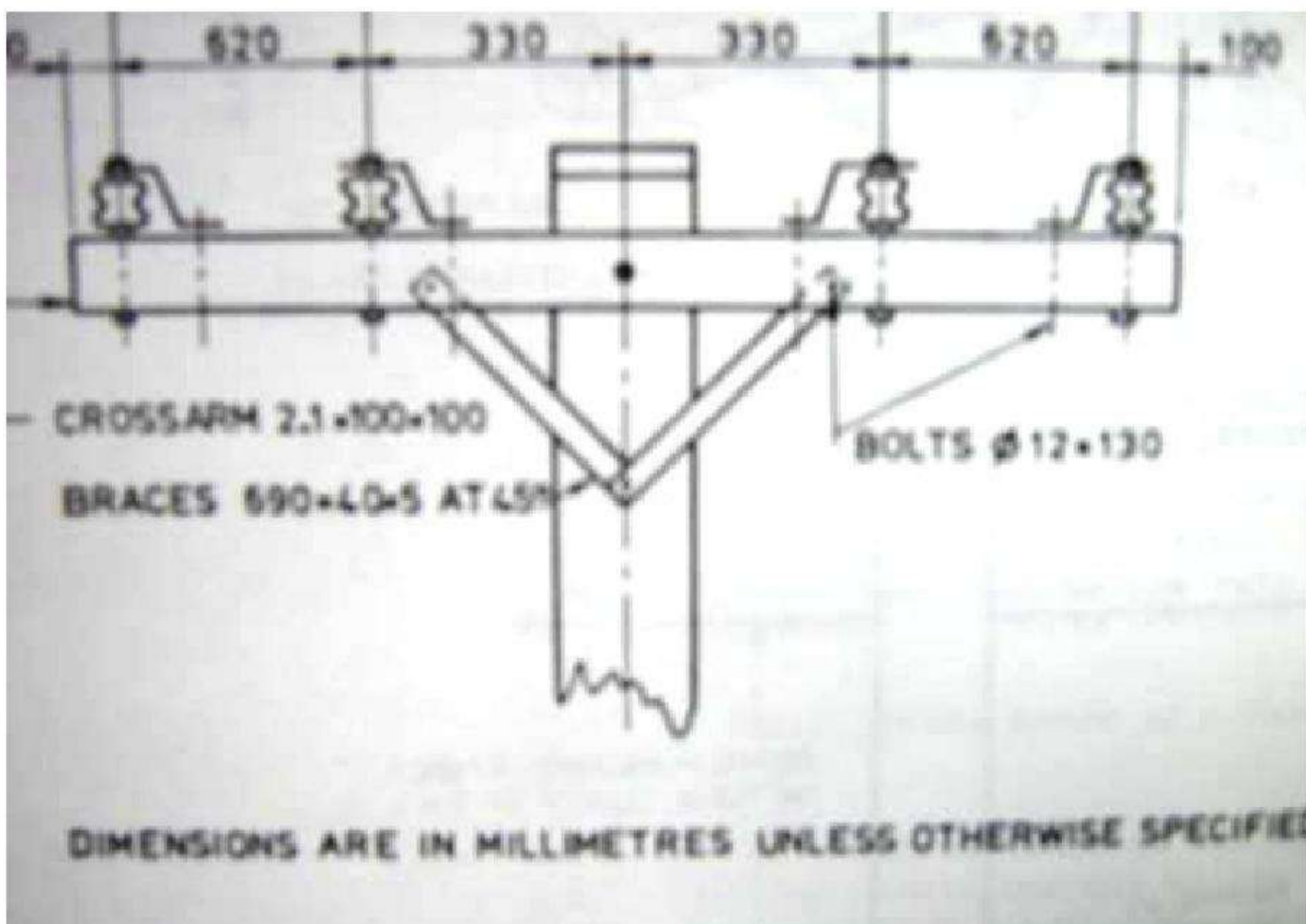
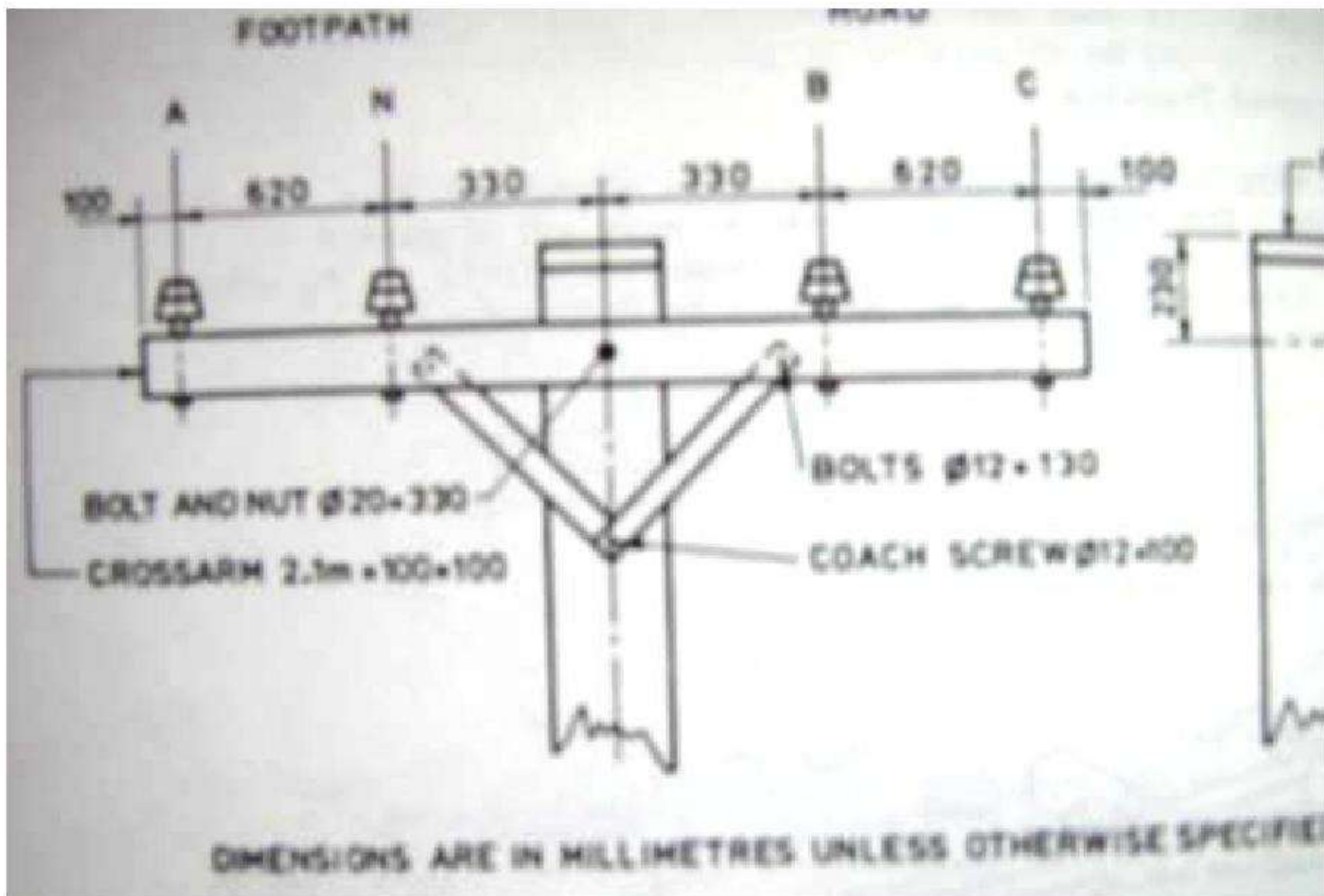

Section 2 – Overhead Lines and Installation

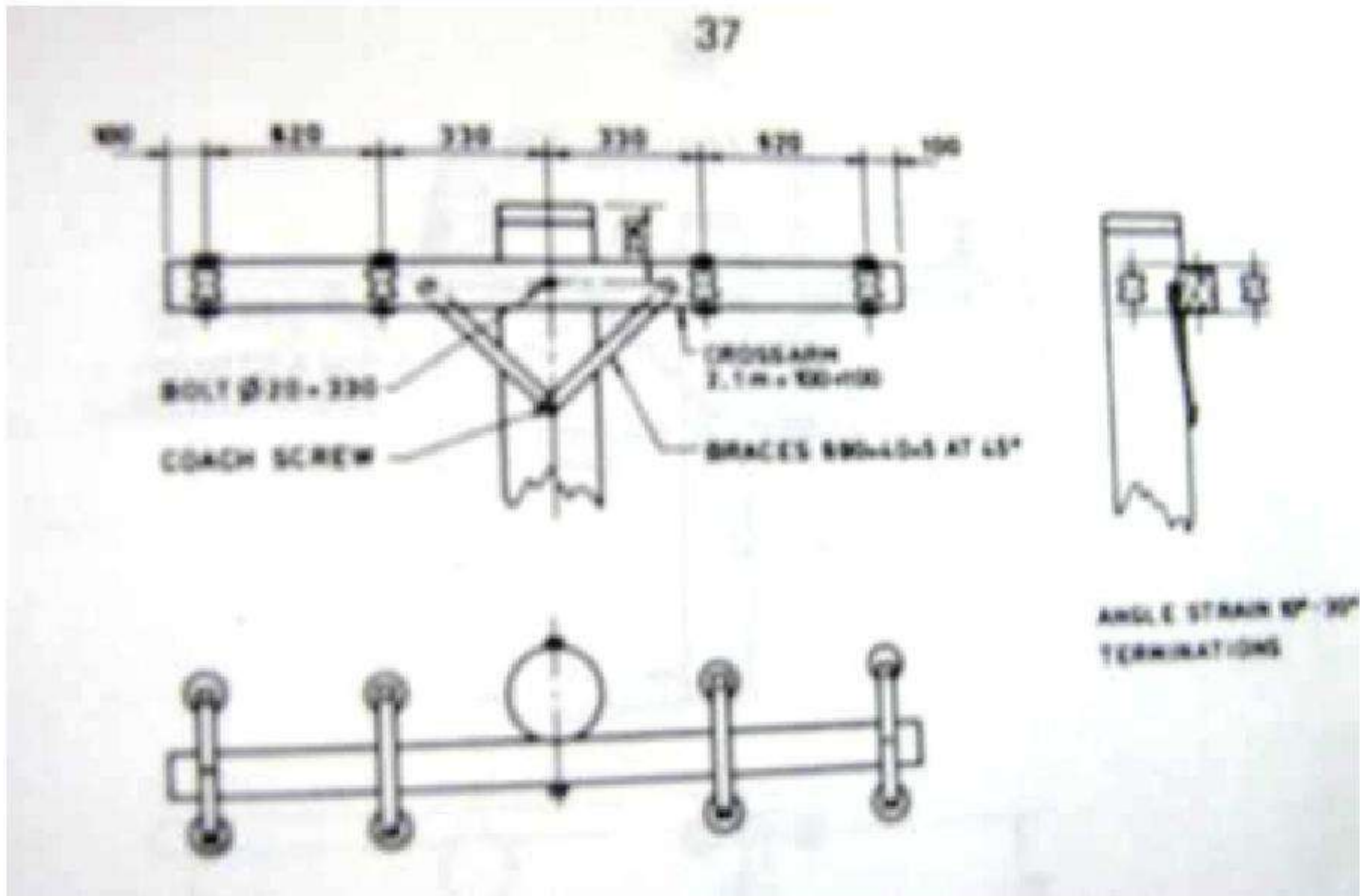

Section 2 – Overhead Lines and Installation

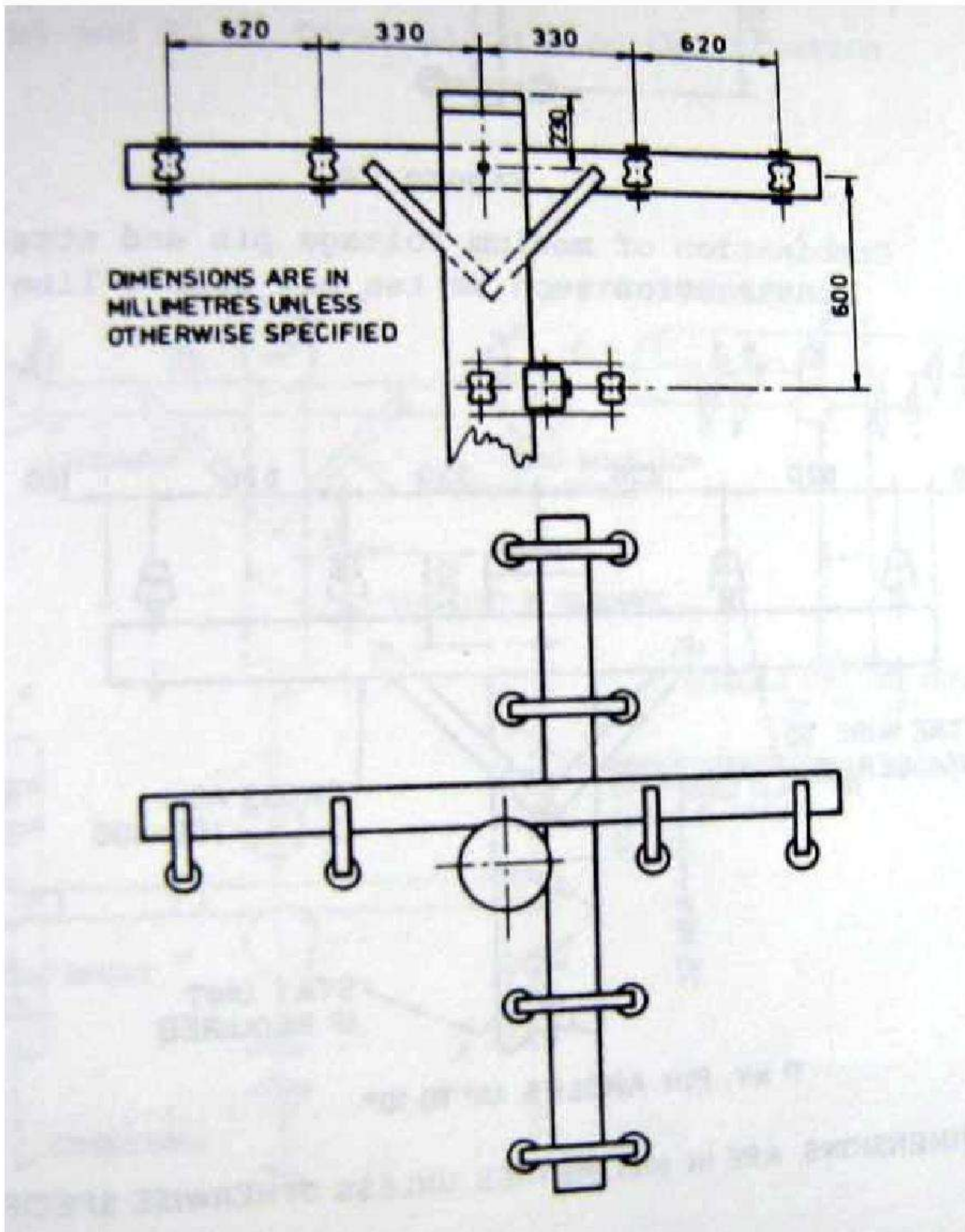

Section 2 – Overhead Lines and Installation

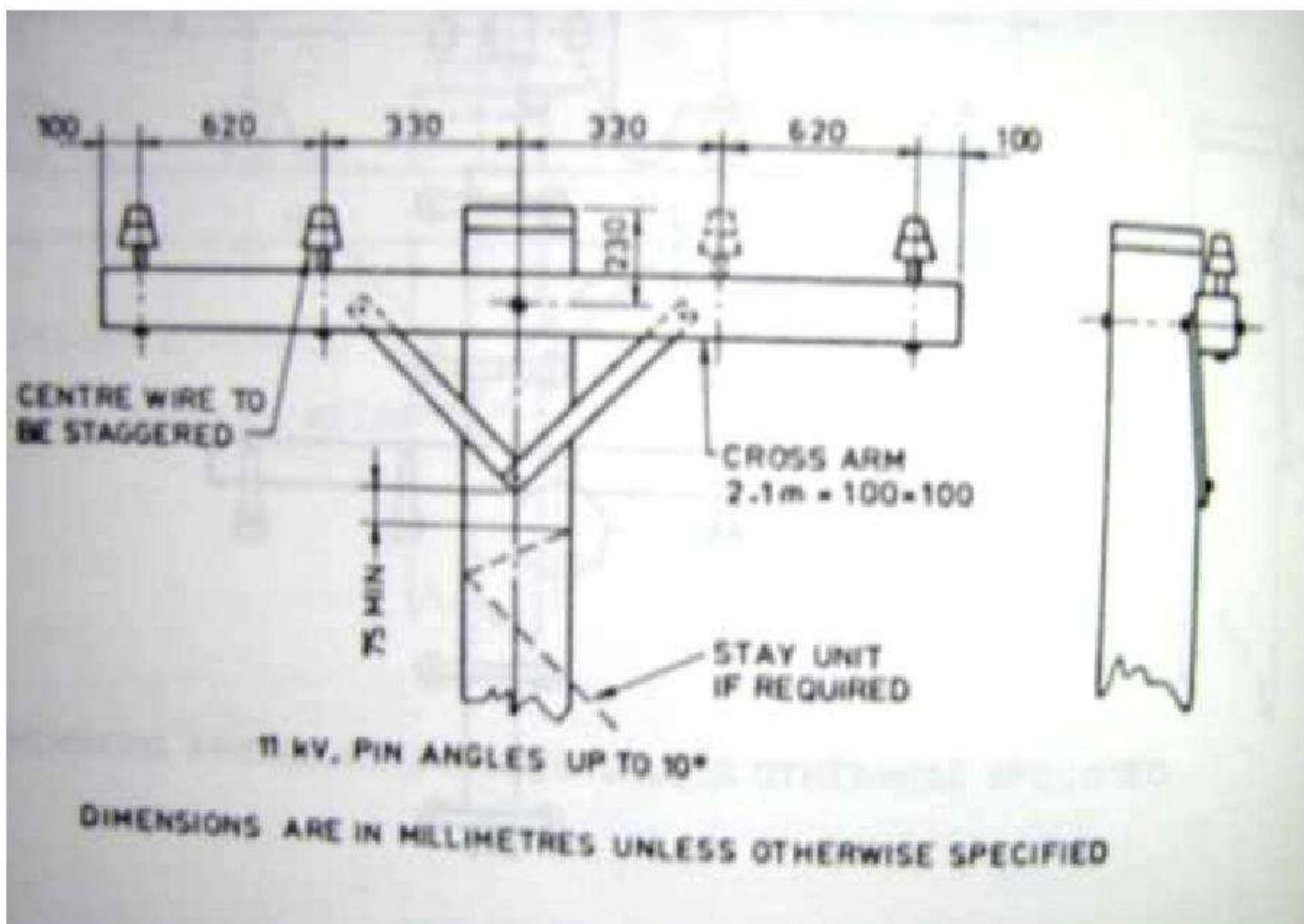
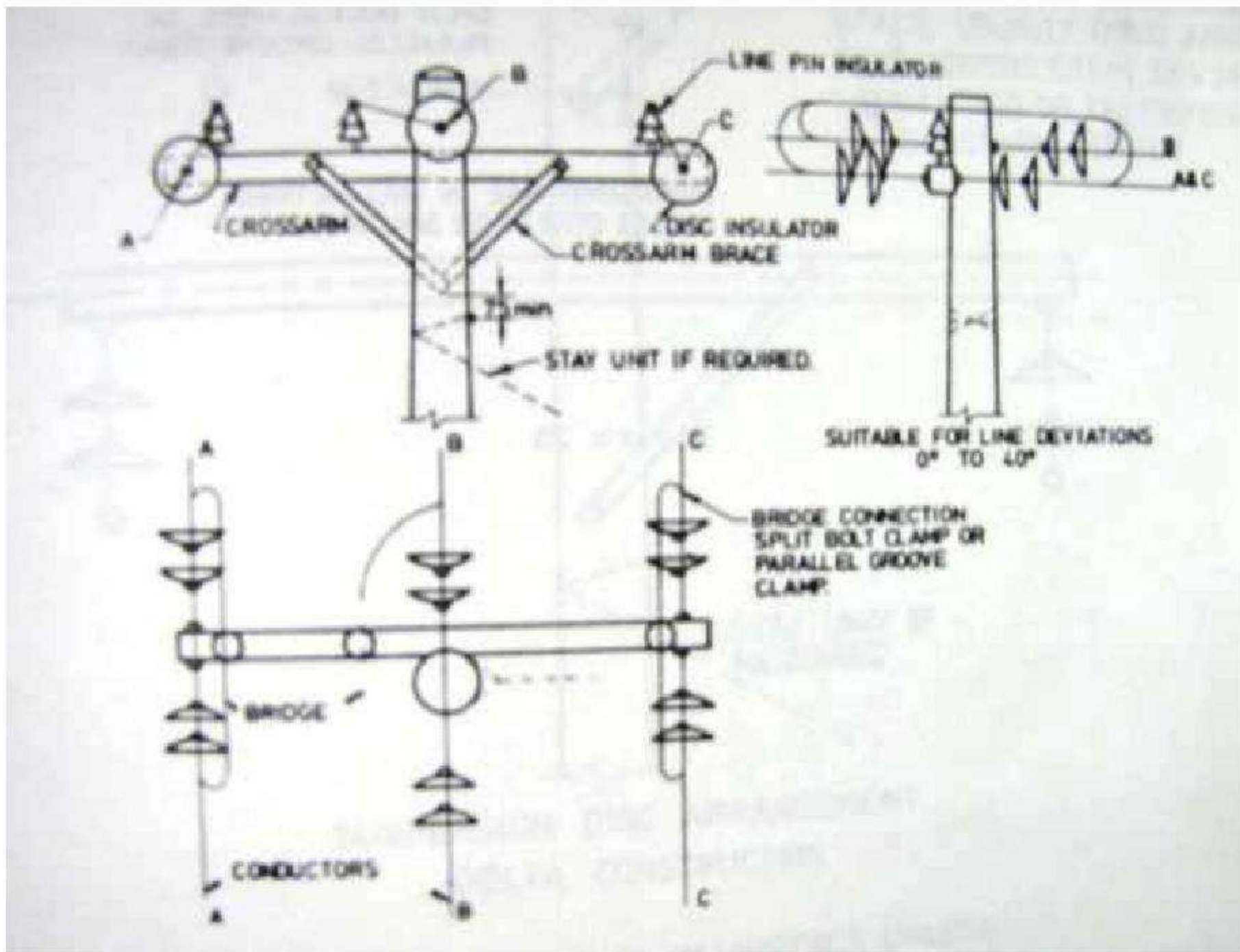

Section 2 – Overhead Lines and Installation

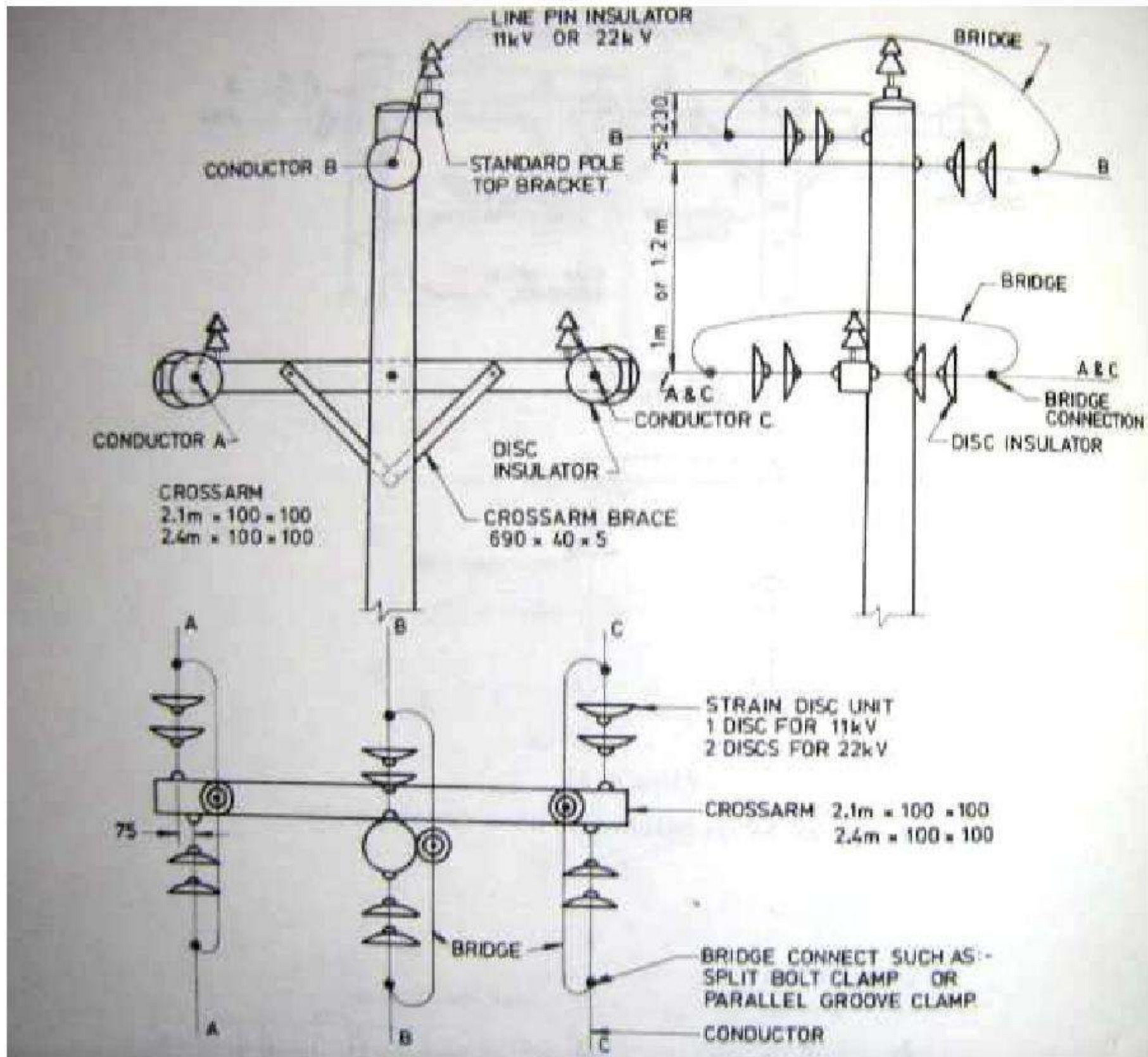

Section 2 – Overhead Lines and Installation

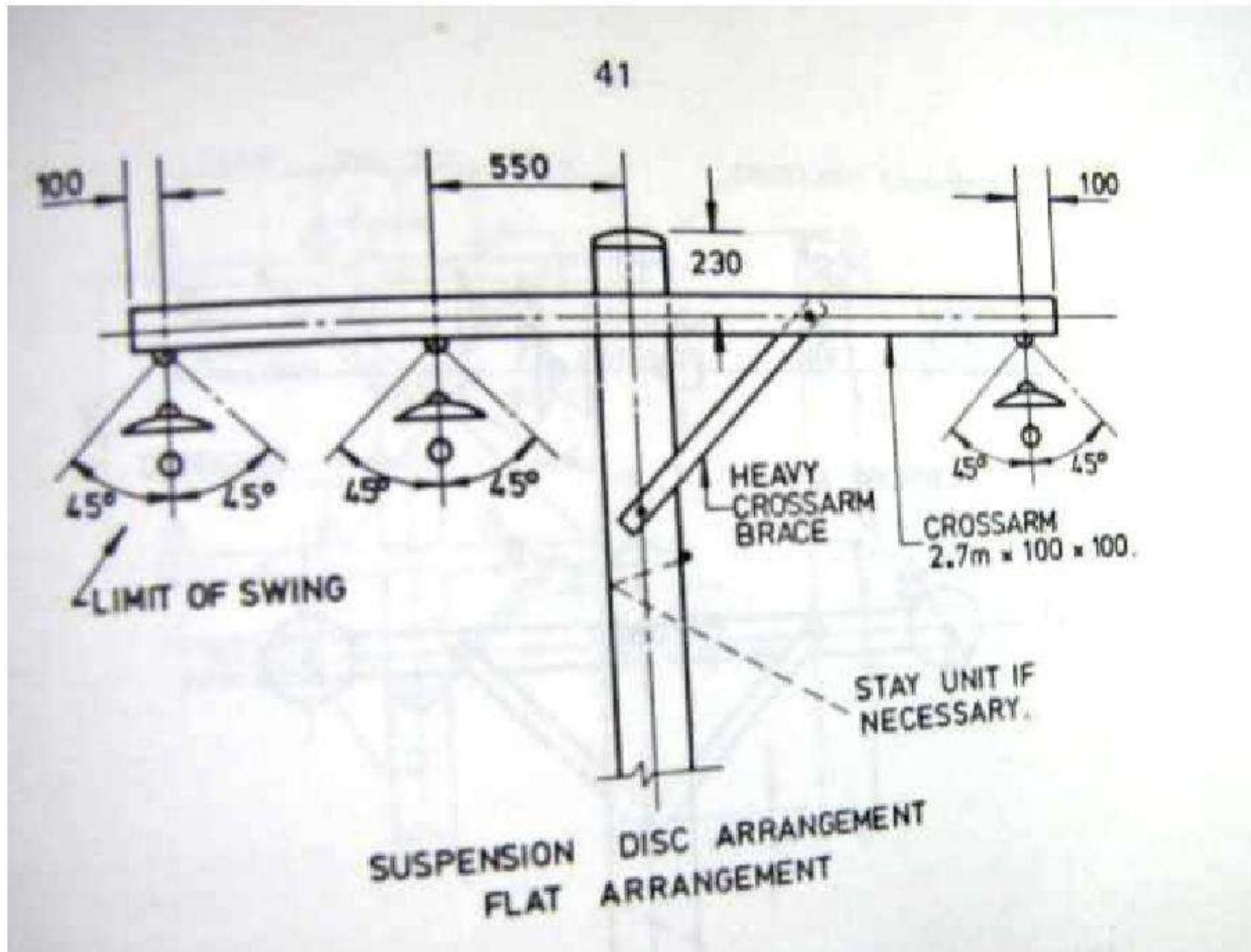

Section 2 – Overhead Lines and Installation

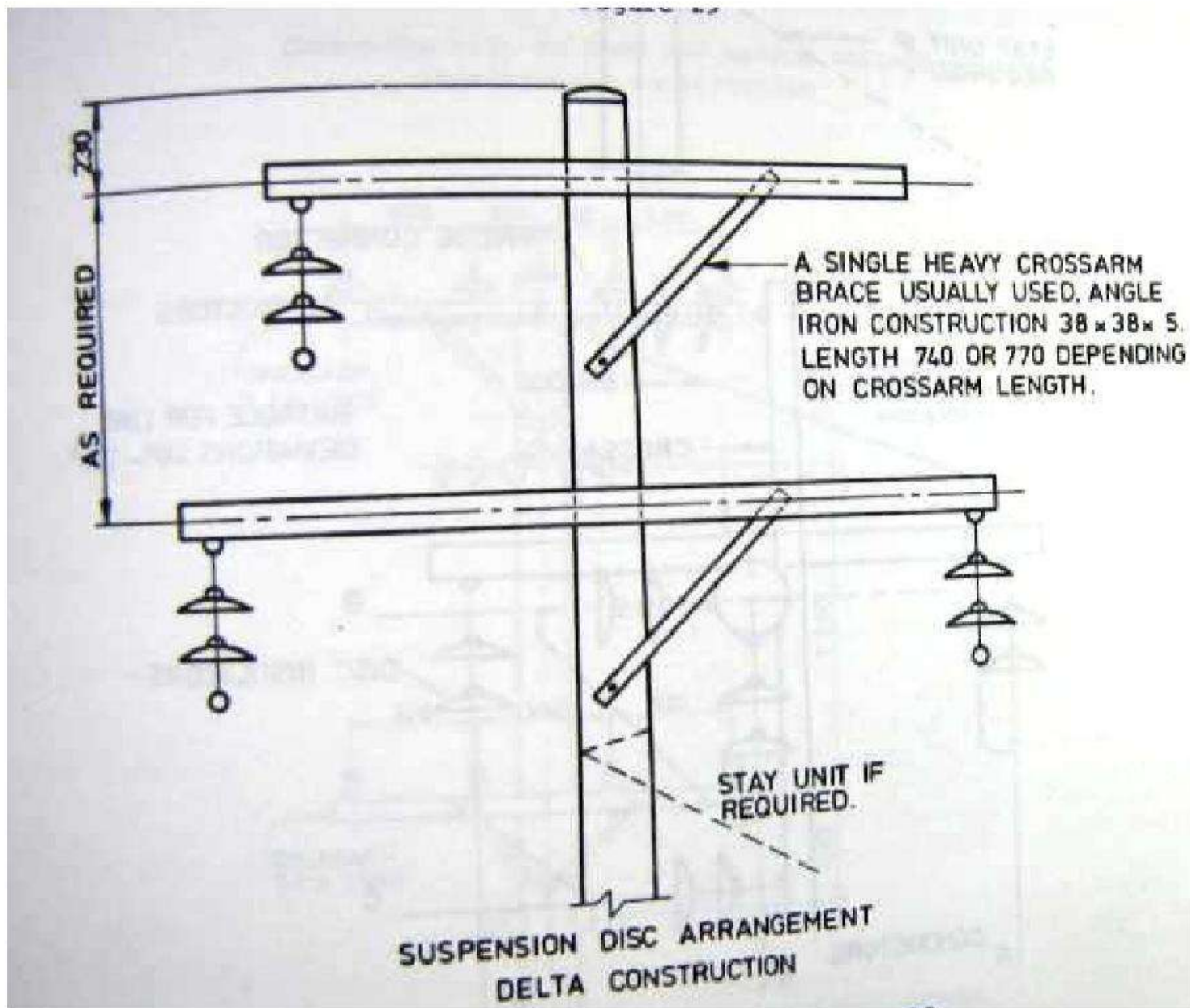

Section 2 – Overhead Lines and Installation

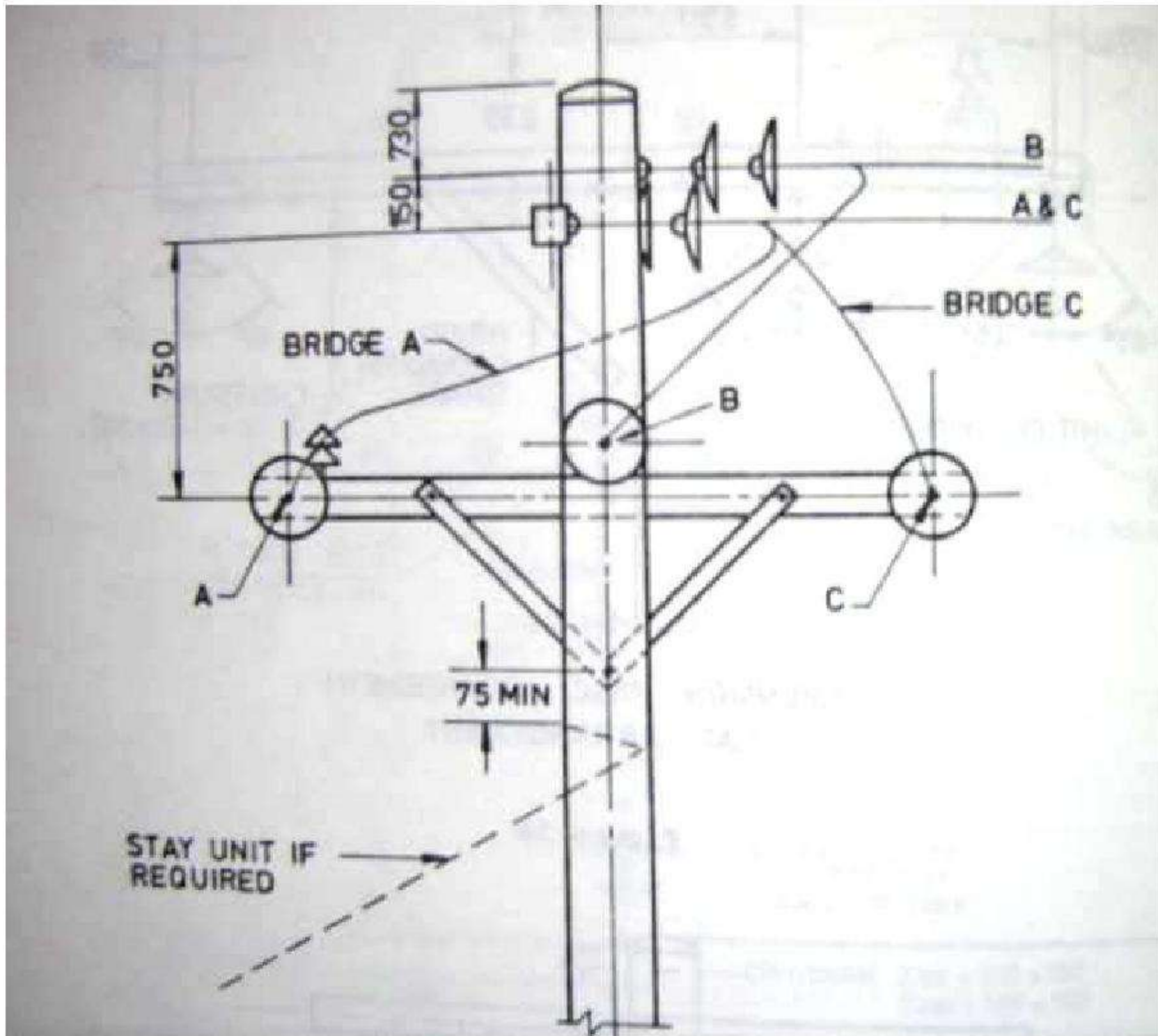

Section 2 – Overhead Lines and Installation

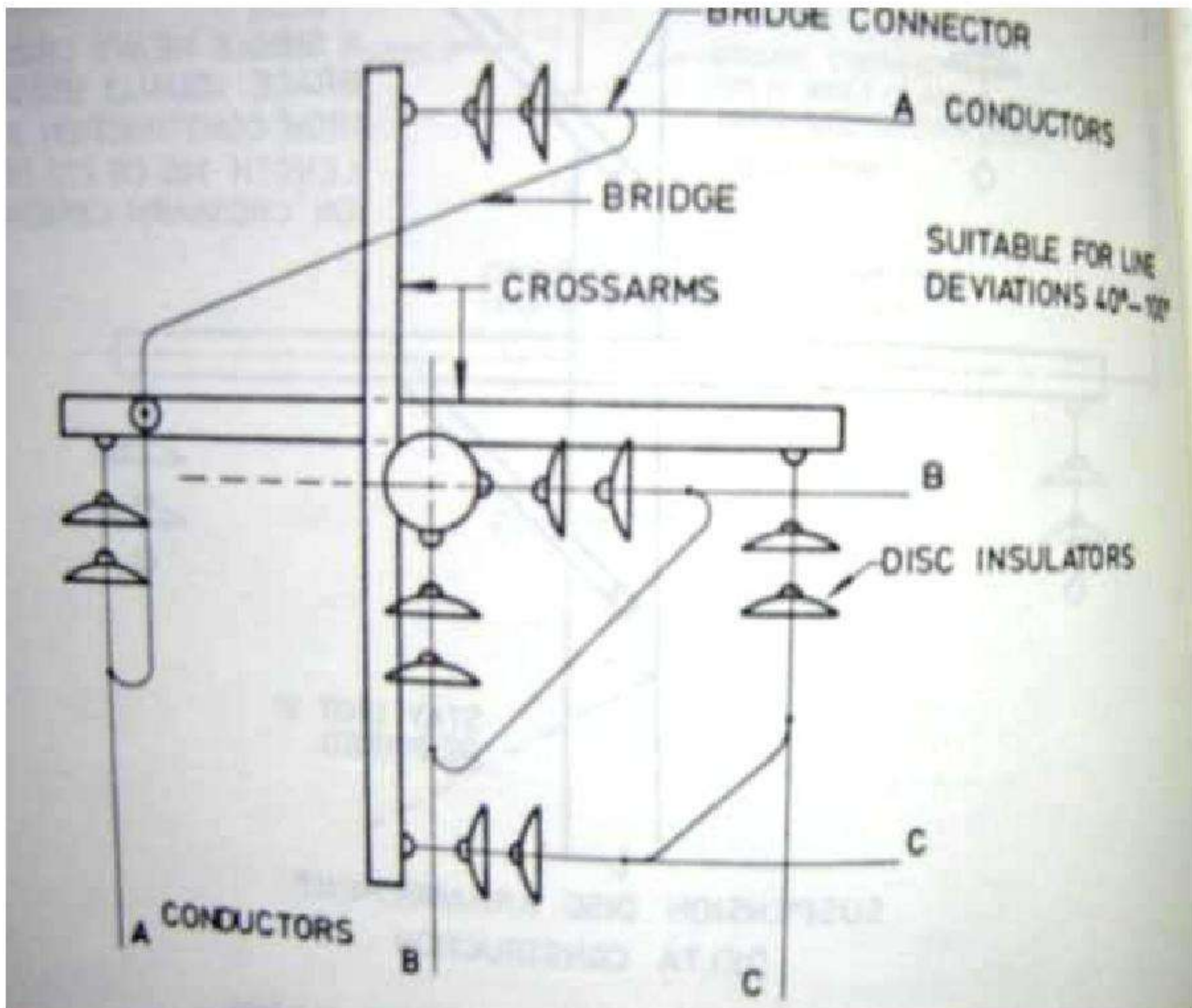

Section 2 – Overhead Lines and Installation

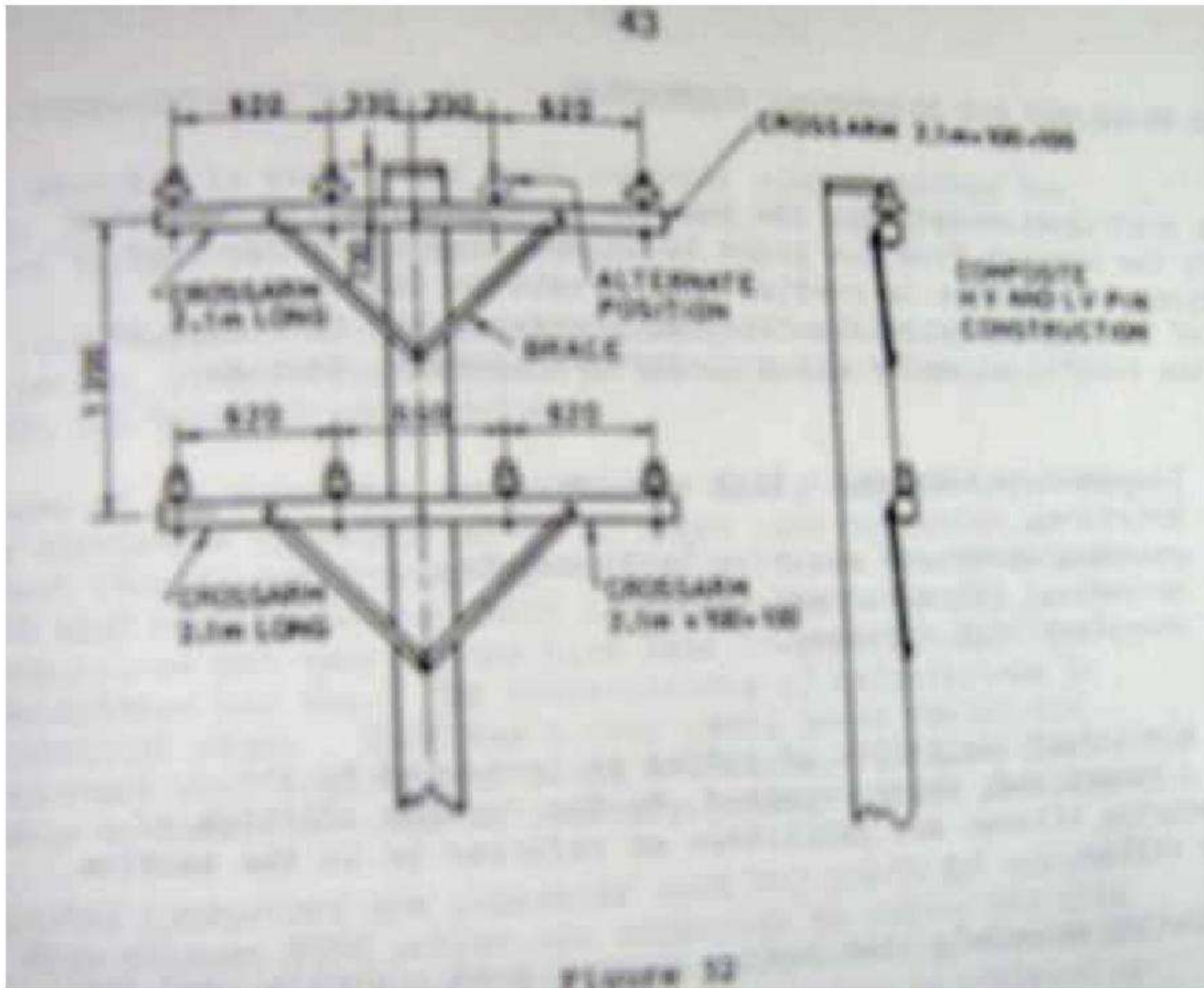

Section 2 – Overhead Lines and Installation

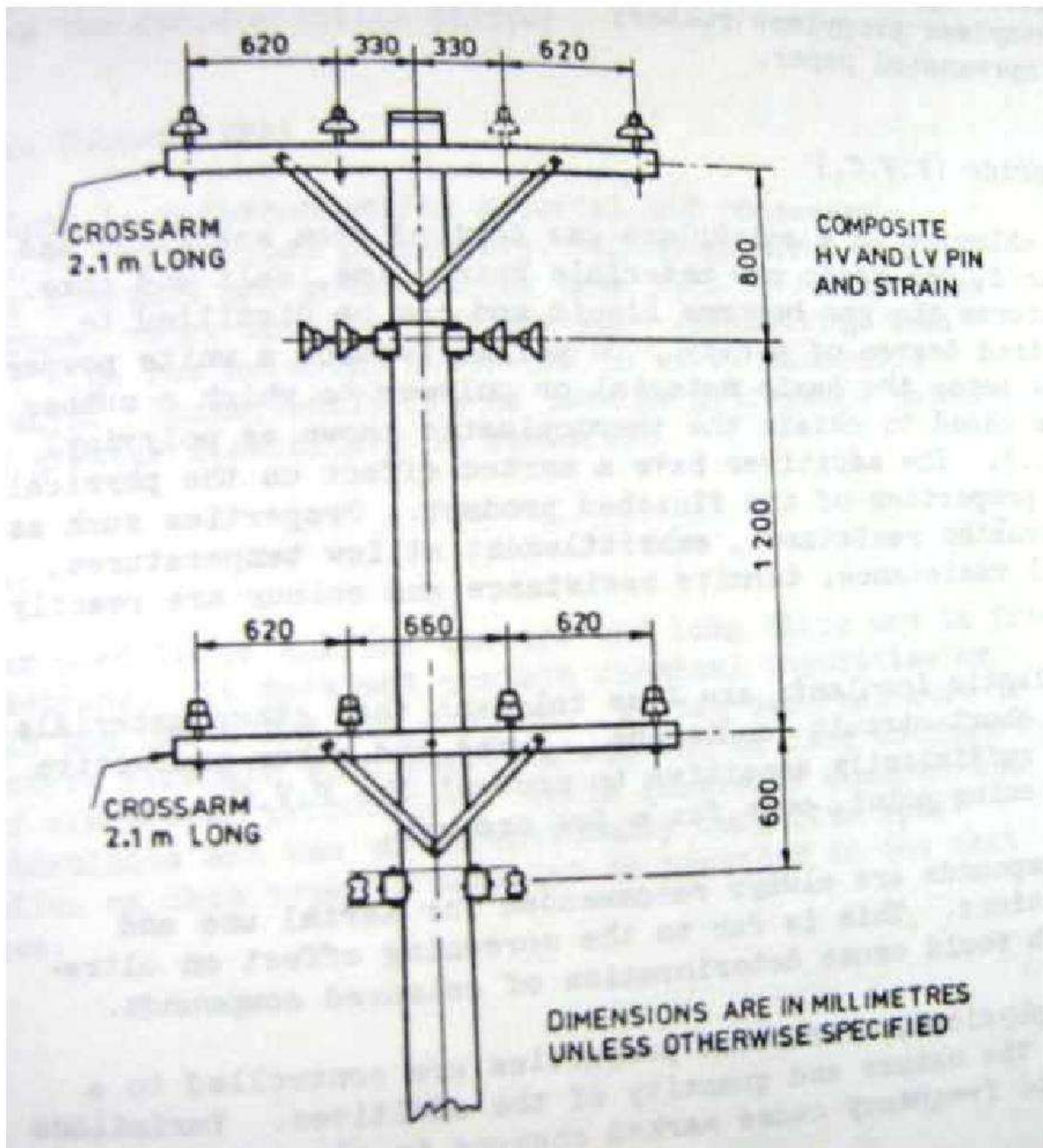

Section 2 – Overhead Lines and Installation

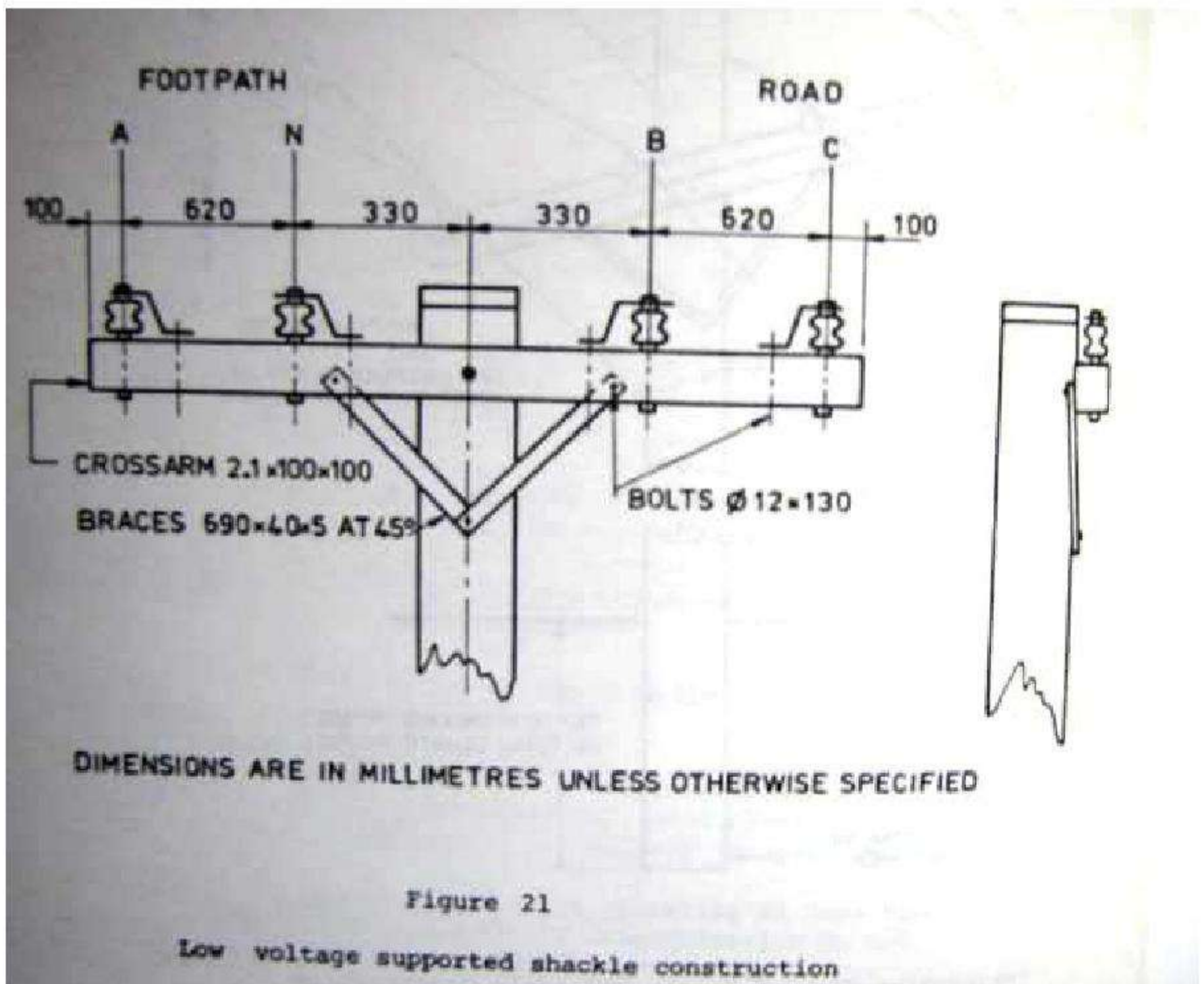
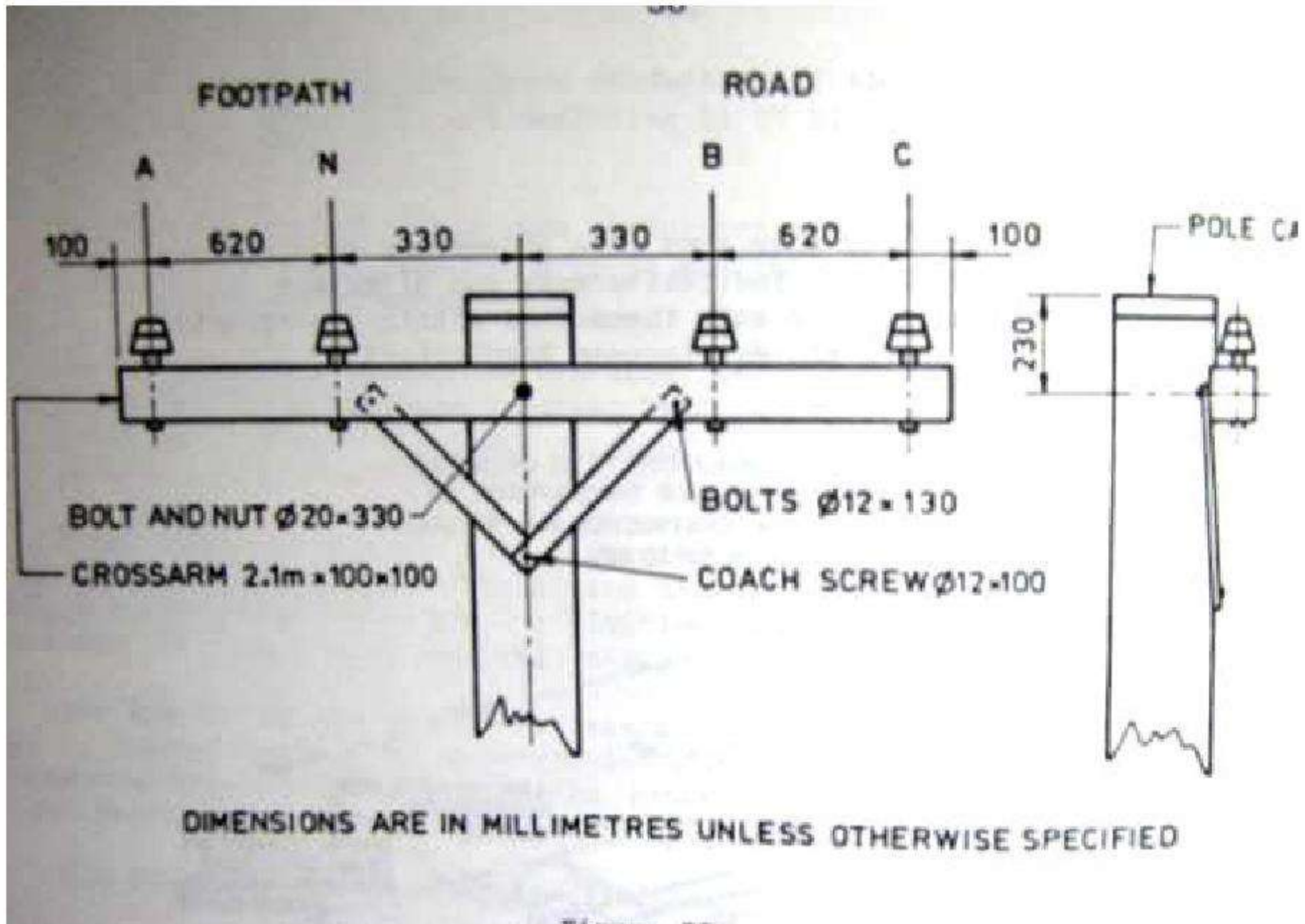

Section 2 – Overhead Lines and Installation

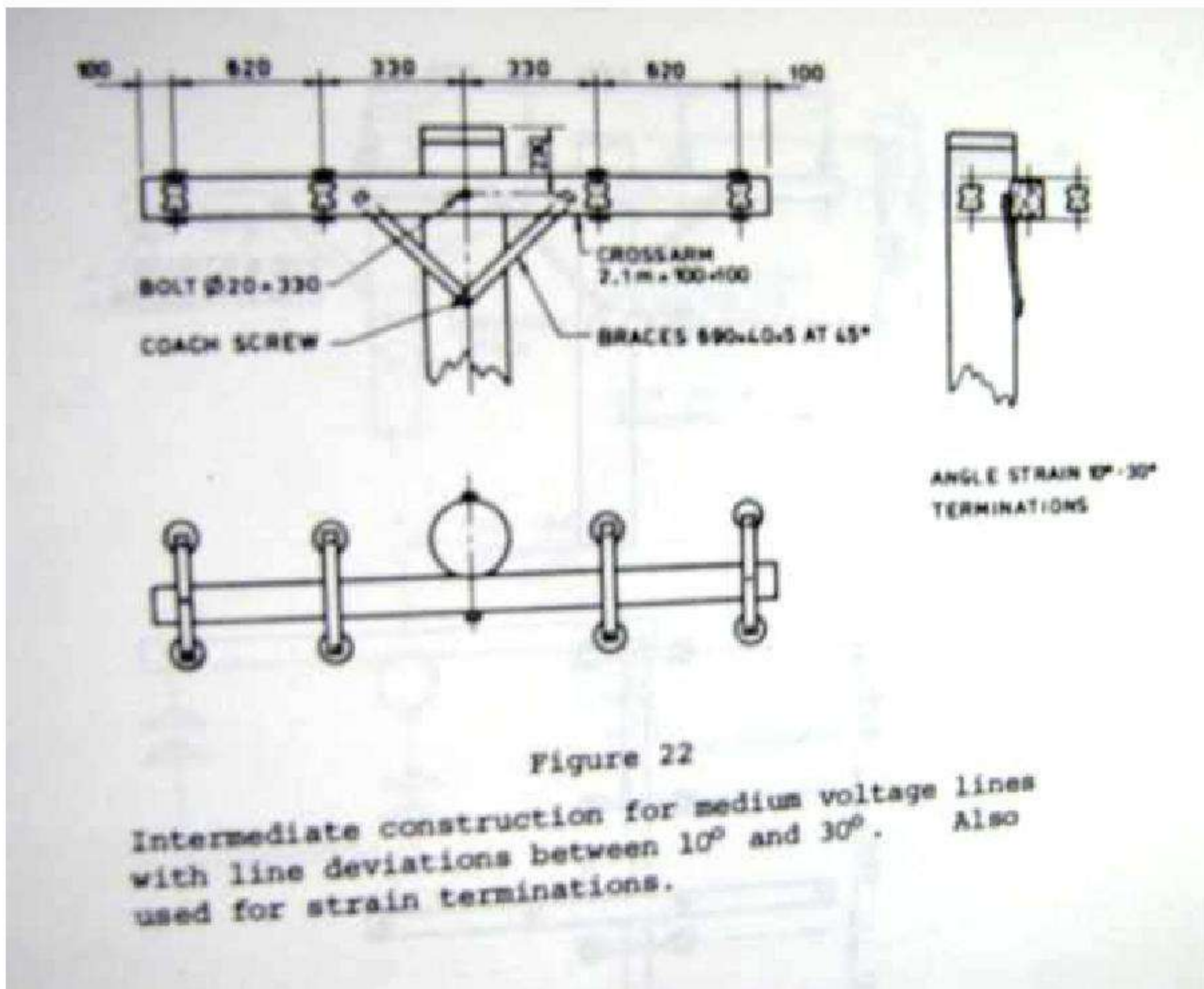

Section 2 – Overhead Lines and Installation

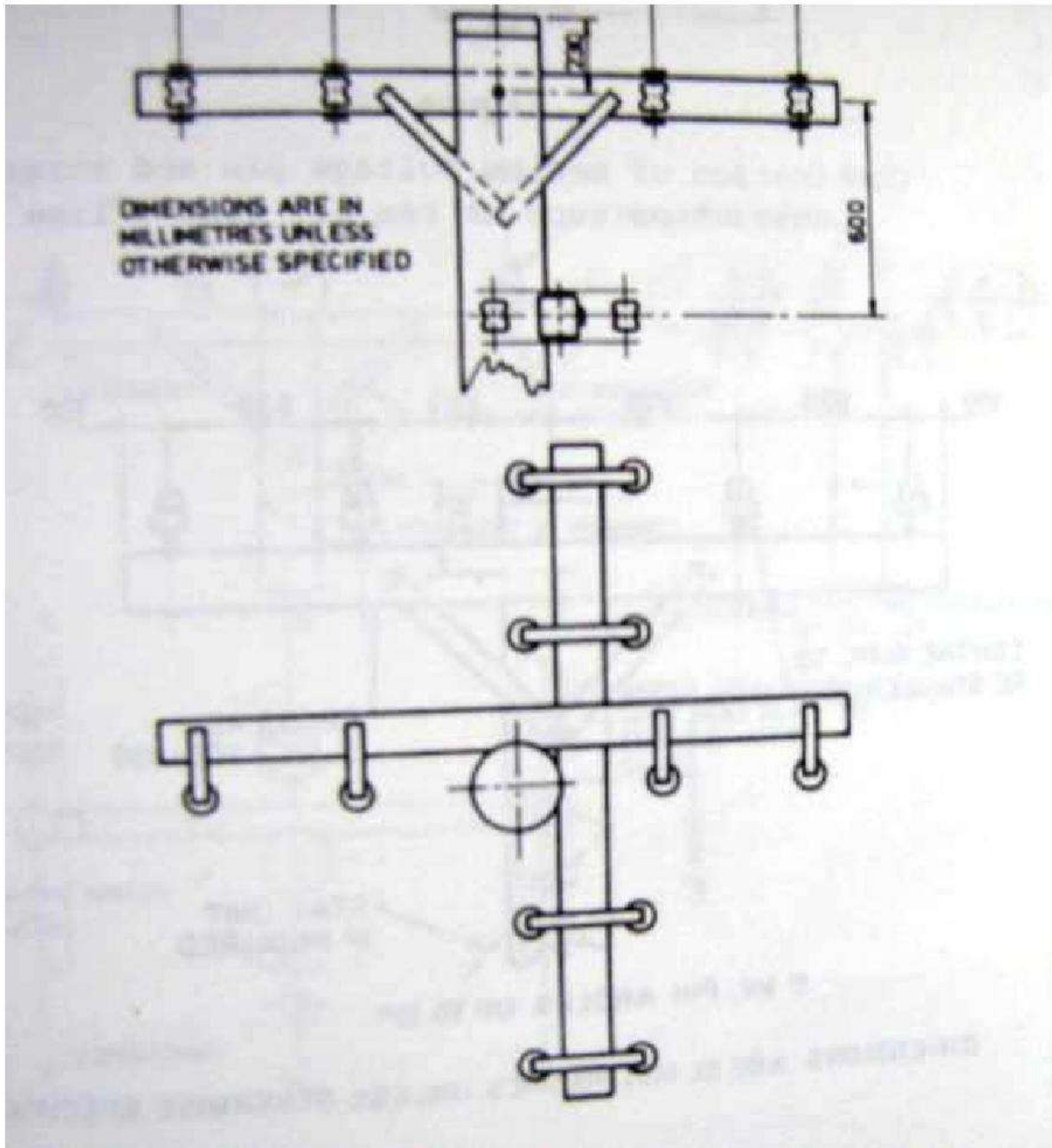

Section 2 – Overhead Lines and Installation

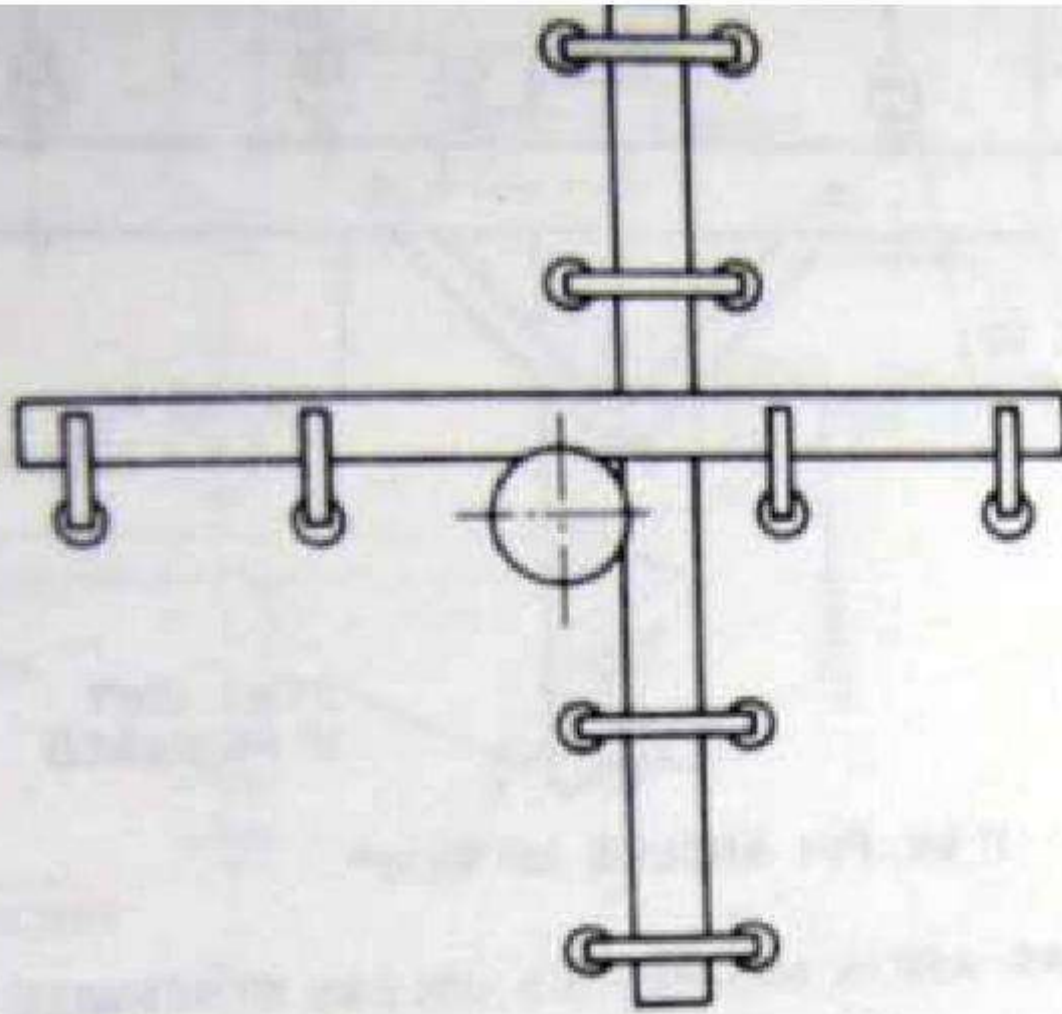
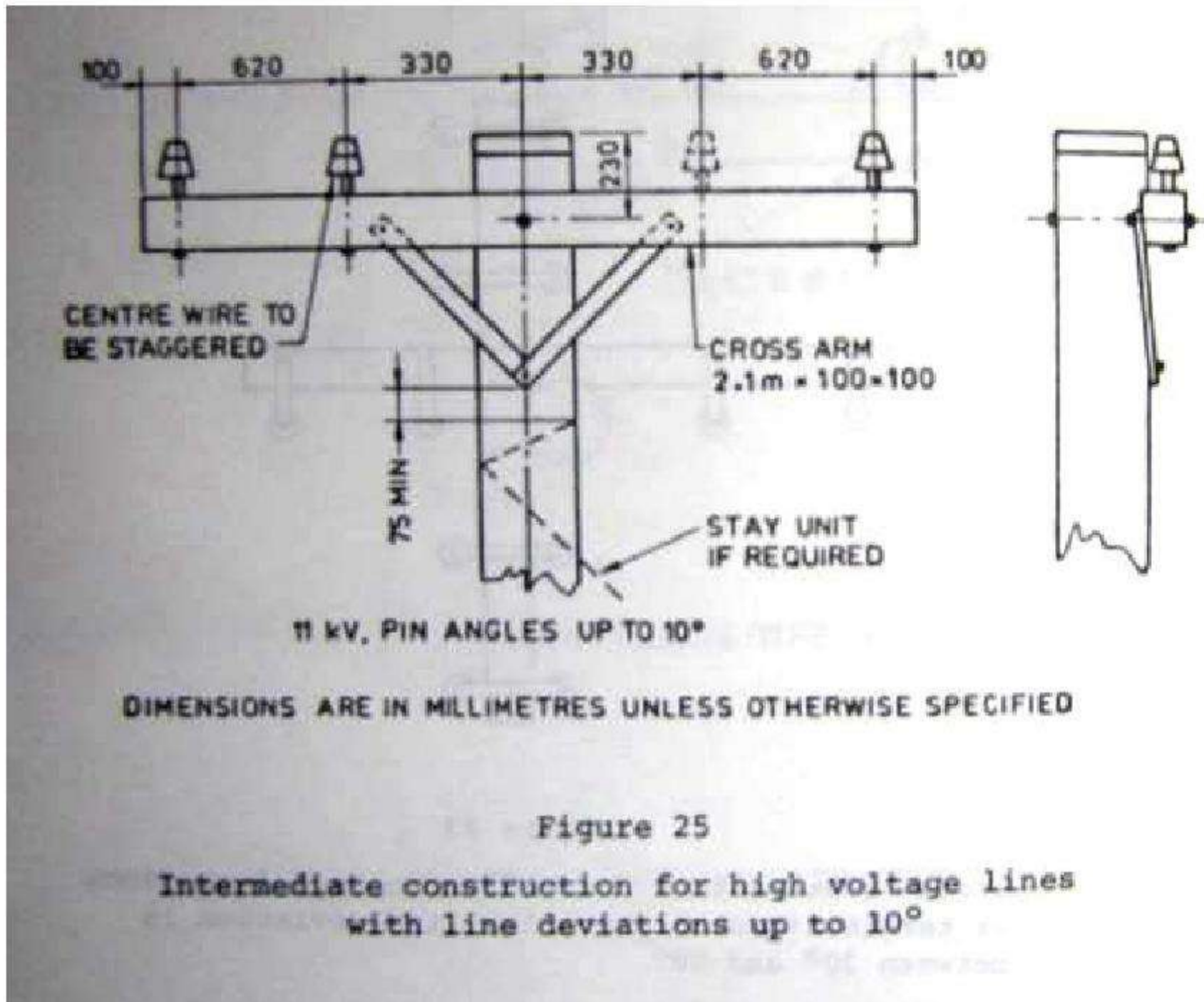

Figure 23

Strain construction for medium voltage lines such as terminations or where the line deviation is between 30° and 90° .

Section 2 – Overhead Lines and Installation



Section 2 – Overhead Lines and Installation

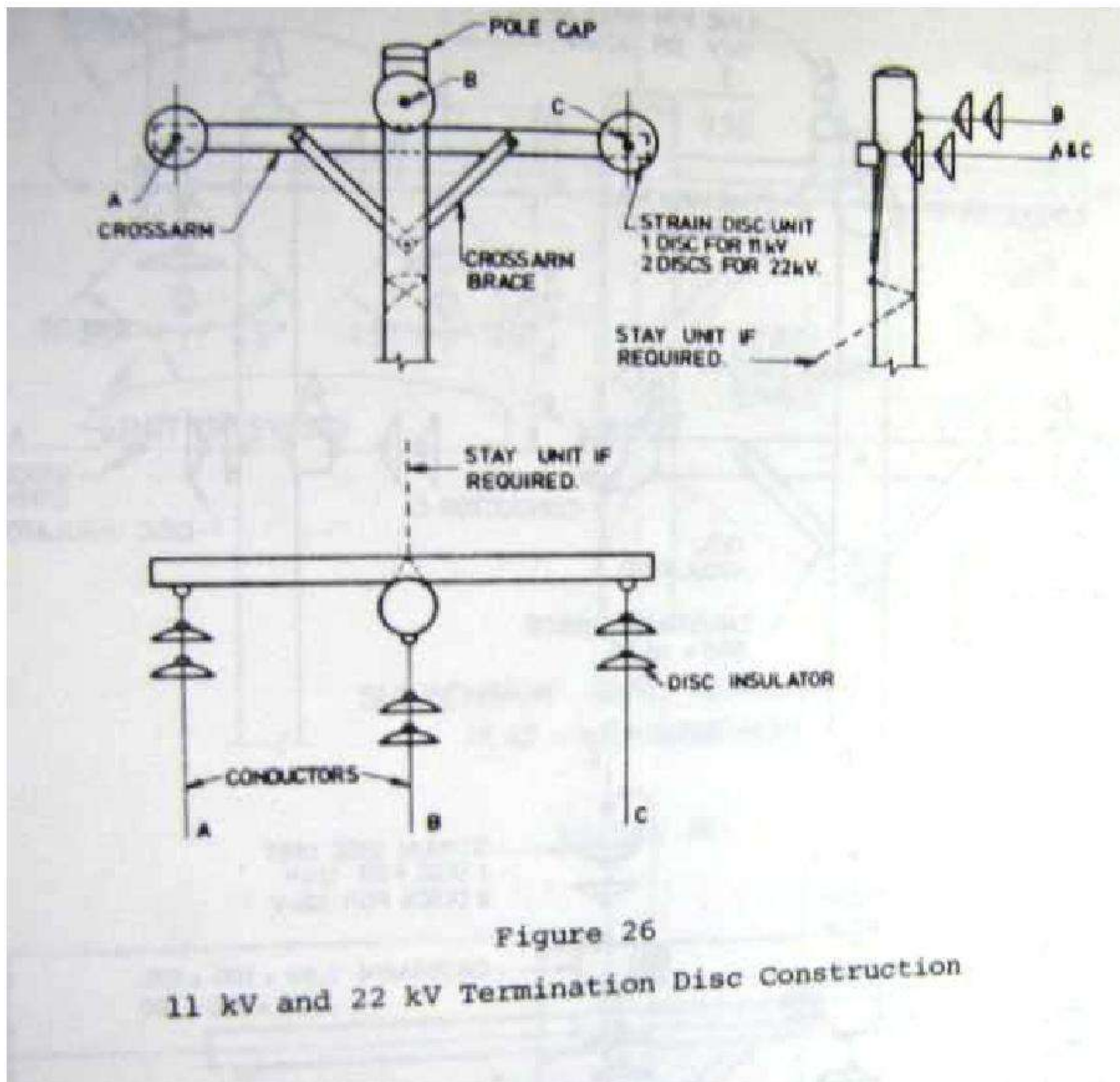

Section 2 – Overhead Lines and Installation

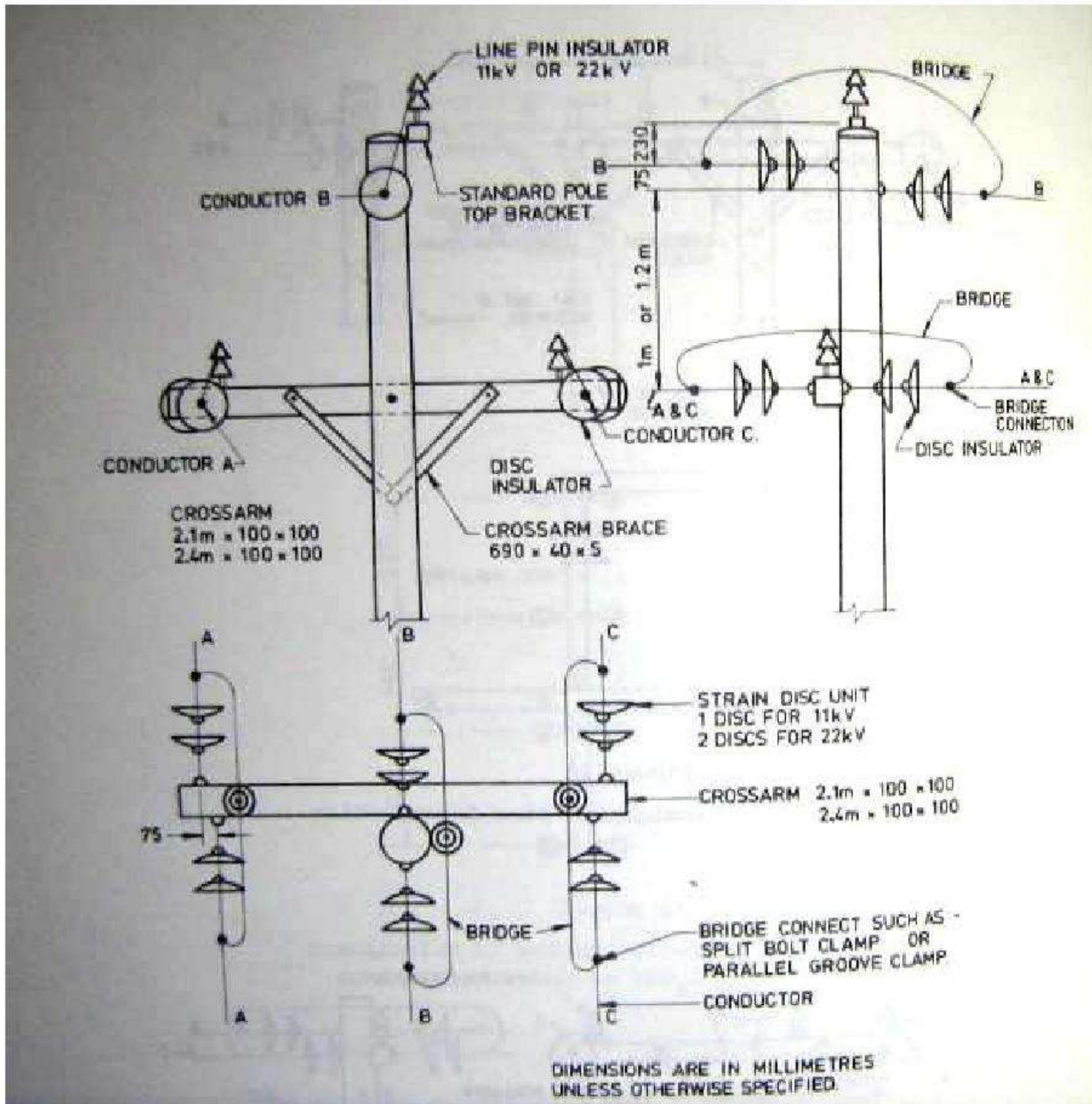

Section 2 – Overhead Lines and Installation

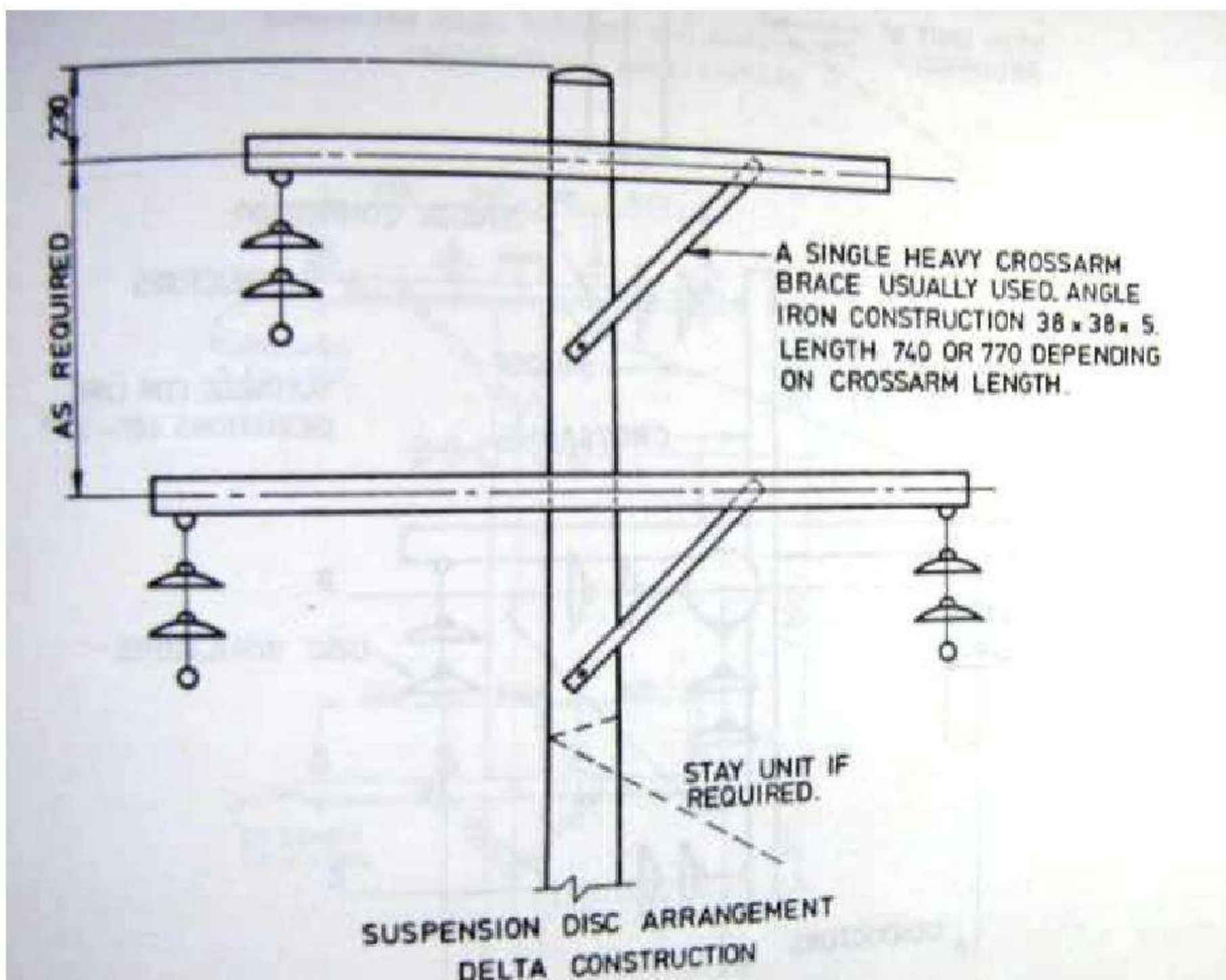
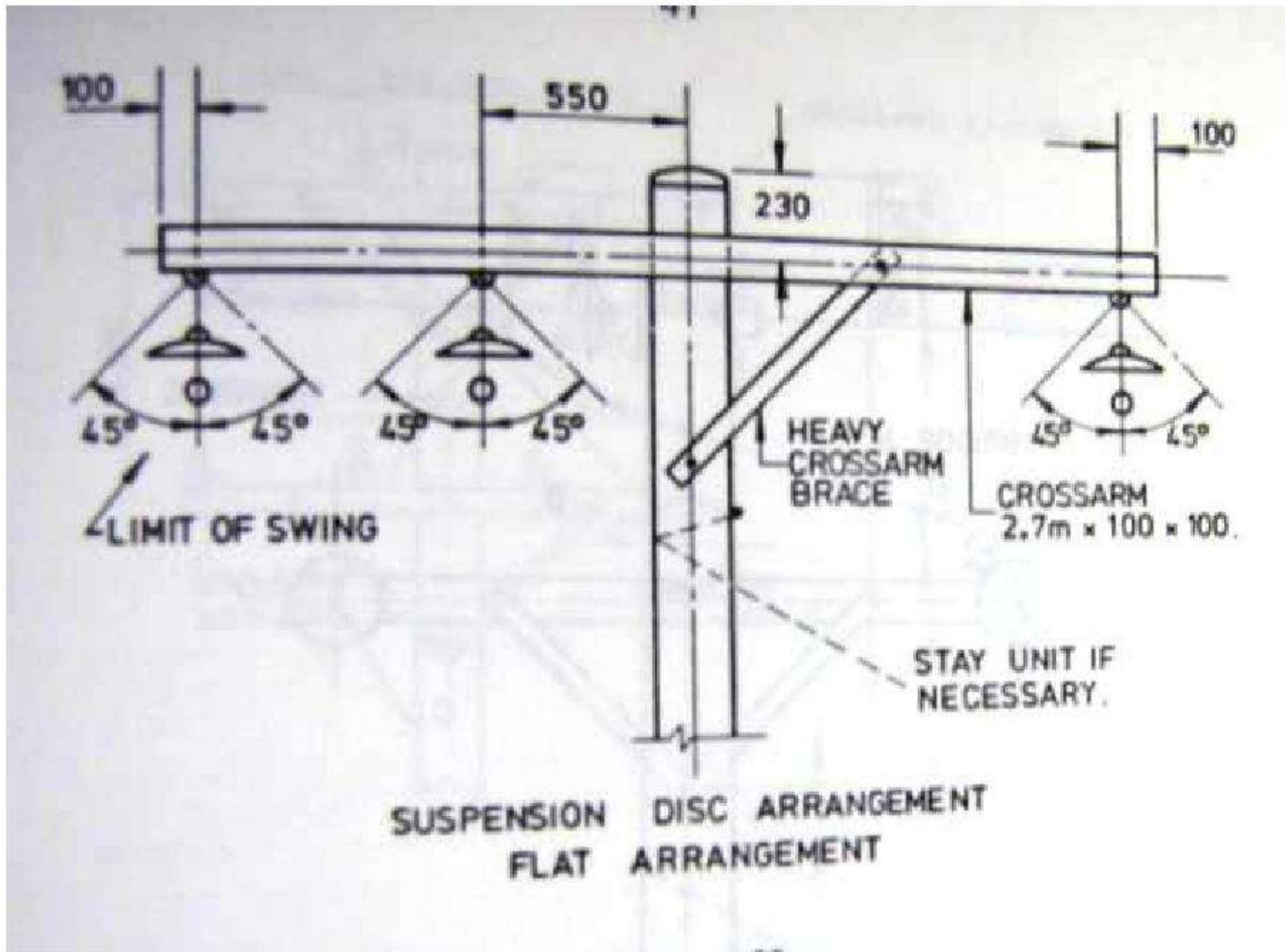

Section 2 – Overhead Lines and Installation

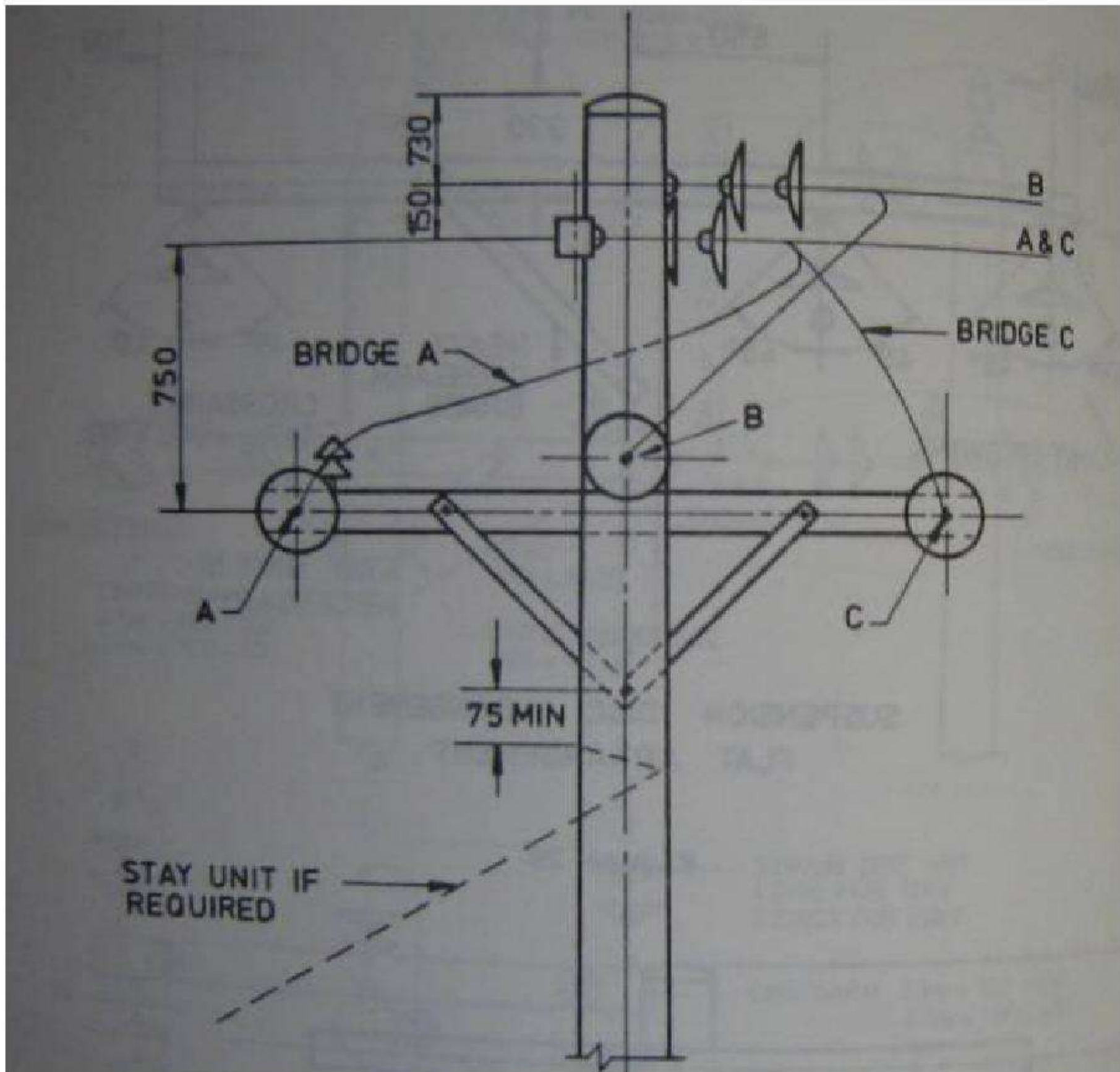

Section 2 – Overhead Lines and Installation

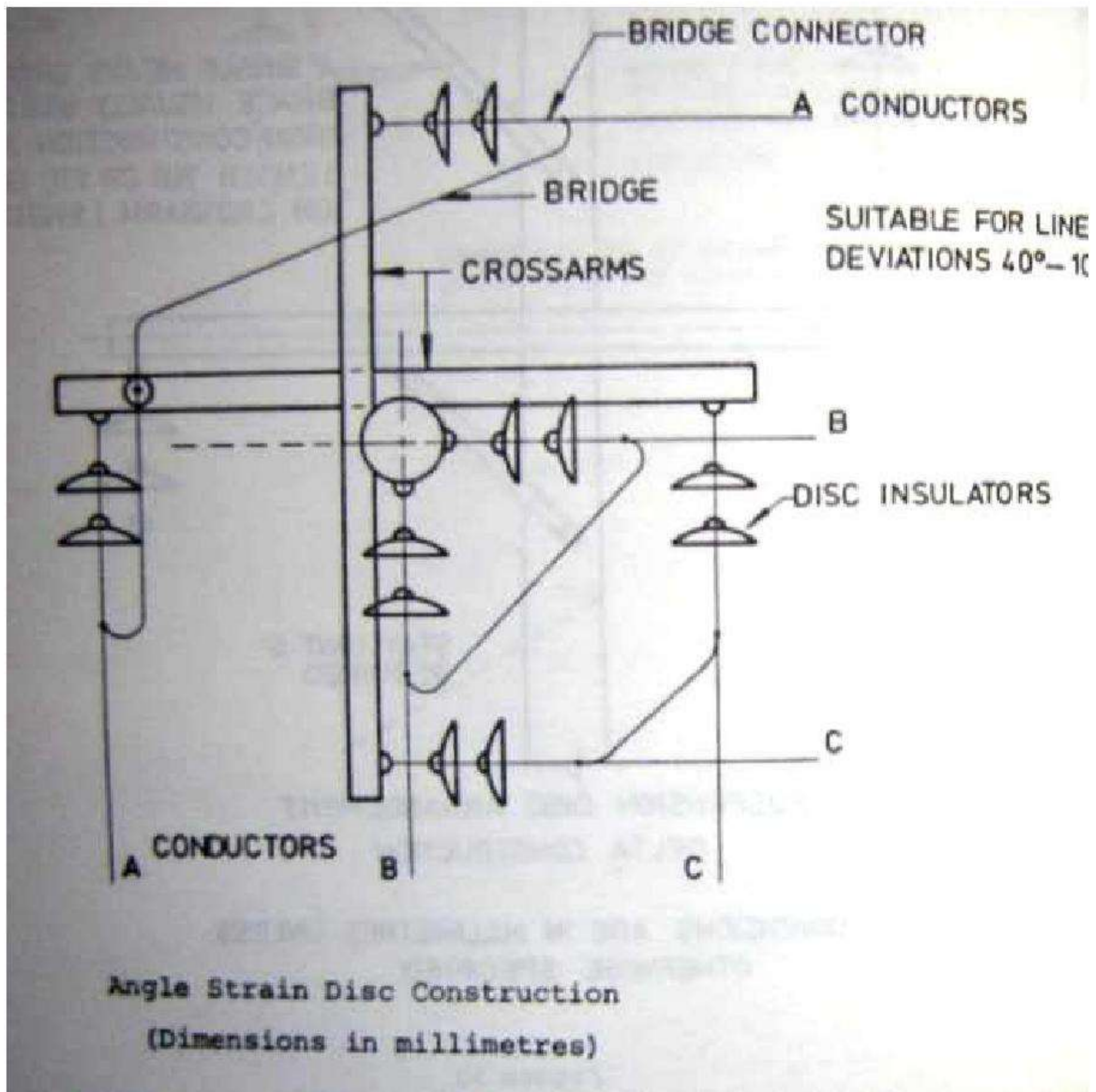

Section 2 – Overhead Lines and Installation

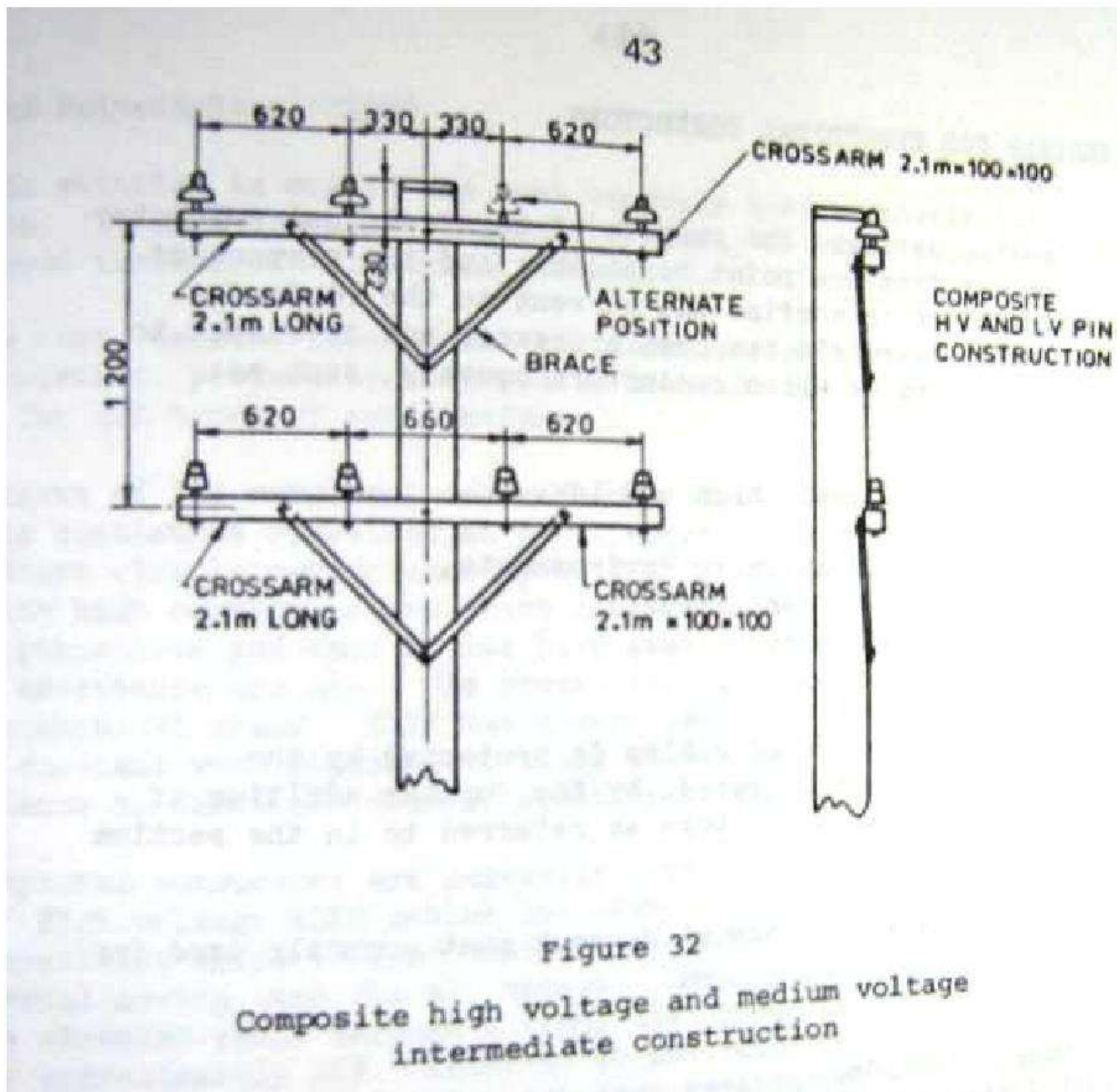

Section 2 – Overhead Lines and Installation

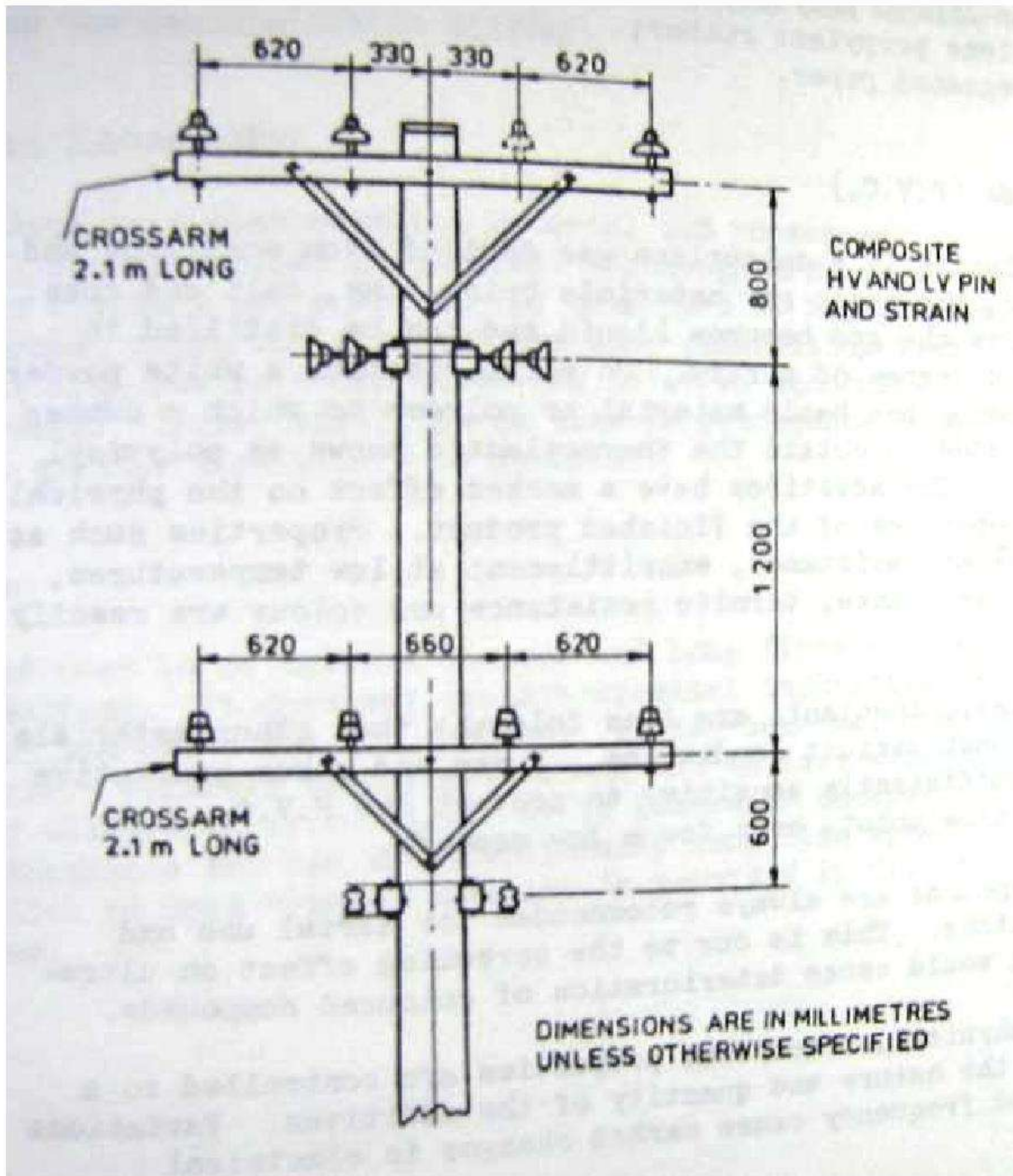

Section 2 – Overhead Lines and Installation

2.6 Recall regulations pertaining to over head lines

Notes and comments on some of the overhead line construction and maintenance regulations

Regulation 12 - Protection against corrosion

All iron and steel fittings must be protected by galvanising or other suitable means. It is necessary to have a minimum deposit of 460 grams of zinc per square metre and hot dip galvanising should be called in for in any specification for line fittings.

Regulation 13 – Insulators

These must be of adequate strength. Pin insulators must not be used for strain or termination construction.

Where the direction of an overhead conductor is changed there is a resultant load acting on the insulators in addition to the possible wind loading.

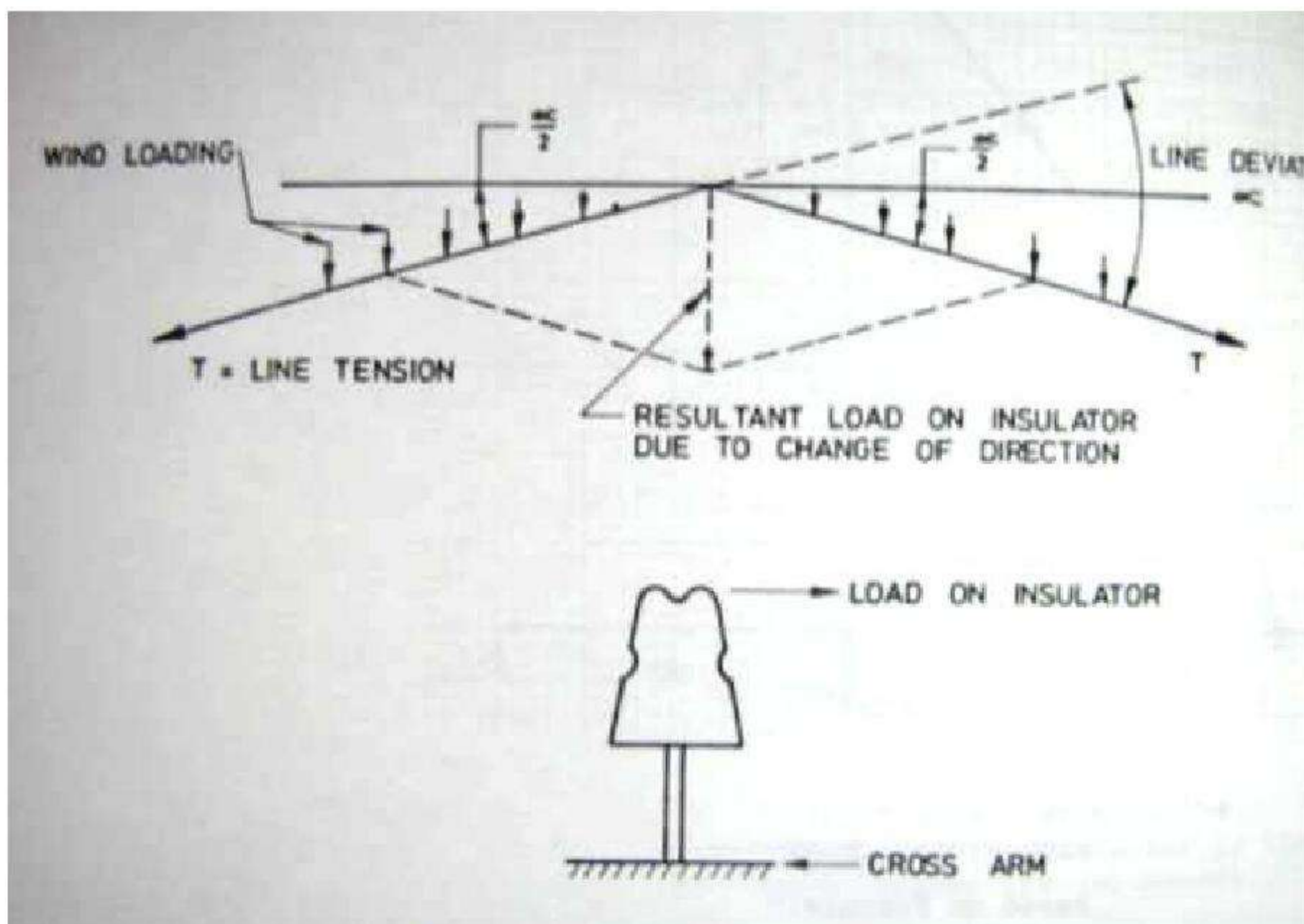

When a pin insulator is used, a bending moment is placed on the pin and this must be limited so that the pin is not excessively stressed.

As explained in Unit 1, pin insulators are designed for a failing load of 7kN or 11kN with a maximum working load of 40 per cent of the ultimate strength.

Section 2 – Overhead Lines and Installation

The permissible line deviation for pin type insulators is calculated as follows:

Let	w_ℓ	=	wind load on the conductor in newtons per metre
	ℓ	=	span length in metres
	T	=	maximum tension in the conductor in newtons
	α	=	angle of line deviation

The resultant force on the pin

$$= 2 T \sin \frac{\alpha}{2} + w_\ell \ell \cos \frac{\alpha}{2}$$

For small angles such as associated with pin insulators $\cos \frac{\alpha}{2}$ can be taken as unity and the expression reduces to:

$$\text{Force on pin} = 2 T \sin \frac{\alpha}{2} + w_\ell \ell$$

Example

Determine the maximum deviation allowed on an 11 kN pin insulator for a 7/3.50 hard drawn copper conductor with a span of 150 metres. The ultimate strength of the conductor is 26600 N, the wind load is to be taken as 500 Pa and the diameter of the conductor is 10.5 mm. The tension in the conductor must not be more than 50 per cent of the ultimate strength. The transverse loading on the pin insulator is not to exceed 40 per cent of the ultimate strength.

$$\text{Wind load} = 500 \times 10.5 \times 10^{-3} = 5.25 \text{ N/m}$$

$$\text{Pin load} = 2 T \sin \frac{\alpha}{2} + w_1 \ell$$

$$\frac{40}{100} \times 11000 = 2 \frac{26600}{2} \sin \frac{\alpha}{2} + 5.25 \times 150$$

$$\sin \frac{\alpha}{2} = \frac{3612.5}{26600}$$

$$= 0.1358$$

$$\frac{\alpha}{2} = 7.8^\circ$$

Maximum angle of deviation = 15.6°

To standardise line construction many supply authorities specify a limiting line deviation such as 10° for pin type insulators. For line deviations in excess of this, strain construction must be used.

As a comparison, the SAA Wiring Rules (Regulation 3.13.4.4) limits the change of direction of overhead lines to 30° where pin type insulators are used. However, these lines are limited to 60 metres span without approval of the supply authority.

Regulation 14 – Loading Conditions

Section 2 – Overhead Lines and Installation

The values stated should be learnt. The value of 500 pascals has been found by experience to be satisfactory.

Regulation 15 – Aerial Conductors

All conductors must be stranded and all normally available materials are allowed.

The minimum ground clearances must be maintained under conditions of increased sag because of the heating effect of the current.

Regulation 16 – Conductor Sags and Tensions

The conditions specified in this regulation must be known.

Regulation 17 – Foundation for Supports

The foundations for supports for aerial conductors must be capable of bearing any load to which they are likely to be subjected.

The use of pole stays involves vertical component which increases the vertical load on the pole. Suitable pole footings were dealt with previously.

Staying of poles is usually necessary on high voltage lines at terminations and all intermediate poles where there is a large deviation in the line. Similar staying may also be needed for poles with lines up to 650 volts if the soil is of poor bearing quality.

The essential components for the staying of a pole are:

1. Galvanised stay wire of suitable strength.
2. Strain insulator to insulate the strain wire within eight feet of the ground.
3. Wire rope grips for strain wire, or preset fittings.
4. Stay anchorage.
5. Batten

Figure 13 illustrates the overall constructional features of a ground stay. The various stay anchorages are shown in Figure 14. A typical stay rod is shown in Figure 15. Wire clips and the method of fixing these are shown in Figure 16.

Regulation 18 – Supports

The percentage of the ultimate strengths of various parts of overhead lines are stated in this regulation. The values are 50% for steel, 25% for wood, 40% for stay wires and insulators.

For insulators, the term, electro-mechanical strength, is used. This is the maximum tension which can be applied without causing the insulator to puncture and fracture when a voltage of 75 per cent of the dry flashover voltage is simultaneously applied to the insulator.

Regulation 19 – Earthing and Insulating of Metalwork

Effectively earthed means that such earthing prevents the potential of exposed metalwork within 2.4 metres of the ground from exceeding a sustained voltage of 32 volts a.c.

Further notes on earthing will be given in a unit devoted to earthing.

Section 2 – Overhead Lines and Installation

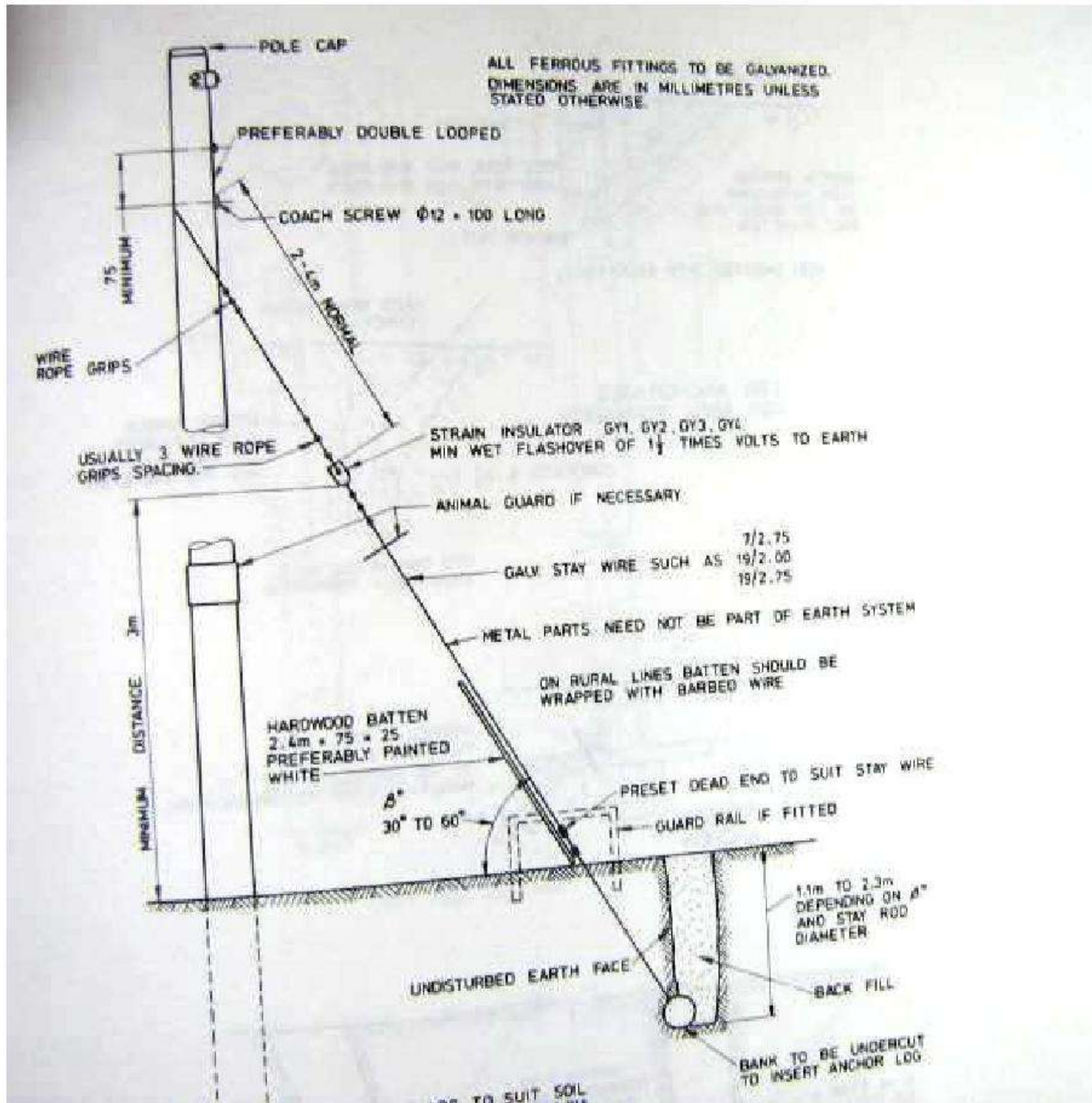

Section 2 – Overhead Lines and Installation

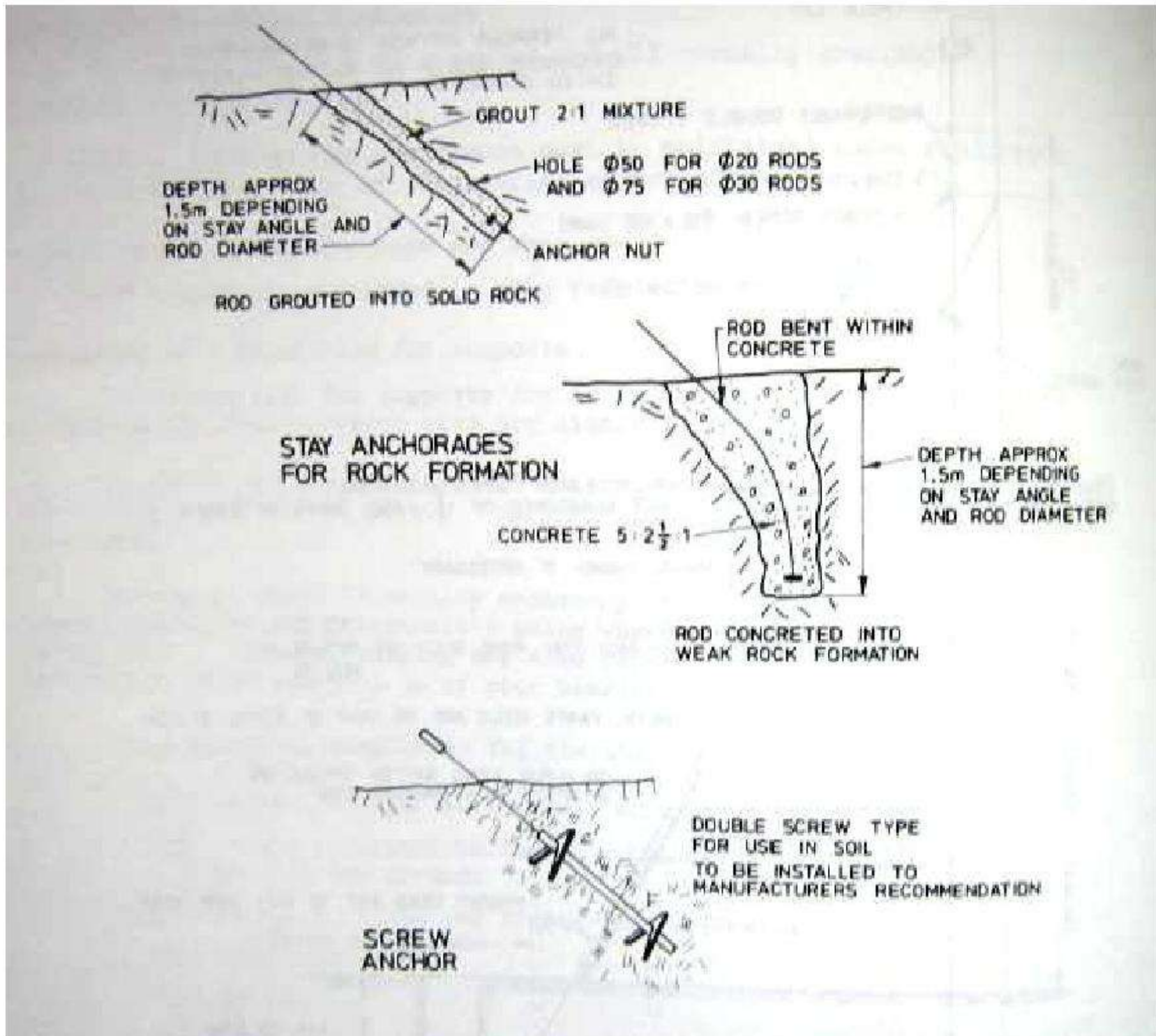

Section 2 – Overhead Lines and Installation

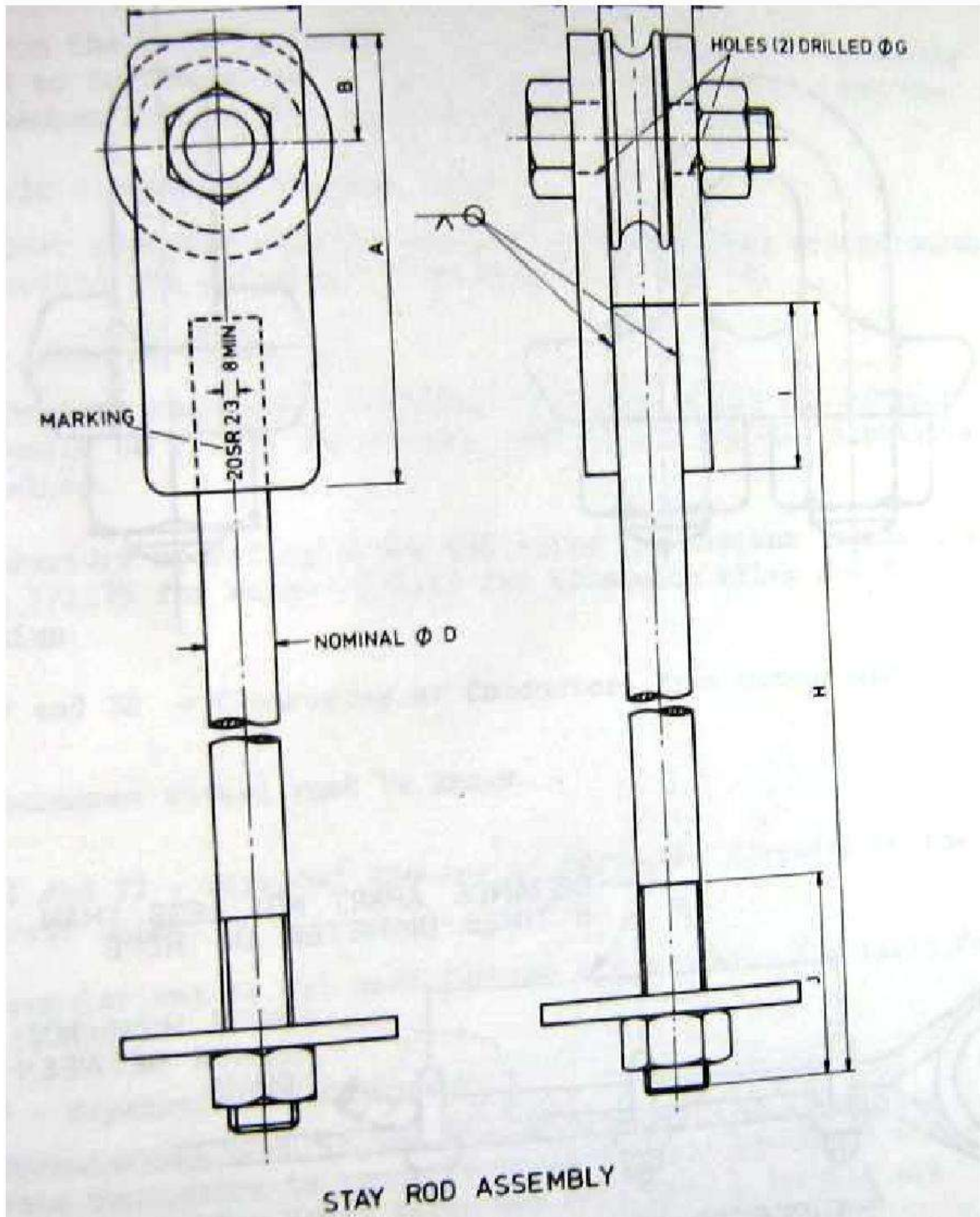

Regulation 20 – Prevention of Unauthorised Climbing

Apart from the methods listed in this regulation, anti climbing guards may need to be fitted in areas frequented by children, and the attachment of danger notices may be desirable.

Regulations 21 – 26 – Overhead Service Lines

These cover specific applications to service lines, and examples of these regulations are illustrated in Figures 17 and 18.

Regulation 28 – Size of Conductors

Section 2 – Overhead Lines and Installation

For conductors required to operate up to 650 volts the minimum standard size would be 7/1.25 for copper, and 7/1.75 for all aluminium and aluminium alloy.

For conductors operating above 650 volts the minimum standard size conductors are 7/1.75 for copper 7/2.25 for aluminium alloy and 7/2.50 for all aluminium.

Regulations 29 and 30 – Clearance of Conductors from Ground and Structures

The clearances stated must be known.

Regulations 31 and 32 – Vertical Spacing of Different Circuits on the Same and Separate Poles

These regulations do not need further explanation; the limit for distribution is 33kV.

Regulation 33 – Separation of Conductors

Many formulae have been in use for calculating the separation required between conductors to comply with such a regulation as this. The Energy Authority of New South Wales has developed a formula and it is recommended that this should be used on all overhead line construction.

The conductors of the same or different circuits attached to a fixed support should have a minimum equivalent horizontal separation from each other at any point of the span which should not be less than the largest of either A, B, C or D for the situation concerned.

- A. For conductors of the same circuit or different circuits attached to a fixed support, the equivalent horizontal separation 'S' according to the sag at any point of the span shall be calculated as follows;

$$S = 0.0076 + 0.3\sqrt{D - 2.13} + 0.083\sqrt{D} \times \frac{(d)^2}{({}^w r)}$$

S = equivalent horizontal spacing in metres

D = Sag (metres) at 50° C and no wind

D = overall diameter of conductor in millimetres

${}^w r$ = resultant load (N/m) due to gravitational force on Conductors and 500 Pa horizontal wind load on the Conductor.

The Energy Authority publishes a monograph to solve this formula and reference should be made to their design manual.

Section 2 – Overhead Lines and Installation

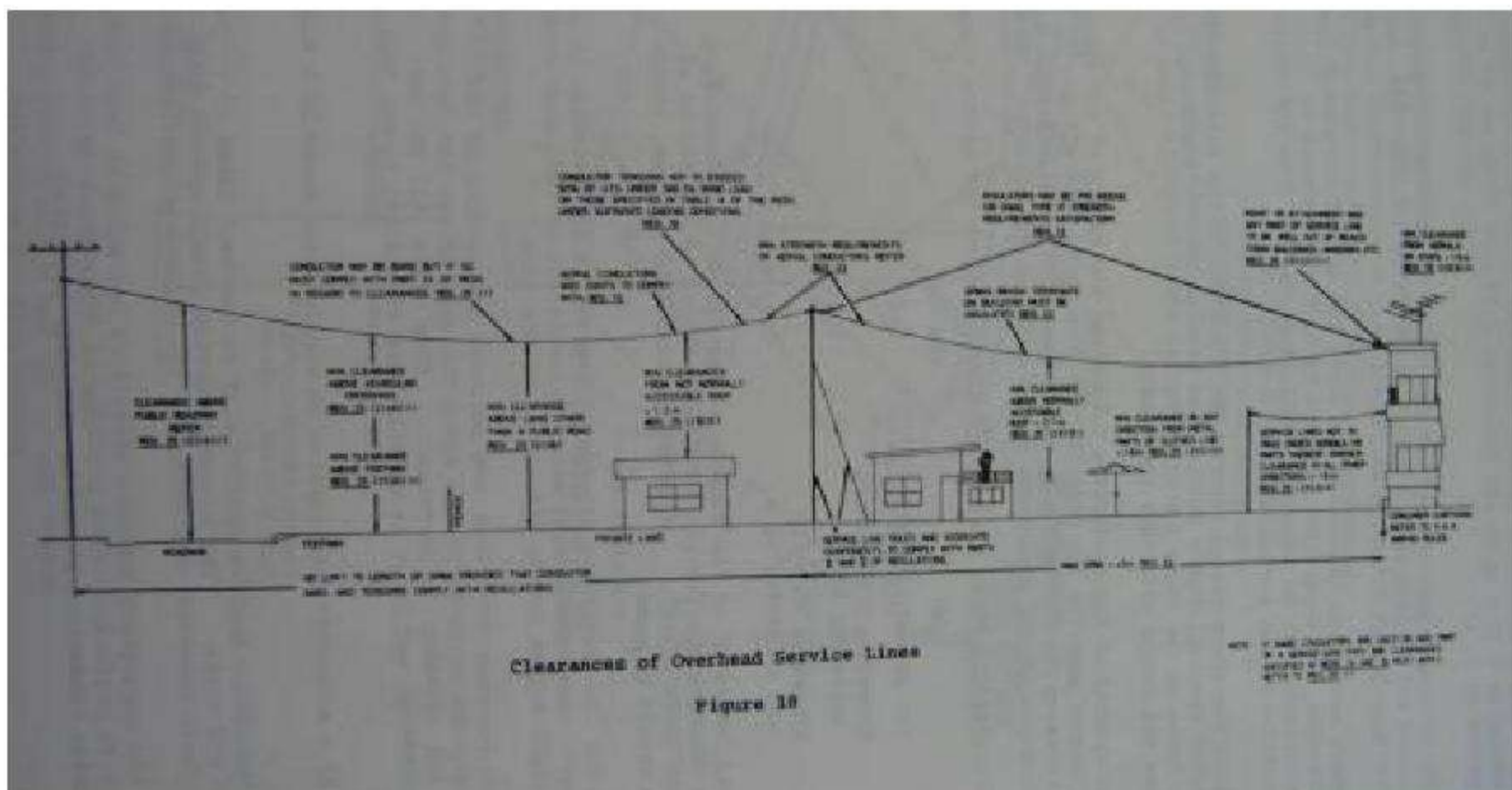
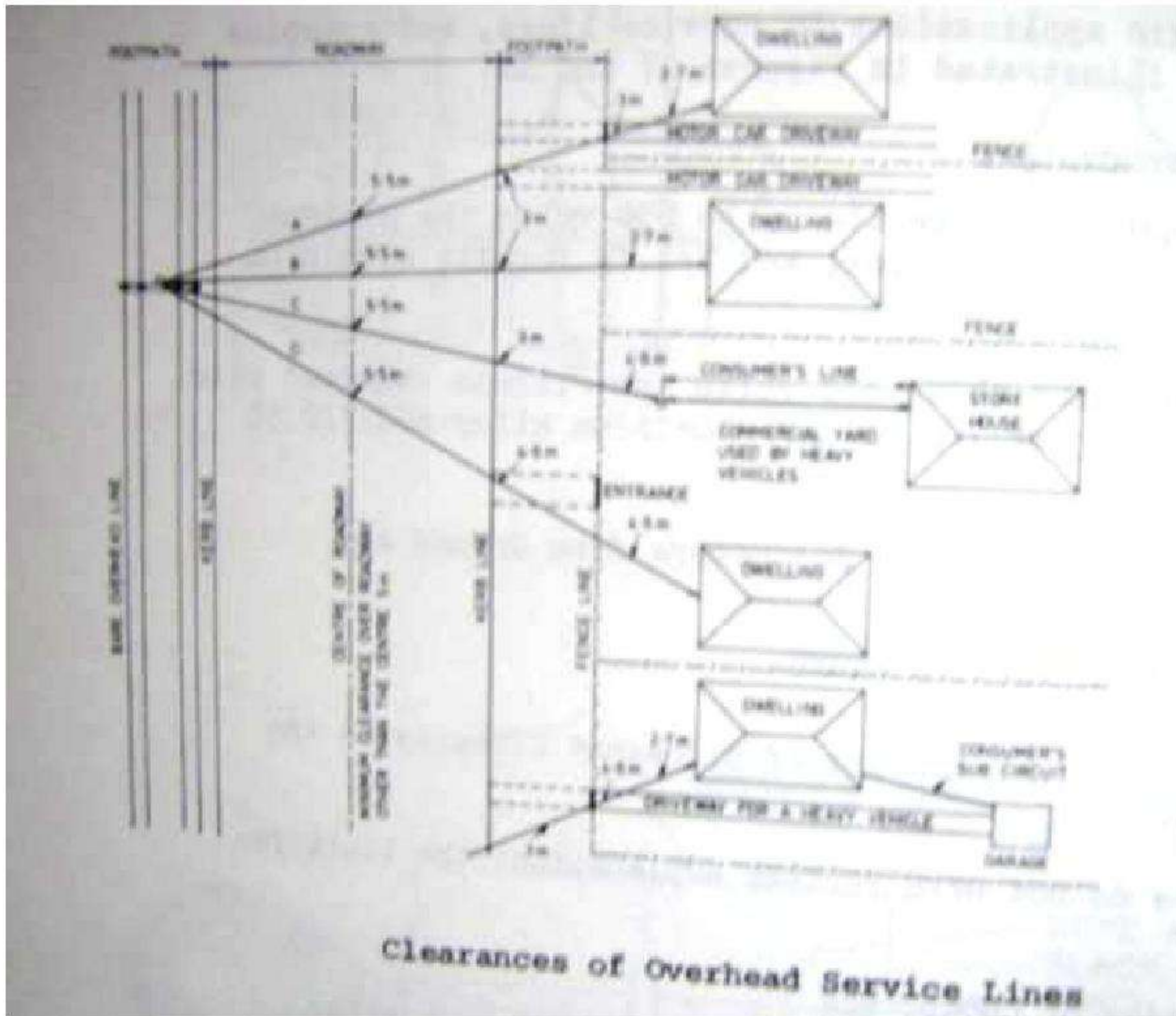

Section 2 – Overhead Lines and Installation

- B. The minimum separation between conductors of the same circuit should be 0.38 m up to and including 11kV plus 10 mm per kV in excess of 11 kV.
- C. The minimum separation between conductors of different circuits should not be less than 0.6 m up to and including 650 volts, and 1.2 m up to and including 33 kV.
- D. Where suspension insulators are used, and are not restrained from movement, the separation required by A, B and C should be maintained with an insulator swing of 45 degrees from the vertical position of one string only.

While the above design factors are important in the calculation of conductor spacing, Supply Authorities usually prepare standard drawings based on the above for distribution work, to enable lines to be erected and comply with this regulation.

The spacing of the conductors determines the design of the cross arms. Common practice for distribution work is to have 450 mm clearance between the insulators on the cross arm for medium voltage and 600mm clearance at the insulators on the cross arm for 11 kV.

The SAA Wiring Rules gives the following values for medium voltage:

Span	Spacing
Not exceeding 9m	0.2m
Not exceeding 60m	0.45m

It was indicated in the summary of Regulation 13 – Insulators, that angle construction for pin insulators should be limited to an angle of the order of 10 degrees. When angles exceed 10 degrees, strain insulators should be used.

When the line deviation exceeds 30 degrees it is advisable to use twin cross arm construction with shackle insulators so that each cross arm is at right angles to the direction of the line.

If two separate cross arms are not used the spacing of the conductors may not be great enough along the span unless the insulator spacing at the cross arm is increased. This would call for non standard cross arms and so it is usually economical to use twin cross arms

Regulation 35 – Automatic Interruption to Supply in the Event of a Fault Condition.

This regulation applies specifically to overhead lines of voltages in excess of 650 volts. The automatic device should operate within two seconds for fault currents equivalent to the maximum prospective values.

While the regulation excludes conductors operating at less than 650 volts, it is preferable where problems of discrimination do not occur that these conductors should be similarly protected.

Section 2 – Overhead Lines and Installation

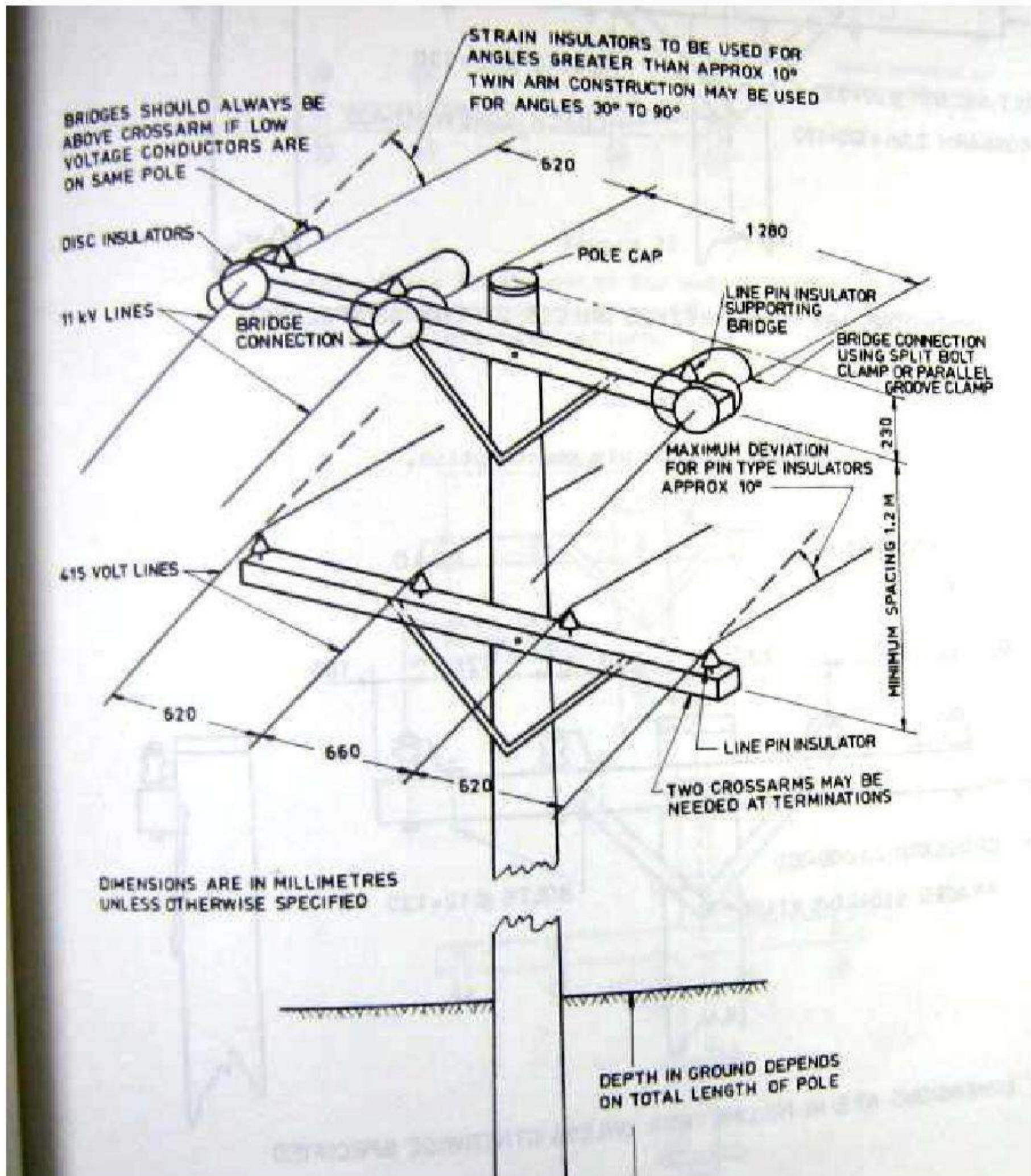

Section 2 – Overhead Lines and Installation

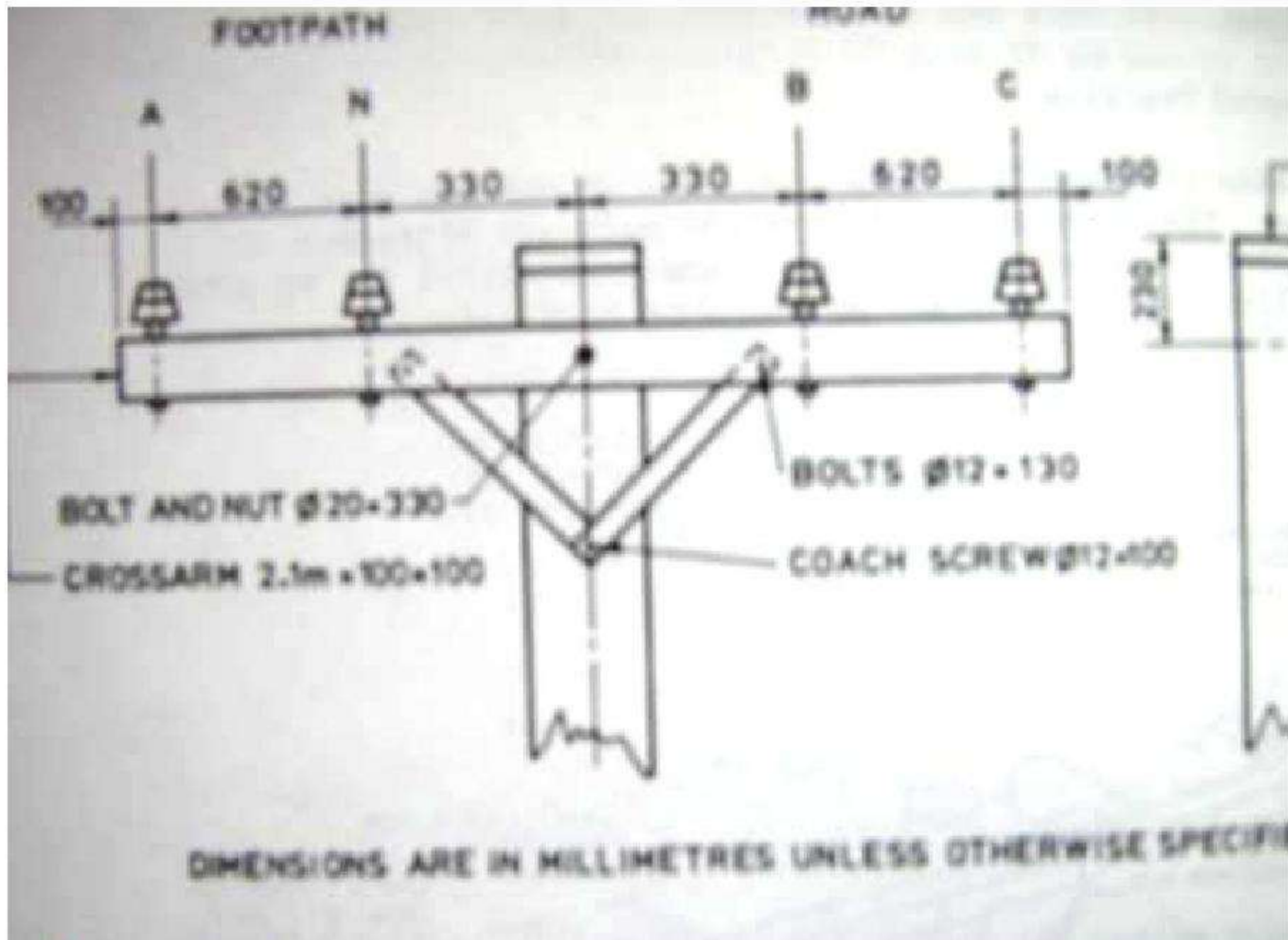

Section 2 – Overhead Lines and Installation

2.7 Measure ground levels, deviation angles and compass bearings

Basic Survey Methods

In order to fully understand the above techniques, an appreciation of the methods of obtaining the required information is necessary. By ignoring instruments and equipment, the techniques can be broken down into *four basic methods* of collecting information. Each method relies on the simple principle that if *two* points are established, a *third* point can be located in relation to them by various forms of measurement.

- a) **Linear measurement** – measurement having only one dimension, i.e. length. Such a measurement in a straight line would give the shortest distance between any two points. When two linear measurements are multiplied together, square measure or area results (see Chapters 2 and 3).
- b) **Angular measurement** – the measurement of the angle formed when two straight lines (or directions) meet (see Chapter 6). Although an angle possesses magnitude (i.e. size), it cannot be estimated as a length, breadth, or area; therefore special units are used, i.e. degrees and radians.

In order to discuss the methods in detail, it is necessary to state the following:

- i. *The situation* In Fig. 1.3, the line AB represents a straight wall, while C is a point (say a vertical metal post) some distance away.
- ii. *The requirement* To produce a two dimensional plan, drawn to some suitable scale, showing the post in true relationship to the wall. (Note: Drawing out the measured information is known as plotting the survey.)
- iii. *The problem* How can the post be located by measurement in relation to the wall in order that the requirement may be fulfilled?

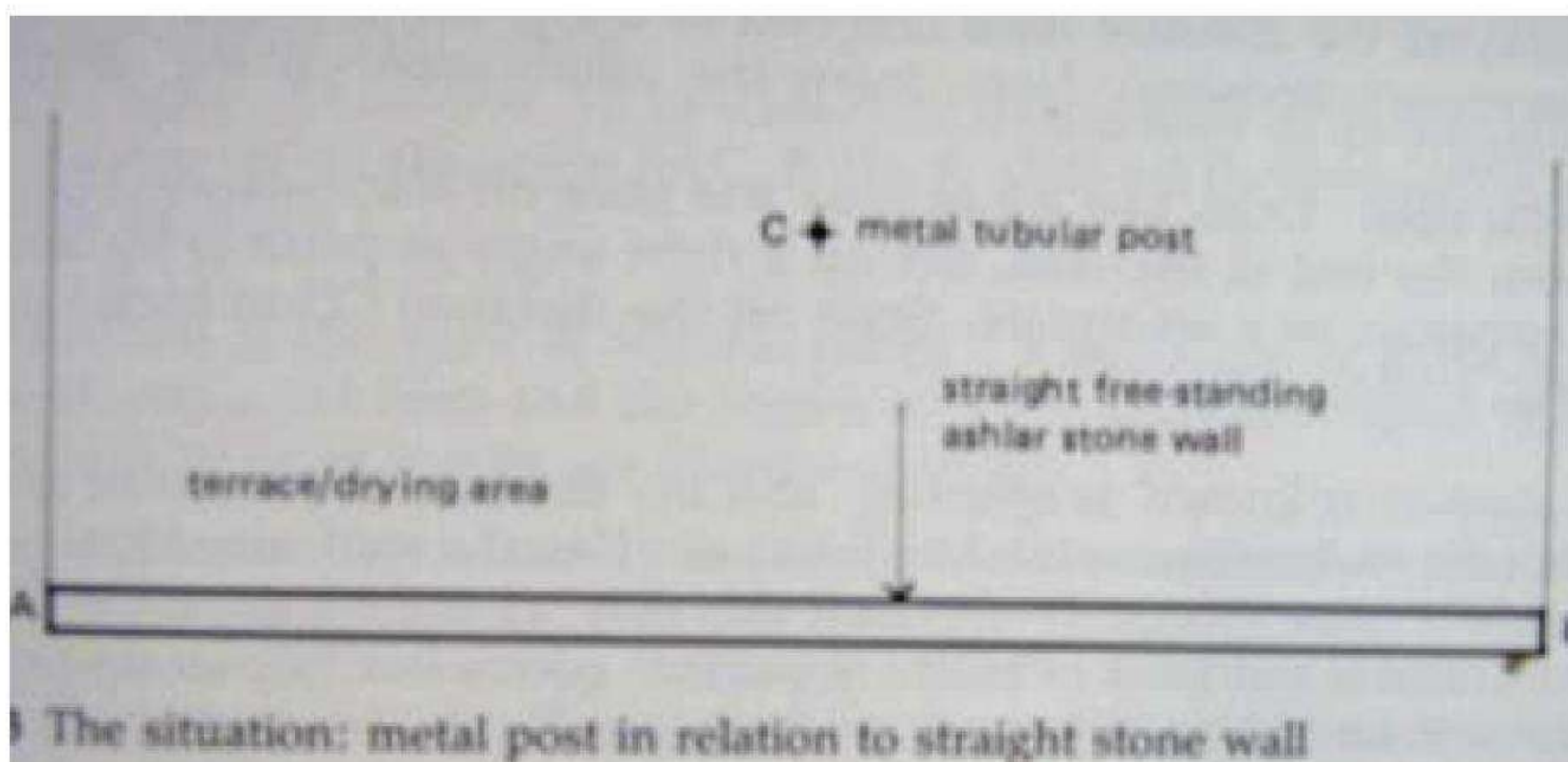

Section 2 – Overhead Lines and Installation

1.4.1 Method 1 – intersecting arcs

- On site* Measure the horizontal distances AB, AC, and BC and note down the information on the sketch (Fig. 1.4(a)).
- In the office* Draw line AB to scale. Using compasses, swing an arc from A with the radius set to the scale length of AC. Similarly, swing an arc from B with the radius set to the scale length of BC. The intersection of these arcs will locate point C (Fig. 1.4(b)).

This method is the basis of *chain-survey technique* and may be used for land survey, building plans, etc. as will be discussed in Chapters 2, 3, and 7.

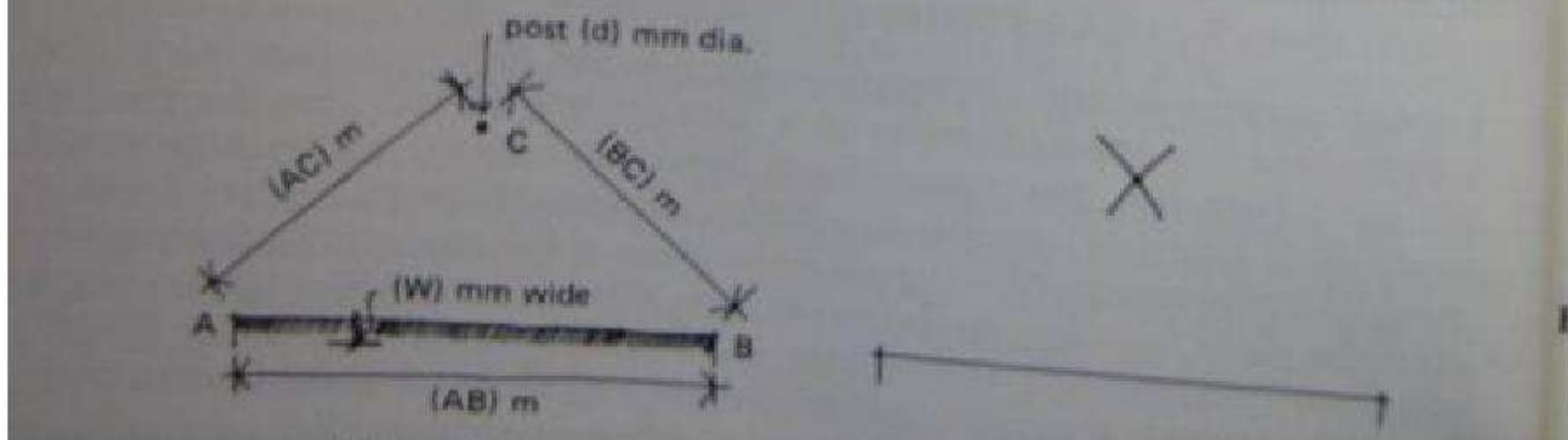

Method 3 – Polar Co-ordinates/radiation

- On site* Measure the horizontal angle BAC the length AB and the horizontal distance from point A to point C. Note down this information on the sketch (Fig.1.6(a)).
- In the office* Draw line AB to scale. Use a protractor or an adjustable set square to set off the angle BAC. From A, scale off the distance measured to locate point C.

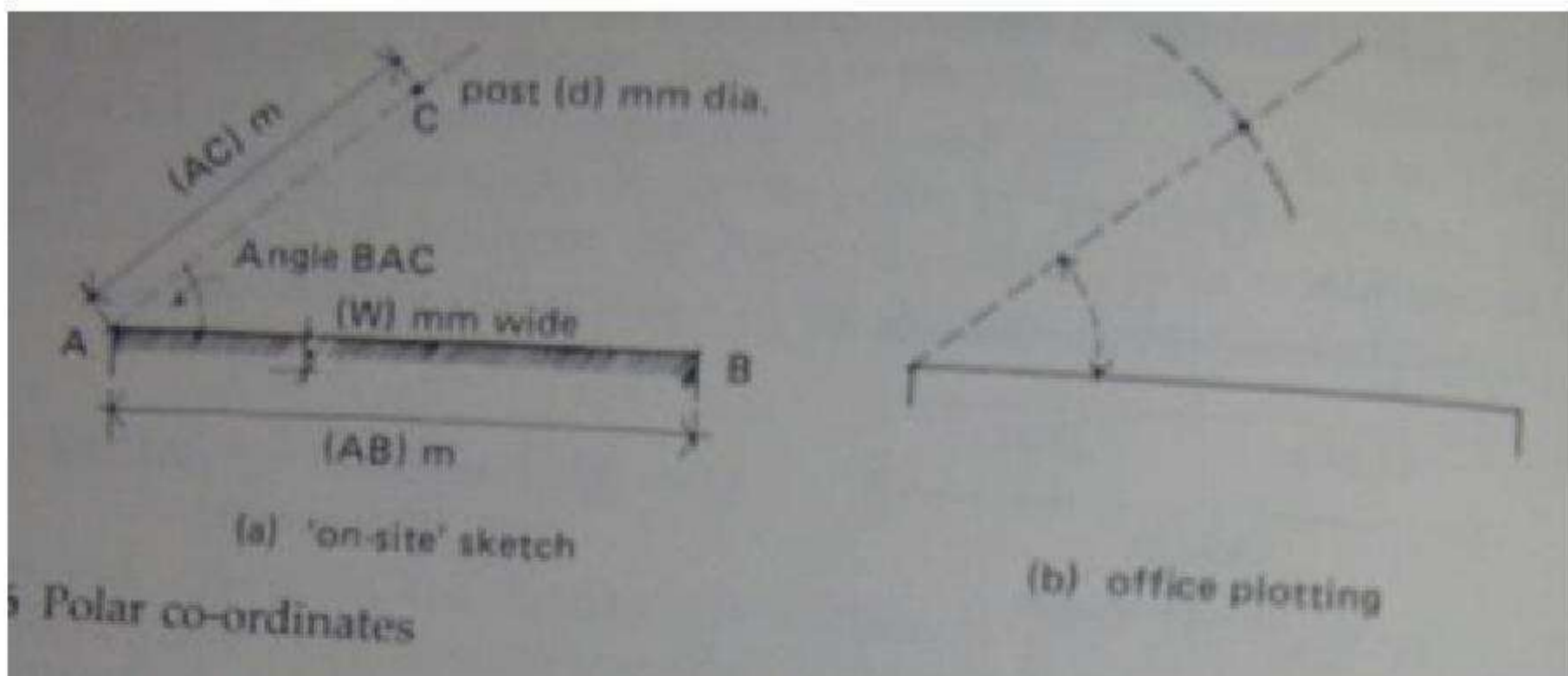

5 Polar co-ordinates

Section 2 – Overhead Lines and Installation

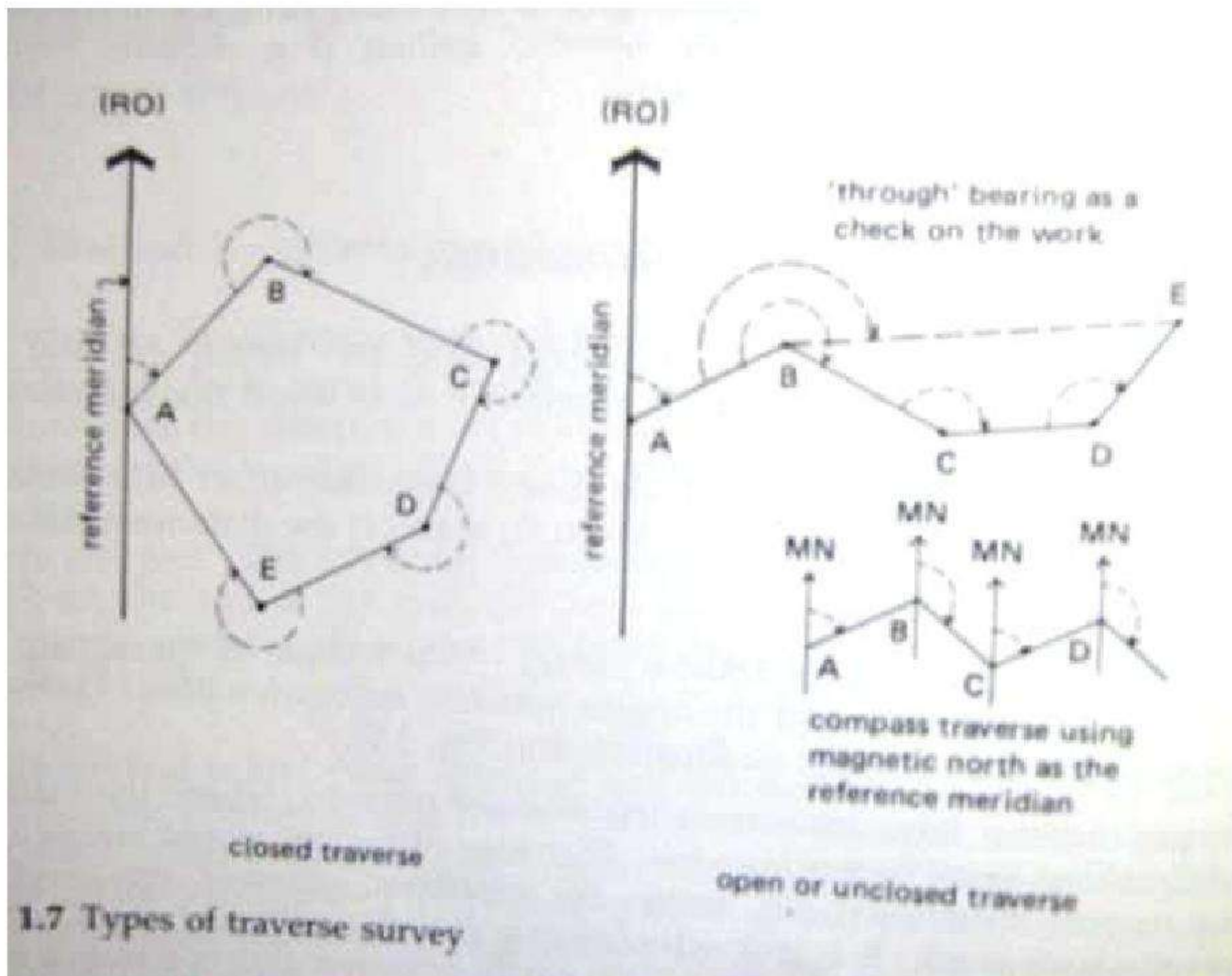

Section 2 – Overhead Lines and Installation

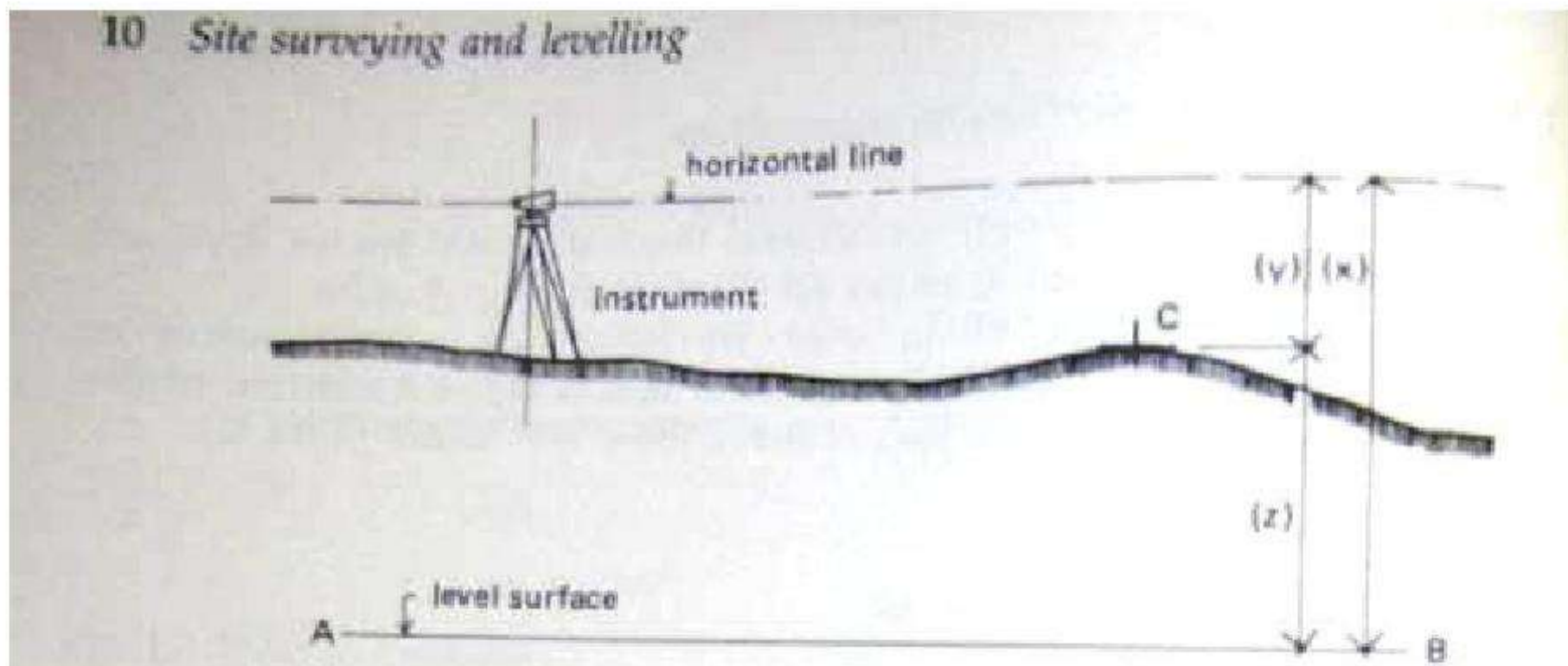
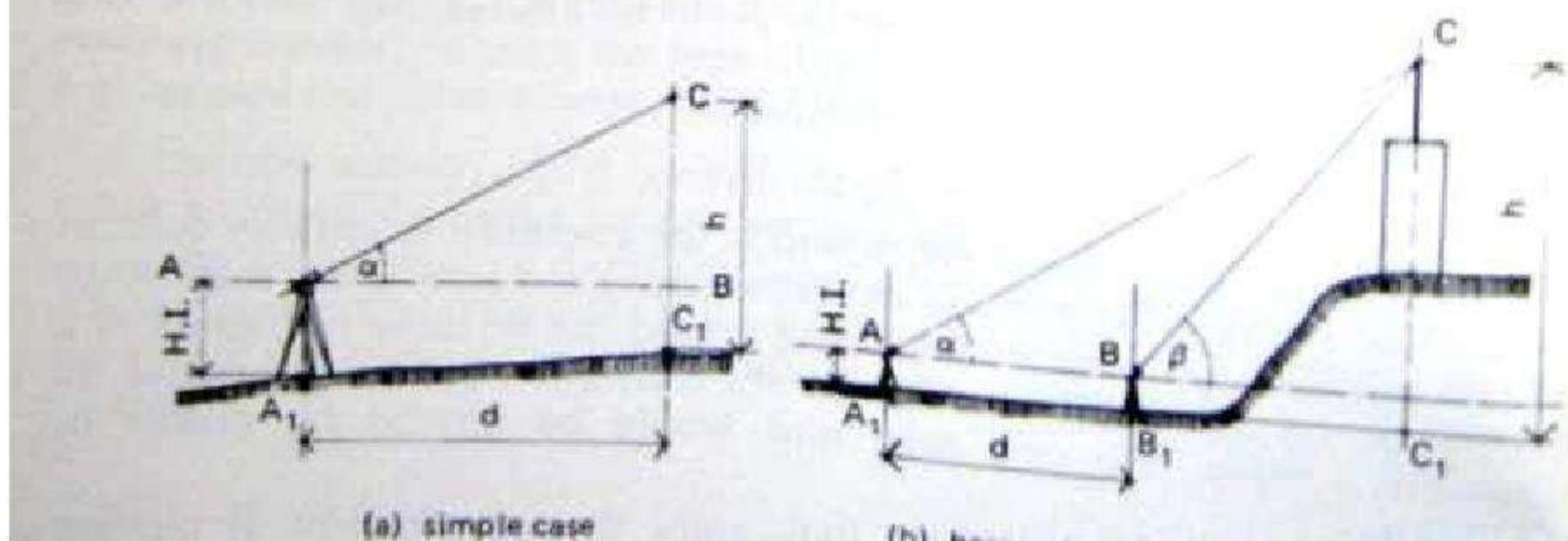

Fig. 1.9 Ordinary levelling. The difference in height (x) between the level surface and the horizontal line can be calculated and the vertical distance (y) from horizontal line to point C can be measured. The height (z) of point C above AB is given by $(x - y) = z$.



Site Surveying and levelling

- a) The use of maps will vary with the scale and the following text gives a brief account of each of the four maps mentioned above, along with an indication of some possible uses.
 - i. 1:25 000 is a relatively small scale map and the smallest scale at which field boundaries are shown. Contour lines are drawn at 10m V, I,
 - ii. Maps at this scale would be used
 - When planning large scale engineering works involving gradients of roads, sewers and pipes;
 - Extensively when involved with the flow of rivers and streams (flooding abatement, irrigation, reservoirs);
 - Where the contour lines provide a means of solving problems indivisibility and clearance between points;

Section 2 – Overhead Lines and Installation

- To illustrate aspects of regional planning because the small set enables an 'overview' to be given.
- iii. 1:10 000 is almost accurately drawn to scale although some times widths are increased to accommodate road names. Conventions (signs and symbols) are used to represent features in a semi pictorial manner, e.g. orchard, quarry, cutting, embankment, etc, whilst individual parcels of land are shown, together with fences and fields. Contour lines are drawn at 5m V.I., although this is increased 10m V.I. in mountainous areas.

Maps at this scale would be used

- By the surveyor involved in estate management because individual tenant holdings can readily be distinguished;
 - For design of schemes for water supply;
 - For geological surveys;
 - By town planners and urban designers to illustrate initial proposals.
- iv. 1:2500 is a highly detailed map providing accurate information to a fairly large scale. A distinctive feature of the map is that each parcel of land is identified by a number and has its area printed below (hectares and acres) which makes the map extremely useful for rating and valuation purposes as well as location plans for local Authority submissions.
- v. 1:1250 is the result of a double enlargement of the 1:2500 sheet which renders it no more accurate than the smaller map. It is the largest scale of mapping published by the O.S., although in the 19th century and early 20th century 1:500 scale maps were produced and are still to be found in many offices. At 1:1250 scale all streets are named, as are public and other buildings having a specific name. Remaining buildings are numbered.

Maps at this scale are used.

- In part, as block plans or location plans when making applications for planning and building regulation approval;
- By designers for initial layouts;
- By statutory undertakings to record the positions of power lines.

Section 2 – Overhead Lines and Installation

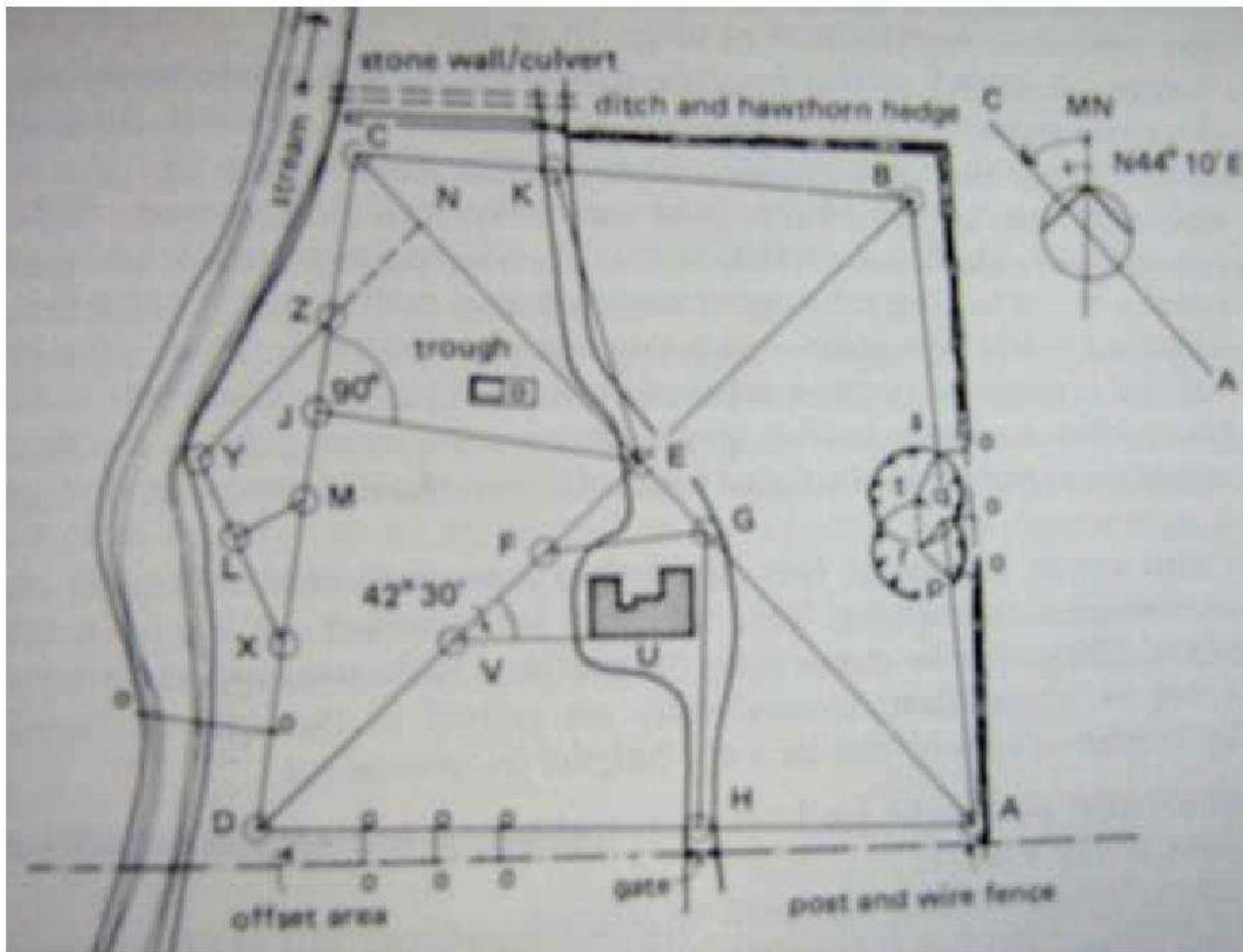

Chain lines: AB, BC, CD, DA, DB, and AC

2.1.2 Survey Stations

A survey station is a point of importance at the beginning or end of a chain line, or at the junction of one line with another. It is usually marked by the insertion into the ground of a vertical ranging pole. On hard surfaces this point may be marked by a stud, while on normal ground where a more permanent mark is required, a wooden peg (50 mm square) should be driven in, which can be easily located at all times. It is not a bad idea to make a dimensioned sketch of the position of the pegs so that these may be relocated if a peg is lost or accidentally removed. For station points on hard ground which are not to be of a permanent nature, a stand should be used to support the rod vertically.

Stations should be placed as may be found convenient at the corner of areas or at prominent points, so that the lines joining them are as close as possible to the boundaries of the site in order to keep offset measurements short (See Section 2.1.7)

2.1.3 The Base Line

This is normally the longest of the chain lines forming the *pattern of triangles*, and should, if possible, be laid off on level ground through the centre of the site and encompass the whole length of the area. A compass bearing should be taken to fix its direction, which in turn will fix the direction of all other lines and allow the position of north to be determined. All survey drawings require a drawn north point.

Section 2 – Overhead Lines and Installation

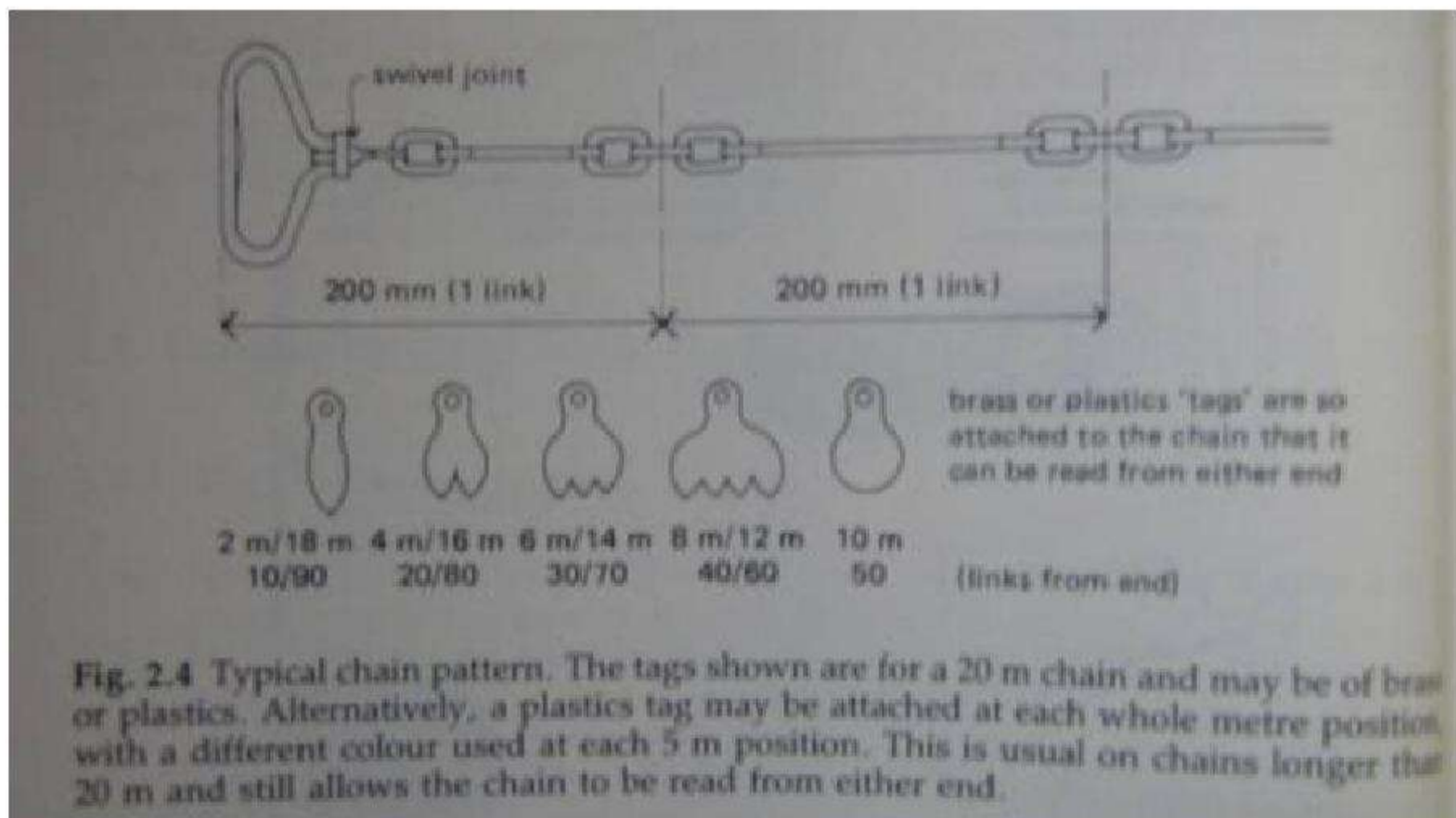
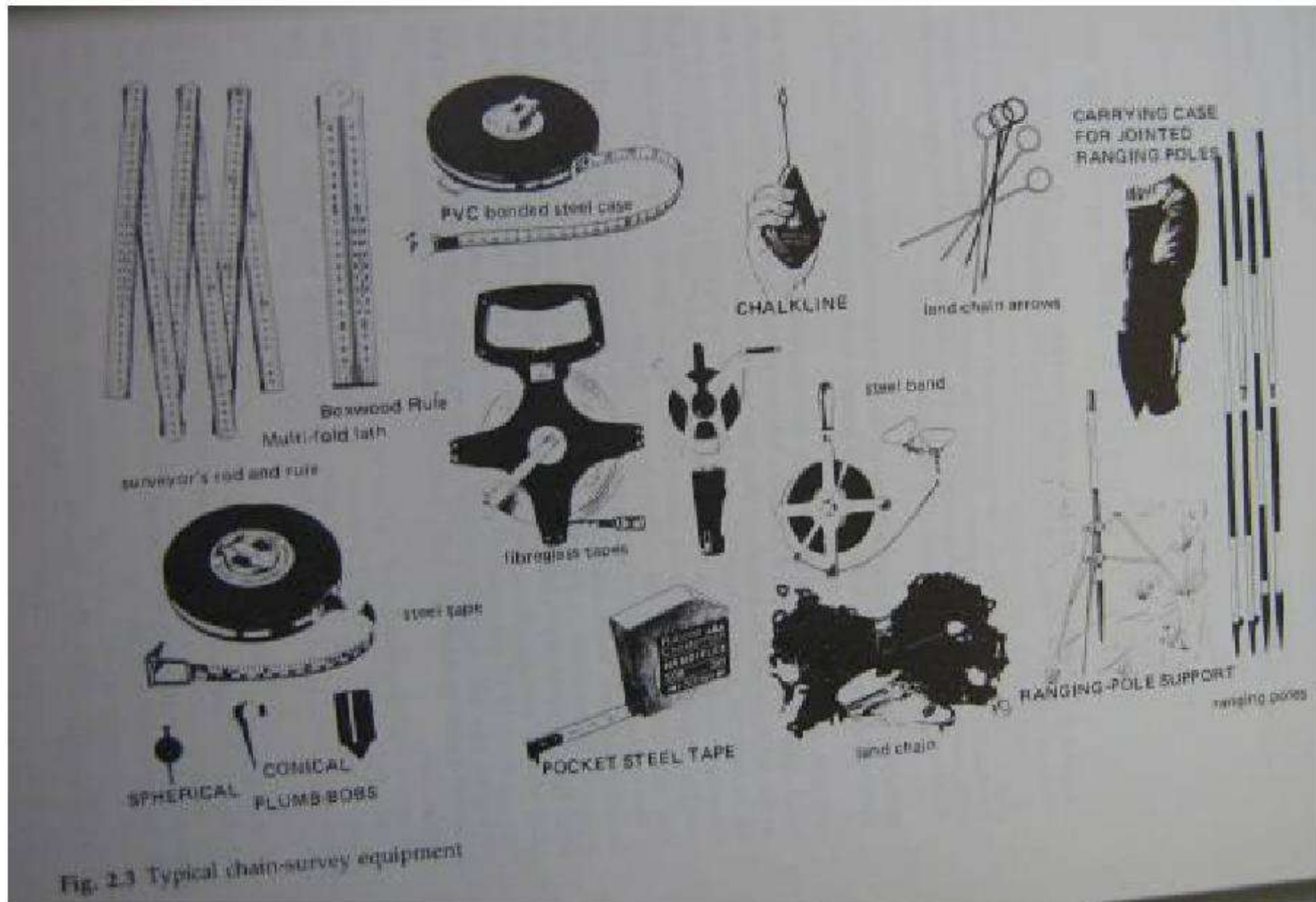

2.3.6 Tapes

A tape is used for taking subsidiary measurements in the field. It is suitable for taking offsets, which are measurements taken from, and at right angles to, the chain line, or to fix adjacent points as on a boundary.

Section 2 – Overhead Lines and Installation

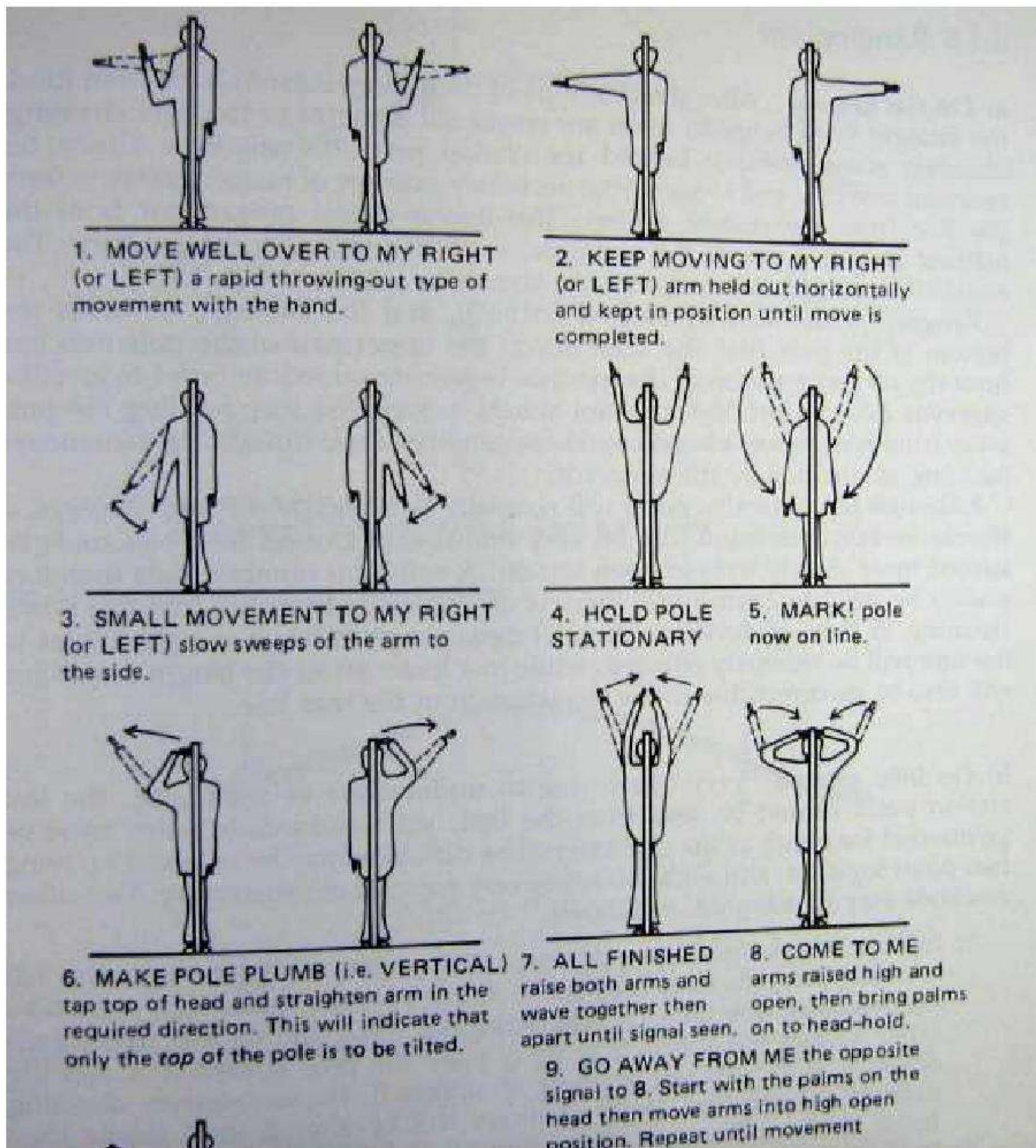

2.4.4 Laying-down the Chain

The leader, equipped with his ten arrows, drags the chain until he is brought up by a gradual pull and directed into line by the follower. Once alignment is effected, an arrow is inserted which marks the measurement of one chain length. Care must be taken to ensure that arrows are inserted *vertically* and on the side of the *vertical handle*, so that no error equal to the thickness of an arrow or the thickness of the handle is .

- b) **On hilly ground** Very often, due to undulations of some size, the last station point cannot be seen from the first, yet intermediate poles must be positioned for lining in the chainmen. The difficulty may be resolved by tying two poles together, although this is not very accurate or satisfactory. Two other methods may be adopted, as follows.

Section 2 – Overhead Lines and Installation

- i. In Fig. 2.8, A and B are the two stations seen in plan, with the hill between them (as shown by the section). Two assistants with poles take up positions, one each side of the hill, at C_1 and D_1 and facing each other so that the observer at C_1 can see the pole at station A and the observer at D_1 can see the pole at station B. By successfully directing each other into line, their positions will be altered until finally the finish at C and D exactly on the line AB and then the poles are inserted.
- ii. In Fig.2.9. A and B are again the two stations with the hill intervening so that A cannot be seen from B and vice versa. A trial line (known as a random line) is set out from A with poles erected at C_1, D_1 , etc. and will end at B_1 (unless by the greatest of good fortune the line ends on B, where there would be no problem). There is therefore an error at the end of the line amounting to BB_1 , which measured, AC_1, AD_1 and AB_1 , are also measured. By application of the principle of similar triangles, it is found that triangle ADD_1 is similar to triangle ABB_1

$$\therefore \frac{DD_1}{AD_1} = \frac{BB_1}{AB_1} \text{ or } DD_1 = BB_1 \times \frac{AD_1}{AB_1}$$

Similarly the shift for any other pole is calculated.

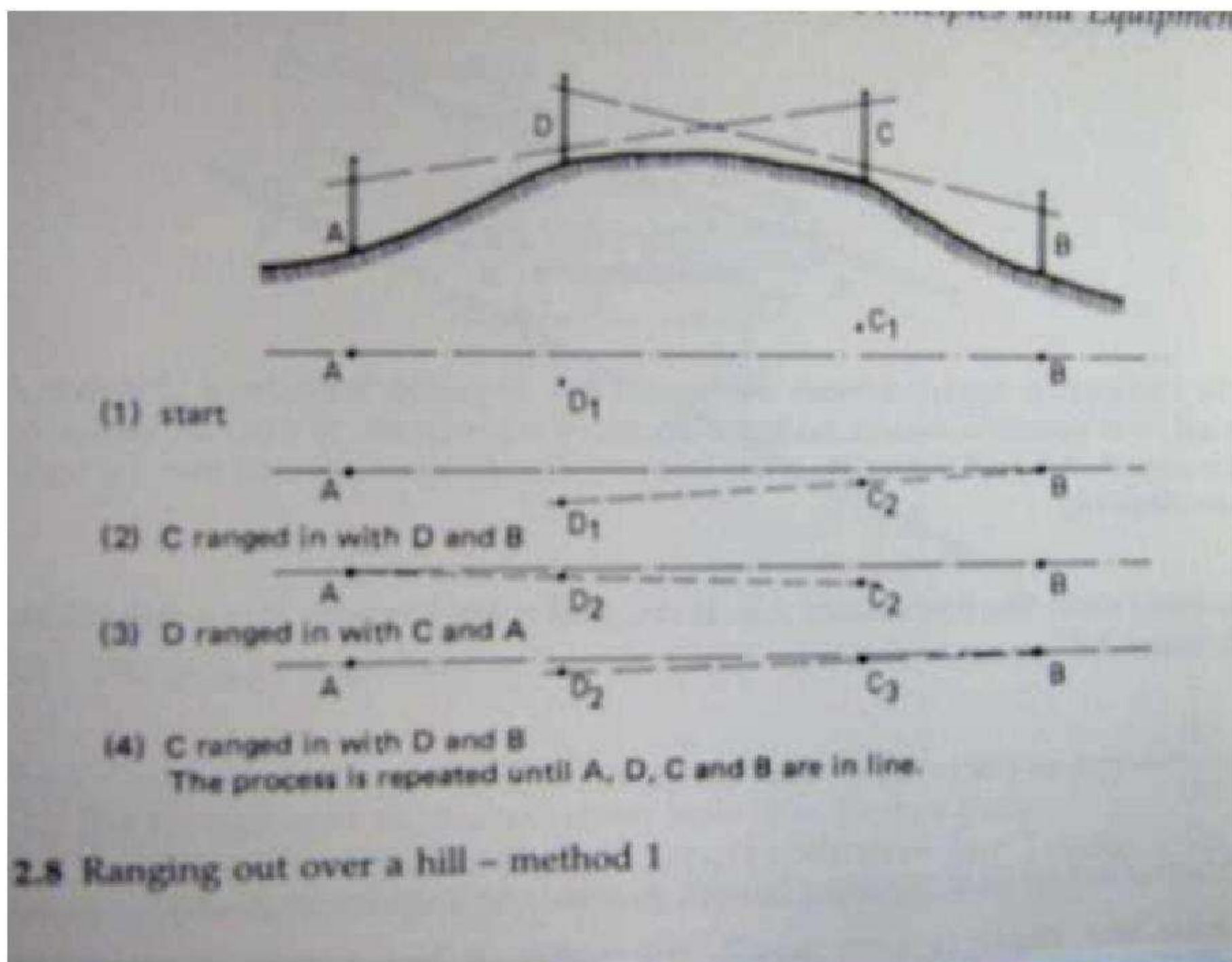

Section 2 – Overhead Lines and Installation

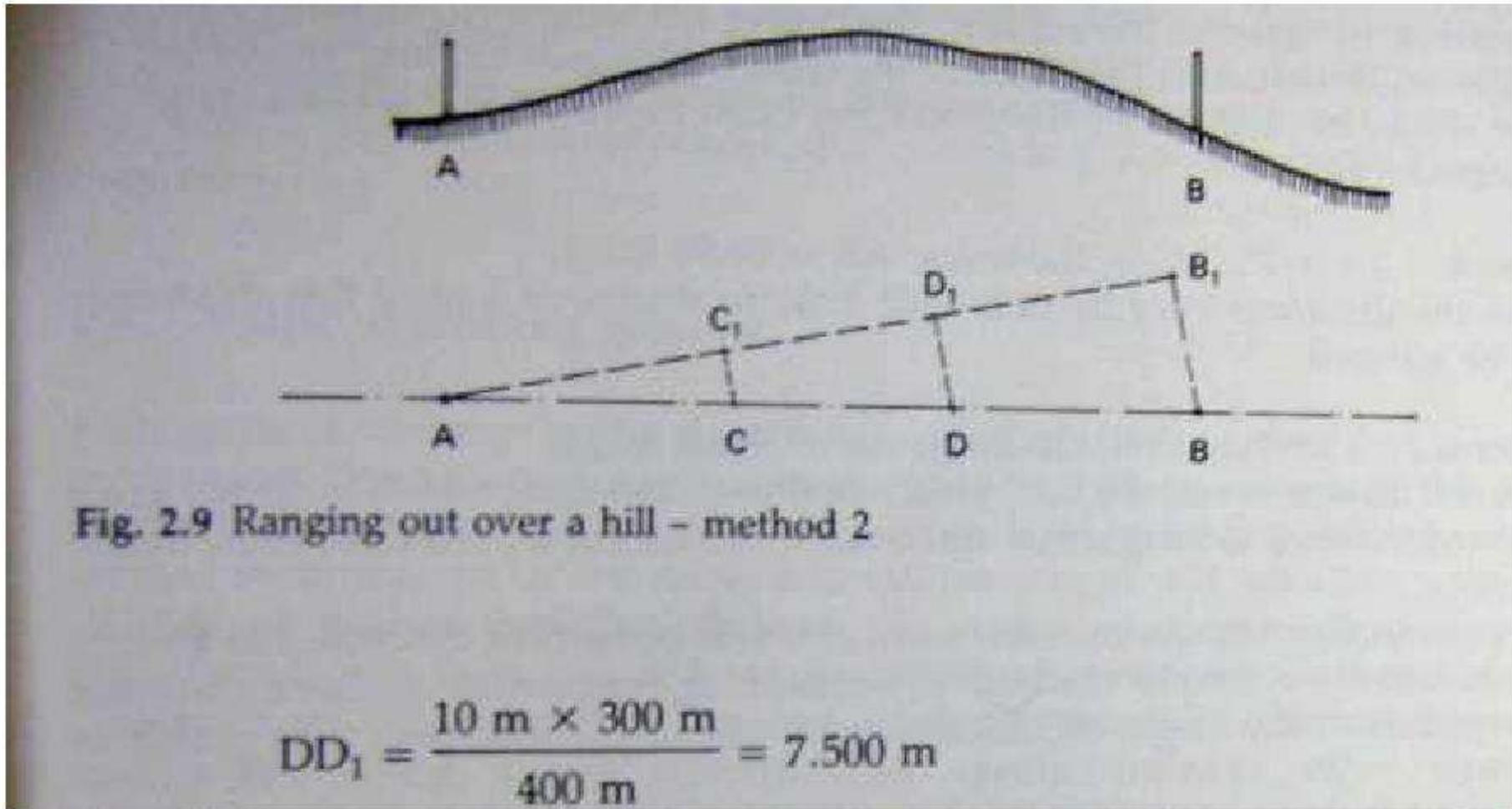

Section 2 – Overhead Lines and Installation

2.8 Perform basic survey of short distribution line extension to produce field notes

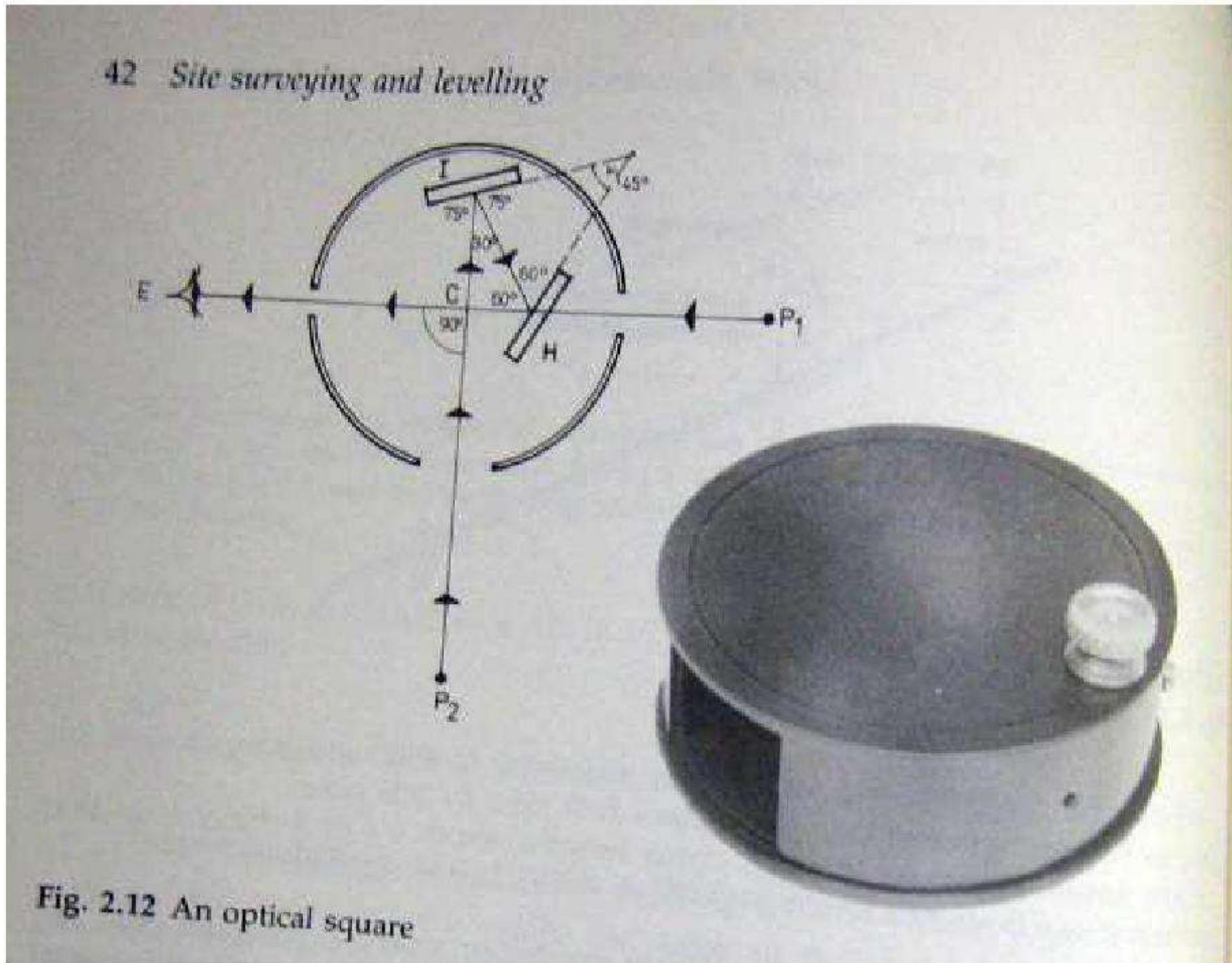

Section 2 – Overhead Lines and Installation

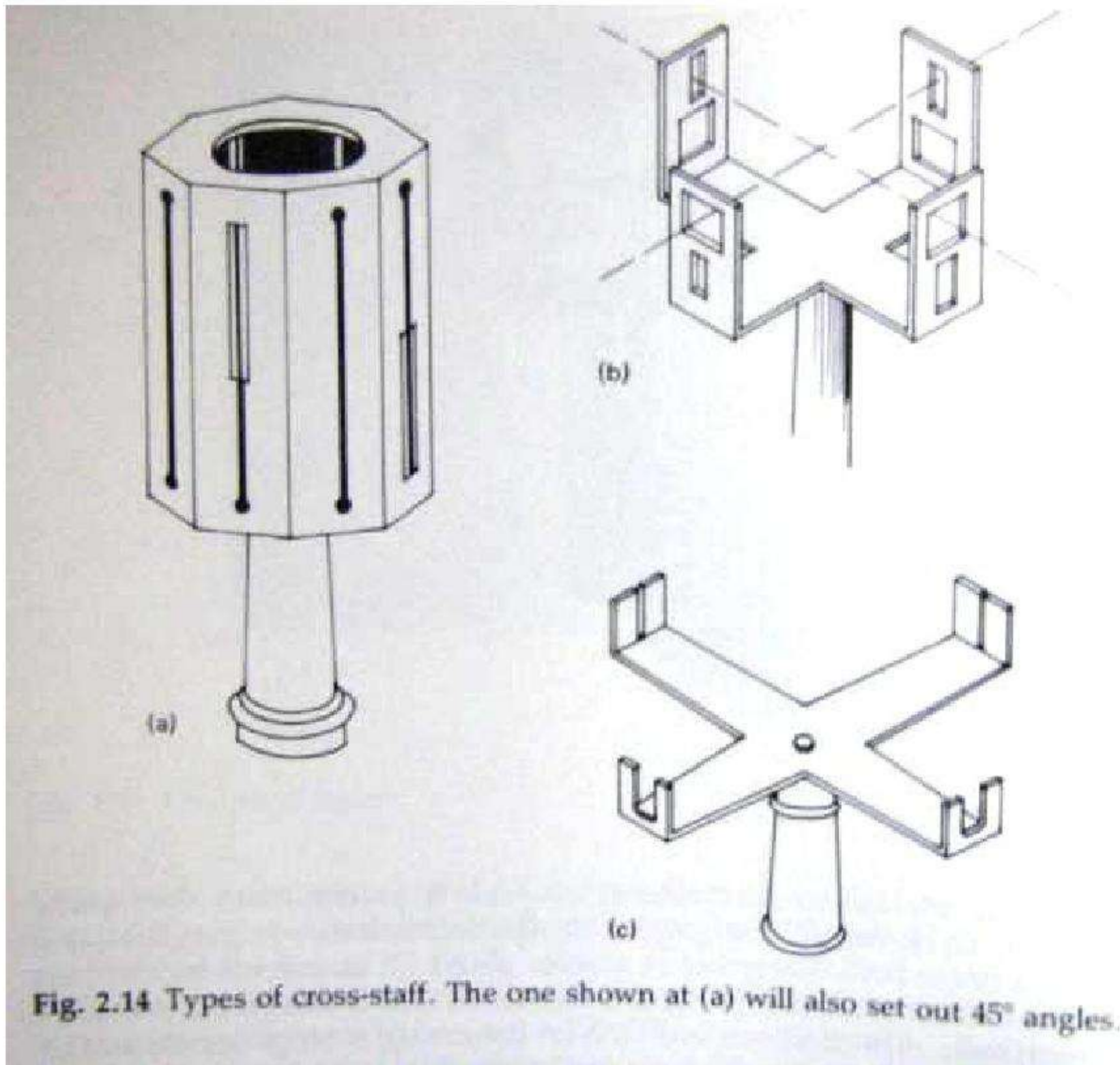

Section 2 – Overhead Lines and Installation

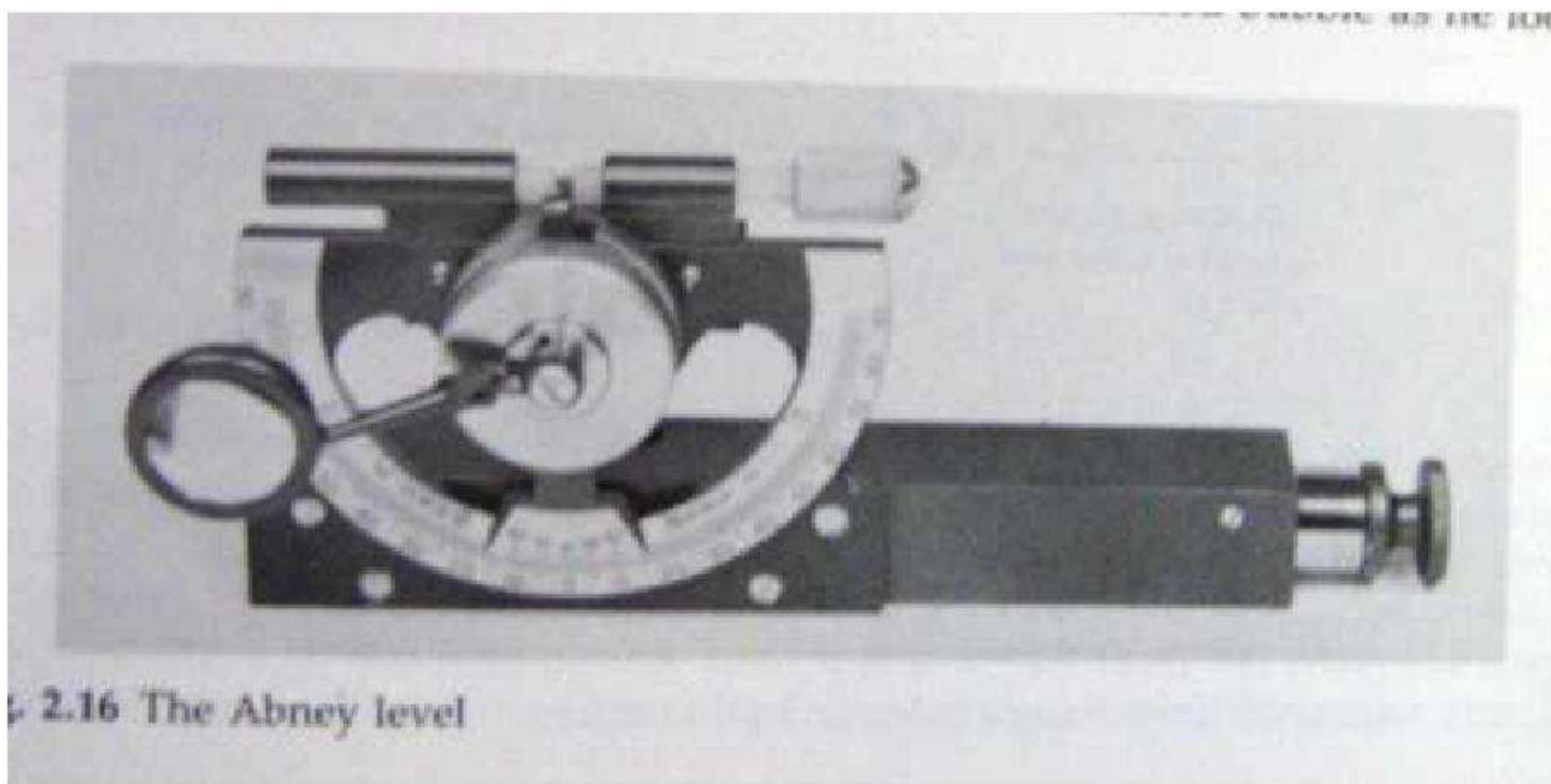
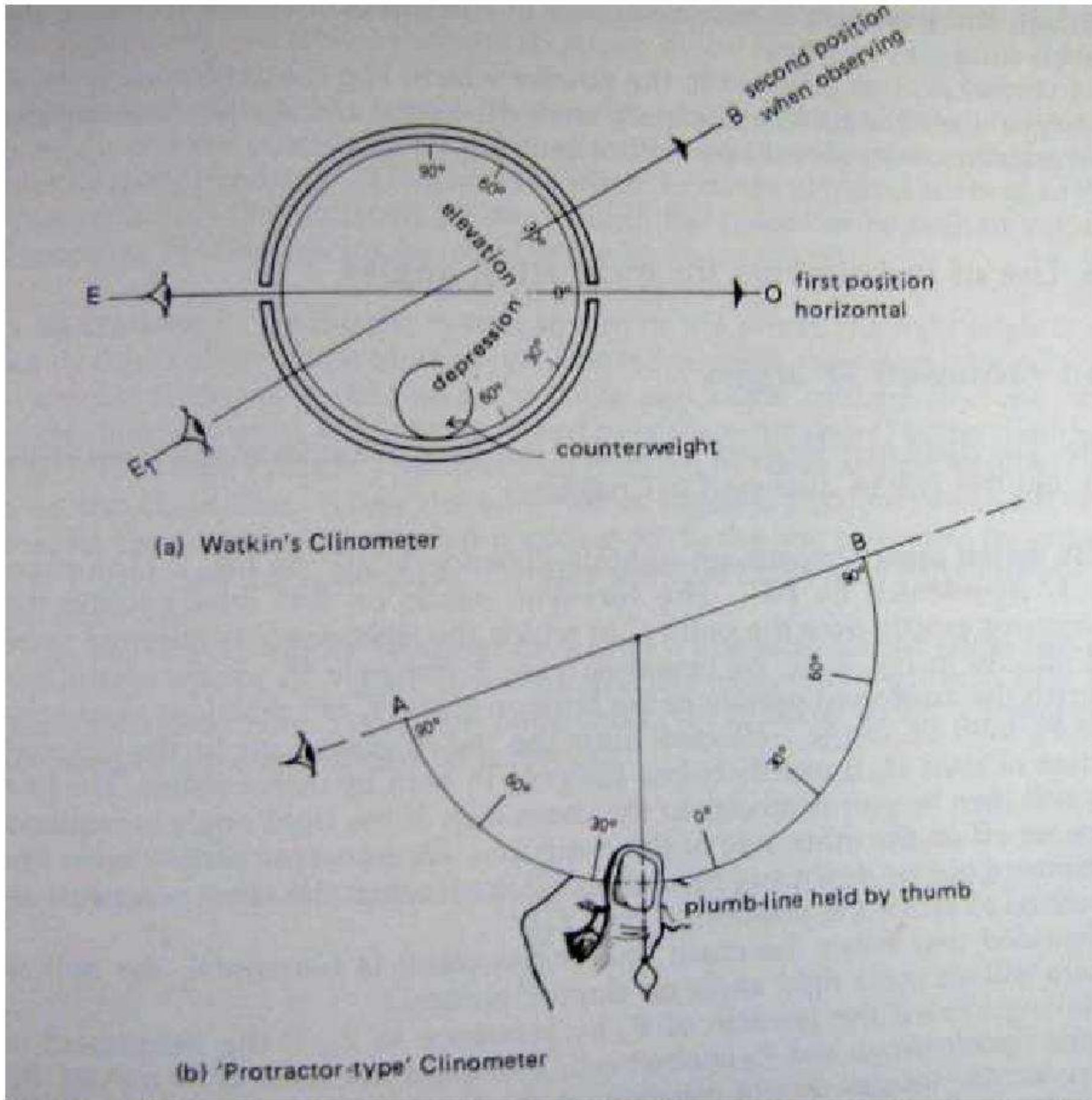

Section 2 – Overhead Lines and Installation

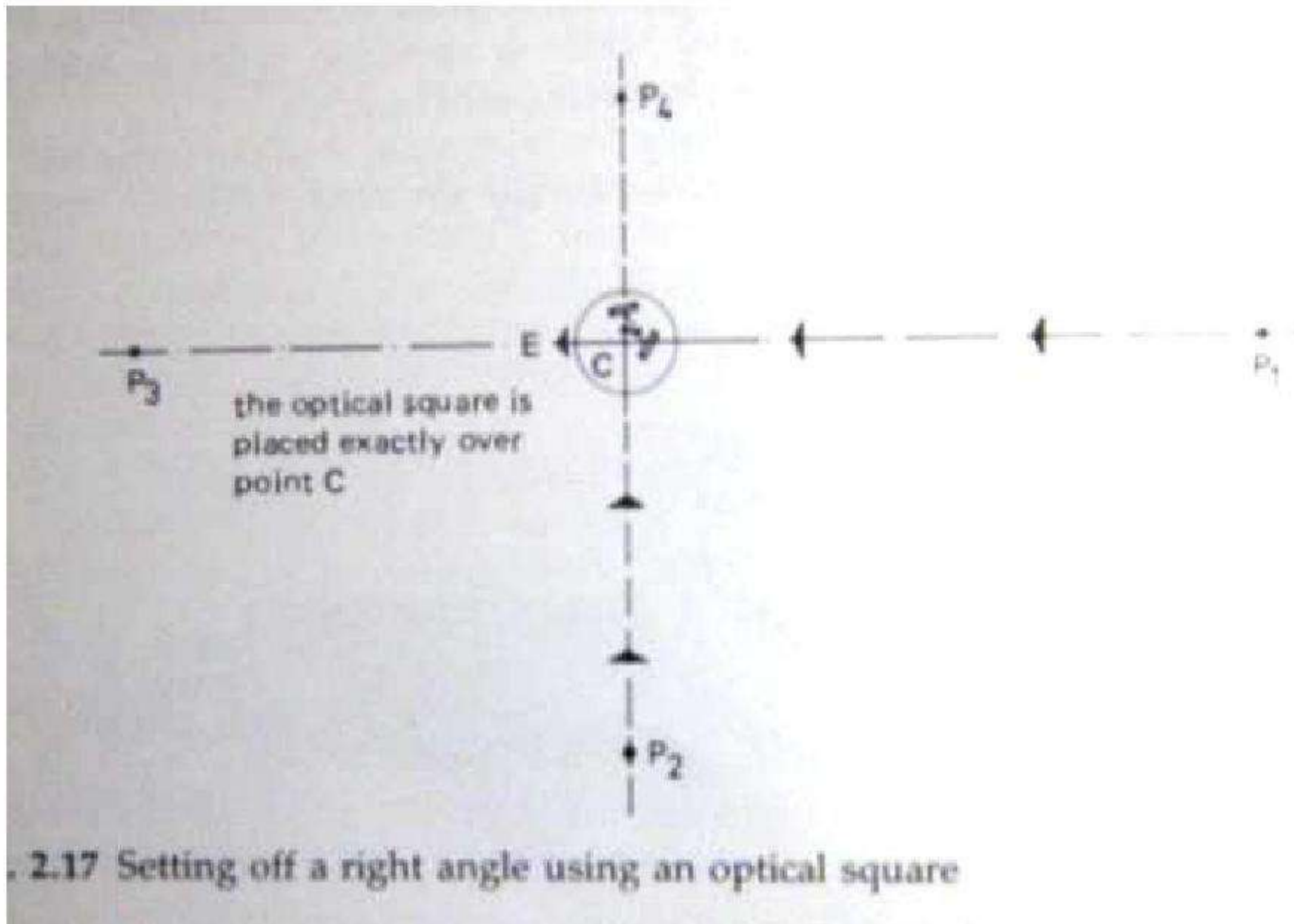

By Prism The prism is held by the surveyor in his hand exactly over the point C, and the pole P_1 is sighted by direct vision over the prism. The rays of light forming the image of P_2 enter the prism from the side and are bent to the observers' eye. The assistant moves P_2 until the poles can be seen in vertical alignment, at which point the right angle has been set off.

Section 2 – Overhead Lines and Installation

By Cross Staff Unlike the optical square or the prism, the right angle is set out by direct observation of all poles. The cross staff is placed on a tripod with a special receiving head, and the slots are made vertical. By use of a plumb line, the cross staff can be placed over the exact spot C in the chain line (Fig. 2.17) Poles P_1 and P_3 are observed through the slots as a test that the staff is on the chain line. When the surveyor is satisfied that the cross staff is in line, he then observes through the slots at 90 degrees to the line and when he can see pole P_2 through the appropriate slot this signifies that P_2C is perpendicular to the chain line.

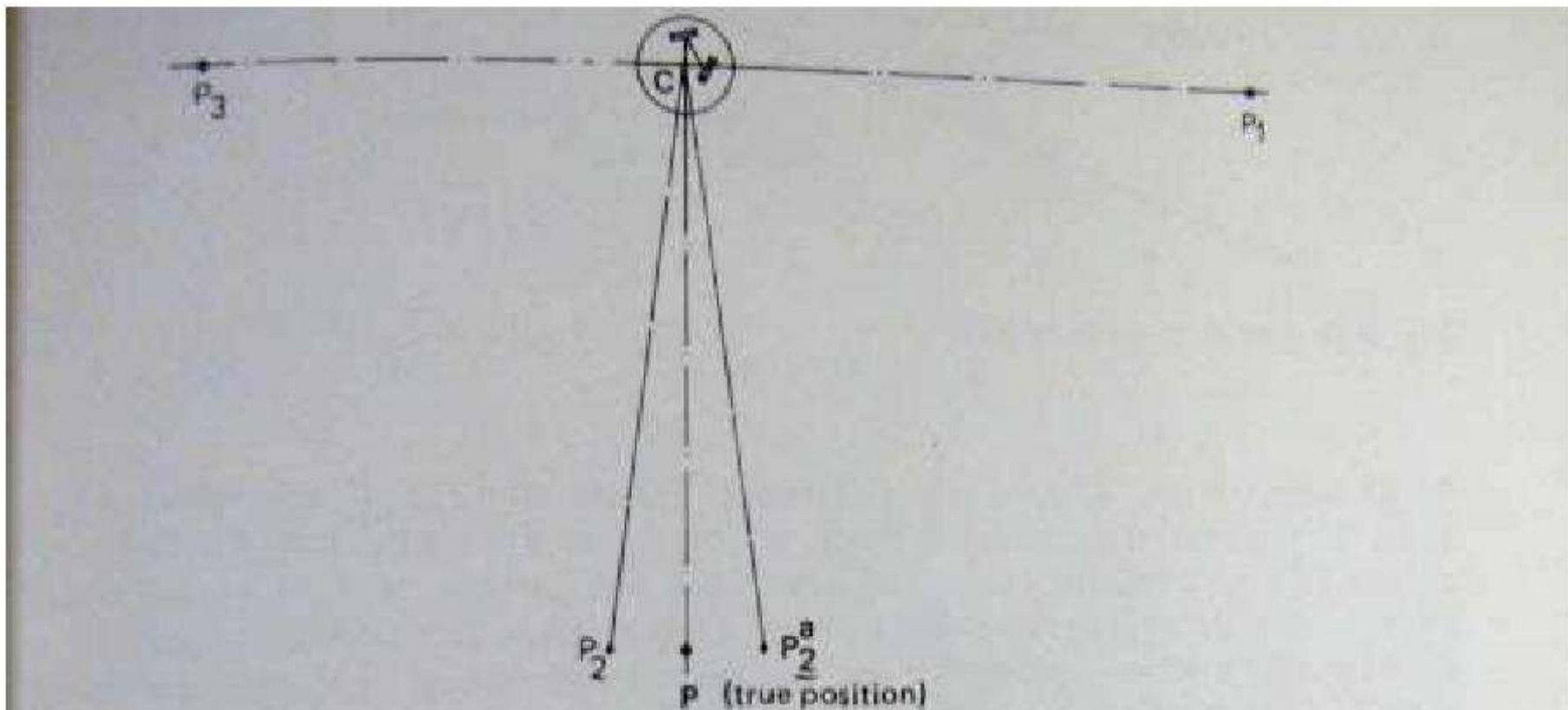

Fig. 2.18 Testing the optical square

2.6.2 Measuring slope angle

a) **By clinometer** To measure the ground slope of a line AB, the surveyor stands at point A holding the Watkin's clinometer to his eye. The assistant stands at B with a pole having a clear marking which is the same height above the ground level at B as that of the surveyor's eye level at A. This mark is observed through the instrument and, if it is *higher* than the surveyor's eye level at A, the instrument will be tilted upwards (elevated). Since the scale is

2.7 Measure ground level, deviation angles and compass bearing

Linear measurement

Measurement having only one dimension

Section 2 – Overhead Lines and Installation

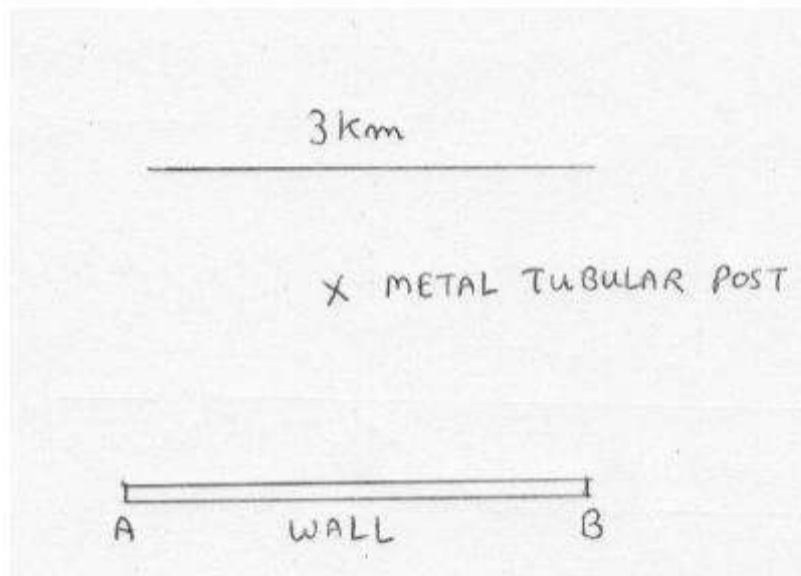

Angular measurement

The measurement of the angles formed when two straight lines meet.

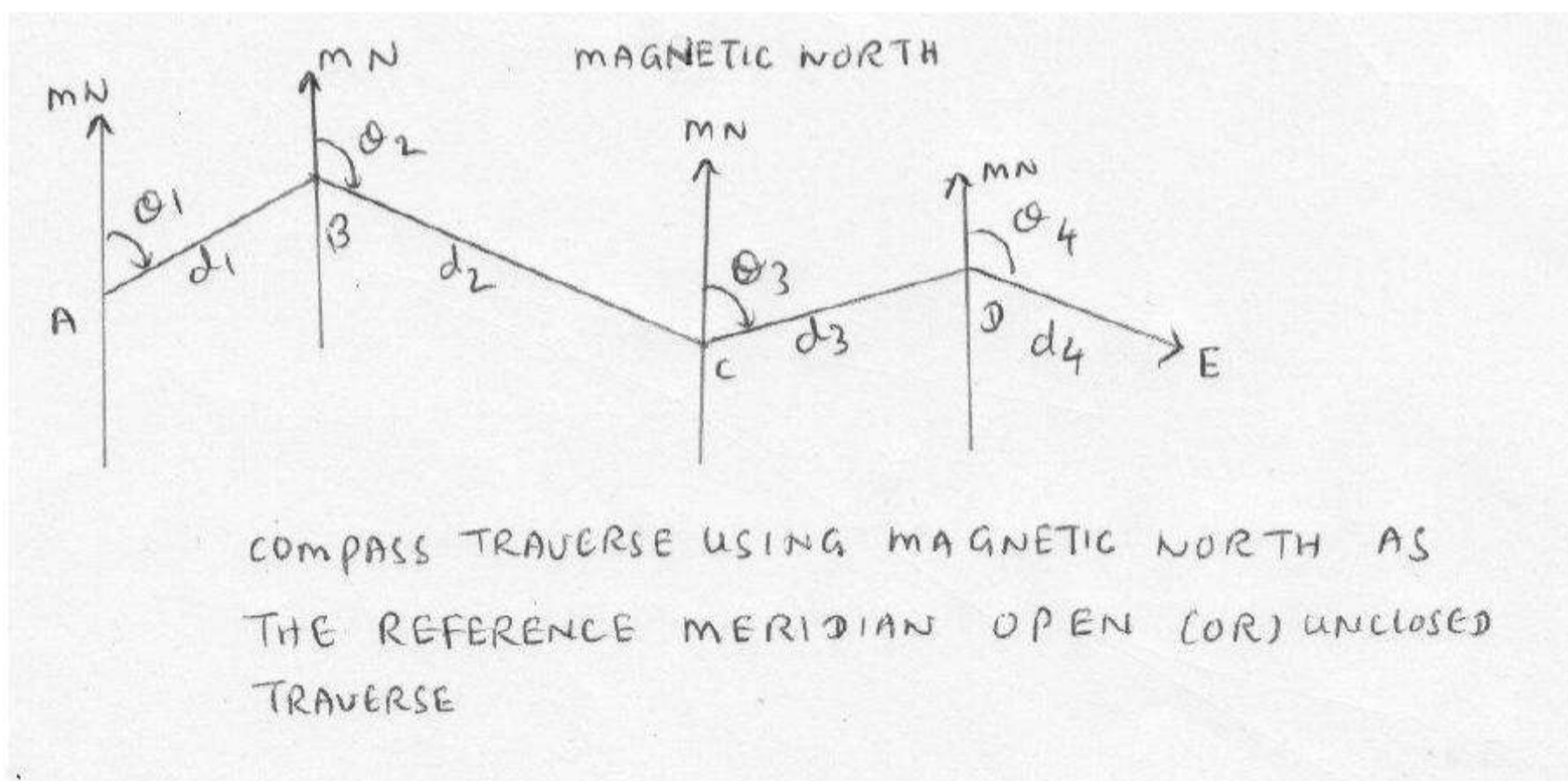
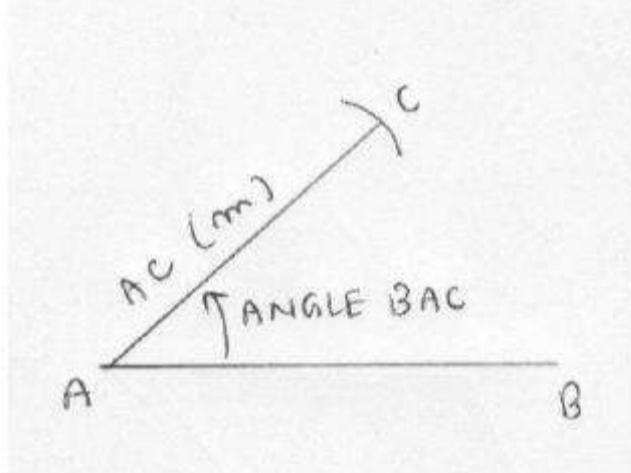

Site surveying and levelling

Scale of map

1:25000---- Small scale map.

- Planning large scale engineering works involving gradient of roads, sewers , pipes
- Involve with the flow of rivers, street
- When contour lines provide a means of solving problems intervisibility and clearance between points
- To illustrate aspects of regional planning

Section 2 – Overhead Lines and Installation

1:10000---Almost accurate drawn to scale. To accommodate road names.

- Estate management, design of schemes for water supply
- Geological surveying
- Town planning

1:2500-----Highly detailed map providing accurate information to fairly large scale

1:1250----- Double management of 1:2500

- All streets are named
- Block plan , location plan when marking application for planning and building regulation approval
- By designers for initial layout.
- By statutory undertakings to record the positions of power lines.

Survey stations

A survey station is a point of importance at the beginning (or) end of a chart (or) at the junction of one line with another.

It is usually marked by an insertion into the ground of a vertical ranging pole. On the surface , this point may be marked by a stud. Stations should be placed as may be found convenient at the corner of area (or) at prominent points so that the lines joining them are as close as possible.

The base line

This is normally the longest of the chain line forming the pattern of triangle. It should , if possible be laid off on level ground through the center of the site and encompass the whole length of the area. A compass bearing should be taken to fix its direction which in turn will fix the direction of all other lines and allow the position of north to be determined. All survey drawings require a drawn north point.

Survey equipments

Chain

Typical chain pattern The tags shown are for 20 m chain and may be of brass or plastics. Plastics tag may be attached at each whole metre positions with a different colour used at each 5 m position. This is usual for chains longer than 20 m.

Tapes

Section 2 – Overhead Lines and Installation

A tape is used for taking subsidiary measurements in the field. It is suitable for taking off sets which are measurements taken from and at right angles to the chain line or to fix adjacent points as on a boundary.

Laying down the chain

The leader equipped with his ten arrow drags the chain until he is brought up by a gradual pull and directed into line by the followers. Once alignment effected, an arrow is inserted which marks the measurement of one length, care must be taken to ensure that arrows are inserted vertically and the side of vertical handle so that no error equally to the thickness of arrow or the thickness of the handle is in trouble.

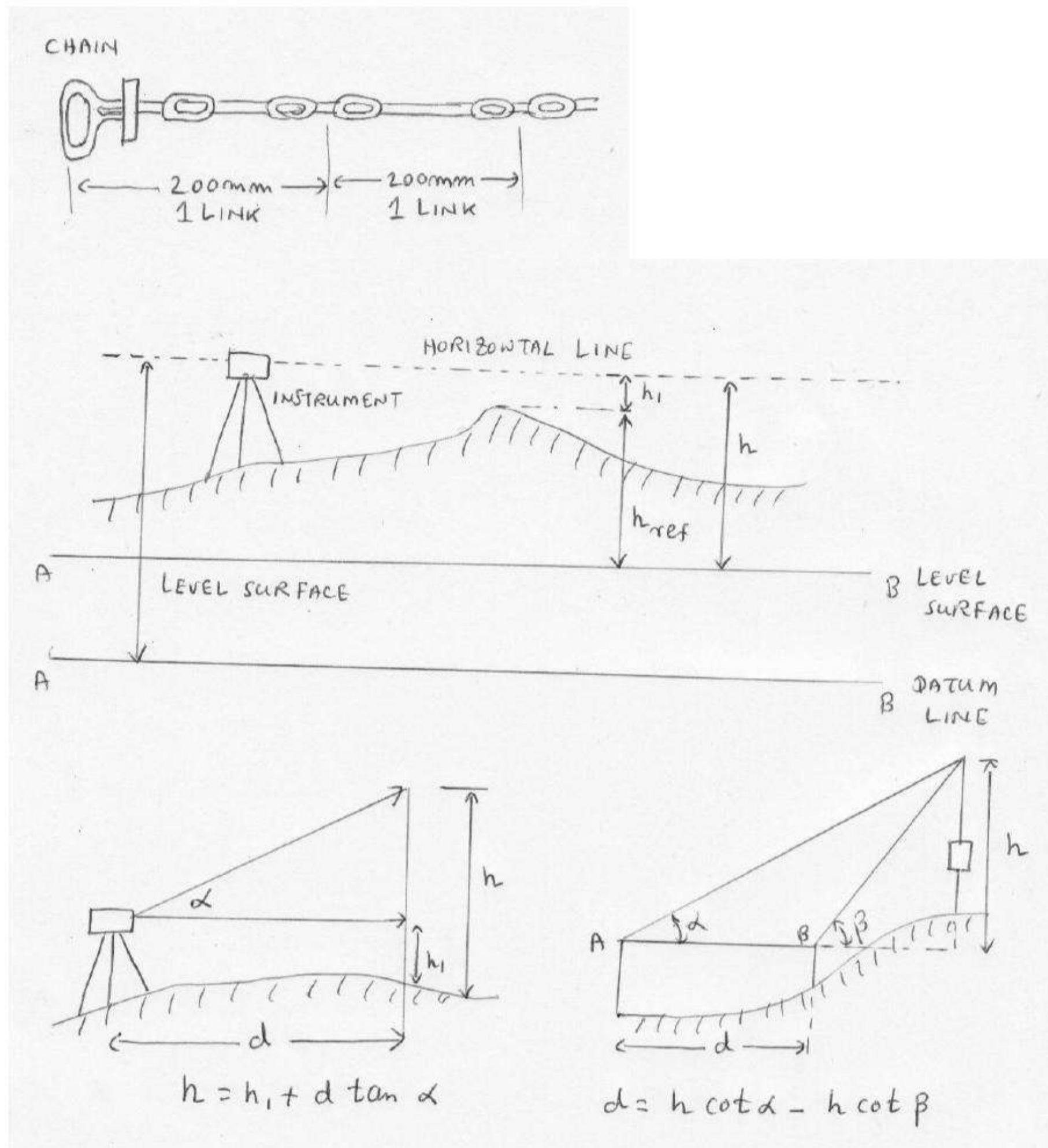

On hilly ground

Very often, due to undulations of some size, the last station point can not be seen, the first, yet intermediate poles must be positioned for lining in the chain man.

Section 2 – Overhead Lines and Installation

The difficulty may be resolved by tying two poles together although this is not very accurate or satisfactory, two other methods may be adopted as follows.

Prism in Theodolite

To see pole

Clinometer

To measure height

Required drawing equipments

Long steel straight edge parallel ruler, protractor 360 degree. French curve, Offset scale

2.8 Perform basic survey of short distribution line , extension to produce field notes

Surveying software

Read the article

“ Re- engineering the Transmission Line Design Design Process in 2.8 Perform basic survey of short distribution line extension to produce field notes handout.

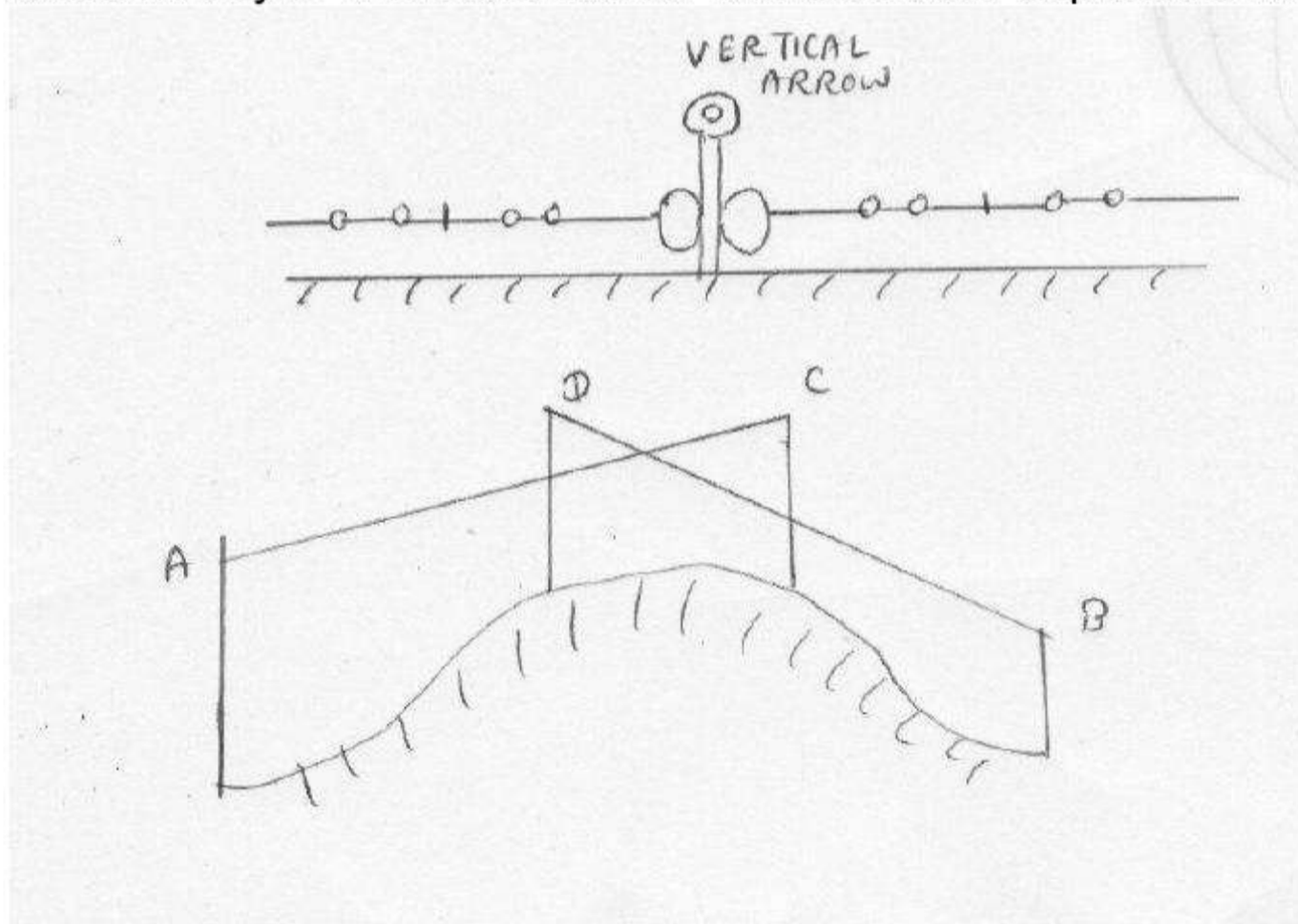

2.8 Site Surveying

Surveying Meanings

Level Datum—It is the level line or surface that has been given to a value to which the heights of points above or below can be referred.

Section 2 – Overhead Lines and Installation

Reduced Level (RL)—It is a value given to a point or surface that represents its height above or below , an assumed level datum.

Bench Mark- Bench Marks are the points that have a reduced level value.

Back Sight--- Back sight is the first reading taken from any instrument set up. It is always taken to a point which has a known RL

Fore Sight – It is the last reading taken from an instrument set up . It is taken to a point where RL is known or where RL is required for further levelling.

Intermediate Sight—It is any other reading taken from an instrument set up.

Change Point—It is a point where RL may not be required but is used in series levelling so that the levelling process can be proceeded.

Inverted Level-- It refers to the bottom inside RL of a pipe

Temporary Bench Mark (TBM)—It is a location normally transferred from a bench mark as a convenient location for other heights to be noted or positioned. For example, they may be positioned close to a building being erected.

Section 2 – Overhead Lines and Installation

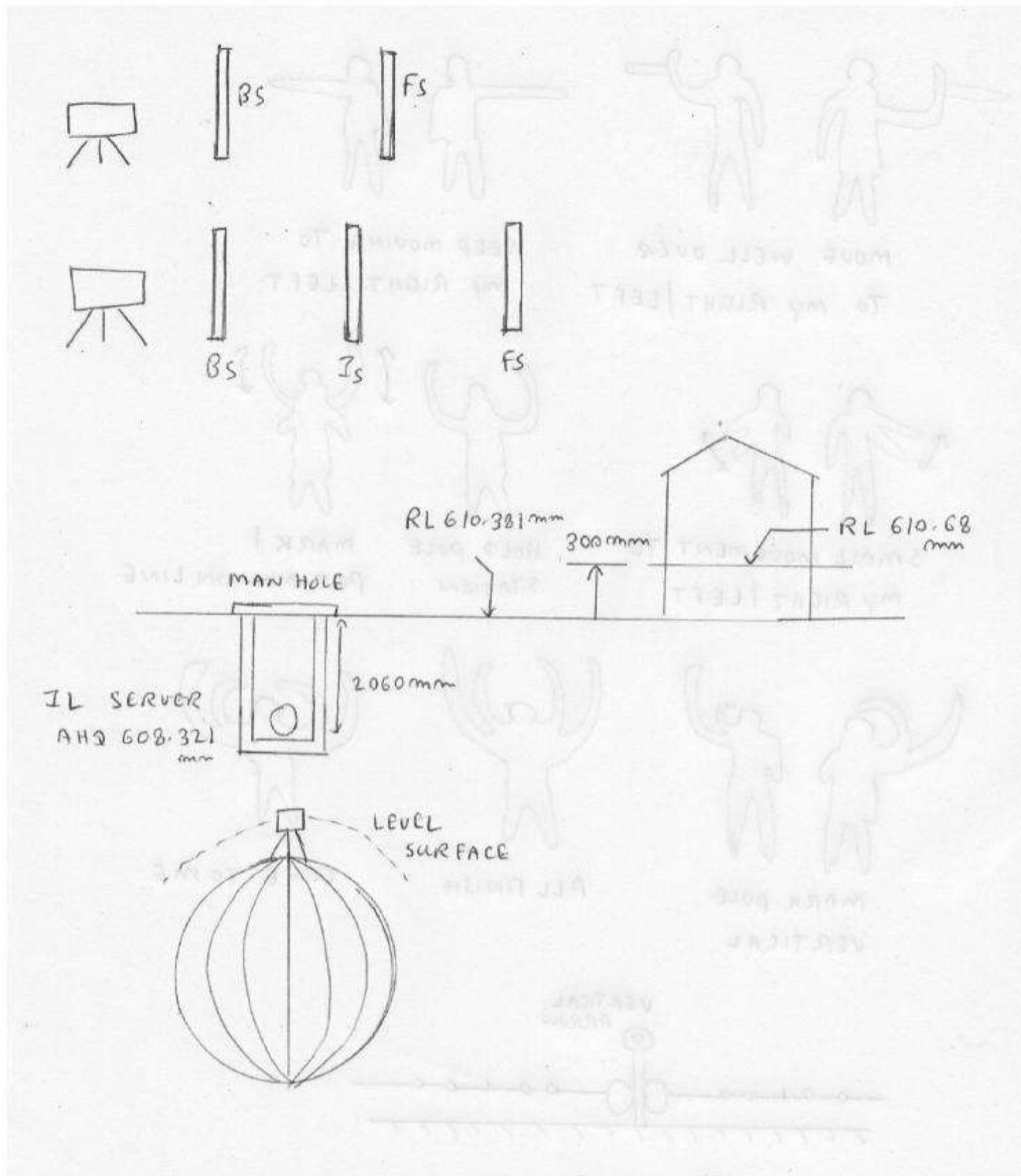

Section 2 – Overhead Lines and Installation

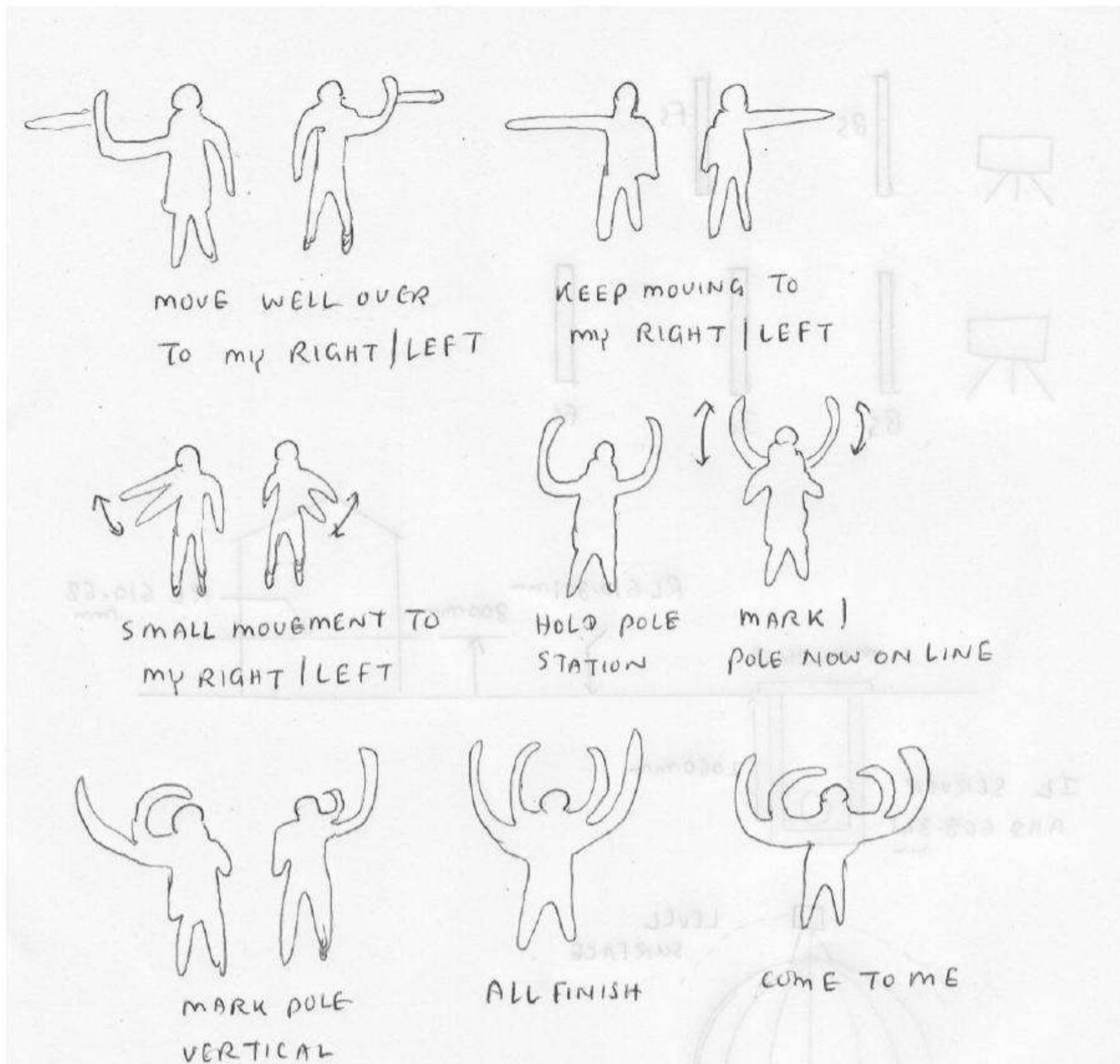

Determination of height difference between two points

Reading		Difference Height
Station 1	Station 2	
0.812	1.013	0.201
0.566	0.764	0.198
	ADD The Difference	0.399
	Average--- / 2	0.195

Rise and fall calculation

FALL

- Second point value is bigger than first point----- FALL

RISE

- Second point value is smaller than first point-----RISE

Section 2 – Overhead Lines and Installation

Calculation of reduced level from known point by field surveying

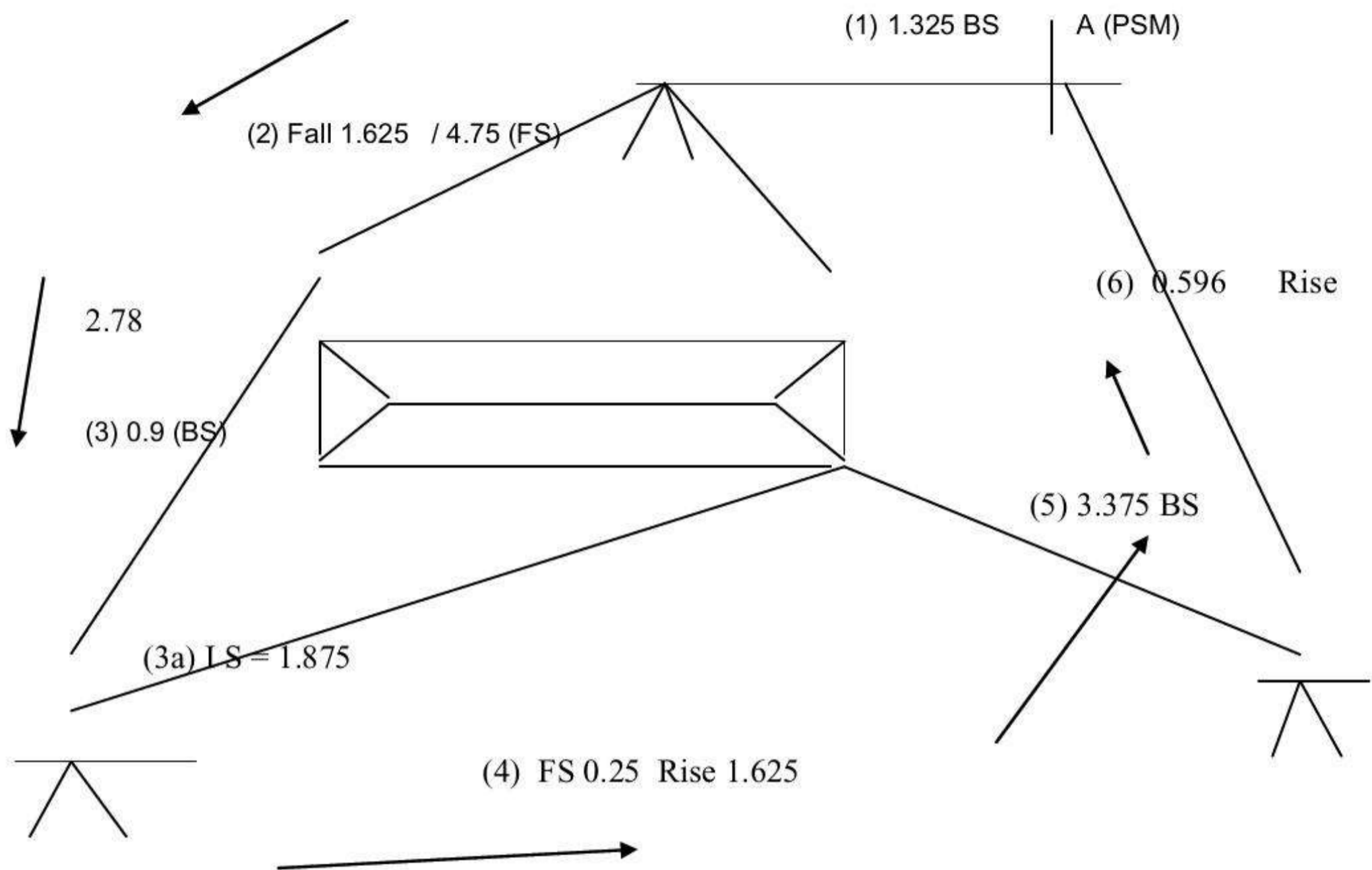

Section 2 – Overhead Lines and Installation

Back sight	Intermediate	Fore Sight	Rise	Fall	RL	Prism
(1) 1.325					100	A
	(1.a) 2.55		1.225		98.775	B
	(1.b) 3.125		0.575		98.2	C
	Difference		-			
(3) 0.9		(2) 4.75	1.625		96.575	D
	(3.a) 1.875		0.975		95.6	E
	Difference		-			
(5) 3.375		(4) 0.25	1.625		97.225	F
		Difference	+			
		(6) 0.595	2.78		100.005	Closed A
		Difference	+			
ADD		ADD	ADD	ADD		
ALL		ALL	ALL	ALL		
5.6		5.595	4.405	4.4		

Rules

1. Data Entry Table

Back sight	Intermediate	Fore Sight	Rise	Fall	RL	Prism
(1) 1.325					100	A

2. Flow Direction of Data Entry

3.

Back Sight

Intermediate

Ever start

4.

I



I

Section 2 – Overhead Lines and Installation

5.

Back Sight ←————— Fore Sight

6.

If Second point > First Point----- FALL

If Second point < First Point-----RISE

7.

BS
↙
FS

8. Calculation of reduced level

First RL – Fall = Second RL

First RL + Rise = Second Level

9. To Adjust

ADD----- ALL -----FS -----BS
↓
RISE
↓
FALL

Re-Engineering the Transmission Line Design Process

Otto J. Lynch, P.E.

Black & Veatch.

8400 Ward Parkway, Kansas City, MO 64114

(913) 339-7549 (913) 339-2888 Fax lynchoj@bv.com

Peter Hilger, E.I.T.

The Empire District Electric Company

P.O. Box 127, Joplin, MO 64802

(417) 625-5100 (417) 625-5165 Fax

Section 2 – Overhead Lines and Installation

INTRODUCTION

Traditionally, transmission line design practices have been comprised of conservative assumptions which easily model an elaborate and complex structural system. Continued developments in computers and software have given us the capability of breaking these normally inflexible traditions, and have allowed the industry the opportunity to re-engineer the entire transmission line design process. Finally, the seamless integration of all aspects associated with transmission line surveying, engineering, drafting, procurement, and construction is essential to maximize the full benefits of the re-engineering effort.

Black & Veatch (B&V) is an engineer/constructor headquartered in Kansas City, Missouri. The firm has provided engineering, construction, and related services for electric power transmission and distribution throughout its 80-year history. The firm's Transmission & Distribution Division forms one of the largest T&D staffs among engineering and construction firms in the United States. By utilizing state-of-the-art resources and techniques, B&V continually strives to improve the transmission line engineering, procurement, and construction (EPC) process to produce better designs in the fastest, most economical manner.

The Empire District Electric Company (E.D.E.) is an independent, investor owned, electric utility providing quality electric service in the four-state area of Kansas, Oklahoma, Arkansas, and Missouri. E.D.E. is dedicated to providing its customers with the highest reliability possible, while maintaining its low rates.

B&V and E.D.E. have selected the PLS-CADD software suite developed by Power Line Systems, Inc., Madison, Wisconsin, to support their needs for a "better, faster, cheaper" transmission line design environment. The line design software selected has the capability of meeting all the objectives required for the full integration of the transmission line design and drafting environment.

SURVEYING

Recent developments in surveying technologies have allowed the industry to re-think the station-elevation-offset formats that designers have traditionally used for transmission line profile modeling. Today's generally accepted method of surveying is some form of three-dimensional geographical information system (GIS) type representation. Data are usually collected in electronic format, and the transmission line software must be capable of reading the data intelligently in any form. Total Station, Geographical Positioning System (GPS), Photogrammetry, electronic topographical maps (USGS), and scanned or digitized existing profile drawings have all been employed to develop quick and relatively accurate terrain models for transmission lines.

B&V and E.D.E. utilize a state-of-the-art technology, the FLI-MAP™ laser mapping system. FLI-MAP was developed by John E. Chance and Associates of Lafayette, Louisiana. This advanced technology system incorporates On-The-Fly (OTF) Kinematic GPS, GPS aided attitude, a reflectorless laser range finding sensor, and a helicopter to quickly gather topographical and other pertinent aboveground data. This method yields about 10 data points per square meter over a 65 meter wide corridor

Section 2 – Overhead Lines and Installation

under the flight path. This technology produces points with an accuracy better than 12 cm vertical and 15 cm horizontal of all points on and above the ground. Approximately 100 kilometers of continuous line can be surveyed in a day, and the data can be available in the desired coordinate system and elevation datum on the same day if dictated by the client. The information can then be directly imported into PLS-CADD in a matter of minutes. Transmission line design can commence immediately using extremely accurate profile, significantly more accurate than even a very dense, time and labor intensive ground survey can produce.

The design software selected has the capability of taking any three-dimensional survey format and "cutting" the profiles. The centerline and up to 20 left and right profiles at any offsets can be generated and shown. This process is nearly instantaneous, so Points of Intersection (P.I.s) can be moved or added at any time, and the new stationing and profiles are updated immediately. This allows for the typical last minute reroutes to be made quickly and effortlessly without delays caused by having to wait for new profile surveying, stationing changes, and engineering modifications. Station equations (equalities) will be obsolete.

In addition, the software has the capability of creating interpolated points on these profiles by creating a triangular irregular network (TIN). This TIN can also be rendered to present a graphical three-dimensional representation of the transmission line, which can be used for permit and public hearing requirements or any other forum where graphical representations are required of the line (See Figure 1).

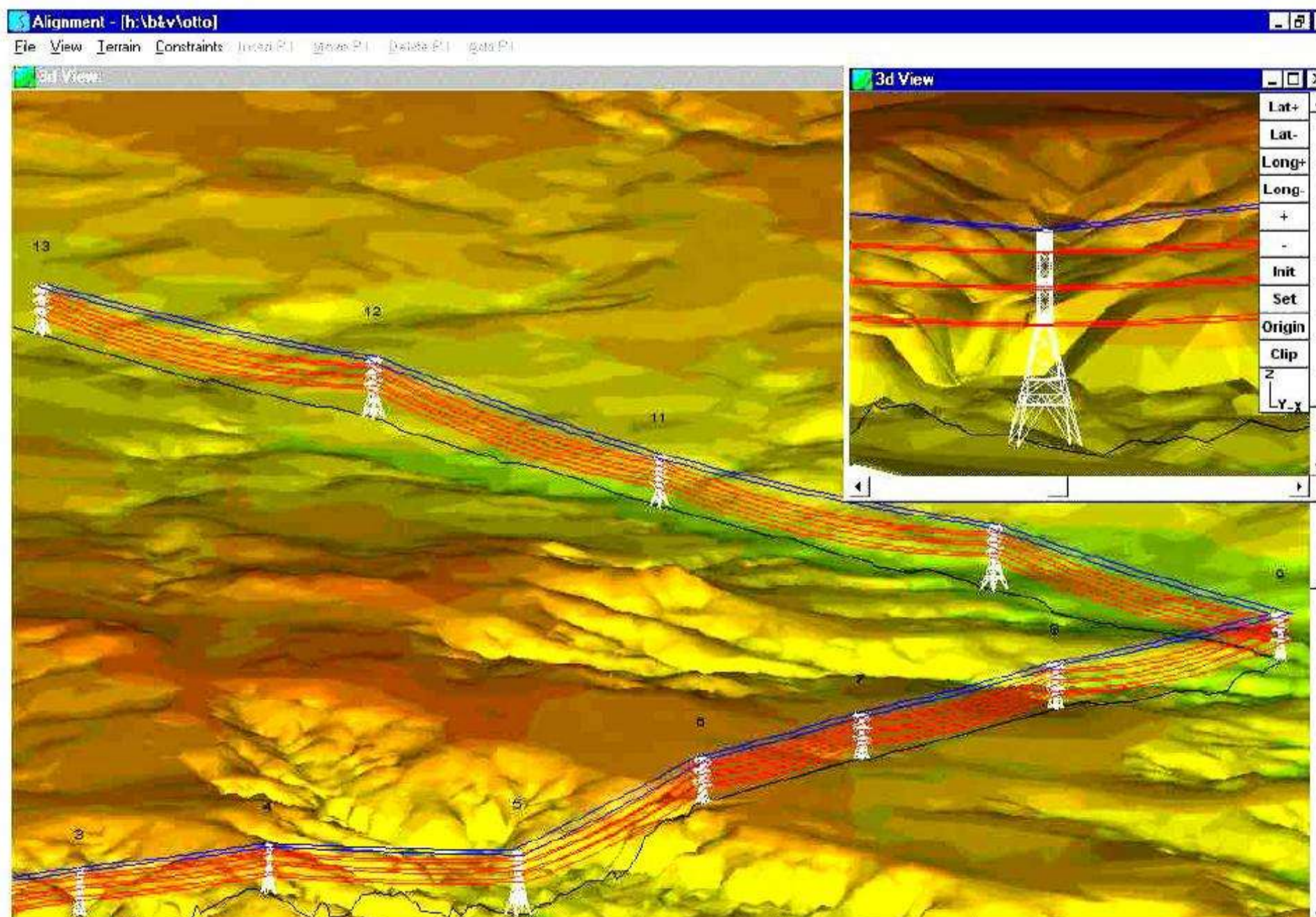

Figure 1 - Three-dimensional rendering of a double-circuit 500 kV transmission line.

Section 2 – Overhead Lines and Installation

ENGINEERING

A critical component in any re-engineering effort is the simplification and centralization of all activities. In the transmission line engineering arena, all parameters governing any part of the line design should be available in one common package. Engineers cannot and should not be expected to learn multitudes of software programs, keep current in each of their independent updates, and maintain support with each of the programs. In addition, any data transfers between such programs, whether manual or electronic, leave room for error. Finally, it is critical that the software be on a computer platform that is user friendly and commonly accepted across the engineering and business worlds. Managers, engineers, technicians, drafters, and secretaries should be able to use any form of the programs or their outputs using a common interface, without having to learn complex drafting programs or obsolete operating system languages.

Another area of the software used in the re-engineering process that should not be overlooked is that it be technically sound. Software that merely duplicates assumptions and errors of the past is only as good as those assumptions. In today's computer environment, these programs will allow an error or mistake to be made faster than ever before. It is imperative that all calculations be made using state-of-the-art technologies and methodologies, and to the highest level of accuracy that is reasonably achievable. These criteria should not be sacrificed in an effort to simplify or expedite the design process.

PLS-CADD allows the engineer to completely design and lay out a transmission line without having to use any other external software. Due to this integration, all design criteria which will be imposed on the transmission line system are developed in one place. Loads which will be used to develop a sag-tension analysis and check sag clearances, uplift considerations, blowout criteria, cable tension limits, insulator swing criteria, structure design, insulator design, guying design, and foundation design are developed in one place. Overload factors (OLFs) can be applied in the transverse, longitudinal, and vertical directions and on the wire tensions. The loads can be selected to be applied to any component of the transmission line system. This allows PLS-CADD to be adaptable to any code or manufacturer requirement where different OLFs are required for each component of the transmission line system.

Structure design and spotting are indicative of the re-engineering effort making tremendous strides. Traditionally, structures have been designed by developing allowable spans, wind and weight, under all the loading cases applicable to the structure. For example, due to terrain factors, a structure family may be designed for a vertical to horizontal span ratio (H/V) of 1.5. Using this criteria, an example tangent structure may have limitations of a maximum wind span of 300 meters and a maximum weight span of 450 meters, where the maximum wind span was probably dictated by an extreme wind condition and the maximum weight span was probably dictated by a heavy ice condition. When spotting this structure on a line, either by hand or by less sophisticated spotting software, the structure location is acceptable if the wind and weight spans are both below the allowable span limitations.

However, in the "real world", the wind and weight spans are rarely maximized simultaneously for any given structure on a line. While we may think that we are

Section 2 – Overhead Lines and Installation

maximizing the use of the structure by approaching 100% use of either the allowable wind or weight span, there is actually additional strength available due to the contra allowable span not being utilized to its capacity, thus creating an interaction between the allowable wind and weight spans. Coupling this interaction phenomenon on a loading case by loading case basis, it can be seen that traditional methods used to spot structures can be as much as 70% or more conservative in their application. The associated reduction in structure costs on a large transmission project can quickly translate into a substantial overall project cost reduction.

Weight spans are another area where traditional assumptions are invalid. It has long been standard practice that wind has no effect on computed weight spans. Sags are calculated with the wind loading, templates are developed with the corresponding sags, and these sags are then applied in the vertical plane. This is simply not the case in a three-dimensional environment. When wind is blowing on a span, the conductor assumes a swung-out catenary. In a level span, this swung-out catenary produces a wind and weight span equivalent to that in the vertical plane, so traditional assumptions are correct. In an inclined span, the weight span effect actually shifts and the traditional assumption is no longer valid (See Figure 2).

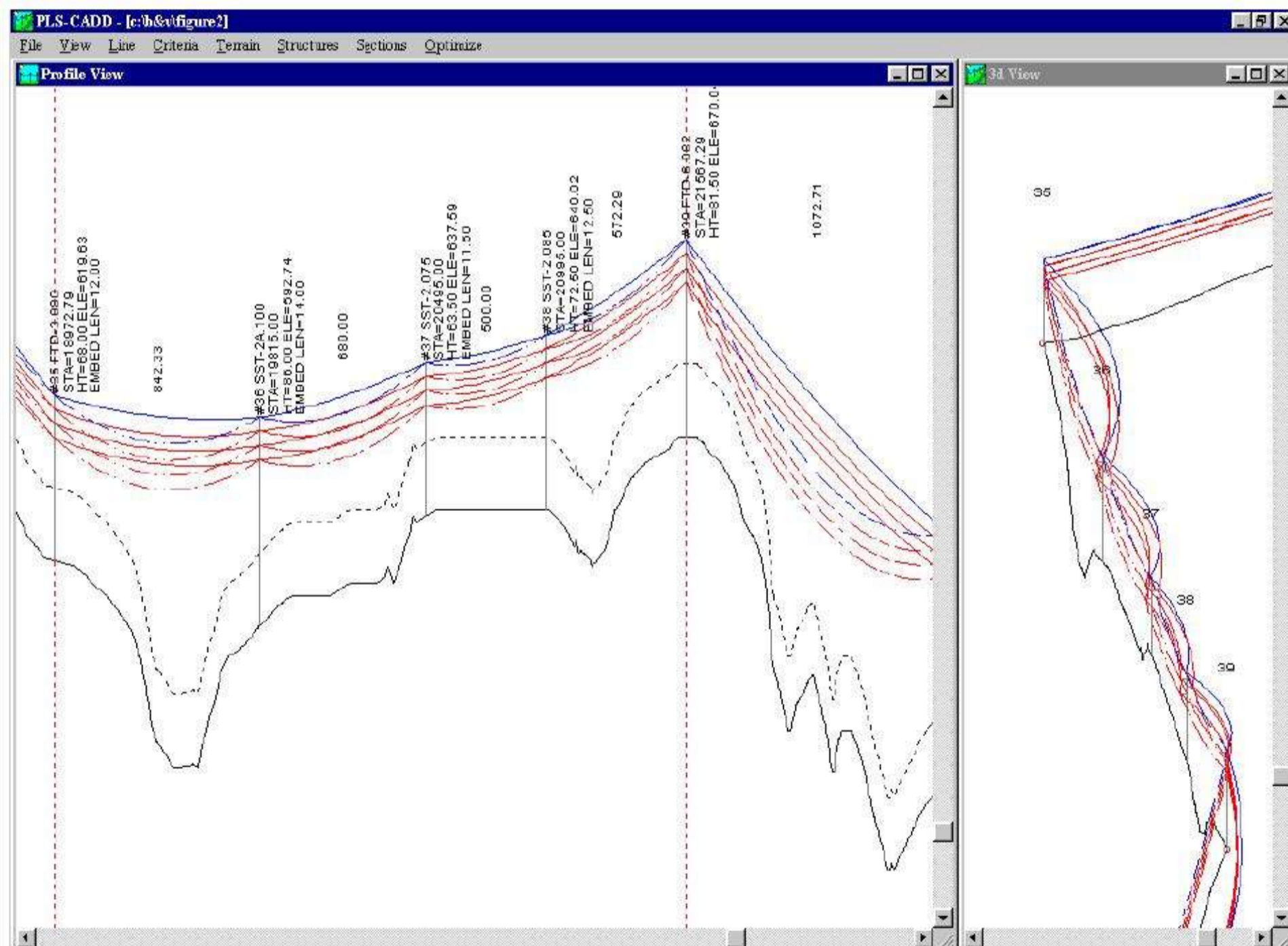

Figure 2 - A profile and associated three-dimensional view of a line illustrating weight span differences due to wind acting on the wire. All other constants remain the same.

The exact weight span in this swung out condition on an inclined span is difficult to determine by traditional methods of finding low points in elevation views, but computers and three-dimensional technology can easily make these determinations.

Section 2 – Overhead Lines and Installation

Using the traditional method, weight spans can be in significant error when considering any wind loaded condition (See Table 1).

The software allows the selection of either the traditional method or exact method for calculating effective weight spans when using the wind and weight span options. It is recommended that the traditional method only be used when comparing PLS-CADD to traditional calculations or on extremely flat terrain. The exact method provides for an accurate three-dimensional line design and should be used on new projects.

Section 2 – Overhead Lines and Installation

		Weight Span	Weight Span	Weight Span
Structure	Wind Span	w/o Wind	w/ Wind	Change
Number	(m)	(m)	(m)	(%)
31	184	146	102	-30%
32	230	287	349	22%
33	190	221	249	13%
34	165	183	199	9%
35	201	87	-19	-122%
36	232	190	159	-16%
37	180	190	196	3%
38	164	120	89	-26%
39	252	428	499	17%
40	242	112	64	-43%
41	78	99	123	24%
42	53	73	89	22%

Table 1 - Calculated weight spans from Figure 2. Traditional calculation of weight spans under wind conditions are in significant error and can lead to expensive field problems if not accounted for properly.

Another significant aspect of any transmission line design program is the ability to incorporate the structure analysis of any type of transmission line structure. Important to the re-engineering effort, these structural programs also must be able to accommodate seamless integration into the line design. The PLS software has the capability to perform a full linear and non-linear finite-element analysis of wood, steel, concrete, and lattice structures. In keeping with the previously described criteria that any process in the re-engineering effort be technically accurate, it is essential that the structural analysis be performed as not merely a simplified replication of traditional hand analysis methods, but one that is rigorous. Traditional analysis methods can yield inaccurate results, sometimes on the conservative side and sometimes not.

An example of a simplified and imprecise method is designing single pole structures by calculating and analyzing the groundline moment only. In actuality, the maximum stresses in the pole usually occur at a point somewhere above the groundline, which can be verified by simple statics and observations of actual structure failures subjected to extreme transverse loading. In addition, it is imperative that any guyed structures and extremely flexible structures be analyzed using a non-linear analysis platform. The PLS software meets all objectives required to fully analyze structures correctly.

The current re-engineering movement has made major strides in analyzing existing lines for upgrade capabilities or fiber optic replacements and additions. Traditionally,

Section 2 – Overhead Lines and Installation

these analysis are performed by examining the structures independently of their location in the transmission line. Loads that are created by the maximum span limitations are recalculated for the replacement conductors and static wires based on those maximum wind and weight span limitations. Structure modifications are then designed and made to every structure on the entire line regardless of its physical application. However, as described earlier, very rarely are structures placed where the maximum span limitations are simultaneously utilized. By expanding our parameters and factoring in the placement of the structures in the line, we begin to realize those modifications may not be required on every structure. The PLS software has the capability of placing actual structure designs in a line and analyzing them directly on a site-by-site basis. This capability allows a full analysis to be made on the transmission line, allowing modifications to be designed on a structure specific basis using the actual loads that are applied to that specific structure at that specific site (See Figure 3). Considering the gross conservativeness of maximum wind and weight span modeling, many lines analyzed using this method can actually meet significant upgrading requirements with little or no structure modifications being required.

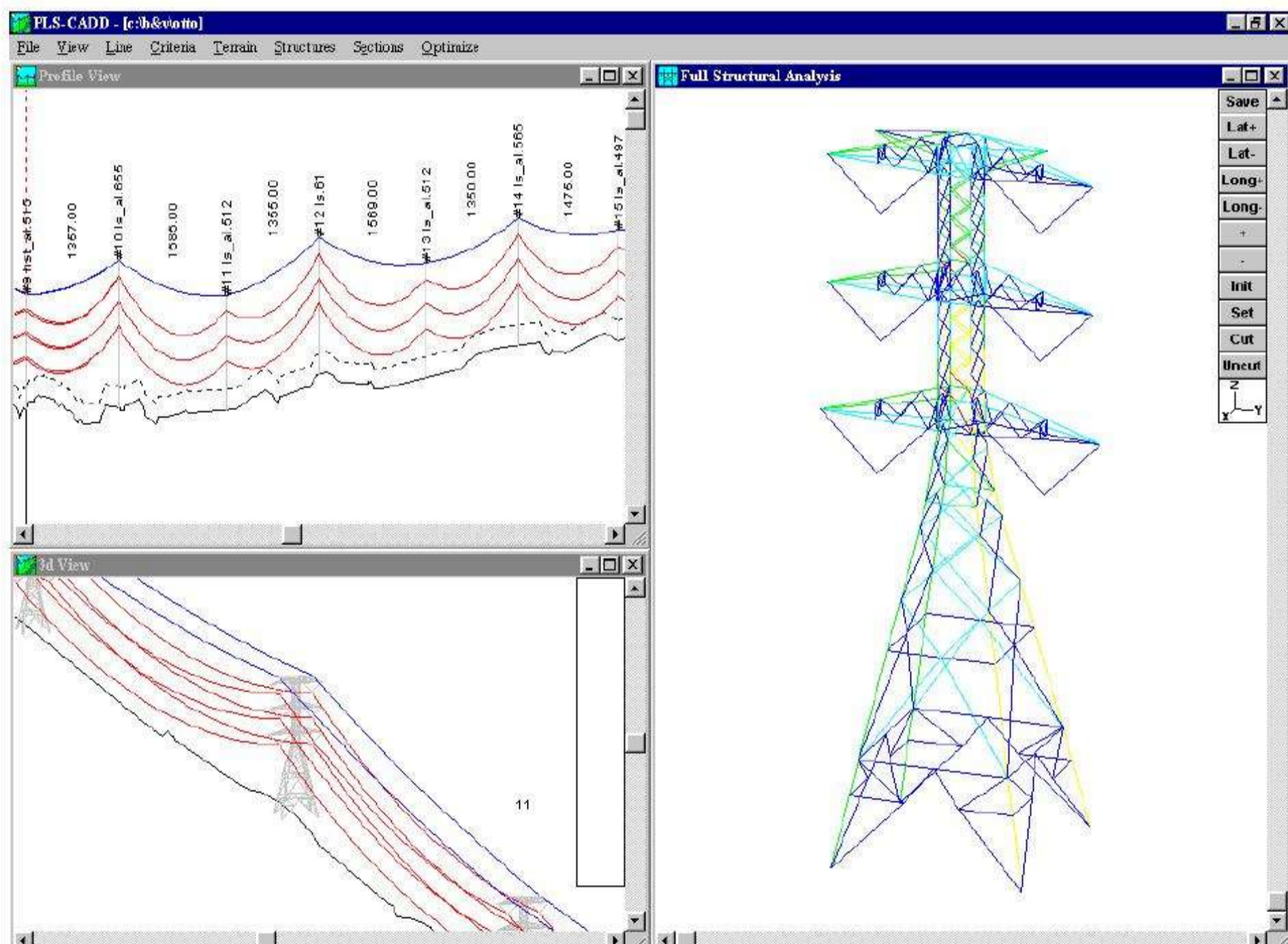

Figure 3 - Finite element structural analysis on an in-line lattice structure using the actual loads imposed on the structure.

Optimization of transmission lines is key to any design re-engineering effort. It is a necessary component for any true line design program. In addition, with many constraints imposed by physical obstructions, land owner desires, and environmental controls, the optimization process must allow for user defined controls to be handled

Section 2 – Overhead Lines and Installation

easily. Even on lines where there are many constraints, finding the least expensive combination of structures is still paramount to the project. Constraints usually fall under four categories: prohibited, extra cost, required structure location, and required structures.

Prohibited zones are simply areas where it is physically not possible to put a structure such as driveways, roads, wetlands, and inaccessible areas. Extra cost zones are areas where structures may be placed, but at additional cost to standard construction practices. An ideal example of this situation is a river crossing, where structures in the water are possible but the construction of the water crossing foundations can be a significant factor. Using an optimization routine, it can be determined whether it will be less expensive to place tall river crossing structures on each bank, or to place several standard structures in the river itself. PLS-CADD is capable of finding the least-cost design when accounting for all constraints imposed on the transmission line.

DRAFTING

Transmission line drawings, while being somewhat complex, are very simple in that they are usually repetitious. There are several commercial programs available and many utilities and consultants have written in-house programs capable of incorporating all the various facets of the typical plan and profile (P&P) transmission line drawing. Plan views have P.I.s, structure locations, and often geographical maps. Profile views have terrain profiles, structure specific information such as type, height and stationing, span lengths, clearance requirements, and wire catenaries. In addition, maps are often incorporated into the plan view, which requires placing the proper terrain information on the drawings. In a true re-engineered environment, the drawing generation should be merely an extension of the engineering process, eliminating the need for tedious and time-consuming drawing generation.

The P&P drafting of the design software is exactly that - an extension of all surveying and engineering activities. Drawings are formatted to fit client standards only once and include:

- Drawing Size
- Scales
- Plan Size and Location
- Profile Size and Location
- Drawing Overlaps
- Structure Text Contents
- Other Standards

All subsequent drawings are automatically generated using these same standards. Geographical maps created in other formats can be imported and placed under the plan view, automatically being cut and placed within the plan view area (See Figure 4). Electronic USGS maps, economically available today for most parts of the US, also are being imported into PLS-CADD. Finally, these drawings can be plotted directly within the software package, eliminating the need for any other drafting program. As an option, drawings can be exported to other popular drafting programs for further customization and archiving in those formats.

Section 2 – Overhead Lines and Installation

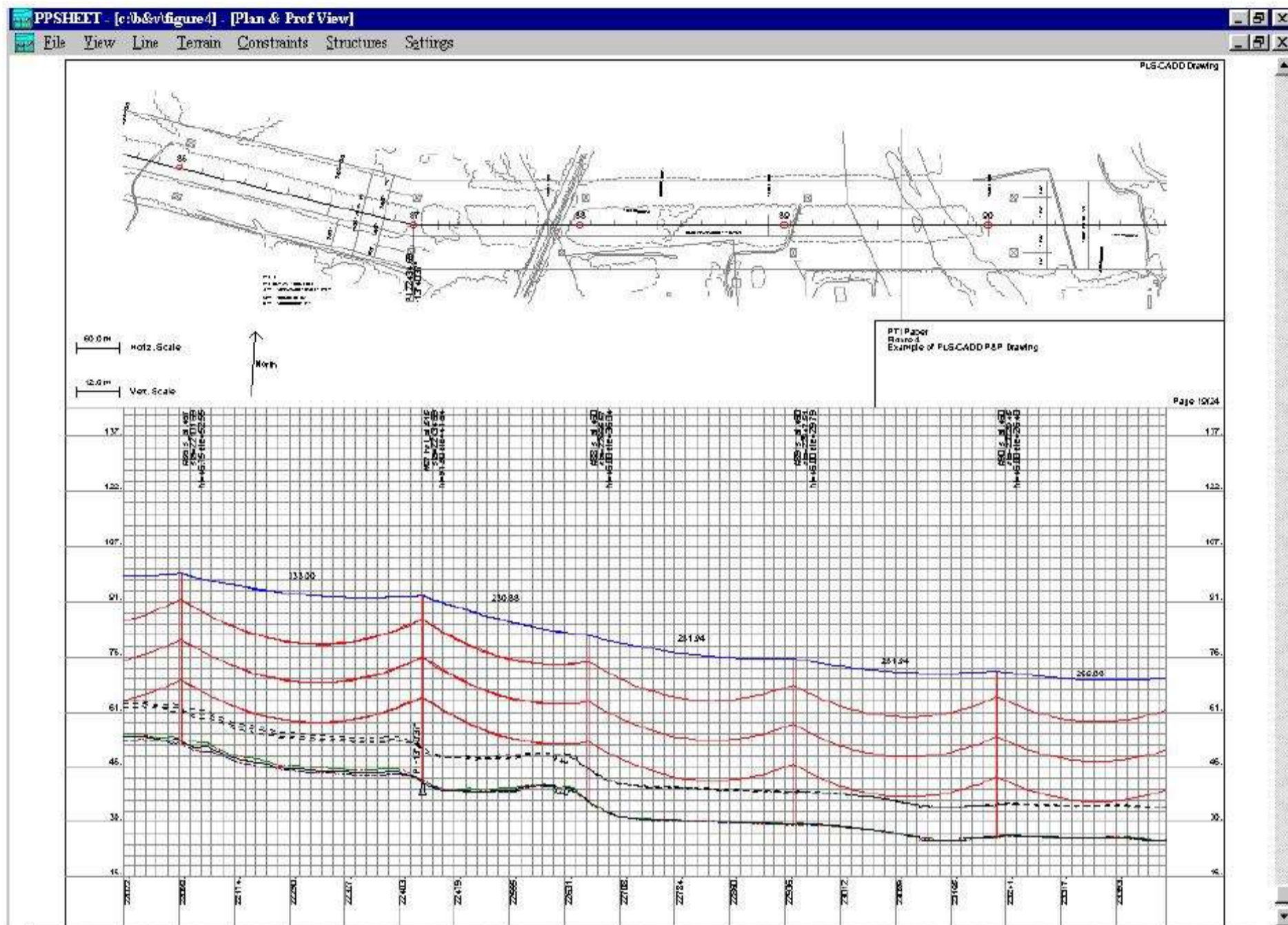

Figure 4 - Plan & profile drawing created in PLS-CADD. All design information on the drawing was obtained internally from the engineering process. The geographical map was directly imported and automatically cut and placed in the correct position.

PROCUREMENT

With any large transmission line project, the procurement process can be a project within itself. As a step towards the re-engineering effort, many self-supporting programs and spreadsheets have been developed to tabulate, quantify, and correlate the numerous parts and assemblies that make up the transmission line. PLS-CADD has adapted this ability internally. Parts, assemblies, and even labor units from existing databases can be electronically imported into the software, where the standard structures are associated with the appropriate units. The parts, assemblies, and labor (if used) can then be totaled, creating the structure cost to be used in the optimization process. This approach eliminates the need for the long and tedious process of developing the actual structure cost to use in any optimization program.

Material also can be associated on a specific structure site basis, for construction items such as gates and culverts. A material list can be generated from the line at any time for any section. This is extremely beneficial from the standpoint of determining marshaling yard locations along the line. The material list can be electronically transferred to most spreadsheet and word processing software, eliminating the need for re-entering data and thus preventing the introduction of errors and mistakes. Like drafting, material list generation is an extension of the engineering process.

Section 2 – Overhead Lines and Installation

CONCLUSIONS

Today's fast moving and economy-driven business environment has dictated that companies, both private and public, cannot be competitive without closely examining traditional design practices and taking full advantage of the tools available to help them overcome limitations. They must make conscious efforts to make paradigm shifts and welcome new ideas, technologies, and practices. The computer is the major tool of the corporate world, and PLS-CADD is the tool that has allowed the transmission line industry to make a major move within the re-engineering effort.

REFERENCES

Reed, M. D., Lynch, O. J., ""Near Field" Airborne Remote Sensing Using A Laser Mapping System on Electric Transmission Line Corridor Surveys and Capacity Analyses", Presented at the Second International Airborne Remote Sensing Conference and Exhibition in San Francisco, California 24-27 June 1996.

This article was published in the Autumn 1996 issue of Power Technology International magazine

Section 2 – Overhead Lines and Installation

Review questions for Section 2

1 Name the factors that are used in the selection for overhead line conductors

2 Name **six** commonly used materials for overhead lines.

- ---
- ---
- ---
- ---
- ---
- ---

3 Name the **three** factors that determine conductor current rating.

- ---
- ---
- ---

4 What are the factors that determine the maximum conductor temperature?

5 Name the standard methods used for protecting the steel against corrosion when it is used as reinforcement or as a conductor.

Section 2 – Overhead Lines and Installation

- 6 Name the types of supports for conductors. Describe the one that is commonly used in distribution.

- 7 Describe how wood poles are being protected against weather and fungal attack

- 8 State the governing factors that determine the stability of a pole

- 9 Define pole rake

Section 2 – Overhead Lines and Installation

10 Draw simple sketches of the following pole footings and describe their usages.

- Plain footing
- Concrete slab footing
- Concreted footing
- Baulk footing

Section 2 – Overhead Lines and Installation

11 State the factors that determine the lift of poles

12 For the wood pole label shown, describe the meaning of each item.

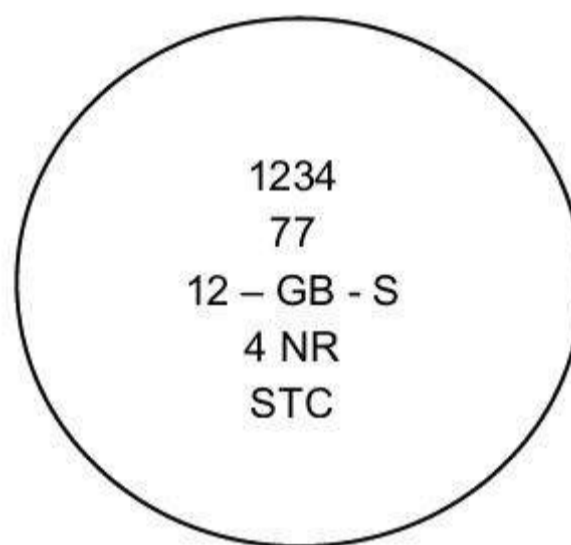

Label

13 Describe how pole strength is classified.

Section 2 – Overhead Lines and Installation

14 A cross arm is listed as 2.7P/16/100x100. Describe the meaning of each term in the list

15 Describe the **three** common types of insulators used in distribution systems.

- ---
- ---
- ---

16 The designation of an insulator is ALP 33/920. Describe the meaning of each item.

17 For the designation of an insulator: EA/2D, describe the meaning of each item.

18 Sketch 'creepage' of an insulator.

Section 2 – Overhead Lines and Installation

19 Describe the use of 'arcing horns'

20 Briefly describe the **three** determining factors for the mechanical properties of overhead conductors.

- ---
- ---
- ---

21 Describe briefly the **two** methods used in sag measurement.

- ---
- ---

22 Sketch the following stay anchorages

- Used in solid rock formation
- Used in weak rock formation
- Used in soil

Section 2 – Overhead Lines and Installation

- 23 Using the attached table, calculate the allowable sag for a 7/3.50 hard drawn copper overhead conductor with a span of 150 metres. The wind loading is 500 pascals and the maximum conductor tension is to be 50 percent of the ultimate tensile strength.

Stranding	Sectional Area mm ²	Overall diameter mm	Ultimate tensile strength N	Mass kg/m	Gravitational force (N/m)	Wind load at 500 Pa (N/m)	Resultant load at 500 Pa (N/m)	Resistance per Km at 20° C (OHMS)
17/1.00	5.50	3.00	2310	0.049	0.483	1.500	1.576	3.25
7/1.25	8.59	3.75	3610	0.077	0.754	1.875	2.021	2.09
7/1.75	16.84	5.25	6890	0.151	1.480	2.625	3.013	1.06
7/2.00	21.99	6.00	9020	0.197	1.931	3.000	3.568	0.815
7/2.75	41.58	8.25	16700	0.375	3.675	4.125	5.525	0.433
7/3.50	67.35	10.50	26600	0.607	5.949	5.250	7.934	0.268
19/1.75	45.70	8.75	18300	0.413	4.047	4.375	5.960	0.395
19/2.00	59.69	10.00	23900	0.538	5.272	5.000	7.266	0.302
19/2.75	12.90	13.80	44500	1.020	9.996	6.900	12.146	0.160
19/3.00	134.30	15.00	52800	1.210	11.858	7.500	14.031	0.134

Table 1

Temperature coefficient of resistance = 0.00381 per °C at 20° C

Section 3 – Underground Cables

3.1 Describe the construction features and insulation abbreviations of under ground cable

Cables

The majority of cables used for distribution work are impregnated paper insulated cables with a lead or lead alloy sheath. These cables up to 33kV are covered by the Australian Standard 1026. This standard also recognises aluminium sheathed cables and both aluminium and copper conductors for paper insulated cables.

The conductor

The conductor is made of either copper or aluminium

Table 5 presents the properties of these two types of conductor materials.

Properties	Units	Annealed Copper	99.5% Purity Aluminium $\frac{3}{4}$ H	99.5% Purity Aluminium T.O. as Extruded
Density	g/cm^3	8.89	2.703	2.700
Resistivity	Ωm at $20^\circ C$	1.7241×10^{-8}	2.8264×10^{-8}	2.803×10^{-8}
Temp. Coefficient of Resistance	$per^\circ C$	0.00393	0.00403	0.00403
Melting Point	$^\circ C$	1083	658	658
Coefficient of Expansion	$per^\circ C \times 10^{-6}$	17	23.8	23.8
Ultimate Tensile Strength	MPa	241	124	83

$\frac{3}{4}$ H – $\frac{3}{4}$ Hard

T.O. – SAA code symbol

Table 5

An analysis of these properties discloses that:

- 1 The electrical resistivity of aluminium is 164% of copper;
- 2 Although aluminium is only 30% of the density of copper it has 62% of its conductivity;
- 3 For equal conductivity, the ratio of
 - a) Areas is 1.64;
 - b) Diameters is 1.28 aluminium to copper.

Section 3 – Underground Cables

Types of Cables

The various types of cables are listed as follows:

- 1 Single core cables
- 2 Belted cables
- 3 Screened cables
- 4 Multicore SL cables
- 5 Multicore HSL cables
- 6 Oil filled cables
- 7 Gas filled cables
- 8 Plastic insulated cables

The main types used for distribution work are numbers 1, 2, 3 and 4 and these are described below.

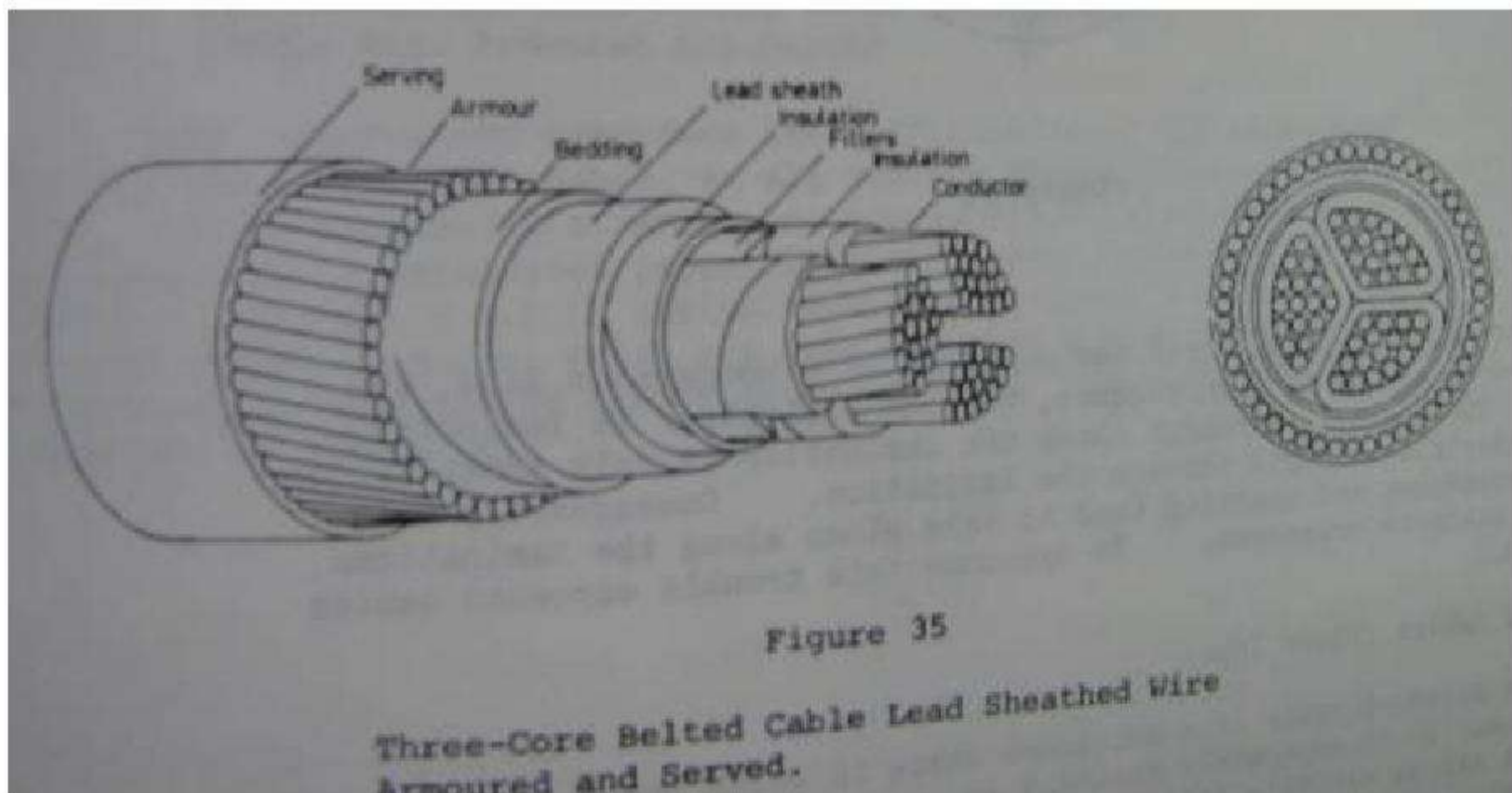

Screened Cables (Power Type)

A screened cable is a multicore cable in which the insulation of each conductor is separately enclosed in a conducting film in order to ensure a radial electric field surrounding the conductor. The films are in electrical connection with one another and with the metallic sheath of the cable. They are usually earthed (see Figure 37).

Section 3 – Underground Cables

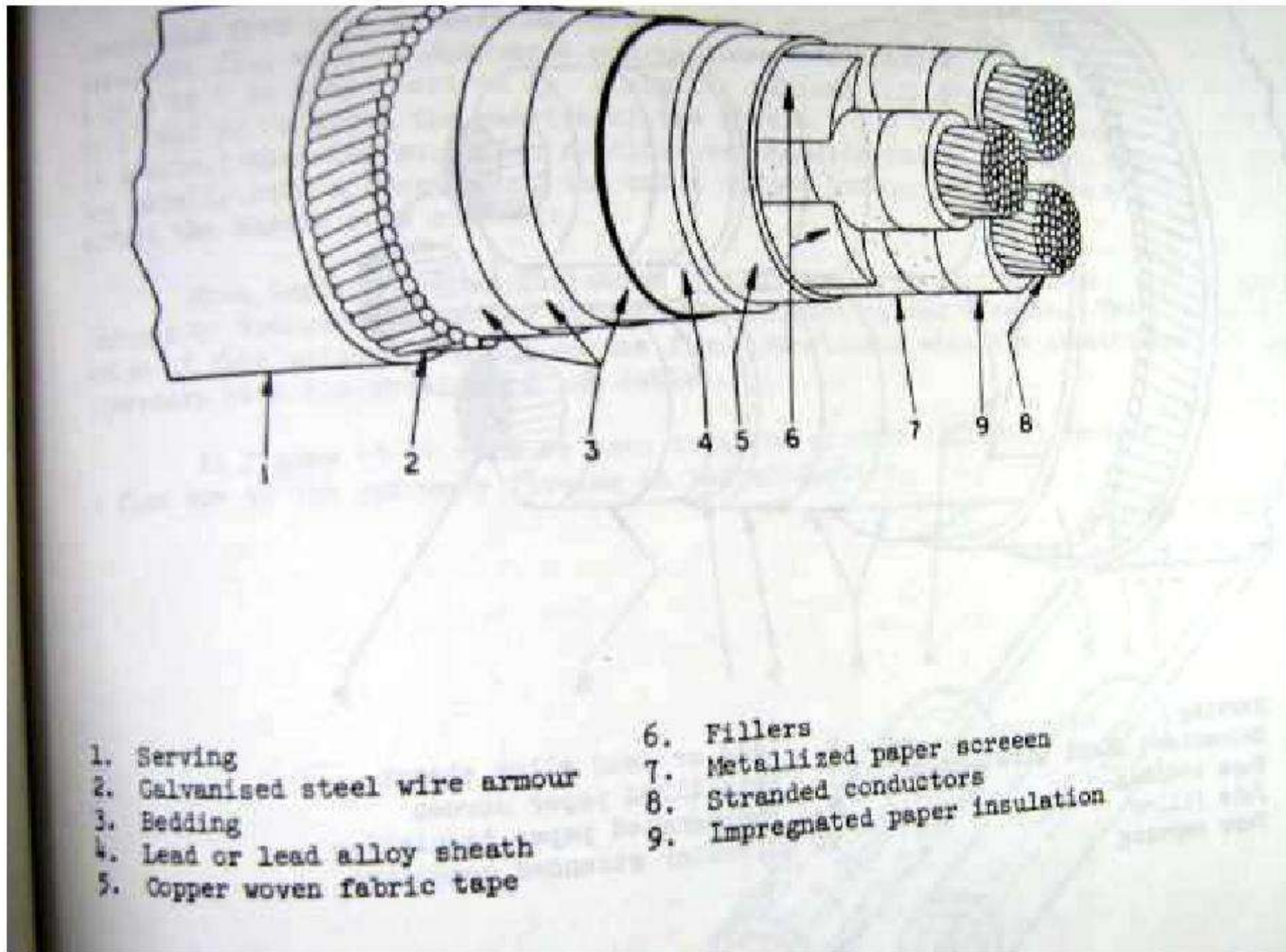

Current Rating of Cables

The current rating of cables is determined by:

- The thermal capacity of the cable
- The voltage drop
- The short circuit capacity

Sheath Currents

Sheath currents may be divided into two kinds, namely:

- Currents whose outward and return paths lie entirely in the sheath of one cable – sheath of one cable – sheath eddies.
- Currents whose outward and return paths are formed by the sheaths of separate cables - sheath circuit eddies.

The formation of sheath eddies is shown in Figure 39 where two single core cables are shown carrying a current I .

To obviate derating cables because of proximity effect, the following conditions should be considered:

- Where cables are fixed to a vertical surface or wall the distance between the wall and the surface of the cable should not be less than 20mm.
- Cables of which the cross sectional area does not exceed 185^2 should be installed at a distance between centres of not less than twice the overall diameter of the cable.

Section 3 – Underground Cables

- 3 Cables of which the cross sectional area exceeds 185^2 should be installed at a distance between centres of 90 mm.
- 4 Cables should be remote from iron and steel other than cable supports.

Conductor Temperatures

The maximum permissible continuous conductor temperatures for paper insulated cables are given in the following table

Voltage rating of cable kV	Type of cable	Maximum permissible temperature
0.6/1	All types	80
1.9/3.3		
3.8/6.6		
6.35/11	Single core	70
	Three core belted	65
	Three core screened	70
12.7/22		65
19/33	All types	

Table 6

Rating Factors

Tables of current ratings for cables always specify some ambient temperature and the number of cables which are in close proximity.

In practice the ambient temperature may be higher than that used for the design conditions, and so reduced current rating must be used.

When more than the specified number of cables are in close proximity the current rating of an individual cable must be reduced to allow for the cumulative heating effect in all adjacent cables. To allow for such conditions rating factors are used.

Rating factors for temperature changes are given in Figure 41; depth of laying in Figure 42; while proximity rating factors are given in Figure 43.

Section 3 – Underground Cables

Rating factors for ground air temperatures

Maximum Conductor Temperature °C	RATING FACTOR								
	Ground Temperature for Cables laid Direct or in Ducts				Air Temperature for Cables laid in Air				
	15°C	20°C	25°C	30°C	25°C	30°C	35°C	40°C	45°C
60	1.14	1.07	1.0	0.92	-	-	-	-	-
65	1.12	1.06	1.0	0.94	1.26	1.18	1.10	1.0	0.89
70	1.11	1.05	1.0	0.94	1.22	1.15	1.08	1.0	0.91
80	1.09	1.04	1.0	0.95	1.16	1.12	1.06	1.0	0.93

Figure 41

Single or Multicore Cables in Single Way Ducts

Depth of Laying Metres	0.6/1 kV Cables		1.9/3.3 kV to 19/33 kV Cables	
	Single Core	Multicore	Single Core	Multicore
0.50	1.00	1.00	-	-
0.60	0.98	0.99	-	-
0.80	0.95	0.97	1.00	1.00
1.00	0.93	0.96	0.98	0.99
1.25	0.90	0.95	0.95	0.97
1.50	0.89	0.94	0.93	0.96
1.75	0.88	0.94	0.92	0.95
2.0	0.87	0.93	0.90	0.94
2.5	0.86	0.93	0.89	0.93
3.0 or more	0.85	0.92	0.88	0.92

Section 3 – Underground Cables

3.2 Calculate cable voltage drop in relation to length of cable run (Part 1)

When selecting cables based on voltage drop the voltage drop in all circuits in the series arrangement must be considered.

Voltage drop is likely to be the main factor for selecting cable in circuits where:

- Cables carry high currents, that is, where
- Installation conditions are such that the current carrying capacity of a cable is not greatly reduced, and
- Maximum demand for the circuit is near the current carrying capacity of the cable

Cable route lengths are long.

Calculating voltage drop (Vd)

The actual voltage drop (Vd) for a particular cable in a given circuit is calculated using the equation:

$$Vd = \frac{Vc \times L \times I}{1000}$$

Where: Vd = actual voltage drop in volts

Vc = unit voltage drop in millivolts per ampere meter (mV/A.m)

This value is listed in the current carrying capacity and voltage drop tables of *Appendix B*.

L = route length of the circuit cables.

I = current to be carried by the circuit. (usually the maximum demand)

The divisor 1000 converts millivolts in the expression *mV/A.m* to volts.

A diversity allowance is applied when calculating voltage drop in domestic installations (See Clause 2.3.3(b)).

Calculating the unit value of voltage drop (Vc)

The maximum permissible unit value of voltage drop is calculated by using the same equation used for actual voltage drop transposer Vc is the subject.

$$Vc = \frac{1000Vd}{L \times I} \text{ mV/A}$$

Section 3 – Underground Cables

Single and three phase voltage drop

It may be necessary to convert the voltage drop in a single phase circuit to three phase voltage drop. For example determining the voltage drop in an installation from three phase consumers' mains to a single phase final subcircuit.

Conversion of the unit voltage drop value V_c ($mV/A.m$)

- Three phase $V_C = \text{single phase } V_c \times 0.866$
- Single phase $V_C = \text{three phase } V_c \div 0.866$

Conversion of the actual voltage drop V_d (Volts)

- Three phase $V_d = \text{single phase } V_d \times \sqrt{3}$
- Single phase $V_d = \text{three phase } V_d \div \sqrt{3}$

Cable selection based on voltage drop

You may need to select a cable size based on voltage drop where the voltage drop in the other cables in the series arrangement is known. For example:

Planning to meet voltage drop requirements

The following questions and comments will help you plan to select cables that meet voltage drop requirements.

What is maximum value of voltage drop permitted in the circuit?

- Supply voltage is voltage measured at consumer's terminals (Clause 2.3.3). Nominal voltage for single phase supply can generally be taken as 240 V.
- Maximum value of voltage drop in the cables to be selected is:
 - 5% of supply voltage (V_s) - sum of other voltage drops
 - °5% is 0.05 in your calculator
- In the circuit above this is $(V_s \times 5\%) - V_{d_{fsc}}$

What is the maximum unit of voltage drop (V_c in $mv/A.m$) that will satisfy the voltage drop requirements?

- Look up Appendix B and use the voltage drop equation to calculate maximum unit value of voltage drop.

Section 3 – Underground Cables

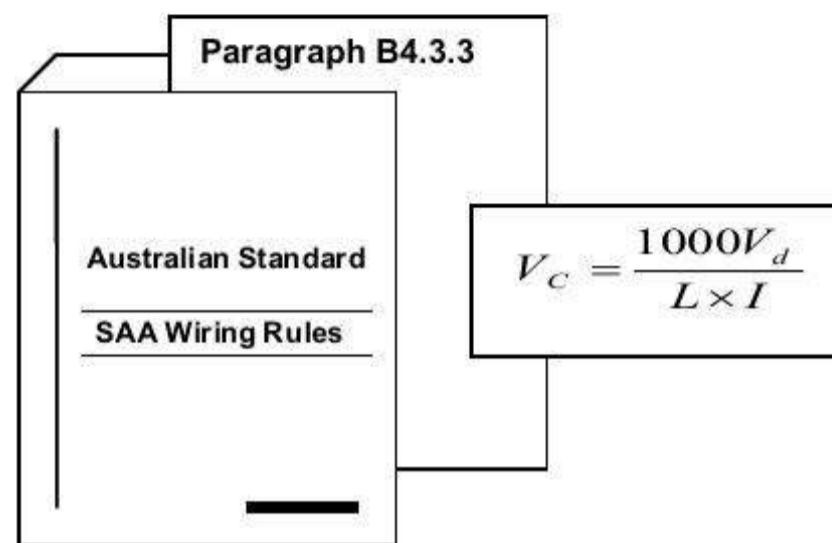

What cable has a unit value of voltage drop (V_c) equal to or less than the value calculated above?

- Look up the current carrying capacity and voltage drop (Table B2).

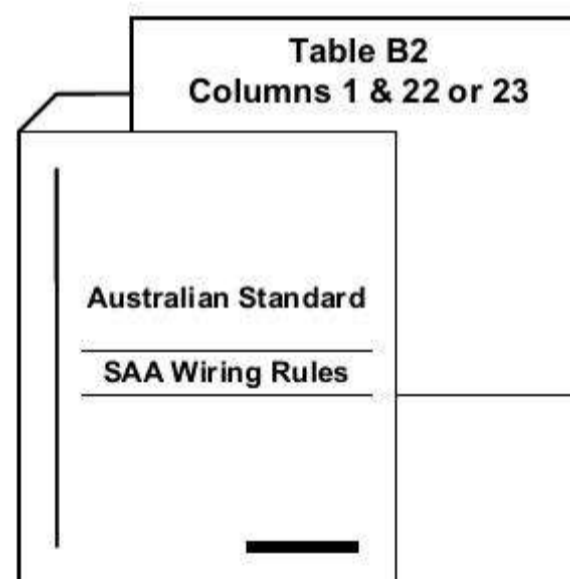

Will the cable size selected carry the current required by the circuit?

- Check the current carrying capacity in the appropriate table (Tables B2 or B3)
- Current carrying capacity of the cable must be equal to or greater than the maximum demand in the circuit.

Section 3 – Underground Cables

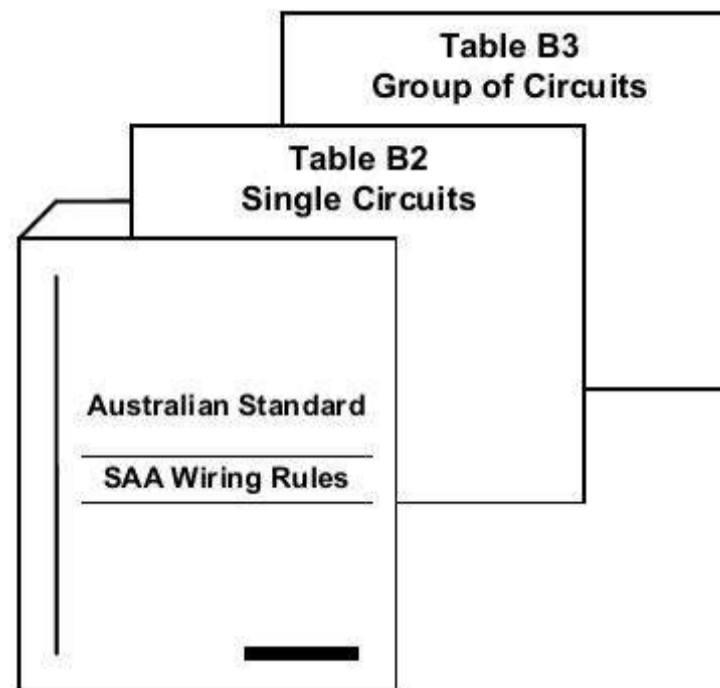

Alternative cable size

After all the cables in a series arrangement have been selected to satisfy current carrying capacity requirements it may be found that the voltage drop exceeds 5%. In this case it is usually only necessary to increase the size of one of the circuit cables.

What is the maximum permissible voltage drop for the installation?

- Supply voltage is voltage measured at consumers terminals (Clause 2.3.3)
- To convert single phase voltage drop to three phase voltage drop multiply by.

What is the voltage drop in each circuit?

- Look up
 - the voltage drop unit values
 - (V_c in mV/A.m) for the conductor size in each circuit.
 - The equation in *Appendix B*.
- Use the voltage drop equation to calculate the voltage drop for each circuit.

Section 3 – Underground Cables

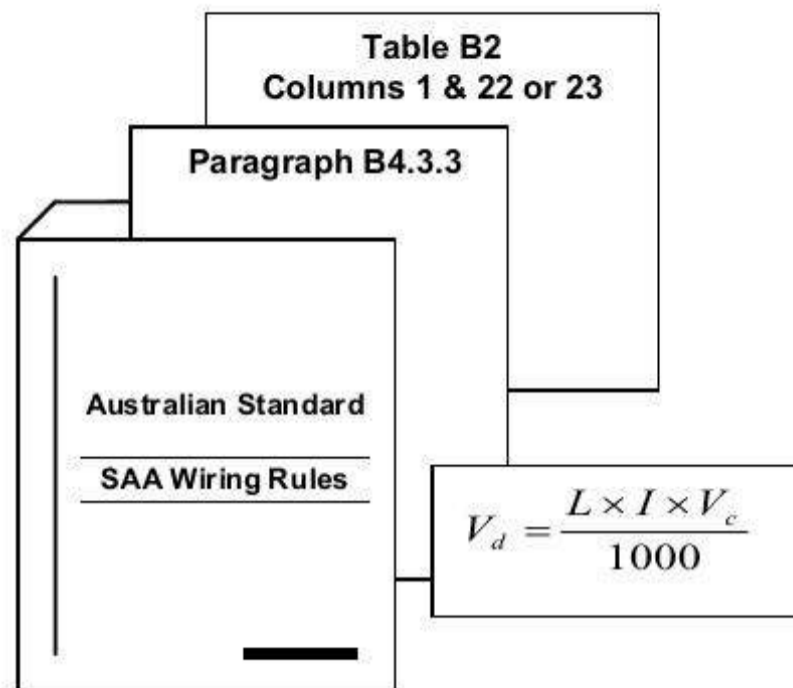

What is the total voltage drop for the installation?

- The total voltage drop is the sum of the voltage drops in the series arrangement of consumers mains, submains and final subcircuit.
- The sum must not exceed 5% of the supply voltage for any series arrangement of circuits from the consumers terminals to load device terminals.

What circuit/s should have its cable sizes increased?

- Where one cable has a much larger voltage drop than the other cables, increase its size.
- Where all circuits have a similar voltage drop, increase the cable size on the circuit that is likely to be least costly.

What is the maximum permitted voltage drop in the circuit which is to have its cable size increased?

- This is 5% of the supply voltage minus the sum of the voltage drops in the other circuits in the series arrangement.

Section 3 – Underground Cables

What is the maximum voltage drop unit value (V_c in $mV/A.m$) that will satisfy the maximum permitted voltage drop in the circuit?

- Look up Appendix B and apply the voltage drop equation.

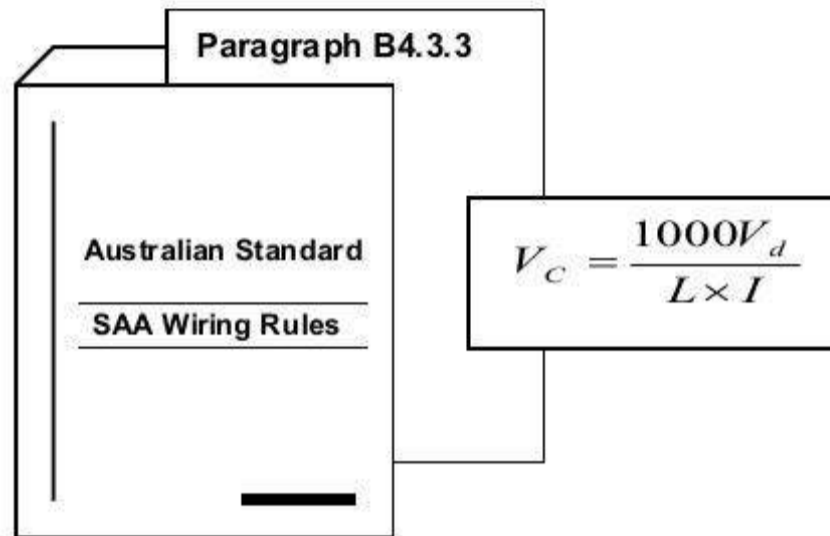

What cable has a unit value of voltage drop (V_c) equal to or less than the value calculated above?

- Look up the current carrying capacity and voltage drop table (Table B2)

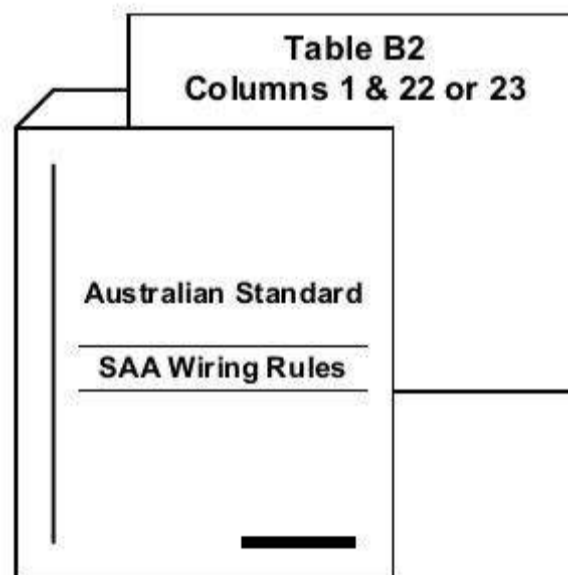

- Complete practical exercises 5 & 6.

Cable size

Current carrying capacity is likely to be the determining factor in selecting cable size where:

- Circuit route length is relatively short, and
- Derating factors apply such as circuit grouping and effect of thermal insulation.

Section 3 – Underground Cables

Voltage drop is likely to be the main consideration for selecting cable size in circuits with high currents and long route lengths.

The cable size must satisfy both current carrying capacity and voltage drop requirements.

Section 3 – Underground Cables

3.2 Calculate cable voltage drop in relation to length of cable run (Part 2)

Practical exercise 5: Select cables based on voltage drop

Task

Use AS 3000 to select a cable size based on voltage drop where the voltage drop of other cables in the series arrangements is known.

Instructions

For each of the following circuits determine:

- Maximum unit value of voltage drop (mV/A.m) permitted in the circuit
- Minimum cable size for the chosen circuit

Circuit 1

A lighting circuit in a single phase 240 V domestic installation with:

- Consumers mains $V_d = 9\text{ V}$
- Route length from switchboard: 28m
- Circuit breaker rating: 6 A
- Cable is TPS fully surrounded in thermal insulation.

Maximum unit value of voltage drop (mV/A.m) permitted in the circuit:

Minimum cable size: _____

Circuit 2

A 240 V caravan site supply position is 40 m from a distribution board.

Installation has:

- Three phase consumers mains: $V_d = 4.5\text{ V}$
- Three phase submains $V_d = 7\text{ V}$
- Final subcircuit is protected by a 16 A circuit breaker and installed underground.

Section 3 – Underground Cables

Maximum unit value of voltage drop (mV/A.m) permitted in the circuit:

Minimum cable size: _____

Circuit 3

A single phase 20 A irrigation pump is located 30 m from a distribution board.

Installation has:

- Single phase consumers mains: $V_d = 2 \text{ V}$
- Submains $V_d = 3 \text{ V}$
- Final subcircuit is protected by a rewirable fuse and is TPS cable on a catenary wire.

Maximum unit value of voltage drop (mV/A.m) permitted in the circuit:

Minimum cable size: _____

Circuit 4

A single phase 240 V 20 A appliance is wired in TP1 cable in steel conduit.

Installation has:

- Three phase consumers mains: $V_d = 6 \text{ V}$
- Three phase submains $V_d = 4 \text{ V}$

Appliance is located 30 m from the distribution board and is protected by a circuit breaker.

Maximum unit value of voltage drop (mV/A.m) permitted in the circuit:

Minimum cable size: _____

Section 3 – Underground Cables

Practical exercise 6: Select alternative cable size based on voltage drop

Task

Use AS 3000 to select an alternative cable size in one circuit of an installation to avoid excessive voltage drop.

Instructions

For each of the following circuits determine:

- Maximum permissible voltage drop in the installation.
- The voltage drop in each circuit in the series arrangement.
- The total voltage drop in the installation.
- The circuit you choose to increase the cable size.
- Maximum permitted voltage drop in the chosen circuit.
- Minimum cable size for the chosen circuit.

Installation

Consumer's mains are three phase 42 mm^2 bare copper aerials spaced 0.4 m apart. Length is 25 m and maximum demand is 200 A. Sub mains are three phase 16 mm^2 TPS cable in an underground duct. Length is 60 m and maximum demand is 75 A.

Final sub circuit is single phase 2.5 mm^2 TP1 cable in surface mounted conduit. Length is 18 m and maximum demand is 20A.

1. Maximum permissible voltage drop in the installation:_____
2. Voltage drop in each circuit:_____
3. Total voltage drop:_____
4. Circuit chosen to increase cable size:_____
5. Maximum permitted voltage drop in the chosen circuit:_____
6. Maximum unit value of voltage drop (mV/A.m) in the chosen circuit:_____
7. Minimum cable size for the chosen circuit:_____

Section 3 – Underground Cables

3.3 Recall techniques to reduce electrical stress on cables

For rules relating to specific installation requirements, consult AS 3000 Part 1 SAA Wiring Rules.

Method of removing cables from the cable drum

The cable drums should be placed on a common shaft as shown. The drums are reversed in relation to one another on the shaft as. The drums are reversed in relation to one another on the shaft. This will result in the cable of one drum being removed over the top of the drum while the cable on the second drum is removed under the drum. As the drums will revolve in opposite directions, they will tend to slow down because the friction between them acts as a brake. This prevents excess cable being wound off the drums and reduces the possibility of kinks and twists in the cables.

Many different types and varieties of cables are used in electrical installations. When a cable is selected for a given application, the appropriate Australian Standard (for example AS 3000) must be consulted to ensure that the cable chosen meets all the requirements of the different authorities concerned with the oversight and approval of electrical installation. The following combination of factors must be considered in making the correct selection of cable:

- Application and types of duty;
- Current conditions;
- Voltage drop considerations;
- Operating voltage;
- Operating environment, e.g. ambient temperature (of surrounding areas), possibility of vibration and/or mechanical damage.

Cable Stranding

Conductors may be either solid drawn or stranded. In the above example, the conductor was specified 1/1.38 mm. This is a single strand of 1.38 mm diameter conductor. The equivalent cross sectional area of this conductor as shown in the appropriate tables would be 1.5 mm^2

If a more flexible conductor was required, a 7/0.50 (e.g. a 7 strand) conductor could be used. Such a conductor would have the same cross-sectional area but also seven strands of 0.5 mm diameter conductors twisted together to form a single conductor.

The two differ mainly in cost and flexibility. The single stranded conductor is cheaper but less flexible than the stranded conductor.

Section 3 – Underground Cables

Because of its flexibility, the stranded conductor is generally used in installations prone to vibration, while the single strand conductor has wide use in domestic installations where low cost is an important factor.

Bending of Cables

Excessive bending of cables during their installation will reduce their working life. The parts of a cable especially liable to damage through undue bending are conductors, paper or cambris tapes, metal or conductive tapes, core screens and insulation of high voltage cables.

Tables in the appendix list the recommended bending radii for various cables.

Temperature Ratings

Cables have a temperature rating based on that of the insulation. Maximum operating temperatures are set out in the Appendix. However, some specific examples are:

- R75 or V75 has a maximum working temperature of $75^{\circ}C$
These cables would be used in general wiring, i.e. normal domestic installations.
- V105 has a maximum working temperature of $105^{\circ}C$
- R-S-150 has a maximum working temperature of $150^{\circ}C$
These cables would be used in high temperature applications such as fluorescent strip lighting.
- Heat resisting fibrous insulation has operating temperatures ranging from $110^{\circ}C$ to in excess of $200^{\circ}C$, depending on the type used.
These cables would be used in high temperature incandescent lamp fittings.

Polytetrafluorethylene (PTFE) cable has a working temperature of $200^{\circ}C$

- This type of cable would be used to connect the hot plates of an electric range to the appropriate control switch.

Enclosure of Cables

The maximum number of cables that may be enclosed in a conduit or pipe must comply with the requirements of the SAA Wiring Rules Part 1

The procedure used to determine the size conduit for a particular job is as follows:

- Determine the overall cross sectional area of each cable size to be installed in conduit (Table 3 of Appendix refers)
- Calculate the total overall cross sectional area of all the cables to be installed in the conduit.

Section 3 – Underground Cables

- Determine the required conduit size, having regard to the space factor based on the number of cables to be installed in the conduit. (Table 2)
- Check that the proposed conduit enclosure will conform to the requirements of Tables 4 and 5, regarding the maximum number of cables to be enclosed.

Types of Conductors

The two main types of material used for conductors are aluminium and copper, each having specific advantages:

Copper:

- Has high conductivity per unit area;
- Is easily mechanical joined or soldered;
- Is expensive;
- Is resistant to corrosion;
- Is stronger than aluminium.

Aluminium:

- Has high conductivity per weight;
- Must be joined with a joining paste, since aluminium oxide, an insulator, forms almost immediately after cleaning;
- Is cheaper than copper, but its coefficient of expansion must be taken into account when joining;
- Is not as resistant to corrosion;
- Is weaker than copper;

When used in installations such as aerials, aluminium cable is usually steel cored for added strength

The cable lugs used on aluminium cables are longer and thicker, while aluminium cables require a larger bending radius than copper cables.

The performance of cable insulating material will be drastically affected if the cable is exposed to:

- Weather
- Oil
- Abrasion
- Chemicals

Section 3 – Underground Cables

Tables in the appendix detail the relative performance of various sheathing materials. A comparison of vulcanised rubber has:

- Operating temperature;
- Poorer weather resistance;
- Poorer oil resistance;
- Similar water resistance;
- Poorer chemical resistance
- Poorer solvent resistance;
- Poorer abrasion resistance;
- Similar flame and insulation resistance;
- Similar electric strength.

Section 3 – Underground Cables

3.4 Recall cable rating factors, method of cable joining

Paper insulated, lead sheathed armoured cable, PVC served, typically has the following features:

- Conductors – stranded copper or aluminium
- Insulation – oil impregnated paper
- Covering – lead sheathing
- Armouring – steel wire
- Serving – PVC (as protection against corrosion)

This type of cable is mainly used for high voltage distribution systems.

The three-core plus earth, PVC insulated, steel wire armoured, PVC sheathed cable is used where cables are prone to mechanical damage. The steel wire armouring acts as a buffer to prevent damage to the conductors.

Table 14 in the Appendix provides further details.

The substitution of aluminium conductors results in a less expensive alternative.

Note that the conductors are shaped to allow maximum utilisation of space to counteract the larger aluminium cables required to match the conductivity of copper.

Aluminium cables require special joining techniques which will be discussed later.

Stripping the Cable

The correct stripping of cables is of utmost importance as an incorrect stripping method will result in a nicking of the conductor. This will impair its mechanical strength and after relatively few bends of the conductor a break may occur.

- Knife
- Adjustable strippers
- Automatic strippers
- Pliers

The Knife

To use the knife:

- Cut insulation away from your body.
- Slice insulation at an angle of approximately 15° to the insulation to avoid cutting into the conductor.
- Continue the process until all the required insulation is removed from the conductor.

Section 3 – Underground Cables

Adjustable Strippers

To use adjustable strippers:

- Rotate the adjusting screw until the strippers close and the jaws grip the cable insulation.
- Rotate a further half turn until the jaws begin to cut the insulation.
Do not screw the adjusting screw too tight as this will damage the conductor.
- Pull the strippers away from the cable; this will remove the insulation.

Automatic Strippers

Automatic strippers are available from most electrical wholesalers. This stripper operates automatically once the correct positions on the blade is selected and the handles compressed together.

- Grip the insulation under one set of jaws.
- Knick the insulation under the other set of jaws.
- Remove the insulation by moving the second set of jaws away from the first by squeezing the handles.

Automatic strippers are generally used by production times requiring many cables to be effectively stripped as quickly as possible.

Pliers

Many experienced electricians use their pliers to strip cables. However, this method is not recommended for inexperienced persons, as it carries a high risk of damaging the conductor.

The pressure exerted by the plier jaws in gripping the insulation is critical; too much pressure will damage the conductor.

Replacement of insulation

Observe the following points in stripping:

- Do not remove insulation further than is necessary to allow each conductor to enter and extend to the full length of the hole where it is to be clamped or joined.
- Cut away insulating material damaged by soldering and replace it with insulation equipment to the original.

Basic Terminating Methods

Two widely used methods of termination are:

- Soldering
- Mechanical connection

Section 3 – Underground Cables

Soldering

Care must be taken when soldering to prevent the formation of a 'dry joint' which results in a high resistance joint.

To prevent a dry joint forming:

- Heat the cable to solder-melting temperature and apply solder to the cable.
The melting of the solder is produced by heat from the cable rather than direct heat from the flame or the soldering iron.
- Do not move the soldered connection until the solder has solidified.

The automatic preset crimping tool crimps 0.5 to 6 mm^2 cables and has an automatic predetermined depth control.

Cables from 10 to 120 mm^2 may be crimped using an adjustable crimper. The size of the crimp is set by rotating the adjusting screw and lining up the mark on the jaws with the scale on the crimper.

Large cables generally require much force to be exerted during the crimping operation. For these, hydraulic crimpers are used.

Aluminium Conductors

The use of aluminium conductors is becoming increasingly popular because aluminium:

- Is cheaper than copper;
- Is about 1/3 the weight of copper;
- Has a larger cross sectional area for the equivalent current rating than copper;
- Has a better thermal capacity than copper

The cost and weight factors are the main reasons for aluminium's growing use for aerials, busbars and large current carrying conductors.

Joining Aluminium Conductors

The major problem in joining aluminium conductors is the oxide which reforms on the surface as soon as it is removed. This oxide is an effective insulator.

To overcome oxide formation, a contact aid is used in cleaning aluminium surfaces for joining. This consists of a special grease which may contain abrasive particles to help in the removal of the oxide film. The grease prevents the oxide reforming.

NOTE:

Ordinary greases are not used as they may corrode aluminium.

Section 3 – Underground Cables

3.5 Apply cable schedules for underground cable installation scheme

Underground Cables

Introduction. In towns and densely populated areas overhead lines are clearly impossible. In the very early days of distribution the principles of overhead lines were employed in underground work. One very successful system was devised by Crompton, who stretched bare conductors between glass insulators contained in underground ducts or culverts; one such system was in use in 1926 after thirty years service. The method was successful for low voltage systems, except that explosions sometimes occurred due to pressure of gas produced by the metallic sodium which was formed by electrolysis, due to slow leakage at the insulators. The method is unsuitable for high voltages because of the flash over of the insulators. It was found advisable to insulate the conductor before it was laid, and the combination of conductor and its insulation is called a cable.

Vulcanized rubber insulated cables were then used, and because of their failure vulcanized bitumen cables. The latter are still used for low voltage distributors and in mines.

One of the earliest attempts to make a high voltage, paper insulated cable was due to Ferranti, who wrapped oil impregnated paper round copper tubes and pushed the insulated conductor into lengths of wrought iron pipes which he filled with compound

Types of Cable

There are many types of cable used at the present time; the type for a particular service is determined by the mechanical properties required and the voltage of transmission, mainly the latter.

Low Tension Cables (Below 1000 Volt)

The insulating material may be impregnated paper, varnished cambric, vulcanized rubber, or vulcanized bitumen.

Paper is the most important insulating material, and is made of wood pulp, manila fibre or rag. The impregnating compound is thin or thick oil with or without resin. The resin is added to increase viscosity at working temperatures so that drainage should not be excessive, whilst it does not increase the viscosity greatly at the temperature of impregnation. The thickness of dielectric at 660 volts is between 0.08 and 0.11 in.

Varnished cambric is coated with petroleum jelly to provide lubrication between layers so that bending of the cable is possible without damage. An advantage is that there is no drainage from the ends of the cable.

In *vulcanized bitumen* cables the refined bitumen is melted and sulphur and vegetable oils are added. On cooling, the bitumen hardens and acts as the

Section 3 – Underground Cables

waterproof envelope of the cable. No elaborate sealing is required. A major disadvantage is that the bitumen becomes soft under the action of alkaline solutions, and the conductor becomes decentralised. Vulcanized bitumen cables were once favoured for shaft and roadway cables because they are easily jointed, do not require elaborate sealing, and are light compared with lead covered, paper insulated cables. They are not now made because of the softening and decentralisation, and are being replaced by the paper cables, which are often cheaper and as suitable, and have a greater current carrying capacity

Lead sheathed, rubber insulated cables have a vast field of use in house wiring, large building, and ships.

Cables in mines are subjected to specially rough handling and they are constructed accordingly. Trailing cables must be flexible and must be capable of being dragged along without being damaged. Fig. 69 shows a 5 core trailing cable, with a tough rubber central cradle, insulated pilot, tough rubber sheath, and braided wire screen. One of the conductors acts as the earth conductor, and all the five cores are rubber insulated flexibles. The central cradle prevents a short circuit from occurring when a fall of coal or tone crushes the cable. The braided wire screen is of tinned copper and is embedded in the tough rubber sheathing; the screen is earthed but is not used as the earth conductor. The pilot wire serves for the remote control of coal cutter and other circuits.

Shaft cables should be drained and not contain free compound, otherwise the compound will settle and force its way out at the lower termination. The installation of a shaft cable is best performed in the following way, in order that the cable may not suffer a large tension due to its weight. The cleats are first fixed. Then the cable is run from a winch over pulleys into the shaft, where a short length is allowed to swing free. It is fastened to a winch rope with a spun yarn lashing and then lowered a short distance, say 30 ft. It is lashed again, and lowered a further distance. This is repeated until the cable reaches the bottom of the shaft.

Section 3 – Underground Cables

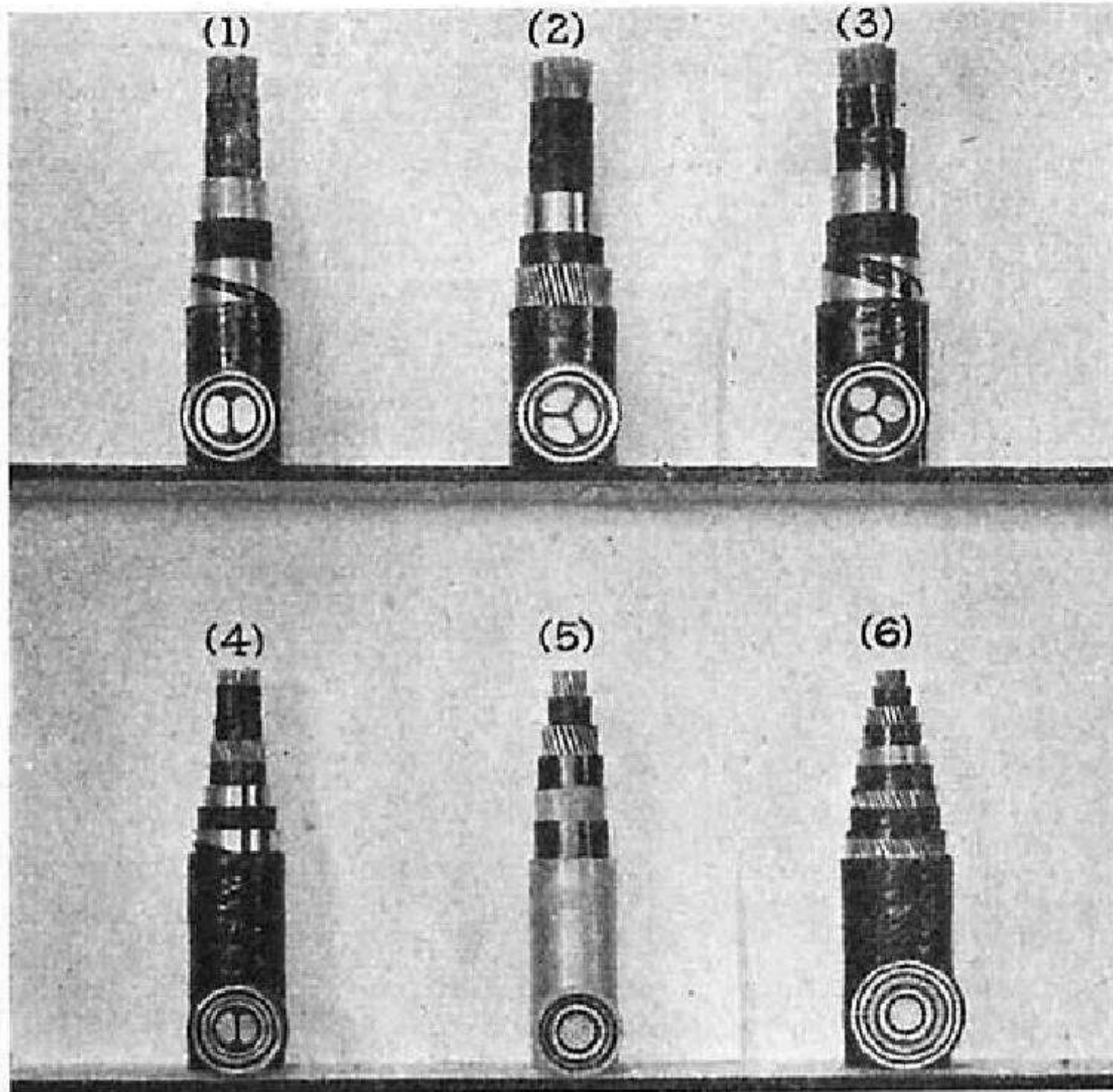

FIG. 70 PAPER-INSULATED POWER CABLES

Fig 70 Paper Insulated Power Cables

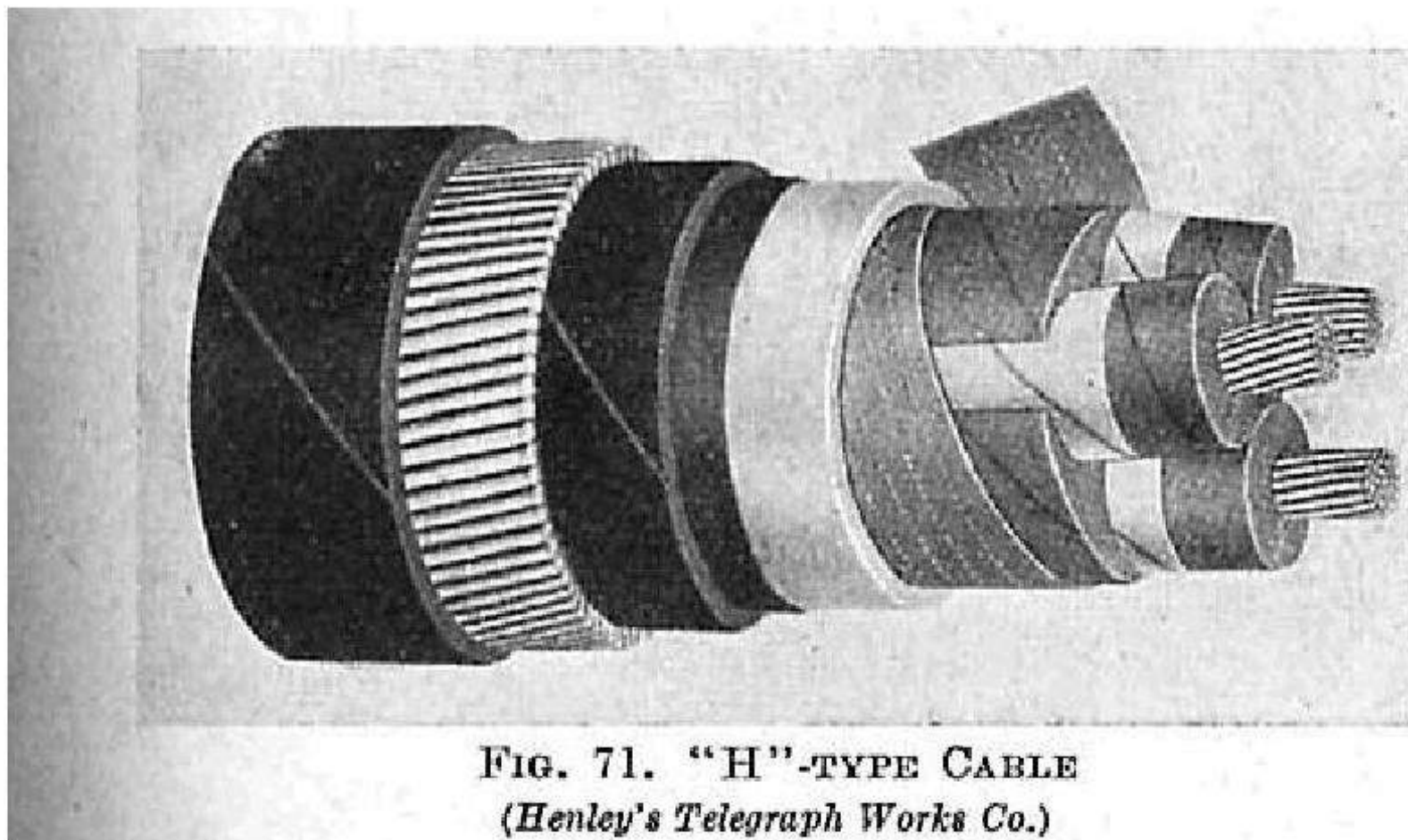

FIG. 71. "H"-TYPE CABLE
(*Henley's Telegraph Works Co.*)

Section 3 – Underground Cables

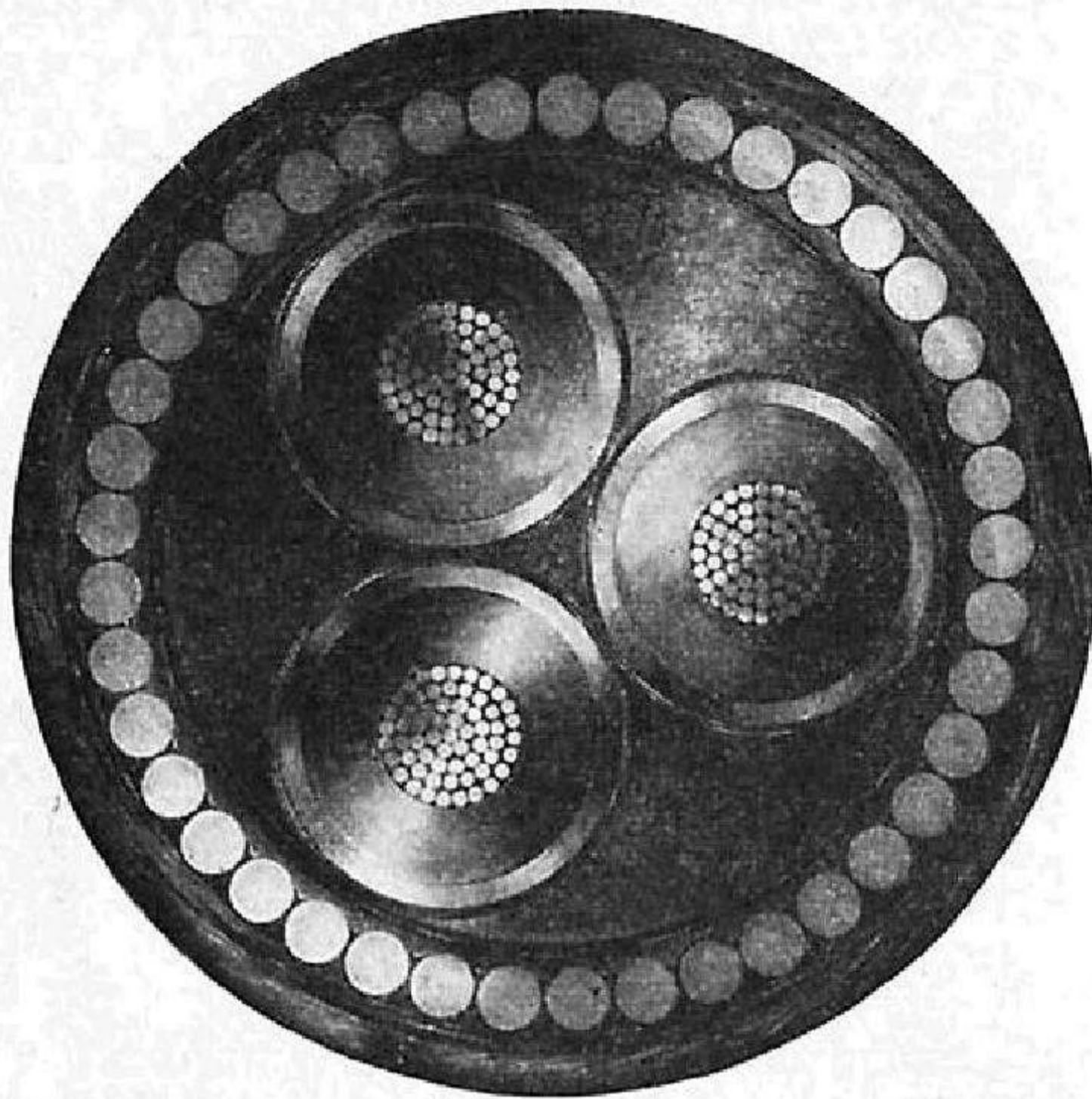

FIG. 72. "H.S.L."-TYPE CABLE
(Siemens Bros.)

Laying

There are three main methods of laying cables: *direct laying*, the *draw in* system, and the *solid* system.

In direct laying a trench is dug, in which the cable is laid and covered with soil. The cable may be protected by planks, bricks, tiles, or concrete slabs. It used to be the practice to armour such cables, but nowadays they are often laid with a bare sheath or with a serving of bituminized paper and Hessian over the sheath. The former method is the only safe one in places where subsidence of the soil is likely to occur; then the cable should have steel wire armouring, so as to take a considerable tension. If the ground contains harmful chemicals, the serving must be adequate to protect the cable from corrosion and electrolysis. Bituminized paper is effective. It is clear that direct laying is cheap, but an extension of load is possible only by a completely new excavation which costs as much as the original work. In most cases, digging and trenching are done manually, but in laces free from obstruction machine methods can be used.

Section 3 – Underground Cables

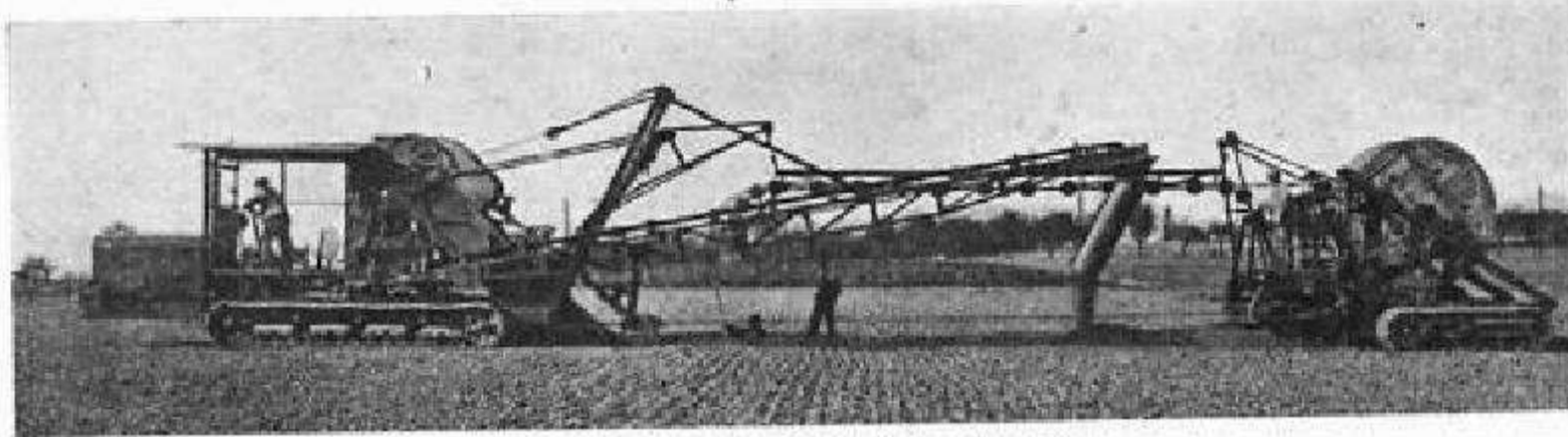

FIG. 78. MACHINE LAYING OF CABLES
(Wasserhutte A.-G.)

Fig. 78 shows a machine dredges a trench 18in.wide by 5 ft. deep, conveys the soil back along the top, and lays the cable. The trench is then filled and levelled.

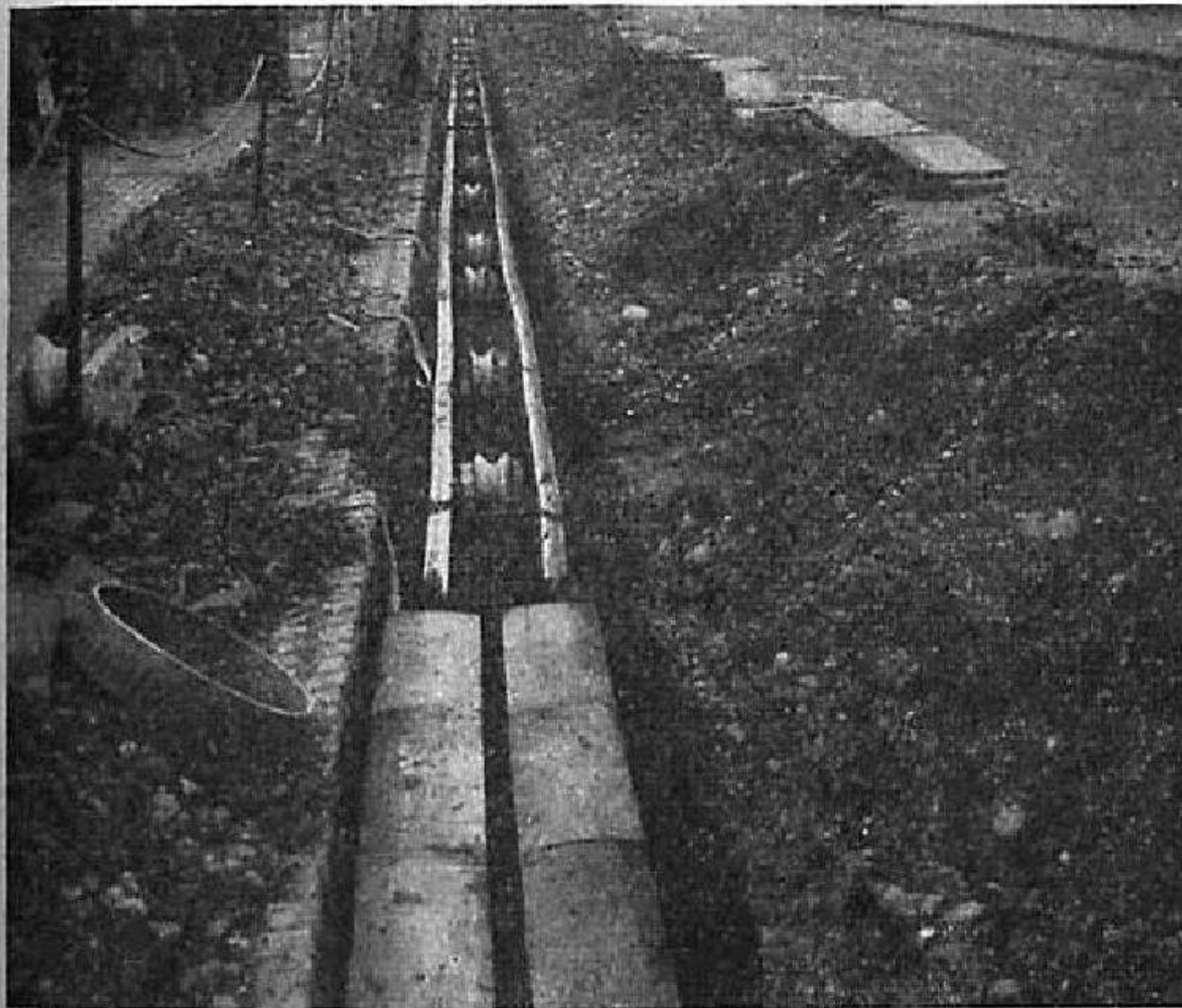

FIG. 79. CABLES IN TRENCH PROTECTED BY CONCRETE COVERS

Fig. 79 shows a cable in a trench with concrete covers for protection.

In the draw in system a line of conduits, ducts, or tubes is laid in a trench. The conduits or ducts are of glazed stoneware, cement, or concrete (Fig 80). The tubes are of stoneware, fibre, steel, or wrought iron. The ducts being laid, the cables are pulled into position from manholes or brick pits. It is unnecessary to

Section 3 – Underground Cables

armour the cable, but a serving of Hessian tape of jute protects the cable when drawing in.

In the solid system the cable is laid in troughing in an open trench.

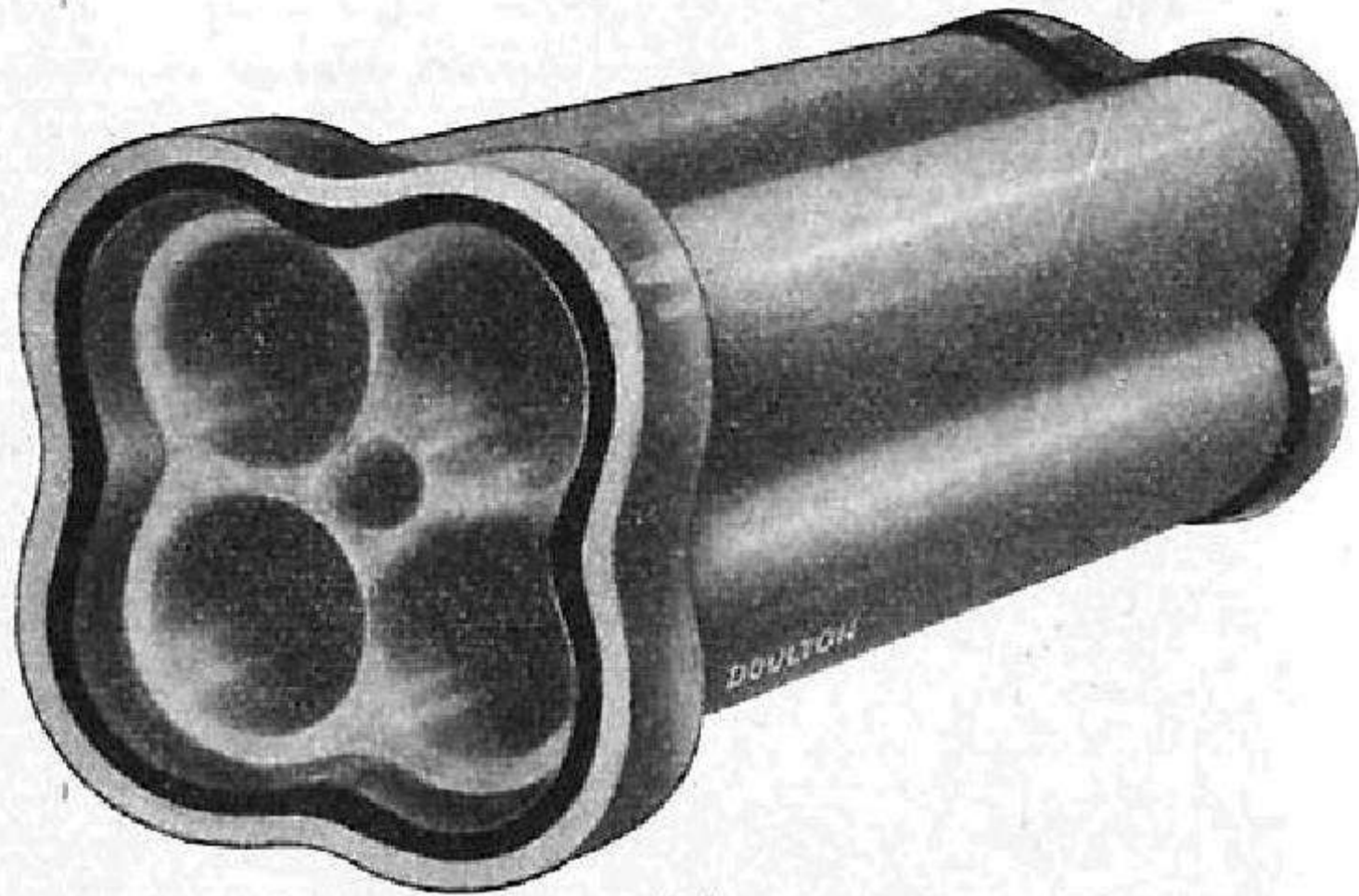

(a)

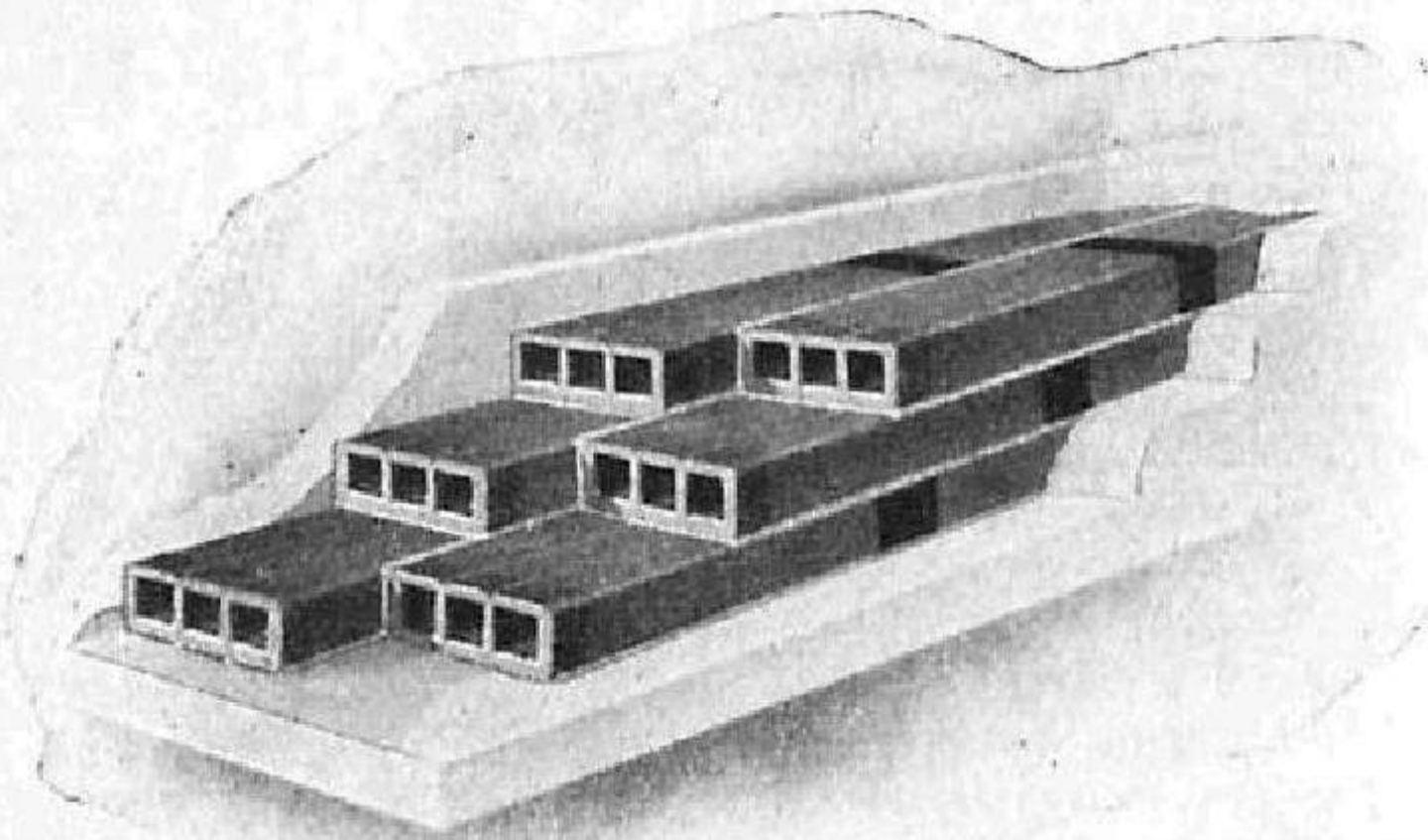

(b)

FIG. 80. STONEWARE CONDUITS

(a) Multiple duct.

(b) Multiple butt-ended stoneware conduit.
(Doulton)

Section 3 – Underground Cables

The troughing is of stoneware, cast iron, asphalt, or treated wood. After the cable is placed in position, the troughing is filled with a bituminous or asphaltic compound and covered over. The cable can be laid with a bare sheath, and is immune from electrolysis as the sheath is electrically insulated from earth. Fig 81 shows a trough containing cable and covered with asphalt.

Jointing

The most common way of jointing the conductors is to insert the ends into a ferrule, which is a slotted metal tube, and solder the whole solid.

With oval cable the ferrule is made in two halves which can be turned with respect to one another, in order that the cables need not be twisted to make their major axes parallel. Packing adaptors are also being used.

Fig .82 shows a join for a 66kV., single core, "H" – type cable with oval conductor. The following is a brief description of the procedure. The lead sheath is cut back 20 5/8 in. and the paper 2 7/8 in. The lead sleeve, lead flare and paper tube are passed back along the conductors. The ferrule is put on and the parts soldered together. The paper is pencilled back 1 1/4 in., and the metallized paper is cut back to within 1 1/2 in. of the lead. The paper tube is slipped into position and fixed by four narrow wedges, which are jammed in by layers of oiled silk tape. The paper tube is kept in a canted position by a kalanite spreader, which is made of two halves as shown in the cross sectional diagram. This ensures that no air will be entrapped when the joint is filled with compound. Preshaped paper stress cones are lapped on, and oilproof (Kaleoilres) tape is wrapped over the end of the lead sheath to prevent oil from flowing from the joint into the cable. The lead flare is placed in position and 1/4 in. diameter lead wire is wrapped on. The lead sleeve is put in position and plumbed at the ends and the middle. The bonding strands are fixed, and then the joint is filled with oil. It is seen that the upper part of the lead sleeve is shaped so that the sleeve cannot be filled completely with oil; the air dome is left to allow for the expansion of the oil. The black sectors show in the figure represent steel reinforcing bands.

Fig. 83 shows a joint for a 66kV. Oil filled cable, single core. It is essential that no moisture or dust shall enter the jointing tent.

Fig. 84 shows the recently designed styrene joint. The styrene is added as liquid and on being heated it polymerizes and sets into a very hard solid. The method is specially useful for 3 core cables, as the joint is mechanically rigid and displacement of the cores cannot occur.

A recent type of joint, which is solid at working temperatures, employs a mixture of oil and finely powdered and cleaned sand in place of the styrene. A small lead flare is used between the plumbed joint and the lead cylinder containing the compound.

Section 3 – Underground Cables

Insulation Resistance

Consider a single core cable of conductor radius τ and internal sheath radius $1/2D$. The resistance of a thin shell between radii x and $x+dx$, and axial length 1cm. is

$$dR = p dx / 2\pi x,$$

Where p is the resistivity or specific resistance of the dielectric, for the area of cross section is $2\pi x \times 1cm^2$ and the thickness is dx .

The total resistance is thus

$$R = \int_{\tau}^{1/2D} \frac{p dx}{2\pi x} = \frac{p}{2\pi} \log h \frac{D}{2\tau}$$

The insulation resistance of a length l is

$$R_l = (p / 2\pi l) \log h(D / 2\tau)$$

The value of p for impregnate paper is about 5×10^{14} ohms, and decreases exponentially with temperature, so that

$$pt = p_0 e^{-\alpha t} : \alpha \text{ is about } 0.05$$

Example. Find the insulation resistance per mile of a cable of conductor diameter 0.4 in. and internal sheath diameter 0.7 in. $p = 6 \times 10^{14}$

The resistance of 1 mile is

$$\begin{aligned} & \frac{p \times 2.303}{2\pi \times 5280 \times 12 \times 2.54} \log \frac{D}{2\tau} \text{ ohms} \\ &= 2.28 \times 10^{-6} p \log(D / 2\tau) \text{ ohms} \\ &= 2.28 \times 10^{-6} \times 6 \times 10^{14} \log(7 / 4) \\ &= 3.21 \times 10^{-8} \text{ ohms} = \underline{\underline{321}} \text{ M}\Omega \end{aligned}$$

Section 3 – Underground Cables

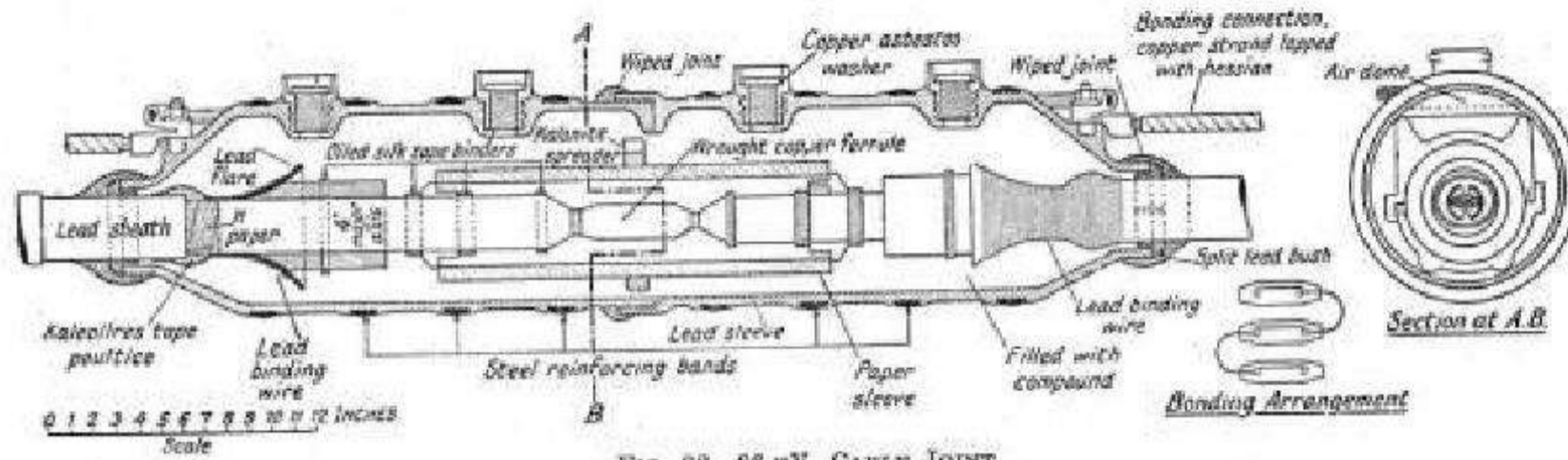

FIG. 82. 66 kV. CABLE JOINT
(Cattinder's Cable and Construction Co.)

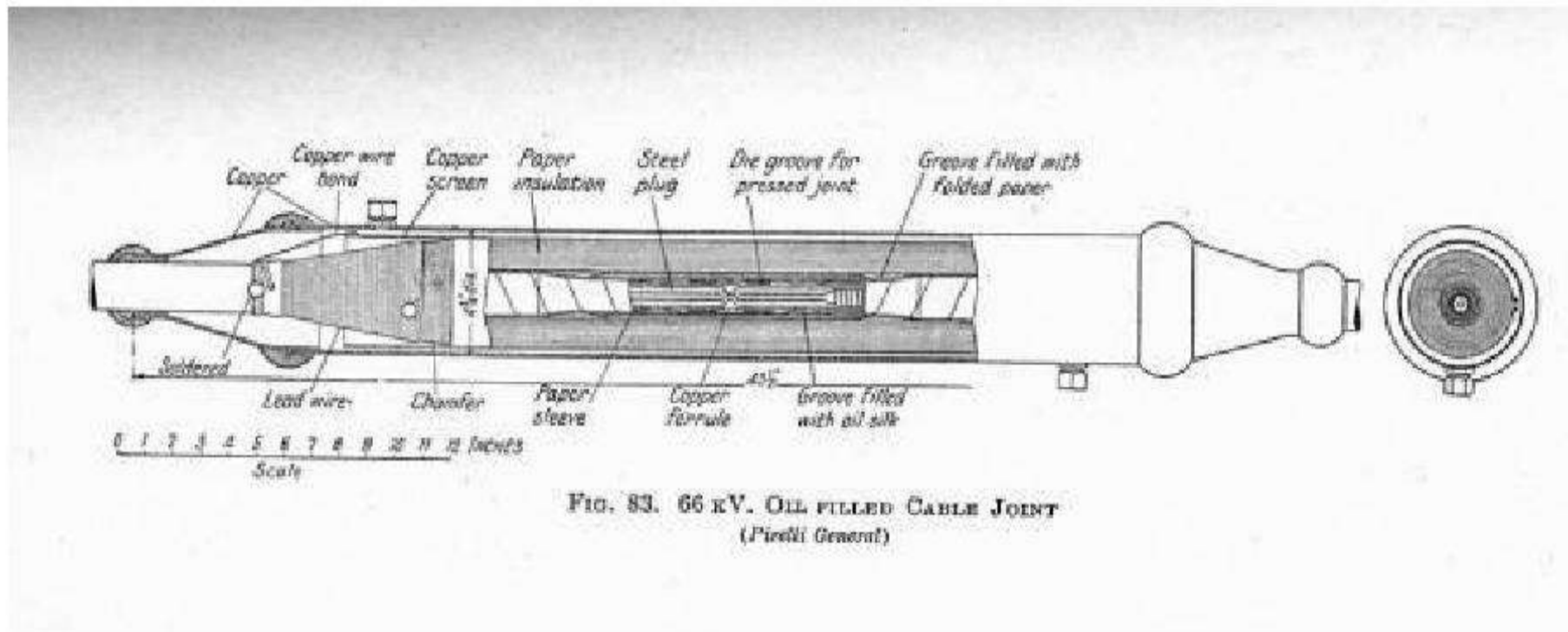

FIG. 83. 66 kV. OIL FILLED CABLE JOINT
(Picelli General)

Example. Deduce a formula for the insulation resistance to earth of the positive and negative mains of a 2 wire system in terms of V , V_1 , V_2 and τ , where V is the voltage between the mains, and V_1 and V_2 are the respective readings on a voltmeter having a resistance τ when connected between the positive main and earth and between the negative main and earth.

Find the insulation resistance of each main to earth when $V = 250$, $V_1 = 150$ and $V_2 = 30$ V., the voltmeter resistance τ being $10\,000\ \Omega$ (Lond. Univ., 1932)

Let the mains have earth resistances R_1 and R_2 . It is clear that the resistance between the mains R_3 , does not affect the readings.

Section 3 – Underground Cables

When the voltmeter is across the positive main and earth, the system is as shown in Fig. 85. The following currents then flow to and from the earth: (1) V_1 / τ downwards, (ii) V_1 / R_1 downwards, and (iii) $V - V_1 / R_2$ upwards.

Therefore

$$(V_1 / \tau) + (V_1 / R_1) = (V - V_1) / R_2$$

Giving

$$V_1(1/\tau + 1/R_1 + 1/R_2) = V/R_2$$

Similarly in the other case

$$V_2(1/\tau + 1/R_1 + 1/R_2) = V/R_1$$

Therefore, by division,

$$V_1 / V_2 = R_1 / R_2,$$

So that

$$\begin{aligned} V/V_2 &= R_1(1/\tau + 1/R_1 + 1/R_2) \\ &= R_1/\tau + 1 + R_1/R_2 \\ &= R_1/\tau + 1 + V_1/V_2, \end{aligned}$$

Giving

$$R_1 = \tau \left(\frac{V}{V_2} - 1 - \frac{V_1}{V_2} \right) = r \frac{V - V_1 - V_2}{V_2}$$

Similarly

$$R_2 = r \frac{V - V_1 - V_2}{V_1}$$

In this case $R_1 = 10000 \left(\frac{250 - 150 - 30}{30} \right) = \underline{\underline{23300}} \ \Omega$

And $R_2 = 10000 \left(\frac{250 - 150 - 30}{150} \right) = \underline{\underline{4660}} \ \Omega$

Stress and Capacitance of Single-Core Cable

Suppose that the cable of Fig. 86 has a dielectric constant ϵ , no losses, and a charge q per cm. of axial length. Applying Gauss's theorem to a circular cylinder of radius x , we get

$$eS2\pi x = 4\pi q$$

Or

$$S = 2q / \epsilon x,$$

Where S is the electric stress at distance x from the axis. If E is the potential difference between the conductor and sheath

$$E = \int_r^{\frac{1}{2}} S dx = \frac{2q}{\epsilon} \log h \frac{D}{2r},$$

Section 3 – Underground Cables

So that the capacitance per cm. length is

$$C = \frac{q}{E} = \frac{\epsilon}{2 \log h(D/2r)} \text{ electrostatic units (cm.)}$$

$$= \frac{\epsilon}{2 \log D/d} \text{ cm. per cm. length}$$

Where d = the conductor diameter

Remembering that

$$1 \text{ cm.} = 10/9 \mu\mu F$$

We find that

$$C = \frac{0.0388 \epsilon}{(\log D/d)} \mu F \text{ per mile length}$$

Substituting for q in terms of E we see that the stress is

$$S = \frac{E}{x \log h(D/d)}$$

The stress is a maximum at the conductor where it is

$$S_{\max} = \frac{E}{r \log h(D/d)} = \frac{2E}{d \log h(D/d)}$$

For a given voltage E and internal sheath diameter D , the stress S_{\max} has a minimum value for variation of d when the differential coefficient of S_{\max} with respect to d is zero. This occurs when

$$\log h(D/d) = 1 * \text{ or } D = 2.718d$$

In low voltage cables the insulation is thin and d is greater than $D/2.718$. In high voltage cables d may be less, and then it is advantageous to increase the diameter of the conductor to this value. There are two ways of doing this without using excessive copper; by making the conductor hollow or by building it up with a lead sheath. The latter method has the advantage of eliminating at the same time the increase of stress due to stranding which may be as high as 25 per cent. If d varies from $D/2$ to $D/4$, the maximum stress varies by only 6 per cent, so that no great care need be taken to fix the ratio D/d provided it is not too great.

The stress at the lead sheath is

$$\frac{2E}{D \log h(D/d)}$$

So that the stress varies from a maximum at the conductor to a minimum (of d/D times the maximum) at the sheath. In some high voltage cables the

Section 3 – Underground Cables

dielectric is graded for strength by having a dense paper at the conductor and a less dense elsewhere. This does not appreciably alter the stress and voltage distribution unless the dielectric constants of the paper differ, but by using a paper of high electric strength near the conductor the total thickness of insulation can be reduced.

There are two main methods by which a more uniform distribution of stress may be achieved, by the introduction of intersheaths and by the use of layers of insulating material with different dielectric constants.

Effect of Intersheaths on Stress

Suppose that intersheaths of diameters d_1 and d_2 are inserted into the dielectric and maintained at potentials E_1 and E_2 . The stress between any two metallic cylinders varies inversely as the distance from the axis; this is found by applying Gauss's theorem. Thus between the conductor and the first intersheath the stress at a point distant x from the conductor is

$$S_1 = A_1 / x,$$

$$\text{For } \frac{\partial S_{\max}}{\partial d} = -\frac{2E}{[d \log h(D/d)]^2} * \frac{\partial [d \log h(D/d)]}{\partial d}$$

$$= -\frac{2E}{[d \log h(D/d)]^2} \left[\log h \frac{D}{d} + \frac{d}{D/d} \left(-\frac{D}{d^2} \right) \right]$$

$$= -\frac{2E}{[d \log h(D/d)]^2} \left[\log h \frac{D}{d} - 1 \right]$$

Where A_1 is a constant which is found by integrating S_1 from the conductor to the intersheath as follows

$$E - E_1 = \int_{\frac{1}{2}d}^{\frac{1}{2}d_1} S_1 dx = A_1 \log h \frac{d_1}{d}$$

So that
$$A_1 = (E - E_1) / \log h \frac{d_1}{d}$$

And
$$S_1 = \frac{E - E_1}{x \log h \frac{d_1}{d}}$$

The maximum stress is

$$S_{1\max} = \frac{E - E_1}{\frac{1}{2}d \log h \frac{d_1}{d}}$$

Similarly the maximum stress between the first and second intersheaths is

Section 3 – Underground Cables

$$S_{2\max} = \frac{E_1 - E_2}{\frac{1}{2} d_1 \log h(d_2 / d_1)}$$

Whilst the maximum stress between the second intersheath and the sheath is

$$S_{3\max} = \frac{E_2}{\frac{1}{2} d_2 \log h(D / d_2)}$$

By choice of E_1 and E_2 the maximum stresses can be made equal, and the stress distribution is like that shown by curve A of Fig. 87 instead of curve B which represents the stress without intersheaths.

It is possible to choose d_1 and d_2 so that the stress varies between the same maximum and minimum in the three layers, by taking

$$d_1 / d = d_2 / d_1 = D / d_2 = \alpha$$

Equating the maximum stresses we get

$$E_2 = \frac{E}{1 + 1/\alpha + 1/\alpha^2}, \quad E_1 = \frac{E(1 + 1/\alpha)}{1 + 1/\alpha + 1/\alpha^2}.$$

The maximum stress is then

$$\frac{E - E_1}{\frac{1}{2} d \log h \alpha} = \frac{E}{(1 + \alpha + \alpha^2) \frac{1}{2} d \log h \alpha} = \frac{E}{\frac{1}{3} (1 + \alpha + \alpha^2) \frac{1}{2} d \log h(D / d)},$$

Since $\log h(D / d) = \log h \alpha^3 = 3 \log h \alpha$.

Without the use of intersheaths the maximum stress is

$$\frac{E}{\frac{1}{2} d \log h(D / d)},$$

So that the maximum stress has been reduced in the ratio

$$1 : \frac{1}{3} (1 + \alpha + \alpha^2)$$

Example. A single core 66kV. Cable has a conductor diameter of 2cm, and a sheath of inside diameter 5.3 cm. Find the maximum stress. If two intersheaths are used, find the best positions, the maximum stress, and the voltages on the intersheaths.

Here $D / d = 5.3 / 2 = \alpha^3$, so that $\alpha = 1.384$

Thus $d_1 = \underline{2.77}$ cm. and $d_2 = \underline{3.84}$ cm. are the diameters of the intersheaths. The peak voltage on the conductor is $66 \times \sqrt{2} \div \sqrt{3} = 53.8$ kV., so that

Section 3 – Underground Cables

$$E_2 = \frac{53 \cdot 8}{1 + \frac{1}{1 \cdot 384} + \frac{1}{1 \cdot 910}} = \underline{\underline{23.9kV}}$$

And

$$E_1 = \left(1 + \frac{1}{1 \cdot 384}\right) 23 \cdot 9 = 41 \cdot 1kV$$

It should be remembered that in practice the system will be three phase at this voltage, and the r.m.s. neutral to voltage is $(1/\sqrt{3})$ times these values. The maximum stress without the intersheaths is

$$\frac{53 \cdot 8}{1 \times \log h 2 \cdot 65} = \underline{\underline{55.3kV}} \text{ per cm.},$$

And the maximum stress is $20 \cdot 8kV$ per cm. With the intersheaths the maximum stress is

$$\frac{55 \cdot 3}{\frac{1}{3}(1 + 1 \cdot 384 + 1 \cdot 91)} = \frac{55 \cdot 3}{1 \cdot 43} = \underline{\underline{38 \cdot 7kV}} \text{ per cm.},$$

While the minimum stress is $27.9kV$. per cm. Fig 87 shows the stress distribution in both cases. The maximum stress has been reduced by the ratio 1:1.43.

Example. Suppose that in the previous example the intersheaths are spaced at equal distances from each other, the conductor and the sheath. Find their voltages for the same maximum stresses in the layers, and find the maximum stress.

$$D = 5 \cdot 3cm., d = 2cm. \frac{1}{3}(D - d) = 1 \cdot 1cm., \text{ so that } d_1 = 3 \cdot 1 \text{ and } d_2 = 4 \cdot 2.$$

$$S_{1\max} = \frac{E - E_1}{\log h 1 \cdot 55} = 2 \cdot 28(E - E_1),$$

$$S_{2\max} = \frac{E - E_2}{1 \cdot 55 \log h(4 \cdot 2 / 3 \cdot 1)} = 2 \cdot 12(E_1 - E_2),$$

$$S_{3\max} = \frac{E_2}{2 \cdot 1 \log h(5 \cdot 3 / 4 \cdot 2)} = 2 \cdot 06 E_2.$$

Equating these we get $E_1 = \underline{\underline{45 \cdot 2kV}}$. and $E_2 = \underline{\underline{23 \cdot 0kV}}$. The maximum stress is $\underline{\underline{47 \cdot 5kV}}$. per cm. It is seen that the positions and voltages of the intersheaths are not very critical.

The use of intersheaths has not been general practice because of the complications involved. The sheaths must be supplied with the requisite potentials and must carry quite large charging currents. Jointing is made very difficult. Furthermore when there is a breakdown at one place, the stresses

Section 3 – Underground Cables

between the intersheaths containing healthy dielectric rise and breakdowns take place at other the cable, which is probably the greatest drawback.

Capacitance Grading

Suppose that the dielectric consists of two layers with a dividing diameter d_1 , the dielectric constants being ϵ_1 and ϵ_2 , as shown in Fig. 88. By Gauss's theorem the stress in the inner layer is

$$S_1 = 2q / \epsilon_1 \alpha$$

Whilst in the outer layer it is

$$S_2 = 2q / \epsilon_2 \alpha$$

Then

$$\begin{aligned} E &= \int_{\frac{1}{2}d}^{\frac{1}{2}d_1} S_1 dx + \int_{\frac{1}{2}d_1}^{\frac{1}{2}D} S_2 dx \\ &= 2q \left(\frac{1}{\epsilon_1} \log h \frac{d_1}{d} + \frac{1}{\epsilon_2} \log h \frac{D}{d_1} \right), \end{aligned}$$

so that

$$C = \frac{q}{E} = \frac{1}{\frac{2}{\epsilon_1} \log h \frac{d_1}{d} + \frac{2}{\epsilon_2} \log h \frac{D}{d_1}}.$$

The maximum value of S_1 is

$$S_{1\max} = \frac{4q}{\epsilon_1 d} = \frac{2E}{d \left(\log h \frac{d_1}{d} + \frac{\epsilon_1}{\epsilon_2} \log h \frac{D}{d_1} \right)},$$

and

$$S_{2\max} = \frac{4q}{\epsilon_2 d_1} = \frac{2E}{d_1 \left(\frac{\epsilon_2}{\epsilon_1} \log h \frac{d_1}{d} + \log h \frac{D}{d_1} \right)}.$$

Example. Suppose that the cable of the last two examples has an inner layer 1 cm. thick of rubber dielectric constant 4.5 and the rest impregnated paper of constant 3.6. Find the maximum stress in the rubber and in the paper.

$$d = 2, \quad d_1 = 4, \quad D = 5.3, \quad \epsilon_1 = 4.5, \quad \epsilon_2 = 3.6.$$

$$S_{1\max} = \frac{2 \times 66}{2(\log h 2 + 1.25 \log h 1.325)} = \underline{\underline{63 \text{ kV. Per cm.}}}$$

and

Section 3 – Underground Cables

$$S_{2\max} = \frac{2 \times 66}{4(0.8 \log h_2 + \log h_1 \cdot 325)} = \underline{\underline{39.5}} \text{ kV. Per cm.,}$$

Both to be multiplied by $\sqrt{2/3}$ of course.

Thus the maximum stress has been reduced from 67.8 to 63. The reduction is hardly worth while, and in practice the only grading used is for strength, i.e. a better quality paper is put near the conductor than near the sheath. This method of grading is quite practicable.

Power Factor of Single-core Cable

Suppose that the dielectric has a resistivity p which is independent of the stress and may be considered as constant throughout the cable. Then upon the application of an alternating voltage E of frequency $\omega/2\pi$ there will be an in phase current of E/R per cm. length, where R is given by equation (39).

The value of p from which G is to be calculated is generally very much less than that measured by direct current, and depends upon the frequency of the voltage. This is due to the fact that the losses with alternating currents are caused mainly by absorption phenomena.

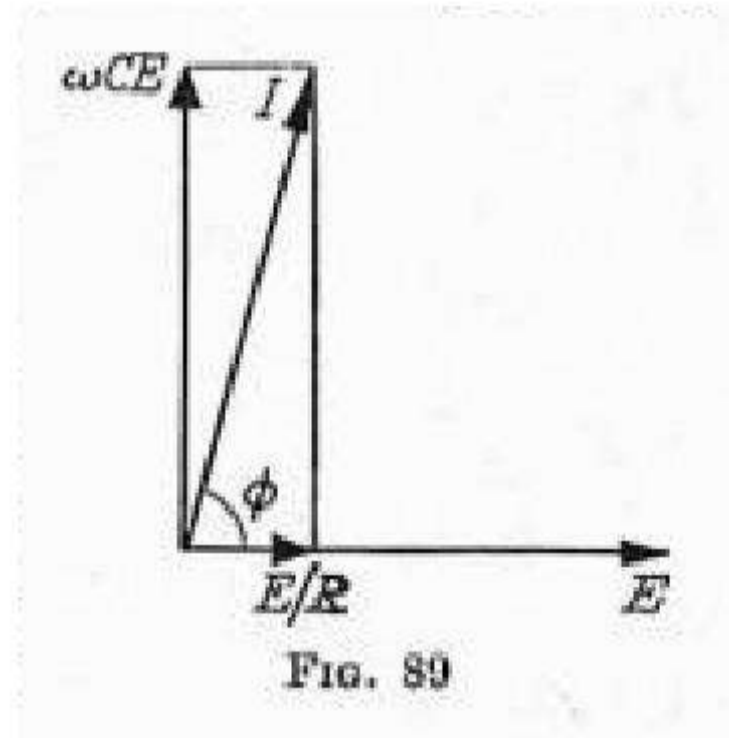

Also a charging current ωCE , where C is given by equation (40), which leads the voltage by a right angle. Fig. 89 shows the vector diagram for this case. The total current I is the vector sum of E/R and ωCE , and leads the voltage by an angle ϕ

where

$$\cot \phi = (E/R) \div \omega CE = 1/\omega CR.$$

It is usual to denote the reciprocal of R by G , which is the conductance of the cable per cm. length, so that

$$\cot \phi = G/\omega C$$

Section 3 – Underground Cables

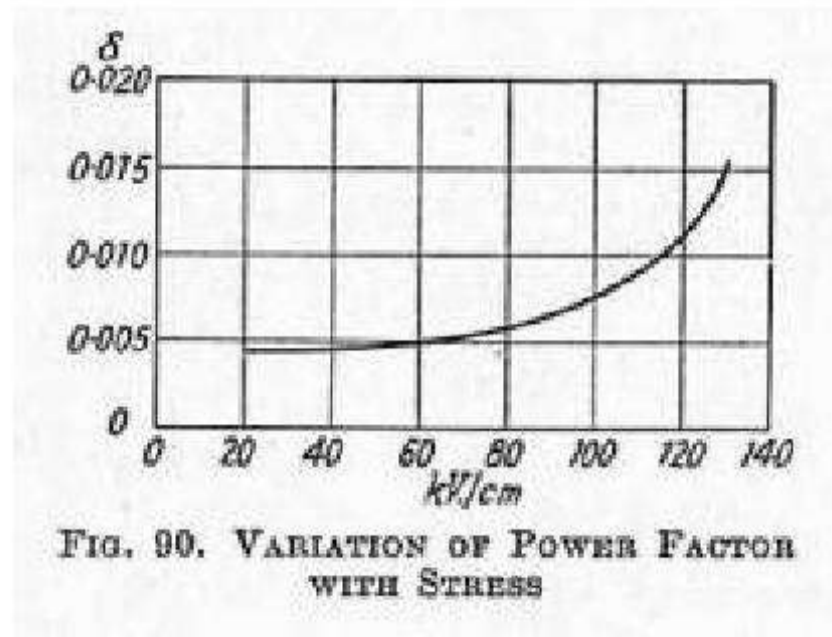

The power factor of the cable is given by

$$P.F. = \frac{\text{Watts}}{EI} = \frac{E^2 / R}{EI} = \frac{E / R}{I} = \cos \phi$$

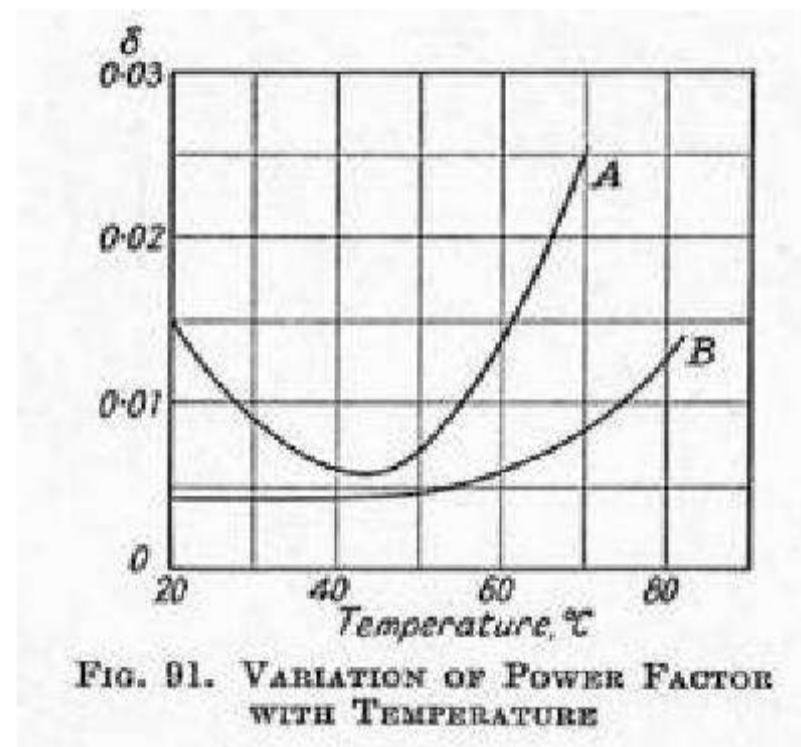

In well made cables ϕ is so near to 90° that $\cos \phi$ and $\cot \phi$ are small and very nearly equal to each other and to δ , where δ is $(\pi / 2) - \phi$ and is in radians.

We may thus put

$$P.F. = \delta = G / \omega C$$

The dielectric loss is

$$E^2 / R = E^2 G = \omega C E^2 \delta$$

The power factor of impregnated paper varies with the electrical stress and the temperature. Fig. 90 shows how the power factor rises with the stress. At a stress of 60kV per cm. the power factor begins to rise, and above this stress it is said that the dielectric is *ionising*. The term is unfortunate, as it implies that the gaseous voids are producing ions by collision and this may not be the case; for although ionization by collision will cause a rise of power factor, it is not true that a rise of power factor is necessarily caused by this phenomenon.

Section 3 – Underground Cables

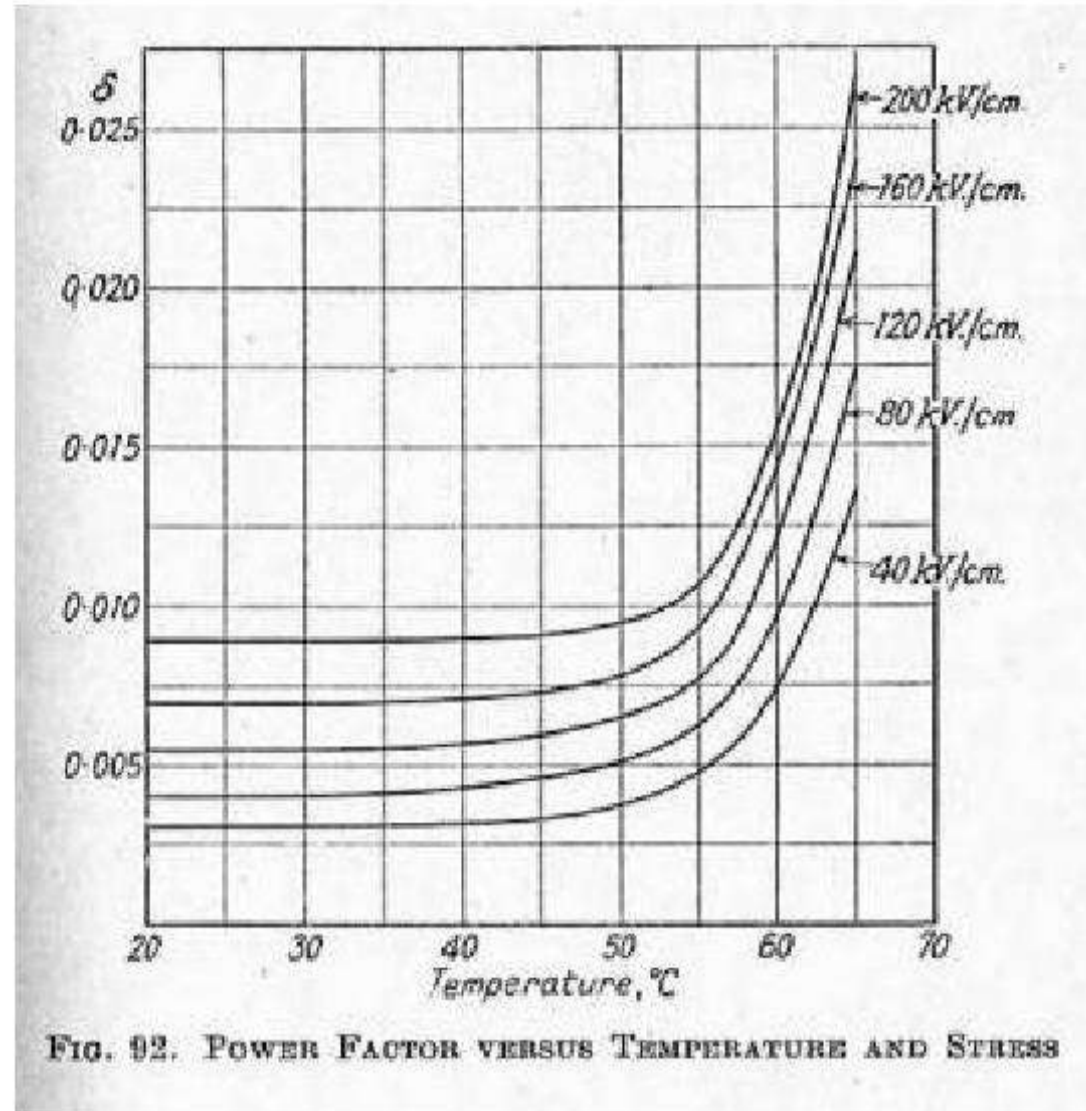

FIG. 92. POWER FACTOR VERSUS TEMPERATURE AND STRESS

The variation of power factor with temperature depends upon the paper and oil, and also upon the completeness of drying. It was once usual for the power factor temperature curve to have a minimum of about 40 $^{\circ}\text{C}$., as shown in Fig. 91, curve A; this is with the V-curve. With better drying and impregnation, the power factor temperature curve is nowadays more like that of curve B, which is flat up to 50 $^{\circ}\text{C}$. or higher. Fig.92 shows power factor temperature curves for various stresses on high grade impregnated paper insulation. The effect of resin is to make the power factor rise steeply at high temperatures, and the tendency in high voltage cables is to omit the resin.

The existence of the V-curve can be explained by the presence of moisture or inhomogeneities in the dielectric.

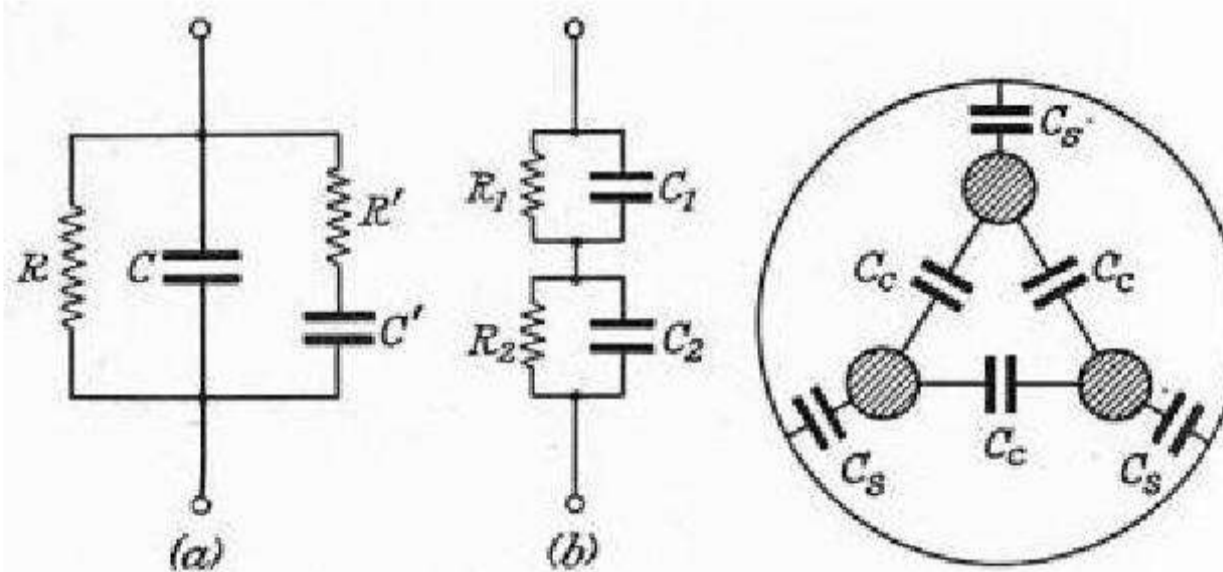
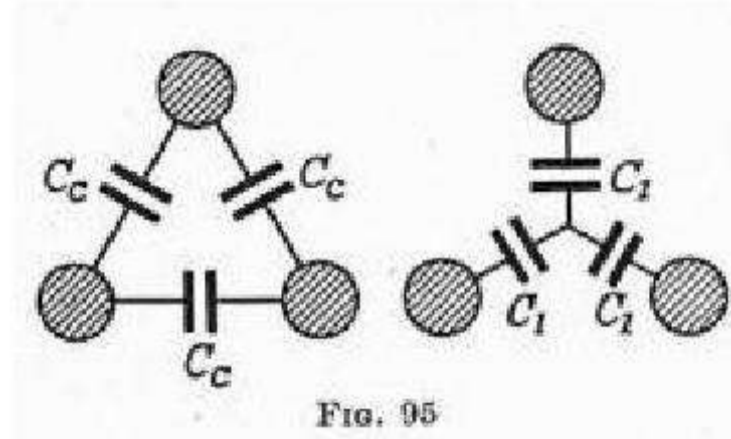

FIG. 93
REPRESENTATIONS OF IMPERFECT DIELECTRIC

FIG. 94
CAPACITANCES IN BELTED-TYPE, THREE-CORE CABLE

Section 3 – Underground Cables

Thus if a dielectric has a conducting path represented by R in Fig. 93 (a), a capacitance path C , and a mixed path $R'C'$, it can be shown that it is represented by the arrangement of Fig. 93 (b), where R_1 and R_2 are of the same character as R and R' C_1 and C_2 are like C and C' , i.e. they have the same temperature variations. The second arrangement is the well known Maxwell model for dielectric absorption and will exhibit the V-curve.



Capacitance of Three-core, Belted-type Cable

The three-core S.L. and H types are equivalent, as far as capacitance and stress are concerned, to three separate single core cables. In the belted type cable conductors have capacitance C_c to each other and C_s to the sheath, so that the system of capacitances can be replaced by a Y of capacitances C_1 as shown in Fig. 95. For this to be so, the capacitances between any two conductors in these arrangements must be the same, so that $C_c + \frac{1}{2}C_c = \frac{1}{2}C_1$, or $C_1 = 3C_c$. The centre point of the Y is the neutral, and as the sheath is at zero potential, we can consider that these capacitances act to the sheath, so that the neutral capacitance of each conductor is

$$C_c = C_1 + 3C_c$$

It is very difficult to calculate the capacitance to neutral from the geometry of the cable. The following empirical formula gives the capacitance with sufficient accuracy for design work.

$$C_c = \frac{0.048\epsilon}{\log \left[1 + \frac{T+t}{d} \left\{ 3.84 - 1.70 \frac{t}{T} + 0.52 \frac{t^2}{T^2} \right\} \right]} \mu F \cdot \text{Per mile}$$

Where d = conductor diameter,
 T = thickness of conductor insulation,
 And t = thickness of belt insulation.

Section 3 – Underground Cables

The capacitances C_c and C_s are found best by measurement, and the neutral capacitance calculated in the following way.

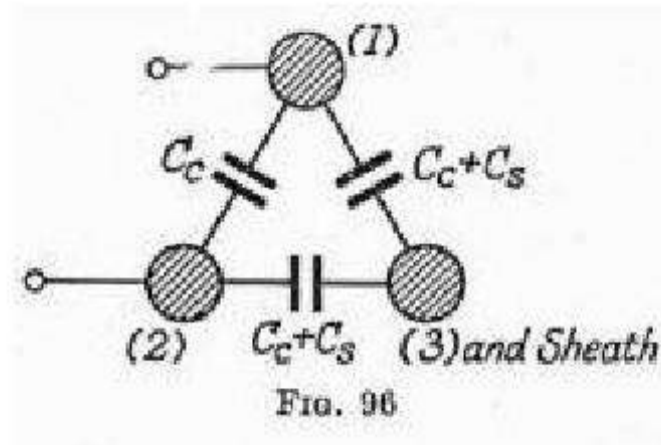

Let conductors 2 and 3 be connected to the sheath and the capacitance be measured between conductor 1 and the rest. The value is

$$C_c = C_s + 2C_c$$

Next let all the conductors be commoned and the capacitance, C_b , be measured between them and the sheath.

$$C_b = 3C_2$$

Then

$$C_2 = \frac{1}{3} C_b$$

And

$$C_c = \frac{1}{2} C_a - \frac{1}{6} C_b$$

The capacitance to neutral is thus

$$\begin{aligned} C_c &= \frac{1}{3} C_b + \frac{3}{2} C_a - \frac{1}{2} C_b \\ &= \frac{3}{2} C_a - \frac{1}{6} C_b \end{aligned}$$

If C_b is not known it may be taken as $1.8C_a$, so that

$$C_c = 1.5C_a - 0.3C_a = 1.2C_a$$

Example. The capacitance of a length of three phase cable is measured and is the capacitance between two cores (the third being connected to the lead sheath) is found to be $3\mu F$. Find the charging current per core if the cable is connected to an 11kV., 50 eye., three phase alternator. Prove each step.

The capacitances are shown in Fig.96, so that the measured capacitance is

$$C_c + \frac{1}{2}(C_c + C_s) = \frac{1}{2}(3C_c + C_s),$$

Which is half the capacitance to neutral. The neutral capacitance is therefore $6\mu F$. And the charging current per core is

$$\begin{aligned} \omega C_0 E &= 2\pi \times 50 \times 6 \times 10^{-6} \times (11000 \div \sqrt{3}) \\ &= \underline{\underline{11.97A}} \end{aligned}$$

Section 3 – Underground Cables

Stress in a Three Core Cable

Even when the dielectric is homogeneous the problem cannot be solved with accuracy, and as the dielectric is never homogeneous, because of the fillers, there is no point in quoting or working from formulae. There is a rotating electric field in the 3 core cable, and the maximum stress occurs at the point nearest the centre on the conductor at maximum voltage.

It is, however, almost certain that this stress is not the determining factor in the life of the cable, for it is normal to the paper and is easily borne than the lower stresses which occur in and near the fillers and are tangential to the papers. It was found in the 3 core 33 kV. Cables that deterioration began in the fillers and wormings, and not at the point of the maximum stress on the conductors; the H-type cable was designed to avoid these tangential stresses and solved at once the problem of the 3 core 33 kV. cable.

Inductance of Cables

The methods of calculating the inductance of overhead lines may be applied to underground cables, but the results will be in error because of the skin and proximity effects and the effect of the sheath. In low voltage cables the conductor spacings are small compared with the conductor diameters, so that the effects will not be negligible. It is then best to measure the inductances, if they are required, as calculation will be very laborious and inaccurate.

In high voltage cables the skin and proximity effects are negligible because of the increased thickness of insulation. In such cables the separate cores are often sheathed, or surrounded by metallized (H) paper which is connected to sheath. The sheaths have mutuals inductance to the conductors and influence considerably the resistance and inductance of the cores to neutral; the effects of the sheath will now be considered.

Sheath Effects

The currents induced in the sheaths are two kinds: *sheath eddies*, whose paths lie in the sheath of a single cable and which flow even when the sheaths are isolated from each other, and *sheath circuit eddies*, whose paths lie in the sheaths of separate cables and flow only when the sheaths are bonded.

Fig. 97 shows the formation of sheath eddies in the case of two single core cables with separate and insulated lead sheaths. The conductor currents I produce a flux downwards through the sheath section ABCD. When I and the flux increase there is a sheath eddy round ABCD from A to B to C to D to A. The sheath eddy at A' is outwards to B', along the outside of the sheath into the paper and back again inside the sheath to A'. The loss due to sheath eddies is a maximum when the cores are as close as possible to one another, but in practical cases it is never more than a few per cent of the copper losses and can be neglected. A much more important effect is the voltage induced in the sheaths by the currents I .

Section 3 – Underground Cables

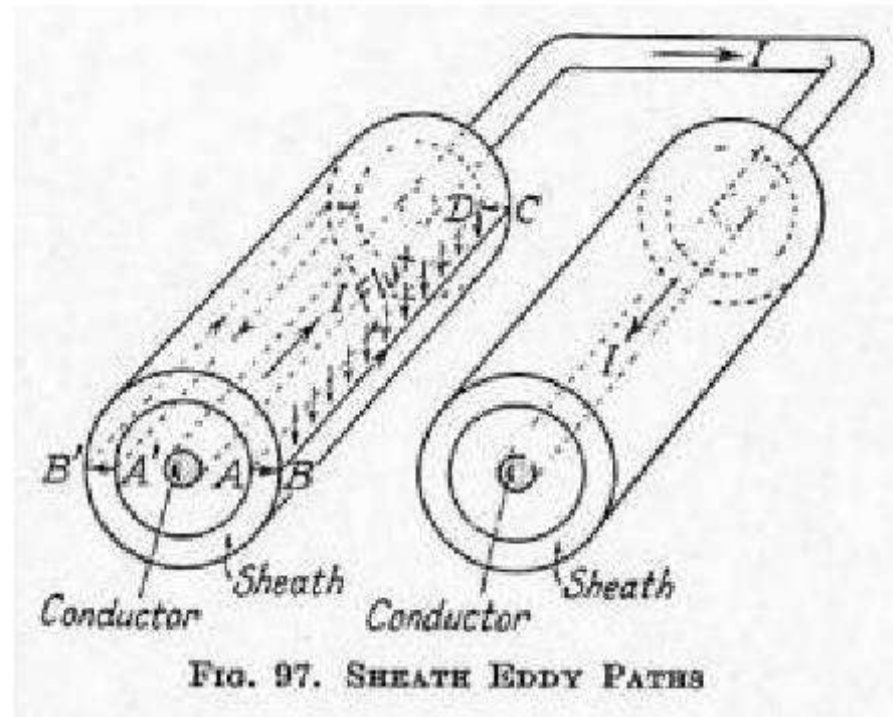

Suppose that the sheaths are replaced by thin cylinders of radius $\frac{1}{2}D$ and we consider a circuit ABCD shown in Fig.98 The flux through ABCD is seen to be

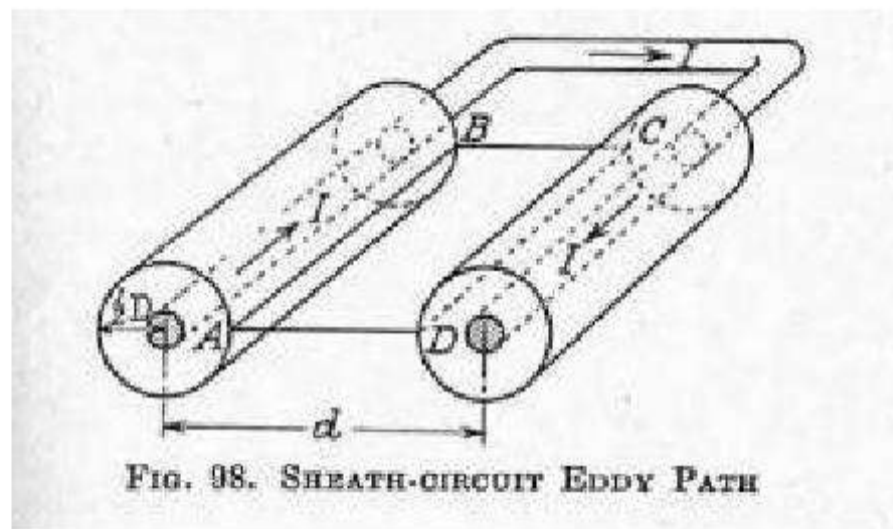

$$0.41 \log h(D \frac{1}{2} D) \text{ per cm. length,}$$

where d is conductor spacing. The induced e.m.f. is thus

$$4\omega I \log h(d / \frac{1}{2} D) \times 10^{-9} \text{ volts per cm. length}$$

This is e.m.f. along both sheaths and we may consider that each sheath has an induced e.m.f. of half this, viz.

$$E_{2\lambda} = 2\omega I \log h(d \frac{1}{2} D) \times 10^{-9} \text{ volts per cm. length.}$$

$$= IX_m = I\omega M, \tag{49}$$

Where M is the mutual inductance between the core and sheath and is

$$2 \log h(d \frac{1}{2} D) \text{ e.m. units per cm.}$$

Or $M = 0.741 \log(d \frac{1}{2} D) \text{ mH. Per mile.} \tag{50}$

By equation (18a) in chapter IV. It is clear from the work in chapter IV and the equation (24) given there that formulae (49) and (50) just given hold for a three phase symmetrical system with spacing d .

Section 3 – Underground Cables

Example. Find the induced sheath voltage per mile of a symmetrical three phase system with conductor spacing 15 cm and sheath diameters 5.5 cm. The current is 250 A.

$$M = 0.741 \log(15 / 2.75) = 0.545 \text{ mH. Per mile.}$$

$$\begin{aligned} E_{2\lambda} &= 250 \times 2\pi \times 50 \times 0.545 \times 10^{-3} \\ &= \underline{\underline{42.8 \text{ V. per mile.}}} \end{aligned}$$

If the sheaths are bonded at one end, the voltage between them at the other is

$$\sqrt{3} \times 42.8 = \underline{\underline{74.3 \text{ V. per mile}}}$$

Currents in Bonded Sheaths

It is seen from the preceding example that large voltages are induced in the sheaths if they are open circuited, and it is very probable that arcing will occur between them. It is therefore standard practice to bond the sheaths at both ends so as to avoid the high voltages. The impedance of the sheath current path is due to the sheath resistance R_s and the sheath self inductance, which is equal to M . Thus if the sheaths are bonded the sheath current is

$$I_{sh} = \frac{E_{sh}}{\sqrt{(R_s^2 + X_m^2)}} = I \frac{X_m}{\sqrt{(R_s^2 + X_m^2)}} \quad 51$$

The magnitude of the sheath current is independent of the distance between the bonds, for X_m and R_s are both proportional to the length. The sheath losses per phase are

$$R_s I_{sh}^2 = I^2 X_m^2 R_s / (R_s^2 + X_m^2) \quad 52$$

So that the effective resistance per phase is the conductor resistance plus

$$X_m^2 R_s / (R_s^2 + X_m^2) \quad 53$$

The ratio of sheath losses to copper losses is

$$\frac{I^2 X_m^2 R_s}{R_s^2 + X_m^2} \div I^2 R = \frac{X_m^2 R}{R(R_s^2 + X_m^2)}$$

Where R is the resistance of the conductor. With large conductors and close spacing this ratio is approximately equal to

$$X_m^2 R_s / R R_s^2 = X_m^2 / R R_2,$$

As R_s^2 is large compared with X_m^2 . If conductor is made larger, R and R_2 diminish whilst X_m remains fairly constant, so that the ratio increases rapidly. Thus for 66kV. cables at a spacing of 6 in., the sheath losses exceed the conductor losses for conductor sections above 0.85 in^2

Section 3 – Underground Cables

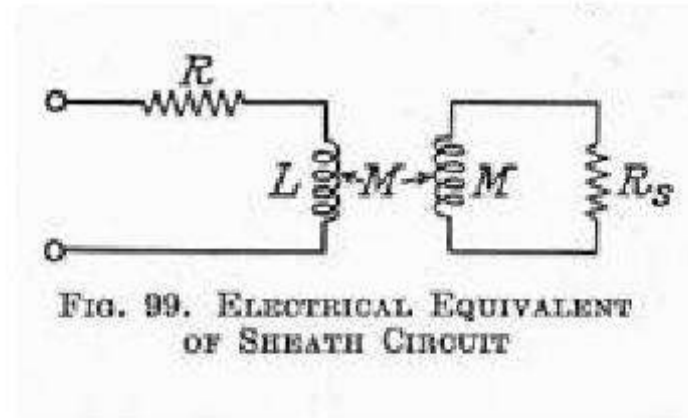

The effect of the sheath on the inductance of the cable may be found in the following way. The conductor has resistance R and self inductance L , where

$$L = 2 \log h(d/r)$$

from the work in Chapter IV. This inductance is coupled to the sheath circuit by a mutual inductance M , where

$$M = 2 \log h(d/\frac{1}{2}D).$$

The sheath circuit itself has a resistance R_2 and self inductance M , so that the cable impedance is represented by the network of Fig.99. By the well known theorem of the equivalent network of the equivalent network of the transformer (see page 471) the arrangement can be replaced by that shown in Fig.100.

$$\begin{aligned} L - M &= 2 \log h(d/r) - \log h(d/\frac{1}{2}D) \\ &= 2 \log h(\frac{1}{2}D/r) = L_c \end{aligned}$$

Which is the leakage inductance of the core to the sheath. The total impedance of the conductor is thus

$$\begin{aligned} R &= j\omega L_c + \frac{R_s \cdot j\omega M}{R_s + j\omega M} \\ &= R + j\omega L_c + \frac{R_s \cdot j\omega M (R_s - j\omega M)}{R_s^2 + \omega^2 M^2} \\ &= \left[R + \frac{R_s \omega^2 M^2}{R_s^2 + \omega^2 M^2} \right] + j\omega \left[L_c + \frac{MR_s^2}{R_s^2 + \omega^2 M^2} \right] \\ &= \left[R + \frac{R_s X_m^2}{R_s^2 + X_m^2} \right] + j\omega \left[L_c + \frac{MR_s^2}{R_s^2 + X_m^2} \right] \end{aligned}$$

The resistance is thus

$$= R + R_s X_m^2 / (R_s^2 + X_m^2)$$

Which we have already found in equation (53), whilst the inductance is

$$L_c + MR_s^2 / (R_s^2 + X_m^2) = L - M + MR_s^2 / (R_s^2 + X_m^2)$$

Section 3 – Underground Cables

$$= L - MX_m^2 / (R_s^2 + X_m^2)$$

The decrease in inductance due to the sheath is thus

$$MX_m^2 / (R_s^2 + X_m^2)$$

The resistivity of lead is $23 \cdot 2 \times 10^{-6}$ ohms per cm. cube at $30^\circ C$.

Given the thickness of the sheath and its diameter, R_s can be calculated and thence the resistance and inductance of the cable.

In order to avoid large sheath currents, which lower the current-carrying capacity of cables, sheaths are sometimes cross-bonded.

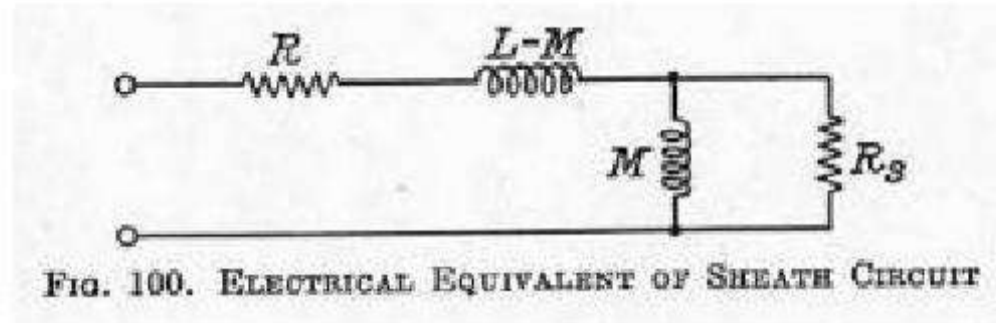

FIG. 100. ELECTRICAL EQUIVALENT OF SHEATH CIRCUIT

The sheath conductor 1 is connected to that of conductor 2 and then to that of conductor 3 at equidistant points, and the induced sheath voltage is

$$I_1 wM + I_2 wM + I_3 wM = (I_1 + I_2 + I_3) wM = 0.$$

(See Fig. 82.)

There will be no sheath current and yet the sheath voltage will never be greater than IwM at any point. A combination of cross-bonding except at every third joint, which is solidly bonded and of simple reactances reduces sheath losses and voltages and also prevents the generation of third harmonic currents.

Example. Find the resistance, inductance and capacitance per mile of a 3 core belted type cable, in which the conductors are circular $37/0 \cdot 093$, conductor insulation is $0 \cdot 17$ in., and the dielectric constant is 3.6.

From tables it is found that the resistance is $0 \cdot 099333\Omega$ per 1000 yd. at $60^\circ F$. The resistance per mile at $55^\circ C$., which is taken as a normal working temperature, being $40^\circ C$. above the average temperature of $40^\circ C$. above the average temperature of $15^\circ C$., is

$$R = 0 \cdot 09933 \times 1 \cdot 760 \times [1 + 0 \cdot 004 \times 39 \cdot 5]$$

$$\underline{0 \cdot 202\Omega.},$$

Stranding having been allowed for in the tables.

The formula for overhead lines is used in this case for inductance, and no great accuracy can be claimed.

$$L = 0 \cdot 085 + 0 \cdot 741 \log(d/r) \text{ mH. Per mile.}$$

Here $r = 0 \cdot 325$ in. and $d = 2(0 \cdot 325 + 0 \cdot 20) = 1 \cdot 05$ in., so that

Section 3 – Underground Cables

$$L = 0.085 + 0.741 \log(1.05/0.325) = \underline{\underline{0.462}} \text{ mH. Per mile.}$$

The capacitance is given by equation (46)

$$C = \frac{0.048\epsilon}{\log\left[1 + \frac{T+t}{d} \left\{3.84 - 1.70\frac{t}{T} + 0.52\frac{t^2}{T^2}\right\}\right]} \mu F. \text{ Per mile}$$

Where d here is the conductor diameter, not the spacing.

$$C = \frac{0.048 \times 3.6\epsilon}{\log\left[1 + \frac{0.37}{0.65} \left\{3.84 - 1.70 \times 0.85 + 0.52 \times 0.85^2\right\}\right]}$$

$$= \frac{0.048 \times 3.6}{\log 2.57} = \underline{\underline{0.420}} \quad \mu F. \text{ per mile}$$

Example. Find the resistance, inductance and capacitance of a three phase symmetrical arrangement of 66kV. single core cables, 61/0.103 (nominal 0.5 in.^2), insulation thickness 0.65in., sheath thickness 0.15in., serving thickness 0.15in., serving thickness 0.15in., dielectric constant 3.6; the cables are laid touching one another and the sheaths are bonded.

From the tables the resistance is 0.04913Ω . Per 1000 yd at 60° F. , so that at 55° C , the resistance per mile per phase is

$$R = 0.04913 \times 1.760 \times [1 + 0.004 \times 39.5]$$

$$0.1005\Omega$$

$$C = \frac{0.0388 \epsilon}{\log(D/d)} \mu F \text{ per mile.}$$

Here $d = 9 \times 0.103 = 0.103 = 0.927 \text{ in.},$

And $D = 0.927 + 2 \times 0.65 = 2.227.$

$$C = \frac{0.0388 \times 3.6}{\log 2.40} = \underline{\underline{0.378}} \mu F \text{ per mile.}$$

We will assume a sheath temperature of 30° C .

$$R_s = \frac{23.2 \times 10^{-6} \times 5280 \times 12 \times 2.54}{\pi [1.263^2 - 1.113^2]} \times 2.54^2$$

$$0.516\Omega \text{ per mile}$$

The spacing is $2.227 + 4 \times 0.15 = 2.827 \text{ in.},$ so that

$$M = 0.741 \log(2.827 / 1.115)$$

$$= 0.297 \text{ mH. per mile}$$

Section 3 – Underground Cables

$$X_m = 2\pi \times 50 \times 0.297 \times 10^{-3} = 0.0931 \Omega \text{ per mile}$$

The effective resistance per mile is therefore

$$0.1005 + \frac{0.516 \times 0.0931^2}{0.516^2 + 0.0931^2}$$

$$= 0.1005 + 0.0167 = 0.1172 \text{ ohms}$$

The sheath loss is $0.0167 \div 0.1005 = 16.6$ per cent of the conductor loss.

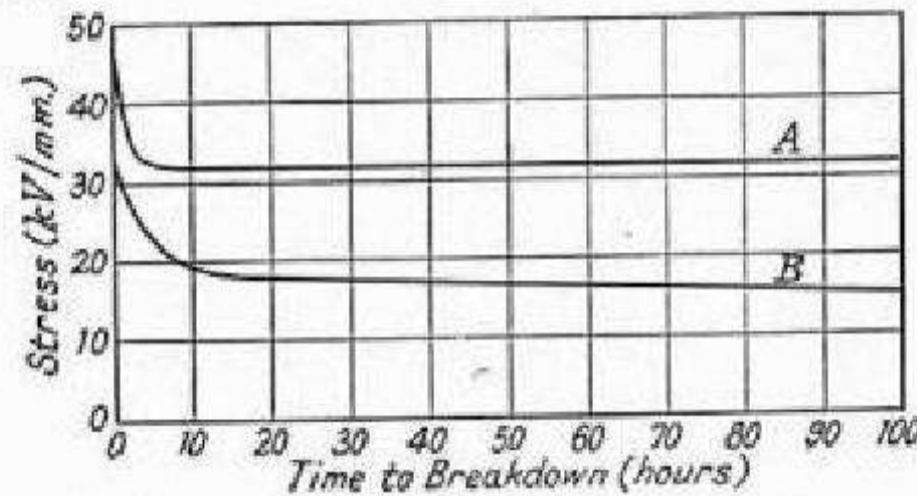

FIG. 101. V.T.B. CURVES OF WELL AND BADLY IMPREGNATED PAPER

The inductance is

$$L_C + MR_s^2 / (R_s^2 + X_m^2) = L - MX_m^2 / (R_s^2 + X_m^2)$$

$$= L - 0.031M$$

$$\cong L = 0.741 \log 2.827 / 0.583 \text{ mH. per mile}$$

Actually the inductance is slightly lower by 0.0092 mH. due to the sheath bonding, so that L is 0.574 mH. per mile.

Breakdown Voltage and Mechanism of Breakdown

The voltage required to break down a certain insulation depends upon many factors such as time of application, shape of electrodes, temperature, pressure, the presence of moisture or gaseous spaces. The dependence of voltage on time is very important, and tests are made to determine the curve relating the voltage required to break down a certain insulation depends upon many factors such as time of application, shape of electrodes, temperature, pressure, the presence of moisture or gaseous spaces. The dependence of the voltage on time is very important and tests are made to determine the curve relating the voltage and time of application; such a curve is called a V.T.B. curve, i.e. voltage-time-breakdown curve. Curve A, shows the V.T.B. curve of 1mm. thickness of very well impregnated paper. The short time breakdown voltage is about 45 kV. (stress 45 kV. per m.), but the breakdown voltage reach a steady value of 32kV. in about 5 hours. If a voltage of 31.5kV. is applied the insulation never break down. It is of the greatest advantage if asymptotic value (.e. final value) is

Section 3 – Underground Cables

reached in a short time, for then decisive tests may be short; presumably also the cable is stable and likely to give long service. Curve *B* shows the V.T.B. curve of the badly impregnated paper which contains air spaces. The short time breakdown voltage is not much less than for the good dielectric, but the asymptotic value is much lower and is not reached even in 100 hours. With slow deterioration of this kind it is difficult to say what voltage the dielectric can maintain indefinitely.

Moisture has the same effect as gaseous voids on V.T.B. curve. A carefully impregnated cable will initially contain no voids and so it will have V.T.B. curve like a curve *A*. When however, this cable is subjected to fluctuating loads, the heating causes the oil to expand and sheath is stretched; when the cable cools, the sheath does not recover and small voids are formed by cavitation. After a number of fluctuations the voids may be such that the V.T.B. curve is like curve *B*, and eventual failure will occur if the applied voltage is greater than the new asymptotic value. In order to ascertain whether the cable V.T.B. curve is stable, the cable is subjected to the working voltage or a higher voltage whilst the cable is alternately heated and allowed to cool. Such a test is called a *stability test* and is applied to all types of high voltage cables.

The formation of voids is accompanied by ionization by collision and a rise of the power factor of the cable.

The voids are eliminated in the oil filled and pressure cables, whilst the gas cable prevents ionization by the application of hydrostatic pressure. All these cables have good V.T.B. curves.

There are two ways in which breakdown of cables usually occurs.

One way is by a progressive coring and tracking, which always starts from the conductor or sheath, and ultimately bridges the electrodes. Another way is by thermal instability; this occurs when the power factor increases so rapidly with rise of temperature, that a small rise of temperature increases the dielectric losses by a greater amount than can be conducted away. This method will be considered later in detail. A marked difference between the methods of breakdown is that coring, once it commences, will continue until the cable breaks down, although the time may be considerable for the complete action. In thermal instability, however, no damage is done until just before breakdown, so that if the load is released before breakdown the cable will not have suffered any permanent change. A very common occurrence is for coring to start and then introduce thermal instability at the centre of coring.

Thermal Characteristics of Cables

Maximum current capacity. There are several reasons why cables should not be run too hot; differential expansion may create voids with resulting ionization; the expansion of the oil may burst the sheath; the oil may lose its viscosity and drain away from higher levels; thermal instability may arise due to the rapid increase of dielectric losses with temperature. The last phenomenon is not likely to occur

Section 3 – Underground Cables

in cables up to 33 kV., but it is being reached in cables above kV. The calculation is difficult and will not be given.

In order not to incur the other harmful effects, a maximum conductor temperature of 65° C has been adopted for cables impregnated with viscous oils in this country. The maximum current that a cable can carry with a conductor temperature of 65° C is found in the following way.

Assume that the dielectric and sheath losses are negligible compared with the conductor losses, which are given by nRI^2 , where R is the conductor resistance at 65° C., and n the number of phases. Let S be the thermal resistance of the cable, i.e. between the combined conductors and sheath, and G the thermal resistance from sheath to earth surface. The heat has to pass through the two thermal paths in series, so that the temperature difference between the conductors and ground is

$$nRI^2(S + G) = 65 - 0 \quad (56)$$

Where 0 is the ambient ground temperature. We may take $0 = 18$, so that

$$nRI^2(S + G) = 43$$

Giving
$$I = \sqrt{[43 / nR(S + G)]} \quad (57)$$

If the dielectric and sheath losses are not negligible, we can replace equation (56) by

$$65 - 0 = nRI^2(S + G) + W(S + G) + R_a I^2 G,$$

Where W is the dielectric losses and is conservatively taken as occurring all at the conductor, and R_a is an equivalent resistance due to sheath losses. Then the current capacity is

$$I = \sqrt{\left[\frac{65 - 0 - W(S + G)}{nR(S + G) + R_a G} \right]} \quad (58)$$

Thermal Resistance

The unit is the thermal ohm and is that thermal resistance which requires a temperature difference of 1° C, to produce a heat flow of one watt (i.e. one joule per second). If the thermal resistivity of a cable dielectric is K , the thermal resistance of a single core cable is

$$S_1 = (K / 2\pi) \log h(D / d) \text{ thermal ohms per cm. length of cable} \quad (59)$$

K is taken as 750 for cables up to and including 2200 volts, and 550 for cables above 2200 volts.

The thermal resistance of a 3 core belted type cable is given by the empirical formula.

$$S_1 = \frac{K}{6n} \left(0.85 + \frac{0.2t}{T} \right) \log h \left[1 + \frac{2(T+t)}{d} \left(4.15 - \frac{1.1t}{T} \right) \right] \quad (60)$$

Section 3 – Underground Cables

The thermal resistance of the ground is

$$G = (g^1 / 2\pi) \log h(2h / R_2) \quad (61)$$

Where g^1 is the resistivity, h the depth of cable below ground and R_2 the overall radius of the cable. It is found that the thermal resistivity g as measured in the laboratory is too great for use in the above formula by about 50 per cent, so that $g^1 = \frac{2}{3}g$ and the thermal resistance is given by

$$G = (\frac{2}{3}g / 2\pi) \log h(2h / R_2) = (g / 3\pi) \log h(2h / R_2) \quad (62)$$

In practice g varies from 120 to 800 or 1000 depending on the soil and its moistness.

Example. Find the maximum current that a 3 core, 11kV. 0.25 in.^2 cable can carry; $t = 0.06 \text{ in}$ $T = 0.15 \text{ in.}$, $K = 550$, buried 3 ft. deep, $g = 180$, ambient temperature 15° C .

$$S_1 = \frac{550}{6\pi} (0.85 + \frac{0.012}{0.15}) \log h [1 + \frac{0.42}{0.65} (4.15 - \frac{0.066}{0.15})]$$

33.2 thermal ohms per cm.

The lead sheath has a very small thermal resistance, but there is a serving of thickness 0.31 in. of $K = 300$. This has a thermal resistance of

$$S_2 = (300 / 2\pi) \log h(1.54 / 1.22) = 11 \text{ thermal ohms,}$$

As the external radius of lead sheath is 1.22 in. , and that of the serving of is 1.54 in. The ground resistance is

$$G = \frac{180}{3\pi} \log h \frac{2 \times 36}{1.54} = 73.4 \text{ thermal ohms.}$$

$$\therefore S + G = S_1 + S_2 + G = 117.6$$

From tables, allowing for coring and stranding and temperature rise, $R = 1.33 \times 10^{-6} \Omega$. Per cm.

$$\therefore I = \sqrt{\frac{65-15}{3 \times 1.33 \times 10^{-6} \times 117.6}}$$

$$= \underline{\underline{326 \text{ A.}}}$$

3.6 Describe techniques used to install cable and associate equipments

Ducts

To expand future installation

Iron / reinforced concrete/ steel pipe/ wood / fibre/ plastic

Section 3 – Underground Cables

Fig 6.4

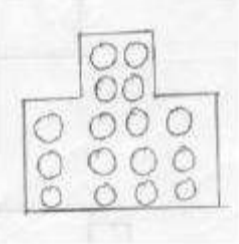
Duct type	Cost of construction	Ability to radiate heat	Cost of support
	Expensive	Best	Best
	Moderate	Very good	Very good
	Moderate	Very good	Good
	Cheapest	Very poor	Very poor

Service boxes

Secondary mains are installed in ducts buried at shallower depths than those carrying primary conductor. Precast reinforce concrete is used.

Section 3 – Underground Cables

Cable manhole

- Rectangular for straight line conduit construction.
- Square for accommodating from 4 directions.

Fig 6.5

Transformer Manholes

Transformer manholes are designed to contain transformers and other equipments for radial or network system.

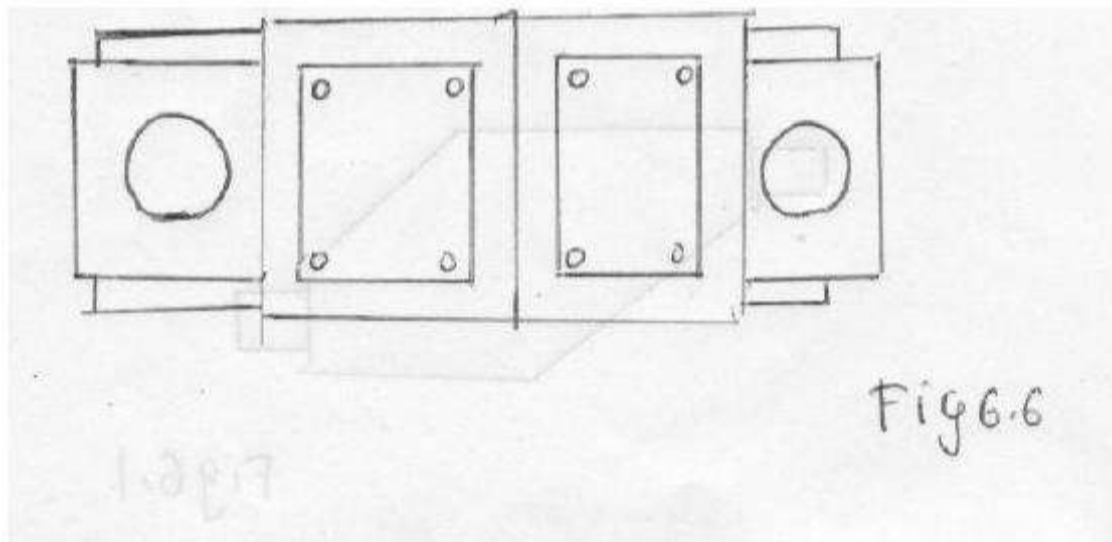

Design loading on manhole

$$\text{Concentrated load} = \frac{\text{Wheel load (1 + \% Impact / 100)}}{\text{Wheel Area}}$$

Problem

Wheel load 9576 Kg , imposed 50% for heavily travelled street under which truck traffic may be concrete. Wheel area is 15.5 cm x 30.5 cm

Calculate concentrate load on manhole cover.

$$\text{Concentrated load} = \frac{\text{Wheel load (1 + \% Impact / 100)}}{\text{Wheel Area}}$$

Section 3 – Underground Cables

Wheel Area

$$\begin{aligned} &= \frac{9576 (1 + 50 / 100)}{15.5 \times 30.5 \times 10^{-4}} \\ &= \frac{14364 \times 10^4}{472.75} \\ &= 303839 \text{ Kg / m}^2 \end{aligned}$$

Roofs

Manhole roofs are designed as a series of structural steel beams or rail or reinforced concrete with extra reinforcement or structural steel to support manhole frames

Wall

Manhole wall designs are based on the horizontal component of the effect of both line and dead loads acting on the walls.

Floors

In the design of manhole, floors , the load bearing power of the soil and the height of the water tube play an important part. The soil must support the weight of the manhole structure its contents and any imposed surface level loads.

Frame / covers

- Made of cast iron/ malleable iron/ steel
- Are designed to withstand the loadings of traffic
- May be made of reinforce concrete

Ventilation

- Principal heat source is power loss in windings
- Tube ventilation is natural ventilation
- Large conductors are put in separate ducts

Section 3 – Underground Cables

- XLPLE/ Lead/ Plastic insulation are used.

Cross section of joint

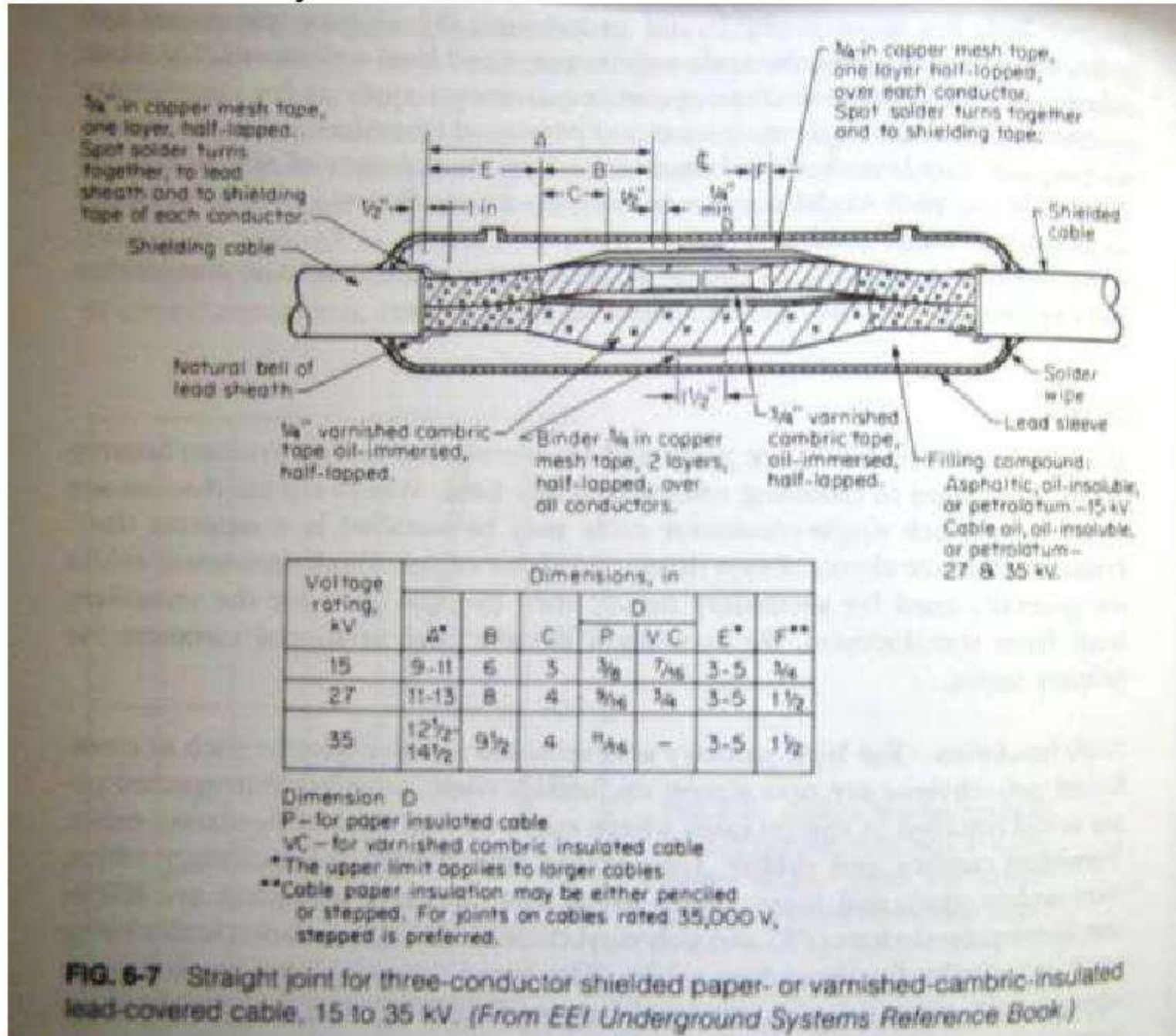

Underground Equipments

Transformers, oil filled cutouts and oil switches for use underground are hermetically sealed so as to be water proofed

Such submersible equipment is usually of welded construction. Wiping sleeves are welded or brazed directly to the tank or terminal chamber to which cable sheaths are attached.

Barriers in the conductors prevent the equipment oil from being siphoned into the cables.

Section 3 – Underground Cables

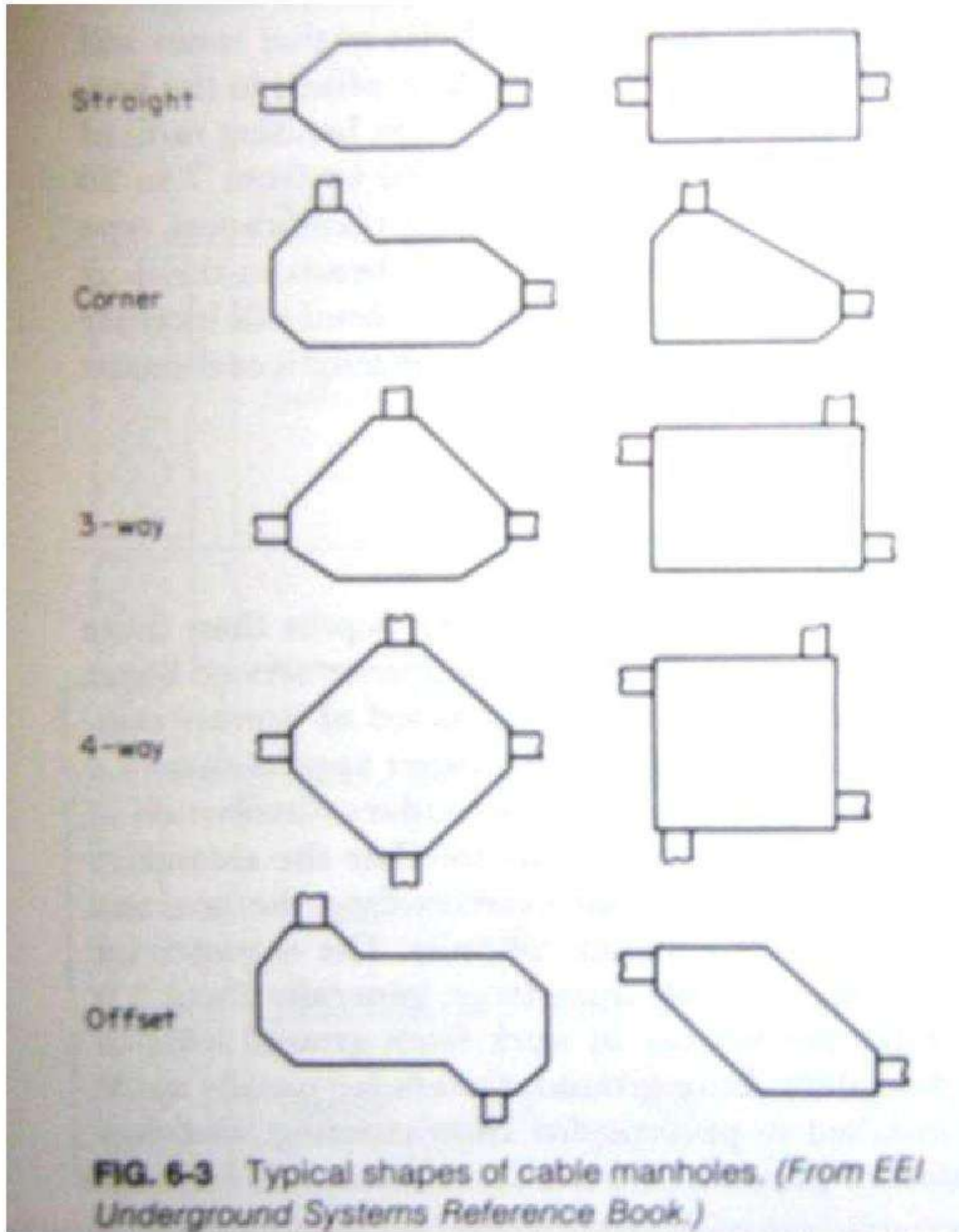

Section 3 – Underground Cables

Transformer Manholes

Transformer manholes are designed to contain transformers and other equipment required for radial or network systems. Their dimensions depend on the location and the equipment they are to contain. Standard transformer manholes

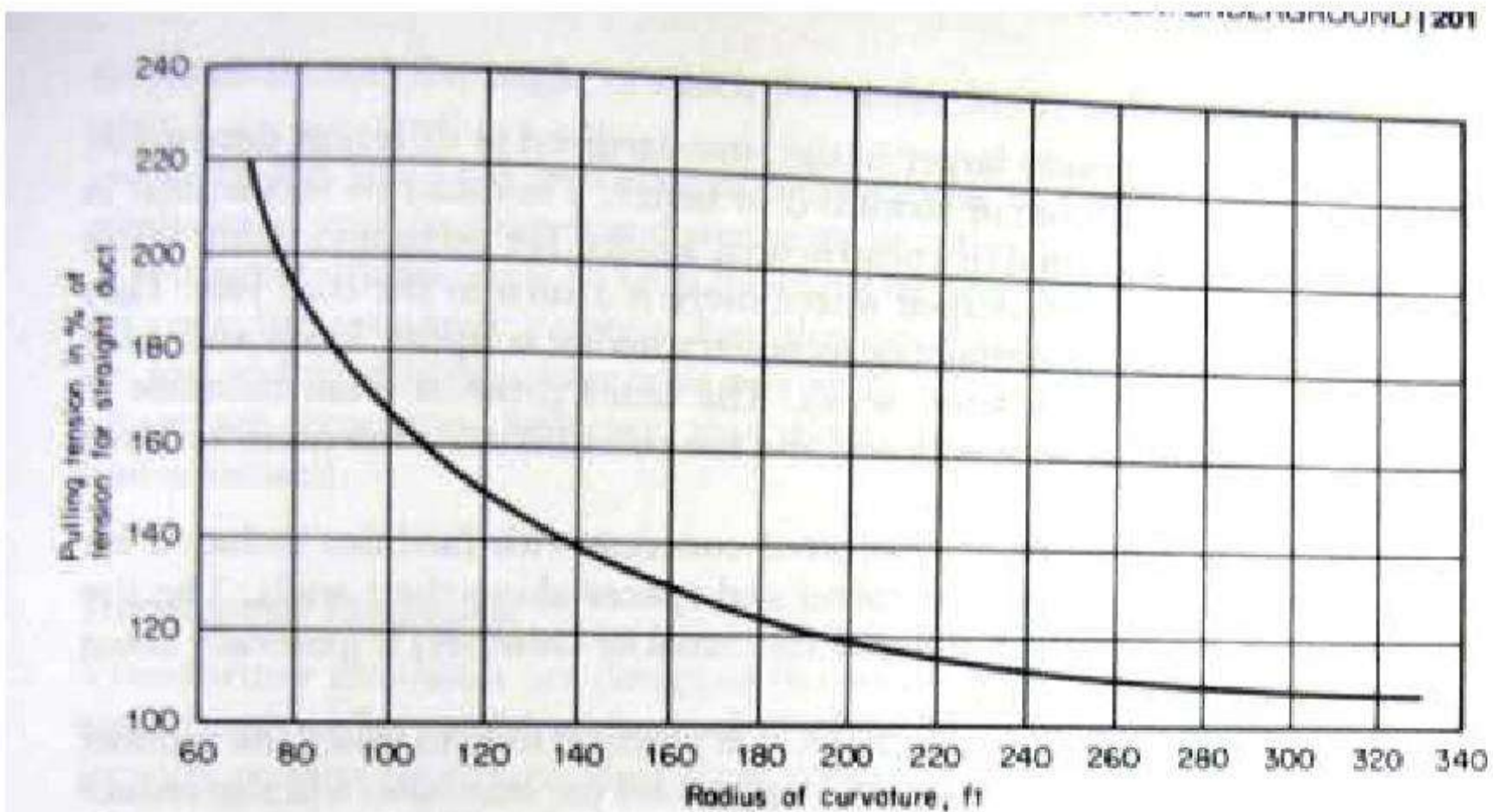
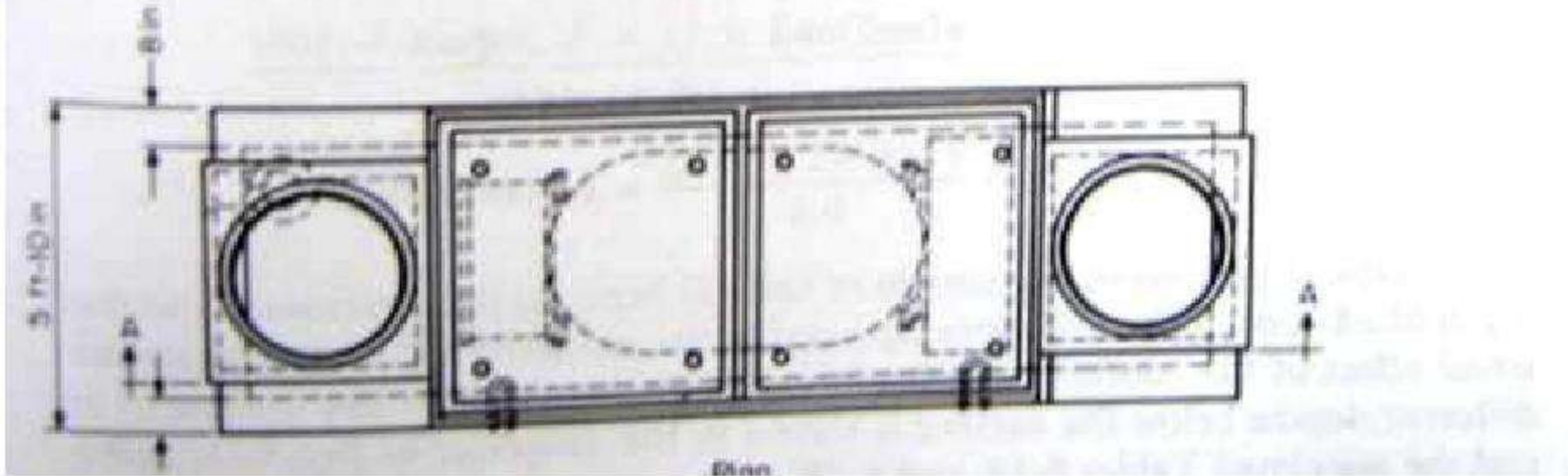

FIG. 6-2. Effect of radius of curvature of conduit on pulling tension (applicable to a conduit consisting of one continuous curved section). (From *EEI Underground Systems Reference Book*.)

Section 3 – Underground Cables

3.7 Recall cable testing techniques and methods used to find the location of cable fault

What method or combination of methods is best for locating underground cable faults?

Finding the location of an underground cable fault doesn't have to be like finding a needle in a haystack. There are many locating methods, coupled with new detection technologies, that make this task much easier and less time consuming. However, you should understand that there is no single method or combination of methods that is "best." Your selection of the appropriate method for the situation and your skill in employing that method are the keys to safely and efficiently locating cable faults without damaging the cable. Let's see what's involved.

Basic cable fault locating methods. There are two basic methods of locating an underground cable fault.

Sectionalizing This procedure, as shown in Fig. 1, risks reducing cable reliability, because it depends on physically cutting and splicing the cable. Dividing the cable into successively smaller sections will enable you to narrow down the search for a fault.

For example, on a 500-ft length, you would cut the cable into two 250-ft sections and measure both ways with an ohmmeter or high-voltage insulation resistance (IR) tester. The defective section shows a lower IR than the good section. You would repeat this "divide and conquer" procedure until reaching a short enough section of cable to allow repair of the fault. This laborious procedure normally involves repeated cable excavation.

Thumping When you supply a high voltage to a faulted cable, the resulting high-current arc makes a noise loud enough for you to hear above ground. While this method eliminates the sectionalizing method's cutting and splicing, it has its own drawback. Thumping requires a current on the order of tens of thousands of amps at voltages as high as 25kV to make an underground noise loud enough for you to hear above ground.

The heating from this high current often causes some degradation of the cable insulation. If you're proficient in the thumping method, you can limit damage by reducing the power sent through the cable to the minimum required to conduct the test. While moderate testing may produce no noticeable effects, sustained or frequent testing can cause the cable insulation to degrade to an unacceptable condition. Many cable fault locating experts accept some insulation damage for two reasons: First, when thumping time is minimal, so is the cable insulation damage; secondly, there is no existing technology (or combination of technologies) that can entirely replace thumping.

Newer fault locating technologies. There are some relatively new methods of locating cable faults that use rather sophisticated technology.

Section 3 – Underground Cables

Time Domain Reflectometry (TDR) The TDR sends a low-energy signal through the cable, causing no insulation degradation. A theoretically perfect cable returns that signal in a known time and in a known profile. Impedance variations in a "real-world" cable alter both the time and profile, which the TDR screen or printout graphically represents. This graph (called a "trace") gives the user approximate distances to "landmarks" such as opens, splices, Y-taps, transformers, and water ingress.

One weakness of TDR is that it does not pinpoint faults. TDR is accurate to within about 1% of testing range. Sometimes, this information alone is sufficient. Other times, it only serves to allow more precise thumping. Nevertheless, this increased precision can produce substantial savings in cost and time. A typical result is "438 ft 5 10 ft." If the fault is located at 440 ft, you only need to thump the 20-ft distance from 428 ft to 448 ft, instead of the entire 440 ft.

Another weakness of TDR is that reflectometers cannot see faults-to-ground with resistances much greater than 200 ohms. So, in the case of a "bleeding fault" rather than a short or near-short, TDR is blind.

High-voltage radar methods There are three basic methods for high-voltage radar, ranked here in order of popularity, with the most popular described first: arc reflection, surge pulse reflection, and voltage pulse reflection. The arc reflection method, as shown in Fig. 2 (on page 64N), uses a TDR with a filter and thumper. The filter limits both the surge current and voltage that can reach the cable under test, thus allowing minimal stress to the cable. Arc reflection provides an approximate distance to the fault (when there is an ionizing, clean arc produced at the fault and the TDR in use is powerful enough to sense and display a reflected pulse).

The surge pulse reflection method, as shown in Fig. 3, uses a current coupler and a storage oscilloscope with a thumper. The advantage of this method is its superior ability to ionize difficult and distant faults. Its disadvantages are that its high output surge can damage the cable, and interpreting the trace requires more skill than with the other methods.

The voltage pulse reflection method, as shown in Fig. 4 (on page 64P), uses a voltage coupler and an analyzer with a dielectric test set or proof tester. This method provides a way to find faults that occur at voltages above the maximum thumper voltage of 25kV.

The open neutral and cable fault locating Bare neutrals corrode quickly in contaminated soil that holds corrosive chemicals or excessive moisture. Open neutrals often thwart the effectiveness of high-voltage radar. Beware: In the existence of an open neutral, nearby telephone or CATV cables will complete the circuit.

One test to detect an open neutral requires shorting a known good conductor to a suspect neutral, as shown in Fig. 5 (on page 64P), then measuring the resistance with an ohmmeter. If the reading is 10 ohms or higher, you can suspect an open neutral. Remember, other objects can complete the circuit.

Another test uses a TDR. The trace on an open neutral will show a much flatter

Section 3 – Underground Cables

positive pulse than it will for an open conductor. On lower-end TDRs, this pulse may not be visible. When the conductor is completely open, the trace will almost never include a reflected pulse indicating the end of the cable.

If the TDR displays an open neutral, then an AC-voltage gradient test set can locate the break in a direct-buried unjacked cable. The test set's transmitter forces AC current to flow through the neutral, and the conducting earth surrounding the damaged section acts as an electrical jumper. An A-frame, as shown in Fig. 6 (on page 64P), then detects the resulting voltage gradient in the soil.

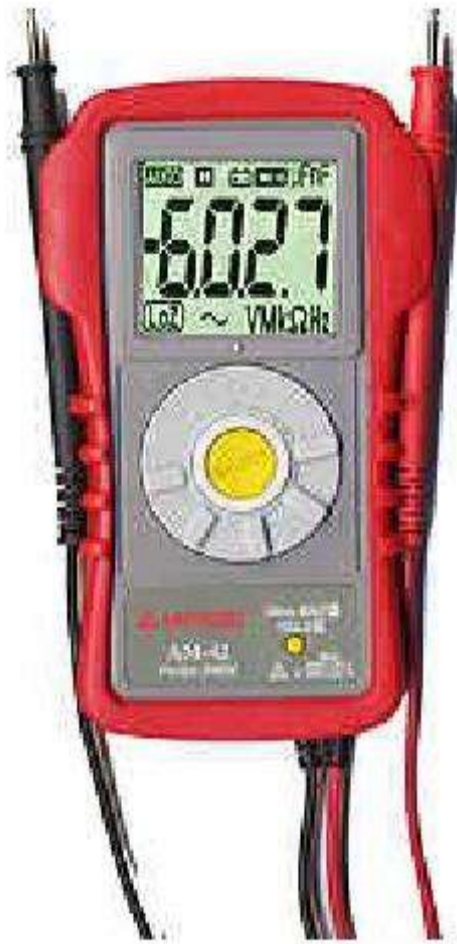

) [BI Communications TX2001 Graphical TDR Cable Fault Locator](#)

Made By BI Communications

The BI Communications TX2001 is a professional Time Domain Reflectometer and Toner designed to detect and locate faults on copper communication cables up to a distance of 3000m (10,000ft). Advanced signal processing techniques enable the TX2001 to find opens, short circuits, splices, taps, water ingress and other more elusive impedance mismatches. A built in oscillator also provides a tone for pair tracing and identification

Section 3 – Underground Cables



Megger®

Cable (Fault) Locators, TDRs and Cable Height Meters

Whether locating cable faults or testing the integrity of communication, power, or control cables, TDRs and Megger Cable Fault Locators provide fast and accurate results. Each unit is a safe, low-voltage tester that can be used on virtually all cable types, whatever their power rating.



Computerware UK, Europe's largest distributor of light pens is now expanding with BI Communications Test and Measurement products to offer a new range of [Time Domain Reflectometers](#) and [Cable Fault Locators](#).

These are the smallest graphical time domain reflectometers and cable fault locators in the world and include the [TX2001](#) - the **lowest cost** time domain reflectometer in its class.

Computerware UK also supply the [TX2002](#) and [TX2003](#) graphical time domain reflector and cable fault locator with 1% accuracy, the [FaultCaster](#) digital time domain reflectometer and the low cost [LanCaster](#) structured cable fault locator and troubleshooter incorporating EDT™ End Discrimination Technology.

The Computerware UK range of time domain reflectometers and cable fault locators are suitable for use by all communications engineers and technicians, telecom fault teams and linesmen, and contractors to the communication industries. More broadly, target end users include Telecom Companies (RBOC's, CLEC's, PTT's, etc.), Cable Television (CATV) and Cable Internet Service

Section 3 – Underground Cables

Providers, as well as Government and Military organisations. The FaultCaster is also aimed at Network Installers and general electrical Contractors.

Standardized VDE-switch-on procedures for operating high voltage test sets:

1. Ready for operation
2. Ready to switch on

Application

As the supply of electrical energy is getting more and more important for our society, it is necessary to make sure that power supply system works without any problems.

Cables are frequently used for the distribution of the electrical energy. Although the cables are highly developed, there are sometimes malfunctions in the cable system. To keep the consequential damages as small as possible, trained staff and efficient equipment is needed.

BAUR cable fault location instruments and systems are applicable to all types of cables

ranging from 1 kV to 500 kV and all types of cable faults such as

Short circuit faults

Cable cuts

Resistive faults

Intermittent faults

Sheath faults

Water trees

Partial discharges

We distinguish between two types of cable fault location:

Pre-location

Section 3 – Underground Cables

Section 4- Voltage Regulation and Associate Equipments

4.1 Recall Terminology used in relation to voltage profile

Voltage regulation

The voltage regulation is defined as the percentage rise in voltage at receiving end when full load is thrown off, the sending end voltage is unaltered.

$$\text{Regulation} = \frac{E_s - E_r}{E_r} \times 100 \%$$
$$= \frac{I R \cos \phi_r + I X \sin \phi_r}{E_r}$$

Off load tap changer

The usual tapplings on a transformer are 2 ½ percent giving + - 2 ½ percent and + - 5 percent of the nominal voltage. However, the tapplings may all be on the minus side.

On load tap changer

On load tap changer is a transformer which is provided with equipment for changing the voltage ratio under load. The essential feature is that there must be no break in the winding circuit whilst the selector switches pass from one tapping point to the next. This requirement inevitably means that for a short period there must be connection between two adjacent tapplings at the same time and means must be provided to prevent the flow of a heavy short-circuit current.

Booster Transformer

Booster transformer is a separate transformer which is used to inject a variable voltage into a circuit for regulating purpose. Such an application could be made where it is desired to obtain additional voltage control under load on lines already existent and where new transformers are not to be purchased.

Quadrature Boosters

Quadrature Boosters or phase angle control units inject a voltage with a major component at 90 degrees to the existing voltage.

Section 3 – Underground Cables

Section 4- Voltage Regulation and Associate Equipments

Induction and Moving Coil Regulators

Tap changing transformers of the “ off load “ or “ on load” and booster type transformers are the most commonly used voltage regulating equipments for distribution work.

Power loss

The power loss in the distribution feeders depends on the square of the current and the resistance of the feeder. His loss must be considered in relation to the capital cost involved in the erection of distribution line. As costs of raw materials, cost of generation, or cost of bulk electricity vary greatly this aspect can not be considered in detail. The basis of most cost calculations is known as Kelvin’s Law, which is as follows.

On the assumption that the variable portion of the cost of the conductor is proportional to its cross sectional area the most economical size is that one for which the annual cost of energy lost is equal to the cost of interest and depreciation

Voltage profile

Voltage profile charts are useful for studying pattern and to locate causes or reasons for abnormal voltage conditions

4.2 Describe the reasons effects and limitation of voltage variation

Voltage control

All modern transmission systems with the exception of the constant current system, operate at a constant voltage . It is essential for the satisfactory operation of the consumer’s apparatus that the vltage be kept within narrow limit.

Voltage drop

The conductor must operate so that when the maximum current is being conveyed. The fall in voltage along the line is within certain limit.

The value of fall in potential for a consumer’s overhead line must be taken into account when ensuring that the fall in potential from the consumer’s mains to any point on the installation .

Section 3 – Underground Cables

SAA Rule

Fall in the potential in the consumer's mains to any point on the installation does not exceed 5 % of the voltage at the commencement when full current is flowing.

Section 4- Voltage Regulation and Associate Equipments

Medium voltage – variation within 6% (Not exceed)
 Higher voltage—Variation within 10% (Not exceed)

4.3 Recall methods used in controlling voltage level

The reactance and the resistance of the line must first be determined . The effects of transformers can be represented by adding to the series line impedance, the series impedance of the transformers. The equivalent electrical circuit of the line is drawn as follows.

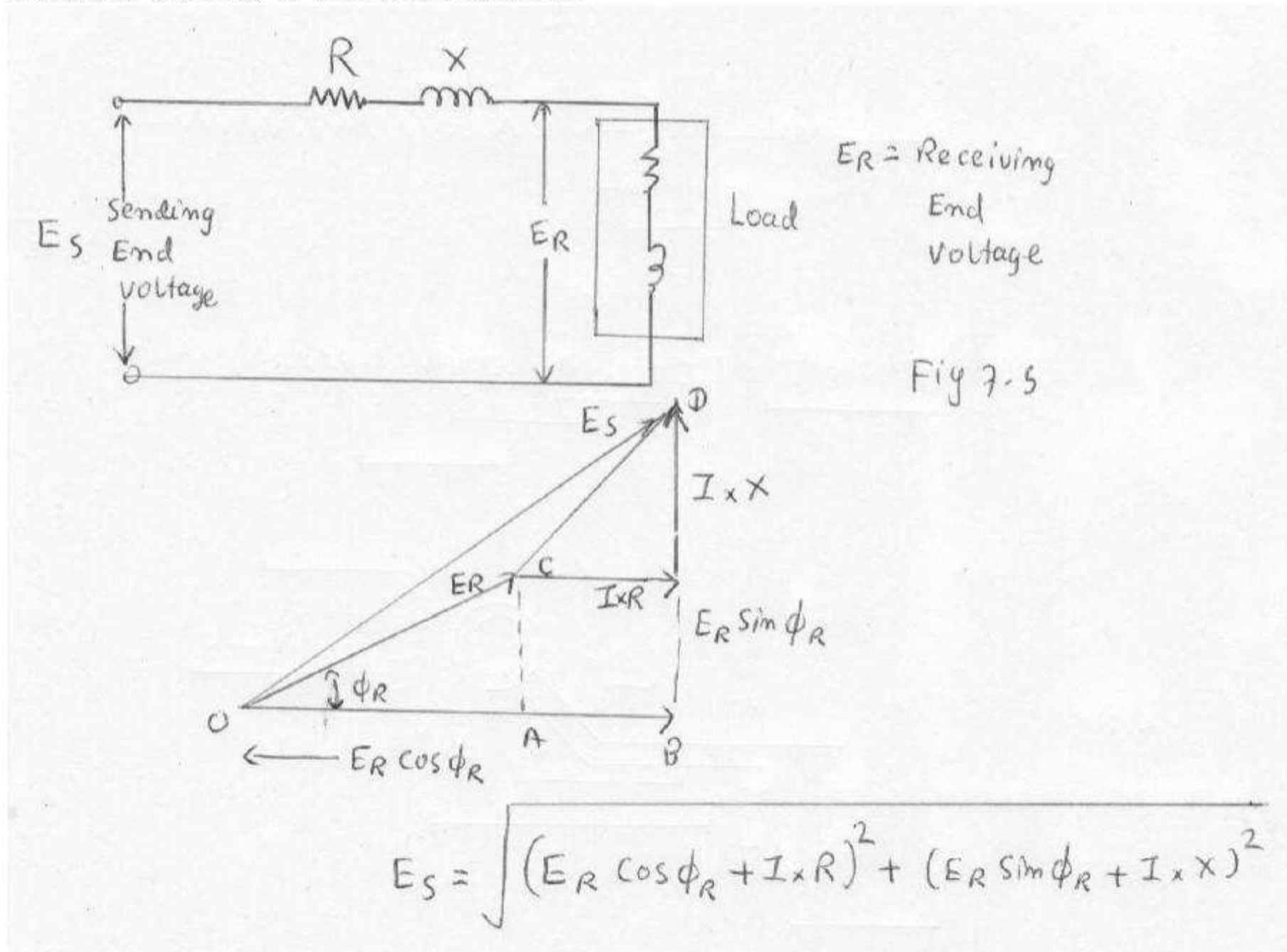

From the above it will be seen that

$$E_s = \sqrt{OB^2 + BD^2}$$

Section 3 – Underground Cables

$$OB = E_r \cos \phi_r + IR$$

$$BD = E_r \sin \phi_r + IX$$

Section 4- Voltage Regulation and Associate Equipments

Therefore

$$E_s = \sqrt{(E_r \cos \phi_r + IR)^2 + (E_r \sin \phi_r + IX)^2}$$

Where

E_s = Sending end voltage

E_r = Receiving end voltage

Then

$$= E_r \sqrt{(\cos \phi_r + IR/E_r)^2 + (\sin \phi_r + IX/E_r)^2}$$

This form is more convenient because the quantity under the radical sign is in the order of unity.

$$E_s = E_r \sqrt{1 + 2 IR/E_r \cos \phi_r + 2 IX/E_r \sin \phi_r + I^2 (R^2 + X^2) / E_r^2}$$

The last term is usually negligible because the denominator E_r^2 is very big.

Thus

$$E_s = E_r \sqrt{1 + 2 IR/E_r \cos \phi_r + 2 IX/E_r \sin \phi_r}$$

$$= E_r \{ 1 + 2 IR/E_r \cos \phi_r + 2 IX/E_r \sin \phi_r \}^{1/2}$$

Using the binomial theorem this gives as a first approximation

$$E_s = E_r (1 + IR/E_r \cos \phi_r + IX/E_r \sin \phi_r)$$

OR

Section 3 – Underground Cables

$$E_s = E_r + IR \cos \phi_r + IX \sin \phi_r$$

Section 4- Voltage Regulation and Associate Equipments

The regulation is defined as the percentage rise in voltage at the receiving end when the full load is thrown off , the sending end voltage is unaltered.

$$\text{Regulation} = \frac{E_s - E_r}{E_r} \times 100$$

$$= \frac{IR \cos \phi_r + IX \sin \phi_r}{E_r} \times 100$$

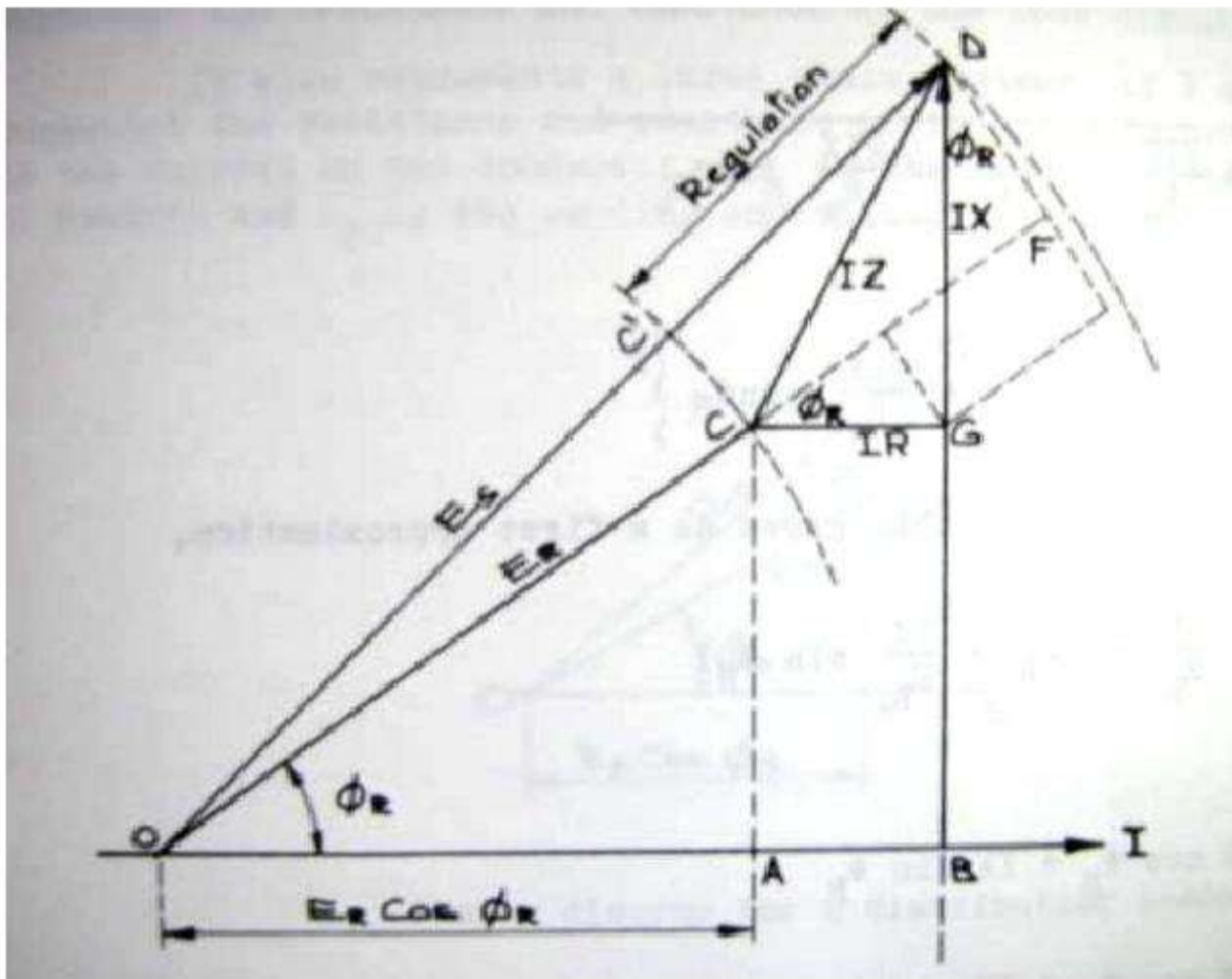

Section 3 – Underground Cables

The regulation is then

$$CF = CG \cos \phi_R + GD \sin \phi_R$$

$$= IR \cos \phi_R + IX \sin \phi_R$$

If R and X are values for single conductor per kilometre, the total voltage drop per kilometre will be:

$$\text{For single phase lines} = 2 (IR \cos \phi_R + IX \sin \phi_R)$$

$$\text{For three phase lines} = \sqrt{3} (IR \cos \phi_R + IX \sin \phi_R)$$

Methods of voltage control

Three general methods are available for controlling the voltage at the end of a distribution feeder. They are

1. By controlling the sending end voltage
2. By controlling the receiving end voltage
3. By controlling the current in the line that is varying the power factor

Voltage control equipments

1. Off load tap changing transformer
2. On load tap changing transformer
3. Booster transformer
4. Moving coil regulator
5. Induction regulator

Off load tap changer

The usual tapplings on a transformer are 2 ½ percent giving + - 2 ½ percent and + - 5 percent of the nominal voltage. However, the tapplings may all be on the minus side.

Plus Tapping & Minus tapping

A plus tapping is one which introduces into the active part of the winding concerned a greater number of turns while a minus tapping is one which introduces fewer turns into the winding. The taps are usually located in the centre of the winding or near the neutral end away from line surges. They are arranged so as not appreciably to displace the electrical centres of the whole windings for any tap circuit, and also not to affect appreciably the reactance of any tap circuit.

Section 3 – Underground Cables

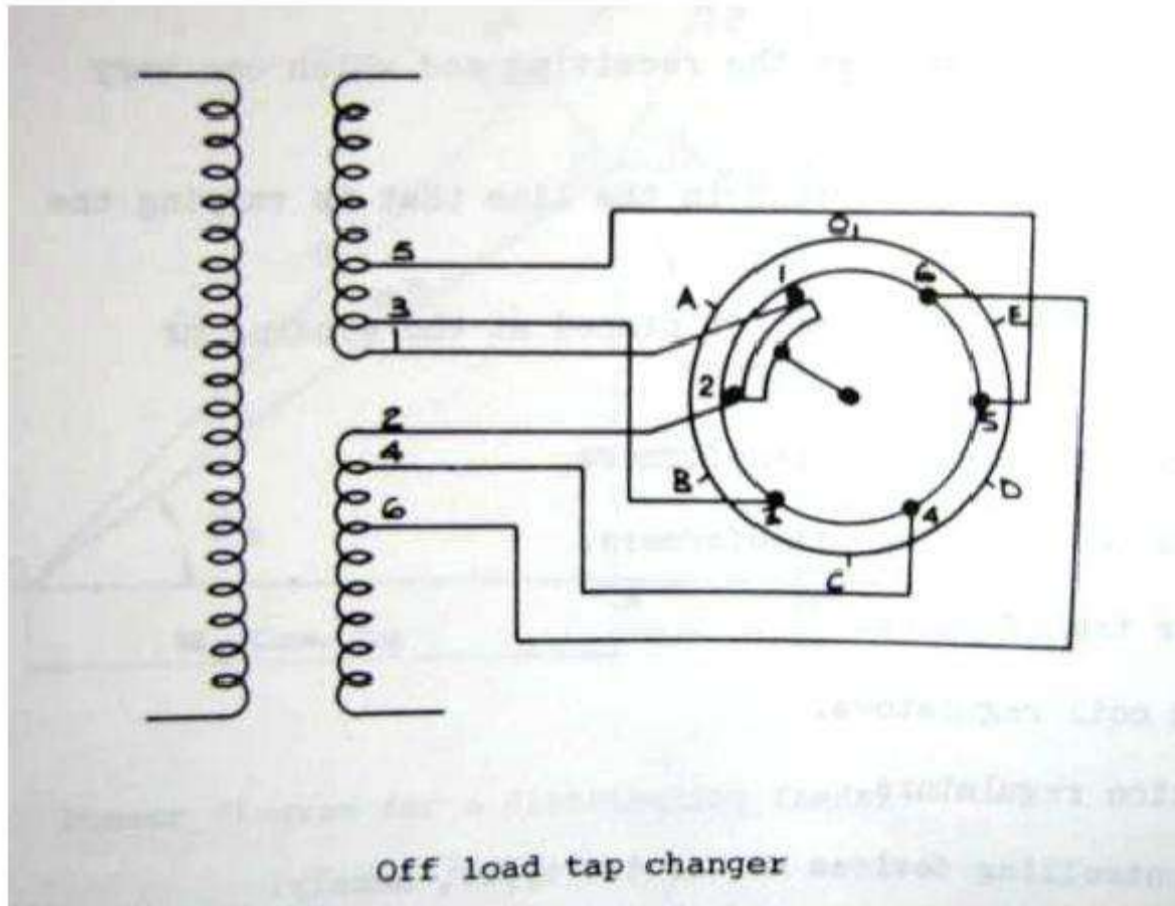

+/- 2 ½ % to +/- 5% of nominal voltage

Tap Connections

Position	Connecting tap terminals	per cent of winding
A	1 to 2	100
B	2 to 3	97.5
C	3 to 4	95
D	4 to 5	92.5
E	5 to 6	90

On load tap changer

Section 3 – Underground Cables

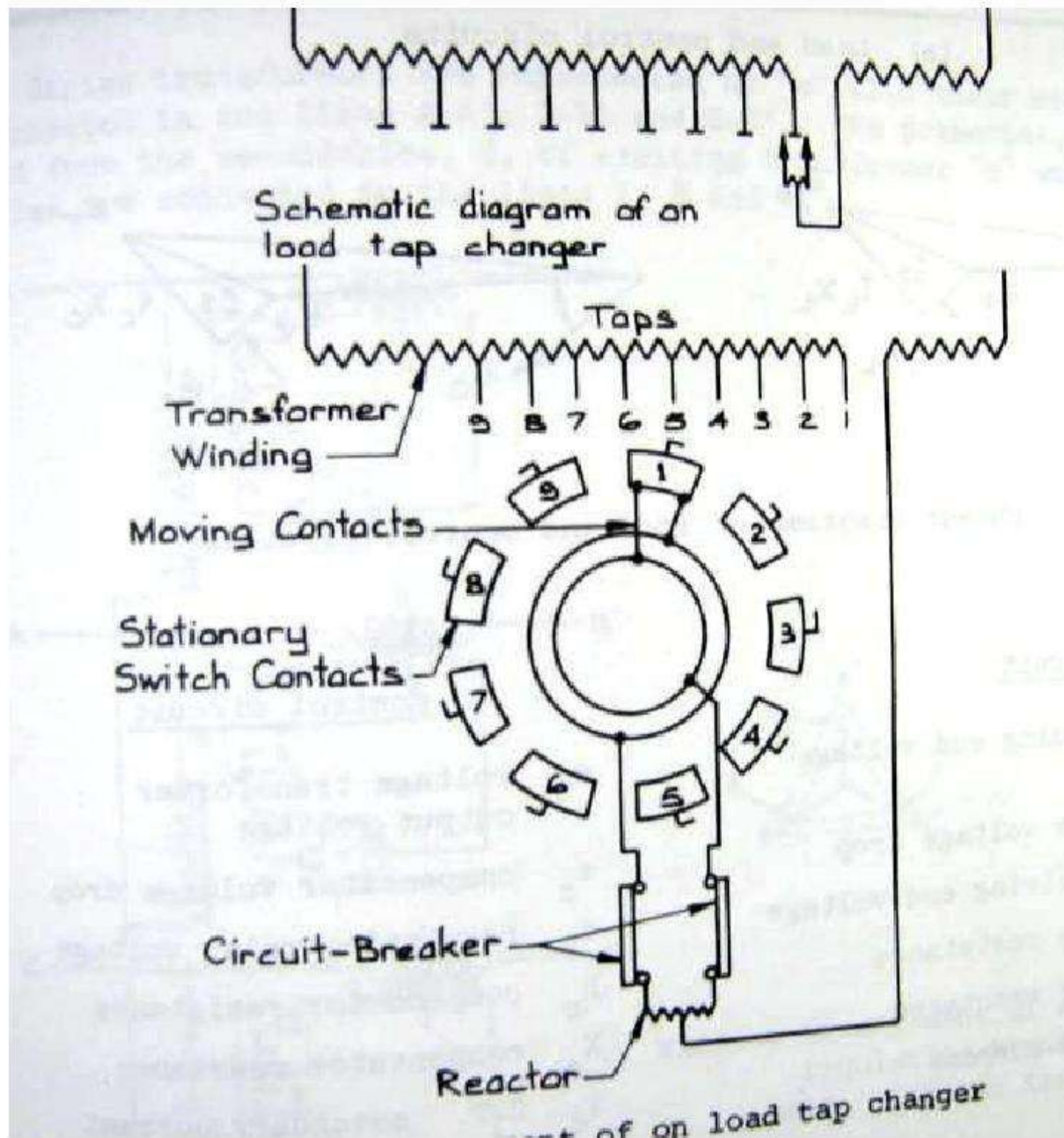

Many transformers are provided with equipments for changing their voltage ratio under load. The essential feature is that there must be no break in the winding circuit whilst the selector switches pass from one tapping point to the next. This requirement inevitably means that for a short period there must be connection between two adjacent tappings at the same time and means must be provided to prevent the flow of a heavy short-circuit current. This is achieved either by the introduction of a current limiting resistor or a reactor. Each arrangement has its merits and both are in common use.

On the smaller tap changers, the current is broken by the selector switches themselves. On the larger sizes, however, where KVA per step exceeds about 20 kVA per step per phase, special switches are used. They are provided in a separate tank usually mounted below the selector switch tank.

While the operating mechanism for on load tap changers may be manual, it is usual for it to be motor operated, and in many cases to be fully automatic.

Section 3 – Underground Cables

Automatic Voltage Control

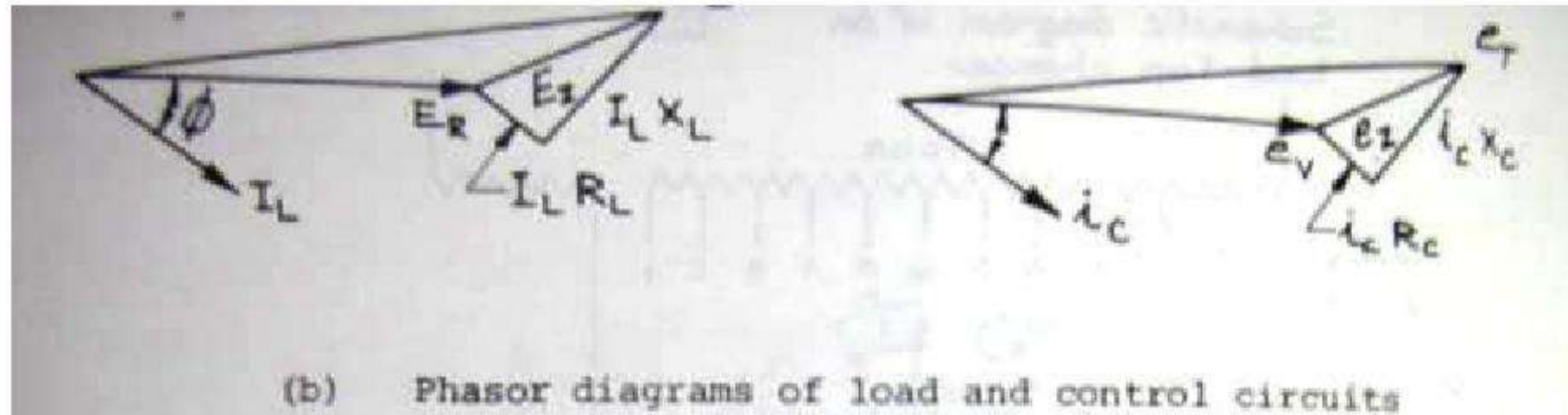
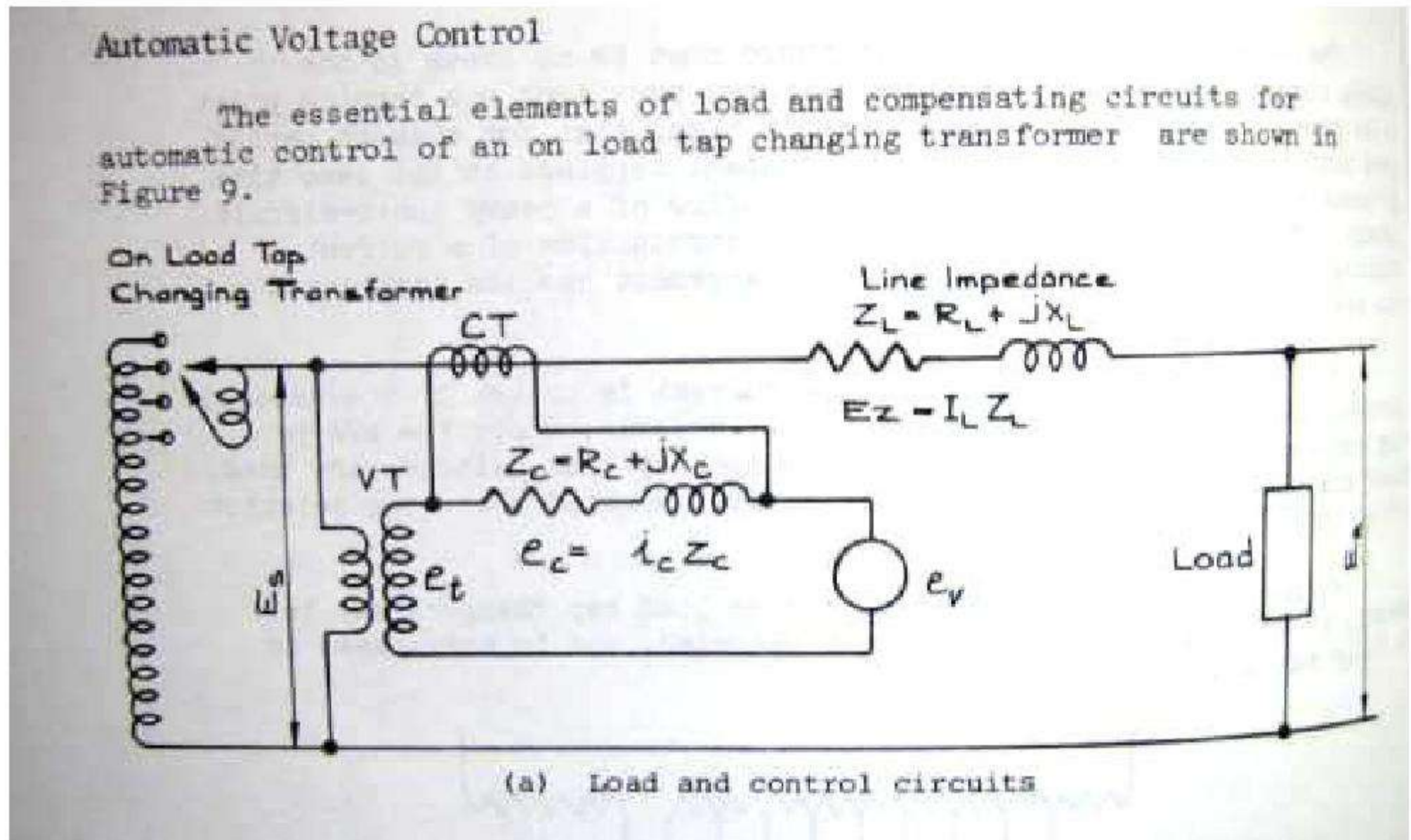

Main Circuit

E_s	sending end voltage
E_z	line voltage drop
E_R	receiving end voltage
R_L	line resistance
X_L	line reactance
I_L	load current

Control Circuit

e_t	voltage transformer output voltage
e_c	compensator voltage drop
e_v	regulating relay voltage
R_c	compensator resistance
X_c	compensator reactance
i_c	C.T. secondary current

Section 3 – Underground Cables

Booster transformer

A separate transformer may be used to inject a variable voltage into a circuit for regulating purpose.

Quadrature booster

Injects a voltage with a major component at 90 degree to the existing voltage.

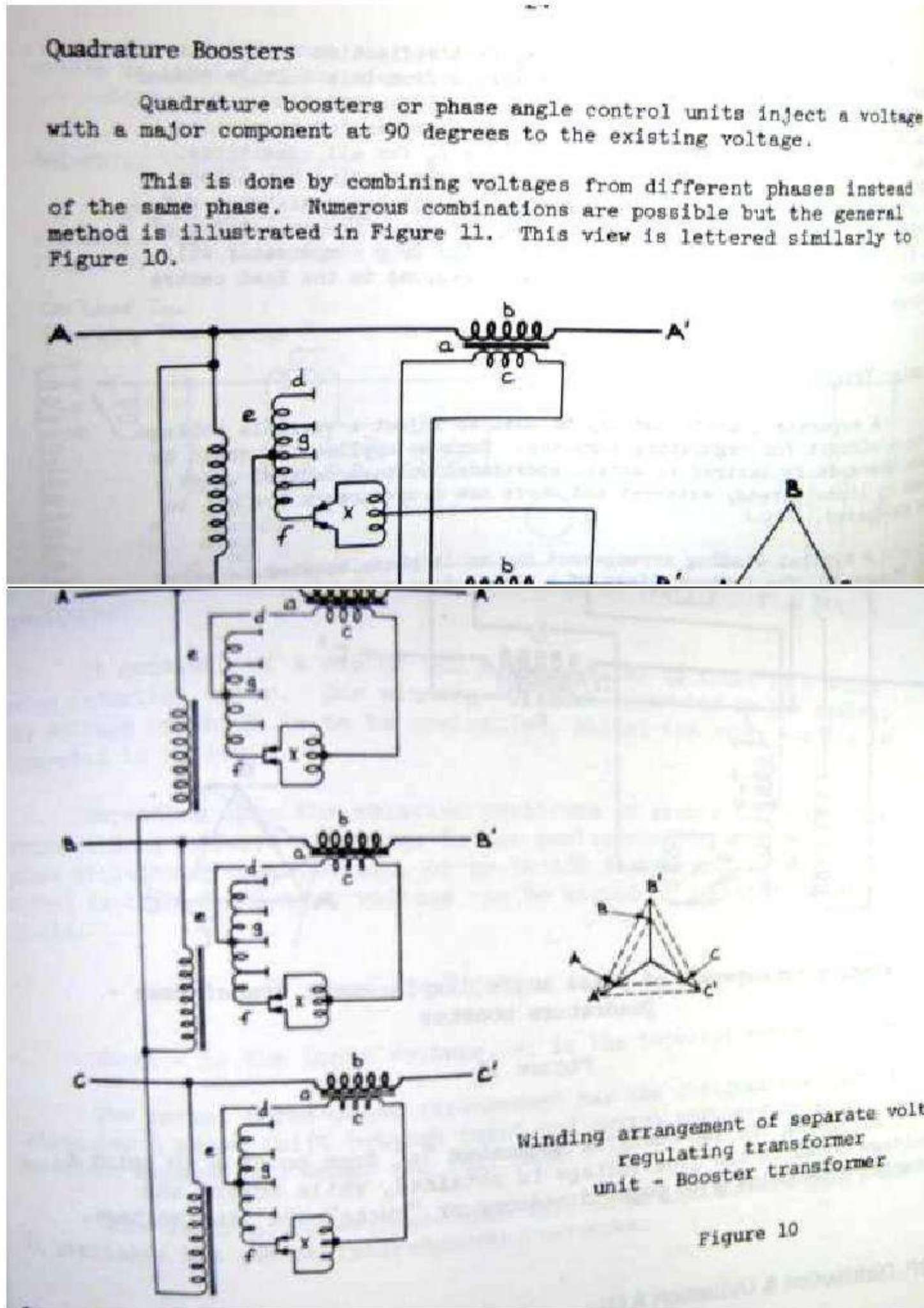

Section 3 – Underground Cables

Section 4- Voltage Regulation and Associate Equipments

Induction and moving coil regulator

Tap changing transformers of the “off load” or “on load” and booster type transformers are the most commonly used voltage regulating equipment for distribution work. Other types of equipment which could be used are the induction regulator and the moving coil regulator. These , however, are usually more expensive and liable to be damaged under a system fault.

Induction regulator

This equipment may be used by itself or in conjunction with a transformer. It consists of a stator and rotor similar to those of a wound rotor induction motor. One winding is shunt connected on the system, the voltage of which is to be controlled, whilst the other winding is connected in series.

Depending upon the relative positions of stator and rotor, the shunt winding induces a voltage in the series winding that may be in phase with the system voltage, or up to 180 degrees out of phase. The effect is that the output voltage can be varied in magnitude between limits.

$$V \pm V_1$$

Where V is the input voltage, V_1 is the injected series voltage.

The normal three phase arrangement has the disadvantage that it introduces a phase shift between input and output voltages at all positions except full boost and full back.

This is of no consequence when used on an individual supply , but it produces its use on interconnected networks.

$\Phi_{\text{output}} = \Phi_1 + \Phi_2$ depending on the position of moving coil.

Section 3 – Underground Cables

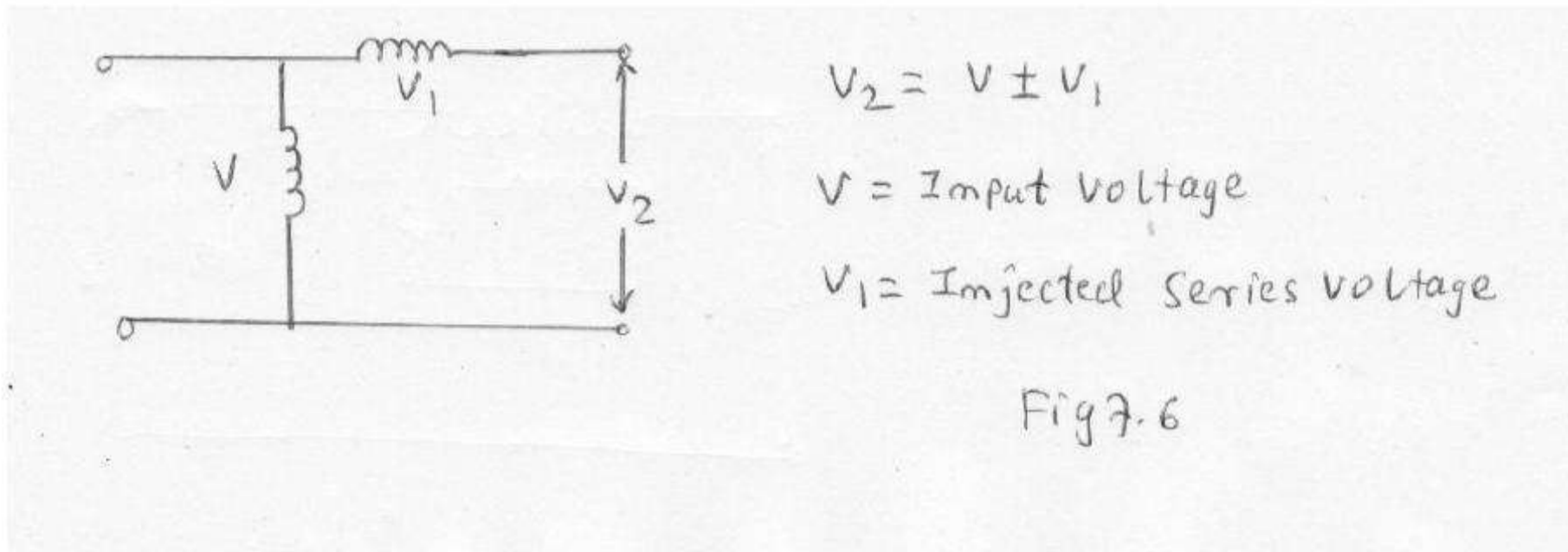

$$V_2 = V \pm V_1$$

$$V \pm V_1 = V_2$$

$V = \text{Input voltage}$

$V_1 = \text{Injected series voltage}$

Moving Coil Regulator

In the construction of a moving coil regulator, there are two pairs of closely coupled shunt and series coils A1, S1 and A2 S2 respectively shown in the figure.

The four coils are mounted on a common magnetic circuit. The moving coil M is short-circuited on itself and at its limits of travel surrounds one or other of pairs of fixed coils.

The shunt coils A1 and A2 are connected additively and the series coils S1 and S2 in opposition.

Section 3 – Underground Cables

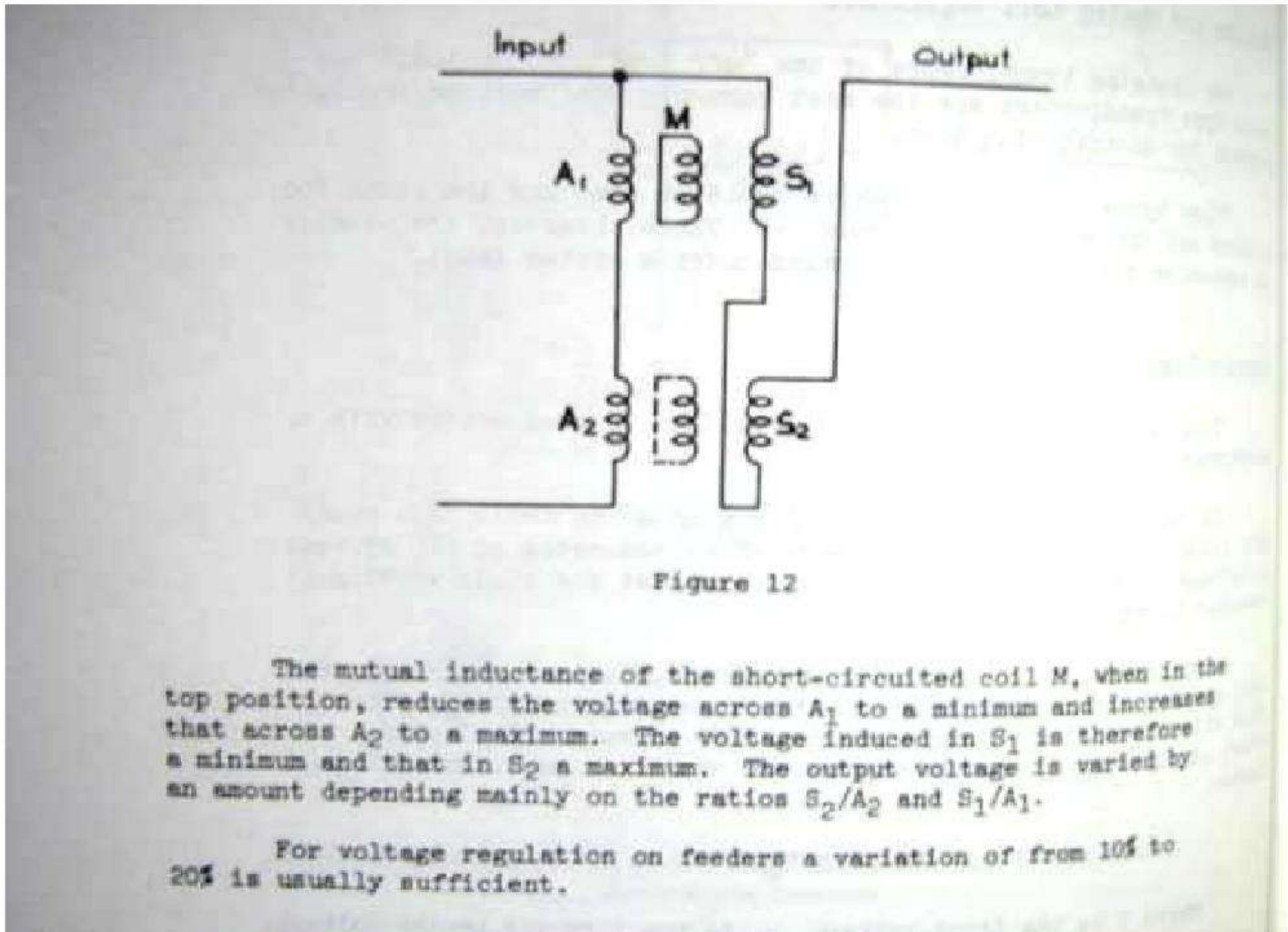

Constant ratio distribution transformer

Constant ratio distribution transformer are transformers with no variation of the transformer ratios. For a light load, the zone transformer tap changer is set at 100 percent, while for a heavy load, the zone transformer gives a 10 percent boost.

It will be seen that with 10 percent boost the voltage for a heavy load is minus 6 percent .

For light load conditions with the zone transformer at 100 percent , the voltage is minus percent.

Note

Light load, zone transformer tap changer is set at 100%.

Heavy load, transformer gives 10% boost

Section 4- Voltage Regulation and Associate Equipments

Section 3 – Underground Cables

Variable ratio distribution transformer

Variable ratio distribution provides the voltage profile with combined zone transformer voltage boost of 10 percent variation of the far distribution transformer off load tap changer to 2 ½ percent boost. With this arrangement, for a heavy load, the voltage regulation is plus 5 percent and for light load, it is minus 1 ½ percent.

Note

Zone transformer 10% boost
Variation of far distribution transformer off-load
Tap changer to 2 ½ % boost.

Voltage regulation by control of current

While voltage control by means of tap changing transformers is the usual method for distribution work, mention must be made of the use of capacitors to a load and so changing the power factor. The load conditions without capacitors is shown in full lines.

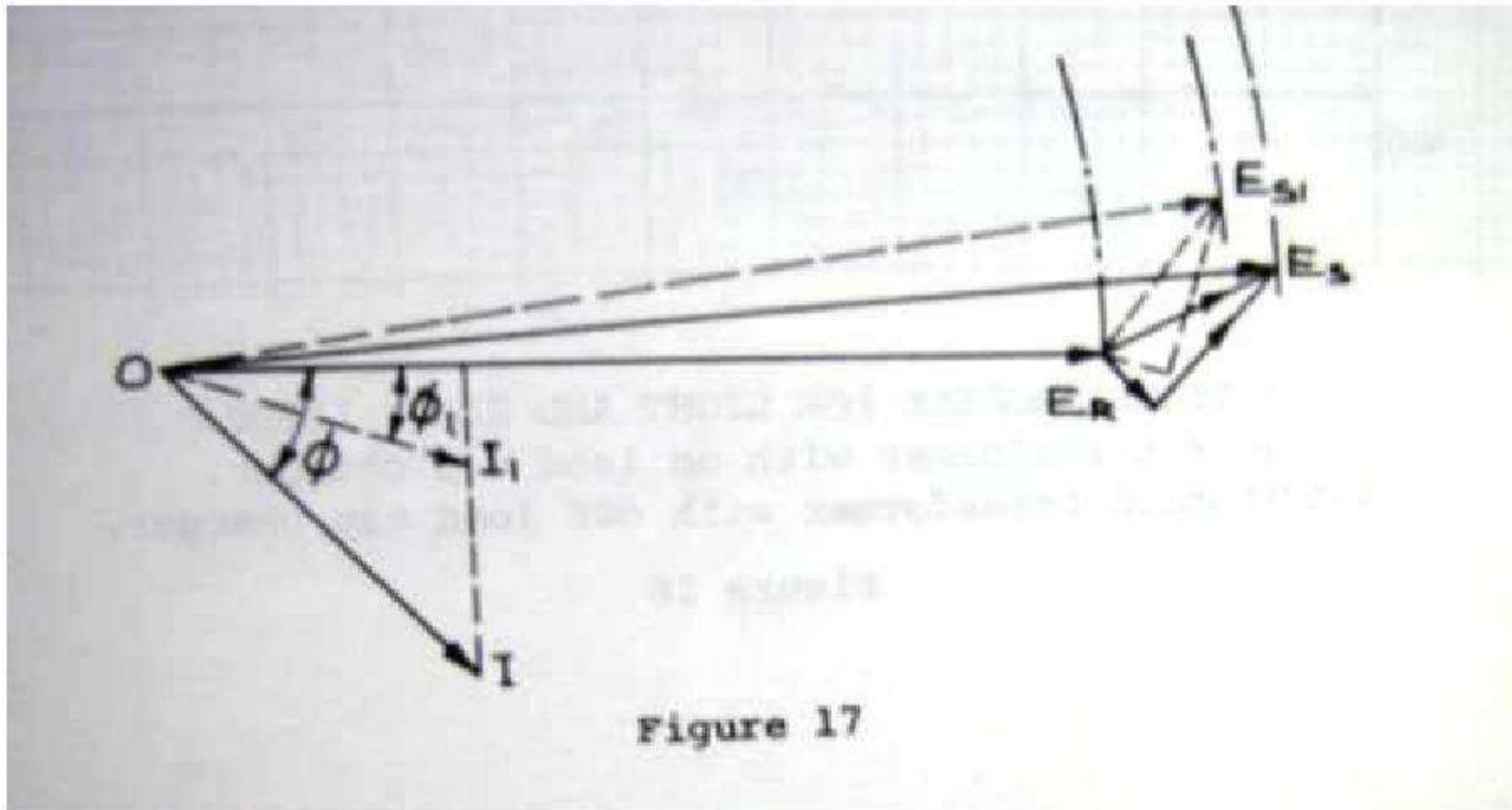

Section 3 – Underground Cables

Section 4- Voltage Regulation and Associate Equipments

4.4 Draw voltage profile using calculation to determine % voltage drop for components within the distribution feeders.

Voltage profile

Voltage profile charts are useful for studying pattern and to locate causes or reasons for abnormal voltage conditions.

To make such a chart, a common voltage level is selected for the system and the circuit constants such as resistance and reactance are converted to this voltage by means of the formula.

$$R_2 = (E1/E2)^2 R_1$$

R_2 = Resistance referred to voltage E_2

R_1 = Resistance referred to voltage E_1

E_1 and E_2 are respective voltage levels.

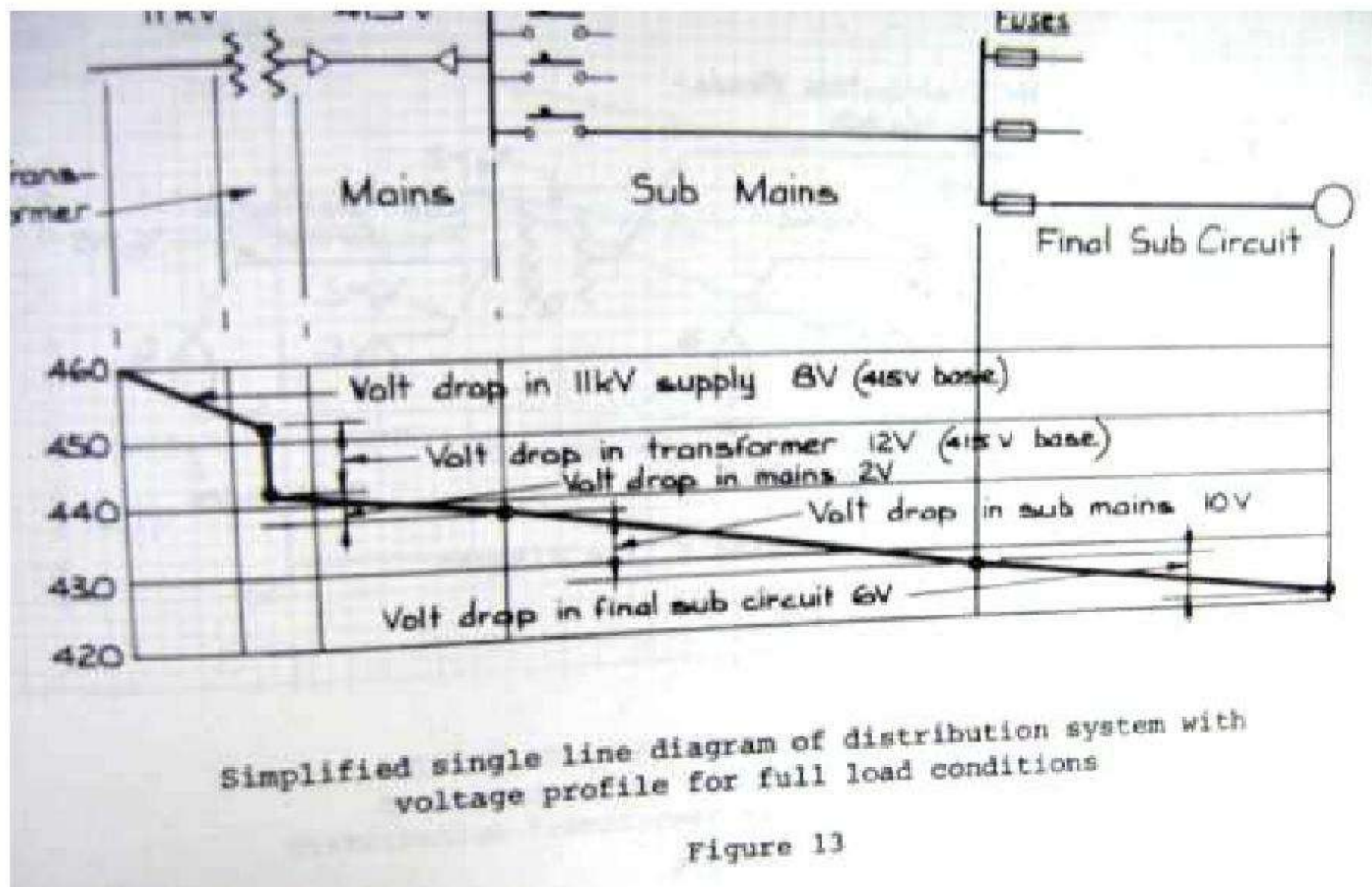

Section 3 – Underground Cables

Voltage profile example

The simplified single line diagram of a distribution system is shown in the figure. It is desired to keep the voltage within + 6 % and -4% of the nominal voltage.

Consumers

A, B --- Distribution transformer T1

C, D---- Distribution transformer T2

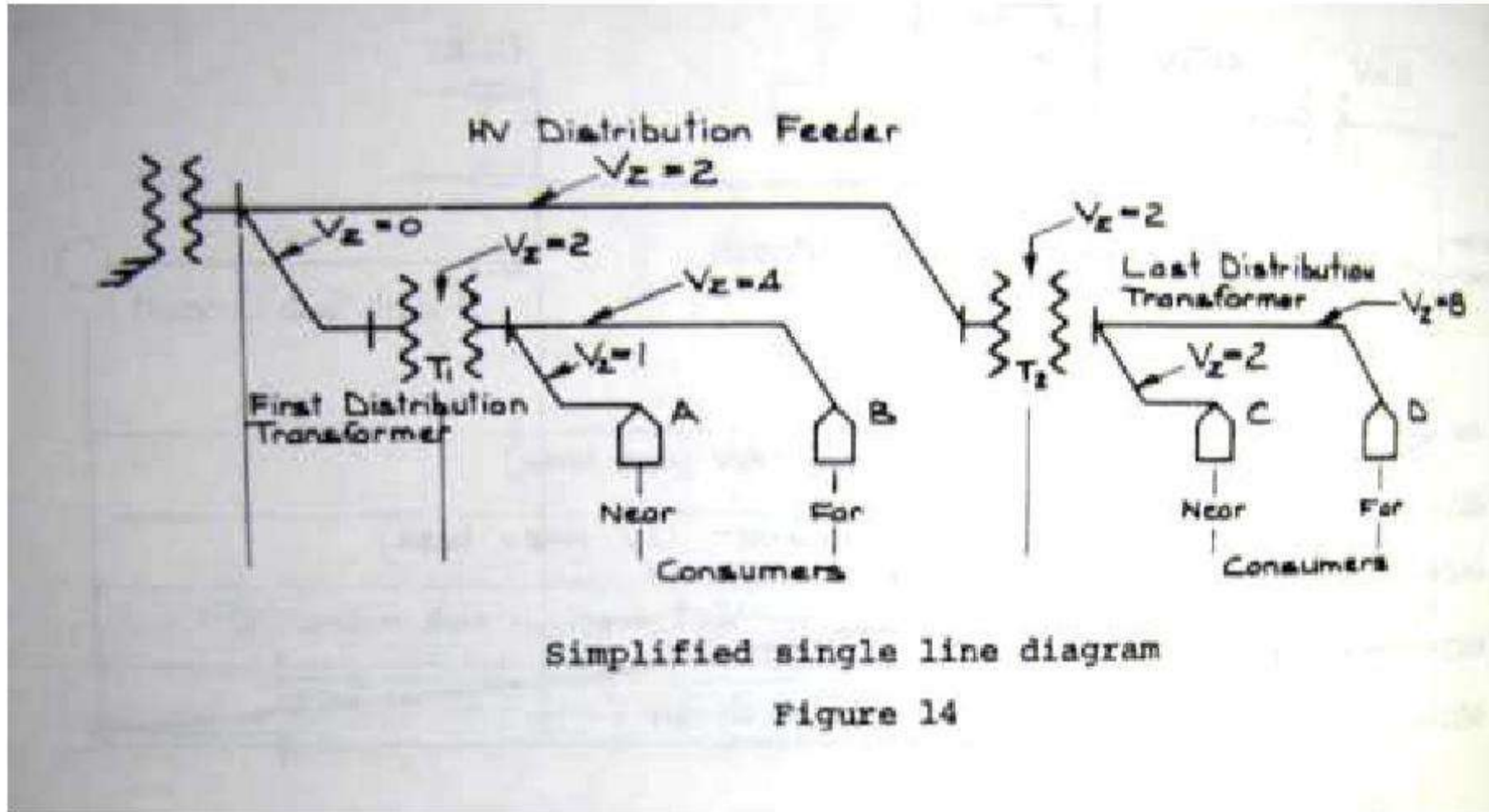

Problem

An industrial consumer takes a load of 100KVA at 0.8 Power factor lagging . Calculate the voltage at the consumer terminal . Given that supply transformer is a half kilometre away and has a sending end voltage of 433 Volts and the conductor has resistance 0.238 Ω/ km and reactance of 0.296 Ω/ km.

$$\text{Line current} = \frac{100 \times 10^3}{\sqrt{3} \times 433} = 133 \text{ Amp}$$

$$\sqrt{3} \times 433$$

$$\begin{aligned} V \text{ drop} &= I (R \cos\Phi + X \sin \Phi) \\ &= 133 (0.119 \times 0.8 + 0.148 \times 0.6) \\ &= 133 (0.0952 + 0.0888) \\ &= 133 \times 0.184 = 24.5V \end{aligned}$$

Section 3 – Underground Cables

$$\text{Receiving end voltage} = \frac{433}{\sqrt{3}} - 24.5 = 225.5 \text{ V / Ph or } 390.5 \text{ V /line}$$

Section 4- Voltage Regulation and Associate Equipments

Problem

From the given graph, determine the minimum voltage rating required for the direct laid single core cable so that a voltage rating of 0.6/ 1 KV can be achieved when

- (a) 2 circuits are in each group with spacing of 0.6 m
- (b) 3 circuits exist in two touching groups.

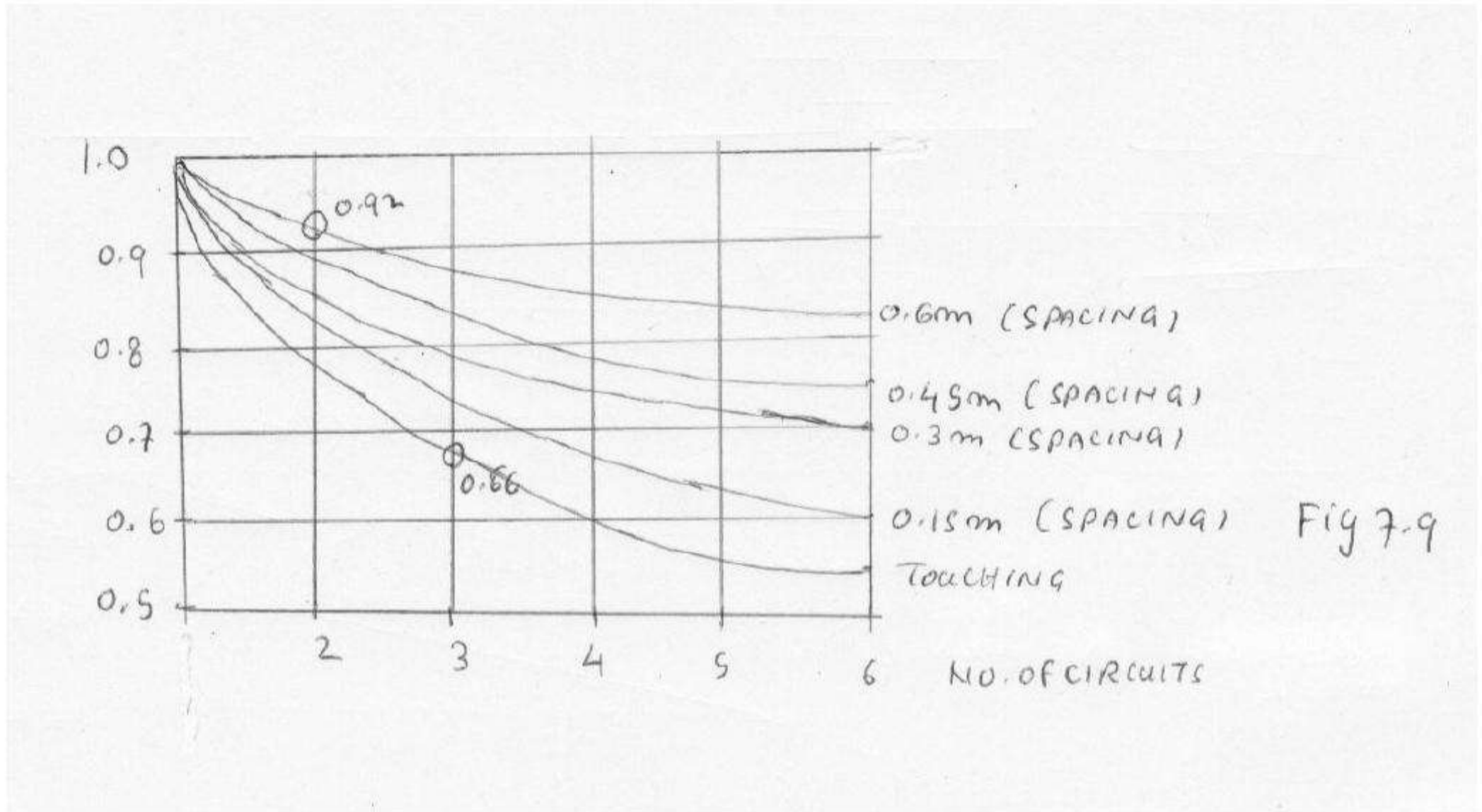

(a)

$$\text{Phase to earth voltage} = \frac{0.6}{0.92} = 0.652 \text{ KV}$$

$$\text{Phase to phase voltage} = \frac{1}{0.92} = 1.087 \text{ KV}$$

Section 3 – Underground Cables

(b)

$$\text{Phase to earth voltage} = \frac{0.6}{0.66} = 0.91 \text{ KV}$$

$$\text{Phase to phase voltage} = \frac{1}{0.66} = 1.52 \text{ KV}$$

Section 4- Voltage Regulation and Associate Equipments

Problem

For the simplified single line diagram shown, draw the voltage profile for the following full load conditions

- Full load system voltage at point A is 12.19 KV
- Voltage drop in 11 KV supply is 212V
- Voltage drop in 11 KV transformer is 318 V
- Voltage drop in main is 2 V.
- Voltage drop in sub-main is 10 V
- Voltage drop in final sub circuit is 6 V.

Use 415 V as nominal load voltage.

Section 4- Voltage Regulation and Associate Equipments

Formula

$$\frac{V1}{V2} = \frac{\text{Voltage drop (1)}}{\text{Voltage drop (2)}}$$

Side	Voltage drop	Side	Voltage drop
11 KV line	12.19 KV	415 V	$\frac{11000}{415} = \frac{12.19 \times 10^3}{V2}$ $V2 = 459 \text{ V}$
11 KV line	212 V	415 V	

Section 3 – Underground Cables

drop			$\frac{11000}{415} = \frac{212}{V2}$ $V2 = 8 \text{ V}$
11 KV Transformer drop	318 V	415	$\frac{11000}{415} = \frac{212}{V2}$ $V2 = 12 \text{ V}$
		415 V main	2 V
		415 V Sub main	10 V
		415 V Final Sub circuit	6 V

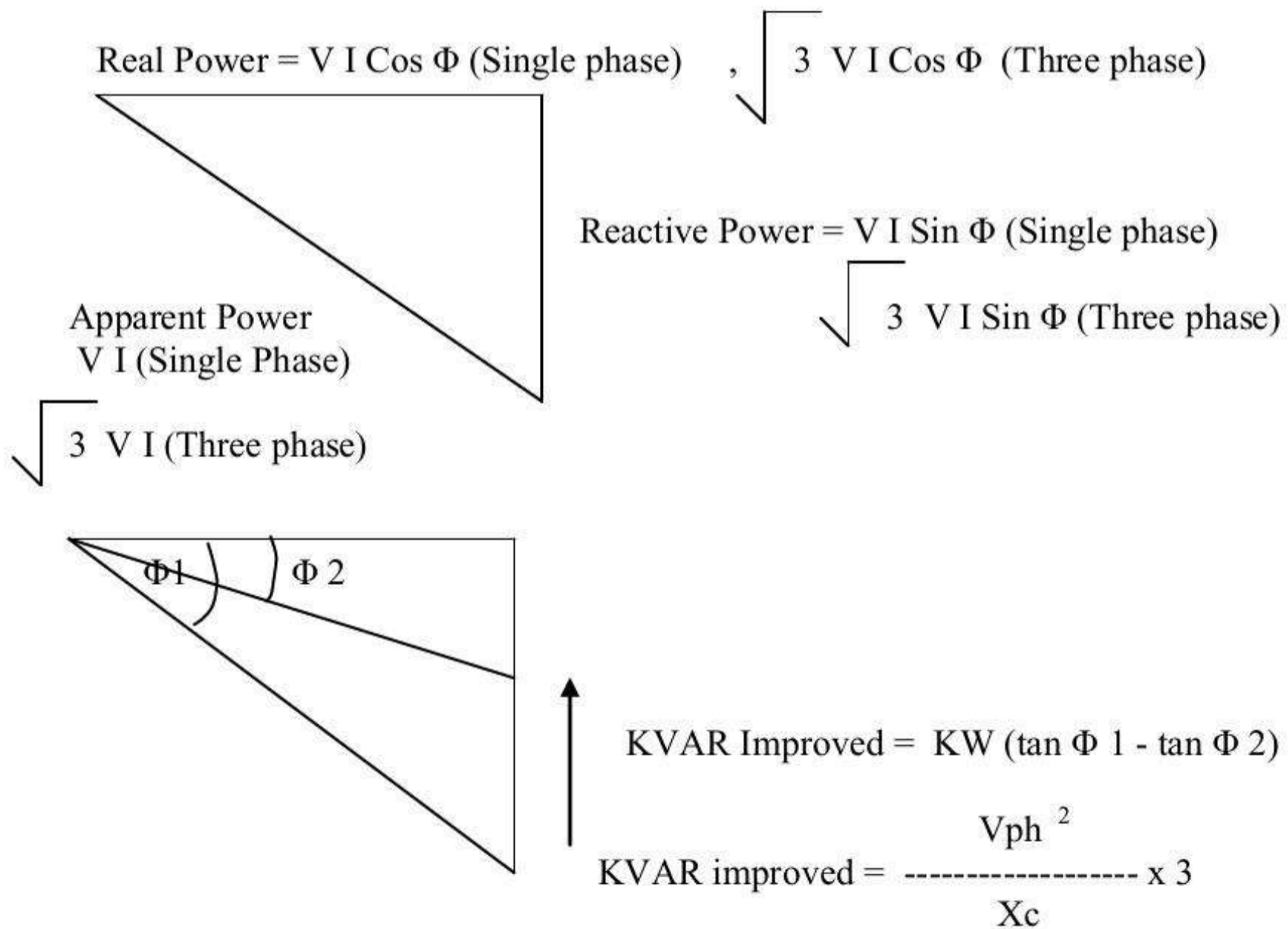

Section 3 – Underground Cables

Problem

A phase load of 200 KVA 50 Hz is to have its power factor improved from 0.75 to 0.9. Calculate the size of capacitor bank required if the supply voltage is 415V. Sketch the connection.

Use delta capacitor bank

$$\Phi 1 = \cos^{-1} 0.75 = 41$$

$$\Phi 2 = \cos^{-1} 0.9 = 26$$

$$Kw = 200 \times 0.75 = 151 \text{ Kvar}$$

$$\text{Kvar correction} = 151 (\tan 41 - \tan 26) = 65.2 \text{ Kvar}$$

$$X_c = \frac{V^2}{Kvar} = \frac{415^2}{65.2 / 3 \times 1000}$$

$$C = \frac{1}{2 \pi f X_c} = 100 \text{ micro farad}$$

Section 3 – Underground Cables

REVIEW QUESTIONS FOR SECTION 3 AND 4

Section 3 – Underground Cables

Review questions for Section 3

1. What are the most commonly used insulating materials used for cables? Describe briefly the one that is used in distribution cables.

2. Describe briefly the following terms:

(a) Conductor screening

(b) Insulation

(c) Sheath

(d) Pre-impregnated cable

Section 3 – Underground Cables

Section 3 – Underground Cables

Review questions for Section 3

(e) Mass-impregnated cable

(f) Drain cable

(g) Non-bleeding cable

(h) Bedding

(i) Armour

3. Sketch the construction of a belted cable as used on 11 kV feeders. State the limitation to this type of cable and how has this been overcome for cables used at higher voltages.

Section 3 – Underground Cables

Section 3

1.
 - polyvinyl chloride
 - cross-linked polyvinyl
 - ethylene propylene rubber
 - impregnated paper

The majority of cables used for distribution work are impregnated paper insulated cables with a lead or lead alloy sheath.

2. (a) Conductor screening is used to evenly distribute electrical stress in the surrounding insulation.

Section 3 – Underground Cables

- (b) This consists of layers of paper tapes built up to the required thickness with a gap between each turn to allow for movement of the papers during the bending of the cable.
- (c) Sheath is a protective covering of either extruded lead, lead alloy or aluminium to exclude moisture.
- (d) The paper tapes used for insulation are impregnated before application to the conductors.
- (e) The paper tapes are applied unimpregnated, the complete cable being subsequently dried and impregnated as a whole.
- (f) A mass impregnated cable from which the free impregnated compound is removed by draining at a temperature in excess of the maximum working temperature.
- (g) An impregnated cable which will not exude the impregnated material under working conditions.
- (h) A layer/layers of fibrous material usually permeated with waterproof compound applied to the cable beneath the armouring.
- (i) Galvanised steel wire or steel tapes wound over the bedding on the lead sheath to give mechanical protection to the cable.

3.

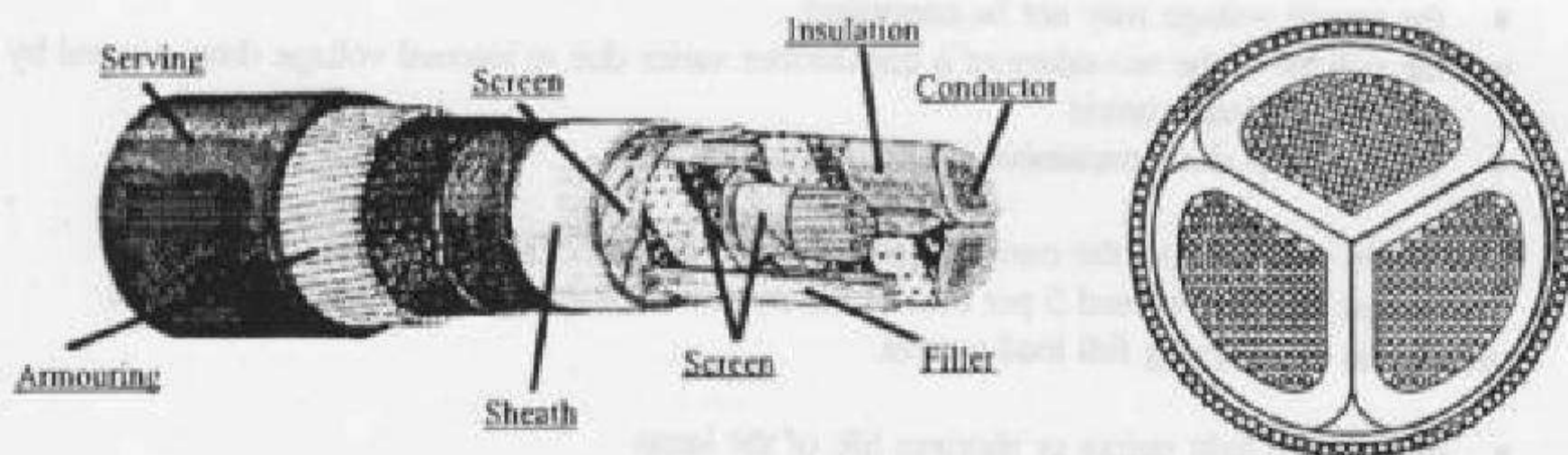

Belted construction tends to fail at about 22 kV due to tangential stress. To overcome this problem, screen cables are used.

Section 3 – Underground Cables

Review questions for Section 3

4. The voltage designation of a distribution cable is given as 6.35/11 kV. State the meaning of each term.

5. Describe the associated precautions in the installation of cables.

6. A 33 kV multicore lead sheathed cable has a minimum bending radius of 18D. State the meaning of this term.

7. Describe briefly the sheath phenomenon. Sketch the sheath eddies where two single core cables are carrying current.

Section 3 – Underground Cables

4. 6.35 - the rated power frequency voltage to earth is 6.35 kV
11 kV - the rated power frequency voltage between conductors is 11 kV.
5.
 - drums of cable must not be dropped
 - drum must always be rolled in the direction of the arrow
 - cables should be installed only when both cable and ambient temperature are above 0°C
 - suitable supports must be used
 - bending radii for paper insulated cable should be as large as possible
 - appropriate method must be used when pulling cables into ducts or trenches
6. 18D - the bending radii must be at least eighteen times the diameter of the overall diameter of the cable.
7. It is the induced electromotive forces in the sheaths of single core cables which might cause heavy current to flow.

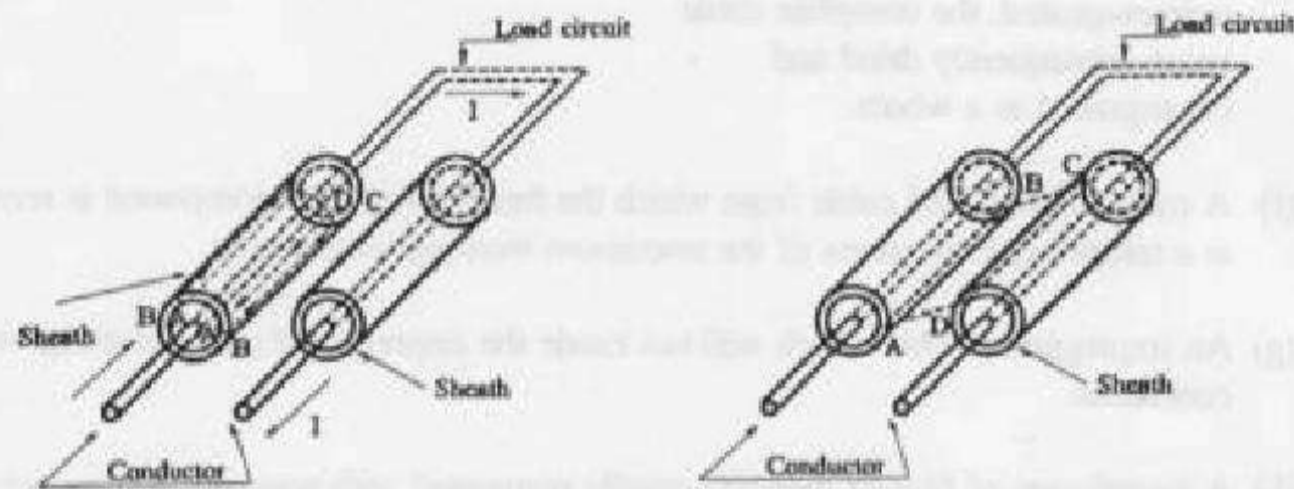

8.
 - the thermal capacity of the cable
 - the depth of burial in the soil
 - the type of soil (eg. sand, clay)

Section 3 – Underground Cables

Review questions for Section 4

1.	Describe briefly the causes of voltage variations	REVIEW YOUR ANSWERS
	<hr/> <hr/> <hr/> <hr/> <hr/>	
2.	State the limit of voltage variation in a distribution system per AS 3000, Part 1 - the SAA Wiring Rules.	
	<hr/> <hr/> <hr/> <hr/> <hr/>	
3.	Describe briefly the effect of voltage variations.	
	<hr/> <hr/> <hr/> <hr/> <hr/>	
4.	State the three general methods of voltage control.	
	<hr/> <hr/> <hr/> <hr/> <hr/>	

Section 3 – Underground Cables

Review questions for Section 4

5. List **five** voltage control devices used in distribution systems.

- _____
- _____
- _____
- _____
- _____

6. Describe the use of voltage profile charts.

REFERENCES

Main text book recommended for 7762AA Electrical Distribution

2832P Distribution and Utilization A

(Published by Department of Technical and Further Education-NSW)

Unit	Contents	Module/ Learning Outcomes
Unit 1 of 2832P	Design concept, character of plant, size and character of load, type of power supply to load, service requirement + 7762AA Module book	7762-AA Learning outcome 1
Unit 2 of 2832P	Transmission line construction Mechanical properties, overhead lines conductors, damper, fitting, insulator, OH line construction and maintenance regulations, sag etc +7762AA Module book	7762AA Learning outcome 2 + Some components of Learning outcome 3
Unit 3 of 2832P	Voltage regulation, control, transformer impedance+7762AA Module book	7762-AA Learning outcome 4

Section 3 – Underground Cables

Australian Standards

AS 1026, 1023, 1034, 1042, 1078, 1117, 1158, 1190, 1202, 1220, 1222, 1243, 1284, 1359, 1360, 1469, 1531, 1675, 1680, 1746, 1767, 1768, 1798, 1824, 1883, 1930, 1931, 2005, 2006, 2184, 2209, 2263, 2264, 2326, 2374, 2421, 3000, 3116, 3274

Other text books

Text book	Learning Outcomes of 7762AA Module
Generation, Transmission and Utilization of Electrical Power By AT Starr	Supporting reference
Basic Training Manual 16-12 Electrical Trades-Cable, conduits, busbar	Some components of Learning outcome 3
Electrical Distribution Engineering (2 nd Ed) by Anthony j Pansini, The Fairmont Press Inc 1991	Support for Learning outcome 1,3
Electrical Power Distribution & Transmission by Luceson Faulkenberry & walter Coffey , Prentice Hall, 1996	Support for Learning outcome 2,
Electrical Power Transmission System- By R Robert Eata & Edward Cohen , Prentice Hall, 1972	Support for Learning outcome 1,2,
Site Surveying & Levelling By John Clancy + Internet downloaded article- Software package for line route survey + Transmission line mechanical design	Survey for transmission line construction site and route + contour map of Learning outcome 2 especially for Line Design Project
Electrical Power Transmission System- By R Robert Eata & Edward Cohen , Prentice Hall, 1972	