

William H. Hayt, Jr. • Jack E. Kemmerly • Steven M. Durbin



# Engineering Circuit Analysis

Eighth Edition

*This page intentionally left blank*

## The Resistor Color Code

Band color	Black	Brown	Red	Orange	Yellow	Green	Blue	Violet	Gray	White
Numeric value	0	1	2	3	4	5	6	7	8	9

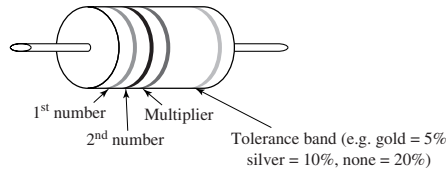

1. Write down the numeric value corresponding to the first band on the left.
2. Write down the numeric value corresponding to the second band from the left.
3. Write down the number of zeros indicated by the multiplier band, which represents a power of 10 (black = no extra zeros, brown = 1 zero, etc.). A gold multiplier band indicates that the decimal is shifted one place to the left; a silver multiplier band indicates that the decimal is shifted two places to the left.
4. The tolerance band represents the precision. So, for example, we would not be surprised to find a 100  $\Omega$  5 percent tolerance resistor that measures anywhere in the range of 95 to 105  $\Omega$ .

### Example

Red Red Orange Gold = 22,000 or  $22 \times 10^3$  = 22 k $\Omega$ , 5% tolerance  
 Blue Gray Gold = 6.8 or  $68 \times 10^{-1}$  = 6.8  $\Omega$ , 20% tolerance

### Standard 5 Percent Tolerance Resistor Values

1.0	1.1	1.2	1.3	1.5	1.6	1.8	2.0	2.2	2.4	2.7	3.0	3.3	3.6	3.9	4.3	4.7	5.1	5.6	6.2	6.8	7.5	8.2	9.1	$\Omega$
10.	11.	12.	13.	15.	16.	18.	20.	22.	24.	27.	30.	33.	36.	39.	43.	47.	51.	56.	62.	68.	75.	82.	91.	$\Omega$
100	110	120	130	150	160	180	200	220	240	270	300	330	360	390	430	470	510	560	620	680	750	820	910	$\Omega$
1.0	1.1	1.2	1.3	1.5	1.6	1.8	2.0	2.2	2.4	2.7	3.0	3.3	3.6	3.9	4.3	4.7	5.1	5.6	6.2	6.8	7.5	8.2	9.1	k $\Omega$
10.	11.	12.	13.	15.	16.	18.	20.	22.	24.	27.	30.	33.	36.	39.	43.	47.	51.	56.	62.	68.	75.	82.	91.	k $\Omega$
100	110	120	130	150	160	180	200	220	240	270	300	330	360	390	430	470	510	560	620	680	750	820	910	k $\Omega$
1.0	1.1	1.2	1.3	1.5	1.6	1.8	2.0	2.2	2.4	2.7	3.0	3.3	3.6	3.9	4.3	4.7	5.1	5.6	6.2	6.8	7.5	8.2	9.1	M $\Omega$

TABLE 14.1 Laplace Transform Pairs

$f(t) = \mathcal{L}^{-1}\{\mathbf{F}(s)\}$	$\mathbf{F}(s) = \mathcal{L}\{f(t)\}$	$f(t) = \mathcal{L}^{-1}\{\mathbf{F}(s)\}$	$\mathbf{F}(s) = \mathcal{L}\{f(t)\}$
$\delta(t)$	1	$\frac{1}{\beta - \alpha}(e^{-\alpha t} - e^{-\beta t})u(t)$	$\frac{1}{(s + \alpha)(s + \beta)}$
$u(t)$	$\frac{1}{s}$	$\sin \omega t u(t)$	$\frac{\omega}{s^2 + \omega^2}$
$tu(t)$	$\frac{1}{s^2}$	$\cos \omega t u(t)$	$\frac{s}{s^2 + \omega^2}$
$\frac{t^{n-1}}{(n-1)!}u(t), n = 1, 2, \dots$	$\frac{1}{s^n}$	$\sin(\omega t + \theta)u(t)$	$\frac{s \sin \theta + \omega \cos \theta}{s^2 + \omega^2}$
$e^{-\alpha t}u(t)$	$\frac{1}{s + \alpha}$	$\cos(\omega t + \theta)u(t)$	$\frac{s \cos \theta - \omega \sin \theta}{s^2 + \omega^2}$
$te^{-\alpha t}u(t)$	$\frac{1}{(s + \alpha)^2}$	$e^{-\alpha t} \sin \omega t u(t)$	$\frac{\omega}{(s + \alpha)^2 + \omega^2}$
$\frac{t^{n-1}}{(n-1)!}e^{-\alpha t}u(t), n = 1, 2, \dots$	$\frac{1}{(s + \alpha)^n}$	$e^{-\alpha t} \cos \omega t u(t)$	$\frac{s + \alpha}{(s + \alpha)^2 + \omega^2}$

TABLE 6.1 Summary of Basic Op Amp Circuits

Name	Circuit Schematic	Input-Output Relation
Inverting Amplifier		$v_{out} = -\frac{R_f}{R_1} v_{in}$
Noninverting Amplifier		$v_{out} = \left(1 + \frac{R_f}{R_1}\right) v_{in}$
Voltage Follower (also known as a Unity Gain Amplifier)		$v_{out} = v_{in}$
Summing Amplifier		$v_{out} = -\frac{R_f}{R} (v_1 + v_2 + v_3)$
Difference Amplifier		$v_{out} = v_2 - v_1$

# ENGINEERING CIRCUIT ANALYSIS

*This page intentionally left blank*

# ENGINEERING CIRCUIT ANALYSIS

EIGHTH EDITION

**William H. Hayt, Jr. (deceased)**

*Purdue University*

**Jack E. Kemmerly (deceased)**

*California State University*

**Steven M. Durbin**

*University at Buffalo*

*The State University of New York*





ENGINEERING CIRCUIT ANALYSIS, EIGHTH EDITION

Published by McGraw-Hill, a business unit of The McGraw-Hill Companies, Inc., 1221 Avenue of the Americas, New York, NY 10020. Copyright © 2012 by The McGraw-Hill Companies, Inc. All rights reserved. Previous editions © 2007, 2002, and 1993. Printed in the United States of America. No part of this publication may be reproduced or distributed in any form or by any means, or stored in a database or retrieval system, without the prior written consent of The McGraw-Hill Companies, Inc., including, but not limited to, in any network or other electronic storage or transmission, or broadcast for distance learning.

Some ancillaries, including electronic and print components, may not be available to customers outside the United States.

This book is printed on acid-free paper.

1 2 3 4 5 6 7 8 9 0 DOW/DOW 1 0 9 8 7 6 5 4 3 2 1

ISBN 978-0-07-352957-8

MHID 0-07-352957-5

Vice President & Editor-in-Chief: *Marty Lange*

Vice President & Director of Specialized Publishing: *Janice M. Roerig-Blong*

Editorial Director: *Michael Lange*

Global Publisher: *Raghothaman Srinivasan*

Senior Marketing Manager: *Curt Reynolds*

Developmental Editor: *Darlene M. Schueller*

Lead Project Manager: *Jane Mohr*

Buyer: *Kara Kudronowicz*

Design Coordinator: *Brenda A. Rolwes*

Senior Photo Research Coordinator: *John C. Leland*

Senior Media Project Manager: *Tammy Juran*

Compositor: *MPS Limited, a Macmillan Company*

Typeface: *10/12 Times Roman*

Printer: *R. R. Donnelley*

Cover Image: © *Getty Images*

Cover Designer: *Studio Montage, St. Louis, Missouri*

MATLAB is a registered trademark of The MathWorks, Inc.

PSpice is a registered trademark of Cadence Design Systems, Inc.

The following photos are courtesy of Steve Durbin: Page 5, Fig. 2.22a, 2.24a–c, 5.34, 6.1a, 7.2a–c, 7.11a–b, 13.15, 17.29

**Library of Congress Cataloging-in-Publication Data**

Hayt, William Hart, 1920–1999

Engineering circuit analysis / William H. Hayt, Jr., Jack E. Kemmerly, Steven M. Durbin. — 8th ed.

p. cm.

Includes index.

ISBN 978-0-07-352957-8

1. Electric circuit analysis. 2. Electric network analysis. I. Kemmerly, Jack E. (Jack Ellsworth), 1924–1998

II. Durbin, Steven M. III. Title.

TK454.H4 2012

621.319'2—dc22

2011009912



*To Sean and Kristi.  
The best part of every day.*

*This page intentionally left blank*

# ABOUT THE AUTHORS

**WILLIAM H. HAYT, Jr.**, received his B.S. and M.S. at Purdue University and his Ph.D. from the University of Illinois. After spending four years in industry, Professor Hayt joined the faculty of Purdue University, where he served as Professor and Head of the School of Electrical Engineering, and as Professor Emeritus after retiring in 1986. Besides *Engineering Circuit Analysis*, Professor Hayt authored three other texts, including *Engineering Electromagnetics*, now in its eighth edition with McGraw-Hill. Professor Hayt's professional society memberships included Eta Kappa Nu, Tau Beta Pi, Sigma Xi, Sigma Delta Chi, Fellow of IEEE, ASEE, and NAEB. While at Purdue, he received numerous teaching awards, including the university's Best Teacher Award. He is also listed in Purdue's Book of Great Teachers, a permanent wall display in the Purdue Memorial Union, dedicated on April 23, 1999. The book bears the names of the inaugural group of 225 faculty members, past and present, who have devoted their lives to excellence in teaching and scholarship. They were chosen by their students and their peers as Purdue's finest educators.

**JACK E. KEMMERLY** received his B.S. magna cum laude from The Catholic University of America, M.S. from University of Denver, and Ph.D. from Purdue University. Professor Kemmerly first taught at Purdue University and later worked as principal engineer at the Aeronutronic Division of Ford Motor Company. He then joined California State University, Fullerton, where he served as Professor, Chairman of the Faculty of Electrical Engineering, Chairman of the Engineering Division, and Professor Emeritus. Professor Kemmerly's professional society memberships included Eta Kappa Nu, Tau Beta Pi, Sigma Xi, ASEE, and IEEE (Senior Member). His pursuits outside of academe included being an officer in the Little League and a scoutmaster in the Boy Scouts.

**STEVEN M. DURBIN** received the B.S., M.S. and Ph.D. degrees in Electrical Engineering from Purdue University, West Lafayette, Indiana. Subsequently, he was with the Department of Electrical Engineering at Florida State University and Florida A&M University before joining the University of Canterbury, New Zealand, in 2000. Since August 2010, he has been with the University at Buffalo, The State University of New York, where he holds a joint appointment between the Departments of Electrical Engineering and Physics. His teaching interests include circuits, electronics, electromagnetics, solid-state electronics and nanotechnology. His research interests are primarily concerned with the development of new semiconductor materials—in particular those based on oxide and nitride compounds—as well as novel optoelectronic device structures. He is a founding principal investigator of the MacDiarmid Institute for Advanced Materials and Nanotechnology, a New Zealand National Centre of Research Excellence, and coauthor of over 100 technical publications. He is a senior member of the IEEE, and a member of Eta Kappa Nu, the Electron Devices Society, the Materials Research Society, the AVS (formerly the American Vacuum Society), the American Physical Society, and the Royal Society of New Zealand.

*This page intentionally left blank*

# BRIEF CONTENTS

PREFACE	xv
1 ● INTRODUCTION	1
2 ● BASIC COMPONENTS AND ELECTRIC CIRCUITS	9
3 ● VOLTAGE AND CURRENT LAWS	39
4 ● BASIC NODAL AND MESH ANALYSIS	79
5 ● HANDY CIRCUIT ANALYSIS TECHNIQUES	123
6 ● THE OPERATIONAL AMPLIFIER	175
7 ● CAPACITORS AND INDUCTORS	217
8 ● BASIC $RL$ AND $RC$ CIRCUITS	261
9 ● THE $RLC$ CIRCUIT	321
10 ● SINUSOIDAL STEADY-STATE ANALYSIS	371
11 ● AC CIRCUIT POWER ANALYSIS	421
12 ● POLYPHASE CIRCUITS	457
13 ● MAGNETICALLY COUPLED CIRCUITS	493
14 ● COMPLEX FREQUENCY AND THE LAPLACE TRANSFORM	533
15 ● CIRCUIT ANALYSIS IN THE $s$ -DOMAIN	571
16 ● FREQUENCY RESPONSE	619
17 ● TWO-PORT NETWORKS	687
18 ● FOURIER CIRCUIT ANALYSIS	733
Appendix 1 AN INTRODUCTION TO NETWORK TOPOLOGY	791
Appendix 2 SOLUTION OF SIMULTANEOUS EQUATIONS	803
Appendix 3 A PROOF OF THÉVENIN'S THEOREM	811
Appendix 4 A PSPICE <sup>®</sup> TUTORIAL	813
Appendix 5 COMPLEX NUMBERS	817
Appendix 6 A BRIEF MATLAB <sup>®</sup> TUTORIAL	827
Appendix 7 ADDITIONAL LAPLACE TRANSFORM THEOREMS	833
INDEX	839

*This page intentionally left blank*

## CHAPTER 1

### INTRODUCTION 1

- 1.1 Overview of Text 2
  - 1.2 Relationship of Circuit Analysis to Engineering 4
  - 1.3 Analysis and Design 5
  - 1.4 Computer-Aided Analysis 6
  - 1.5 Successful Problem-Solving Strategies 7
- READING FURTHER 8

## CHAPTER 2

### BASIC COMPONENTS AND ELECTRIC CIRCUITS 9

- 2.1 Units and Scales 9
  - 2.2 Charge, Current, Voltage, and Power 11
  - 2.3 Voltage and Current Sources 17
  - 2.4 Ohm's Law 22
- SUMMARY AND REVIEW 28
- READING FURTHER 29
- EXERCISES 29

## CHAPTER 3

### VOLTAGE AND CURRENT LAWS 39

- 3.1 Nodes, Paths, Loops, and Branches 39
  - 3.2 Kirchhoff's Current Law 40
  - 3.3 Kirchhoff's Voltage Law 42
  - 3.4 The Single-Loop Circuit 46
  - 3.5 The Single-Node-Pair Circuit 49
  - 3.6 Series and Parallel Connected Sources 51
  - 3.7 Resistors in Series and Parallel 55
  - 3.8 Voltage and Current Division 61
- SUMMARY AND REVIEW 66
- READING FURTHER 67
- EXERCISES 67

## CHAPTER 4

### BASIC NODAL AND MESH ANALYSIS 79

- 4.1 Nodal Analysis 80
- 4.2 The Supernode 89
- 4.3 Mesh Analysis 92
- 4.4 The Supermesh 98

- 4.5 Nodal vs. Mesh Analysis: A Comparison 101
  - 4.6 Computer-Aided Circuit Analysis 103
- SUMMARY AND REVIEW 107
- READING FURTHER 109
- EXERCISES 109

## CHAPTER 5

### HANDY CIRCUIT ANALYSIS TECHNIQUES 123

- 5.1 Linearity and Superposition 123
  - 5.2 Source Transformations 133
  - 5.3 Thévenin and Norton Equivalent Circuits 141
  - 5.4 Maximum Power Transfer 152
  - 5.5 Delta-Wye Conversion 154
  - 5.6 Selecting an Approach: A Summary of Various Techniques 157
- SUMMARY AND REVIEW 158
- READING FURTHER 159
- EXERCISES 159

## CHAPTER 6

### THE OPERATIONAL AMPLIFIER 175

- 6.1 Background 175
  - 6.2 The Ideal Op Amp: A Cordial Introduction 176
  - 6.3 Cascaded Stages 184
  - 6.4 Circuits for Voltage and Current Sources 188
  - 6.5 Practical Considerations 192
  - 6.6 Comparators and the Instrumentation Amplifier 203
- SUMMARY AND REVIEW 206
- READING FURTHER 207
- EXERCISES 208

## CHAPTER 7

### CAPACITORS AND INDUCTORS 217

- 7.1 The Capacitor 217
- 7.2 The Inductor 225
- 7.3 Inductance and Capacitance Combinations 235
- 7.4 Consequences of Linearity 238
- 7.5 Simple Op Amp Circuits with Capacitors 240
- 7.6 Duality 242

- 7.7** Modeling Capacitors and Inductors with PSpice 245  
 SUMMARY AND REVIEW 247  
 READING FURTHER 249  
 EXERCISES 249

## CHAPTER 8

### BASIC *RL* AND *RC* CIRCUITS 261

- 8.1** The Source-Free *RL* Circuit 261  
**8.2** Properties of the Exponential Response 268  
**8.3** The Source-Free *RC* Circuit 272  
**8.4** A More General Perspective 275  
**8.5** The Unit-Step Function 282  
**8.6** Driven *RL* Circuits 286  
**8.7** Natural and Forced Response 289  
**8.8** Driven *RC* Circuits 295  
**8.9** Predicting the Response of Sequentially Switched Circuits 300  
 SUMMARY AND REVIEW 306  
 READING FURTHER 308  
 EXERCISES 309

## CHAPTER 9

### THE *RLC* CIRCUIT 321

- 9.1** The Source-Free Parallel Circuit 321  
**9.2** The Overdamped Parallel *RLC* Circuit 326  
**9.3** Critical Damping 334  
**9.4** The Underdamped Parallel *RLC* Circuit 338  
**9.5** The Source-Free Series *RLC* Circuit 345  
**9.6** The Complete Response of the *RLC* Circuit 351  
**9.7** The Lossless *LC* Circuit 359  
 SUMMARY AND REVIEW 361  
 READING FURTHER 363  
 EXERCISES 363

## CHAPTER 10

### SINUSOIDAL STEADY-STATE ANALYSIS 371

- 10.1** Characteristics of Sinusoids 371  
**10.2** Forced Response to Sinusoidal Functions 374  
**10.3** The Complex Forcing Function 378  
**10.4** The Phasor 383  
**10.5** Impedance and Admittance 389  
**10.6** Nodal and Mesh Analysis 394  
**10.7** Superposition, Source Transformations and Thévenin's Theorem 397  
**10.8** Phasor Diagrams 406

- SUMMARY AND REVIEW 409  
 READING FURTHER 410  
 EXERCISES 410

## CHAPTER 11

### AC CIRCUIT POWER ANALYSIS 421

- 11.1** Instantaneous Power 422  
**11.2** Average Power 424  
**11.3** Effective Values of Current and Voltage 433  
**11.4** Apparent Power and Power Factor 438  
**11.5** Complex Power 441  
 SUMMARY AND REVIEW 447  
 READING FURTHER 449  
 EXERCISES 449

## CHAPTER 12

### POLYPHASE CIRCUITS 457

- 12.1** Polyphase Systems 458  
**12.2** Single-Phase Three-Wire Systems 460  
**12.3** Three-Phase Y-Y Connection 464  
**12.4** The Delta ( $\Delta$ ) Connection 470  
**12.5** Power Measurement in Three-Phase Systems 476  
 SUMMARY AND REVIEW 484  
 READING FURTHER 486  
 EXERCISES 486

## CHAPTER 13

### MAGNETICALLY COUPLED CIRCUITS 493

- 13.1** Mutual Inductance 493  
**13.2** Energy Considerations 501  
**13.3** The Linear Transformer 505  
**13.4** The Ideal Transformer 512  
 SUMMARY AND REVIEW 522  
 READING FURTHER 523  
 EXERCISES 523

## CHAPTER 14

### COMPLEX FREQUENCY AND THE LAPLACE TRANSFORM 533

- 14.1** Complex Frequency 533  
**14.2** The Damped Sinusoidal Forcing Function 537  
**14.3** Definition of the Laplace Transform 540  
**14.4** Laplace Transforms of Simple Time Functions 543  
**14.5** Inverse Transform Techniques 546  
**14.6** Basic Theorems for the Laplace Transform 553



- 14.7** The Initial-Value and Final-Value Theorems 561  
 SUMMARY AND REVIEW 564  
 READING FURTHER 565  
 EXERCISES 565

## CHAPTER 15

### CIRCUIT ANALYSIS IN THE s-DOMAIN 571

- 15.1**  $Z(s)$  and  $Y(s)$  571  
**15.2** Nodal and Mesh Analysis in the s-Domain 578  
**15.3** Additional Circuit Analysis Techniques 585  
**15.4** Poles, Zeros, and Transfer Functions 588  
**15.5** Convolution 589  
**15.6** The Complex-Frequency Plane 598  
**15.7** Natural Response and the s Plane 602  
**15.8** A Technique for Synthesizing the Voltage Ratio  
 $H(s) = V_{\text{out}}/V_{\text{in}}$  606  
 SUMMARY AND REVIEW 610  
 READING FURTHER 612  
 EXERCISES 612

## CHAPTER 16

### FREQUENCY RESPONSE 619

- 16.1** Parallel Resonance 619  
**16.2** Bandwidth and High- $Q$  Circuits 627  
**16.3** Series Resonance 633  
**16.4** Other Resonant Forms 637  
**16.5** Scaling 644  
**16.6** Bode Diagrams 648  
**16.7** Basic Filter Design 664  
**16.8** Advanced Filter Design 672  
 SUMMARY AND REVIEW 677  
 READING FURTHER 679  
 EXERCISES 679

## CHAPTER 17

### TWO-PORT NETWORKS 687

- 17.1** One-Port Networks 687  
**17.2** Admittance Parameters 692  
**17.3** Some Equivalent Networks 699  
**17.4** Impedance Parameters 708  
**17.5** Hybrid Parameters 713  
**17.6** Transmission Parameters 716  
 SUMMARY AND REVIEW 720  
 READING FURTHER 721  
 EXERCISES 722

## CHAPTER 18

### FOURIER CIRCUIT ANALYSIS 733

- 18.1** Trigonometric Form of the Fourier Series 733  
**18.2** The Use of Symmetry 743  
**18.3** Complete Response to Periodic Forcing Functions 748  
**18.4** Complex Form of the Fourier Series 750  
**18.5** Definition of the Fourier Transform 757  
**18.6** Some Properties of the Fourier Transform 761  
**18.7** Fourier Transform Pairs for Some Simple Time Functions 764  
**18.8** The Fourier Transform of a General Periodic Time Function 769  
**18.9** The System Function and Response in the Frequency Domain 770  
**18.10** The Physical Significance of the System Function 777  
 SUMMARY AND REVIEW 782  
 READING FURTHER 783  
 EXERCISES 783

### APPENDIX 1 AN INTRODUCTION TO NETWORK TOPOLOGY 791

### APPENDIX 2 SOLUTION OF SIMULTANEOUS EQUATIONS 803

### APPENDIX 3 A PROOF OF THÉVENIN'S THEOREM 811

### APPENDIX 4 A PSPICE® TUTORIAL 813

### APPENDIX 5 COMPLEX NUMBERS 817

### APPENDIX 6 A BRIEF MATLAB® TUTORIAL 827

### APPENDIX 7 ADDITIONAL LAPLACE TRANSFORM THEOREMS 833

### INDEX 839

*This page intentionally left blank*

The target audience colors everything about a book, being a major factor in decisions big and small, particularly both the pace and the overall writing style. Consequently it is important to note that the authors have made the conscious decision to write this book to the **student**, and not to the instructor. Our underlying philosophy is that reading the book should be enjoyable, despite the level of technical detail that it must incorporate. When we look back to the very first edition of *Engineering Circuit Analysis*, it's clear that it was developed specifically to be more of a conversation than a dry, dull discourse on a prescribed set of fundamental topics. To keep it conversational, we've had to work hard at updating the book so that it continues to speak to the increasingly diverse group of students using it all over the world.

Although in many engineering programs the introductory circuits course is preceded or accompanied by an introductory physics course in which electricity and magnetism are introduced (typically from a fields perspective), this is not required to use this book. After finishing the course, many students find themselves truly amazed that such a broad set of analytical tools have been derived from **only three simple scientific laws**—Ohm's law and Kirchhoff's voltage and current laws. The first six chapters assume only a familiarity with algebra and simultaneous equations; subsequent chapters assume a first course in calculus (derivatives and integrals) is being taken in tandem. Beyond that, we have tried to incorporate sufficient details to allow the book to be read on its own.

*So, what key features have been designed into this book with the student in mind?* First, individual chapters are organized into relatively short subsections, each having a single primary topic. The language has been updated to remain informal and to flow smoothly. Color is used to highlight important information as opposed to merely improve the aesthetics of the page layout, and white space is provided for jotting down short notes and questions. New terms are defined as they are introduced, and examples are placed strategically to demonstrate not only basic concepts, but problem-solving approaches as well. Practice problems relevant to the examples are placed in proximity so that students can try out the techniques for themselves before attempting the end-of-chapter exercises. The exercises represent a broad range of difficulties, generally ordered from simpler to more complex, and grouped according to the relevant section of each chapter. Answers to selected odd-numbered end-of-chapter exercises are posted on the book's website at [www.mhhe.com/haytdurbin8e](http://www.mhhe.com/haytdurbin8e).

Engineering is an intensive subject to study, and students often find themselves faced with deadlines and serious workloads. This does not mean that textbooks have to be dry and pompous, however, or that coursework should never contain any element of fun. In fact, successfully solving a problem often *is* fun, and learning how to do that can be fun as well. Determining how

to best accomplish this within the context of a textbook is an ongoing process. The authors have always relied on the often very candid feedback received from our own students at Purdue University; the California State University, Fullerton; Fort Lewis College in Durango, the joint engineering program at Florida A&M University and Florida State University, the University of Canterbury (New Zealand) and the University at Buffalo. We also rely on comments, corrections, and suggestions from instructors and students worldwide, and for this edition, consideration has been given to a new source of comments, namely, semianonymous postings on various websites.

The first edition of *Engineering Circuit Analysis* was written by Bill Hayt and Jack Kemmerly, two engineering professors who very much enjoyed teaching, interacting with their students, and training generations of future engineers. It was well received due to its compact structure, “to the point” informal writing style, and logical organization. There is no timidity when it comes to presenting the theory underlying a specific topic, or pulling punches when developing mathematical expressions. Everything, however, was carefully designed to assist students in their learning, present things in a straightforward fashion, and leave theory for theory’s sake to other books. They clearly put a great deal of thought into writing the book, and their enthusiasm for the subject comes across to the reader.

## KEY FEATURES OF THE EIGHTH EDITION

We have taken great care to retain key features from the seventh edition which were clearly working well. These include the general layout and sequence of chapters, the basic style of both the text and line drawings, the use of four-color printing where appropriate, numerous worked examples and related practice problems, and grouping of end-of-chapter exercises according to section. Transformers continue to merit their own chapter, and complex frequency is briefly introduced through a student-friendly extension of the phasor technique, instead of indirectly by merely stating the Laplace transform integral. We also have retained the use of icons, an idea first introduced in the sixth edition:



Provides a heads-up to common mistakes;



Indicates a point that’s worth noting;



Denotes a design problem to which there is no unique answer;



Indicates a problem which requires computer-aided analysis.

The introduction of engineering-oriented analysis and design software in the book has been done with the mind-set that it should assist, not replace, the learning process. Consequently, the computer icon denotes problems that are typically phrased such that the software is used to *verify* answers, and not simply provide them. Both MATLAB<sup>®</sup> and PSpice<sup>®</sup> are used in this context.

## SPECIFIC CHANGES FOR THE EIGHTH EDITION INCLUDE:

---

- A new section in Chapter 16 on the analysis and design of multistage Butterworth filters
- Over 1000 new and revised end-of-chapter exercises
- A new overarching philosophy on end-of-chapter exercises, with each section containing problems similar to those solved in worked examples and practice problems, before proceeding to more complex problems to test the reader's skills
- Introduction of Chapter-Integrating Exercises at the end of each chapter. For the convenience of instructors and students, end-of-chapter exercises are grouped by section. To provide the opportunity for assigning exercises with less emphasis on an explicit solution method (for example, mesh or nodal analysis), as well as to give a broader perspective on key topics within each chapter, a select number of Chapter-Integrating Exercises appear at the end of each chapter.
- New photos, many in full color, to provide connection to the real world
- Updated screen captures and text descriptions of computer-aided analysis software
- New worked examples and practice problems
- Updates to the Practical Application feature, introduced to help students connect material in each chapter to broader concepts in engineering. Topics include distortion in amplifiers, modeling automotive suspension systems, practical aspects of grounding, the relationship of poles to stability, resistivity, and the memristor, sometimes called “the missing element”
- Streamlining of text, especially in the worked examples, to get to the point faster
- Answers to selected odd-numbered end-of-chapter exercises are posted on the book's website at [www.mhhe.com/haytdurbin8e](http://www.mhhe.com/haytdurbin8e).

I joined the book in 1999, and sadly never had the opportunity to speak to either Bill or Jack about the revision process, although I count myself lucky to have taken a circuits course from Bill Hayt while I was a student at Purdue. It is a distinct privilege to serve as a coauthor to *Engineering Circuit Analysis*, and in working on this book I give its fundamental philosophy and target audience the highest priority. I greatly appreciate the many people who have already provided feedback—both positive and negative—on aspects of previous editions, and welcome others to do so as well, either through the publishers (McGraw-Hill Higher Education) or to me directly ([durbin@ieee.org](mailto:durbin@ieee.org)).

Of course, this project has been a team effort, as is the case with every modern textbook. In particular I would like to thank Raghu Srinivasan (Global Publisher), Peter Massar (Sponsoring Editor), Curt Reynolds (Marketing Manager), Jane Mohr (Project Manager), Brittney-Corrigan-McElroy (Project Manager), Brenda Rolwes (Designer), Tammy Juran (Media Project Manager), and most importantly, Developmental Editor Darlene Schueller, who helped me with many, many details, issues, deadlines,

and questions. She is absolutely the best, and I'm very grateful for all the support from the team at McGraw-Hill. I would also like to thank various McGraw-Hill representatives, especially Nazier Hassan, who dropped by whenever on campus to just say hello and ask how things were going. Special thanks are also due to Catherine Shultz and Michael Hackett, former editors who continue to keep in contact. Cadence® and The MathWorks kindly provided assistance with software-aided analysis software, which was much appreciated. Several colleagues have generously supplied or helped with photographs and technical details, for which I'm very grateful: Prof. Masakazu Kobayashi of Waseda University; Dr. Wade Enright, Prof. Pat Bodger, Prof. Rick Millane, Mr. Gary Turner, and Prof. Richard Blaikie of the University of Canterbury; and Prof. Reginald Perry and Prof. Jim Zheng of Florida A&M University and the Florida State University. For the eighth edition, the following individuals deserve acknowledgment and a debt of gratitude for taking the time to review various versions of the manuscript:

Chong Koo An, *The University of Ulsan*

Mark S. Andersland, *The University of Iowa*

Marc Cahay, *University of Cincinnati*

Claudio Canizares, *University of Waterloo*

Teerapon Dachokiatawan, *King Mongkut's University of Technology North Bangkok*

John Durkin, *The University of Akron*

Lauren M. Fuentes, *Durham College*

Lalit Goel, *Nanyang Technological University*

Rudy Hofer, *Conestoga College ITAL*

Mark Jerabek, *West Virginia University*

Michael Kelley, *Cornell University*

Hua Lee, *University of California, Santa Barbara*

Georges Livanos, *Humber College Institute of Technology*

Ahmad Nafisi, *Cal Poly State University*

Arnost Neugroschel, *University of Florida*

Pravin Patel, *Durham College*

Jamie Phillips, *The University of Michigan*

Daryl Reynolds, *West Virginia University*

G.V.K.R. Sastry, *Andhra University*

Michael Scordilis, *University of Miami*

Yu Sun, *University of Toronto, Canada*

Chanchana Tangwongsan, *Chulalongkorn University*

Edward Wheeler, *Rose-Hulman Institute of Technology*

Xiao-Bang Xu, *Clemson University*

Tianyu Yang, *Embry-Riddle Aeronautical University*

Zivan Zabar, *Polytechnic Institute of NYU*

I would also like to thank Susan Lord, *University of San Diego*, Archie L. Holmes, Jr., *University of Virginia*, Arnost Neugroschel, *University of Florida*, and Michael Scordilis, *University of Miami*, for their assistance in accuracy checking answers to selected end-of-chapter exercises.

Finally, I would like to briefly thank a number of other people who have contributed both directly and indirectly to the eighth edition. First and foremost, my wife, Kristi, and our son, Sean, for their patience, understanding, support, welcome distractions, and helpful advice. Throughout the day it has always been a pleasure to talk to friends and colleagues about what should be taught, how it should be taught, and how to measure learning. In particular, Martin Allen, Richard Blaikie, Alex Cartwright, Peter Cottrell, Wade Enright, Jeff Gray, Mike Hayes, Bill Kennedy, Susan Lord, Philippa Martin, Theresa Mayer, Chris McConville, Reginald Perry, Joan Redwing, Roger Reeves, Dick Schwartz, Leonard Tung, Jim Zheng, and many others have provided me with many useful insights, as has my father, Jesse Durbin, an electrical engineering graduate of the Indiana Institute of Technology.

**Steven M. Durbin**  
*Buffalo, New York*

## McGraw-Hill Digital Offerings Include:

### McGraw-Hill Connect™ Engineering

McGraw-Hill Connect Engineering is a web-based assignment and assessment platform that gives students the means to better connect with their coursework, with their instructors, and with the important concepts that they will need to know for success now and in the future. With Connect Engineering, instructors can deliver assignments, quizzes, and tests easily online. Students can practice important skills at their own pace and on their own schedule. Ask your McGraw-Hill representative for more details and check it out at [www.mcgrawhillconnect.com/engineering](http://www.mcgrawhillconnect.com/engineering).

Instructor support materials are available from the book's website at [www.mhhe.com/haytdurbin8e](http://www.mhhe.com/haytdurbin8e). The materials include a password-protected solutions manual and image library. Instructors can also benefit from McGraw-Hill's Complete Online Solutions Manual Organization System (COSMOS). COSMOS enables instructors to generate a limitless supply of problem material for assignments, as well as transfer and integrate their own problems into the software. Contact your McGraw-Hill sales representative for additional information.



### McGraw-Hill Create™

Craft your teaching resources to match the way you teach! With McGraw-Hill Create, [www.mcgrawhillcreate.com](http://www.mcgrawhillcreate.com), you can easily rearrange chapters, combine material from other content sources, and quickly upload content you have written such as your course syllabus or teaching notes. Find the content you need in Create by searching through thousands of leading McGraw-Hill textbooks. Arrange your book to fit your teaching style. Create even allows you to personalize your book's appearance by selecting the cover and adding your name, school, and course information. Order a Create book and you'll receive a complimentary print review copy in 3–5 business days or a complimentary electronic review copy (eComp) via email in minutes. Go to [www.mcgrawhillcreate.com](http://www.mcgrawhillcreate.com) today and register to experience how McGraw-Hill Create empowers you to teach *your* students *your* way.



Do More

### McGraw-Hill Higher Education and Blackboard® Have Teamed Up.

Blackboard, the web-based course management system, has partnered with McGraw-Hill to better allow students and faculty to use online materials and activities to complement face-to-face teaching. Blackboard features exciting social learning and teaching tools that foster more logical, visually



impactful, and active learning opportunities for students. You'll transform your closed-door classrooms into communities where students remain connected to their educational experience 24 hours a day.

This partnership allows you and your students access to McGraw-Hill's Connect™ and Create™ right from within your Blackboard course—all with one single sign-on.

Not only do you get single sign-on with Connect and Create, you also get deep integration of McGraw-Hill content and content engines right in Blackboard. Whether you're choosing a book for your course or building Connect assignments, all the tools you need are right where you want them—inside of Blackboard.

Gradebooks are now seamless. When a student completes an integrated Connect assignment, the grade for that assignment automatically (and instantly) feeds your Blackboard grade center.

McGraw-Hill and Blackboard can now offer you easy access to industry leading technology and content, whether your campus hosts it or we do. Be sure to ask your local McGraw-Hill representative for details.

## Electronic Textbook Option

This text is offered through CourseSmart for both instructors and students. CourseSmart is an online resource where students can purchase the complete text online at almost half the cost of a traditional text. Purchasing the eTextbook allows students to take advantage of CourseSmart's web tools for learning, which include full text search, notes and highlighting, and email tools for sharing notes between classmates. To learn more about CourseSmart options, contact your sales representative or visit [www.CourseSmart.com](http://www.CourseSmart.com).

*This page intentionally left blank*

# Introduction

## PREAMBLE

Although there are clear specialties within the field of engineering, all engineers share a considerable amount of common ground, particularly when it comes to problem solving. In fact, many practicing engineers find it is possible to work in a large variety of settings and even outside their traditional specialty, as their skill set is often transferrable to other environments. Today's engineering graduates are employed in a broad range of jobs, from design of individual components and systems, to assisting in solving socio-economic problems such as air and water pollution, urban planning, communication, mass transportation, power generation and distribution, and efficient use and conservation of natural resources.

Circuit analysis has long been a traditional introduction to **the art of problem solving** from an engineering perspective, even for those whose interests lie outside electrical engineering. There are many reasons for this, but one of the best is that in today's world it's extremely unlikely for any engineer to encounter a system that does not in some way include electrical circuitry. As circuits become smaller and require less power, and power sources become smaller and cheaper, embedded circuits are seemingly everywhere. Since most engineering situations require a team effort at some stage, having a working knowledge of circuit analysis therefore helps to provide everyone on a project with the background needed for effective communication.

Consequently, this book is not just about "circuit analysis" from an engineering perspective, but is also about developing basic problem-solving skills as they apply to situations an engineer is likely to encounter. As part of this, we also find that we're developing an intuitive understanding at a general level, and often we can

## KEY CONCEPTS

Linear versus Nonlinear Circuits

Four Main Categories of Circuit Analysis:

- DC Analysis
- Transient Analysis
- Sinusoidal Analysis
- Frequency Response

Circuit Analysis Beyond Circuits

Analysis and Design

Use of Engineering Software

A Problem-Solving Strategy



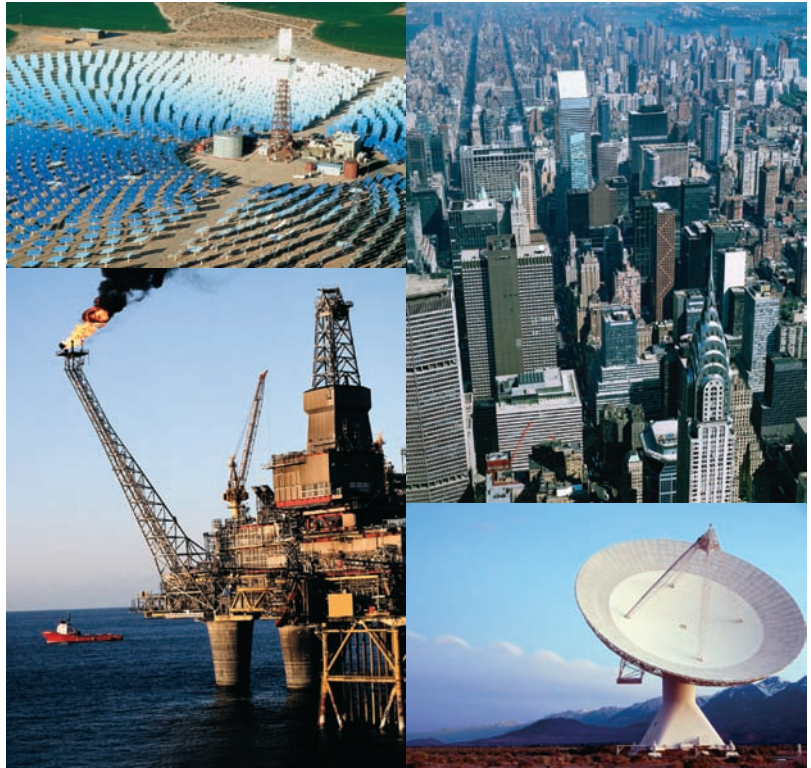

Not all electrical engineers routinely make use of circuit analysis, but they often bring to bear analytical and problem-solving skills learned early on in their careers. A circuit analysis course is one of the first exposures to such concepts. (*Solar Mirrors*: © Corbis; *Skyline*: © Getty Images/PhotoLink; *Oil Rig*: © Getty Images; *Dish*: © Getty Images/J. Luke/PhotoLink)

understand a complex system by its analogy to an electrical circuit. Before launching into all this, however, we'll begin with a quick preview of the topics found in the remainder of the book, pausing briefly to ponder the difference between analysis and design, and the evolving role computer tools play in modern engineering.

## 1.1 OVERVIEW OF TEXT

The fundamental subject of this text is *linear circuit analysis*, which sometimes prompts a few readers to ask,

“Is there ever any *nonlinear* circuit analysis?”

Sure! We encounter nonlinear circuits every day: they capture and decode signals for our TVs and radios, perform calculations millions of times a second inside microprocessors, convert speech into electrical signals for transmission over phone lines, and execute many other functions outside our field of view. In designing, testing, and implementing such nonlinear circuits, detailed analysis is unavoidable.

“Then why study *linear* circuit analysis?”

you might ask. An excellent question. The simple fact of the matter is that no physical system (including electrical circuits) is ever perfectly linear. Fortunately for us, however, a great many systems behave in a reasonably



Television sets include many nonlinear circuits. A great deal of them, however, can be understood and analyzed with the assistance of linear models. (© Sony Electronics, Inc.)

linear fashion over a limited range—allowing us to model them as linear systems if we keep the range limitations in mind.

For example, consider the common function

$$f(x) = e^x$$

A linear approximation to this function is

$$f(x) \approx 1 + x$$

Let's test this out. Table 1.1 shows both the exact value and the approximate value of  $f(x)$  for a range of  $x$ . Interestingly, the linear approximation is exceptionally accurate up to about  $x = 0.1$ , when the relative error is still less than 1%. Although many engineers are rather quick on a calculator, it's hard to argue that any approach is faster than just adding 1.

**TABLE 1.1 Comparison of a Linear Model for  $e^x$  to Exact Value**

$x$	$f(x)^*$	$1 + x$	Relative error**
0.0001	1.0001	1.0001	0.0000005%
0.001	1.0010	1.001	0.00005%
0.01	1.0101	1.01	0.005%
0.1	1.1052	1.1	0.5%
1.0	2.7183	2.0	26%

\*Quoted to four significant figures.

\*\*Relative error  $\triangleq \left| 100 \times \frac{e^x - (1+x)}{e^x} \right|$

Linear problems are inherently more easily solved than their nonlinear counterparts. For this reason, we often seek reasonably accurate linear approximations (or *models*) to physical situations. Furthermore, the linear models are more easily manipulated and understood—making design a more straightforward process.

The circuits we will encounter in subsequent chapters all represent linear approximations to physical electric circuits. Where appropriate, brief discussions of potential inaccuracies or limitations to these models are provided, but generally speaking we find them to be suitably accurate for most applications. When greater accuracy is required in practice, nonlinear models are employed, but with a considerable increase in solution complexity. A detailed discussion of what constitutes a *linear electric circuit* can be found in Chap. 2.

Linear circuit analysis can be separated into four broad categories: (1) *dc analysis*, where the energy sources do not change with time; (2) *transient analysis*, where things often change quickly; (3) *sinusoidal analysis*, which applies to both ac power and signals; and (4) *frequency response*, which is the most general of the four categories, but typically assumes something is changing with time. We begin our journey with the topic of resistive circuits, which may include simple examples such as a flashlight or a toaster. This provides us with a perfect opportunity to learn a number of very powerful engineering circuit analysis techniques, such as *nodal analysis*, *mesh analysis*, *superposition*, *source transformation*, *Thévenin's theorem*, *Norton's*



Modern trains are powered by electric motors. Their electrical systems are best analyzed using ac or phasor analysis techniques. (Used with permission. Image copyright © 2010 M. Kobayashi. All rights reserved.)



Frequency-dependent circuits lie at the heart of many electronic devices, and they can be a great deal of fun to design. (© The McGraw-Hill Companies, Inc.)

*theorem*, and several methods for simplifying networks of components connected in series or parallel. The single most redeeming feature of resistive circuits is that the time dependence of any quantity of interest does not affect our analysis procedure. In other words, if asked for an electrical quantity of a resistive circuit at several specific instants in time, we do not need to analyze the circuit more than once. As a result, we will spend most of our effort early on considering only dc circuits—those circuits whose electrical parameters do not vary with time.

Although dc circuits such as flashlights or automotive rear window defoggers are undeniably important in everyday life, things are often much more interesting when something happens suddenly. In circuit analysis parlance, we refer to *transient analysis* as the suite of techniques used to study circuits which are suddenly energized or de-energized. To make such circuits interesting, we need to add elements that respond to the rate of change of electrical quantities, leading to circuit equations which include derivatives and integrals. Fortunately, we can obtain such equations using the simple techniques learned in the first part of our study.

Still, not all time-varying circuits are turned on and off suddenly. Air conditioners, fans, and fluorescent lights are only a few of the many examples we may see daily. In such situations, a calculus-based approach for every analysis can become tedious and time-consuming. Fortunately, there is a better alternative for situations where equipment has been allowed to run long enough for transient effects to die out, and this is commonly referred to as ac or sinusoidal analysis, or sometimes *phasor analysis*.

The final leg of our journey deals with a subject known as *frequency response*. Working directly with the differential equations obtained in time-domain analysis helps us develop an intuitive understanding of the operation of circuits containing energy storage elements (e.g., capacitors and inductors). As we shall see, however, circuits with even a relatively small number of components can be somewhat onerous to analyze, and so much more straightforward methods have been developed. These methods, which include Laplace and Fourier analysis, allow us to transform differential equations into algebraic equations. Such methods also enable us to design circuits to respond in specific ways to particular frequencies. We make use of frequency-dependent circuits every day when we dial a telephone, select our favorite radio station, or connect to the Internet.

## 1.2 RELATIONSHIP OF CIRCUIT ANALYSIS TO ENGINEERING

Whether we intend to pursue further circuit analysis at the completion of this course or not, it is worth noting that there are several layers to the concepts under study. Beyond the nuts and bolts of circuit analysis techniques lies the opportunity to develop a methodical approach to problem solving, the ability to determine the goal or goals of a particular problem, skill at collecting the information needed to effect a solution, and, perhaps equally importantly, opportunities for practice at verifying solution accuracy.

Students familiar with the study of other engineering topics such as fluid flow, automotive suspension systems, bridge design, supply chain management, or process control will recognize the general form of many of the



A molecular beam epitaxy crystal growth facility. The equations governing its operation closely resemble those used to describe simple linear circuits.

equations we develop to describe the behavior of various circuits. We simply need to learn how to “translate” the relevant variables (for example, replacing *voltage* with *force*, *charge* with *distance*, *resistance* with *friction coefficient*, etc.) to find that we already know how to work a new type of problem. Very often, if we have previous experience in solving a similar or related problem, our intuition can guide us through the solution of a totally new problem.

What we are about to learn regarding linear circuit analysis forms the basis for many subsequent electrical engineering courses. The study of electronics relies on the analysis of circuits with devices known as diodes and transistors, which are used to construct power supplies, amplifiers, and digital circuits. The skills which we will develop are typically applied in a rapid, methodical fashion by electronics engineers, who sometimes can analyze a complicated circuit without even reaching for a pencil! The time-domain and frequency-domain chapters of this text lead directly into discussions of signal processing, power transmission, control theory, and communications. We find that frequency-domain analysis in particular is an extremely powerful technique, easily applied to any physical system subjected to time-varying excitation, and particularly helpful in the design of filters.

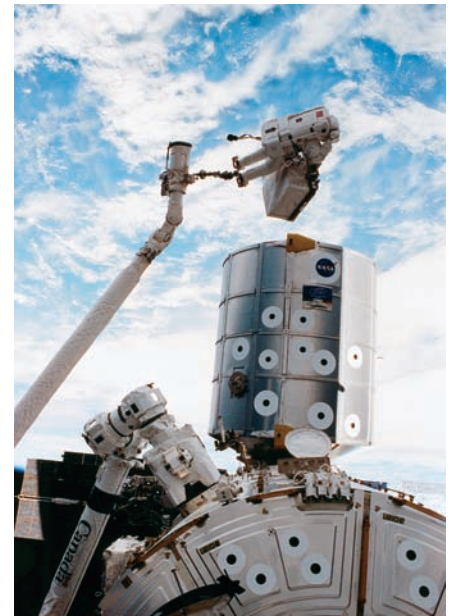

An example of a robotic manipulator. The feedback control system can be modeled using linear circuit elements to determine situations in which the operation may become unstable. (NASA Marshall Space Flight Center.)

### 1.3 ANALYSIS AND DESIGN

Engineers take a fundamental understanding of scientific principles, combine this with practical knowledge often expressed in mathematical terms, and (frequently with considerable creativity) arrive at a solution to a given problem. **Analysis** is the process through which we determine the scope of a problem, obtain the information required to understand it, and compute the parameters of interest. **Design** is the process by which we synthesize something new as part of the solution to a problem. Generally speaking, there is an expectation that a problem requiring design will have no unique solution, whereas the analysis phase typically will. Thus, the last step in designing is always analyzing the result to see if it meets specifications.

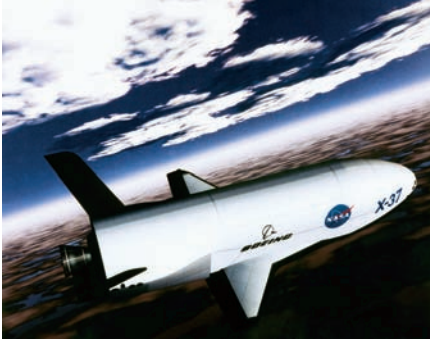

Two proposed designs for a next-generation space shuttle. Although both contain similar elements, each is unique. (NASA Dryden Flight Research Center.)

This text is focused on developing our ability to analyze and solve problems because it is the starting point in every engineering situation. The philosophy of this book is that we need clear explanations, well-placed examples, and plenty of practice to develop such an ability. Therefore, elements of design are integrated into end-of-chapter problems and later chapters so as to be enjoyable rather than distracting.

## 1.4 COMPUTER-AIDED ANALYSIS

Solving the types of equations that result from circuit analysis can often become notably cumbersome for even moderately complex circuits. This of course introduces an increased probability that errors will be made, in addition to considerable time in performing the calculations. The desire to find a tool to help with this process actually predates electronic computers, with purely mechanical computers such as the Analytical Engine designed by Charles Babbage in the 1880s proposed as possible solutions. Perhaps the earliest successful electronic computer designed for solution of differential equations was the 1940s-era ENIAC, whose vacuum tubes filled a large room. With the advent of low-cost desktop computers, however, computer-aided circuit analysis has developed into an invaluable everyday tool which has become an integral part of not only analysis but design as well.

One of the most powerful aspects of computer-aided design is the relatively recent integration of multiple programs in a fashion transparent to the user. This allows the circuit to be drawn schematically on the screen, reduced automatically to the format required by an analysis program (such as SPICE, introduced in Chap. 4), and the resulting output smoothly transferred to a third program capable of plotting various electrical quantities of

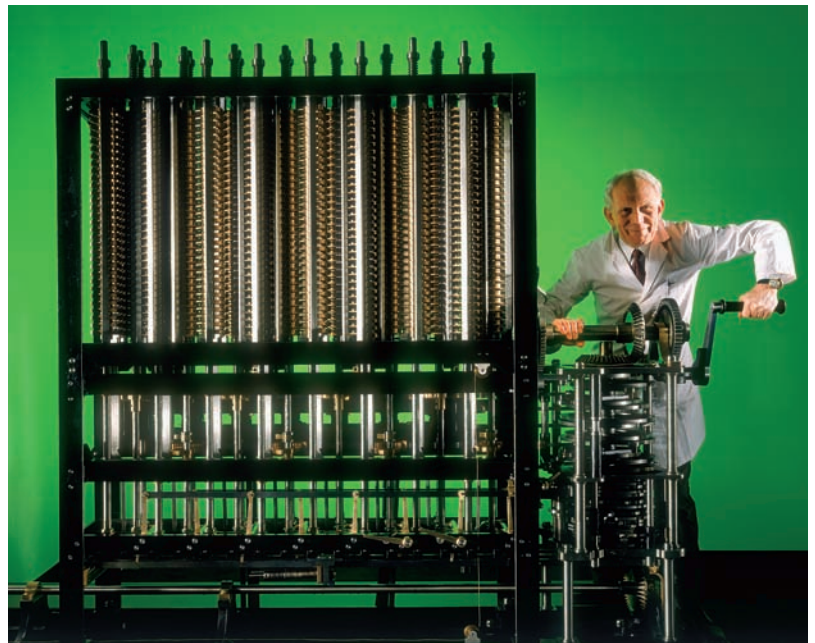

Charles Babbage's "Difference Engine Number 2," as completed by the Science Museum (London) in 1991. (© Science Museum/Science & Society Picture Library.)



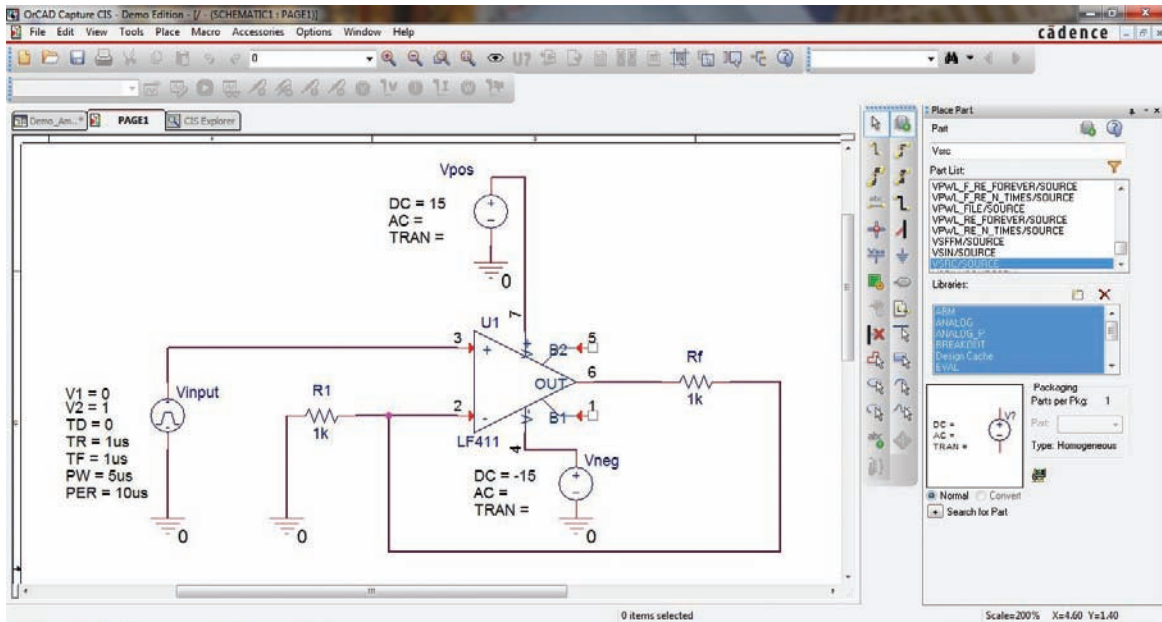

An amplifier circuit drawn using a commercial schematic capture software package.

interest that describe the operation of the circuit. Once the engineer is satisfied with the simulated performance of the design, the same software can generate the printed circuit board layout using geometrical parameters in the components library. This level of integration is continually increasing, to the point where soon an engineer will be able to draw a schematic, click a few buttons, and walk to the other side of the table to pick up a manufactured version of the circuit, ready to test!

The reader should be wary, however, of one thing. Circuit analysis software, although fun to use, is by no means a replacement for good old-fashioned paper-and-pencil analysis. We need to have a solid understanding of how circuits work in order to develop an ability to design them. Simply going through the motions of running a particular software package is a little like playing the lottery: with user-generated entry errors, hidden default parameters in the myriad of menu choices, and the occasional shortcoming of human-written code, there is no substitute for having at least an approximate idea of the expected behavior of a circuit. Then, if the simulation result does not agree with expectations, we can find the error early, rather than after it's too late.

Still, computer-aided analysis is a powerful tool. It allows us to vary parameter values and evaluate the change in circuit performance, and to consider several variations to a design in a straightforward manner. The result is a reduction of repetitive tasks, and more time to concentrate on engineering details.

## 1.5 SUCCESSFUL PROBLEM-SOLVING STRATEGIES

As the reader might have picked up, this book is just as much about problem solving as it is about circuit analysis. As a result, the expectation is that during your time as an engineering student, you are learning how to solve problems—so just at this moment, those skills are not yet fully developed. As you proceed

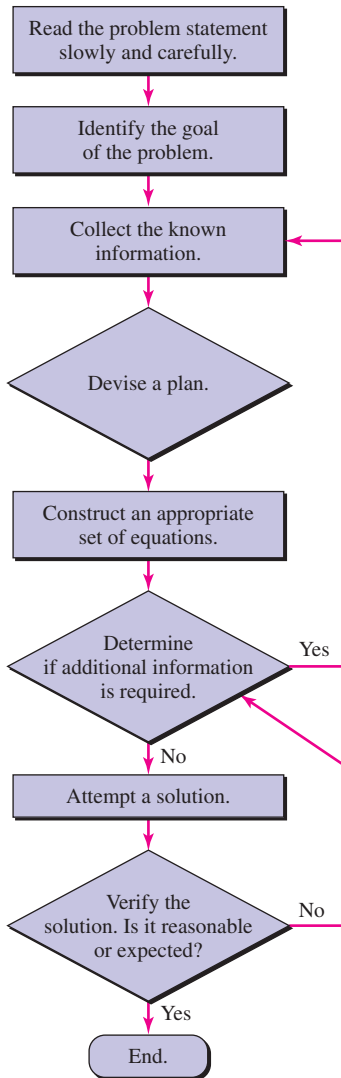

through your course of study, you will pick up techniques that work for you, and likely continue to do so as a practicing engineer. At this stage, then, we should spend a few moments discussing some basic points.

The first point is that by far, the most common difficulty encountered by engineering students is *not knowing how to start* a problem. This improves with experience, but early on that's of no help. The best advice we can give is to adopt a methodical approach, beginning with reading the problem statement slowly and carefully (and more than once, if needed). Since experience usually gives us some type of insight into how to deal with a specific problem, worked examples appear throughout the book. Rather than just read them, however, it might be helpful to work through them with a pencil and a piece of paper.

Once we've read through the problem, and feel we might have some useful experience, the next step is to identify the goal of the problem—perhaps to calculate a voltage or a power, or to select a component value. Knowing where we're going is a big help. The next step is to collect as much information as we can, and to organize it somehow.

At this point *we're still not ready to reach for the calculator*. It's best first to devise a plan, perhaps based on experience, perhaps based simply on our intuition. Sometimes plans work, and sometimes they don't. Starting with our initial plan, it's time to construct an initial set of equations. If they appear complete, we can solve them. If not, we need to either locate more information, modify our plan, or both.

Once we have what appears to be a working solution, we should not stop, even if exhausted and ready for a break. **No engineering problem is solved unless the solution is tested somehow.** We might do this by performing a computer simulation, or solving the problem a different way, or perhaps even just estimating what answer might be reasonable.

Since not everyone likes to read to learn, these steps are summarized in the adjacent flowchart. This is just one particular problem-solving strategy, and the reader of course should feel free to modify it as necessary. The real key, however, is to try and learn in a relaxed, low-stress environment free of distractions. Experience is the best teacher, and learning from our own mistakes will always be part of the process of becoming a skilled engineer.

## READING FURTHER

This relatively inexpensive, best-selling book teaches the reader how to develop winning strategies in the face of seemingly impossible problems:

G. Polya, *How to Solve It*. Princeton, N.J.: Princeton University Press, 1971.

# Basic Components and Electric Circuits

## INTRODUCTION

In conducting circuit analysis, we often find ourselves seeking specific *currents*, *voltages*, or *powers*, so here we begin with a brief description of these quantities. In terms of components that can be used to build electrical circuits, we have quite a few from which to choose. We initially focus on the *resistor*, a simple passive component, and a range of idealized active sources of voltage and current. As we move forward, new components will be added to the inventory to allow more complex (and useful) circuits to be considered.

A quick word of advice before we begin: Pay close attention to the role of “+” and “−” signs when labeling voltages, and the significance of the arrow in defining current; they often make the difference between wrong and right answers.

## 2.1 UNITS AND SCALES

In order to state the value of some measurable quantity, we must give both a *number* and a *unit*, such as “3 meters.” Fortunately, we all use the same number system. This is not true for units, and a little time must be spent in becoming familiar with a suitable system. We must agree on a standard unit and be assured of its permanence and its general acceptability. The standard unit of length, for example, should not be defined in terms of the distance between two marks on a certain rubber band; this is not permanent, and furthermore everybody else is using another standard.

The most frequently used system of units is the one adopted by the National Bureau of Standards in 1964; it is used by all major professional engineering societies and is the language in which today’s textbooks are written. This is the International System of Units (abbreviated *SI* in all languages), adopted by the General

## KEY CONCEPTS

Basic Electrical Quantities and Associated Units: Charge, Current, Voltage, and Power

Current Direction and Voltage Polarity

The Passive Sign Convention for Calculating Power

Ideal Voltage and Current Sources

Dependent Sources

Resistance and Ohm’s Law



Conference on Weights and Measures in 1960. Modified several times since, the SI is built upon seven basic units: the *meter*, *kilogram*, *second*, *ampere*, *kelvin*, *mole*, and *candela* (see Table 2.1). This is a “metric system,” some form of which is now in common use in most countries of the world, although it is not yet widely used in the United States. Units for other quantities such as volume, force, energy, etc., are derived from these seven base units.

TABLE 2.1 SI Base Units

Base Quantity	Name	Symbol
length	meter	m
mass	kilogram	kg
time	second	s
electric current	ampere	A
thermodynamic temperature	kelvin	K
amount of substance	mole	mol
luminous intensity	candela	cd

There is some inconsistency regarding whether units named after a person should be capitalized. Here, we will adopt the most contemporary convention,<sup>1,2</sup> where such units are written out in lowercase (e.g., watt, joule), but abbreviated with an uppercase symbol (e.g., W, J).

(1) H. Barrell, *Nature* **220**, 1968, p. 651.

(2) V. N. Krutikov, T. K. Kanishcheva, S. A. Kononogov, L. K. Isaev, and N. I. Khanov, *Measurement Techniques* **51**, 2008, p. 1045.

The “calorie” used with food, drink, and exercise is really a kilocalorie, 4.187 J.

The fundamental unit of work or energy is the *joule* (J). One joule (a  $\text{kg m}^2 \text{s}^{-2}$  in SI base units) is equivalent to 0.7376 foot pound-force (ft · lbf). Other energy units include the calorie (cal), equal to 4.187 J; the British thermal unit (Btu), which is 1055 J; and the kilowatthour (kWh), equal to  $3.6 \times 10^6$  J. Power is defined as the *rate* at which work is done or energy is expended. The fundamental unit of power is the *watt* (W), defined as 1 J/s. One watt is equivalent to 0.7376 ft · lbf/s or, equivalently, 1/745.7 horsepower (hp).

The SI uses the decimal system to relate larger and smaller units to the basic unit, and employs prefixes to signify the various powers of 10. A list of prefixes and their symbols is given in Table 2.2; the ones most commonly encountered in engineering are highlighted.

TABLE 2.2 SI Prefixes

Factor	Name	Symbol	Factor	Name	Symbol
$10^{-24}$	yocto	y	$10^{24}$	yotta	Y
$10^{-21}$	zepto	z	$10^{21}$	zetta	Z
$10^{-18}$	atto	a	$10^{18}$	exa	E
$10^{-15}$	femto	f	$10^{15}$	peta	P
$10^{-12}$	pico	p	$10^{12}$	tera	T
$10^{-9}$	nano	n	$10^9$	giga	G
$10^{-6}$	micro	$\mu$	$10^6$	mega	M
$10^{-3}$	milli	m	$10^3$	kilo	k
$10^{-2}$	centi	c	$10^2$	hecto	h
$10^{-1}$	deci	d	$10^1$	deka	da

These prefixes are worth memorizing, for they will appear often both in this text and in other technical work. Combinations of several prefixes, such as the millimicrosecond, are unacceptable. It is worth noting that in terms of distance, it is common to see “micron ( $\mu\text{m}$ )” as opposed to “micrometer,” and often the angstrom ( $\text{\AA}$ ) is used for  $10^{-10}$  meter. Also, in circuit analysis and engineering in general, it is fairly common to see numbers expressed in what are frequently termed “engineering units.” In engineering notation, a quantity is represented by a number between 1 and 999 and an appropriate metric unit using a power divisible by 3. So, for example, it is preferable to express the quantity  $0.048\text{ W}$  as  $48\text{ mW}$ , instead of  $4.8\text{ cW}$ ,  $4.8 \times 10^{-2}\text{ W}$ , or  $48,000\ \mu\text{W}$ .

### PRACTICE

2.1 A krypton fluoride laser emits light at a wavelength of  $248\text{ nm}$ . This is the same as: (a)  $0.0248\text{ mm}$ ; (b)  $2.48\ \mu\text{m}$ ; (c)  $0.248\ \mu\text{m}$ ; (d)  $24,800\ \text{\AA}$ .

2.2 A single logic gate in a prototype integrated circuit is found to be capable of switching from the “on” state to the “off” state in  $12\text{ ps}$ . This corresponds to: (a)  $1.2\text{ ns}$ ; (b)  $120\text{ ns}$ ; (c)  $1200\text{ ns}$ ; (d)  $12,000\text{ ns}$ .

2.3 A typical incandescent reading lamp runs at  $60\text{ W}$ . If it is left on constantly, how much energy (J) is consumed per day, and what is the weekly cost if energy is charged at a rate of 12.5 cents per kilowatthour?

Ans: 2.1 (c); 2.2 (d); 2.3  $5.18\text{ MJ}$ ,  $\$1.26$ .

## 2.2 CHARGE, CURRENT, VOLTAGE, AND POWER

### Charge

One of the most fundamental concepts in electric circuit analysis is that of charge conservation. We know from basic physics that there are two types of charge: positive (corresponding to a proton) and negative (corresponding to an electron). For the most part, this text is concerned with circuits in which only electron flow is relevant. There are many devices (such as batteries, diodes, and transistors) in which positive charge motion is important to understanding internal operation, but external to the device we typically concentrate on the electrons which flow through the connecting wires. Although we continuously transfer charges between different parts of a circuit, we do nothing to change the total amount of charge. In other words, we neither create nor destroy electrons (or protons) when running electric circuits.<sup>1</sup> Charge in motion represents a *current*.

In the SI system, the fundamental unit of charge is the *coulomb* (C). It is defined in terms of the *ampere* by counting the total charge that passes through an arbitrary cross section of a wire during an interval of one second; one coulomb is measured each second for a wire carrying a current of 1 ampere (Fig. 2.1). In this system of units, a single electron has a charge of  $-1.602 \times 10^{-19}\text{ C}$  and a single proton has a charge of  $+1.602 \times 10^{-19}\text{ C}$ .

(1) Although the occasional appearance of smoke may seem to suggest otherwise. . .

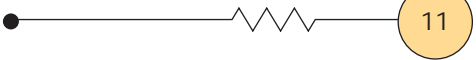

As seen in Table 2.1, the base units of the SI are not derived from fundamental physical quantities. Instead, they represent historically agreed upon measurements, leading to definitions which occasionally seem backward. For example, it would make more sense physically to define the ampere based on electronic charge.

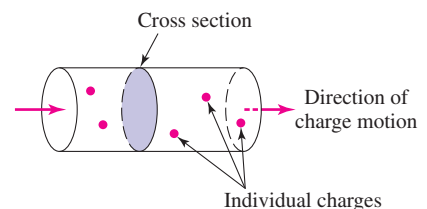

■ FIGURE 2.1 The definition of current illustrated using current flowing through a wire; 1 ampere corresponds to 1 coulomb of charge passing through the arbitrarily chosen cross section in 1 second.

A quantity of charge that does not change with time is typically represented by  $Q$ . The instantaneous amount of charge (which may or may not be time-invariant) is commonly represented by  $q(t)$ , or simply  $q$ . This convention is used throughout the remainder of the text: capital letters are reserved for constant (time-invariant) quantities, whereas lowercase letters represent the more general case. Thus, a constant charge may be represented by *either*  $Q$  or  $q$ , but an amount of charge that changes over time *must* be represented by the lowercase letter  $q$ .

## Current

The idea of “transfer of charge” or “charge in motion” is of vital importance to us in studying electric circuits because, in moving a charge from place to place, we may also transfer energy from one point to another. The familiar cross-country power-transmission line is a practical example of a device that transfers energy. Of equal importance is the possibility of varying the rate at which the charge is transferred in order to communicate or transfer information. This process is the basis of communication systems such as radio, television, and telemetry.

The current present in a discrete path, such as a metallic wire, has both a *numerical value* and a *direction* associated with it; it is a measure of the rate at which charge is moving past a given reference point in a specified direction.

Once we have specified a reference direction, we may then let  $q(t)$  be the total charge that has passed the reference point since an arbitrary time  $t = 0$ , moving in the defined direction. A contribution to this total charge will be negative if negative charge is moving in the reference direction, or if positive charge is moving in the opposite direction. As an example, Fig. 2.2 shows a history of the total charge  $q(t)$  that has passed a given reference point in a wire (such as the one shown in Fig. 2.1).

We define the current at a specific point and flowing in a specified direction as the instantaneous rate at which net positive charge is moving past that point in the specified direction. This, unfortunately, is the historical definition, which came into popular use before it was appreciated that current in wires is actually due to negative, not positive, charge motion. Current is symbolized by  $I$  or  $i$ , and so

$$i = \frac{dq}{dt} \quad [1]$$

The unit of current is the ampere (A), named after A. M. Ampère, a French physicist. It is commonly abbreviated as an “amp,” although this is unofficial and somewhat informal. One ampere equals 1 coulomb per second.

Using Eq. [1], we compute the instantaneous current and obtain Fig. 2.3. The use of the lowercase letter  $i$  is again to be associated with an instantaneous value; an uppercase  $I$  would denote a constant (i.e., time-invariant) quantity.

The charge transferred between time  $t_0$  and  $t$  may be expressed as a definite integral:

$$\int_{q(t_0)}^{q(t)} dq = \int_{t_0}^t i dt'$$

The total charge transferred over all time is thus given by

$$q(t) = \int_{t_0}^t i dt' + q(t_0) \quad [2]$$

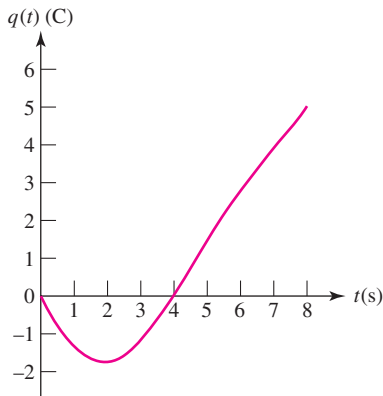

■ FIGURE 2.2 A graph of the instantaneous value of the total charge  $q(t)$  that has passed a given reference point since  $t = 0$ .

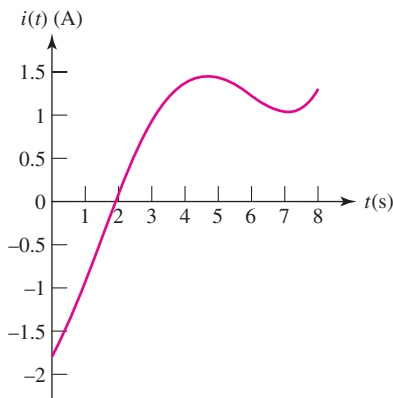

■ FIGURE 2.3 The instantaneous current  $i = dq/dt$ , where  $q$  is given in Fig. 2.2.

Several different types of current are illustrated in Fig. 2.4. A current that is constant in time is termed a direct current, or simply dc, and is shown by Fig. 2.4a. We will find many practical examples of currents that vary sinusoidally with time (Fig. 2.4b); currents of this form are present in normal household circuits. Such a current is often referred to as alternating current, or ac. Exponential currents and damped sinusoidal currents (Fig. 2.4c and d) will also be encountered later.

We create a graphical symbol for current by placing an arrow next to the conductor. Thus, in Fig. 2.5a the direction of the arrow and the value 3 A indicate either that a net positive charge of 3 C/s is moving to the right or that a net negative charge of  $-3$  C/s is moving to the left each second. In Fig. 2.5b there are again two possibilities: either  $-3$  A is flowing to the left or  $+3$  A is flowing to the right. All four statements and both figures represent currents that are equivalent in their electrical effects, and we say that they are equal. A nonelectrical analogy that may be easier to visualize is to think in terms of a personal savings account: e.g., a deposit can be viewed as either a *negative* cash flow *out of* your account or a *positive* flow *into* your account.

It is convenient to think of current as the motion of positive charge, even though it is known that current flow in metallic conductors results from electron motion. In ionized gases, in electrolytic solutions, and in some semiconductor materials, however, positive charges in motion constitute part or all of the current. Thus, any definition of current can agree with the physical nature of conduction only part of the time. The definition and symbolism we have adopted are standard.

It is essential that we realize that the current arrow does not indicate the “actual” direction of current flow but is simply part of a convention that allows us to talk about “the current in the wire” in an unambiguous manner. The arrow is a fundamental part of the definition of a current! Thus, to talk about the value of a current  $i_1(t)$  without specifying the arrow is to discuss an undefined entity. For example, Fig. 2.6a and b are meaningless representations of  $i_1(t)$ , whereas Fig. 2.6c is complete.

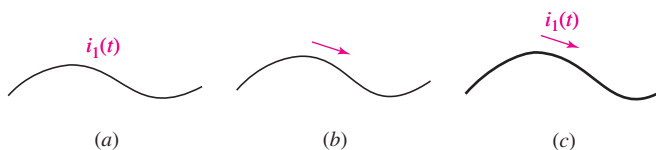

■ FIGURE 2.6 (a, b) Incomplete, improper, and incorrect definitions of a current. (c) The correct definition of  $i_1(t)$ .

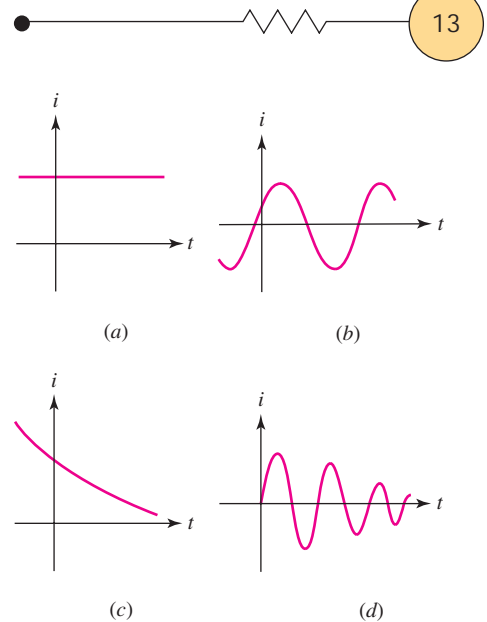

■ FIGURE 2.4 Several types of current: (a) Direct current (dc). (b) Sinusoidal current (ac). (c) Exponential current. (d) Damped sinusoidal current.



■ FIGURE 2.5 Two methods of representation for the exact same current.

## PRACTICE

2.4 In the wire of Fig. 2.7, electrons are moving *left to right* to create a current of 1 mA. Determine  $I_1$  and  $I_2$ .

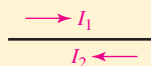

■ FIGURE 2.7

Ans:  $I_1 = -1$  mA;  $I_2 = +1$  mA.

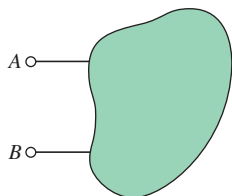

■ FIGURE 2.8 A general two-terminal circuit element.

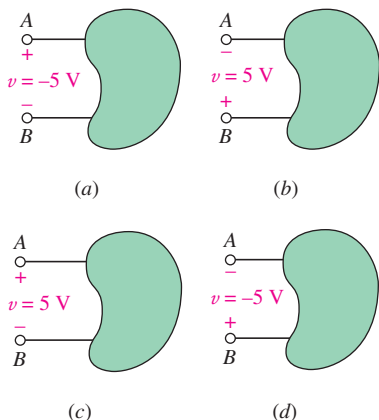

■ FIGURE 2.9 (a, b) Terminal B is 5 V positive with respect to terminal A; (c, d) terminal A is 5 V positive with respect to terminal B.

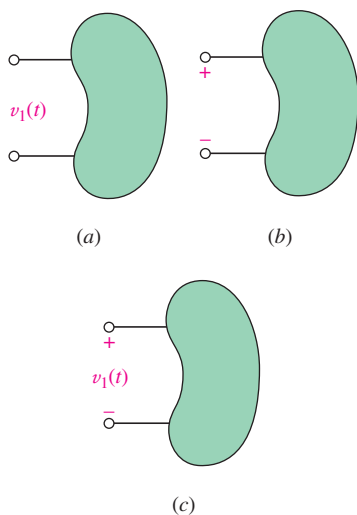

■ FIGURE 2.10 (a, b) These are inadequate definitions of a voltage. (c) A correct definition includes both a symbol for the variable and a plus-minus symbol pair.

## Voltage

We must now begin to refer to a circuit element, something best defined in general terms to begin with. Such electrical devices as fuses, light bulbs, resistors, batteries, capacitors, generators, and spark coils can be represented by combinations of simple circuit elements. We begin by showing a very general circuit element as a shapeless object possessing two terminals at which connections to other elements may be made (Fig. 2.8).

There are two paths by which current may enter or leave the element. In subsequent discussions we will define particular circuit elements by describing the electrical characteristics that may be observed at their terminals.

In Fig. 2.8, let us suppose that a dc current is sent into terminal A, through the general element, and back out of terminal B. Let us also assume that pushing charge through the element requires an expenditure of energy. We then say that an electrical voltage (or a *potential difference*) exists between the two terminals, or that there is a voltage “across” the element. Thus, the voltage across a terminal pair is a measure of the work required to move charge through the element. The unit of voltage is the volt,<sup>2</sup> and 1 volt is the same as 1 J/C. Voltage is represented by V or v.

A voltage can exist between a pair of electrical terminals whether a current is flowing or not. An automobile battery, for example, has a voltage of 12 V across its terminals even if nothing whatsoever is connected to the terminals.

According to the principle of conservation of energy, the energy that is expended in forcing charge through the element must appear somewhere else. When we later meet specific circuit elements, we will note whether that energy is stored in some form that is readily available as electric energy or whether it changes irreversibly into heat, acoustic energy, or some other nonelectrical form.

We must now establish a convention by which we can distinguish between energy supplied *to* an element and energy that is supplied *by* the element itself. We do this by our choice of sign for the voltage of terminal A with respect to terminal B. If a positive current is entering terminal A of the element and an external source must expend energy to establish this current, then terminal A is positive with respect to terminal B. (Alternatively, we may say that terminal B is negative with respect to terminal A.)

The sense of the voltage is indicated by a plus-minus pair of algebraic signs. In Fig. 2.9a, for example, the placement of the + sign at terminal A indicates that terminal A is  $v$  volts positive with respect to terminal B. If we later find that  $v$  happens to have a numerical value of  $-5$  V, then we may say either that A is  $-5$  V positive with respect to B or that B is 5 V positive with respect to A. Other cases are shown in Fig. 2.9b, c, and d.

Just as we noted in our definition of current, it is essential to realize that the plus-minus pair of algebraic signs does not indicate the “actual” polarity of the voltage but is simply part of a convention that enables us to talk unambiguously about “the voltage across the terminal pair.” *The definition of any voltage must include a plus-minus sign pair!* Using a quantity  $v_1(t)$  without specifying the location of the plus-minus sign pair is using an undefined term. Figure 2.10a and b do *not* serve as definitions of  $v_1(t)$ ; Fig. 2.10c does.

(2) We are probably fortunate that the full name of the 18th century Italian physicist, *Alessandro Giuseppe Antonio Anastasio Volta*, is not used for our unit of potential difference!



**PRACTICE**

2.5 For the element in Fig. 2.11,  $v_1 = 17$  V. Determine  $v_2$ .

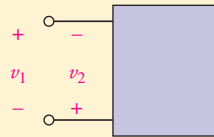

■ FIGURE 2.11

Ans:  $v_2 = -17$  V.

**Power**

We have already defined power, and we will represent it by  $P$  or  $p$ . If one joule of energy is expended in transferring one coulomb of charge through the device in one second, then the rate of energy transfer is one watt. The absorbed power must be proportional both to the number of coulombs transferred per second (current) and to the energy needed to transfer one coulomb through the element (voltage). Thus,

$$p = vi \quad [3]$$

Dimensionally, the right side of this equation is the product of joules per coulomb and coulombs per second, which produces the expected dimension of joules per second, or watts. The conventions for current, voltage, and power are shown in Fig. 2.12.

We now have an expression for the power being absorbed by a circuit element in terms of a voltage across it and current through it. Voltage was defined in terms of an energy expenditure, and power is the rate at which energy is expended. However, no statement can be made concerning energy transfer in any of the four cases shown in Fig. 2.9, for example, until the direction of the current is specified. Let us imagine that a current arrow is placed alongside each upper lead, directed to the right, and labeled “+2 A.” First, consider the case shown in Fig. 2.9c. Terminal  $A$  is 5 V positive with respect to terminal  $B$ , which means that 5 J of energy is required to move each coulomb of positive charge into terminal  $A$ , through the object, and out terminal  $B$ . Since we are injecting +2 A (a current of 2 coulombs of positive charge per second) into terminal  $A$ , we are doing  $(5 \text{ J/C}) \times (2 \text{ C/s}) = 10 \text{ J}$  of work per second on the object. In other words, the object is absorbing 10 W of power from whatever is injecting the current.

We know from an earlier discussion that there is no difference between Fig. 2.9c and Fig. 2.9d, so we expect the object depicted in Fig. 2.9d to also be absorbing 10 W. We can check this easily enough: we are injecting +2 A into terminal  $A$  of the object, so +2 A flows out of terminal  $B$ . Another way of saying this is that we are injecting  $-2$  A of current into terminal  $B$ . It takes  $-5 \text{ J/C}$  to move charge from terminal  $B$  to terminal  $A$ , so the object is absorbing  $(-5 \text{ J/C}) \times (-2 \text{ C/s}) = +10 \text{ W}$  as expected. The only difficulty in describing this particular case is keeping the minus signs straight, but with a bit of care we see the correct answer can be obtained regardless of our choice of positive reference terminal (terminal  $A$  in Fig. 2.9c, and terminal  $B$  in Fig. 2.9d).

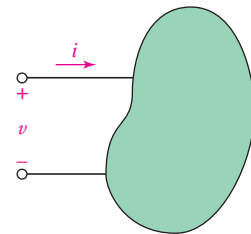

■ FIGURE 2.12 The power absorbed by the element is given by the product  $p = vi$ . Alternatively, we can say that the element generates or supplies a power  $-vi$ .

Now let's look at the situation depicted in Fig. 2.9a, again with  $+2\text{ A}$  injected into terminal A. Since it takes  $-5\text{ J/C}$  to move charge from terminal A to terminal B, the object is absorbing  $(-5\text{ J/C}) \times (2\text{ C/s}) = -10\text{ W}$ . What does this mean? How can anything absorb *negative* power? If we think about this in terms of energy transfer,  $-10\text{ J}$  is transferred to the object each second through the  $2\text{ A}$  current flowing into terminal A. The object is actually losing energy—at a rate of  $10\text{ J/s}$ . In other words, it is supplying  $10\text{ J/s}$  (i.e.,  $10\text{ W}$ ) to some other object not shown in the figure. Negative *absorbed* power, then, is equivalent to positive *supplied* power.

Let's recap. Figure 2.12 shows that if one terminal of the element is  $v$  volts positive with respect to the other terminal, and if a current  $i$  is entering the element through that terminal, then a power  $p = vi$  is being *absorbed* by the element; it is also correct to say that a power  $p = vi$  is being *delivered* to the element. When the current arrow is directed into the element at the plus-marked terminal, we satisfy the *passive sign convention*. This convention should be studied carefully, understood, and memorized. In other words, it says that if the current arrow and the voltage polarity signs are placed such that the current enters that end of the element marked with the positive sign, then the power *absorbed* by the element can be expressed by the product of the specified current and voltage variables. If the numerical value of the product is negative, then we say that the element is absorbing negative power, or that it is actually generating power and delivering it to some external element. For example, in Fig. 2.12 with  $v = 5\text{ V}$  and  $i = -4\text{ A}$ , the element may be described as either absorbing  $-20\text{ W}$  or generating  $20\text{ W}$ .

Conventions are only required when there is more than one way to do something, and confusion may result when two different groups try to communicate. For example, it is rather arbitrary to always place “North” at the top of a map; compass needles don't point “up,” anyway. Still, if we were talking to people who had secretly chosen the opposite convention of placing “South” at the top of their maps, imagine the confusion that could result! In the same fashion, there is a general convention that always draws the current arrows pointing into the positive voltage terminal, regardless of whether the element supplies or absorbs power. This convention is not incorrect but sometimes results in counterintuitive currents labeled on circuit schematics. The reason for this is that it simply seems more natural to refer to positive current flowing out of a voltage or current source that is supplying positive power to one or more circuit elements.

### EXAMPLE 2.1

Compute the power absorbed by each part in Fig. 2.13.

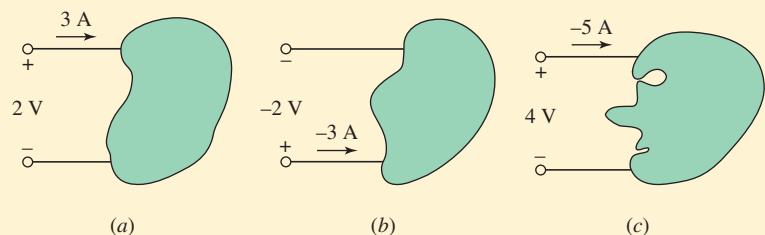

FIGURE 2.13 (a, b, c) Three examples of two-terminal elements.

If the current arrow is directed into the “+” marked terminal of an element, then  $p = vi$  yields the *absorbed* power. A negative value indicates that power is actually being generated by the element.

If the current arrow is directed out of the “+” terminal of an element, then  $p = vi$  yields the *supplied* power. A negative value in this case indicates that power is being absorbed.

In Fig. 2.13a, we see that the reference current is defined consistent with the passive sign convention, which assumes that the element is absorbing power. With +3 A flowing into the positive reference terminal, we compute

$$P = (2 \text{ V})(3 \text{ A}) = 6 \text{ W}$$

of power absorbed by the element.

Figure 2.13b shows a slightly different picture. Now, we have a current of  $-3 \text{ A}$  flowing into the positive reference terminal. This gives us an absorbed power

$$P = (-2 \text{ V})(-3 \text{ A}) = 6 \text{ W}$$

Thus, we see that the two cases are actually equivalent: A current of +3 A flowing into the top terminal is the same as a current of +3 A flowing out of the bottom terminal, or, equivalently, a current of  $-3 \text{ A}$  flowing into the bottom terminal.

Referring to Fig. 2.13c, we again apply the passive sign convention rules and compute an absorbed power

$$P = (4 \text{ V})(-5 \text{ A}) = -20 \text{ W}$$

Since we computed a negative *absorbed* power, this tells us that the element in Fig. 2.13c is actually *supplying* +20 W (i.e., it's a source of energy).

## PRACTICE

2.6 Determine the power being absorbed by the circuit element in Fig. 2.14a.

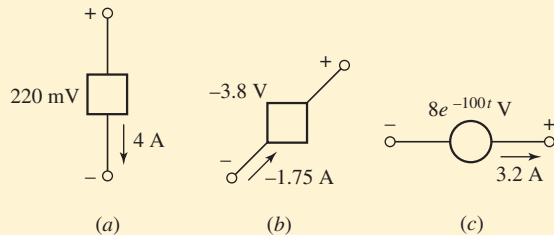

■ FIGURE 2.14

2.7 Determine the power being generated by the circuit element in Fig. 2.14b.

2.8 Determine the power being delivered to the circuit element in Fig. 2.14c at  $t = 5 \text{ ms}$ .

Ans: 880 mW; 6.65 W;  $-15.53 \text{ W}$ .

## 2.3 VOLTAGE AND CURRENT SOURCES

Using the concepts of current and voltage, it is now possible to be more specific in defining a *circuit element*.

In so doing, it is important to differentiate between the physical device itself and the mathematical model which we will use to analyze its behavior in a circuit. The model is only an approximation.

By definition, a simple circuit element is the mathematical model of a two-terminal electrical device, and it can be completely characterized by its voltage-current relationship; it cannot be subdivided into other two-terminal devices.

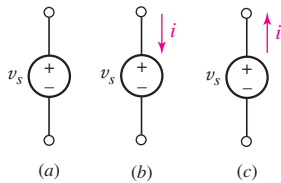

■ FIGURE 2.15 Circuit symbol of the independent voltage source.

If you've ever noticed the room lights dim when an air conditioner kicks on, it's because the sudden large current demand temporarily led to a voltage drop. After the motor starts moving, it takes less current to keep it in motion. At that point, the current demand is reduced, the voltage returns to its original value, and the wall outlet again provides a reasonable approximation of an ideal voltage source.

Let us agree that we will use the expression *circuit element* to refer to the mathematical model. The choice of a particular model for any real device must be made on the basis of experimental data or experience; we will usually assume that this choice has already been made. For simplicity, we initially consider circuits with idealized components represented by simple models.

All the simple circuit elements that we will consider can be classified according to the relationship of the current through the element to the voltage across the element. For example, if the voltage across the element is linearly proportional to the current through it, we will call the element a resistor. Other types of simple circuit elements have terminal voltages which are proportional to the *derivative* of the current with respect to time (an inductor), or to the *integral* of the current with respect to time (a capacitor). There are also elements in which the voltage is completely independent of the current, or the current is completely independent of the voltage; these are termed *independent sources*. Furthermore, we will need to define special kinds of sources for which either the source voltage or current depends upon a current or voltage elsewhere in the circuit; such sources are referred to as *dependent sources*. Dependent sources are used a great deal in electronics to model both dc and ac behavior of transistors, especially in amplifier circuits.

## Independent Voltage Sources

The first element we will consider is the *independent voltage source*. The circuit symbol is shown in Fig. 2.15a; the subscript  $s$  merely identifies the voltage as a “source” voltage, and is common but not required. *An independent voltage source is characterized by a terminal voltage which is completely independent of the current through it.* Thus, if we are given an independent voltage source and are notified that the terminal voltage is 12 V, then we always assume this voltage, regardless of the current flowing.

The independent voltage source is an *ideal* source and does not represent exactly any real physical device, because the ideal source could theoretically deliver an infinite amount of energy from its terminals. This idealized voltage source does, however, furnish a reasonable approximation to several practical voltage sources. An automobile storage battery, for example, has a 12 V terminal voltage that remains essentially constant as long as the current through it does not exceed a few amperes. A small current may flow in either direction through the battery. If it is positive and flowing out of the positively marked terminal, then the battery is furnishing power to the headlights, for example; if the current is positive and flowing into the positive terminal, then the battery is charging by absorbing energy from the alternator.<sup>3</sup> An ordinary household electrical outlet also approximates an independent voltage source, providing a voltage  $v_s = 115\sqrt{2} \cos 2\pi 60t$  V; this representation is valid for currents less than 20 A or so.

A point worth repeating here is that the presence of the plus sign at the upper end of the symbol for the independent voltage source in Fig. 2.15a does not necessarily mean that the upper terminal is numerically positive with respect to the lower terminal. Instead, it means that the upper terminal is  $v_s$  volts positive with respect to the lower. If at some instant  $v_s$  happens to be negative, then the upper terminal is actually negative with respect to the lower at that instant.

(3) Or the battery of a friend's car, if you accidentally left your headlights on. . .

Consider a current arrow labeled “ $i$ ” placed adjacent to the upper conductor of the source as in Fig. 2.15b. The current  $i$  is entering the terminal at which the positive sign is located, the passive sign convention is satisfied, and the source thus *absorbs* power  $p = v_s i$ . More often than not, a source is expected to deliver power to a network and not to absorb it. Consequently, we might choose to direct the arrow as in Fig. 2.15c so that  $v_s i$  will represent the power *delivered* by the source. Technically, either arrow direction may be chosen; whenever possible, we will adopt the convention of Fig. 2.15c in this text for voltage and current sources, which are not usually considered passive devices.

An independent voltage source with a constant terminal voltage is often termed an independent dc voltage source and can be represented by either of the symbols shown in Fig. 2.16a and b. Note in Fig. 2.16b that when the physical plate structure of the battery is suggested, the longer plate is placed at the positive terminal; the plus and minus signs then represent redundant notation, but they are usually included anyway. For the sake of completeness, the symbol for an independent ac voltage source is shown in Fig. 2.16c.

## Independent Current Sources

Another ideal source which we will need is the *independent current source*. Here, the current through the element is completely independent of the voltage across it. The symbol for an independent current source is shown in Fig. 2.17. If  $i_s$  is constant, we call the source an independent dc current source. An ac current source is often drawn with a tilde through the arrow, similar to the ac voltage source shown in Fig. 2.16c.

Like the independent voltage source, the independent current source is at best a reasonable approximation for a physical element. In theory it can deliver infinite power from its terminals because it produces the same finite current for any voltage across it, no matter how large that voltage may be. It is, however, a good approximation for many practical sources, particularly in electronic circuits.

Although most students seem happy enough with an independent voltage source providing a fixed voltage but essentially any current, *it is a common mistake* to view an independent current source as having zero voltage across its terminals while providing a fixed current. In fact, we do not know a priori what the voltage across a current source will be—it depends entirely on the circuit to which it is connected.

## Dependent Sources

The two types of ideal sources that we have discussed up to now are called *independent* sources because the value of the source quantity is not affected in any way by activities in the remainder of the circuit. This is in contrast with yet another kind of ideal source, the *dependent*, or *controlled*, source, in which the source quantity is determined by a voltage or current existing at some other location in the system being analyzed. Sources such as these appear in the equivalent electrical models for many electronic devices, such as transistors, operational amplifiers, and integrated circuits. To distinguish between dependent and independent sources, we introduce the diamond symbols shown in Fig. 2.18. In Fig. 2.18a and c,  $K$  is a dimensionless scaling constant. In Fig. 2.18b,  $g$  is a scaling factor with units of A/V; in Fig. 2.18d,  $r$  is a scaling factor with units of V/A. The controlling current  $i_x$  and the controlling voltage  $v_x$  must be defined in the circuit.

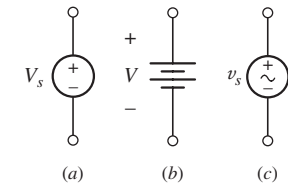

FIGURE 2.16 (a) DC voltage source symbol; (b) battery symbol; (c) ac voltage source symbol.

Terms like dc voltage source and dc current source are commonly used. Literally, they mean “direct-current voltage source” and “direct-current current source,” respectively. Although these terms may seem a little odd or even redundant, the terminology is so widely used there’s no point in fighting it.

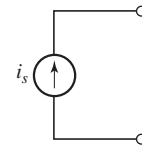

FIGURE 2.17 Circuit symbol for the independent current source.

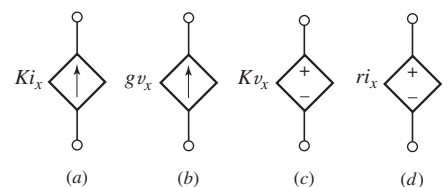
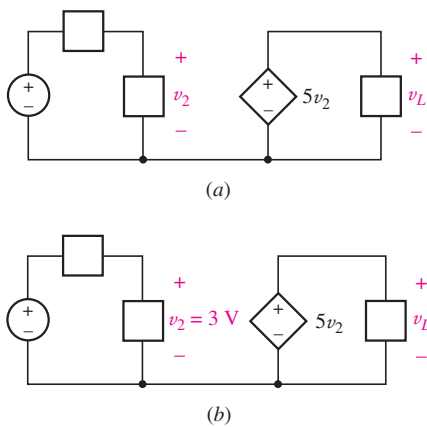

FIGURE 2.18 The four different types of dependent sources: (a) current-controlled current source; (b) voltage-controlled current source; (c) voltage-controlled voltage source; (d) current-controlled voltage source.

It does seem odd at first to have a current source whose value depends on a voltage, or a voltage source which is controlled by a current flowing through some other element. Even a voltage source depending on a remote voltage can appear strange. Such sources are invaluable for modeling complex systems, however, making the analysis algebraically straightforward. Examples include the drain current of a field effect transistor as a function of the gate voltage, or the output voltage of an analog integrated circuit as a function of differential input voltage. When encountered during circuit analysis, we write down the entire controlling expression for the dependent source just as we would if it was a numerical value attached to an independent source. This often results in the need for an additional equation to complete the analysis, unless the controlling voltage or current is already one of the specified unknowns in our system of equations.

### EXAMPLE 2.2



■ FIGURE 2.19 (a) An example circuit containing a voltage-controlled voltage source. (b) The additional information provided is included on the diagram.

In the circuit of Fig. 2.19a, if  $v_2$  is known to be 3 V, find  $v_L$ .

We have been provided with a partially labeled circuit diagram and the additional information that  $v_2 = 3$  V. This is probably worth adding to our diagram, as shown in Fig. 2.19b.

Next we step back and look at the information collected. In examining the circuit diagram, we notice that the desired voltage  $v_L$  is the same as the voltage across the dependent source. Thus,

$$v_L = 5v_2$$

At this point, we would be done with the problem if only we knew  $v_2$ !

Returning to our diagram, we see that we actually do know  $v_2$ —it was specified as 3 V. We therefore write

$$v_2 = 3$$

We now have two (simple) equations in two unknowns, and solve to find  $v_L = 15$  V.

An important lesson at this early stage of the game is that *the time it takes to completely label a circuit diagram is always a good investment*. As a final step, we should go back and check over our work to ensure that the result is correct.

### PRACTICE

2.9 Find the power *absorbed* by each element in the circuit in Fig. 2.20.

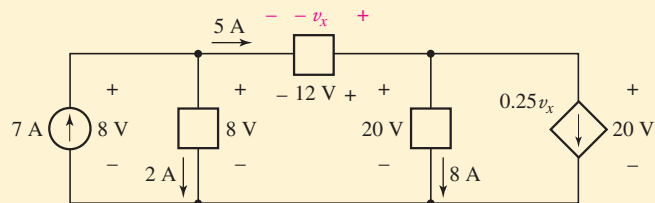

■ FIGURE 2.20

Ans: (left to right)  $-56$  W;  $16$  W;  $-60$  W;  $160$  W;  $-60$  W.

Dependent and independent voltage and current sources are *active* elements; they are capable of delivering power to some external device. For the present we will think of a *passive* element as one which is capable only of receiving power. However, we will later see that several passive elements are able to store finite amounts of energy and then return that energy later to various external devices; since we still wish to call such elements passive, it will be necessary to improve upon our two definitions a little later.

## Networks and Circuits

The interconnection of two or more simple circuit elements forms an electrical *network*. If the network contains at least one closed path, it is also an electric *circuit*. Note: Every circuit is a network, but not all networks are circuits (see Fig. 2.21)!

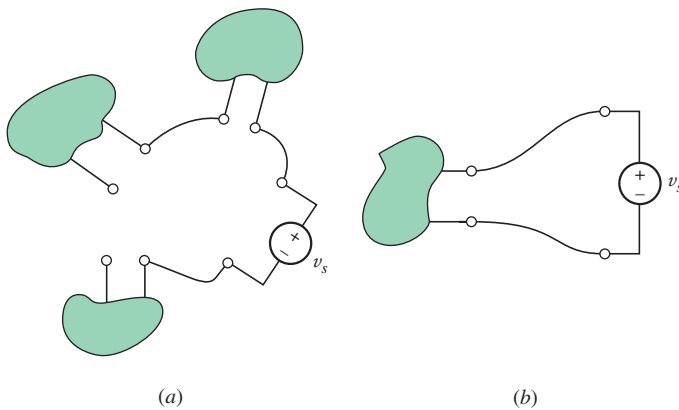

■ FIGURE 2.21 (a) A network that is not a circuit. (b) A network that is a circuit.

A network that contains at least one active element, such as an independent voltage or current source, is an active network. A network that does not contain any active elements is a passive network.

We have now defined what we mean by the term *circuit element*, and we have presented the definitions of several specific circuit elements, the independent and dependent voltage and current sources. Throughout the remainder of the book we will define only five additional circuit elements: the resistor, inductor, capacitor, transformer, and the ideal operational amplifier (“op amp,” for short). These are all ideal elements. They are important because we may combine them into networks and circuits that represent real devices as accurately as we require. Thus, the transistor shown in Fig. 2.22a and b may be modeled by the voltage terminals designated  $v_{gs}$  and the single dependent current source of Fig. 2.22c. Note that the dependent current source produces a current that depends on a voltage elsewhere in the circuit. The parameter  $g_m$ , commonly referred to as the transconductance, is calculated using transistor-specific details as well as the operating point determined by the circuit connected to the transistor. It is generally a small number, on the order of  $10^{-2}$  to perhaps 10 A/V. This model works pretty well as long as the frequency of any sinusoidal source is neither very large nor very small; the model can be modified to account for frequency-dependent

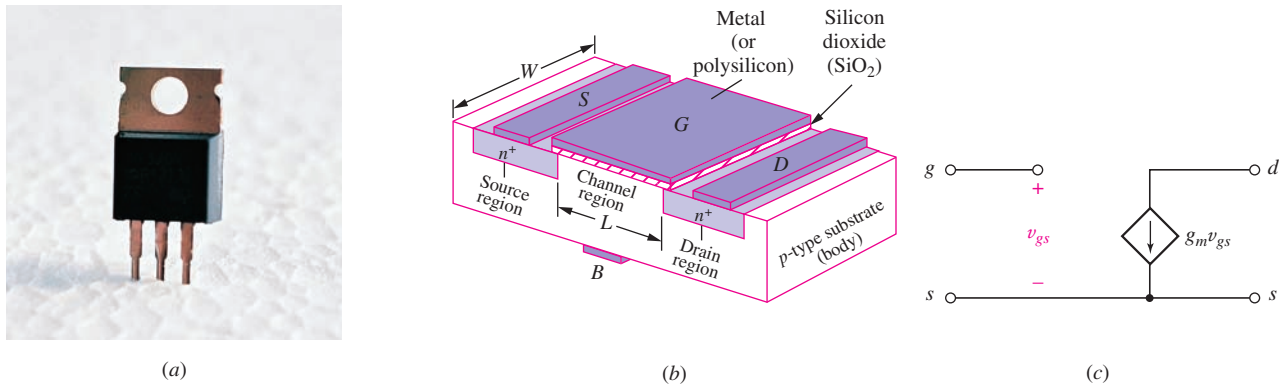

■ FIGURE 2.22 The Metal Oxide Semiconductor Field Effect Transistor (MOSFET). (a) An IRF540 N-channel power MOSFET in a TO-220 package, rated at 100 V and 22 A; (b) cross-sectional view of a basic MOSFET (R. Jaeger, *Microelectronic Circuit Design*, McGraw-Hill, 1997); (c) equivalent circuit model for use in ac circuit analysis.

effects by including additional ideal circuit elements such as resistors and capacitors.

Similar (but much smaller) transistors typically constitute only one small part of an integrated circuit that may be less than  $2 \text{ mm} \times 2 \text{ mm}$  square and  $200 \text{ }\mu\text{m}$  thick and yet contains several thousand transistors plus various resistors and capacitors. Thus, we may have a physical device that is about the size of one letter on this page but requires a model composed of ten thousand ideal simple circuit elements. We use this concept of “circuit modeling” in a number of electrical engineering topics covered in other courses, including electronics, energy conversion, and antennas.

## 2.4 OHM'S LAW

So far, we have been introduced to both dependent and independent voltage and current sources and were cautioned that they were *idealized* active elements that could only be approximated in a real circuit. We are now ready to meet another idealized element, the linear resistor. The resistor is the simplest passive element, and we begin our discussion by considering the work of an obscure German physicist, Georg Simon Ohm, who published a pamphlet in 1827 that described the results of one of the first efforts to measure currents and voltages, and to describe and relate them mathematically. One result was a statement of the fundamental relationship we now call **Ohm's law**, even though it has since been shown that this result was discovered 46 years earlier in England by Henry Cavendish, a brilliant semirecluse.

Ohm's law states that the voltage across conducting materials is directly proportional to the current flowing through the material, or

$$v = Ri \quad [4]$$

where the constant of proportionality  $R$  is called the **resistance**. The unit of resistance is the *ohm*, which is  $1 \text{ V/A}$  and customarily abbreviated by a capital omega,  $\Omega$ .



When this equation is plotted on  $i$ -versus- $v$  axes, the graph is a straight line passing through the origin (Fig. 2.23). Equation [4] is a linear equation, and we will consider it as the definition of a *linear resistor*. Resistance is normally considered to be a positive quantity, although negative resistances may be simulated with special circuitry.

Again, it must be emphasized that the linear resistor is an idealized circuit element; it is only a mathematical model of a real, physical device. “Resistors” may be easily purchased or manufactured, but it is soon found that the voltage-current ratios of these physical devices are reasonably constant only within certain ranges of current, voltage, or power, and depend also on temperature and other environmental factors. We usually refer to a linear resistor as simply a resistor; any resistor that is nonlinear will always be described as such. Nonlinear resistors should not necessarily be considered undesirable elements. Although it is true that their presence complicates an analysis, the performance of the device may depend on or be greatly improved by the nonlinearity. For example, fuses for overcurrent protection and Zener diodes for voltage regulation are very nonlinear in nature, a fact that is exploited when using them in circuit design.

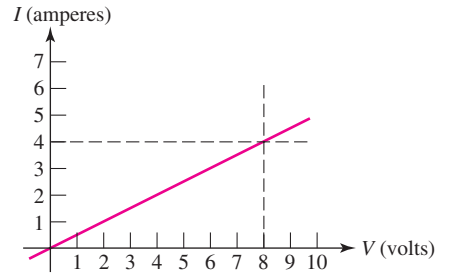

■ FIGURE 2.23 Current-voltage relationship for an example  $2\ \Omega$  linear resistor. Note the slope of the line is  $0.5\ \text{A/V}$ , or  $500\ \text{m}\Omega^{-1}$ .

## Power Absorption

Figure 2.24 shows several different resistor packages, as well as the most common circuit symbol used for a resistor. In accordance with the voltage, current, and power conventions already adopted, the product of  $v$  and  $i$  gives the power absorbed by the resistor. That is,  $v$  and  $i$  are selected to satisfy the passive sign convention. The absorbed power appears physically

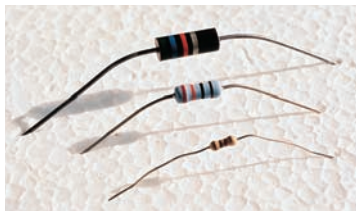

(a)



(b)

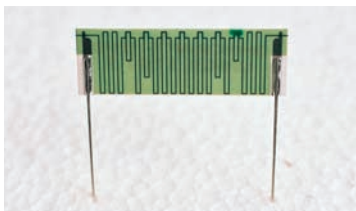

(c)



(d)

■ FIGURE 2.24 (a) Several common resistor packages. (b) A  $560\ \Omega$  power resistor rated at up to  $50\ \text{W}$ . (c) A 5% tolerance 10-teraohm ( $10,000,000,000,000\ \Omega$ ) resistor manufactured by Ohmcraft. (d) Circuit symbol for the resistor, applicable to all of the devices in (a) through (c).

as heat and/or light and is always positive; a (positive) resistor is a passive element that cannot deliver power or store energy. Alternative expressions for the absorbed power are

$$p = vi = i^2R = v^2/R \quad [5]$$

One of the authors (who shall remain anonymous) had the unfortunate experience of inadvertently connecting a 100  $\Omega$ , 2 W carbon resistor across a 110 V source. The ensuing flame, smoke, and fragmentation were rather disconcerting, demonstrating clearly that a practical resistor has definite limits to its ability to behave like the ideal linear model. In this case, the unfortunate resistor was called upon to absorb 121 W; since it was designed to handle only 2 W, its reaction was understandably violent.

### EXAMPLE 2.3

**The 560  $\Omega$  resistor shown in Fig. 2.24b is connected to a circuit which causes a current of 42.4 mA to flow through it. Calculate the voltage across the resistor and the power it is dissipating.**

The voltage across the resistor is given by Ohm's law:

$$v = Ri = (560)(0.0424) = 23.7 \text{ V}$$

The dissipated power can be calculated in several different ways. For instance,

$$p = vi = (23.7)(0.0424) = 1.005 \text{ W}$$

Alternatively,

$$p = v^2/R = (23.7)^2/560 = 1.003 \text{ W}$$

or

$$p = i^2R = (0.0424)^2(560) = 1.007 \text{ W}$$

We note several things.

First, we calculated the power in three different ways, and we seem to have obtained *three different answers!*

In reality, however, we rounded our voltage to three significant digits, which will impact the accuracy of any subsequent quantity we calculate with it. With this in mind, we see that the answers show reasonable agreement (within 1%).

The other point worth noting is that the resistor is rated to 50 W—since we are only dissipating approximately 2% of this value, the resistor is in no danger of overheating.

### PRACTICE

With reference to Fig. 2.25, compute the following:

2.10  $R$  if  $i = -2 \mu\text{A}$  and  $v = -44 \text{ V}$ .

2.11 The power absorbed by the resistor if  $v = 1 \text{ V}$  and  $R = 2 \text{ k}\Omega$ .

2.12 The power absorbed by the resistor if  $i = 3 \text{ nA}$  and  $R = 4.7 \text{ M}\Omega$ .

Ans: 22  $\text{M}\Omega$ ; 500  $\mu\text{W}$ ; 42.3  $\text{pW}$ .

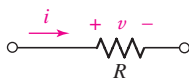

FIGURE 2.25

# PRACTICAL APPLICATION

## Wire Gauge

Technically speaking, any material (except for a superconductor) will provide resistance to current flow. As in all introductory circuits texts, however, we tacitly assume that wires appearing in circuit diagrams have zero resistance. This implies that there is no potential difference between the ends of a wire, and hence no power absorbed or heat generated. Although usually not an unreasonable assumption, it does neglect practical considerations when choosing the appropriate wire diameter for a specific application.

Resistance is determined by (1) the inherent resistivity of a material and (2) the device geometry. **Resistivity**, represented by the symbol  $\rho$ , is a measure of the ease with which electrons can travel through a certain material. Since it is the ratio of the electric field (V/m) to the areal density of current flowing in the material ( $A/m^2$ ), the general unit of  $\rho$  is an  $\Omega \cdot m$ , although metric prefixes are often employed. Every material has a different inherent resistivity, which depends on temperature. Some examples are shown in Table 2.3; as can be seen, there is a small variation between different types of copper (less than 1%) but a very large difference between different metals. In particular, although physically stronger than copper, steel wire is several times more resistive. In some technical discussions, it is more common to see the conductivity (symbolized by  $\sigma$ ) of a

material quoted, which is simply the reciprocal of the resistivity.

The resistance of a particular object is obtained by multiplying the resistivity by the length  $\ell$  of the resistor and dividing by the cross-sectional area ( $A$ ) as in Eq. [6]; these parameters are illustrated in Fig. 2.26.

$$R = \rho \frac{\ell}{A} \quad [6]$$

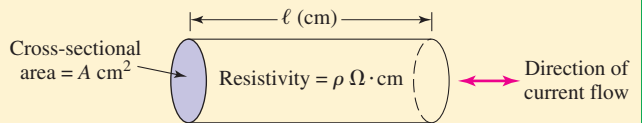

■ FIGURE 2.26 Definition of geometrical parameters used to compute the resistance of a wire. The resistivity of the material is assumed to be spatially uniform.

We determine the resistivity when we select the material from which to fabricate a wire and measure the temperature of the application environment. Since a finite amount of power is absorbed by the wire due to its resistance, current flow leads to the production of heat. Thicker wires have lower resistance and also dissipate heat more easily but are heavier, take up a larger volume, and are more expensive. Thus, we are motivated by practical considerations to choose the smallest wire that

TABLE 2.3 Common Electrical Wire Materials and Resistivities\*

ASTM Specification**	Temper and Shape	Resistivity at 20°C ( $\mu\Omega \cdot \text{cm}$ )
B33	Copper, tinned soft, round	1.7654
B75	Copper, tube, soft, OF copper	1.7241
B188	Copper, hard bus tube, rectangular or square	1.7521
B189	Copper, lead-coated soft, round	1.7654
B230	Aluminum, hard, round	2.8625
B227	Copper-clad steel, hard, round, grade 40 HS	4.3971
B355	Copper, nickel-coated soft, round Class 10	1.9592
B415	Aluminum-clad steel, hard, round	8.4805

\* C. B. Rawlins, "Conductor materials," *Standard Handbook for Electrical Engineering*, 13th ed., D. G. Fink and H. W. Beaty, eds. New York: McGraw-Hill, 1993, pp. 4-4 to 4-8.

\*\* American Society of Testing and Materials.

(Continued on next page)

can safely do the job, rather than simply choosing the largest-diameter wire available in an effort to minimize resistive losses. The American Wire Gauge (AWG) is a standard system of specifying wire size. In selecting a wire gauge, smaller AWG corresponds to a larger wire

diameter; an abbreviated table of common gauges is given in Table 2.4. Local fire and electrical safety codes typically dictate the required gauge for specific wiring applications, based on the maximum current expected as well as where the wires will be located.

**TABLE 2.4** Some Common Wire Gauges and the Resistance of (Soft) Solid Copper Wire\*

Conductor Size (AWG)	Cross-Sectional Area (mm <sup>2</sup> )	Ohms per 1000 ft at 20°C
28	0.0804	65.3
24	0.205	25.7
22	0.324	16.2
18	0.823	6.39
14	2.08	2.52
12	3.31	1.59
6	13.3	0.3952
4	21.1	0.2485
2	33.6	0.1563

\* C. B. Rawlins et al., *Standard Handbook for Electrical Engineering*, 13th ed., D. G. Fink and H. W. Beaty, eds. New York: McGraw-Hill, 1993, p. 4-47.

## EXAMPLE 2.4

**A dc power link is to be made between two islands separated by a distance of 24 miles. The operating voltage is 500 kV and the system capacity is 600 MW. Calculate the maximum dc current flow, and estimate the resistivity of the cable, assuming a diameter of 2.5 cm and a solid (not stranded) wire.**

Dividing the maximum power (600 MW, or  $600 \times 10^6$  W) by the operating voltage (500 kV, or  $500 \times 10^3$  V) yields a maximum current of

$$\frac{600 \times 10^6}{500 \times 10^3} = 1200 \text{ A}$$

The cable resistance is simply the ratio of the voltage to the current, or

$$R_{\text{cable}} = \frac{500 \times 10^3}{1200} = 417 \Omega$$

We know the length:

$$\ell = (24 \text{ miles}) \left( \frac{5280 \text{ ft}}{1 \text{ mile}} \right) \left( \frac{12 \text{ in}}{1 \text{ ft}} \right) \left( \frac{2.54 \text{ cm}}{1 \text{ in}} \right) = 3,862,426 \text{ cm}$$

Given that most of our information appears to be valid to only two significant figures, we round this to  $3.9 \times 10^6$  cm.

With the cable diameter specified as 2.5 cm, we know its cross-sectional area is  $4.9 \text{ cm}^2$ .

$$\text{Thus, } \rho_{\text{cable}} = R_{\text{cable}} \frac{A}{\ell} = 417 \left( \frac{4.9}{3.9 \times 10^6} \right) = 520 \mu\Omega \cdot \text{cm}$$

### PRACTICE

2.13 A 500 ft long 24 AWG soft copper wire is carrying a current of 100 mA. What is the voltage dropped across the wire?

Ans: 3.26 V.

## Conductance

For a linear resistor the ratio of current to voltage is also a constant

$$\frac{i}{v} = \frac{1}{R} = G \quad [7]$$

where  $G$  is called the *conductance*. The SI unit of conductance is the siemens (S), 1 A/V. An older, unofficial unit for conductance is the mho, which was often abbreviated as  $\mathfrak{U}$  and is still occasionally written as  $\Omega^{-1}$ . You will occasionally see it used on some circuit diagrams, as well as in catalogs and texts. The same circuit symbol (Fig. 2.24d) is used to represent both resistance and conductance. The absorbed power is again necessarily positive and may be expressed in terms of the conductance by

$$p = vi = v^2 G = \frac{i^2}{G} \quad [8]$$

Thus a  $2 \Omega$  resistor has a conductance of  $\frac{1}{2}$  S, and if a current of 5 A is flowing through it, then a voltage of 10 V is present across the terminals and a power of 50 W is being absorbed.

All the expressions given so far in this section were written in terms of instantaneous current, voltage, and power, such as  $v = iR$  and  $p = vi$ . We should recall that this is a shorthand notation for  $v(t) = Ri(t)$  and  $p(t) = v(t)i(t)$ . The current through and voltage across a resistor must both vary with time in the same manner. Thus, if  $R = 10 \Omega$  and  $v = 2 \sin 100t$  V, then  $i = 0.2 \sin 100t$  A. Note that the power is given by  $0.4 \sin^2 100t$  W, and a simple sketch will illustrate the different nature of its variation with time. Although the current and voltage are each negative during certain time intervals, the absorbed power is *never* negative!

Resistance may be used as the basis for defining two commonly used terms, *short circuit* and *open circuit*. We define a short circuit as a resistance of zero ohms; then, since  $v = iR$ , the voltage across a short circuit must be zero, although the current may have any value. In an analogous manner,





we define an open circuit as an infinite resistance. It follows from Ohm's law that the current must be zero, regardless of the voltage across the open circuit. Although real wires have a small resistance associated with them, we always assume them to have zero resistance unless otherwise specified. Thus, in all of our circuit schematics, wires are taken to be perfect short circuits.

## SUMMARY AND REVIEW

In this chapter, we introduced the topic of units – specifically those relevant to electrical circuits—and their relationship to fundamental (SI) units. We also discussed current and current sources, voltage and voltage sources, and the fact that the product of voltage and current yields power (the rate of energy consumption or generation). Since power can be either positive or negative depending on the current direction and voltage polarity, the passive sign convention was described to ensure we always know if an element is *absorbing* or *supplying* energy to the rest of the circuit. Four additional sources were introduced, forming a general class known as dependent sources. They are often used to model complex systems and electrical components, but the actual value of voltage or current supplied is typically unknown until the entire circuit is analyzed. We concluded the chapter with the resistor—by far the most common circuit element—whose voltage and current are linearly related (described by Ohm's law). Whereas the *resistivity* of a material is one of its fundamental properties (measured in  $\Omega \cdot \text{cm}$ ), *resistance* describes a device property (measured in  $\Omega$ ) and hence depends not only on resistivity but on the device geometry (i.e., length and area) as well.

We conclude with key points of this chapter to review, along with appropriate examples.

- The system of units most commonly used in electrical engineering is the SI.
- The direction in which positive charges are moving is the direction of positive current flow; alternatively, positive current flow is in the direction opposite that of moving electrons.
- To define a current, both a value and a direction must be given. Currents are typically denoted by the uppercase letter “ $I$ ” for constant (dc) values, and either  $i(t)$  or simply  $i$  otherwise.
- To define a voltage across an element, it is necessary to label the terminals with “+” and “−” signs as well as to provide a value (either an algebraic symbol or a numerical value).
- Any element is said to supply positive power if positive current flows out of the positive voltage terminal. Any element absorbs positive power if positive current flows into the positive voltage terminal. (Example 2.1)
- There are six sources: the independent voltage source, the independent current source, the current-controlled dependent current source, the voltage-controlled dependent current source, the voltage-controlled dependent voltage source, and the current-controlled dependent voltage source. (Example 2.2)

Note that a current represented by  $i$  or  $i(t)$  can be constant (dc) or time-varying, but currents represented by the symbol  $I$  must be non-time-varying.

- Ohm's law states that the voltage across a linear resistor is directly proportional to the current flowing through it; i.e.,  $v = Ri$ . (Example 2.3)
- The power dissipated by a resistor (which leads to the production of heat) is given by  $p = vi = i^2R = v^2/R$ . (Example 2.3)
- Wires are typically assumed to have zero resistance in circuit analysis. When selecting a wire gauge for a specific application, however, local electrical and fire codes must be consulted. (Example 2.4)

## READING FURTHER

A good book that discusses the properties and manufacture of resistors in considerable depth:

Felix Zandman, Paul-René Simon, and Joseph Szwarc, *Resistor Theory and Technology*. Raleigh, N.C.: SciTech Publishing, 2002.

A good all-purpose electrical engineering handbook:

Donald G. Fink and H. Wayne Beaty, *Standard Handbook for Electrical Engineers*, 13th ed., New York: McGraw-Hill, 1993.

In particular, pp. 1-1 to 1-51, 2-8 to 2-10, and 4-2 to 4-207 provide an in-depth treatment of topics related to those discussed in this chapter.

A detailed reference for the SI is available on the Web from the National Institute of Standards:

Ambler Thompson and Barry N. Taylor, *Guide for the Use of the International System of Units (SI)*, NIST Special Publication 811, 2008 edition, [www.nist.gov](http://www.nist.gov).

## EXERCISES

### 2.1 Units and Scales

1. Convert the following to engineering notation:
 

(a) 0.045 W	(b) 2000 pJ
(c) 0.1 ns	(d) 39,212 as
(e) 3 $\Omega$	(f) 18,000 m
(g) 2,500,000,000,000 bits	(h) $10^{15}$ atoms/cm <sup>3</sup>
2. Convert the following to engineering notation:
 

(a) 1230 fs	(b) 0.0001 decimeter
(c) 1400 mK	(d) 32 nm
(e) 13,560 kHz	(f) 2021 micromoles
(g) 13 deciliters	(h) 1 hectometer
3. Express the following in engineering units:
 

(a) 1212 mV	(b) $10^{11}$ pA
(c) 1000 yoctoseconds	(d) 33.9997 zeptoseconds
(e) 13,100 attoseconds	(f) $10^{-14}$ zettasecond
(g) $10^{-5}$ second	(h) $10^{-9}$ Gs
4. Expand the following distances in simple meters:
 

(a) 1 Zm	(b) 1 Em	(c) 1 Pm
(d) 1 Tm	(e) 1 Gm	(f) 1 Mm

5. Convert the following to SI units, taking care to employ proper engineering notation:
- (a) 212°F      (b) 0°F      (c) 0 K  
(d) 200 hp      (e) 1 yard      (f) 1 mile
6. Convert the following to SI units, taking care to employ proper engineering notation:
- (a) 100°C      (b) 0°C      (c) 4.2 K  
(d) 150 hp      (e) 500 Btu      (f) 100 J/s
7. A certain krypton fluoride laser generates 15 ns long pulses, each of which contains 550 mJ of energy. (a) Calculate the peak instantaneous output power of the laser. (b) If up to 100 pulses can be generated per second, calculate the maximum average power output of the laser.
8. When operated at a wavelength of 750 nm, a certain Ti:sapphire laser is capable of producing pulses as short as 50 fs, each with an energy content of 500  $\mu$ J. (a) Calculate the instantaneous output power of the laser. (b) If the laser is capable of a pulse repetition rate of 80 MHz, calculate the maximum average output power that can be achieved.
9. An electric vehicle is driven by a single motor rated at 40 hp. If the motor is run continuously for 3 h at maximum output, calculate the electrical energy consumed. Express your answer in SI units using engineering notation.
10. Under insolation conditions of 500 W/m<sup>2</sup> (direct sunlight), and 10% solar cell efficiency (defined as the ratio of electrical output power to incident solar power), calculate the area required for a photovoltaic (solar cell) array capable of running the vehicle in Exer. 9 at half power.
11. A certain metal oxide nanowire piezoelectricity generator is capable of producing 100 pW of usable electricity from the type of motion obtained from a person jogging at a moderate pace. (a) How many nanowire devices are required to operate a personal MP3 player which draws 1 W of power? (b) If the nanowires can be produced with a density of 5 devices per square micron directly onto a piece of fabric, what area is required, and would it be practical?
12. A particular electric utility charges customers different rates depending on their daily rate of energy consumption: \$0.05/kWh up to 20 kWh, and \$0.10/kWh for all energy usage above 20 kWh in any 24 hour period. (a) Calculate how many 100 W light bulbs can be run continuously for less than \$10 per week. (b) Calculate the daily energy cost if 2000 kW of power is used continuously.
13. The Tilting Windmill Electrical Cooperative LLC Inc. has instituted a differential pricing scheme aimed at encouraging customers to conserve electricity use during daylight hours, when local business demand is at its highest. If the price per kilowatthour is \$0.033 between the hours of 9 p.m. and 6 a.m., and \$0.057 for all other times, how much does it cost to run a 2.5 kW portable heater continuously for 30 days?
14. Assuming a global population of 9 billion people, each using approximately 100 W of power continuously throughout the day, calculate the total land area that would have to be set aside for photovoltaic power generation, assuming 800 W/m<sup>2</sup> of incident solar power and a conversion efficiency (sunlight to electricity) of 10%.

## 2.2 Charge, Current, Voltage, and Power

15. The total charge flowing out of one end of a small copper wire and into an unknown device is determined to follow the relationship  $q(t) = 5e^{-t/2}$  C, where  $t$  is expressed in seconds. Calculate the current flowing into the device, taking note of the sign.
16. The current flowing into the collector lead of a certain bipolar junction transistor (BJT) is measured to be 1 nA. If no charge was transferred in or out of the collector lead prior to  $t = 0$ , and the current flows for 1 min, calculate the total charge which crosses into the collector.



17. The total charge stored on a 1 cm diameter insulating plate is  $-10^{13}$  C.  
 (a) How many electrons are on the plate? (b) What is the areal density of electrons (number of electrons per square meter)? (c) If additional electrons are added to the plate from an external source at the rate of  $10^6$  electrons per second, what is the magnitude of the current flowing between the source and the plate?
18. A mysterious device found in a forgotten laboratory accumulates charge at a rate specified by the expression  $q(t) = 9 - 10t$  C from the moment it is switched on. (a) Calculate the total charge contained in the device at  $t = 0$ . (b) Calculate the total charge contained at  $t = 1$  s. (c) Determine the current flowing into the device at  $t = 1$  s, 3 s, and 10 s.
19. A new type of device appears to accumulate charge according to the expression  $q(t) = 10t^2 - 22t$  mC ( $t$  in s). (a) In the interval  $0 \leq t < 5$  s, at what time does the current flowing into the device equal zero? (b) Sketch  $q(t)$  and  $i(t)$  over the interval  $0 \leq t < 5$  s.
20. The current flowing through a tungsten-filament light bulb is determined to follow  $i(t) = 114 \sin(100\pi t)$  A. (a) Over the interval defined by  $t = 0$  and  $t = 2$  s, how many times does the current equal zero amperes? (b) How much charge is transported through the light bulb in the first second?
21. The current waveform depicted in Fig. 2.27 is characterized by a period of 8 s.  
 (a) What is the average value of the current over a single period? (b) If  $q(0) = 0$ , sketch  $q(t)$ ,  $0 < t < 20$  s.

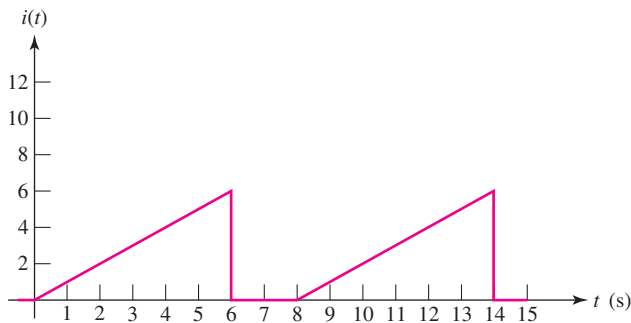

■ FIGURE 2.27 An example of a time-varying current.

22. The current waveform depicted in Fig. 2.28 is characterized by a period of 4 s.  
 (a) What is the average value of the current over a single period? (b) Compute the average current over the interval  $1 < t < 3$  s. (c) If  $q(0) = 1$  C, sketch  $q(t)$ ,  $0 < t < 4$  s.

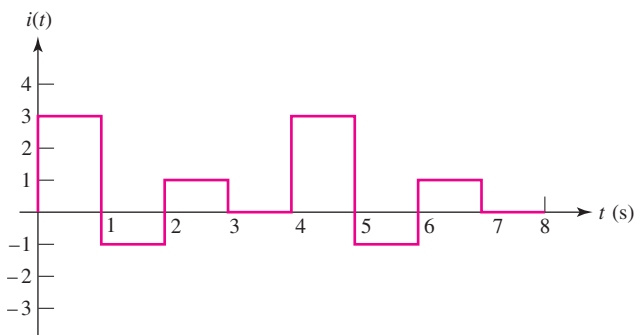

■ FIGURE 2.28 An example of a time-varying current.

23. A path around a certain electric circuit has discrete points labeled  $A$ ,  $B$ ,  $C$ , and  $D$ . To move an electron from points  $A$  to  $C$  requires  $5 \text{ pJ}$ . To move an electron from  $B$  to  $C$  requires  $3 \text{ pJ}$ . To move an electron from  $A$  to  $D$  requires  $8 \text{ pJ}$ . (a) What is the potential difference (in volts) between points  $B$  and  $C$ , assuming a “+” reference at  $C$ ? (b) What is the potential difference (in volts) between points  $B$  and  $D$ , assuming a “+” reference at  $D$ ? (c) What is the potential difference (in volts) between points  $A$  and  $B$  (again, in volts), assuming a “+” reference at  $B$ ?
24. Two metallic terminals protrude from a device. The terminal on the left is the positive reference for a voltage called  $v_x$  (the other terminal is the negative reference). The terminal on the right is the positive reference for a voltage called  $v_y$  (the other terminal being the negative reference). If it takes  $1 \text{ mJ}$  of energy to push a single electron into the left terminal, determine the voltages  $v_x$  and  $v_y$ .
25. The convention for voltmeters is to use a black wire for the negative reference terminal and a red wire for the positive reference terminal. (a) Explain why two wires are required to measure a voltage. (b) If it is dark and the wires into the voltmeter are swapped by accident, what will happen during the next measurement?
26. Determine the power absorbed by each of the elements in Fig. 2.29.

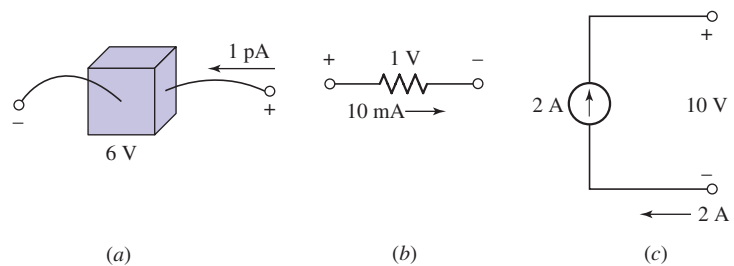

■ FIGURE 2.29 Elements for Exer. 26.

27. Determine the power absorbed by each of the elements in Fig. 2.30.

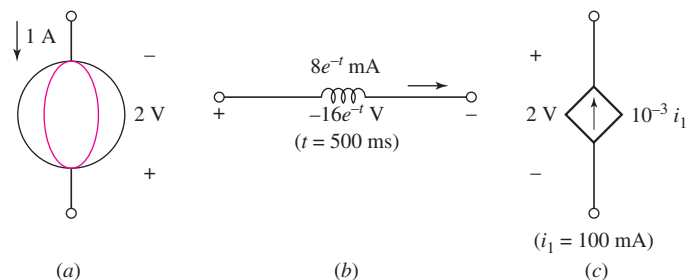

■ FIGURE 2.30 Elements for Exer. 27.

28. A constant current of  $1 \text{ ampere}$  is measured flowing into the positive reference terminal of a pair of leads whose voltage we'll call  $v_p$ . Calculate the absorbed power at  $t = 1 \text{ s}$  if  $v_p(t)$  equals (a)  $+1 \text{ V}$ ; (b)  $-1 \text{ V}$ ; (c)  $2 + 5 \cos(5t) \text{ V}$ ; (d)  $4e^{-2t} \text{ V}$ . (e) Explain the significance of a negative value for absorbed power.

29. Determine the power supplied by the leftmost element in the circuit of Fig. 2.31.

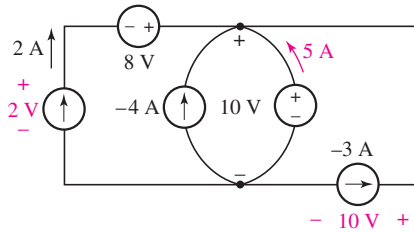

■ FIGURE 2.31

30. The current-voltage characteristic of a silicon solar cell exposed to direct sunlight at noon in Florida during midsummer is given in Fig. 2.32. It is obtained by placing different-sized resistors across the two terminals of the device and measuring the resulting currents and voltages.

- What is the value of the short-circuit current?
- What is the value of the voltage at open circuit?
- Estimate the maximum power that can be obtained from the device.

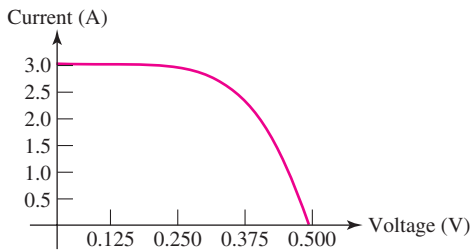

■ FIGURE 2.32

## 2.3 Voltage and Current Sources

- Some of the ideal sources in the circuit of Fig. 2.31 are supplying positive power, and others are absorbing positive power. Determine which are which, and show that the algebraic sum of the power absorbed by each element (taking care to preserve signs) is equal to zero.
- By careful measurements it is determined that a benchtop argon ion laser is consuming (absorbing) 1.5 kW of electric power from the wall outlet, but only producing 5 W of optical power. Where is the remaining power going? Doesn't conservation of energy require the two quantities to be equal?
- Refer to the circuit represented in Fig. 2.33, while noting that the same current flows through each element. The voltage-controlled dependent source provides a current which is 5 times as large as the voltage  $V_x$ . (a) For  $V_R = 10$  V and  $V_x = 2$  V, determine the power absorbed by each element. (b) Is element A likely a passive or active source? Explain.

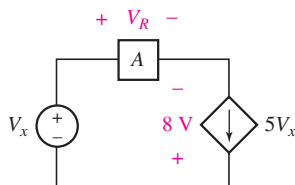

■ FIGURE 2.33

34. Refer to the circuit represented in Fig. 2.33, while noting that the same current flows through each element. The voltage-controlled dependent source provides a current which is 5 times as large as the voltage  $V_x$ . (a) For  $V_R = 100$  V and  $V_x = 92$  V, determine the power supplied by each element. (b) Verify that the algebraic sum of the supplied powers is equal to zero.
35. The circuit depicted in Fig. 2.34 contains a dependent current source; the magnitude and direction of the current it supplies are directly determined by the voltage labeled  $v_1$ . Note that therefore  $i_2 = -3v_1$ . Determine the voltage  $v_1$  if  $v_2 = 33i_2$  and  $i_2 = 100$  mA.

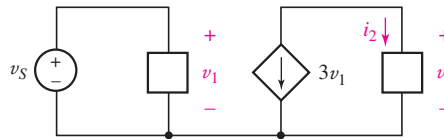

■ FIGURE 2.34

36. To protect an expensive circuit component from being delivered too much power, you decide to incorporate a fast-blowing fuse into the design. Knowing that the circuit component is connected to 12 V, its minimum power consumption is 12 W, and the maximum power it can safely dissipate is 100 W, which of the three available fuse ratings should you select: 1 A, 4 A, or 10 A? Explain your answer.
37. The dependent source in the circuit of Fig. 2.35 provides a voltage whose value depends on the current  $i_x$ . What value of  $i_x$  is required for the dependent source to be supplying 1 W?

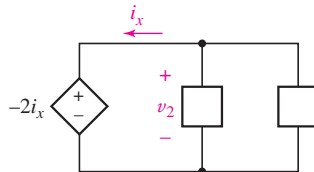

■ FIGURE 2.35

## 2.4 Ohm's Law

38. Determine the magnitude of the current flowing through a  $4.7$  k $\Omega$  resistor if the voltage across it is (a) 1 mV; (b) 10 V; (c)  $4e^{-t}$  V; (d)  $100 \cos(5t)$  V; (e)  $-7$  V.
39. Real resistors can only be manufactured to a specific tolerance, so that in effect the value of the resistance is uncertain. For example, a  $1$   $\Omega$  resistor specified as 5% tolerance could in practice be found to have a value anywhere in the range of 0.95 to 1.05  $\Omega$ . Calculate the voltage across a 2.2 k $\Omega$  10% tolerance resistor if the current flowing through the element is (a) 1 mA; (b)  $4 \sin 44t$  mA.
40. (a) Sketch the current-voltage relationship (current on the y-axis) of a 2 k $\Omega$  resistor over the voltage range of  $-10$  V  $\leq V_{\text{resistor}} \leq +10$  V. Be sure to label both axes appropriately. (b) What is the numerical value of the slope (express your answer in siemens)?
41. Sketch the voltage across a 33  $\Omega$  resistor over the range  $0 < t < 2\pi$  s, if the current is given by  $2.8 \cos(t)$  A. Assume both the current and voltage are defined according to the passive sign convention.
42. Figure 2.36 depicts the current-voltage characteristic of three different resistive elements. Determine the resistance of each, assuming the voltage and current are defined in accordance with the passive sign convention.

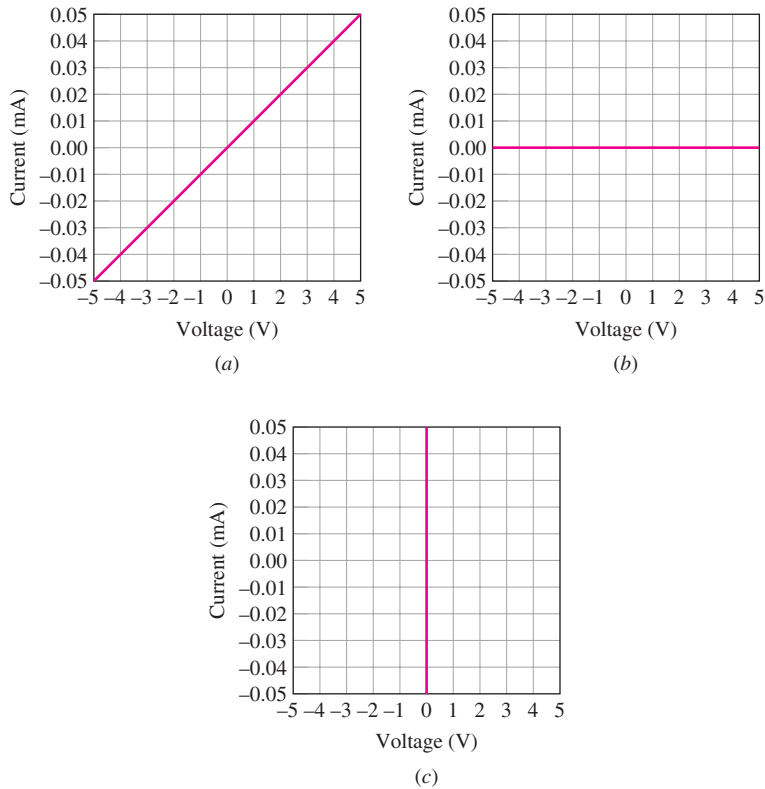

■ FIGURE 2.36

43. Determine the conductance (in siemens) of the following: (a)  $0\ \Omega$ ; (b)  $100\ \text{M}\Omega$ ; (c)  $200\ \text{m}\Omega$ .
44. Determine the magnitude of the current flowing through a  $10\ \text{mS}$  conductance if the voltage across it is (a)  $2\ \text{mV}$ ; (b)  $-1\ \text{V}$ ; (c)  $100e^{-2t}\ \text{V}$ ; (d)  $5\sin(5t)\ \text{V}$ ; (e)  $0\ \text{V}$ .
45. A 1% tolerance  $1\ \text{k}\Omega$  resistor may in reality have a value anywhere in the range of  $990$  to  $1010\ \Omega$ . Assuming a voltage of  $9\ \text{V}$  is applied across it, determine (a) the corresponding range of current and (b) the corresponding range of absorbed power. (c) If the resistor is replaced by a 10% tolerance  $1\ \text{k}\Omega$  resistor, repeat parts (a) and (b).
46. The following experimental data is acquired for an unmarked resistor, using a variable-voltage power supply and a current meter. The current meter readout is somewhat unstable, unfortunately, which introduces error into the measurement.

Voltage (V)	Current (mA)
-2.0	-0.89
-1.2	-0.47
0.0	0.01
1.0	0.44
1.5	0.70

- (a) Plot the measured current-versus-voltage characteristic.  
 (b) Using a best-fit line, estimate the value of the resistance.

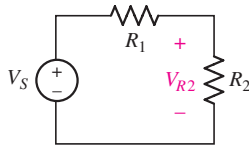

■ FIGURE 2.37

47. Utilize the fact that in the circuit of Fig. 2.37, the total power supplied by the voltage source must equal the total power absorbed by the two resistors to show that

$$V_{R_2} = V_S \frac{R_2}{R_1 + R_2}$$

You may assume the same current flows through each element (a requirement of charge conservation).

48. For each of the circuits in Fig. 2.38, find the current  $I$  and compute the power absorbed by the resistor.

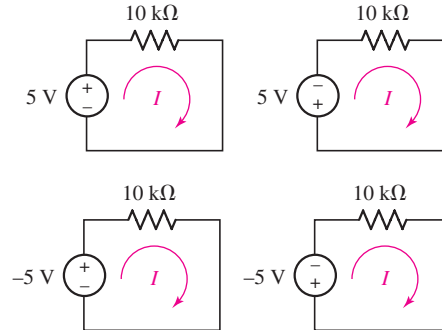

■ FIGURE 2.38

49. Sketch the power absorbed by a  $100 \Omega$  resistor as a function of voltage over the range  $-2 \text{ V} \leq V_{\text{resistor}} \leq +2 \text{ V}$ .

### Chapter-Integrating Exercises



50. So-called “ $n$ -type” silicon has a resistivity given by  $\rho = (-qN_D\mu_n)^{-1}$ , where  $N_D$  is the volume density of phosphorus atoms (atoms/cm<sup>3</sup>),  $\mu_n$  is the electron mobility (cm<sup>2</sup>/V·s), and  $q = -1.602 \times 10^{-19}$  C is the charge of each electron. Conveniently, a relationship exists between mobility and  $N_D$ , as shown in Fig. 2.39. Assume an 8 inch diameter silicon wafer (disk) having a thickness of  $300 \mu\text{m}$ . Design a  $10 \Omega$  resistor by specifying a phosphorus concentration in the range of  $2 \times 10^{15} \text{ cm}^{-3} \leq N_D \leq 2 \times 10^{17} \text{ cm}^{-3}$ , along with a suitable geometry (the wafer may be cut, but not thinned).

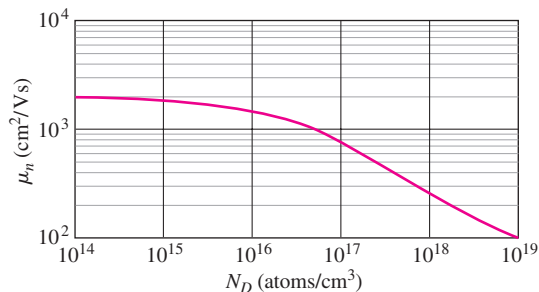

■ FIGURE 2.39

51. Figure 2.39 depicts the relationship between electron mobility  $\mu_n$  and dopant density  $N_D$  for  $n$ -type silicon. With the knowledge that resistivity in this material is given by  $\rho = N_D\mu_n/q$ , plot resistivity as a function of dopant density over the range  $10^{14} \text{ cm}^{-3} \leq N_D \leq 10^{19} \text{ cm}^{-3}$ .

DP

52. Referring to the data of Table 2.4, design a resistor whose value can be varied mechanically in the range of 100 to 500  $\Omega$  (assume operation at 20°C).
53. A 250 ft long span separates a dc power supply from a lamp which draws 25 A of current. If 14 AWG wire is used (note that two wires are needed for a total of 500 ft), calculate the amount of power wasted in the wire.
54. The resistance values in Table 2.4 are calibrated for operation at 20°C. They may be corrected for operation at other temperatures using the relationship<sup>4</sup>

$$\frac{R_2}{R_1} = \frac{234.5 + T_2}{234.5 + T_1}$$

where  $T_1$  = reference temperature (20°C in present case)  
 $T_2$  = desired operating temperature  
 $R_1$  = resistance at  $T_1$   
 $R_2$  = resistance at  $T_2$

A piece of equipment relies on an external wire made of 28 AWG soft copper, which has a resistance of 50.0  $\Omega$  at 20°C. Unfortunately, the operating environment has changed, and it is now 110.5°F. (a) Calculate the length of the original wire. (b) Determine by how much the wire should be shortened so that it is once again 50.0  $\Omega$ .

DP

55. Your favorite meter contains a precision (1% tolerance) 10  $\Omega$  resistor. Unfortunately, the last person who borrowed this meter somehow blew the resistor, and it needs to be replaced. Design a suitable replacement, assuming at least 1000 ft of each of the wire gauges listed in Table 2.4 is readily available to you.
56. At a new installation, you specified that all wiring should conform to the ASTM B33 specification (see Table 2.3). Unfortunately the subcontractor misread your instructions and installed B415 wiring instead (but the same gauge). Assuming the operating voltage is unchanged, (a) by how much will the current be reduced, and (b) how much additional power will be wasted in the lines? (Express both answers in terms of percentage.)
57. If 1 mA of current is forced through a 1 mm diameter, 2.3 meter long piece of hard, round, aluminum-clad steel (B415) wire, how much power is wasted as a result of resistive losses? If instead wire of the same dimensions but conforming to B75 specifications is used, by how much will the power wasted due to resistive losses be reduced?
58. The network shown in Fig. 2.40 can be used to accurately model the behavior of a bipolar junction transistor provided that it is operating in the forward active mode. The parameter  $\beta$  is known as the current gain. If for this device

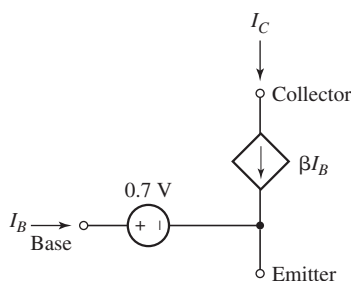

■ FIGURE 2.40 DC model for a bipolar junction transistor operating in forward active mode.

(4) D. G. Fink and H. W. Beaty, *Standard Handbook for Electrical Engineers*, 13th ed. New York: McGraw-Hill, 1993, p. 2–9.



- $\beta = 100$ , and  $I_B$  is determined to be  $100 \mu\text{A}$ , calculate (a)  $I_C$ , the current flowing into the collector terminal; and (b) the power dissipated by the base-emitter region.
59. A 100 W tungsten filament light bulb functions by taking advantage of resistive losses in the filament, absorbing 100 joules each second of energy from the wall socket. How much *optical* energy per second do you expect it to produce, and does this violate the principle of energy conservation?
60. Batteries come in a wide variety of types and sizes. Two of the most common are called “AA” and “AAA.” A single battery of either type is rated to produce a terminal voltage of 1.5 V when fully charged. So what are the differences between the two, other than size? (*Hint*: Think about energy.)



# Voltage and Current Laws

## INTRODUCTION

In Chap. 2 we were introduced to independent voltage and current sources, dependent sources, and resistors. We discovered that *dependent* sources come in four varieties, and are controlled by a voltage or current which exists elsewhere. Once we know the voltage across a resistor, we know its current (and vice versa); this is not the case for sources, however. In general, circuits must be analyzed to determine a complete set of voltages and currents. This turns out to be reasonably straightforward, and only two simple laws are needed in addition to Ohm's law. These new laws are Kirchhoff's current law (KCL) and Kirchhoff's voltage law (KVL), and they are simply restatements of charge and energy conservation, respectively. They apply to any circuit we will ever encounter, although in later chapters we will learn more efficient techniques for specific types of situations.

## 3.1 NODES, PATHS, LOOPS, AND BRANCHES

We now focus our attention on the current-voltage relationships in simple networks of two or more circuit elements. The elements will be connected by wires (sometimes referred to as "leads"), which have zero resistance. Since the network then appears as a number of simple elements and a set of connecting leads, it is called a ***lumped-parameter network***. A more difficult analysis problem arises when we are faced with a ***distributed-parameter network***, which contains an essentially infinite number of vanishingly small elements. We will concentrate on lumped-parameter networks in this text.

## KEY CONCEPTS

New Circuit Terms: *Node*,  
*Path*, *Loop*, and *Branch*

Kirchhoff's Current Law (KCL)

Kirchhoff's Voltage Law (KVL)

Analysis of Basic Series and  
Parallel Circuits

Combination of Series and  
Parallel Sources

Reduction of Series and  
Parallel Resistor  
Combinations

Voltage and Current Division

Ground Connections





In circuits assembled in the real world, the wires will always have finite resistance. However, this resistance is typically so small compared to other resistances in the circuit that we can neglect it without introducing significant error. In our idealized circuits, we will therefore refer to “zero resistance” wires from now on.

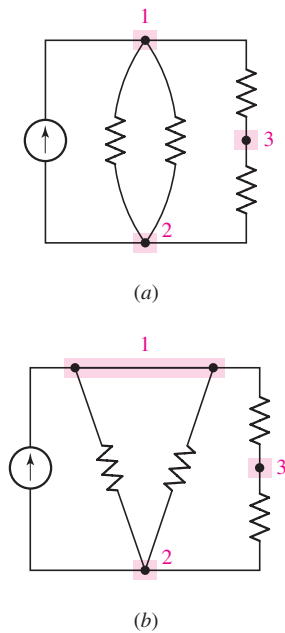

■ FIGURE 3.1 (a) A circuit containing three nodes and five branches. (b) Node 1 is redrawn to look like two nodes; it is still one node.

A point at which two or more elements have a common connection is called a **node**. For example, Fig. 3.1a shows a circuit containing three nodes. Sometimes networks are drawn so as to trap an unwary student into believing that there are more nodes present than is actually the case. This occurs when a node, such as node 1 in Fig. 3.1a, is shown as two separate junctions connected by a (zero-resistance) conductor, as in Fig. 3.1b. However, all that has been done is to spread the common point out into a common zero-resistance line. Thus, we must necessarily consider all of the perfectly conducting leads or portions of leads attached to the node as part of the node. Note also that every element has a node at each of its ends.

Suppose that we start at one node in a network and move through a simple element to the node at the other end. We then continue from that node through a different element to the next node, and continue this movement until we have gone through as many elements as we wish. If no node was encountered more than once, then the set of nodes and elements that we have passed through is defined as a **path**. If the node at which we started is the same as the node on which we ended, then the path is, by definition, a closed path or a **loop**.

For example, in Fig. 3.1a, if we move from node 2 through the current source to node 1, and then through the upper right resistor to node 3, we have established a path; since we have not continued on to node 2 again, we have not made a loop. If we proceeded from node 2 through the current source to node 1, down through the left resistor to node 2, and then up through the central resistor to node 1 again, we do not have a path, since a node (actually two nodes) was encountered more than once; we also do not have a loop, because a loop must be a path.

Another term whose use will prove convenient is **branch**. We define a branch as a single path in a network, composed of one simple element and the node at each end of that element. Thus, a path is a particular collection of branches. The circuit shown in Fig. 3.1a and b contains five branches.

## 3.2 KIRCHHOFF'S CURRENT LAW

We are now ready to consider the first of the two laws named for Gustav Robert Kirchhoff (two *h*'s and two *f*'s), a German university professor who was born about the time Ohm was doing his experimental work. This axiomatic law is called Kirchhoff's current law (abbreviated KCL), and it simply states that

The algebraic sum of the currents entering any node is zero.

This law represents a mathematical statement of the fact that charge cannot accumulate at a node. *A node is not a circuit element*, and it certainly cannot store, destroy, or generate charge. Hence, the currents must sum to zero. A hydraulic analogy is sometimes useful here: for example, consider three water pipes joined in the shape of a Y. We define three “currents” as flowing *into* each of the three pipes. If we insist that water is always flowing, then obviously we cannot have three positive water currents, or the pipes would burst. This is a result of our defining currents independent of

the direction that water is actually flowing. Therefore, the value of either one or two of the currents as defined must be negative.

Consider the node shown in Fig. 3.2. The algebraic sum of the four currents entering the node must be zero:

$$i_A + i_B + (-i_C) + (-i_D) = 0$$

However, the law could be equally well applied to the algebraic sum of the currents *leaving* the node:

$$(-i_A) + (-i_B) + i_C + i_D = 0$$

We might also wish to equate the sum of the currents having reference arrows directed into the node to the sum of those directed out of the node:

$$i_A + i_B = i_C + i_D$$

which simply states that the sum of the currents going in must equal the sum of the currents going out.

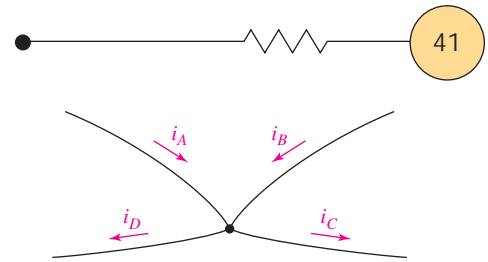

FIGURE 3.2 Example node to illustrate the application of Kirchhoff's current law.



For the circuit in Fig. 3.3a, compute the current through resistor  $R_3$  if it is known that the voltage source supplies a current of 3 A.

► **Identify the goal of the problem.**

The current through resistor  $R_3$ , labeled as  $i$  on the circuit diagram.

► **Collect the known information.**

The node at the top of  $R_3$  is connected to four branches.

Two of these currents are clearly labeled: 2 A flows out of the node into  $R_2$ , and 5 A flows into the node from the current source. We are told the current out of the 10 V source is 3 A.

► **Devise a plan.**

If we label the current through  $R_1$  (Fig. 3.3b), we may write a KCL equation at the top node of resistors  $R_2$  and  $R_3$ .

► **Construct an appropriate set of equations.**

Summing the currents flowing into the node:

$$i_{R_1} - 2 - i + 5 = 0$$

The currents flowing into this node are shown in the expanded diagram of Fig. 3.3c for clarity.

► **Determine if additional information is required.**

We have one equation but two unknowns, which means we need to obtain an additional equation. At this point, the fact that we know the 10 V source is supplying 3 A comes in handy: KCL shows us that this is also the current  $i_{R_1}$ .

► **Attempt a solution.**

Substituting, we find that  $i = 3 - 2 + 5 = 6$  A.

► **Verify the solution. Is it reasonable or expected?**

It is always worth the effort to recheck our work. Also, we can attempt to evaluate whether at least the magnitude of the solution is

### EXAMPLE 3.1

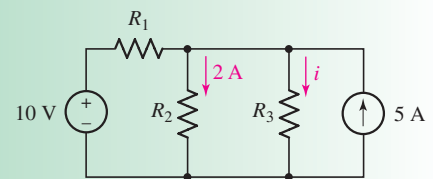

(a)

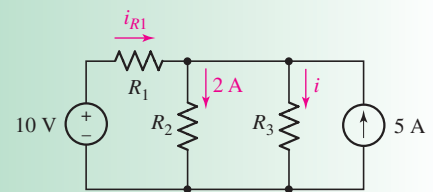

(b)

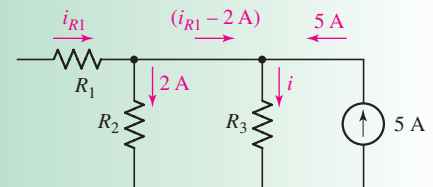

(c)

FIGURE 3.3 (a) Simple circuit for which the current through resistor  $R_3$  is desired. (b) The current through resistor  $R_1$  is labeled so that a KCL equation can be written. (c) The currents into the top node of  $R_3$  are redrawn for clarity.

(Continued on next page)

reasonable. In this case, we have two sources—one supplies 5 A, and the other supplies 3 A. There are no other sources, independent or dependent. Thus, we would not expect to find any current in the circuit in excess of 8 A.

### PRACTICE

3.1 Count the number of branches and nodes in the circuit in Fig. 3.4. If  $i_x = 3$  A and the 18 V source delivers 8 A of current, what is the value of  $R_A$ ? (Hint: You need Ohm's law as well as KCL.)

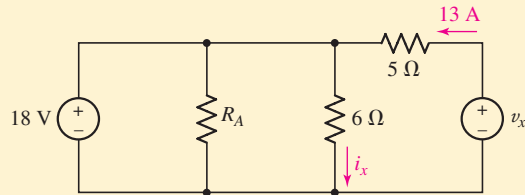

FIGURE 3.4

Ans: 5 branches, 3 nodes, 1 Ω.

A compact expression for Kirchhoff's current law is

$$\sum_{n=1}^N i_n = 0 \quad [1]$$

which is just a shorthand statement for

$$i_1 + i_2 + i_3 + \cdots + i_N = 0 \quad [2]$$



When Eq. [1] or Eq. [2] is used, it is understood that the  $N$  current arrows are either all directed toward the node in question, or are all directed away from it.

### 3.3 KIRCHHOFF'S VOLTAGE LAW

Current is related to the charge flowing *through* a circuit element, whereas voltage is a measure of potential energy difference *across* the element. There is a single unique value for any voltage in circuit theory. Thus, the energy required to move a unit charge from point  $A$  to point  $B$  in a circuit must have a value independent of the path chosen to get from  $A$  to  $B$  (there is often more than one such path). We may assert this fact through Kirchhoff's voltage law (abbreviated **KVL**):

The algebraic sum of the voltages around any closed path is zero.

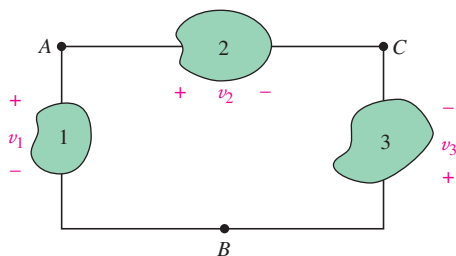

FIGURE 3.5 The potential difference between points  $A$  and  $B$  is independent of the path selected.

In Fig. 3.5, if we carry a charge of 1 C from  $A$  to  $B$  through element 1, the reference polarity signs for  $v_1$  show that we do  $v_1$  joules of work.<sup>1</sup> Now

(1) Note that we chose a 1 C charge for the sake of numerical convenience: therefore, we did  $(1 \text{ C})(v_1 \text{ J/C}) = v_1$  joules of work.

if, instead, we choose to proceed from  $A$  to  $B$  via node  $C$ , then we expend  $(v_2 - v_3)$  joules of energy. The work done, however, is independent of the path in a circuit, and so any route must lead to the same value for the voltage. In other words,

$$v_1 = v_2 - v_3 \quad [3]$$

It follows that if we trace out a closed path, the algebraic sum of the voltages across the individual elements around it must be zero. Thus, we may write

$$v_1 + v_2 + v_3 + \cdots + v_N = 0$$

or, more compactly,

$$\sum_{n=1}^N v_n = 0 \quad [4]$$

We can apply KVL to a circuit in several different ways. One method that leads to fewer equation-writing errors than others consists of moving mentally around the closed path in a clockwise direction and writing down directly the voltage of each element whose (+) terminal is entered, and writing down the negative of every voltage first met at the (-) sign. Applying this to the single loop of Fig. 3.5, we have

$$-v_1 + v_2 - v_3 = 0$$

which agrees with our previous result, Eq. [3].



### EXAMPLE 3.2

In the circuit of Fig. 3.6, find  $v_x$  and  $i_x$ .

We know the voltage across two of the three elements in the circuit. Thus, KVL can be applied immediately to obtain  $v_x$ .

Beginning with the bottom node of the 5 V source, we apply KVL clockwise around the loop:

$$-5 - 7 + v_x = 0$$

so  $v_x = 12$  V.

KCL applies to this circuit, but only tells us that the same current ( $i_x$ ) flows through all three elements. We now know the voltage across the  $100\ \Omega$  resistor, however.

Invoking Ohm's law,

$$i_x = \frac{v_x}{100} = \frac{12}{100} \text{ A} = 120 \text{ mA}$$

### PRACTICE

3.2 Determine  $i_x$  and  $v_x$  in the circuit of Fig. 3.7.

Ans:  $v_x = -4$  V;  $i_x = -400$  mA.

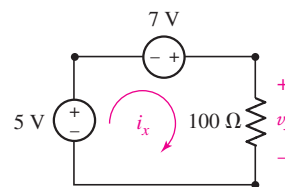

FIGURE 3.6 A simple circuit with two voltage sources and a single resistor.

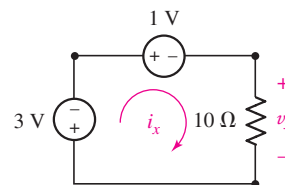

FIGURE 3.7

## EXAMPLE 3.3

In the circuit of Fig. 3.8 there are eight circuit elements. Find  $v_{R2}$  (the voltage across  $R_2$ ) and the voltage labeled  $v_x$ .

The best approach for finding  $v_{R2}$  is to look for a loop to which we can apply KVL. There are several options, but the leftmost loop offers a straightforward route, as two of the voltages are clearly specified. Thus, we find  $v_{R2}$  by writing a KVL equation around the loop on the left, starting at point  $c$ :

$$4 - 36 + v_{R2} = 0$$

which leads to  $v_{R2} = 32 \text{ V}$ .

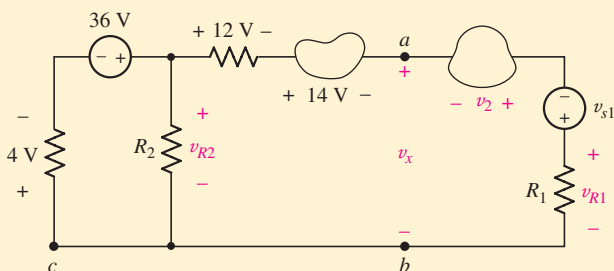

FIGURE 3.8 A circuit with eight elements for which we desire  $v_{R2}$  and  $v_x$ .

To find  $v_x$ , we might think of this as the (algebraic) sum of the voltages across the three elements on the right. However, since we do not have values for these quantities, such an approach would not lead to a numerical answer. Instead, we apply KVL beginning at point  $c$ , moving up and across the top to  $a$ , through  $v_x$  to  $b$ , and through the conducting lead to the starting point:

$$+4 - 36 + 12 + 14 + v_x = 0$$

so that

$$v_x = 6 \text{ V}$$

**An alternative approach:** Knowing  $v_{R2}$ , we might have taken the shortcut through  $R_2$ :

$$-32 + 12 + 14 + v_x = 0$$

yielding  $v_x = 6 \text{ V}$  once again.

## PRACTICE

3.3 For the circuit of Fig. 3.9, determine (a)  $v_{R2}$  and (b)  $v_2$ , if  $v_{R1} = 1 \text{ V}$ .

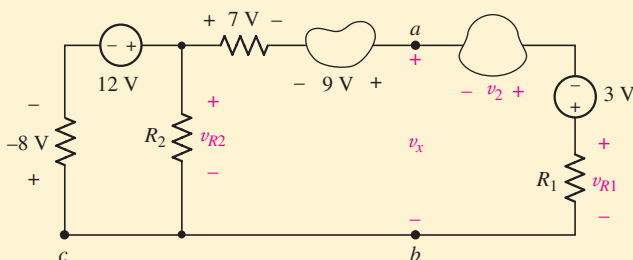

FIGURE 3.9

Ans: (a) 4 V; (b) -8 V.

Points  $b$  and  $c$ , as well as the wire between them, are all part of the same node.

As we have just seen, the key to correctly analyzing a circuit is to first methodically label all voltages and currents on the diagram. This way, carefully written KCL or KVL equations will yield correct relationships, and Ohm's law can be applied as necessary if more unknowns than equations are obtained initially. We illustrate these principles with a more detailed example.

## EXAMPLE 3.4

Determine  $v_x$  in the circuit of Fig. 3.10a.

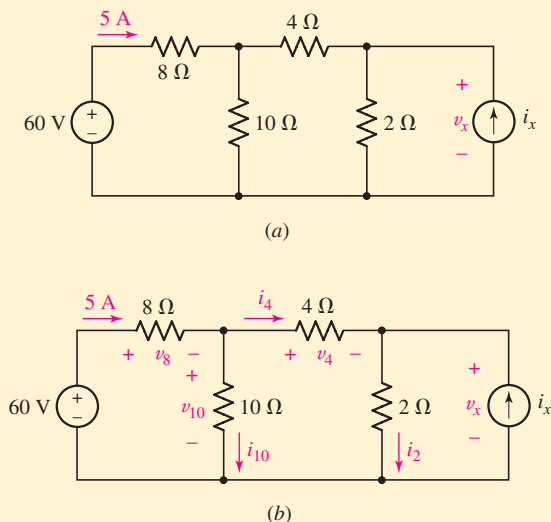

FIGURE 3.10 (a) A circuit for which  $v_x$  is to be determined using KVL. (b) Circuit with voltages and currents labeled.

We begin by labeling voltages and currents on the rest of the elements in the circuit (Fig. 3.10b). Note that  $v_x$  appears across the  $2\ \Omega$  resistor and the source  $i_x$  as well.

If we can obtain the current through the  $2\ \Omega$  resistor, Ohm's law will yield  $v_x$ . Writing the appropriate KCL equation, we see that

$$i_2 = i_4 + i_x$$

Unfortunately, we do not have values for any of these three quantities. Our solution has (temporarily) stalled.

Since we were given the current flowing from the  $60\ \text{V}$  source, perhaps we should consider starting from that side of the circuit. Instead of finding  $v_x$  using  $i_2$ , it might be possible to find  $v_x$  directly using KVL. We can write the following KVL equations:

$$-60 + v_8 + v_{10} = 0$$

and

$$-v_{10} + v_4 + v_x = 0 \quad [5]$$

This is progress: we now have two equations in four unknowns, an improvement over one equation in which *all* terms were unknown. In fact, we know that  $v_8 = 40\ \text{V}$  through Ohm's law, as we were told that  $5\ \text{A}$  flows through the  $8\ \Omega$  resistor. Thus,  $v_{10} = 0 + 60 - 40 = 20\ \text{V}$ ,

(Continued on next page)

so Eq. [5] reduces to

$$v_x = 20 - v_4$$

If we can determine  $v_4$ , the problem is solved.

The best route to finding a numerical value for the voltage  $v_4$  in this case is to employ Ohm's law, which requires a value for  $i_4$ . From KCL, we see that

$$i_4 = 5 - i_{10} = 5 - \frac{v_{10}}{10} = 5 - \frac{20}{10} = 3$$

so that  $v_4 = (4)(3) = 12$  V and hence  $v_x = 20 - 12 = 8$  V.

### PRACTICE

3.4 Determine  $v_x$  in the circuit of Fig. 3.11.

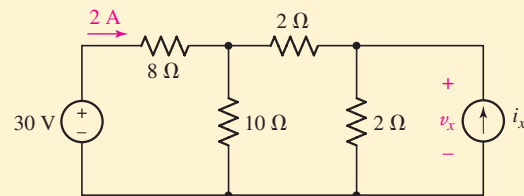
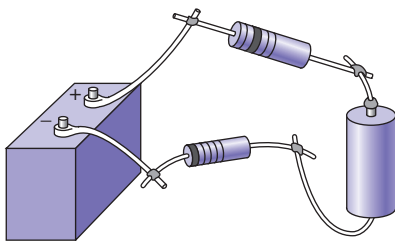
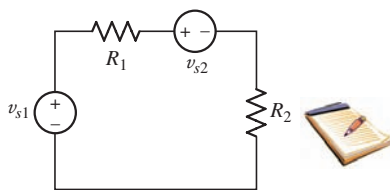

FIGURE 3.11

Ans:  $v_x = 12.8$  V.



(a)



(b)

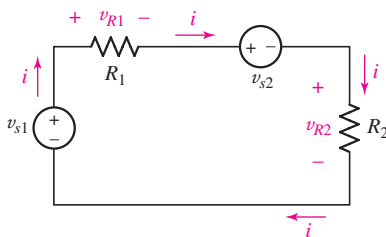

(c)

FIGURE 3.12 (a) A single-loop circuit with four elements. (b) The circuit model with source voltages and resistance values given. (c) Current and voltage reference signs have been added to the circuit.

## 3.4 THE SINGLE-LOOP CIRCUIT

We have seen that repeated use of KCL and KVL in conjunction with Ohm's law can be applied to nontrivial circuits containing several loops and a number of different elements. Before proceeding further, this is a good time to focus on the concept of series (and, in the next section, parallel) circuits, as they form the basis of any network we will encounter in the future.

All of the elements in a circuit that carry the same current are said to be connected in *series*. As an example, consider the circuit of Fig. 3.10. The 60 V source is in series with the 8 Ω resistor; they carry the same 5 A current. However, the 8 Ω resistor is not in series with the 4 Ω resistor; they carry different currents. Note that elements may carry equal currents and not be in series; two 100 W light bulbs in neighboring houses may very well carry equal currents, but they certainly do not carry the same current and are *not* connected in series.

Figure 3.12a shows a simple circuit consisting of two batteries and two resistors. Each terminal, connecting lead, and solder glob is assumed to have zero resistance; together they constitute an individual node of the circuit diagram in Fig. 3.12b. Both batteries are modeled by ideal voltage sources; any internal resistances they may have are assumed to be small enough to neglect. The two resistors are assumed to be ideal (linear) resistors.

We seek the current *through* each element, the voltage *across* each element, and the power *absorbed* by each element. Our first step in the analysis is the assumption of reference directions for the unknown currents. Arbitrarily, let us select a clockwise current  $i$  which flows out of the upper terminal of the voltage source on the left. This choice is indicated by an arrow labeled  $i$  at that point in the circuit, as shown in Fig. 3.12c. A trivial



application of Kirchhoff's current law assures us that this same current must also flow through every other element in the circuit; we emphasize this fact this one time by placing several other current symbols about the circuit.

Our second step in the analysis is a choice of the voltage reference for each of the two resistors. The passive sign convention requires that the resistor current and voltage variables be defined so that the current enters the terminal at which the positive voltage reference is located. Since we already (arbitrarily) selected the current direction,  $v_{R1}$  and  $v_{R2}$  are defined as in Fig. 3.12c.

The third step is the application of Kirchhoff's voltage law to the only closed path. Let us decide to move around the circuit in the clockwise direction, beginning at the lower left corner, and to write down directly every voltage first met at its positive reference, and to write down the negative of every voltage encountered at the negative terminal. Thus,

$$-v_{s1} + v_{R1} + v_{s2} + v_{R2} = 0 \quad [6]$$

We then apply Ohm's law to the resistive elements:

$$v_{R1} = R_1 i \quad \text{and} \quad v_{R2} = R_2 i$$

Substituting into Eq. [6] yields

$$-v_{s1} + R_1 i + v_{s2} + R_2 i = 0$$

Since  $i$  is the only unknown, we find that

$$i = \frac{v_{s1} - v_{s2}}{R_1 + R_2}$$

The voltage or power associated with any element may now be obtained by applying  $v = Ri$ ,  $p = vi$ , or  $p = i^2R$ .

### PRACTICE

3.5 In the circuit of Fig. 3.12b,  $v_{s1} = 120$  V,  $v_{s2} = 30$  V,  $R_1 = 30 \Omega$ , and  $R_2 = 15 \Omega$ . Compute the power absorbed by each element.

Ans:  $p_{120\text{V}} = -240$  W;  $p_{30\text{V}} = +60$  W;  $p_{30\Omega} = 120$  W;  $p_{15\Omega} = 60$  W.

### EXAMPLE 3.5

Compute the power absorbed in each element for the circuit shown in Fig. 3.13a.

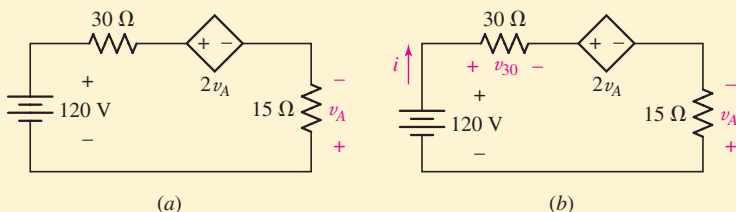
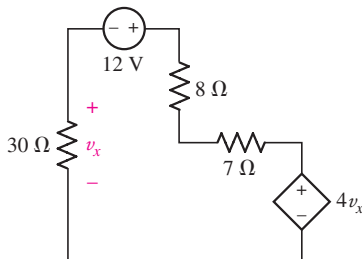

FIGURE 3.13 (a) A single-loop circuit containing a dependent source. (b) The current  $i$  and voltage  $v_{30}$  are assigned.

(Continued on next page)



■ FIGURE 3.14 A simple loop circuit.

We first assign a reference direction for the current  $i$  and a reference polarity for the voltage  $v_{30}$  as shown in Fig. 3.13b. There is no need to assign a voltage to the  $15\ \Omega$  resistor, since the controlling voltage  $v_A$  for the dependent source is already available. (It is worth noting, however, that the reference signs for  $v_A$  are reversed from those we would have assigned based on the passive sign convention.)

This circuit contains a dependent voltage source, the value of which remains unknown until we determine  $v_A$ . However, its algebraic value  $2v_A$  can be used in the same fashion as if a numerical value were available. Thus, applying KVL around the loop:

$$-120 + v_{30} + 2v_A - v_A = 0 \quad [7]$$

Using Ohm's law to introduce the known resistor values:

$$v_{30} = 30i \quad \text{and} \quad v_A = -15i$$

Note that the negative sign is required since  $i$  flows into the negative terminal of  $v_A$ .

Substituting into Eq. [7] yields

$$-120 + 30i - 30i + 15i = 0$$

and so we find that

$$i = 8\ \text{A}$$

Computing the power *absorbed* by each element:

$$p_{120\text{V}} = (120)(-8) = -960\ \text{W}$$

$$p_{30\Omega} = (8)^2(30) = 1920\ \text{W}$$

$$p_{\text{dep}} = (2v_A)(8) = 2[(-15)(8)](8) \\ = -1920\ \text{W}$$

$$p_{15\Omega} = (8)^2(15) = 960\ \text{W}$$

### PRACTICE

3.6 In the circuit of Fig. 3.14, find the power absorbed by each of the five elements in the circuit.

Ans: (CW from left) 0.768 W, 1.92 W, 0.2048 W, 0.1792 W,  $-3.072\ \text{W}$ .

In the preceding example and practice problem, we were asked to compute the power absorbed by each element of a circuit. It is difficult to think of a situation, however, in which *all* of the absorbed power quantities of a circuit would be positive, for the simple reason that the energy must come from somewhere. Thus, from simple conservation of energy, we expect that ***the sum of the absorbed power for each element of a circuit should be zero.*** In





other words, at least one of the quantities should be negative (neglecting the trivial case where the circuit is not operating). Stated another way, the sum of the supplied power for each element should be zero. More pragmatically, *the sum of the absorbed power equals the sum of the supplied power*, which seems reasonable enough at face value.

Let's test this with the circuit of Fig. 3.13 from Example 3.5, which consists of two sources (one dependent and one independent) and two resistors. Adding the power absorbed by each element, we find

$$\sum_{\text{all elements}} p_{\text{absorbed}} = -960 + 1920 - 1920 + 960 = 0$$

In reality (our indication is the sign associated with the absorbed power) the 120 V source *supplies* +960 W, and the dependent source supplies +1920 W. Thus, the sources supply a total of  $960 + 1920 = 2880$  W. The resistors are expected to absorb positive power, which in this case sums to a total of  $1920 + 960 = 2880$  W. Thus, if we take into account each element of the circuit,

$$\sum p_{\text{absorbed}} = \sum p_{\text{supplied}}$$

as we expect.

Turning our attention to Practice Problem 3.6, the solution to which the reader might want to verify, we see that the absorbed powers sum to  $0.768 + 1.92 + 0.2048 + 0.1792 - 3.072 = 0$ . Interestingly enough, the 12 V independent voltage source is absorbing +1.92 W, which means it is *dissipating* power, not supplying it. Instead, the dependent voltage source appears to be supplying all the power in this particular circuit. Is such a thing possible? We usually expect a source to supply positive power, but since we are employing idealized sources in our circuits, it is in fact possible to have a net power flow into any source. If the circuit is changed in some way, the same source might then be found to supply positive power. The result is not known until a circuit analysis has been completed.

### 3.5 THE SINGLE-NODE-PAIR CIRCUIT

The companion of the single-loop circuit discussed in Sec. 3.4 is the single-node-pair circuit, in which any number of simple elements are connected between the same pair of nodes. An example of such a circuit is shown in Fig. 3.15a. KVL forces us to recognize that the voltage across each branch is the same as that across any other branch. *Elements in a circuit having a common voltage across them are said to be connected in parallel.*

#### EXAMPLE 3.6

**Find the voltage, current, and power associated with each element in the circuit of Fig. 3.15a.**

We first define a voltage  $v$  and arbitrarily select its polarity as shown in Fig. 3.15b. Two currents, flowing in the resistors, are selected in conformance with the passive sign convention, as shown in Fig. 3.15b.

*(Continued on next page)*

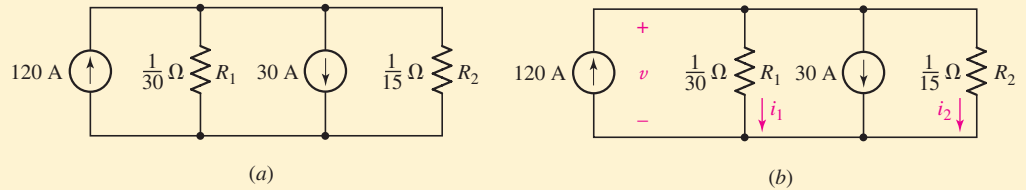

■ FIGURE 3.15 (a) A single-node-pair circuit. (b) A voltage and two currents are assigned.

Determining either current  $i_1$  or  $i_2$  will enable us to obtain a value for  $v$ . Thus, our next step is to apply KCL to either of the two nodes in the circuit. Equating the algebraic sum of the currents leaving the upper node to zero:

$$-120 + i_1 + 30 + i_2 = 0$$

Writing both currents in terms of the voltage  $v$  using Ohm's law

$$i_1 = 30v \quad \text{and} \quad i_2 = 15v$$

we obtain

$$-120 + 30v + 30 + 15v = 0$$

Solving this equation for  $v$  results in

$$v = 2 \text{ V}$$

and invoking Ohm's law then gives

$$i_1 = 60 \text{ A} \quad \text{and} \quad i_2 = 30 \text{ A}$$

The absorbed power in each element can now be computed. In the two resistors,

$$p_{R1} = 30(2)^2 = 120 \text{ W} \quad \text{and} \quad p_{R2} = 15(2)^2 = 60 \text{ W}$$

and for the two sources,

$$p_{120\text{A}} = 120(-2) = -240 \text{ W} \quad \text{and} \quad p_{30\text{A}} = 30(2) = 60 \text{ W}$$

Since the 120 A source absorbs negative 240 W, it is actually *supplying* power to the other elements in the circuit. In a similar fashion, we find that the 30 A source is actually *absorbing* power rather than *supplying* it.

## PRACTICE

3.7 Determine  $v$  in the circuit of Fig. 3.16.

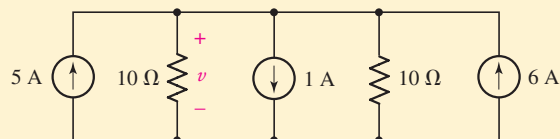

■ FIGURE 3.16

Ans: 50 V.

## EXAMPLE 3.7

Determine the value of  $v$  and the power supplied by the independent current source in Fig. 3.17.

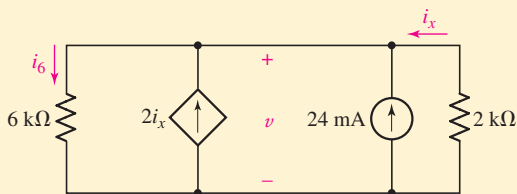

FIGURE 3.17 A voltage  $v$  and a current  $i_6$  are assigned in a single-node-pair circuit containing a dependent source.

By KCL, the sum of the currents leaving the upper node must be zero, so that

$$i_6 - 2i_x - 0.024 - i_x = 0$$

Again, note that the value of the dependent source ( $2i_x$ ) is treated the same as any other current would be, even though its exact value is not known until the circuit has been analyzed.

We next apply Ohm's law to each resistor:

$$i_6 = \frac{v}{6000} \quad \text{and} \quad i_x = \frac{-v}{2000}$$

Therefore,

$$\frac{v}{6000} - 2\left(\frac{-v}{2000}\right) - 0.024 - \left(\frac{-v}{2000}\right) = 0$$

and so  $v = (600)(0.024) = 14.4$  V.

Any other information we may want to find for this circuit is now easily obtained, usually in a single step. For example, the power supplied by the independent source is  $p_{24} = 14.4(0.024) = 0.3456$  W (345.6 mW).

## PRACTICE

3.8 For the single-node-pair circuit of Fig. 3.18, find  $i_A$ ,  $i_B$ , and  $i_C$ .

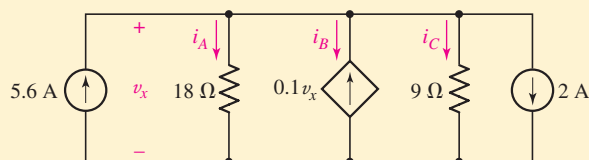
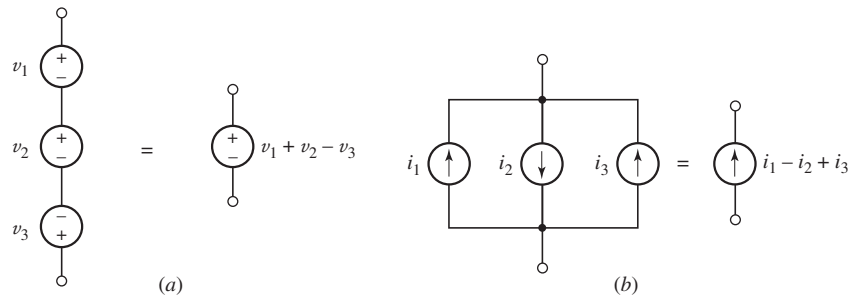

FIGURE 3.18

Ans: 3 A;  $-5.4$  A; 6 A.

## 3.6 SERIES AND PARALLEL CONNECTED SOURCES

It turns out that some of the equation writing that we have been doing for series and parallel circuits can be avoided by combining sources. Note, however, that all the current, voltage, and power relationships in the remainder of the circuit will be unchanged. For example, several voltage



■ FIGURE 3.19 (a) Series-connected voltage sources can be replaced by a single source. (b) Parallel current sources can be replaced by a single source.

sources in series may be replaced by an equivalent voltage source having a voltage equal to the algebraic sum of the individual sources (Fig. 3.19a). Parallel current sources may also be combined by algebraically adding the individual currents, and the order of the parallel elements may be rearranged as desired (Fig. 3.19b).

### EXAMPLE 3.8

**Determine the current  $i$  in the circuit of Fig. 3.20a by first combining the sources into a single equivalent voltage source.**

To be able to combine the voltage sources, they must be in series. Since the same current ( $i$ ) flows through each, this condition is satisfied.

Starting from the bottom left-hand corner and proceeding clockwise,

$$-3 - 9 - 5 + 1 = -16 \text{ V}$$

so we may replace the four voltage sources with a single 16 V source having its negative reference as shown in Fig. 3.20b.

KVL combined with Ohm's law then yields

$$-16 + 100i + 220i = 0$$

or

$$i = \frac{16}{320} = 50 \text{ mA}$$

We should note that the circuit in Fig. 3.20c is also equivalent, a fact easily verified by computing  $i$ .

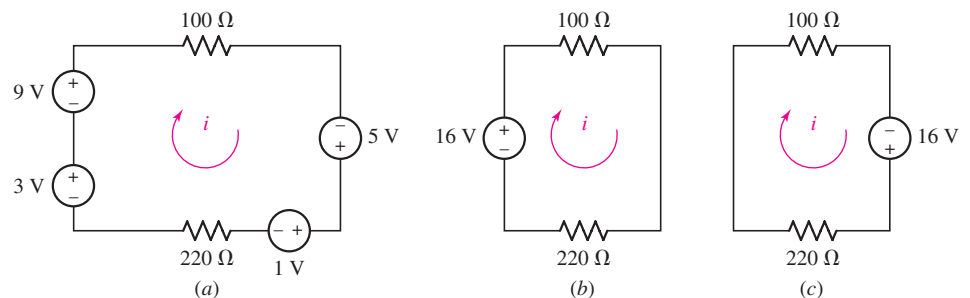

■ FIGURE 3.20

**PRACTICE**

3.9 Determine the current  $i$  in the circuit of Fig. 3.21 after first replacing the four sources with a single equivalent source.

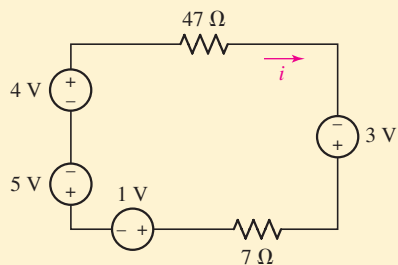

■ FIGURE 3.21

Ans:  $-54$  A.

**EXAMPLE 3.9**

Determine the voltage  $v$  in the circuit of Fig. 3.22a by first combining the sources into a single equivalent current source.

The sources may be combined if the same voltage appears across each one, which we can easily verify is the case. Thus, we create a new source, arrow pointing upward into the top node, by adding the currents that flow into that node:

$$2.5 - 2.5 - 3 = -3 \text{ A}$$

One equivalent circuit is shown in Fig. 3.22b.

KCL then allows us to write

$$-3 + \frac{v}{5} + \frac{v}{5} = 0$$

Solving, we find  $v = 7.5$  V.

Another equivalent circuit is shown in Fig. 3.22c.

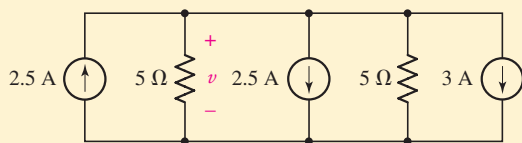

(a)

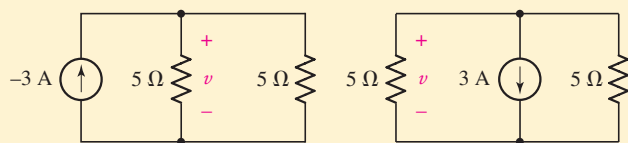

(b)

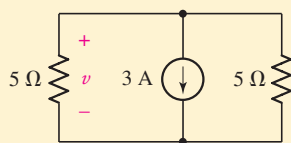

(c)

■ FIGURE 3.22

(Continued on next page)

## PRACTICE

3.10 Determine the voltage  $v$  in the circuit of Fig. 3.23 after first replacing the three sources with a single equivalent source.

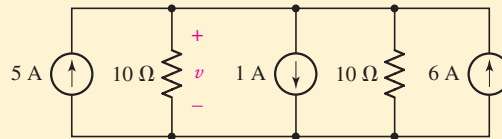

FIGURE 3.23

Ans: 50 V.

To conclude the discussion of parallel and series source combinations, we should consider the parallel combination of two voltage sources and the series combination of two current sources. For instance, what is the equivalent of a 5 V source in parallel with a 10 V source? By the definition of a voltage source, the voltage across the source cannot change; by Kirchhoff's voltage law, then, 5 equals 10 and we have hypothesized a physical impossibility. Thus, *ideal* voltage sources in parallel are permissible only when each has the same terminal voltage at every instant. In a similar way, two current sources may not be placed in series unless each has the same current, including sign, for every instant of time.

## EXAMPLE 3.10

Determine which of the circuits of Fig. 3.24 are valid.

The circuit of Fig. 3.24a consists of two voltage sources in parallel. The value of each source is different, so this circuit violates KVL. For example, if a resistor is placed in parallel with the 5 V source, it is also in parallel with the 10 V source. The actual voltage across it is therefore ambiguous, and clearly the circuit cannot be constructed as indicated. If we attempt to build such a circuit in real life, we will find it impossible to locate “ideal” voltage sources—all real-world sources have an internal resistance. The presence of such resistance allows a voltage difference between the two *real* sources. Along these lines, the circuit of Fig. 3.24b is perfectly valid.

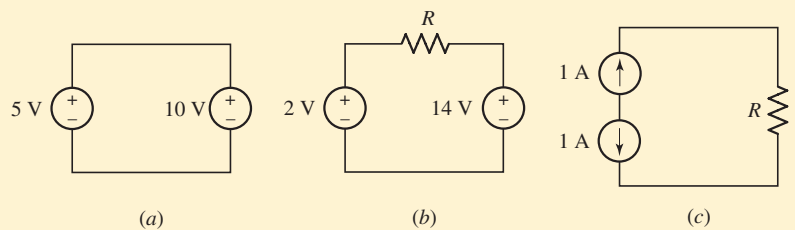

FIGURE 3.24 (a) to (c) Examples of circuits with multiple sources, some of which violate Kirchhoff's laws.



The circuit of Fig. 3.24c violates KCL: it is unclear what current actually flows through the resistor  $R$ .

### PRACTICE

3.11 Determine whether the circuit of Fig. 3.25 violates either of Kirchhoff's laws.

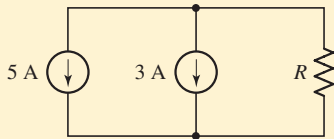

FIGURE 3.25

Ans: No. If the resistor were removed, however, the resulting circuit would.

## 3.7 RESISTORS IN SERIES AND PARALLEL

It is often possible to replace relatively complicated resistor combinations with a single equivalent resistor. This is useful when we are not specifically interested in the current, voltage, or power associated with any of the individual resistors in the combinations. *All the current, voltage, and power relationships in the remainder of the circuit will be unchanged.*

Consider the series combination of  $N$  resistors shown in Fig. 3.26a. We want to simplify the circuit with replacing the  $N$  resistors with a single resistor  $R_{\text{eq}}$  so that the remainder of the circuit, in this case only the voltage source, does not realize that any change has been made. The current, voltage, and power of the source must be the same before and after the replacement.

First, apply KVL:

$$v_s = v_1 + v_2 + \cdots + v_N$$

and then Ohm's law:

$$v_s = R_1 i + R_2 i + \cdots + R_N i = (R_1 + R_2 + \cdots + R_N) i$$

Now compare this result with the simple equation applying to the equivalent circuit shown in Fig. 3.26b:

$$v_s = R_{\text{eq}} i$$

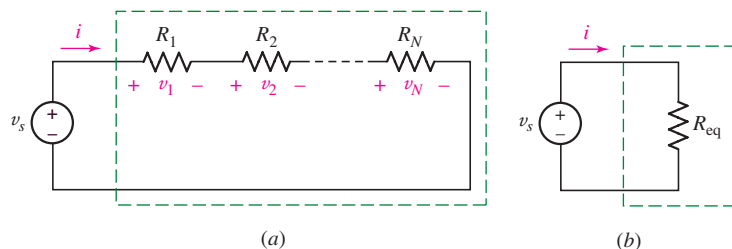

FIGURE 3.26 (a) Series combination of  $N$  resistors. (b) Electrically equivalent circuit.

Helpful Tip: Inspection of the KVL equation for any series circuit will show that *the order* in which elements are placed in such a circuit *makes no difference*.

Thus, the value of the equivalent resistance for  $N$  series resistors is

$$R_{\text{eq}} = R_1 + R_2 + \cdots + R_N \quad [8]$$

We are therefore able to replace a two-terminal network consisting of  $N$  series resistors with a single two-terminal element  $R_{\text{eq}}$  that has the same  $v$ - $i$  relationship.



It should be emphasized again that we might be interested in the current, voltage, or power of one of the original elements. For example, the voltage of a dependent voltage source may depend upon the voltage across  $R_3$ . Once  $R_3$  is combined with several series resistors to form an equivalent resistance, then it is gone and the voltage across it cannot be determined until  $R_3$  is identified by removing it from the combination. In that case, it would have been better to look ahead and not make  $R_3$  a part of the combination initially.

### EXAMPLE 3.11

**Use resistance and source combinations to determine the current  $i$  in Fig. 3.27a and the power delivered by the 80 V source.**

We first interchange the element positions in the circuit, being careful to preserve the proper sense of the sources, as shown in Fig. 3.27b. The

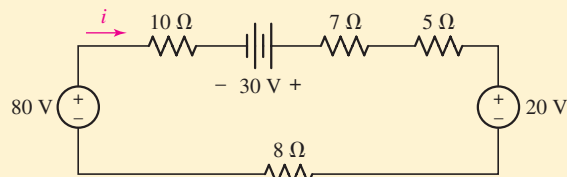

(a)

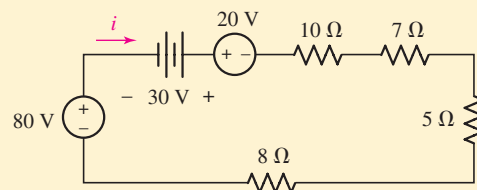

(b)

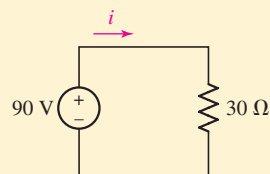

(c)

■ FIGURE 3.27 (a) A series circuit with several sources and resistors. (b) The elements are rearranged for the sake of clarity. (c) A simpler equivalent.

next step is to then combine the three voltage sources into an equivalent 90 V source, and the four resistors into an equivalent 30  $\Omega$  resistance, as in Fig. 3.27c. Thus, instead of writing

$$-80 + 10i - 30 + 7i + 5i + 20 + 8i = 0$$

we have simply

$$-90 + 30i = 0$$

and so we find that

$$i = 3 \text{ A}$$

In order to calculate the power delivered to the circuit by the 80 V source appearing in the given circuit, it is necessary to return to Fig. 3.27a with the knowledge that the current is 3 A. The desired power is then  $80 \text{ V} \times 3 \text{ A} = 240 \text{ W}$ .

It is interesting to note that no element of the original circuit remains in the equivalent circuit.

## PRACTICE

3.12 Determine  $i$  in the circuit of Fig. 3.28.

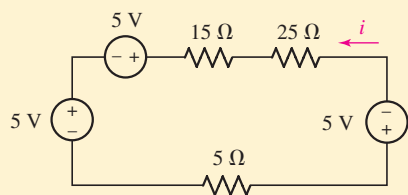

FIGURE 3.28

Ans:  $-333 \text{ mA}$ .

Similar simplifications can be applied to parallel circuits. A circuit containing  $N$  resistors in parallel, as in Fig. 3.29a, leads to the KCL equation

$$i_s = i_1 + i_2 + \cdots + i_N$$

or

$$\begin{aligned} i_s &= \frac{v}{R_1} + \frac{v}{R_2} + \cdots + \frac{v}{R_N} \\ &= \frac{v}{R_{\text{eq}}} \end{aligned}$$

Thus,

$$\frac{1}{R_{\text{eq}}} = \frac{1}{R_1} + \frac{1}{R_2} + \cdots + \frac{1}{R_N}$$

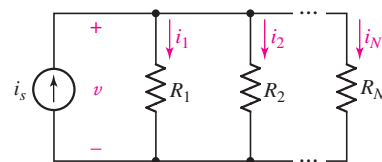

(a)

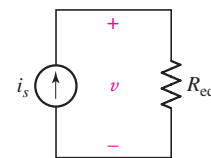

(b)

[9]

FIGURE 3.29 (a) A circuit with  $N$  resistors in parallel. (b) Equivalent circuit.

which can be written as

$$R_{\text{eq}}^{-1} = R_1^{-1} + R_2^{-1} + \cdots + R_N^{-1}$$

or, in terms of conductances, as

$$G_{\text{eq}} = G_1 + G_2 + \cdots + G_N$$

The simplified (equivalent) circuit is shown in Fig. 3.29b.

A parallel combination is routinely indicated by the following shorthand notation:

$$R_{\text{eq}} = R_1 \parallel R_2 \parallel R_3$$

The special case of only two parallel resistors is encountered fairly often, and is given by

$$\begin{aligned} R_{\text{eq}} &= R_1 \parallel R_2 \\ &= \frac{1}{\frac{1}{R_1} + \frac{1}{R_2}} \end{aligned}$$

Or, more simply,

$$R_{\text{eq}} = \frac{R_1 R_2}{R_1 + R_2} \quad [10]$$



The last form is worth memorizing, although it is a common error to attempt to generalize Eq. [10] to more than two resistors, e.g.,

$$R_{\text{eq}} \not\approx \frac{R_1 R_2 R_3}{R_1 + R_2 + R_3}$$

A quick look at the units of this equation will immediately show that the expression cannot possibly be correct.

### PRACTICE

3.13 Determine  $v$  in the circuit of Fig. 3.30 by first combining the three current sources, and then the two  $10\ \Omega$  resistors.

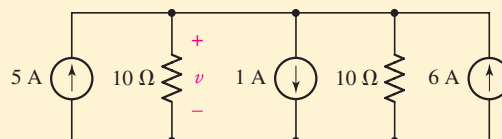
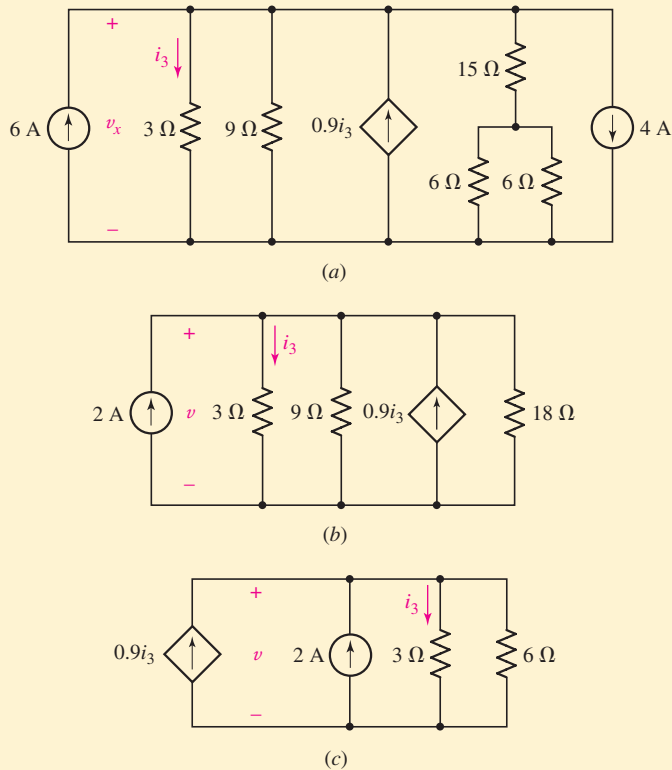

FIGURE 3.30

Ans: 50 V.

## EXAMPLE 3.12

Calculate the power and voltage of the dependent source in Fig. 3.31a.



■ FIGURE 3.31 (a) A multinode circuit. (b) The two independent current sources are combined into a 2 A source, and the 15  $\Omega$  resistor in series with the two parallel 6  $\Omega$  resistors are replaced with a single 18  $\Omega$  resistor. (c) A simplified equivalent circuit.

We will seek to simplify the circuit before analyzing it, but take care not to include the dependent source since its voltage and power characteristics are of interest.

Despite not being drawn adjacent to one another, the two independent current sources are in fact in parallel, so we replace them with a 2 A source.

The two 6  $\Omega$  resistors are in parallel and can be replaced with a single 3  $\Omega$  resistor in series with the 15  $\Omega$  resistor. Thus, the two 6  $\Omega$  resistors and the 15  $\Omega$  resistor are replaced by an 18  $\Omega$  resistor (Fig. 3.31b).

No matter how tempting, *we should not combine the remaining three resistors*; the controlling variable  $i_3$  depends on the 3  $\Omega$  resistor and so that resistor must remain untouched. The only further simplification, then, is  $9 \Omega \parallel 18 \Omega = 6 \Omega$ , as shown in Fig. 3.31c.



(Continued on next page)

Applying KCL at the top node of Fig. 3.31c, we have

$$-0.9i_3 - 2 + i_3 + \frac{v}{6} = 0$$

Employing Ohm's law,

$$v = 3i_3$$

which allows us to compute

$$i_3 = \frac{10}{3} \text{ A}$$

Thus, the voltage across the dependent source (which is the same as the voltage across the  $3 \Omega$  resistor) is

$$v = 3i_3 = 10 \text{ V}$$

The dependent source therefore furnishes  $v \times 0.9i_3 = 10(0.9)(10/3) = 30 \text{ W}$  to the remainder of the circuit.

Now if we are later asked for the power dissipated in the  $15 \Omega$  resistor, we must return to the original circuit. This resistor is in series with an equivalent  $3 \Omega$  resistor; a voltage of  $10 \text{ V}$  is across the  $18 \Omega$  total; therefore, a current of  $5/9 \text{ A}$  flows through the  $15 \Omega$  resistor and the power absorbed by this element is  $(5/9)^2(15)$  or  $4.63 \text{ W}$ .

### PRACTICE

3.14 For the circuit of Fig. 3.32, calculate the voltage  $v_x$ .

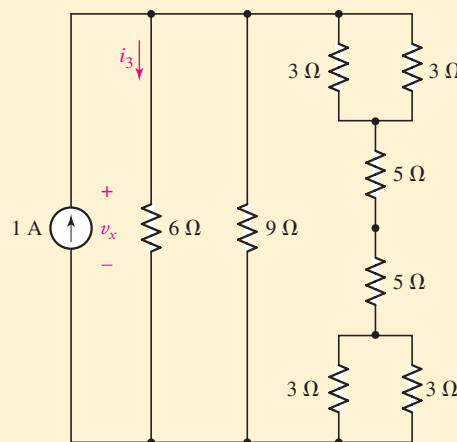
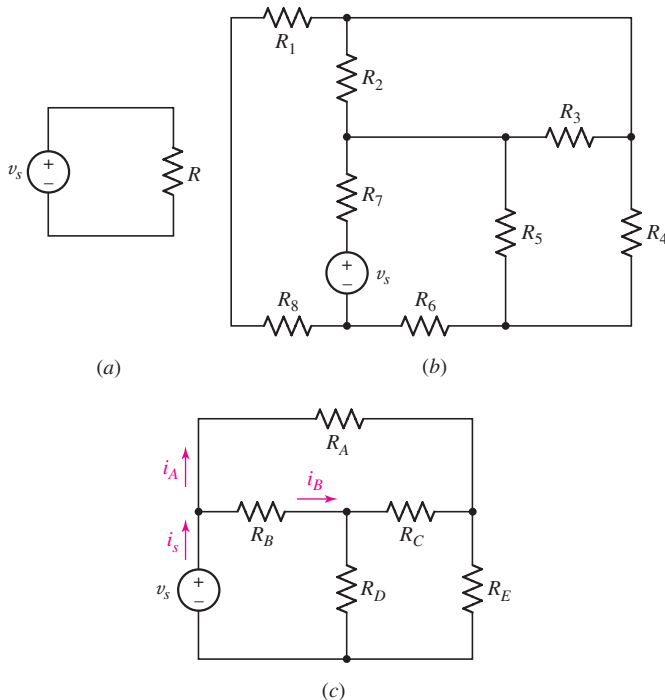

FIGURE 3.32

Ans: 2.819 V.



■ FIGURE 3.33 These two circuit elements are both in series and in parallel. (b)  $R_2$  and  $R_3$  are in parallel, and  $R_1$  and  $R_8$  are in series. (c) There are no circuit elements either in series or in parallel with one another.

Three final comments on series and parallel combinations might be helpful. The first is illustrated by referring to Fig. 3.33a and asking, “Are  $v_s$  and  $R$  in series or in parallel?” The answer is “Both.” The two elements carry the same current and are therefore in series; they also enjoy the same voltage and consequently are in parallel.

The second comment is a word of caution. Circuits can be drawn in such a way as to make series or parallel combinations difficult to spot. In Fig. 3.33b, for example, the only two resistors in parallel are  $R_2$  and  $R_3$ , while the only two in series are  $R_1$  and  $R_8$ .

The final comment is simply that a simple circuit element need not be in series or parallel with any other simple circuit element in a circuit. For example,  $R_4$  and  $R_5$  in Fig. 3.33b are not in series or parallel with any other simple circuit element, and there are no simple circuit elements in Fig. 3.33c that are in series or parallel with any other simple circuit element. In other words, we cannot simplify that circuit further using any of the techniques discussed in this chapter.



### 3.8 VOLTAGE AND CURRENT DIVISION

By combining resistances and sources, we have found one method of shortening the work of analyzing a circuit. Another useful shortcut is the application of the ideas of voltage and current division. Voltage division is used to express the voltage across one of several series resistors in terms of the

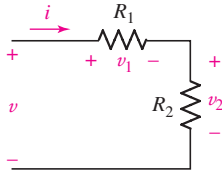

■ FIGURE 3.34 An illustration of voltage division.

voltage across the combination. In Fig. 3.34, the voltage across  $R_2$  is found via KVL and Ohm's law:

$$v = v_1 + v_2 = iR_1 + iR_2 = i(R_1 + R_2)$$

so

$$i = \frac{v}{R_1 + R_2}$$

Thus,

$$v_2 = iR_2 = \left( \frac{v}{R_1 + R_2} \right) R_2$$

or

$$v_2 = \frac{R_2}{R_1 + R_2} v$$

and the voltage across  $R_1$  is, similarly,

$$v_1 = \frac{R_1}{R_1 + R_2} v$$

If the network of Fig. 3.34 is generalized by removing  $R_2$  and replacing it with the series combination of  $R_2, R_3, \dots, R_N$ , then we have the general result for voltage division across a string of  $N$  series resistors

$$v_k = \frac{R_k}{R_1 + R_2 + \dots + R_N} v \quad [11]$$

which allows us to compute the voltage  $v_k$  that appears across an arbitrary resistor  $R_k$  of the series.

### EXAMPLE 3.13

Determine  $v_x$  in the circuit of Fig. 3.35a.

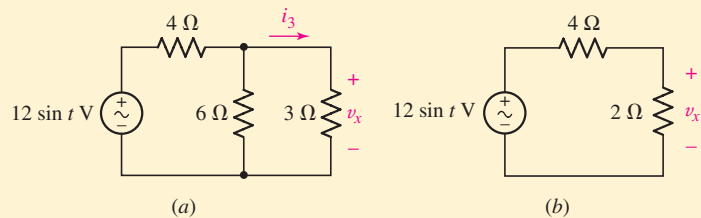

■ FIGURE 3.35 A numerical example illustrating resistance combination and voltage division. (a) Original circuit. (b) Simplified circuit.

We first combine the  $6 \Omega$  and  $3 \Omega$  resistors, replacing them with  $(6)(3)/(6 + 3) = 2 \Omega$ .

Since  $v_x$  appears across the parallel combination, our simplification has not lost this quantity. However, further simplification of the circuit by replacing the series combination of the  $4 \Omega$  resistor with our new  $2 \Omega$  resistor would.



Thus, we proceed by simply applying voltage division to the circuit in Fig. 3.35b:

$$v_x = (12 \sin t) \frac{2}{4 + 2} = 4 \sin t \quad \text{volts}$$

### PRACTICE

3.15 Use voltage division to determine  $v_x$  in the circuit of Fig. 3.36.

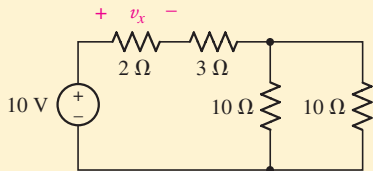

FIGURE 3.36

Ans: 2 V.

The dual<sup>2</sup> of voltage division is current division. We are now given a total current supplied to several parallel resistors, as shown in the circuit of Fig. 3.37.

The current flowing through  $R_2$  is

$$i_2 = \frac{v}{R_2} = \frac{i(R_1 \parallel R_2)}{R_2} = \frac{i}{R_2} \frac{R_1 R_2}{R_1 + R_2}$$

or

$$i_2 = i \frac{R_1}{R_1 + R_2} \quad [12]$$

and, similarly,

$$i_1 = i \frac{R_2}{R_1 + R_2} \quad [13]$$

*Nature has not smiled on us here, for these last two equations have a factor which differs subtly from the factor used with voltage division, and some effort is going to be needed to avoid errors.* Many students look on the expression for voltage division as “obvious” and that for current division as being “different.” It helps to realize that the larger of two parallel resistors always carries the smaller current.

For a parallel combination of  $N$  resistors, the current through resistor  $R_k$  is

$$i_k = i \frac{\frac{1}{R_k}}{\frac{1}{R_1} + \frac{1}{R_2} + \cdots + \frac{1}{R_N}} \quad [14]$$

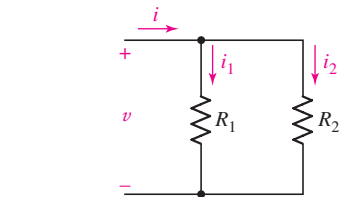

FIGURE 3.37 An illustration of current division.



(2) The principle of duality is encountered often in engineering. We will consider the topic briefly in Chap. 7 when we compare inductors and capacitors.

Written in terms of conductances,

$$i_k = i \frac{G_k}{G_1 + G_2 + \cdots + G_N}$$

which strongly resembles Eq. [11] for voltage division.

### EXAMPLE 3.14

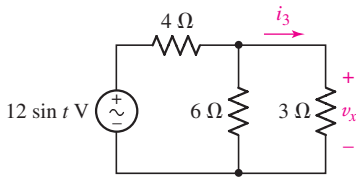

■ FIGURE 3.38 A circuit used as an example of current division. The wavy line in the voltage source symbol indicates a sinusoidal variation with time.

**Write an expression for the current through the 3 Ω resistor in the circuit of Fig. 3.38.**

The total current flowing into the 3 Ω–6 Ω combination is

$$i(t) = \frac{12 \sin t}{4 + 3 \parallel 6} = \frac{12 \sin t}{4 + 2} = 2 \sin t \quad \text{A}$$

and thus the desired current is given by current division:

$$i_3(t) = (2 \sin t) \left( \frac{6}{6 + 3} \right) = \frac{4}{3} \sin t \quad \text{A}$$

Unfortunately, current division is sometimes applied when it is not applicable. As one example, let us consider again the circuit shown in Fig. 3.33c, a circuit that we have already agreed contains no circuit elements that are in series or in parallel. Without parallel resistors, there is no way that current division can be applied. Even so, there are too many students who take a quick look at resistors  $R_A$  and  $R_B$  and try to apply current division, writing an incorrect equation such as

$$i_A \not\approx i_S \frac{R_B}{R_A + R_B}$$

Remember, *parallel resistors must be branches between the same pair of nodes.*

### PRACTICE

3.16 In the circuit of Fig. 3.39, use resistance combination methods and current division to find  $i_1$ ,  $i_2$ , and  $v_3$ .

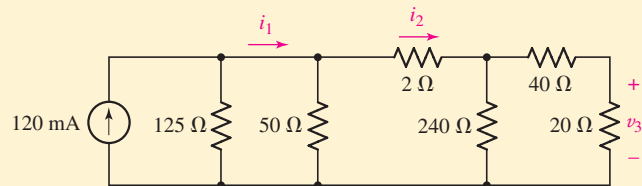

■ FIGURE 3.39

Ans: 100 mA; 50 mA; 0.8 V.

# PRACTICAL APPLICATION

## Not the Earth Ground from Geology

Up to now, we have been drawing circuit schematics in a fashion similar to that of the one shown in Fig. 3.40, where voltages are defined across two clearly marked terminals. Special care was taken to emphasize the fact that voltage cannot be defined at a single point—it is by definition the *difference* in potential between *two* points. However, many schematics make use of the convention of taking the earth as defining zero volts, so that all other voltages are implicitly referenced to this potential. The concept is often referred to as **earth ground**, and is fundamentally tied to safety regulations designed to prevent fires, fatal electrical shocks, and related mayhem. The symbol for earth ground is shown in Fig. 3.41a.

Since earth ground is defined as zero volts, it is often convenient to use this as a common terminal in schematics. The circuit of Fig. 3.40 is shown redrawn in this fashion in Fig. 3.42, where the earth ground symbol represents a common node. It is important to note that the two circuits are equivalent in terms of our value for  $v_a$  (4.5 V in either case), but are no longer exactly the same. The circuit in Fig. 3.40 is said to be “floating” in that it could for all practical purposes be installed on a circuit board of a satellite in geosynchronous orbit (or on its way to Pluto). The circuit in Fig. 3.42, however, is somehow physically connected to the ground through a conducting path. For this reason, there are two other symbols that are occasionally used to denote a common terminal. Figure 3.41b shows what is commonly referred to as **signal ground**; there can be (and often is) a large voltage between earth ground and any terminal tied to signal ground.

The fact that the common terminal of a circuit may or may not be connected by some low-resistance pathway to earth ground can lead to potentially dangerous situations. Consider the diagram of Fig. 3.43a, which depicts an innocent bystander about to touch a piece of equipment powered by an ac outlet. Only two terminals have been used from the wall socket; the round ground pin

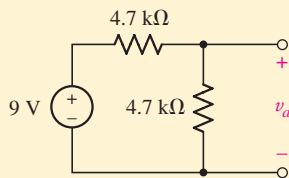

■ FIGURE 3.40 A simple circuit with a voltage  $v_a$  defined between two terminals.

of the receptacle was left unconnected. The common terminal of every circuit in the equipment has been tied together and electrically connected to the conducting equipment chassis; this terminal is often denoted using the **chassis ground** symbol of Fig. 3.41c. Unfortunately, a wiring fault exists, due to either poor manufacturing or perhaps just wear and tear. At any rate, the chassis is not “grounded,” so there is a very large resistance between chassis ground and earth ground. A pseudo-schematic (some liberty was taken with the person’s equivalent resistance symbol) of the situation is shown in Fig. 3.43b. The electrical path between the conducting chassis and ground may in fact be the table, which could represent a resistance of hundreds of megaohms or more. The resistance of the person, however, is many orders of magnitude lower. Once the person taps on the equipment to see why it isn’t working properly . . . well, let’s just say not all stories have happy endings.

The fact that “ground” is not always “earth ground” can cause a wide range of safety and electrical noise problems. One example is occasionally encountered in older buildings, where plumbing originally consisted of electrically conducting copper pipes. In such buildings, any water pipe was often treated as a low-resistance path to earth ground, and therefore used in many electrical connections. However, when corroded pipes are replaced with more modern and cost-effective

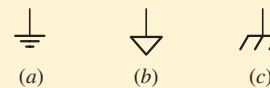

■ FIGURE 3.41 Three different symbols used to represent a ground or common terminal: (a) earth ground; (b) signal ground; (c) chassis ground.

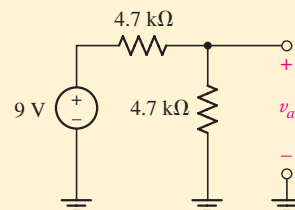

■ FIGURE 3.42 The circuit of Fig. 3.40, redrawn using the earth ground symbol. The rightmost ground symbol is redundant; it is only necessary to label the positive terminal of  $v_a$ ; the negative reference is then implicitly ground, or zero volts.

(Continued on next page)

nonconducting PVC piping, the low-resistance path to earth ground no longer exists. A related problem occurs when the composition of the earth varies greatly over a particular region. In such situations, it is possible to actually have two separated buildings in which the two

“earth grounds” are not equal, and current can flow as a result.

Within this text, the earth ground symbol will be used exclusively. It is worth remembering, however, that not all grounds are created equal in practice.

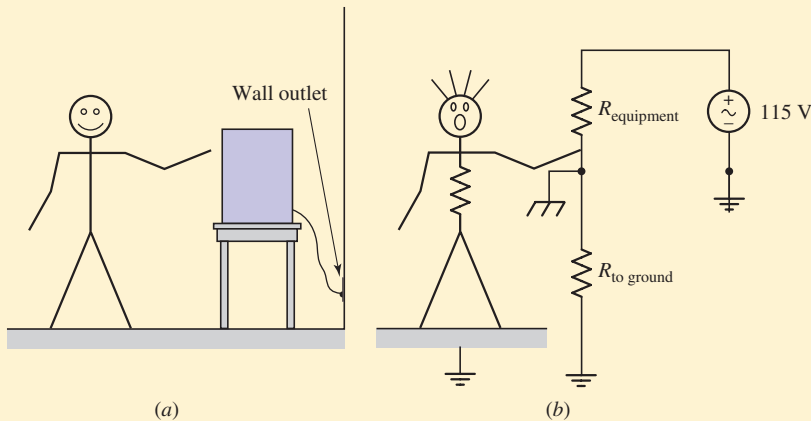

■ FIGURE 3.43 (a) A sketch of an innocent person about to touch an improperly grounded piece of equipment. It's not going to be pretty. (b) A schematic of an equivalent circuit for the situation as it is about to unfold; the person has been represented by an equivalent resistance, as has the equipment. A resistor has been used to represent the nonhuman path to ground.

## SUMMARY AND REVIEW

We began this chapter by discussing connections of circuit elements, and introducing the terms *node*, *path*, *loop*, and *branch*. The next two topics could be considered the two most important in the entire textbook, namely, Kirchhoff's current law (KCL) and Kirchhoff's voltage law. The first is derived from conservation of charge, and can be thought of in terms of “what goes in (current) must come out.” The second is based on conservation of energy, and can be viewed as “what goes up (potential) must come down.” These two laws allow us to analyze *any* circuit, linear or otherwise, provided we have a way of relating the voltage and current associated with passive elements (e.g., Ohm's law for the resistor). In the case of a single-loop circuit, the elements are connected in *series* and hence each carries the same current. The single-node-pair circuit, in which elements are connected in *parallel* with one another, is characterized by a single voltage common to each element. Extending these concepts allowed us to develop a means of simplifying voltage sources connected in series, or current sources in parallel; subsequently we obtained classic expressions for series and parallel connected resistors. The final topic, that of voltage and current division, finds considerable use in the design of circuits where a specific voltage or current is required but our choice of source is limited.

Let's conclude with key points of this chapter to review, highlighting appropriate examples.

- Kirchhoff's current law (KCL) states that the algebraic sum of the currents entering any node is zero. (Examples 3.1, 3.4)
- Kirchhoff's voltage law (KVL) states that the algebraic sum of the voltages around any closed path in a circuit is zero. (Examples 3.2, 3.3)
- All elements in a circuit that carry the same current are said to be connected in series. (Example 3.5)
- Elements in a circuit having a common voltage across them are said to be connected in parallel. (Examples 3.6, 3.7)
- Voltage sources in series can be replaced by a single source, provided care is taken to note the individual polarity of each source. (Examples 3.8, 3.10)
- Current sources in parallel can be replaced by a single source, provided care is taken to note the direction of each current arrow. (Examples 3.9, 3.10)
- A series combination of  $N$  resistors can be replaced by a single resistor having the value  $R_{\text{eq}} = R_1 + R_2 + \cdots + R_N$ . (Example 3.11)
- A parallel combination of  $N$  resistors can be replaced by a single resistor having the value

$$\frac{1}{R_{\text{eq}}} = \frac{1}{R_1} + \frac{1}{R_2} + \cdots + \frac{1}{R_N}$$

(Example 3.12)

- Voltage division allows us to calculate what fraction of the total voltage across a series string of resistors is dropped across any one resistor (or group of resistors). (Example 3.13)
- Current division allows us to calculate what fraction of the total current into a parallel string of resistors flows through any one of the resistors. (Example 3.14)

## READING FURTHER

A discussion of the principles of conservation of energy and conservation of charge, as well as Kirchhoff's laws, can be found in

R. Feynman, R. B. Leighton, and M. L. Sands, *The Feynman Lectures on Physics*. Reading, Mass.: Addison-Wesley, 1989, pp. 4-1, 4-7, and 25-9.

Detailed discussions of numerous aspects of grounding practices consistent with the 2008 National Electrical Code® can be found throughout

J. E. McPartland, B. J. McPartland, and F. P. Hartwell, *McGraw-Hill's National Electrical Code® 2008 Handbook*, 26th ed. New York, McGraw-Hill, 2008.

## EXERCISES

### 3.1 Nodes, Paths, Loops, and Branches

1. Referring to the circuit depicted in Fig. 3.44, count the number of (a) nodes; (b) elements; (c) branches.

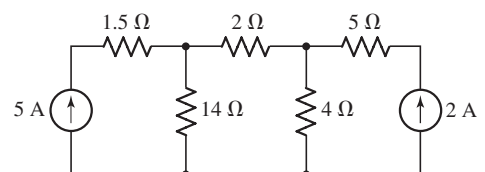

■ FIGURE 3.44

2. Referring to the circuit depicted in Fig. 3.45, count the number of (a) nodes; (b) elements; (c) branches.

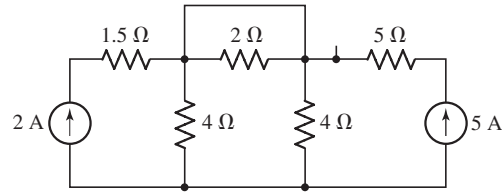

■ FIGURE 3.45

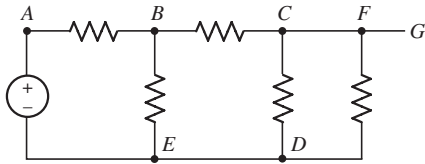

■ FIGURE 3.46

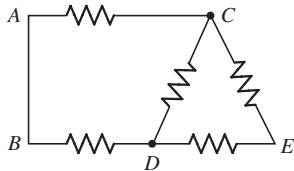

■ FIGURE 3.47

3. For the circuit of Fig. 3.46:
- Count the number of nodes.
  - In moving from A to B, have we formed a path? Have we formed a loop?
  - In moving from C to F to G, have we formed a path? Have we formed a loop?
4. For the circuit of Fig. 3.46:
- Count the number of circuit elements.
  - If we move from B to C to D, have we formed a path? Have we formed a loop?
  - If we move from E to D to C to B, have we formed a path? Have we formed a loop?
5. Refer to the circuit of Fig. 3.47, and answer the following:
- How many distinct nodes are contained in the circuit?
  - How many elements are contained in the circuit?
  - How many branches does the circuit have?
  - Determine if each of the following represents a path, a loop, both, or neither:
    - A to B
    - B to D to C to E
    - C to E to D to B to A to C
    - C to D to B to A to C to E

### 3.2 Kirchoff's Current Law

6. A local restaurant has a neon sign constructed from 12 separate bulbs; when a bulb fails, it appears as an infinite resistance and cannot conduct current. In wiring the sign, the manufacturer offers two options (Fig. 3.48). From what you've learned about KCL, which one should the restaurant owner select? Explain.

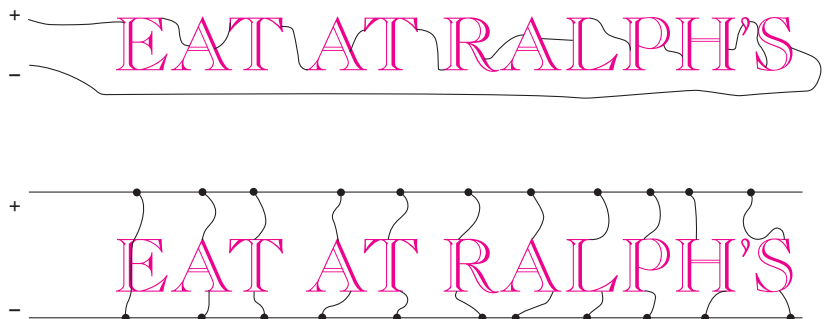

■ FIGURE 3.48

7. Referring to the single node diagram of Fig. 3.49, compute:

- (a)  $i_B$ , if  $i_A = 1$  A,  $i_D = -2$  A,  $i_C = 3$  A, and  $i_E = 0$ ;  
 (b)  $i_E$ , if  $i_A = -1$  A,  $i_B = -1$  A,  $i_C = -1$  A, and  $i_D = -1$  A.

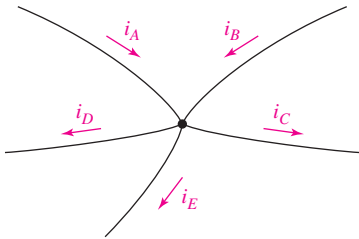

FIGURE 3.49

8. Determine the current labeled  $I$  in each of the circuits of Fig. 3.50.

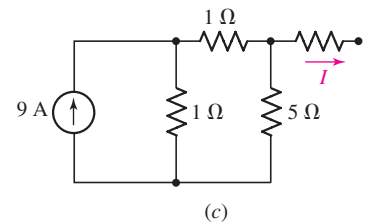
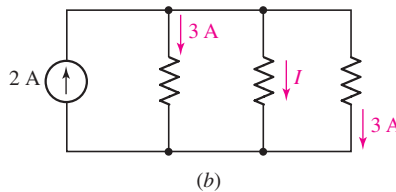
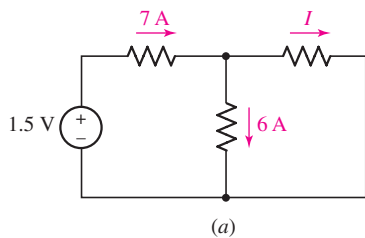

FIGURE 3.50

9. In the circuit shown in Fig. 3.51, the resistor values are unknown, but the 2 V source is known to be supplying a current of 7 A to the rest of the circuit. Calculate the current labeled  $i_2$ .

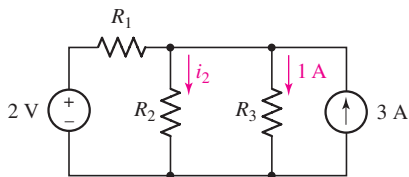

FIGURE 3.51

10. The voltage source in the circuit of Fig. 3.52 has a current of 1 A flowing out of its positive terminal into resistor  $R_1$ . Calculate the current labeled  $i_2$ .

11. In the circuit depicted in Fig. 3.53,  $i_x$  is determined to be 1.5 A, and the 9 V source supplies a current of 7.6 A (that is, a current of 7.6 A leaves the positive reference terminal of the 9 V source). Determine the value of resistor  $R_A$ .

12. For the circuit of Fig. 3.54 (which is a model for the dc operation of a bipolar junction transistor biased in forward active region),  $I_B$  is measured to be 100  $\mu$ A. Determine  $I_C$  and  $I_E$ .

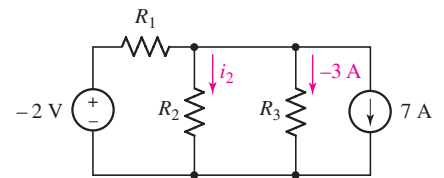

FIGURE 3.52

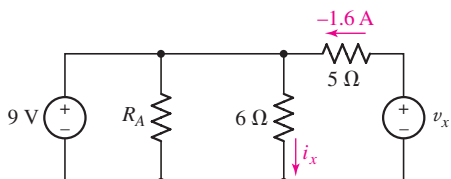

FIGURE 3.53

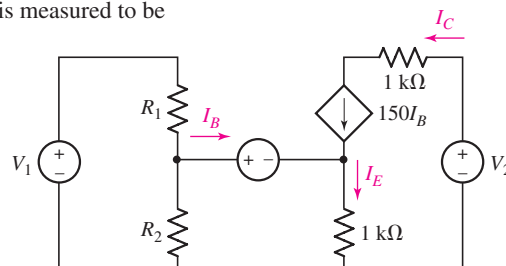
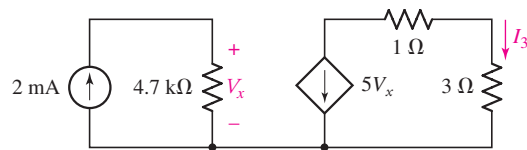

FIGURE 3.54

13. Determine the current labeled  $I_3$  in the circuit of Fig. 3.55.



■ FIGURE 3.55

14. Study the circuit depicted in Fig. 3.56, and explain (in terms of KCL) why the voltage labeled  $V_x$  must be zero.

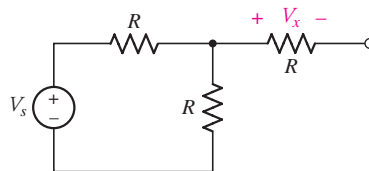

■ FIGURE 3.56

15. In many households, multiple electrical outlets within a given room are often all part of the same circuit. Draw the circuit for a four-walled room which has a single electrical outlet per wall, with a lamp (represented by a  $1 \Omega$  resistor) connected to each outlet.

### 3.3 Kirchoff's Voltage Law

16. For the circuit of Fig. 3.57:

- Determine the voltage  $v_1$  if  $v_2 = 0$  and  $v_3 = -17$  V.
- Determine the voltage  $v_1$  if  $v_2 = -2$  V and  $v_3 = +2$  V.
- Determine the voltage  $v_2$  if  $v_1 = 7$  V and  $v_3 = 9$  V.
- Determine the voltage  $v_3$  if  $v_1 = -2.33$  V and  $v_2 = -1.70$  V.

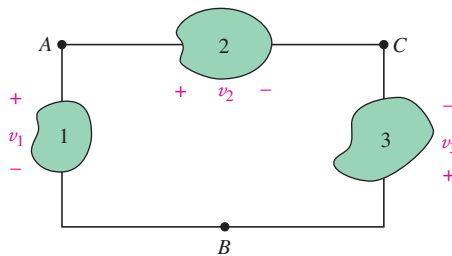

■ FIGURE 3.57

17. For each of the circuits in Fig. 3.58, determine the voltage  $v_x$  and the current  $i_x$ .

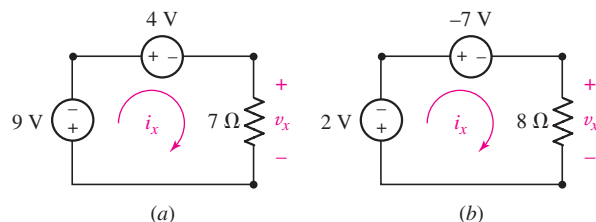

■ FIGURE 3.58



18. Use KVL to obtain a numerical value for the current labeled  $i$  in each circuit depicted in Fig. 3.59.

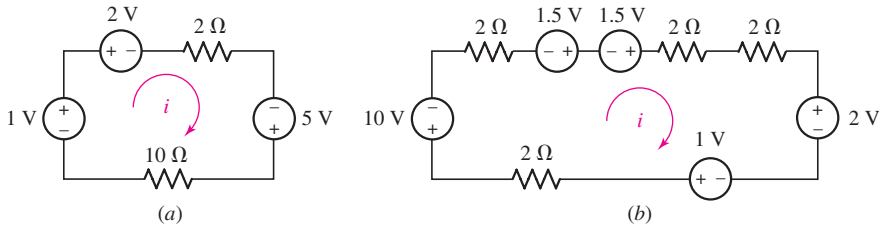

■ FIGURE 3.59

19. In the circuit of Fig. 3.60, it is determined that  $v_1 = 3$  V and  $v_3 = 1.5$  V. Calculate  $v_R$  and  $v_2$ .

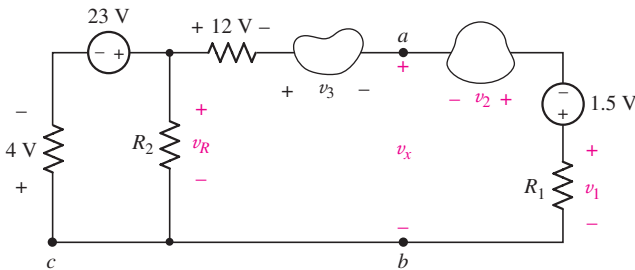

■ FIGURE 3.60

20. In the circuit of Fig. 3.60, a voltmeter is used to measure the following:  $v_1 = 2$  V and  $v_3 = -1.5$  V. Calculate  $v_x$ .
21. Determine the value of  $v_x$  as labeled in the circuit of Fig. 3.61.

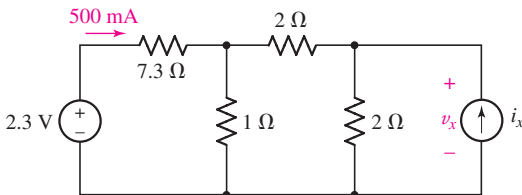

■ FIGURE 3.61

22. Consider the simple circuit shown in Fig. 3.62. Using KVL, derive the expressions

$$v_1 = v_s \frac{R_1}{R_1 + R_2} \quad \text{and} \quad v_2 = v_s \frac{R_2}{R_1 + R_2}$$

23. (a) Determine a numerical value for each current and voltage ( $i_1$ ,  $v_1$ , etc.) in the circuit of Fig. 3.63. (b) Calculate the power absorbed by each element and verify that they sum to zero.

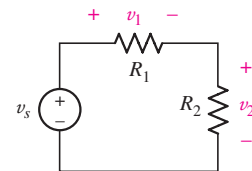

■ FIGURE 3.62

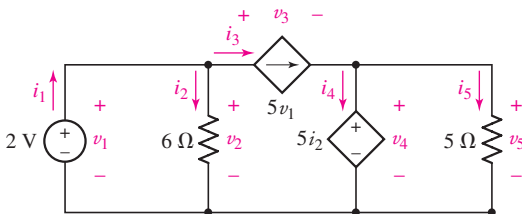

■ FIGURE 3.63

24. The circuit shown in Fig. 3.64 includes a device known as an op amp. This device has two unusual properties in the circuit shown: (1)  $V_d = 0$  V, and (2) no current can flow into either input terminal (marked “-” and “+” inside the symbol), but it *can* flow through the output terminal (marked “OUT”). This seemingly impossible situation—in direct conflict with KCL—is a result of power leads to the device that are not included in the symbol. Based on this information, calculate  $V_{out}$ . (Hint: two KVL equations are required, both involving the 5 V source.)

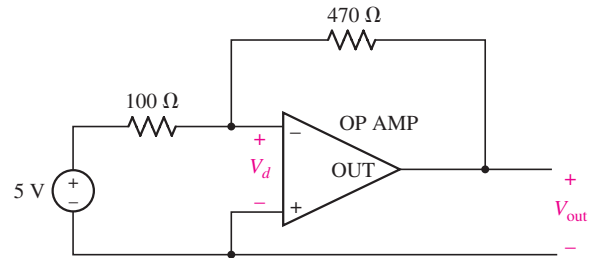

■ FIGURE 3.64

### 3.4 The Single-Loop Circuit

25. The circuit of Fig. 3.12b is constructed with the following:  $v_{s1} = -8$  V,  $R_1 = 1$   $\Omega$ ,  $v_{s2} = 16$  V, and  $R_2 = 4.7$   $\Omega$ . Calculate the power absorbed by each element. Verify that the absorbed powers sum to zero.
26. Obtain a numerical value for the power absorbed by each element in the circuit shown in Fig. 3.65.

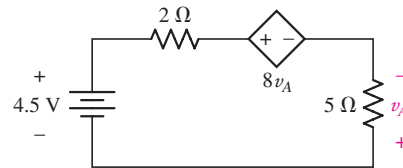

■ FIGURE 3.65

27. Compute the power absorbed by each element of the circuit of Fig. 3.66.
28. Compute the power absorbed by each element in the circuit of Fig. 3.67 if the mysterious element  $X$  is (a) a 13  $\Omega$  resistor; (b) a dependent voltage source labeled  $4v_1$ , “+” reference on top; (c) a dependent voltage source labeled  $4i_x$ , “+” reference on top.

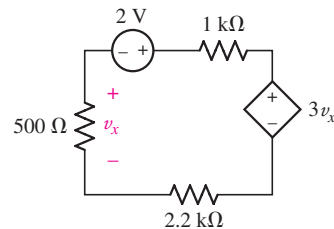

■ FIGURE 3.66

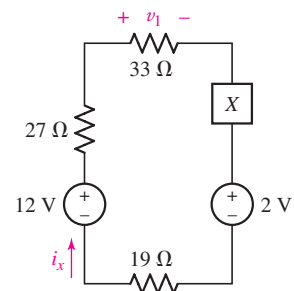

■ FIGURE 3.67

29. Kirchhoff's laws apply whether or not Ohm's law applies to a particular element. The  $I$ - $V$  characteristic of a diode, for example, is given by

$$I_D = I_S (e^{V_D/V_T} - 1)$$

where  $V_T = 27$  mV at room temperature and  $I_S$  can vary from  $10^{-12}$  to  $10^{-3}$  A. In the circuit of Fig. 3.68, use KVL/KCL to obtain  $V_D$  if  $I_S = 29$  pA. (Note: This problem results in a transcendental equation, requiring an iterative approach to obtaining a numerical solution. Most scientific calculators will perform such a function.)

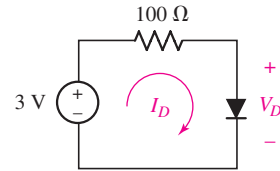

■ FIGURE 3.68

### 3.5 The Single-Node-Pair Circuit

30. Referring to the circuit of Fig. 3.69, (a) determine the two currents  $i_1$  and  $i_2$ ; (b) compute the power absorbed by each element.

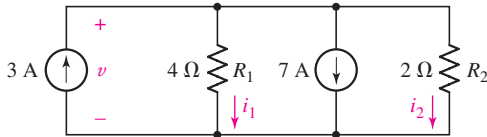

■ FIGURE 3.69

31. Determine a value for the voltage  $v$  as labeled in the circuit of Fig. 3.70, and compute the power supplied by the two current sources.

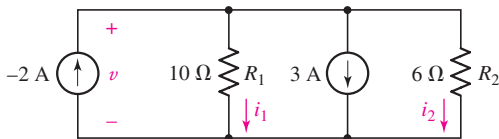

■ FIGURE 3.70

32. Referring to the circuit depicted in Fig. 3.71, determine the value of the voltage  $v$ .

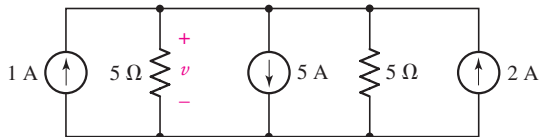

■ FIGURE 3.71

33. Determine the voltage  $v$  as labeled in Fig. 3.72, and calculate the power supplied by each current source.
34. Although drawn so that it may not appear obvious at first glance, the circuit of Fig. 3.73 is in fact a single-node-pair circuit. (a) Determine the power absorbed by each resistor. (b) Determine the power supplied by each current source. (c) Show that the sum of the absorbed power calculated in (a) is equal to the sum of the supplied power calculated in (b).

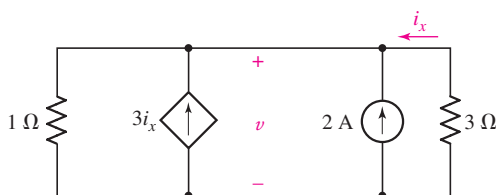

■ FIGURE 3.72

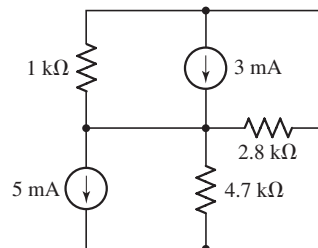

■ FIGURE 3.73

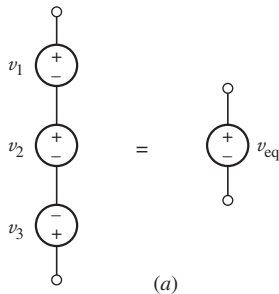

(a)

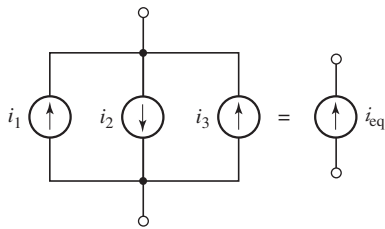

(b)

■ FIGURE 3.74

### 3.6 Series and Parallel Connected Sources

35. Determine the numerical value for  $v_{eq}$  in Fig. 3.74a, if (a)  $v_1 = 0$ ,  $v_2 = -3$  V, and  $v_3 = +3$  V; (b)  $v_1 = v_2 = v_3 = 1$  V; (c)  $v_1 = -9$  V,  $v_2 = 4.5$  V,  $v_3 = 1$  V.
36. Determine the numerical value for  $i_{eq}$  in Fig. 3.74b, if (a)  $i_1 = 0$ ,  $i_2 = -3$  A, and  $i_3 = +3$  A; (b)  $i_1 = i_2 = i_3 = 1$  A; (c)  $i_1 = -9$  A,  $i_2 = 4.5$  A,  $i_3 = 1$  A.
37. For the circuit presented in Fig. 3.75, determine the current labeled  $i$  by first combining the four sources into a single equivalent source.
38. Determine the value of  $v_1$  required to obtain a zero value for the current labeled  $i$  in the circuit of Fig. 3.76.

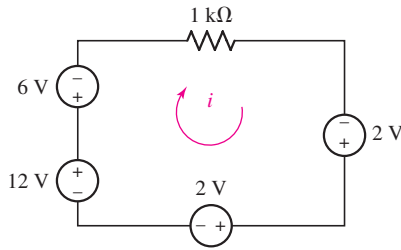

■ FIGURE 3.75

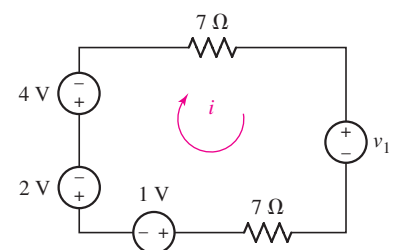

■ FIGURE 3.76

39. (a) For the circuit of Fig. 3.77, determine the value for the voltage labeled  $v$ , after first simplifying the circuit to a single current source in parallel with two resistors. (b) Verify that the power supplied by your equivalent source is equal to the sum of the supplied powers of the individual sources in the original circuit.

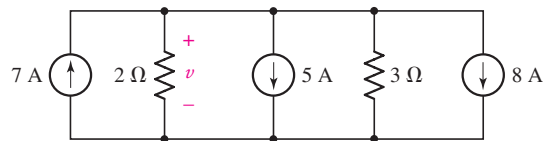

■ FIGURE 3.77

40. What value of  $I_S$  in the circuit of Fig. 3.78 will result in a zero voltage  $v$ ?

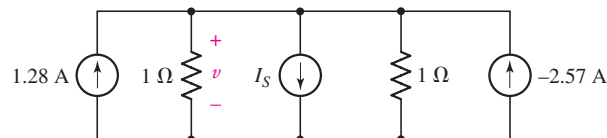

■ FIGURE 3.78

41. (a) Determine the values for  $I_X$  and  $V_Y$  in the circuit shown in Fig. 3.79. (b) Are those values necessarily unique for that circuit? Explain. (c) Simplify the circuit of Fig. 3.79 as much as possible and still maintain the values for  $v$  and  $i$ . (Your circuit must contain the  $1 \Omega$  resistor.)

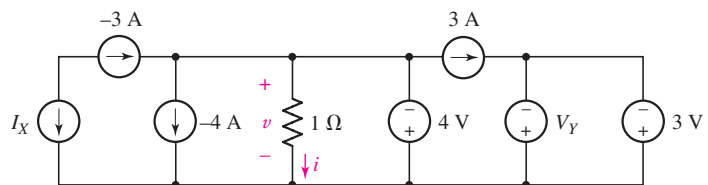

■ FIGURE 3.79

### 3.7 Resistors in Series and Parallel

42. Determine the equivalent resistance of each of the networks shown in Fig. 3.80.

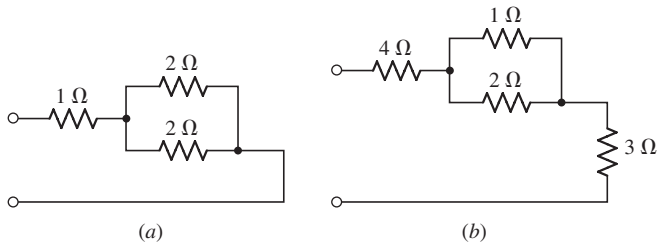

■ FIGURE 3.80

43. For each network depicted in Fig. 3.81, determine a single equivalent resistance.

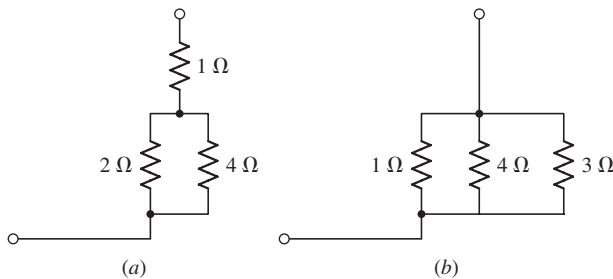

■ FIGURE 3.81

44. (a) Simplify the circuit of Fig. 3.82 as much as possible by using source and resistor combinations. (b) Calculate  $i$ , using your simplified circuit. (c) To what voltage should the 1 V source be changed to reduce  $i$  to zero? (d) Calculate the power absorbed by the 5 Ω resistor.

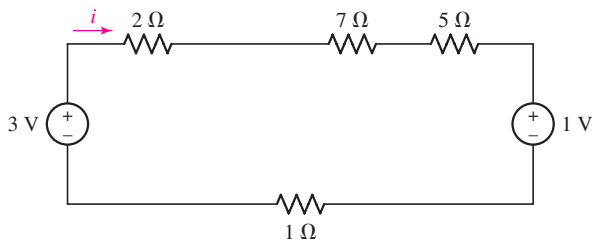

■ FIGURE 3.82

45. (a) Simplify the circuit of Fig. 3.83, using appropriate source and resistor combinations. (b) Determine the voltage labeled  $v$ , using your simplified circuit. (c) Calculate the power provided by the 2 A source to the rest of the circuit.

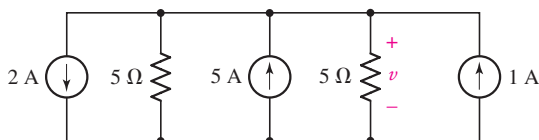

■ FIGURE 3.83

46. Making appropriate use of resistor combination techniques, calculate  $i_3$  in the circuit of Fig. 3.84 and the power provided to the circuit by the single current source.

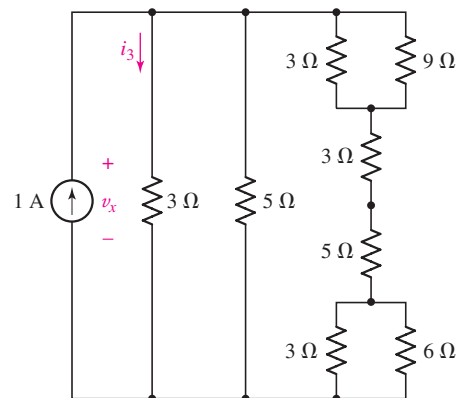

■ FIGURE 3.84

47. Calculate the voltage labeled  $v_x$  in the circuit of Fig. 3.85 after first simplifying, using appropriate source and resistor combinations.

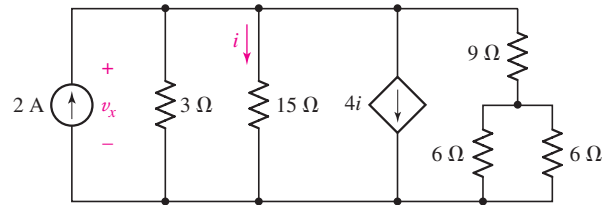

■ FIGURE 3.85

48. Determine the power absorbed by the 15 Ω resistor in the circuit of Fig. 3.86.

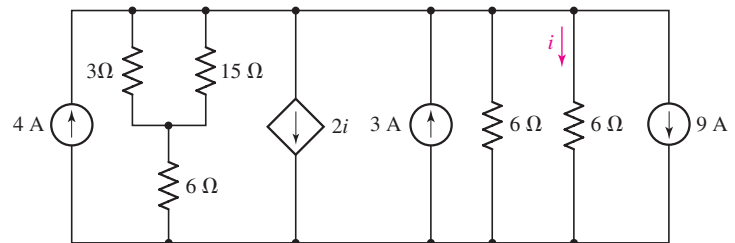

■ FIGURE 3.86

49. Calculate the equivalent resistance  $R_{eq}$  of the network shown in Fig. 3.87 if  $R_1 = 2R_2 = 3R_3 = 4R_4$  etc. and  $R_{11} = 3 \Omega$ .

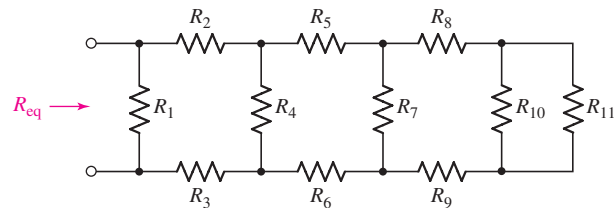

■ FIGURE 3.87

50. Show how to combine four 100 Ω resistors to obtain an equivalent resistance of (a) 25 Ω; (b) 60 Ω; (c) 40 Ω.

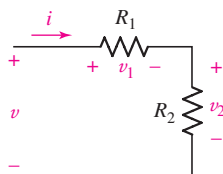

■ FIGURE 3.88

### 3.8 Voltage and Current Division

51. In the voltage divider network of Fig. 3.88, calculate (a)  $v_2$  if  $v = 9.2 \text{ V}$  and  $v_1 = 3 \text{ V}$ ; (b)  $v_1$  if  $v_2 = 1 \text{ V}$  and  $v = 2 \text{ V}$ ; (c)  $v$  if  $v_1 = 3 \text{ V}$  and  $v_2 = 6 \text{ V}$ ; (d)  $R_1/R_2$  if  $v_1 = v_2$ ; (e)  $v_2$  if  $v = 3.5 \text{ V}$  and  $R_1 = 2R_2$ ; (f)  $v_1$  if  $v = 1.8 \text{ V}$ ,  $R_1 = 1 \text{ k}\Omega$ , and  $R_2 = 4.7 \text{ k}\Omega$ .
52. In the current divider network represented in Fig. 3.89, calculate (a)  $i_1$  if  $i = 8 \text{ A}$  and  $i_2 = 1 \text{ A}$ ; (b)  $v$  if  $R_1 = 100 \text{ k}\Omega$ ,  $R_2 = 100 \text{ k}\Omega$ , and  $i = 1 \text{ mA}$ ; (c)  $i_2$  if  $i = 20 \text{ mA}$ ,  $R_1 = 1 \Omega$ , and  $R_2 = 4 \Omega$ ; (d)  $i_1$  if  $i = 10 \text{ A}$ ,  $R_1 = R_2 = 9 \Omega$ ; (e)  $i_2$  if  $i = 10 \text{ A}$ ,  $R_1 = 100 \text{ M}\Omega$ , and  $R_2 = 1 \Omega$ .

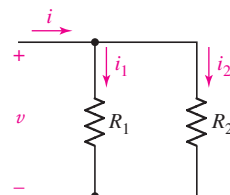

■ FIGURE 3.89

53. Choose a voltage  $v < 2.5$  V and values for the resistors  $R_1$ ,  $R_2$ ,  $R_3$ , and  $R_4$  in the circuit of Fig. 3.90 so that  $i_1 = 1$  A,  $i_2 = 1.2$  A,  $i_3 = 8$  A, and  $i_4 = 3.1$  A.
54. Employ voltage division to assist in the calculation of the voltage labeled  $v_x$  in the circuit of Fig. 3.91.
55. A network is constructed from a series connection of five resistors having values  $1 \Omega$ ,  $3 \Omega$ ,  $5 \Omega$ ,  $7 \Omega$ , and  $9 \Omega$ . If  $9$  V is connected across the terminals of the network, employ voltage division to calculate the voltage across the  $3 \Omega$  resistor, and the voltage across the  $7 \Omega$  resistor.
56. Employing resistance combination and current division as appropriate, determine values for  $i_1$ ,  $i_2$ , and  $v_3$  in the circuit of Fig. 3.92.

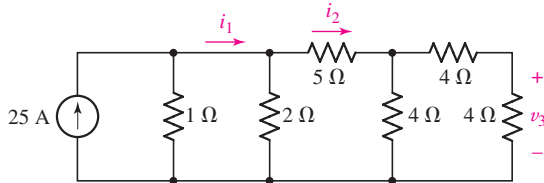

■ FIGURE 3.92

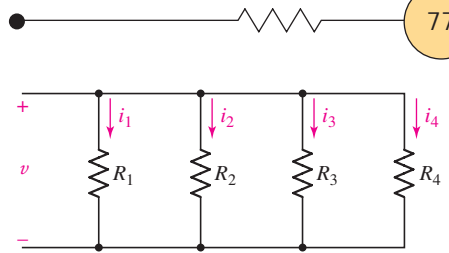

■ FIGURE 3.90

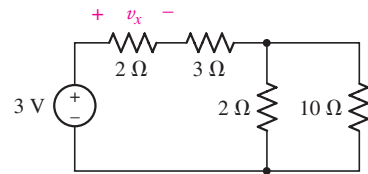

■ FIGURE 3.91

57. In the circuit of Fig. 3.93, only the voltage  $v_x$  is of interest. Simplify the circuit using appropriate resistor combinations and iteratively employ voltage division to determine  $v_x$ .

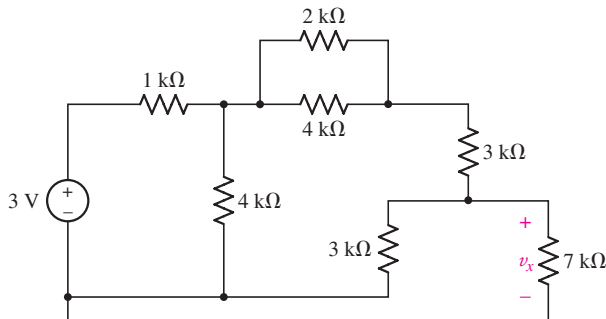

■ FIGURE 3.93

### Chapter-Integrating Exercises

58. The circuit shown in Fig. 3.94 is a linear model of a bipolar junction transistor biased in the forward active region of operation. Explain why voltage division is not a valid approach for determining the voltage across either  $10$  k $\Omega$  resistor.

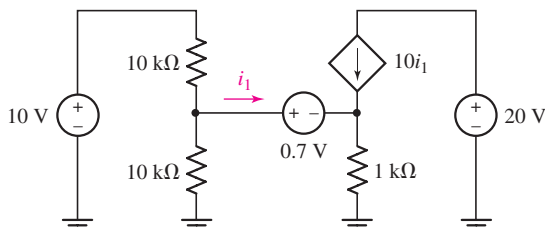

■ FIGURE 3.94

59. A common midfrequency model for a field effect–based amplifier circuit is shown in Fig. 3.95. If the controlling parameter  $g_m$  (known as the *transconductance*) is equal to 1.2 mS, employ current division to obtain the current through the 1 k $\Omega$  resistor, and then calculate the amplifier output voltage  $v_{out}$ .

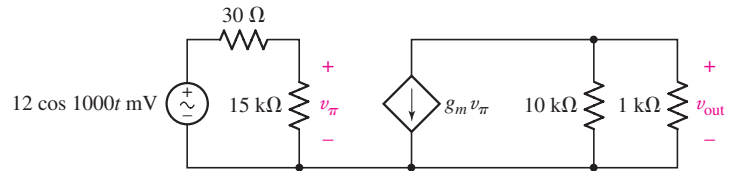

■ FIGURE 3.95

60. The circuit depicted in Fig. 3.96 is routinely employed to model the midfrequency operation of a bipolar junction transistor–based amplifier. Calculate the amplifier output  $v_{out}$  if the transconductance  $g_m$  is equal to 322 mS.

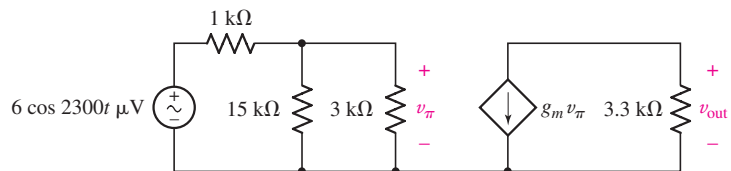

■ FIGURE 3.96

61. With regard to the circuit shown in Fig. 3.97, compute (a) the voltage across the two 10  $\Omega$  resistors, assuming the top terminal is the positive reference; (b) the power dissipated by the 4  $\Omega$  resistor.

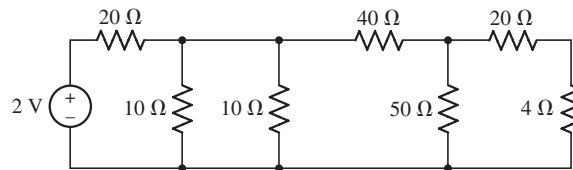

■ FIGURE 3.97

62. Delete the leftmost 10  $\Omega$  resistor in the circuit of Fig. 3.97, and compute (a) the current flowing into the left-hand terminal of the 40  $\Omega$  resistor; (b) the power supplied by the 2 V source; (c) the power dissipated by the 4  $\Omega$  resistor.
63. Consider the seven-element circuit depicted in Fig. 3.98. (a) How many nodes, loops, and branches does it contain? (b) Calculate the current flowing through each resistor. (c) Determine the voltage across the current source, assuming the top terminal is the positive reference terminal.

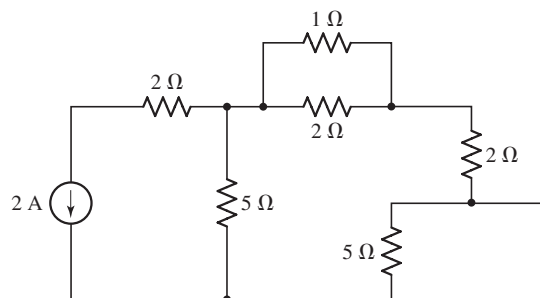

■ FIGURE 3.98



# Basic Nodal and Mesh Analysis

## INTRODUCTION

Armed with the trio of Ohm's and Kirchhoff's laws, analyzing a simple linear circuit to obtain useful information such as the current, voltage, or power associated with a particular element is perhaps starting to seem a straightforward enough venture. Still, for the moment at least, every circuit seems unique, requiring (to some degree) a measure of creativity in approaching the analysis. In this chapter, we learn two basic circuit analysis techniques—*nodal analysis* and *mesh analysis*—both of which allow us to investigate many different circuits with a consistent, methodical approach. The result is a streamlined analysis, a more uniform level of complexity in our equations, fewer errors and, perhaps most importantly, a reduced occurrence of “*I don't know how to even start!*”

Most of the circuits we have seen up to now have been rather simple and (to be honest) of questionable practical use. Such circuits are valuable, however, in helping us to learn to apply fundamental techniques. Although the more complex circuits appearing in this chapter may represent a variety of electrical systems including control circuits, communication networks, motors, or integrated circuits, as well as electric circuit models of nonelectrical systems, we believe it best not to dwell on such specifics at this early stage. Rather, it is important to initially focus on the *methodology of problem solving* that we will continue to develop throughout the book.

## KEY CONCEPTS

Nodal Analysis

The Supernode Technique

Mesh Analysis

The Supermesh Technique

Choosing Between Nodal and Mesh Analysis

Computer-Aided Analysis, Including PSpice and MATLAB



## 4.1 NODAL ANALYSIS

We begin our study of general methods for methodical circuit analysis by considering a powerful method based on KCL, namely *nodal analysis*. In Chap. 3 we considered the analysis of a simple circuit containing only two nodes. We found that the major step of the analysis was obtaining a single equation in terms of a single unknown quantity—the voltage between the pair of nodes.

We will now let the number of nodes increase and correspondingly provide one additional unknown quantity and one additional equation for each added node. Thus, a three-node circuit should have two unknown voltages and two equations; a 10-node circuit will have nine unknown voltages and nine equations; an  $N$ -node circuit will need  $(N - 1)$  voltages and  $(N - 1)$  equations. Each equation is a simple KCL equation.

To illustrate the basic technique, consider the three-node circuit shown in Fig. 4.1a, redrawn in Fig. 4.1b to emphasize the fact that there are only three nodes, numbered accordingly. Our goal will be to determine the voltage across each element, and the next step in the analysis is critical. We designate one node as a *reference node*; it will be the negative terminal of our  $N - 1 = 2$  nodal voltages, as shown in Fig. 4.1c.

A little simplification in the resultant equations is obtained if the node connected to the greatest number of branches is identified as the reference node. If there is a ground node, it is usually most convenient to select it as the reference node, although many people seem to prefer selecting the bottom node of a circuit as the reference, especially if no explicit ground is noted.

The voltage of node 1 *relative to the reference node* is named  $v_1$ , and  $v_2$  is defined as the voltage of node 2 with respect to the reference node. These

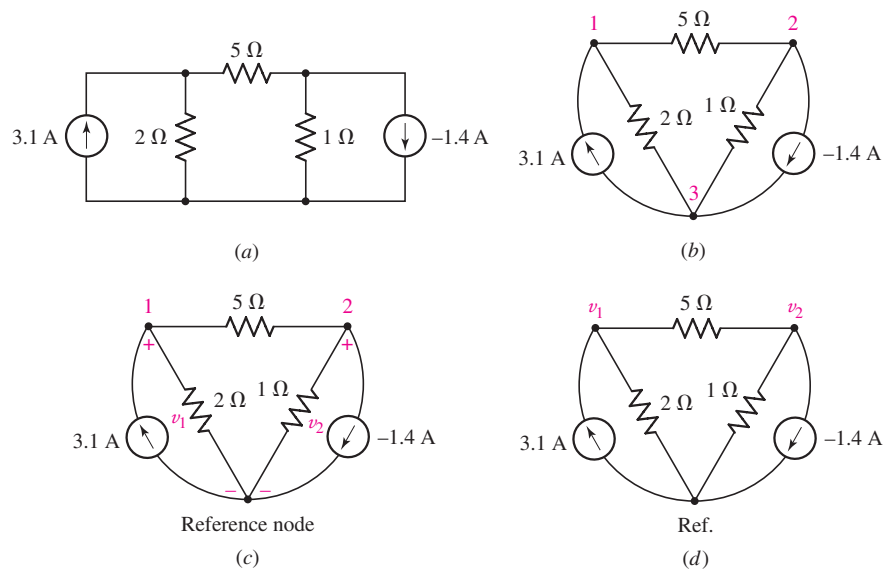

■ FIGURE 4.1 (a) A simple three-node circuit. (b) Circuit redrawn to emphasize nodes. (c) Reference node selected and voltages assigned. (d) Shorthand voltage references. If desired, an appropriate ground symbol may be substituted for "Ref."

two voltages are all we need, as the voltage between any other pair of nodes may be found in terms of them. For example, the voltage of node 1 with respect to node 2 is  $v_1 - v_2$ . The voltages  $v_1$  and  $v_2$  and their reference signs are shown in Fig. 4.1c. It is common practice once a reference node has been labeled to omit the reference signs for the sake of clarity; the node labeled with the voltage is taken to be the positive terminal (Fig. 4.1d). This is understood to be a type of shorthand voltage notation.

We now apply KCL to nodes 1 and 2. We do this by equating the total current leaving the node through the several resistors to the total source current entering the node. Thus,

$$\frac{v_1}{2} + \frac{v_1 - v_2}{5} = 3.1 \quad [1]$$

or

$$0.7v_1 - 0.2v_2 = 3.1 \quad [2]$$

At node 2 we obtain

$$\frac{v_2}{1} + \frac{v_2 - v_1}{5} = -(-1.4) \quad [3]$$

or

$$-0.2v_1 + 1.2v_2 = 1.4 \quad [4]$$

Equations [2] and [4] are the desired two equations in two unknowns, and they may be solved easily. The results are  $v_1 = 5$  V and  $v_2 = 2$  V.

From this, it is straightforward to determine the voltage across the  $5\ \Omega$  resistor:  $v_{5\Omega} = v_1 - v_2 = 3$  V. The currents and absorbed powers may also be computed in one step.

We should note at this point that there is more than one way to write the KCL equations for nodal analysis. For example, the reader may prefer to sum all the currents entering a given node and set this quantity to zero. Thus, for node 1 we might have written

$$3.1 - \frac{v_1}{2} - \frac{v_1 - v_2}{5} = 0$$

or

$$3.1 + \frac{-v_1}{2} + \frac{v_2 - v_1}{5} = 0$$

either of which is equivalent to Eq. [1].

*Is one way better than any other?* Every instructor and every student develop a personal preference, and at the end of the day the most important thing is to be consistent. The authors prefer constructing KCL equations for nodal analysis in such a way as to end up with all current source terms on one side and all resistor terms on the other. Specifically,

$$\begin{aligned} \sum \text{currents entering the node from current sources} \\ = \sum \text{currents leaving the node through resistors} \end{aligned}$$

There are several advantages to such an approach. First, there is never any confusion regarding whether a term should be " $v_1 - v_2$ " or " $v_2 - v_1$ ;" the

The reference node in a schematic is implicitly defined as zero volts. However, it is important to remember that any terminal can be designated as the reference terminal. Thus, the reference node is at zero volts with respect to the other defined nodal voltages, and not necessarily with respect to *earth* ground.

first voltage in every resistor current expression corresponds to the node for which a KCL equation is being written, as seen in Eqs. [1] and [3]. Second, it allows a quick check that a term has not been accidentally omitted. Simply count the current sources connected to a node and then the resistors; grouping them in the stated fashion makes the comparison a little easier.

### EXAMPLE 4.1

**Determine the current flowing left to right through the 15  $\Omega$  resistor of Fig. 4.2a.**

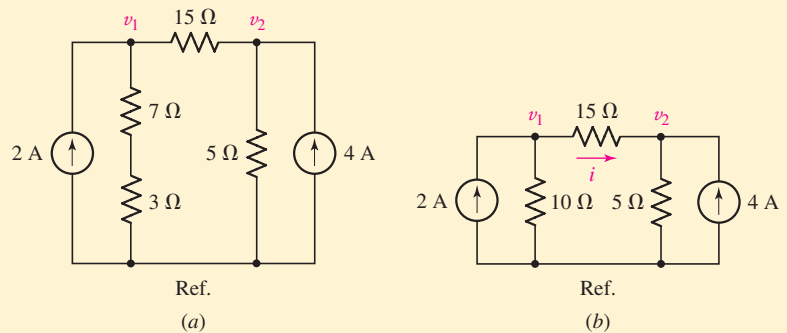

■ FIGURE 4.2 (a) A four-node circuit containing two independent current sources. (b) The two resistors in series are replaced with a single 10  $\Omega$  resistor, reducing the circuit to three nodes.

Nodal analysis will directly yield numerical values for the nodal voltages  $v_1$  and  $v_2$ , and the desired current is given by  $i = (v_1 - v_2)/15$ .

Before launching into nodal analysis, however, we first note that no details regarding either the 7  $\Omega$  resistor or the 3  $\Omega$  resistor are of interest. Thus, we may replace their series combination with a 10  $\Omega$  resistor as in Fig. 4.2b. The result is a reduction in the number of equations to solve.

Writing an appropriate KCL equation for node 1,

$$2 = \frac{v_1}{10} + \frac{v_1 - v_2}{15} \quad [5]$$

and for node 2,

$$4 = \frac{v_2}{5} + \frac{v_2 - v_1}{15} \quad [6]$$

Rearranging, we obtain

$$5v_1 - 2v_2 = 60$$

and

$$-v_1 + 4v_2 = 60$$

Solving, we find that  $v_1 = 20$  V and  $v_2 = 20$  V so that  $v_1 - v_2 = 0$ . In other words, **zero current** is flowing through the 15  $\Omega$  resistor in this circuit!

## PRACTICE

4.1 For the circuit of Fig. 4.3, determine the nodal voltages  $v_1$  and  $v_2$ .

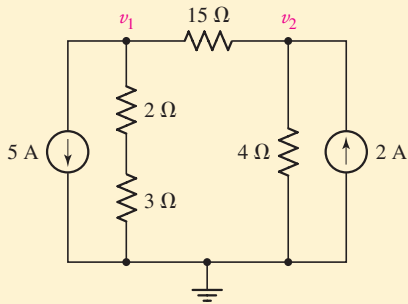

FIGURE 4.3

Ans:  $v_1 = -145/8$  V,  $v_2 = 5/2$  V.

Now let us increase the number of nodes so that we may use this technique to work a slightly more difficult problem.

## EXAMPLE 4.2

Determine the nodal voltages for the circuit of Fig. 4.4a, as referenced to the bottom node.

► **Identify the goal of the problem.**

There are four nodes in this circuit. With the bottom node as our reference, we label the other three nodes as shown in Fig. 4.4b. The circuit has been redrawn for clarity, taking care to identify the two relevant nodes for the  $4\ \Omega$  resistor.

► **Collect the known information.**

We have three unknown voltages,  $v_1$ ,  $v_2$ , and  $v_3$ . All current sources and resistors have designated values, which are marked on the schematic.

► **Devise a plan.**

This problem is well suited to nodal analysis, as three independent KCL equations may be written in terms of the current sources and the current through each resistor.

► **Construct an appropriate set of equations.**

We begin by writing a KCL equation for node 1:

$$-8 - 3 = \frac{v_1 - v_2}{3} + \frac{v_1 - v_3}{4}$$

or

$$0.5833v_1 - 0.3333v_2 - 0.25v_3 = -11 \quad [7]$$

At node 2:

$$-(-3) = \frac{v_2 - v_1}{3} + \frac{v_2}{1} + \frac{v_2 - v_3}{7}$$

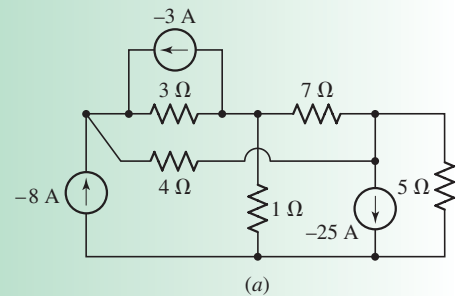

(a)

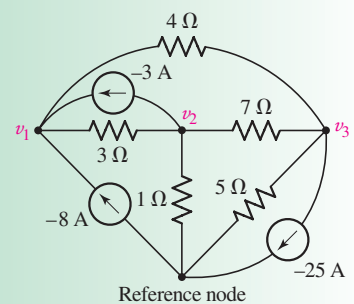

(b)

FIGURE 4.4 (a) A four-node circuit. (b) Redrawn circuit with reference node chosen and voltages labeled.

(Continued on next page)

or

$$-0.3333v_1 + 1.4762v_2 - 0.1429v_3 = 3 \quad [8]$$

And, at node 3:

$$-(-25) = \frac{v_3}{5} + \frac{v_3 - v_2}{7} + \frac{v_3 - v_1}{4}$$

or, more simply,

$$-0.25v_1 - 0.1429v_2 + 0.5929v_3 = 25 \quad [9]$$

► **Determine if additional information is required.**

We have three equations in three unknowns. Provided that they are independent, this is sufficient to determine the three voltages.

► **Attempt a solution.**

Equations [7] through [9] can be solved using a scientific calculator (Appendix 5), software packages such as MATLAB, or more traditional “plug-and-chug” techniques such as elimination of variables, matrix methods, or Cramer’s rule. Using the latter method, described in Appendix 2, we have

$$v_1 = \frac{\begin{vmatrix} -11 & -0.3333 & -0.2500 \\ 3 & 1.4762 & -0.1429 \\ 25 & -0.1429 & 0.5929 \end{vmatrix}}{\begin{vmatrix} 0.5833 & -0.3333 & -0.2500 \\ -0.3333 & 1.4762 & -0.1429 \\ -0.2500 & -0.1429 & 0.5929 \end{vmatrix}} = \frac{1.714}{0.3167} = 5.412 \text{ V}$$

Similarly,

$$v_2 = \frac{\begin{vmatrix} 0.5833 & -11 & -0.2500 \\ -0.3333 & 3 & -0.1429 \\ -0.2500 & 25 & 0.5929 \end{vmatrix}}{0.3167} = \frac{2.450}{0.3167} = 7.736 \text{ V}$$

and

$$v_3 = \frac{\begin{vmatrix} 0.5833 & -0.3333 & -11 \\ -0.3333 & 1.4762 & 3 \\ -0.2500 & -0.1429 & 25 \end{vmatrix}}{0.3167} = \frac{14.67}{0.3167} = 46.32 \text{ V}$$

► **Verify the solution. Is it reasonable or expected?**

Substituting the nodal voltages into any of our three nodal equations is sufficient to ensure we made no computational errors. Beyond that, is it possible to determine whether these voltages are “reasonable” values? We have a maximum possible current of  $3 + 8 + 25 = 36$  amperes anywhere in the circuit. The largest resistor is  $7 \Omega$ , so we do not expect any voltage magnitude greater than  $7 \times 36 = 252 \text{ V}$ .

There are, of course, numerous methods available for the solution of linear systems of equations, and we describe several in Appendix 2 in detail. Prior to the advent of the scientific calculator, Cramer’s rule as seen in Example 4.2 was very common in circuit analysis, although occasionally tedious to implement. It is, however, straightforward to use on a simple

four-function calculator, and so an awareness of the technique can be valuable. MATLAB, on the other hand, although not likely to be available during an examination, is a powerful software package that can greatly simplify the solution process; a brief tutorial on getting started is provided in Appendix 6.

For the situation encountered in Example 4.2, there are several options available through MATLAB. First, we can represent Eqs. [7] to [9] in *matrix form*:

$$\begin{bmatrix} 0.5833 & -0.3333 & -0.25 \\ -0.3333 & 1.4762 & -0.1429 \\ -0.25 & -0.1429 & 0.5929 \end{bmatrix} \begin{bmatrix} v_1 \\ v_2 \\ v_3 \end{bmatrix} = \begin{bmatrix} -11 \\ 3 \\ 25 \end{bmatrix}$$

so that

$$\begin{bmatrix} v_1 \\ v_2 \\ v_3 \end{bmatrix} = \begin{bmatrix} 0.5833 & -0.3333 & -0.25 \\ -0.3333 & 1.4762 & -0.1429 \\ -0.25 & -0.1429 & 0.5929 \end{bmatrix}^{-1} \begin{bmatrix} -11 \\ 3 \\ 25 \end{bmatrix}$$

In MATLAB, we write

```
>> a = [0.5833 -0.3333 -0.25; -0.3333 1.4762 -0.1429; -0.25 -0.1429 0.5929];
>> c = [-11; 3; 25];
>> b = a^-1 * c
b =
    5.4124
    7.7375
   46.3127
>>
```

where spaces separate elements along rows, and a semicolon separates rows. The matrix named **b**, which can also be referred to as a *vector* as it has only one column, is our solution. Thus,  $v_1 = 5.412$  V,  $v_2 = 7.738$  V, and  $v_3 = 46.31$  V (some rounding error has been incurred).

We could also use the KCL equations as we wrote them initially if we employ the symbolic processor of MATLAB.

```
>> eqn1 = '-8 -3 = (v1 - v2)/ 3 + (v1 - v3)/ 4';
>> eqn2 = '-(-3) = (v2 - v1)/ 3 + v2/ 1 + (v2 - v3)/ 7';
>> eqn3 = '-(-25) = v3/ 5 + (v3 - v2)/ 7 + (v3 - v1)/ 4';
>> answer = solve(eqn1, eqn2, eqn3, 'v1', 'v2', 'v3');
>> answer.v1
ans =
    720/133
>> answer.v2
ans =
    147/19
>> answer.v3
ans =
    880/19
>>
```

which results in exact answers, with no rounding errors. The *solve()* routine is invoked with the list of symbolic equations we named eqn1, eqn2, and eqn3, but the variables  $v_1$ ,  $v_2$  and  $v_3$  must also be specified. If *solve()* is called with fewer variables than equations, an algebraic solution is returned. The form of the solution is worth a quick comment; it is returned in what is referred to in programming parlance as a *structure*; in this case, we called our structure “answer.” Each component of the structure is accessed separately by name as shown.

### PRACTICE

4.2 For the circuit of Fig. 4.5, compute the voltage across each current source.

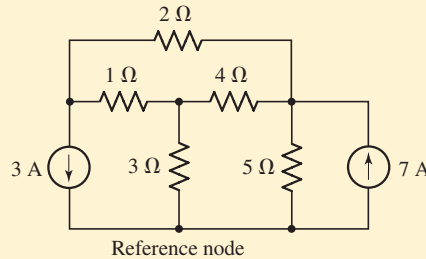

FIGURE 4.5

Ans:  $v_{3A} = 5.235$  V;  $v_{7A} = 11.47$  V.

The previous examples have demonstrated the basic approach to nodal analysis, but it is worth considering what happens if dependent sources are present as well.

### EXAMPLE 4.3

Determine the power supplied by the dependent source of Fig. 4.6a.

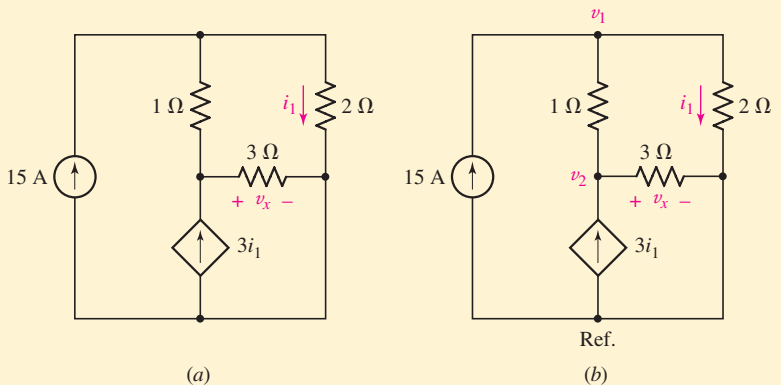

FIGURE 4.6 (a) A four-node circuit containing a dependent current source. (b) Circuit labeled for nodal analysis.



We choose the bottom node as our reference, since it has a large number of branch connections, and proceed to label the nodal voltages  $v_1$  and  $v_2$  as shown in Fig. 4.6b. The quantity labeled  $v_x$  is actually equal to  $v_2$ .

At node 1, we write

$$15 = \frac{v_1 - v_2}{1} + \frac{v_1}{2} \quad [10]$$

and at node 2

$$3i_1 = \frac{v_2 - v_1}{1} + \frac{v_2}{3} \quad [11]$$

Unfortunately, we have only two equations but three unknowns; *this is a direct result of the presence of the dependent current source, since it is not controlled by a nodal voltage*. Thus, we need an additional equation that relates  $i_1$  to one or more nodal voltages.

In this case, we find that

$$i_1 = \frac{v_1}{2} \quad [12]$$

which upon substitution into Eq. [11] yields (with a little rearranging)

$$3v_1 - 2v_2 = 30 \quad [13]$$

and Eq. [10] simplifies to

$$-15v_1 + 8v_2 = 0 \quad [14]$$

Solving, we find that  $v_1 = -40$  V,  $v_2 = -75$  V, and  $i_1 = 0.5v_1 = -20$  A. Thus, the power supplied by the dependent source is equal to  $(3i_1)(v_2) = (-60)(-75) = 4.5$  kW.

We see that the presence of a dependent source will create the need for an additional equation in our analysis if the controlling quantity is not a nodal voltage. Now let's look at the same circuit, but with the controlling variable of the dependent current source changed to a different quantity—the voltage across the  $3\ \Omega$  resistor, which is in fact a nodal voltage. We will find that only *two* equations are required to complete the analysis.



## EXAMPLE 4.4

### Determine the power supplied by the dependent source of Fig. 4.7a.

We select the bottom node as our reference and label the nodal voltages as shown in Fig. 4.7b. We have labeled the nodal voltage  $v_x$  explicitly for clarity. Note that our choice of reference node is important in this case; it led to the quantity  $v_x$  being a nodal voltage.

Our KCL equation for node 1 is

$$15 = \frac{v_1 - v_x}{1} + \frac{v_1}{2} \quad [15]$$

(Continued on next page)

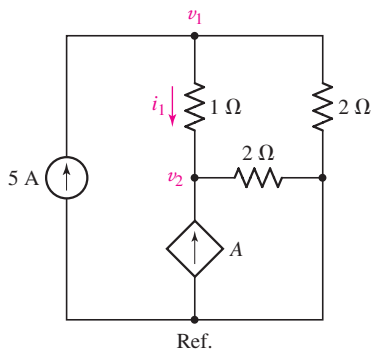

■ FIGURE 4.8

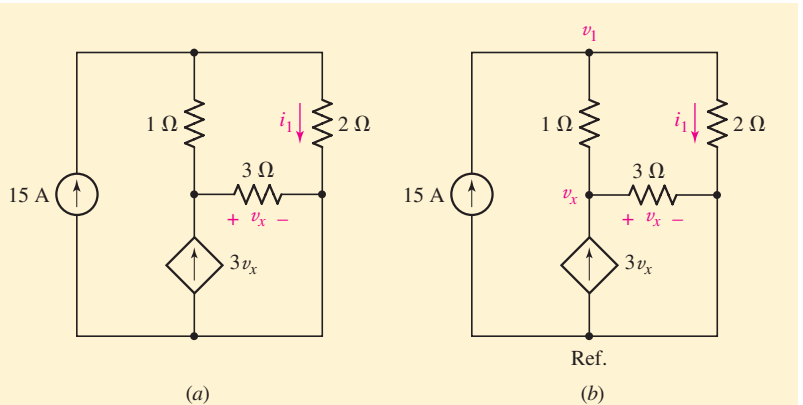

■ FIGURE 4.7 (a) A four-node circuit containing a dependent current source. (b) Circuit labeled for nodal analysis.

and for node  $x$  is

$$3v_x = \frac{v_x - v_1}{1} + \frac{v_2}{3} \quad [16]$$

Grouping terms and solving, we find that  $v_1 = \frac{50}{7}$  V and  $v_x = -\frac{30}{7}$  V. Thus, the dependent source in this circuit generates  $(3v_x)(v_x) = 55.1$  W.

### PRACTICE

4.3 For the circuit of Fig. 4.8, determine the nodal voltage  $v_1$  if  $A$  is (a)  $2i_1$ ; (b)  $2v_1$ .

Ans: (a)  $\frac{70}{9}$  V; (b)  $-10$  V.

### Summary of Basic Nodal Analysis Procedure

1. **Count the number of nodes ( $N$ ).**
2. **Designate a reference node.** The number of terms in your nodal equations can be minimized by selecting the node with the greatest number of branches connected to it.
3. **Label the nodal voltages** (there are  $N - 1$  of them).
4. **Write a KCL equation for each of the nonreference nodes.** Sum the currents flowing *into* a node from sources on one side of the equation. On the other side, sum the currents flowing *out of* the node through resistors. Pay close attention to “ $-$ ” signs.
5. **Express any additional unknowns such as currents or voltages other than nodal voltages in terms of appropriate nodal voltages.** This situation can occur if voltage sources or dependent sources appear in our circuit.
6. **Organize the equations.** Group terms according to nodal voltages.
7. **Solve the system of equations for the nodal voltages** (there will be  $N - 1$  of them).

These seven basic steps will work on any circuit we ever encounter, although the presence of voltage sources will require extra care. Such situations are discussed next.

## 4.2 THE SUPERNODE

As an example of how voltage sources are best handled when performing nodal analysis, consider the circuit shown in Fig. 4.9a. The original four-node circuit of Fig. 4.4 has been changed by replacing the  $7\ \Omega$  resistor between nodes 2 and 3 with a  $22\ \text{V}$  voltage source. We still assign the same node-to-reference voltages  $v_1$ ,  $v_2$ , and  $v_3$ . Previously, the next step was the application of KCL at each of the three nonreference nodes. If we try to do that once again, we see that we will run into some difficulty at both nodes 2 and 3, for we do not know what the current is in the branch with the voltage source. There is no way by which we can express the current as a function of the voltage, for the definition of a voltage source is exactly that the voltage is independent of the current.

There are two ways out of this dilemma. The more difficult approach is to assign an unknown current to the branch which contains the voltage source, proceed to apply KCL three times, and then apply KVL ( $v_3 - v_2 = 22$ ) once between nodes 2 and 3; the result is then four equations in four unknowns.

The easier method is to treat node 2, node 3, and the voltage source together as a sort of *supernode* and apply KCL to both nodes at the same time; the supernode is indicated by the region enclosed by the broken line in Fig. 4.9a. This is okay because if the total current leaving node 2 is zero and the total current leaving node 3 is zero, then the total current leaving the combination of the two nodes is zero. This concept is represented graphically in the expanded view of Fig. 4.9b.

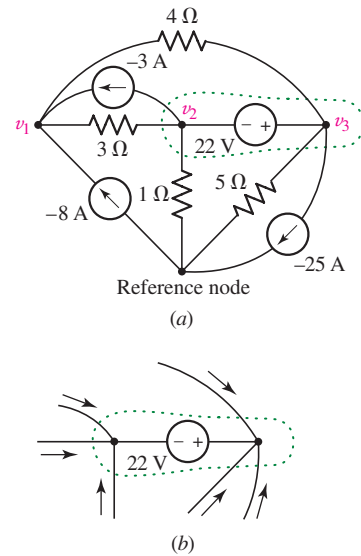

FIGURE 4.9 (a) The circuit of Example 4.2 with a  $22\ \text{V}$  source in place of the  $7\ \Omega$  resistor. (b) Expanded view of the region defined as a supernode; KCL requires that all currents flowing into the region sum to zero, or we would pile up or run out of electrons.

### EXAMPLE 4.5

Determine the value of the unknown node voltage  $v_1$  in the circuit of Fig. 4.9a.

The KCL equation at node 1 is unchanged from Example 4.2:

$$-8 - 3 = \frac{v_1 - v_2}{3} + \frac{v_1 - v_3}{4}$$

or

$$0.5833v_1 - 0.3333v_2 - 0.2500v_3 = -11 \quad [17]$$

Next we consider the 2-3 supernode. Two current sources are connected, and four resistors. Thus,

$$3 + 25 = \frac{v_2 - v_1}{3} + \frac{v_3 - v_1}{4} + \frac{v_3}{5} + \frac{v_2}{1}$$

or

$$-0.5833v_1 + 1.3333v_2 + 0.45v_3 = 28 \quad [18]$$

(Continued on next page)

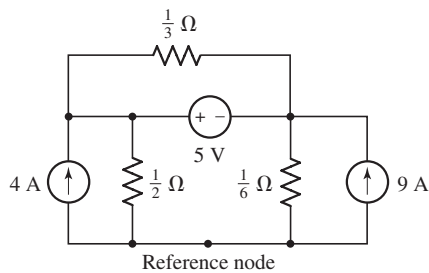

■ FIGURE 4.10



Since we have three unknowns, we need one additional equation, and it must utilize the fact that there is a 22 V voltage source between nodes 2 and 3:

$$v_2 - v_3 = -22 \quad [19]$$

Solving Eqs. [17] to [19], the solution for  $v_1$  is 1.071 V.

### PRACTICE

4.4 For the circuit of Fig. 4.10, compute the voltage across each current source.

Ans: 5.375 V, 375 mV.

The presence of a voltage source thus reduces by 1 the number of nonreference nodes at which we must apply KCL, regardless of whether the voltage source extends between two nonreference nodes or is connected between a node and the reference. We should be careful in analyzing circuits such as that of Practice Problem 4.4. Since both ends of the resistor are part of the supernode, there must technically be *two* corresponding current terms in the KCL equation, but they cancel each other out. We can summarize the supernode method as follows:

#### Summary of Supernode Analysis Procedure

1. **Count the number of nodes ( $N$ ).**
2. **Designate a reference node.** The number of terms in your nodal equations can be minimized by selecting the node with the greatest number of branches connected to it.
3. **Label the nodal voltages** (there are  $N - 1$  of them).
4. **If the circuit contains voltage sources, form a supernode about each one.** This is done by enclosing the source, its two terminals, and any other elements connected between the two terminals within a broken-line enclosure.
5. **Write a KCL equation for each nonreference node and for each supernode that does not contain the reference node.** Sum the currents flowing *into* a node/supernode from current sources on one side of the equation. On the other side, sum the currents flowing *out* of the node/supernode through resistors. Pay close attention to “-” signs.
6. **Relate the voltage across each voltage source to nodal voltages.** This is accomplished by simple application of KVL; one such equation is needed for each supernode defined.
7. **Express any additional unknowns (i.e., currents or voltages other than nodal voltages) in terms of appropriate nodal voltages.** This situation can occur if dependent sources appear in our circuit.
8. **Organize the equations.** Group terms according to nodal voltages.
9. **Solve the system of equations for the nodal voltages** (there will be  $N - 1$  of them).

We see that we have added two additional steps from our general nodal analysis procedure. In reality, however, application of the supernode technique to a circuit containing voltage sources not connected to the reference node will result in a reduction in the number of KCL equations required. With this in mind, let's consider the circuit of Fig. 4.11, which contains all four types of sources and has five nodes.

## EXAMPLE 4.6

**Determine the node-to-reference voltages in the circuit of Fig. 4.11.**

After establishing a supernode about each *voltage* source, we see that we need to write KCL equations only at node 2 and at the supernode containing the dependent voltage source. By inspection, it is clear that  $v_1 = -12$  V.

At node 2,

$$\frac{v_2 - v_1}{0.5} + \frac{v_2 - v_3}{2} = 14 \quad [20]$$

while at the 3-4 supernode,

$$0.5v_x = \frac{v_3 - v_2}{2} + \frac{v_4}{1} + \frac{v_4 - v_1}{2.5} \quad [21]$$

We next relate the source voltages to the node voltages:

$$v_3 - v_4 = 0.2v_y \quad [22]$$

and

$$0.2v_y = 0.2(v_4 - v_1) \quad [23]$$

Finally, we express the dependent current source in terms of the assigned variables:

$$0.5v_x = 0.5(v_2 - v_1) \quad [24]$$

Five nodes requires *four* KCL equations in general nodal analysis, but we have reduced this requirement to *only two*, as we formed two separate supernodes. Each supernode required a KVL equation (Eq. [22] and  $v_1 = -12$ , the latter written by inspection). Neither dependent source was controlled by a nodal voltage, so two additional equations were needed as a result.

With this done, we can now eliminate  $v_x$  and  $v_y$  to obtain a set of four equations in the four node voltages:

$$\begin{aligned} -2v_1 + 2.5v_2 - 0.5v_3 &= 14 \\ 0.1v_1 - v_2 + 0.5v_3 + 1.4v_4 &= 0 \\ v_1 &= -12 \\ 0.2v_1 + v_3 - 1.2v_4 &= 0 \end{aligned}$$

Solving,  $v_1 = -12$  V,  $v_2 = -4$  V,  $v_3 = 0$  V, and  $v_4 = -2$  V.

## PRACTICE

4.5 Determine the nodal voltages in the circuit of Fig. 4.12.

Ans:  $v_1 = 3$  V,  $v_2 = -2.33$  V,  $v_3 = -1.91$  V,  $v_4 = 0.945$  V.

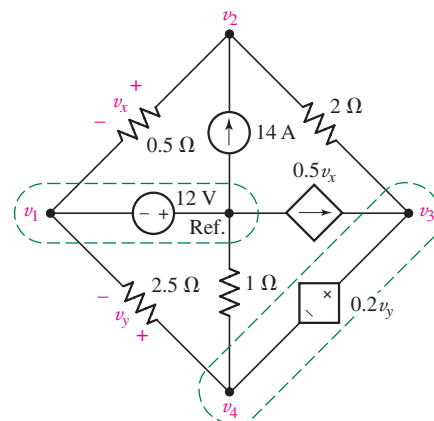

FIGURE 4.11 A five-node circuit with four different types of sources.

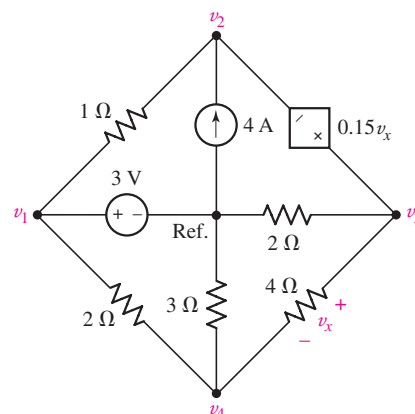
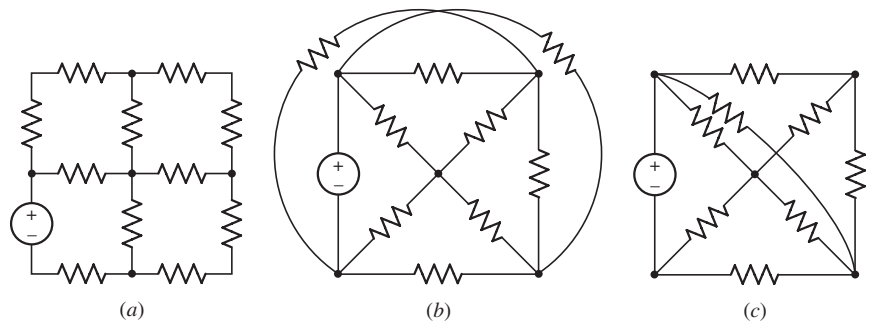

FIGURE 4.12

### 4.3 MESH ANALYSIS

As we have seen, nodal analysis is a straightforward analysis technique when only current sources are present, and voltage sources are easily accommodated with the supernode concept. Still, nodal analysis is based on KCL, and the reader might at some point wonder if there isn't a similar approach based on KVL. There is—it's known as *mesh analysis*—and although only strictly speaking applicable to what we will shortly define as a planar circuit, it can in many cases prove simpler to apply than nodal analysis.

If it is possible to draw the diagram of a circuit on a plane surface in such a way that no branch passes over or under any other branch, then that circuit is said to be a *planar circuit*. Thus, Fig. 4.13a shows a planar network, Fig. 4.13b shows a nonplanar network, and Fig. 4.13c also shows a planar network, although it is drawn in such a way as to make it appear nonplanar at first glance.



■ FIGURE 4.13 Examples of planar and nonplanar networks; crossed wires without a solid dot are not in physical contact with each other.

In Sec. 3.1, the terms *path*, *closed path*, and *loop* were defined. Before we define a mesh, let us consider the sets of branches drawn with heavy lines in Fig. 4.14. The first set of branches is not a path, since four branches are connected to the center node, and it is of course also not a loop. The second set of branches does not constitute a path, since it is traversed only by passing through the central node twice. The remaining four paths are all loops. The circuit contains 11 branches.

The mesh is a property of a planar circuit and is undefined for a nonplanar circuit. We define a *mesh* as a loop that does not contain any other loops within it. Thus, the loops indicated in Fig. 4.14c and d are not meshes, whereas those of parts e and f are meshes. Once a circuit has been drawn neatly in planar form, it often has the appearance of a multipaned window; the boundary of each pane in the window may be considered to be a mesh.

If a network is planar, mesh analysis can be used to accomplish the analysis. This technique involves the concept of a *mesh current*, which we introduce by considering the analysis of the two-mesh circuit of Fig. 4.15a.

As we did in the single-loop circuit, we will begin by defining a current through one of the branches. Let us call the current flowing to the right through the  $6\ \Omega$  resistor  $i_1$ . We will apply KVL around each of the two meshes, and the two resulting equations are sufficient to determine two unknown currents. We next define a second current  $i_2$  flowing to the right in

We should mention that mesh-type analysis can be applied to nonplanar circuits, but since it is not possible to define a complete set of unique meshes for such circuits, assignment of unique mesh currents is not possible.

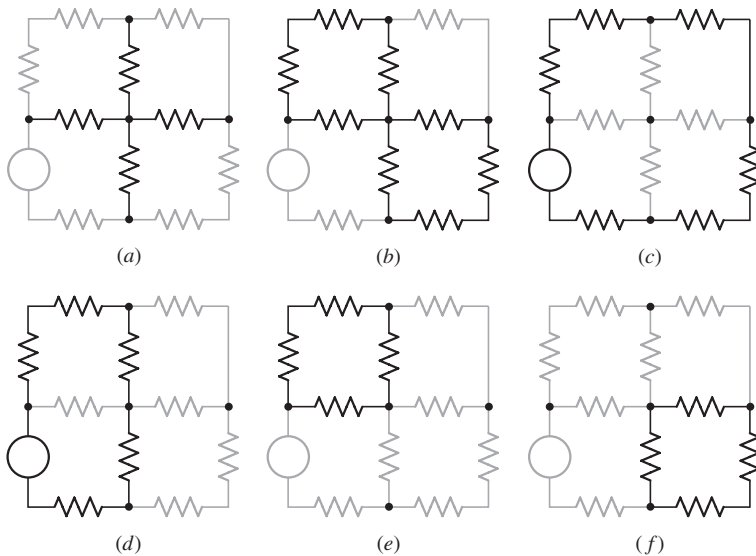

■ FIGURE 4.14 (a) The set of branches identified by the heavy lines is neither a path nor a loop. (b) The set of branches here is not a path, since it can be traversed only by passing through the central node twice. (c) This path is a loop but not a mesh, since it encloses other loops. (d) This path is also a loop but not a mesh. (e, f) Each of these paths is both a loop and a mesh.

the  $4\ \Omega$  resistor. We might also choose to call the current flowing downward through the central branch  $i_3$ , but it is evident from KCL that  $i_3$  may be expressed in terms of the two previously assumed currents as  $(i_1 - i_2)$ . The assumed currents are shown in Fig. 4.15b.

Following the method of solution for the single-loop circuit, we now apply KVL to the left-hand mesh,

$$-42 + 6i_1 + 3(i_1 - i_2) = 0$$

or

$$9i_1 - 3i_2 = 42 \quad [25]$$

Applying KVL to the right-hand mesh,

$$-3(i_1 - i_2) + 4i_2 - 10 = 0$$

or

$$-3i_1 + 7i_2 = 10 \quad [26]$$

Equations [25] and [26] are independent equations; one cannot be derived from the other. With two equations and two unknowns, the solution is easily obtained:

$$i_1 = 6\ \text{A} \quad i_2 = 4\ \text{A} \quad \text{and} \quad (i_1 - i_2) = 2\ \text{A}$$

If our circuit contains  $M$  meshes, then we expect to have  $M$  mesh currents and therefore will be required to write  $M$  independent equations.

Now let us consider this same problem in a slightly different manner by using mesh currents. We define a **mesh current** as a current that flows only around the perimeter of a mesh. One of the greatest advantages in the use of mesh currents is the fact that Kirchhoff's current law is automatically satisfied. If a mesh current flows *into* a given node, it flows *out* of it also.

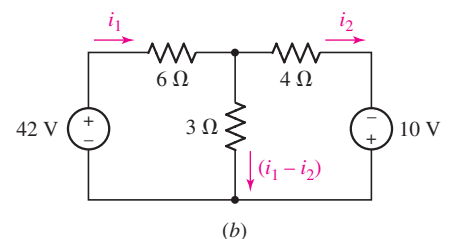
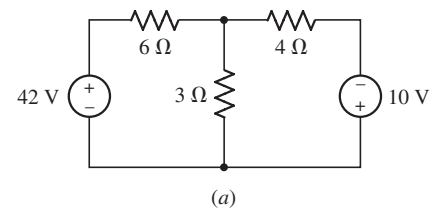

■ FIGURE 4.15 (a, b) A simple circuit for which currents are required.



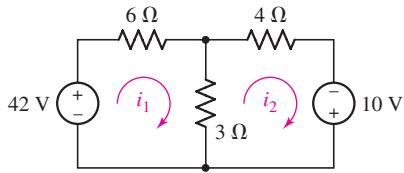

■ FIGURE 4.16 The same circuit considered in Fig. 4.15b, but viewed a slightly different way.

A mesh current may often be identified as a branch current, as  $i_1$  and  $i_2$  have been identified in this example. This is not always true, however, for consideration of a square nine-mesh network soon shows that the central mesh current cannot be identified as the current in any branch.

If we call the left-hand mesh of our problem mesh 1, then we may establish a mesh current  $i_1$  flowing in a clockwise direction about this mesh. A mesh current is indicated by a curved arrow that almost closes on itself and is drawn inside the appropriate mesh, as shown in Fig. 4.16. The mesh current  $i_2$  is established in the remaining mesh, again in a clockwise direction. Although the directions are arbitrary, we will always choose clockwise mesh currents because a certain error-minimizing symmetry then results in the equations.

We no longer have a current or current arrow shown directly on each branch in the circuit. The current through any branch must be determined by considering the mesh currents flowing in every mesh in which that branch appears. This is not difficult, because no branch can appear in more than two meshes. For example, the  $3\ \Omega$  resistor appears in both meshes, and the current flowing downward through it is  $i_1 - i_2$ . The  $6\ \Omega$  resistor appears only in mesh 1, and the current flowing to the right in that branch is equal to the mesh current  $i_1$ .

For the left-hand mesh,

$$-42 + 6i_1 + 3(i_1 - i_2) = 0$$

while for the right-hand mesh,

$$3(i_2 - i_1) + 4i_2 - 10 = 0$$

and these two equations are equivalent to Eqs. [25] and [26].

## EXAMPLE 4.7

Determine the power supplied by the 2 V source of Fig. 4.17a.

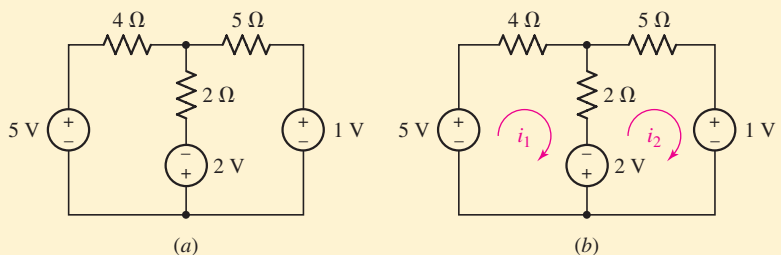

■ FIGURE 4.17 (a) A two-mesh circuit containing three sources. (b) Circuit labeled for mesh analysis.

We first define two clockwise mesh currents as shown in Fig. 4.17b.

Beginning at the bottom left node of mesh 1, we write the following KVL equation as we proceed clockwise through the branches:

$$-5 + 4i_1 + 2(i_1 - i_2) - 2 = 0$$

Doing the same for mesh 2, we write

$$+2 + 2(i_2 - i_1) + 5i_2 + 1 = 0$$



Rearranging and grouping terms,

$$6i_1 - 2i_2 = 7$$

and

$$-2i_1 + 7i_2 = -3$$

Solving,  $i_1 = \frac{43}{38} = 1.132$  A and  $i_2 = -\frac{2}{19} = -0.1053$  A.

The current flowing out of the positive reference terminal of the 2 V source is  $i_1 - i_2$ . Thus, the 2 V source supplies  $(2)(1.237) = 2.474$  W.

### PRACTICE

4.6 Determine  $i_1$  and  $i_2$  in the circuit in Fig. 4.18.

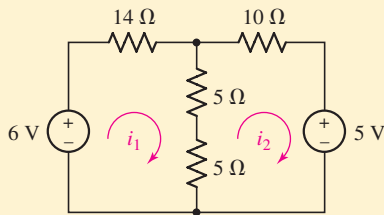

FIGURE 4.18

Ans: +184.2 mA; -157.9 mA.

Let us next consider the five-node, seven-branch, three-mesh circuit shown in Fig. 4.19. This is a slightly more complicated problem because of the additional mesh.

### EXAMPLE 4.8

Use mesh analysis to determine the three mesh currents in the circuit of Fig. 4.19.

The three required mesh currents are assigned as indicated in Fig. 4.19, and we methodically apply KVL about each mesh:

$$-7 + 1(i_1 - i_2) + 6 + 2(i_1 - i_3) = 0$$

$$1(i_2 - i_1) + 2i_2 + 3(i_2 - i_3) = 0$$

$$2(i_3 - i_1) - 6 + 3(i_3 - i_2) + 1i_3 = 0$$

Simplifying,

$$3i_1 - i_2 - 2i_3 = 1$$

$$-i_1 + 6i_2 - 3i_3 = 0$$

$$-2i_1 - 3i_2 + 6i_3 = 6$$

and solving, we obtain  $i_1 = 3$  A,  $i_2 = 2$  A, and  $i_3 = 3$  A.

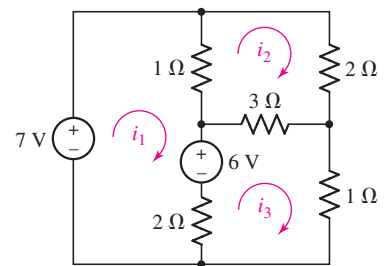

FIGURE 4.19 A five-node, seven-branch, three-mesh circuit.

## PRACTICE

4.7 Determine  $i_1$  and  $i_2$  in the circuit of Fig 4.20.

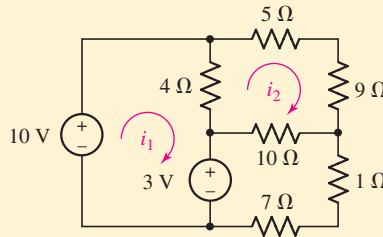
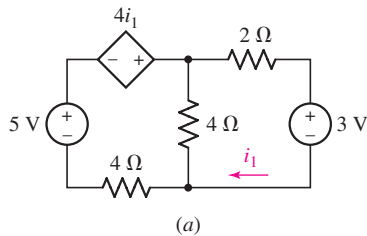

FIGURE 4.20

Ans: 2.220 A, 470.0 mA.

The previous examples dealt with circuits powered exclusively by independent voltage sources. If a current source is included in the circuit, it may either simplify or complicate the analysis, as discussed in Sec. 4.4. As seen in our study of the nodal analysis technique, dependent sources generally require an additional equation besides the  $M$  mesh equations, unless the controlling variable is a mesh current (or sum of mesh currents). We explore this in the following example.

## EXAMPLE 4.9



(a)

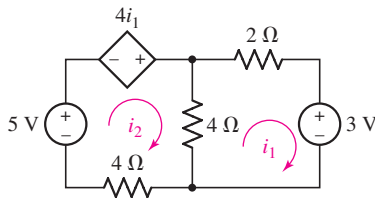

(b)

FIGURE 4.21 (a) A two-mesh circuit containing a dependent source. (b) Circuit labeled for mesh analysis.

Determine the current  $i_1$  in the circuit of Fig. 4.21a.

The current  $i_1$  is actually a mesh current, so rather than redefine it we label the rightmost mesh current  $i_1$  and define a clockwise mesh current  $i_2$  for the left mesh, as shown in Fig. 4.21b.

For the left mesh, KVL yields

$$-5 - 4i_1 + 4(i_2 - i_1) + 4i_2 = 0 \quad [27]$$

and for the right mesh we find

$$4(i_1 - i_2) + 2i_1 + 3 = 0 \quad [28]$$

Grouping terms, these equations may be written more compactly as

$$-8i_1 + 8i_2 = 5$$

and

$$6i_1 - 4i_2 = -3$$

Solving,  $i_2 = 375$  mA, so  $i_1 = -250$  mA.

Since the dependent source of Fig. 4.21 is controlled by a mesh current ( $i_1$ ), only two equations—Eqs. [27] and [28]—were required to analyze the two-mesh circuit. In the following example, we explore the situation that arises if the controlling variable is *not* a mesh current.

## EXAMPLE 4.10

Determine the current  $i_1$  in the circuit of Fig. 4.22a.

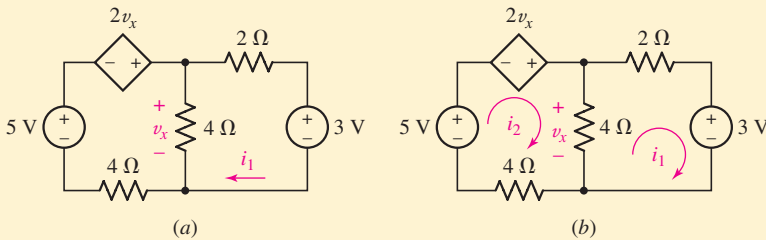

FIGURE 4.22 (a) A circuit with a dependent source controlled by a voltage. (b) Circuit labeled for mesh analysis.

In order to draw comparisons to Example 4.9 we use the same mesh current definitions, as shown in Fig. 4.22b.

For the left mesh, KVL now yields

$$-5 - 2v_x + 4(i_2 - i_1) + 4i_2 = 0 \quad [29]$$

and for the right mesh we find the same as before, namely,

$$4(i_1 - i_2) + 2i_1 + 3 = 0 \quad [30]$$

Since the dependent source is controlled by the unknown voltage  $v_x$ , we are faced with *two* equations in *three* unknowns. The way out of our dilemma is to construct an equation for  $v_x$  in terms of mesh currents, such as

$$v_x = 4(i_2 - i_1) \quad [31]$$

We simplify our system of equations by substituting Eq. [31] into Eq. [29], resulting in

$$4i_1 = 5$$

Solving, we find that  $i_1 = 1.25$  A. In this particular instance, Eq. [30] is not needed unless a value for  $i_2$  is desired.

## PRACTICE

4.8 Determine  $i_1$  in the circuit of Fig. 4.23 if the controlling quantity  $A$  is equal to (a)  $2i_2$ ; (b)  $2v_x$ .

Ans: (a) 1.35 A; (b) 546 mA.

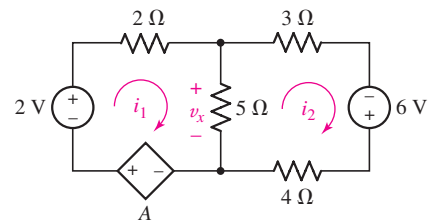

FIGURE 4.23

The mesh analysis procedure can be summarized by the seven basic steps that follow. It will work on any *planar* circuit we ever encounter, although the presence of current sources will require extra care. Such situations are discussed in Sec. 4.4.

### Summary of Basic Mesh Analysis Procedure

1. **Determine if the circuit is a planar circuit.** If not, perform nodal analysis instead.
2. **Count the number of meshes ( $M$ ).** Redraw the circuit if necessary.
3. **Label each of the  $M$  mesh currents.** Generally, defining all mesh currents to flow clockwise results in a simpler analysis.
4. **Write a KVL equation around each mesh.** Begin with a convenient node and proceed in the direction of the mesh current. Pay close attention to “–” signs. If a current source lies on the periphery of a mesh, no KVL equation is needed and the mesh current is determined by inspection.
5. **Express any additional unknowns such as voltages or currents other than mesh currents in terms of appropriate mesh currents.** This situation can occur if current sources or dependent sources appear in our circuit.
6. **Organize the equations.** Group terms according to mesh currents.
7. **Solve the system of equations for the mesh currents** (there will be  $M$  of them).

## 4.4 THE SUPERMESH

How must we modify this straightforward procedure when a current source is present in the network? Taking our lead from nodal analysis, we should feel that there are two possible methods. First, we could assign an unknown voltage across the current source, apply KVL around each mesh as before, and then relate the source current to the assigned mesh currents. This is generally the more difficult approach.

A better technique is one that is quite similar to the supernode approach in nodal analysis. There we formed a supernode, completely enclosing the voltage source inside the supernode and reducing the number of non-reference nodes by 1 for each voltage source. Now we create a kind of “*supermesh*” from two meshes that have a current source as a common element; the current source is in the interior of the supermesh. We thus reduce the number of meshes by 1 for each current source present. If the current source lies on the *perimeter* of the circuit, then the single mesh in which it is found is ignored. Kirchhoff’s voltage law is thus applied only to those meshes or supermeshes in the reinterpreted network.

### EXAMPLE 4.11

#### Determine the three mesh currents in Fig. 4.24a.

We note that a 7 A independent current source is in the common boundary of two meshes, which leads us to create a supermesh whose interior

is that of meshes 1 and 3 as shown in Fig. 4.24b. Applying KVL about this loop,

$$-7 + 1(i_1 - i_2) + 3(i_3 - i_2) + 1i_3 = 0$$

or

$$i_1 - 4i_2 + 4i_3 = 7 \quad [32]$$

and around mesh 2,

$$1(i_2 - i_1) + 2i_2 + 3(i_2 - i_3) = 0$$

or

$$-i_1 + 6i_2 - 3i_3 = 0 \quad [33]$$

Finally, the independent source current is related to the mesh currents,

$$i_1 - i_3 = 7 \quad [34]$$

Solving Eqs. [32] through [34], we find  $i_1 = 9$  A,  $i_2 = 2.5$  A, and  $i_3 = 2$  A.

### PRACTICE

4.9 Determine the current  $i_1$  in the circuit of Fig. 4.25.

Ans:  $-1.93$  A.

The presence of one or more dependent sources merely requires each of these source quantities and the variable on which it depends to be expressed in terms of the assigned mesh currents. In Fig. 4.26, for example, we note that both a dependent and an independent current source are included in the network. Let's see how their presence affects the analysis of the circuit and actually simplifies it.

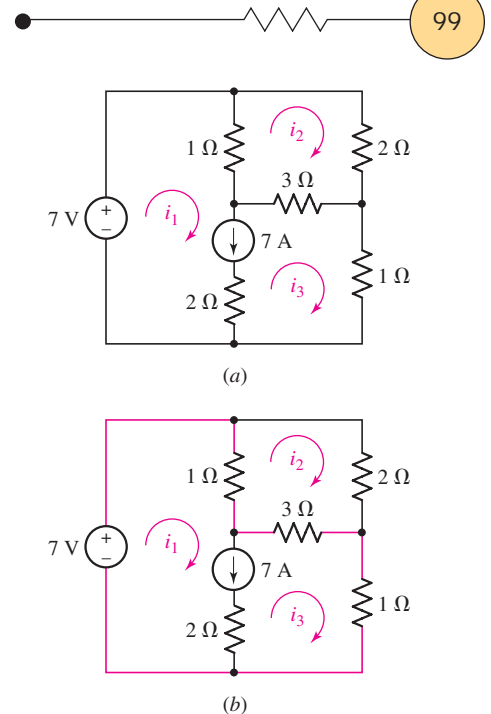

FIGURE 4.24 (a) A three-mesh circuit with an independent current source. (b) A supermesh is defined by the colored line.

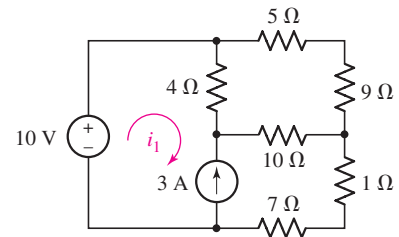

FIGURE 4.25

### EXAMPLE 4.12

**Evaluate the three unknown currents in the circuit of Fig. 4.26.**

The current sources appear in meshes 1 and 3. Since the 15 A source is located on the perimeter of the circuit, we may eliminate mesh 1 from consideration—it is clear that  $i_1 = 15$  A.

We find that because we now know one of the two mesh currents relevant to the dependent current source, there is no need to write a supermesh equation about meshes 1 and 3. Instead, we simply relate  $i_1$  and  $i_3$  to the current from the dependent source using KCL:

$$\frac{v_x}{9} = i_3 - i_1 = \frac{3(i_3 - i_2)}{9}$$

(Continued on next page)

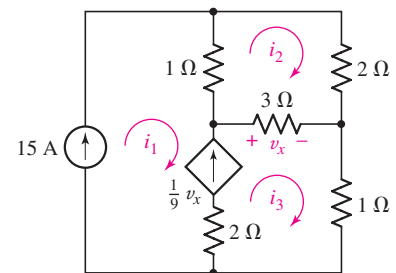

FIGURE 4.26 A three-mesh circuit with one dependent and one independent current source.

which can be written more compactly as

$$-i_1 + \frac{1}{3}i_2 + \frac{2}{3}i_3 = 0 \quad \text{or} \quad \frac{1}{3}i_2 + \frac{2}{3}i_3 = 15 \quad [35]$$

With one equation in two unknowns, all that remains is to write a KVL equation about mesh 2:

$$1(i_2 - i_1) + 2i_2 + 3(i_2 - i_3) = 0$$

or

$$6i_2 - 3i_3 = 15 \quad [36]$$

Solving Eqs. [35] and [36], we find that  $i_2 = 11$  A and  $i_3 = 17$  A; we already determined that  $i_1 = 15$  A by inspection.

### PRACTICE

4.10 Determine  $v_3$  in the circuit of Fig. 4.27.

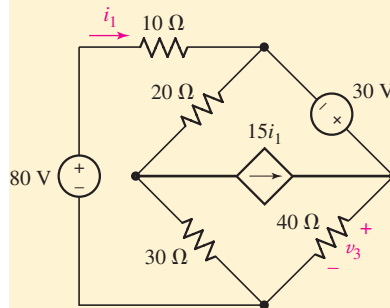

FIGURE 4.27

Ans: 104.2 V

We can now summarize the general approach to writing mesh equations, whether or not dependent sources, voltage sources, and/or current sources are present, provided that the circuit can be drawn as a planar circuit:

#### Summary of Supermesh Analysis Procedure

1. **Determine if the circuit is a planar circuit.** If not, perform nodal analysis instead.
2. **Count the number of meshes ( $M$ ).** Redraw the circuit if necessary.
3. **Label each of the  $M$  mesh currents.** Generally, defining all mesh currents to flow clockwise results in a simpler analysis.
4. **If the circuit contains current sources shared by two meshes, form a supermesh to enclose both meshes.** A highlighted enclosure helps when writing KVL equations.
5. **Write a KVL equation around each mesh/supermesh.** Begin with a convenient node and proceed in the direction of the mesh current. Pay close attention to “−” signs. If a current source lies

on the periphery of a mesh, no KVL equation is needed and the mesh current is determined by inspection.

6. **Relate the current flowing from each current source to mesh currents.** This is accomplished by simple application of KCL; one such equation is needed for each supermesh defined.
7. **Express any additional unknowns such as voltages or currents other than mesh currents in terms of appropriate mesh currents.** This situation can occur if dependent sources appear in our circuit.
8. **Organize the equations.** Group terms according to nodal voltages.
9. **Solve the system of equations for the mesh currents** (there will be  $M$  of them).

## 4.5 NODAL VS. MESH ANALYSIS: A COMPARISON

Now that we have examined two distinctly different approaches to circuit analysis, it seems logical to ask if there is ever any advantage to using one over the other. If the circuit is nonplanar, then there is no choice: only nodal analysis may be applied.

Provided that we are indeed considering the analysis of a *planar* circuit, however, there are situations where one technique has a small advantage over the other. If we plan to use nodal analysis, then a circuit with  $N$  nodes will lead to at most  $(N - 1)$  KCL equations. Each supernode defined will further reduce this number by 1. If the same circuit has  $M$  distinct meshes, then we will obtain at most  $M$  KVL equations; each supermesh will reduce this number by 1. Based on these facts, we should select the approach that will result in the smaller number of simultaneous equations.

If one or more dependent sources are included in the circuit, then each controlling quantity may influence our choice of nodal or mesh analysis. For example, a dependent voltage source controlled by a nodal voltage does not require an additional equation when we perform nodal analysis. Likewise, a dependent current source controlled by a mesh current does not require an additional equation when we perform mesh analysis. *What about the situation where a dependent voltage source is controlled by a current? Or the converse, where a dependent current source is controlled by a voltage?* Provided that the controlling quantity can be easily related to mesh currents, we might expect mesh analysis to be the more straightforward option. Likewise, if the controlling quantity can be easily related to nodal voltages, nodal analysis may be preferable. One final point in this regard is to keep in mind the *location* of the source; current sources which lie on the periphery of a mesh, whether dependent or independent, are easily treated in mesh analysis; voltage sources connected to the reference terminal are easily treated in nodal analysis.

When either method results in essentially the same number of equations, it may be worthwhile to also consider what quantities are being sought. Nodal analysis results in direct calculation of nodal voltages, whereas mesh analysis provides currents. If we are asked to find currents through a set of resistors, for example, after performing nodal analysis, we must still invoke Ohm's law at each resistor to determine the current.

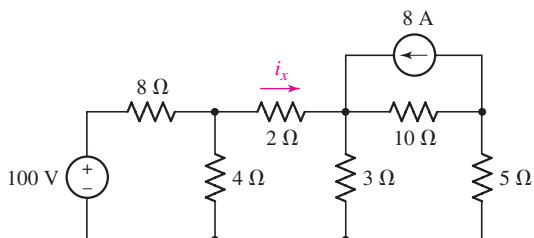

■ FIGURE 4.28 A planar circuit with five nodes and four meshes.

As an example, consider the circuit in Fig. 4.28. We wish to determine the current  $i_x$ .

We choose the bottom node as the reference node, and note that there are four nonreference nodes. Although this means that we can write four distinct equations, there is no need to label the node between the 100 V source and the 8 Ω resistor, since that node voltage is clearly 100 V. Thus, we label the remaining node voltages  $v_1$ ,  $v_2$ , and  $v_3$  as in Fig. 4.29.

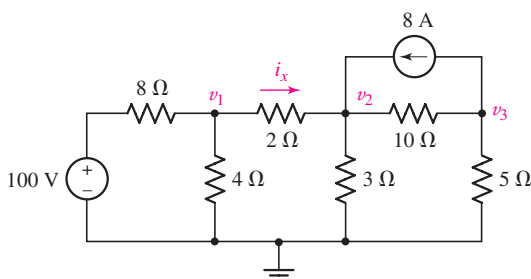

■ FIGURE 4.29 The circuit of Fig. 4.28 with node voltages labeled. Note that an earth ground symbol was chosen to designate the reference terminal.

We write the following three equations:

$$\frac{v_1 - 100}{8} + \frac{v_1}{4} + \frac{v_1 - v_2}{2} = 0 \quad \text{or} \quad 0.875v_1 - 0.5v_2 = 12.5 \quad [37]$$

$$\frac{v_2 - v_1}{2} + \frac{v_2}{3} + \frac{v_2 - v_3}{10} - 8 = 0 \quad \text{or} \quad -0.5v_1 - 0.9333v_2 - 0.1v_3 = 8 \quad [38]$$

$$\frac{v_3 - v_2}{10} + \frac{v_3}{5} + 8 = 0 \quad \text{or} \quad -0.1v_2 + 0.3v_3 = -8 \quad [39]$$

Solving, we find that  $v_1 = 25.89$  V and  $v_2 = 20.31$  V. We determine the current  $i_x$  by application of Ohm's law:

$$i_x = \frac{v_1 - v_2}{2} = 2.79 \text{ A} \quad [40]$$



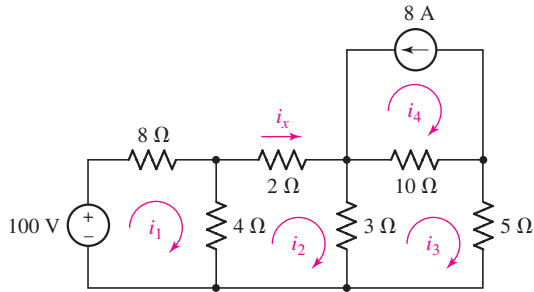

■ FIGURE 4.30 The circuit of Fig. 4.28 with mesh currents labeled.

Next, we consider the same circuit using mesh analysis. We see in Fig. 4.30 that we have four distinct meshes, although it is obvious that  $i_4 = -8$  A; we therefore need to write three distinct equations.

Writing a KVL equation for meshes 1, 2, and 3:

$$-100 + 8i_1 + 4(i_1 - i_2) = 0 \quad \text{or} \quad 12i_1 - 4i_2 = 100 \quad [41]$$

$$4(i_2 - i_1) + 2i_2 + 3(i_2 - i_3) = 0 \quad \text{or} \quad -4i_1 + 9i_2 - 3i_3 = 0 \quad [42]$$

$$3(i_3 - i_2) + 10(i_3 + 8) + 5i_3 = 0 \quad \text{or} \quad -3i_2 + 18i_3 = -80 \quad [43]$$

Solving, we find that  $i_2 (= i_x) = 2.79$  A. For this particular problem, mesh analysis proved to be simpler. Since either method is valid, however, working the same problem both ways can also serve as a means to check our answers.

## 4.6 COMPUTER-AIDED CIRCUIT ANALYSIS

We have seen that it does not take many components at all to create a circuit of respectable complexity. As we continue to examine even more complex circuits, it will become obvious rather quickly that it is easy to make errors during the analysis, and verifying solutions by hand can be time-consuming. A powerful computer software package known as PSpice is commonly employed for rapid analysis of circuits, and the schematic capture tools are typically integrated with either a printed circuit board or integrated circuit layout tool. Originally developed in the early 1970s at the University of California at Berkeley, SPICE (*Simulation Program with Integrated Circuit Emphasis*) is now an industry standard. MicroSim Corporation introduced PSpice in 1984, which built intuitive graphical interfaces around the core SPICE program. Depending on the type of circuit application being considered, there are now several companies offering variations of the basic SPICE package.

Although computer-aided analysis is a relatively quick means of determining voltages and currents in a circuit, we should be careful not to allow simulation packages to completely replace traditional “paper and pencil” analysis. There are several reasons for this. First, in order to design we must be able to analyze. Overreliance on software tools can inhibit the development of necessary analytical skills, similar to introducing calculators too early in grade school. Second, it is virtually impossible to use a complicated software package over a long period of time without making some type of data-entry error. If we have no basic intuition as to what type of answer to



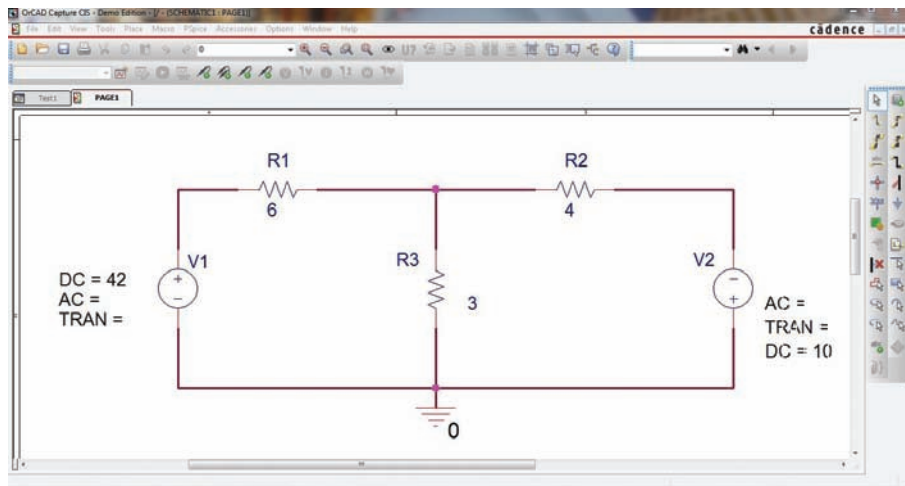

(a)



(b)

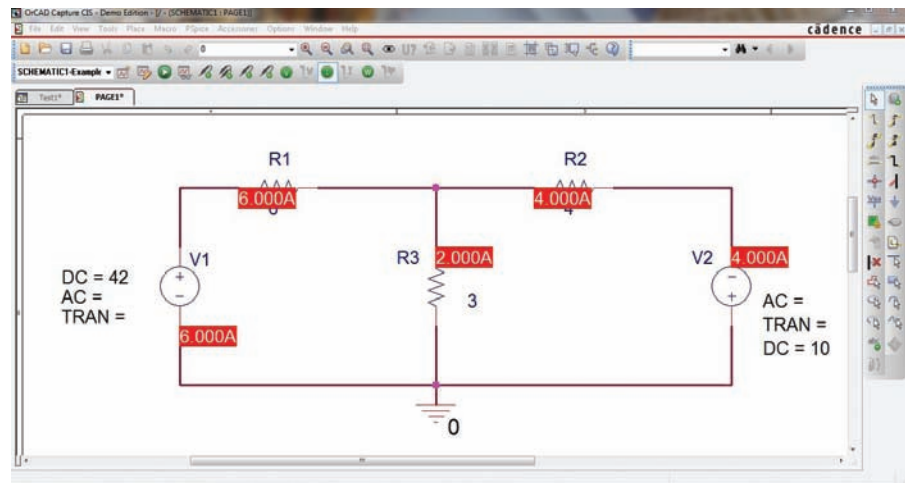

(c)

■ FIGURE 4.31 (a) Circuit of Fig. 4.15a drawn using OrCAD schematic capture software. (b) Current, voltage, and power display buttons. (c) Circuit after simulation run, with current display enabled.

expect from a simulation, then there is no way to determine whether or not it is valid. Thus, the generic name really is a fairly accurate description: *computer-aided analysis*. Human brains are not obsolete. Not yet, anyway.

As an example, consider the circuit of Fig. 4.15b, which includes two dc voltage sources and three resistors. We wish to simulate this circuit using PSpice so that we may determine the currents  $i_1$  and  $i_2$ . Figure 4.31a shows the circuit as drawn using a schematic capture program.<sup>1</sup>

(1) Refer to Appendix 4 for a brief tutorial on PSpice and schematic capture.

In order to determine the mesh currents, we need only run a bias point simulation. Under **PSpice**, select **New Simulation Profile**, type in a name (such as Example), and click on **Create**. Under the **Analysis type**: pull-down menu, select **Bias Point**, then click on **OK**. Returning to the original schematic window, under **PSpice** select **Run** (or use either of the two shortcuts: pressing the F11 key or clicking on the blue “Play” symbol). To see the currents calculated by PSpice, make sure the current button is selected (Fig. 4.31b). The results of our simulation are shown in Fig. 4.31c. We see that the two currents  $i_1$  and  $i_2$  are 6 A and 4 A, respectively, as we found previously.

As a further example, consider the circuit shown in Fig. 4.32a. It contains a dc voltage source, a dc current source, and a voltage-controlled current source. We are interested in the three nodal voltages, which from either nodal or mesh analysis are found to be 82.91 V, 69.9 V, and 59.9 V, respectively, as we move from left to right across the top of the circuit. Figure 4.32b shows this circuit after the simulation was performed. The three nodal voltages are indicated directly on the schematic. Note that in drawing a dependent source using the schematic capture tool, we must *explicitly* link two terminals of the source to the controlling voltage or current.

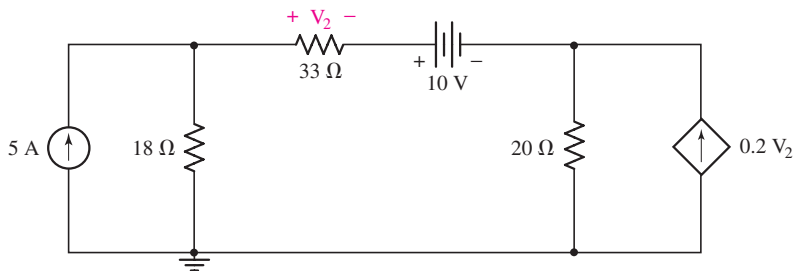

(a)

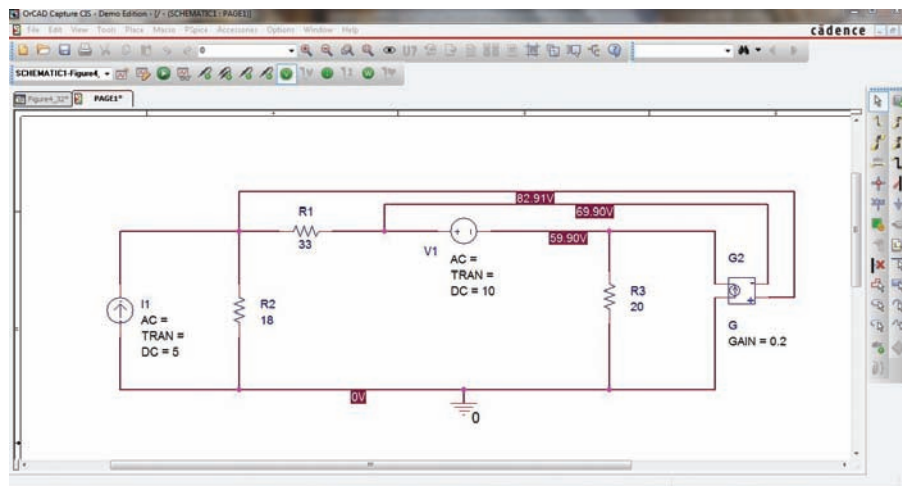

(b)

■ FIGURE 4.32 (a) Circuit with dependent current source. (b) Circuit drawn using a schematic capture tool, with simulation results presented directly on the schematic.

# PRACTICAL APPLICATION

## Node-Based PSpice Schematic Creation

The most common method of describing a circuit in conjunction with computer-aided circuit analysis is with some type of graphical schematic drawing package, an example output of which was shown in Fig. 4.32. SPICE, however, was written before the advent of such software, and as such requires circuits to be described in a specific text-based format. The format has its roots in the syntax used for punch cards, which gives it a somewhat distinct appearance. The basis for circuit description is the definition of elements, each terminal of which is assigned a node number. So, although we have just studied two different generalized circuit analysis methods—the nodal and mesh techniques—it is interesting that SPICE and PSpice were written using a clearly defined nodal analysis approach.

Even though modern circuit analysis is largely done using graphics-oriented interactive software, when errors are generated (usually due to a mistake in drawing the schematic or in selecting a combination of analysis options), the ability to read the text-based “input deck” generated by the schematic capture tool can be invaluable in tracking down the specific problem. The easiest way to develop such an ability is to learn how to run PSpice directly from a user-written input deck.

Consider, for example, the sample input deck below (lines beginning with an asterisk are comments, and are skipped by SPICE).

\* Example SPICE input deck for simple voltage divider circuit.

```
.OP                                (Requests dc operating point)
R1 1 2 1k                          (Locates R1 between nodes 1 and 2; value is 1 kΩ)
R2 2 0 1k                          (Locates R2 between nodes 2 and 0; also 1 kΩ)
V1 1 0 DC 5                        (Locates 5 V source between nodes 1 and 0)
```

\* End of input deck.

We can create the input deck by using the Notepad program from Windows or our favorite text editor. Saving the file under the name `example.cir`, we next invoke PSpice A/D (see Appendix. 4). Under **File**, we choose **Open**, locate the directory in which we saved our file `example.cir`, and for **Files of type**: select **Circuit Files (\*.cir)**. After selecting our file and clicking **Open**, we see the PSpice A/D window with our circuit file loaded (Fig. 4.33a). A netlist such as this, containing instructions for the simulation to be performed, can be created by schematic capture software or created manually as in this example.

We run the simulation by either clicking the green “play” symbol at the top right, or selecting **Run** under **Simulation**.

To view the results, we select **Output File** from under the **View** menu, which provides the window shown in Fig. 4.33b. Here it is worth noting that the output provides the expected nodal voltages (5 V at node 1, 2.5 V across resistor R2), but the current is quoted using the passive sign convention (i.e.,  $-2.5$  mA).

Text-based schematic entry is reasonably straightforward, but for complex (large number of elements) circuits, it can quickly become cumbersome. It is also easy to misnumber nodes, an error that can be difficult to isolate. However, reading the input and output files is often helpful when running simulations, so some experience with this format is useful.

At this point, the real power of computer-aided analysis begins to be apparent: Once you have the circuit drawn in the schematic capture program, it is easy to experiment by simply changing component values and observing the effect on currents and voltages. To gain a little experience at this point, try simulating any of the circuits shown in previous examples and practice problems.

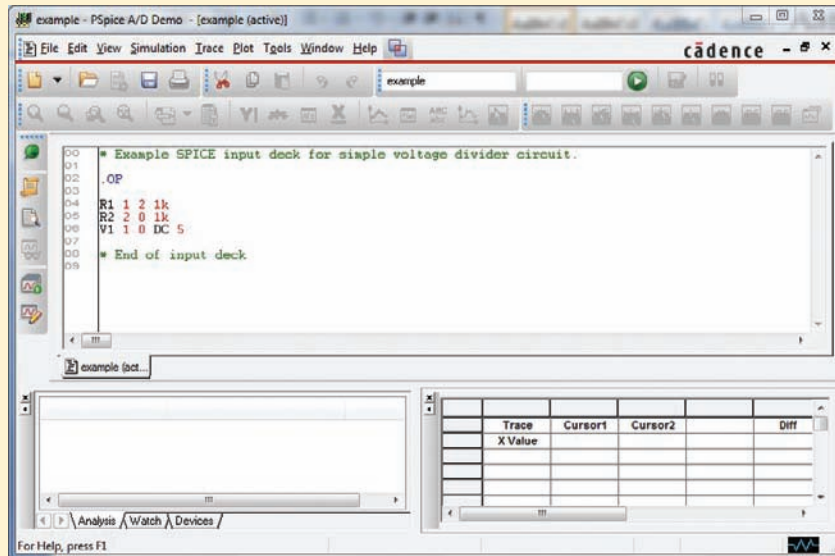

(a)

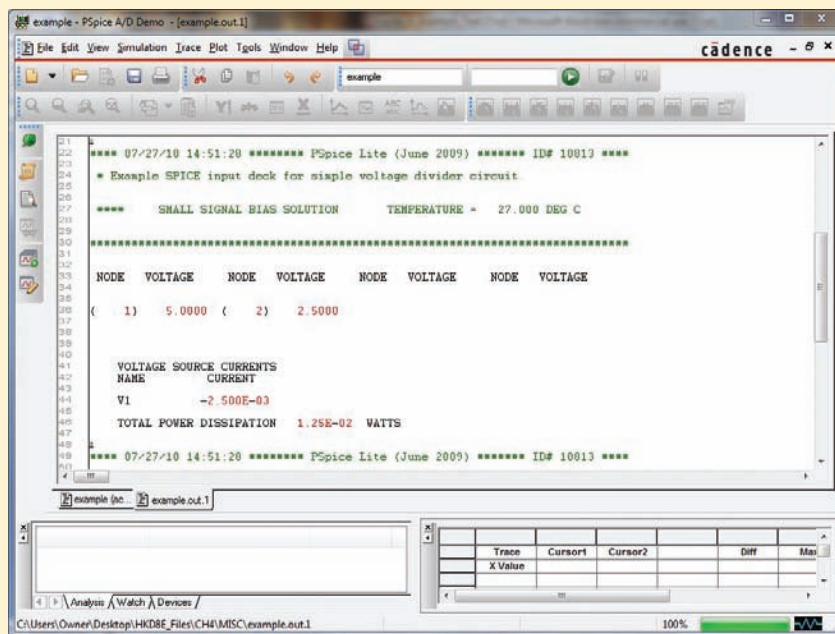

(b)

■ FIGURE 4.33 (a) PSpice A/D window after the input deck describing our voltage divider is loaded. (b) Output window, showing nodal voltages and current from the source (but quoted using the passive sign convention). Note that the voltage across R1 requires post-simulation subtraction.

## SUMMARY AND REVIEW

Although Chap. 3 introduced KCL and KVL, both of which are sufficient to enable us to analyze any circuit, a more methodical approach proves helpful in everyday situations. Thus, in this chapter we developed the nodal analysis technique based on KCL, which results in a voltage at each node

(with respect to some designated “reference” node). We generally need to solve a system of simultaneous equations, unless voltage sources are connected so that they automatically provide nodal voltages. The controlling quantity of a *dependent* source is written down just as we would write down the numerical value of an “independent” source. Typically an additional equation is then required, unless the dependent source is controlled by a nodal voltage. When a voltage source bridges two nodes, the basic technique can be extended by creating a *supernode*; KCL dictates that the sum of the currents flowing into a group of connections so defined is equal to the sum of the currents flowing out.

As an alternative to nodal analysis, the mesh analysis technique was developed through application of KVL; it yields the complete set of *mesh* currents, which do not always represent the *net* current flowing through any particular element (for example, if an element is shared by two meshes). The presence of a current source will simplify the analysis if it lies on the periphery of a mesh; if the source is shared, then the *supermesh* technique is best. In that case, we write a KVL equation around a path that avoids the shared current source, then algebraically link the two corresponding mesh currents using the source.

A common question is: “Which analysis technique should I use?” We discussed some of the issues that might go into choosing a technique for a given circuit. These included whether or not the circuit is planar, what types of sources are present and how they are connected, and also what specific information is required (i.e., a voltage, current, or power). For complex circuits, it may take a greater effort than it is worth to determine the “optimum” approach, in which case most people will opt for the method with which they feel most comfortable. We concluded the chapter by introducing PSpice, a common circuit simulation tool, which is very useful for checking our results.

At this point we wrap up by identifying key points of this chapter to review, along with relevant example(s).

- Start each analysis with a neat, simple circuit diagram. Indicate all element and source values. (Example 4.1)
- For nodal analysis,
  - Choose one node as the reference node. Then label the node voltages  $v_1, v_2, \dots, v_{N-1}$ . Each is understood to be measured with respect to the reference node. (Examples 4.1, 4.2)
  - If the circuit contains only current sources, apply KCL at each nonreference node. (Examples 4.1, 4.2)
  - If the circuit contains voltage sources, form a supernode about each one, and then apply KCL at all nonreference nodes and supernodes. (Examples 4.5, 4.6)
- For mesh analysis, first make certain that the network is a planar network.
  - Assign a clockwise mesh current in each mesh:  $i_1, i_2, \dots, i_M$ . (Example 4.7)
  - If the circuit contains only voltage sources, apply KVL around each mesh. (Examples 4.7, 4.8, 4.9)
  - If the circuit contains current sources, create a supermesh for each one that is common to two meshes, and then apply KVL around each mesh and supermesh. (Examples 4.11, 4.12)

- Dependent sources will add an additional equation to nodal analysis if the controlling variable is a current, but not if the controlling variable is a nodal voltage. (Conversely, a dependent source will add an additional equation to mesh analysis if the controlling variable is a voltage, but not if the controlling variable is a mesh current). (Examples 4.3, 4.4, 4.6, 4.9, 4.10, 4.12)
- In deciding whether to use nodal or mesh analysis for a planar circuit, a circuit with fewer nodes/supernodes than meshes/supermeshes will result in fewer equations using nodal analysis.
- Computer-aided analysis is useful for checking results and analyzing circuits with large numbers of elements. However, common sense must be used to check simulation results.

## READING FURTHER

A detailed treatment of nodal and mesh analysis can be found in:

R. A. DeCarlo and P. M. Lin, *Linear Circuit Analysis*, 2nd ed. New York: Oxford University Press, 2001.

A solid guide to SPICE is

P. Tuinenga, *SPICE: A Guide to Circuit Simulation and Analysis Using PSpice*, 3rd ed. Upper Saddle River, N.J.: Prentice-Hall, 1995.

## EXERCISES

### 4.1 Nodal Analysis

1. Solve the following systems of equations:

(a)  $2v_2 - 4v_1 = 9$  and  $v_1 - 5v_2 = -4$ ;

(b)  $-v_1 + 2v_3 = 8$ ;  $2v_1 + v_2 - 5v_3 = -7$ ;  $4v_1 + 5v_2 + 8v_3 = 6$ .

2. Evaluate the following determinants:

(a)  $\begin{vmatrix} 2 & 1 \\ -4 & 3 \end{vmatrix}$       (b)  $\begin{vmatrix} 0 & 2 & 11 \\ 6 & 4 & 1 \\ 3 & -1 & 5 \end{vmatrix}$ .

3. Employ Cramer's rule to solve for  $v_2$  in each part of Exercise 1.

4. (a) Solve the following system of equations:

$$3 = \frac{v_1}{5} - \frac{v_2 - v_1}{22} + \frac{v_1 - v_3}{3}$$

$$2 - 1 = \frac{v_2 - v_1}{22} + \frac{v_2 - v_3}{14}$$

$$0 = \frac{v_3}{10} + \frac{v_3 - v_1}{3} + \frac{v_3 - v_2}{14}$$

(b) Verify your solution using MATLAB.

5. (a) Solve the following system of equations:

$$7 = \frac{v_1}{2} - \frac{v_2 - v_1}{12} + \frac{v_1 - v_3}{19}$$

$$15 = \frac{v_2 - v_1}{12} + \frac{v_2 - v_3}{2}$$

$$4 = \frac{v_3}{7} + \frac{v_3 - v_1}{19} + \frac{v_3 - v_2}{2}$$

(b) Verify your solution using MATLAB.





6. Correct (and verify by running) the following MATLAB code:

```
>> e1 = '3 = v/7 - (v2 - v1)/2 + (v1 - v3)/3;
>> e2 = '2 = (v2 - v1)/2 + (v2 - v3)/14';
>> e3 = '0 = v3/10 + (v3 - v1)/3 + (v3 - v2)/14';
>>
>> a = solve(e1 e2 e3, 'v1', v2, 'v3')
```

7. Identify the obvious errors in the following complete set of nodal equations if the last equation is known to be correct:

$$7 = \frac{v_1}{4} - \frac{v_2 - v_1}{1} + \frac{v_1 - v_3}{9}$$

$$0 = \frac{v_2 - v_1}{2} + \frac{v_2 - v_3}{2}$$

$$4 = \frac{v_3}{7} + \frac{v_3 - v_1}{19} + \frac{v_3 - v_2}{2}$$

8. In the circuit of Fig. 4.34, determine the current labeled  $i$  with the assistance of nodal analysis techniques.

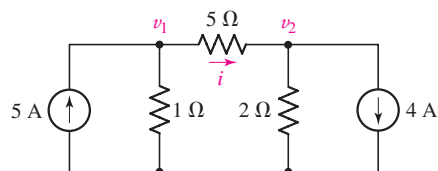

■ FIGURE 4.34

9. Calculate the power dissipated in the 1 Ω resistor of Fig. 4.35.

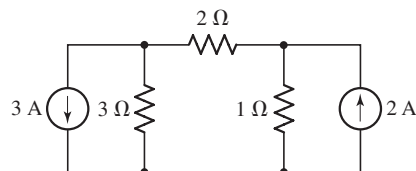

■ FIGURE 4.35

10. With the assistance of nodal analysis, determine  $v_1 - v_2$  in the circuit shown in Fig. 4.36.

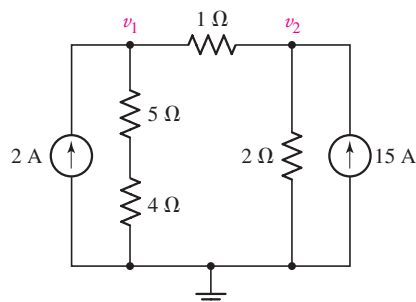

■ FIGURE 4.36



11. For the circuit of Fig. 4.37, determine the value of the voltage labeled  $v_1$  and the current labeled  $i_1$ .

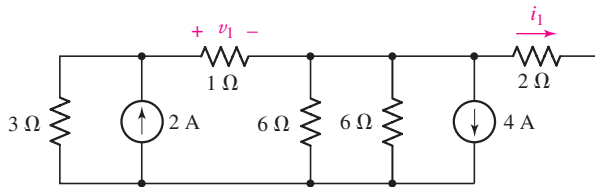

■ FIGURE 4.37

12. Use nodal analysis to find  $v_P$  in the circuit shown in Fig. 4.38.

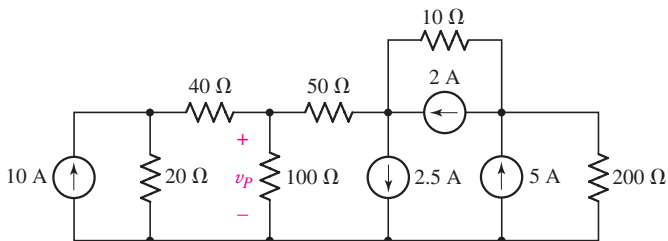

■ FIGURE 4.38

13. Using the bottom node as reference, determine the voltage across the  $5 \Omega$  resistor in the circuit of Fig. 4.39, and calculate the power dissipated by the  $7 \Omega$  resistor.

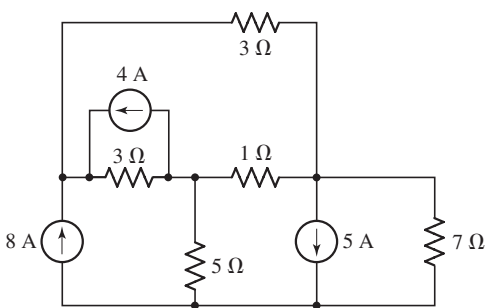

■ FIGURE 4.39

14. For the circuit of Fig. 4.40, use nodal analysis to determine the current  $i_5$ .

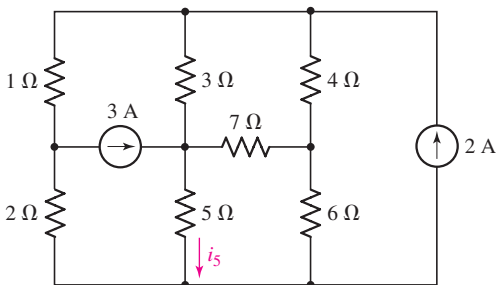

■ FIGURE 4.40

15. Determine a numerical value for each nodal voltage in the circuit of Fig. 4.41.

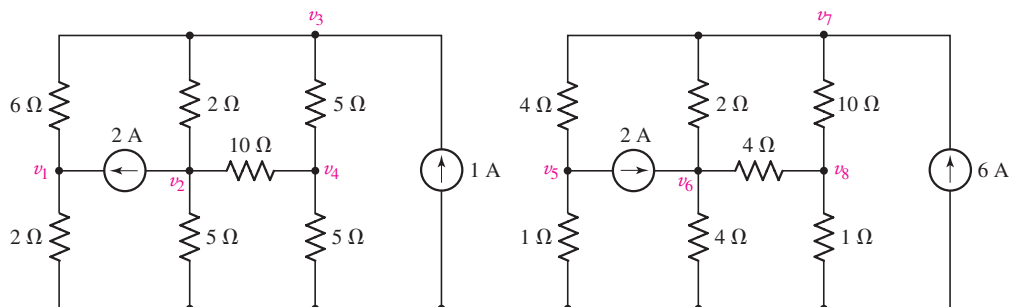

■ FIGURE 4.41

16. Determine the current  $i_2$  as labeled in the circuit of Fig. 4.42, with the assistance of nodal analysis.

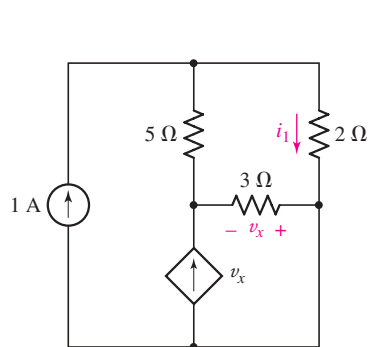

■ FIGURE 4.43

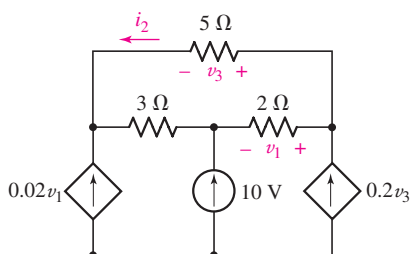

■ FIGURE 4.42

17. Using nodal analysis as appropriate, determine the current labeled  $i_1$  in the circuit of Fig. 4.43.

## 4.2 The Supernode

18. Determine the nodal voltages as labeled in Fig. 4.44, making use of the supernode technique as appropriate.

19. For the circuit shown in Fig. 4.45, determine a numerical value for the voltage labeled  $v_1$ .

20. For the circuit of Fig. 4.46, determine all four nodal voltages.

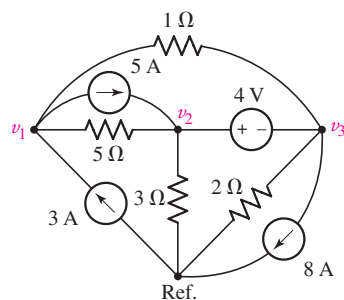

■ FIGURE 4.44

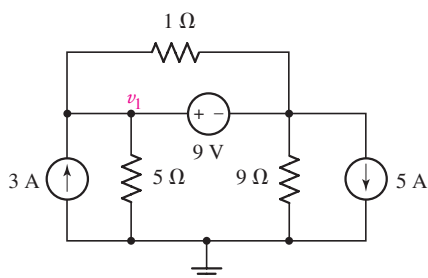

■ FIGURE 4.45

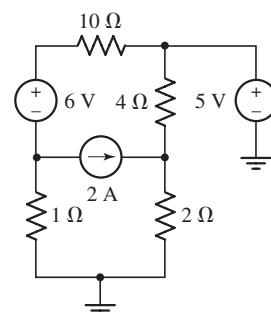

■ FIGURE 4.46

21. Employing supernode/nodal analysis techniques as appropriate, determine the power dissipated by the  $1\ \Omega$  resistor in the circuit of Fig. 4.47.

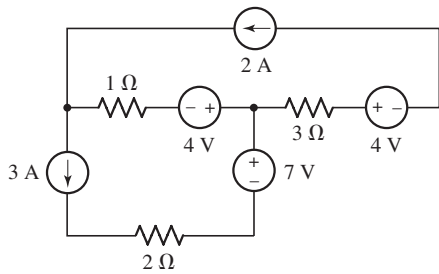

■ FIGURE 4.47

22. Referring to the circuit of Fig. 4.48, obtain a numerical value for the power supplied by the 1 V source.

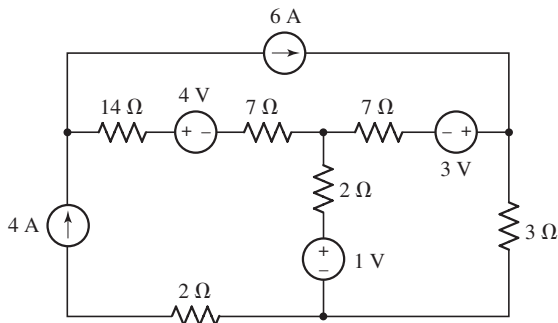

■ FIGURE 4.48

23. Determine the voltage labeled  $v$  in the circuit of Fig. 4.49.  
 24. Determine the voltage  $v_x$  in the circuit of Fig. 4.50, and the power supplied by the 1 A source.

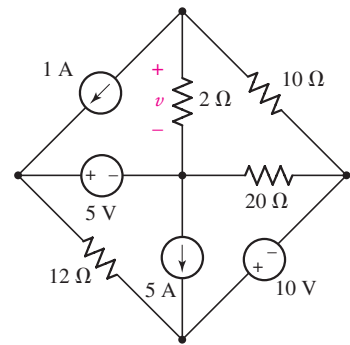

■ FIGURE 4.49

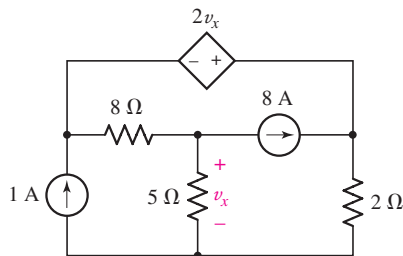

■ FIGURE 4.50

25. Consider the circuit of Fig. 4.51. Determine the current labeled  $i_1$ .

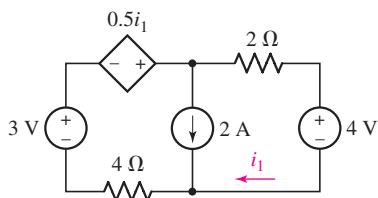

■ FIGURE 4.51

26. Determine the value of  $k$  that will result in  $v_x$  being equal to zero in the circuit of Fig. 4.52.

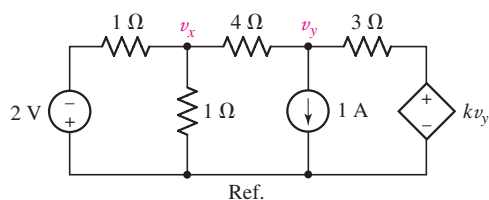

■ FIGURE 4.52

27. For the circuit depicted in Fig. 4.53, determine the voltage labeled  $v_1$  across the  $3\ \Omega$  resistor.

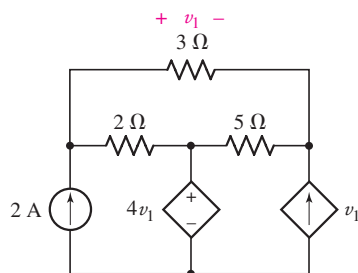

■ FIGURE 4.53

28. For the circuit of Fig. 4.54, determine all four nodal voltages.

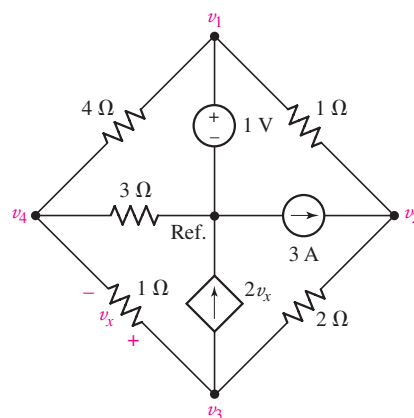

■ FIGURE 4.54

### 4.3 Mesh Analysis

29. Determine the currents flowing out of the positive terminal of each voltage source in the circuit of Fig. 4.55.

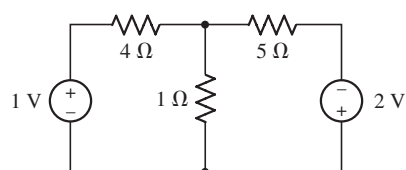

■ FIGURE 4.55

30. Obtain numerical values for the two mesh currents  $i_1$  and  $i_2$  in the circuit shown in Fig. 4.56.

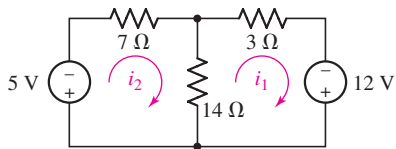

■ FIGURE 4.56

31. Use mesh analysis as appropriate to determine the two mesh currents labeled in Fig. 4.57.

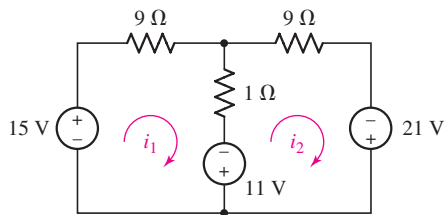

■ FIGURE 4.57

32. Determine numerical values for each of the three mesh currents as labeled in the circuit diagram of Fig. 4.58.

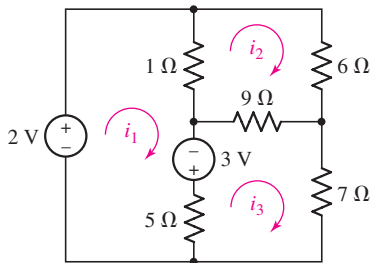

■ FIGURE 4.58

33. Calculate the power dissipated by each resistor in the circuit of Fig. 4.58.
34. Employing mesh analysis as appropriate, obtain (a) a value for the current  $i_y$  and (b) the power dissipated by the  $220\ \Omega$  resistor in the circuit of Fig. 4.59.
35. Choose nonzero values for the three voltage sources of Fig. 4.60 so that no current flows through any resistor in the circuit.

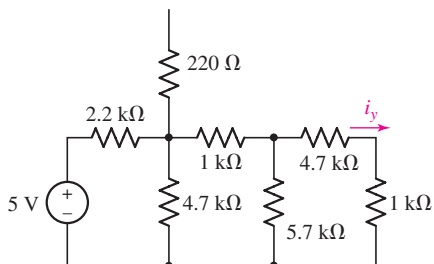

■ FIGURE 4.59

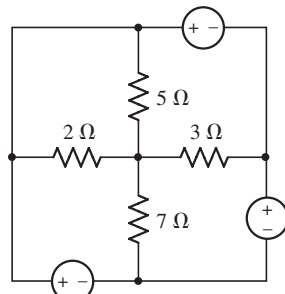

■ FIGURE 4.60

36. Calculate the current  $i_x$  in the circuit of Fig. 4.61.

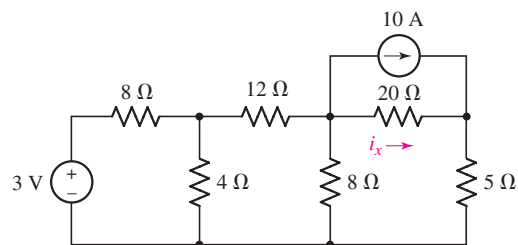

■ FIGURE 4.61

37. Employing mesh analysis procedures, obtain a value for the current labeled  $i$  in the circuit represented by Fig. 4.62.

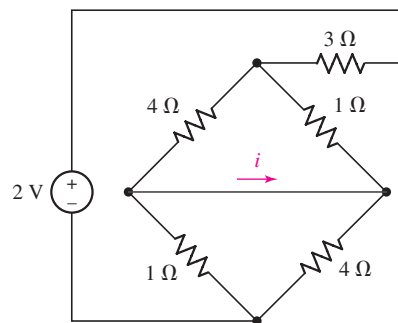

■ FIGURE 4.62

38. Determine the power dissipated in the  $4\ \Omega$  resistor of the circuit shown in Fig. 4.63.

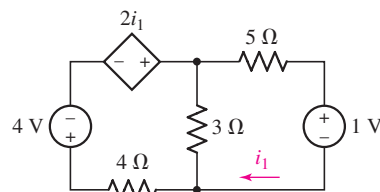

■ FIGURE 4.63

39. (a) Employ mesh analysis to determine the power dissipated by the  $1\ \Omega$  resistor in the circuit represented schematically by Fig. 4.64. (b) Check your answer using nodal analysis.

40. Define three clockwise mesh currents for the circuit of Fig. 4.65, and employ mesh analysis to obtain a value for each.

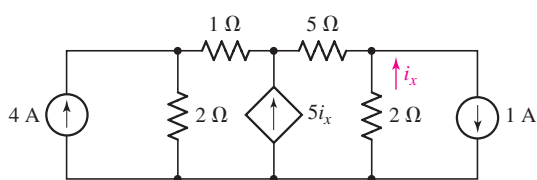

■ FIGURE 4.64

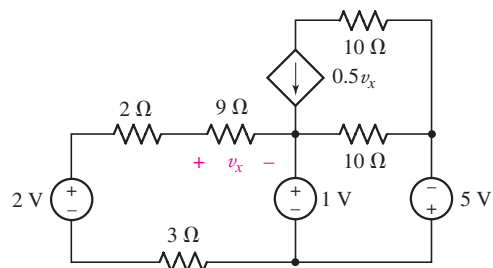

■ FIGURE 4.65

41. Employ mesh analysis to obtain values for  $i_x$  and  $v_a$  in the circuit of Fig. 4.66.

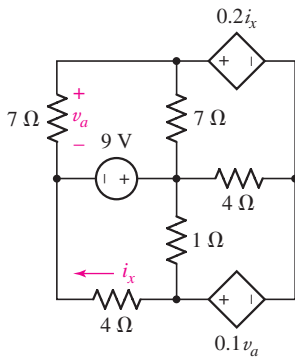

■ FIGURE 4.66

#### 4.4 The Supermesh

42. Determine values for the three mesh currents of Fig. 4.67.

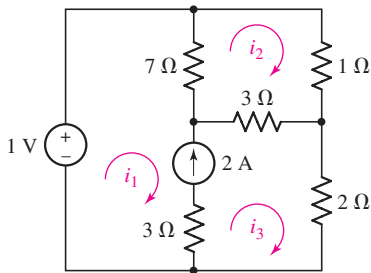

■ FIGURE 4.67

43. Through appropriate application of the supermesh technique, obtain a numerical value for the mesh current  $i_3$  in the circuit of Fig. 4.68, and calculate the power dissipated by the  $1\ \Omega$  resistor.

44. For the circuit of Fig. 4.69, determine the mesh current  $i_1$  and the power dissipated by the  $1\ \Omega$  resistor.

45. Calculate the three mesh currents labeled in the circuit diagram of Fig. 4.70.

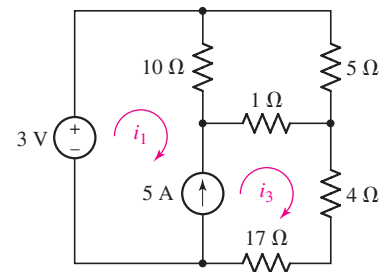

■ FIGURE 4.68

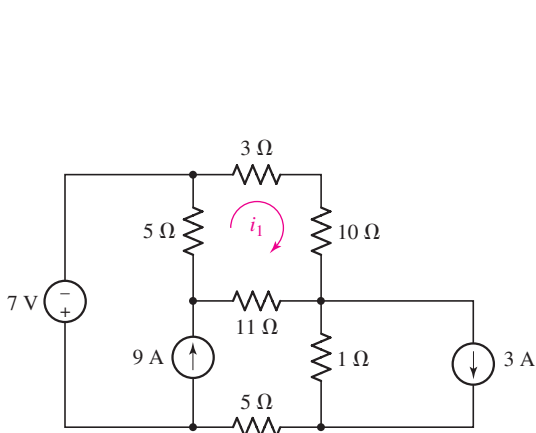

■ FIGURE 4.69

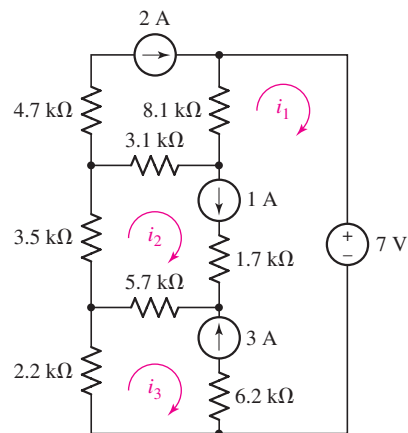

■ FIGURE 4.70

46. Employing the supermesh technique to best advantage, obtain numerical values for each of the mesh currents identified in the circuit depicted in Fig. 4.71.

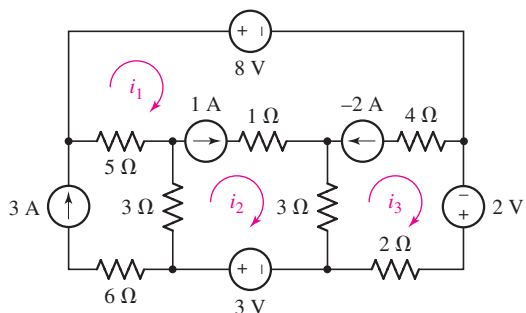

■ FIGURE 4.71

47. Through careful application of the supermesh technique, obtain values for all three mesh currents as labeled in Fig. 4.72.

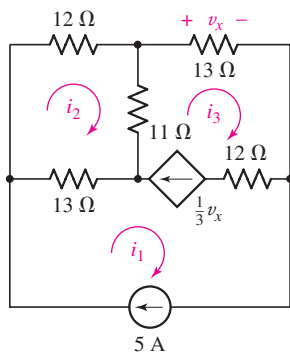

■ FIGURE 4.72

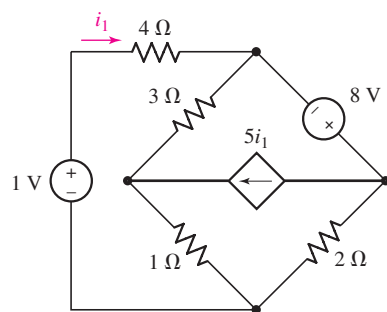

■ FIGURE 4.73

48. Determine the power supplied by the 1 V source in Fig. 4.73.
49. Define three clockwise mesh currents for the circuit of Fig. 4.74, and employ the supermesh technique to obtain a numerical value for each.
50. Determine the power absorbed by the 10 Ω resistor in Fig. 4.75.

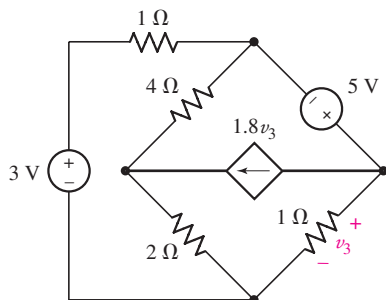

■ FIGURE 4.74

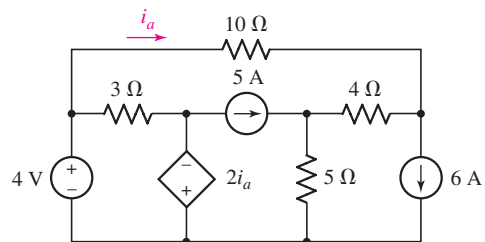

■ FIGURE 4.75



#### 4.5 Nodal vs. Mesh Analysis: A Comparison

51. For the circuit represented schematically in Fig. 4.76: (a) How many nodal equations would be required to determine  $i_5$ ? (b) Alternatively, how many mesh equations would be required? (c) Would your preferred analysis method change if only the voltage across the  $7\ \Omega$  resistor were needed? *Explain.*

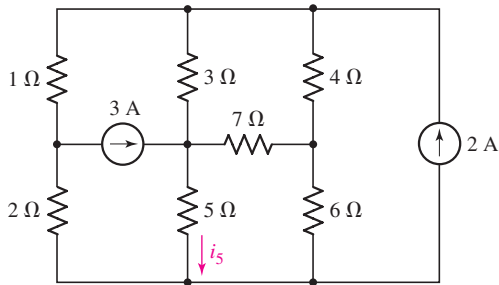

■ FIGURE 4.76

52. The circuit of Fig. 4.76 is modified such that the  $3\ \text{A}$  source is replaced by a  $3\ \text{V}$  source whose positive reference terminal is connected to the  $7\ \Omega$  resistor. (a) Determine the number of nodal equations required to determine  $i_5$ . (b) Alternatively, how many mesh equations would be required? (c) Would your preferred analysis method change if only the voltage across the  $7\ \Omega$  resistor were needed? *Explain.*
53. The circuit of Fig. 4.77 contains three sources. (a) As presently drawn, would nodal or mesh analysis result in fewer equations to determine the voltages  $v_1$  and  $v_2$ ? *Explain.* (b) If the voltage source were replaced with current sources, and the current source replaced with a voltage source, would your answer to part (a) change? *Explain?*

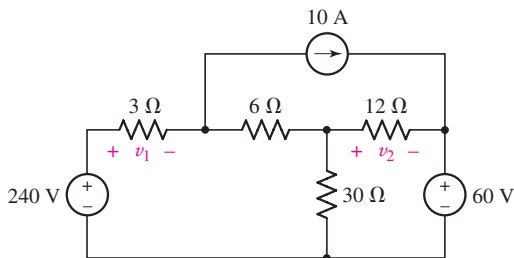

■ FIGURE 4.77

54. Solve for the voltage  $v_x$  as labeled in the circuit of Fig. 4.78 using (a) mesh analysis. (b) Repeat using nodal analysis. (c) Which approach was easier, and why?

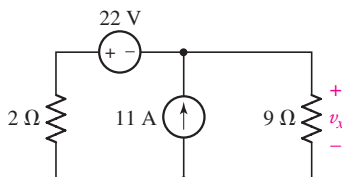

■ FIGURE 4.78

55. Consider the five-source circuit of Fig. 4.79. Determine the total number of simultaneous equations that must be solved in order to determine  $v_1$  using (a) nodal analysis; (b) mesh analysis. (c) Which method is preferred, and does it depend on which side of the  $40\ \Omega$  resistor is chosen as the reference node? Explain your answer.

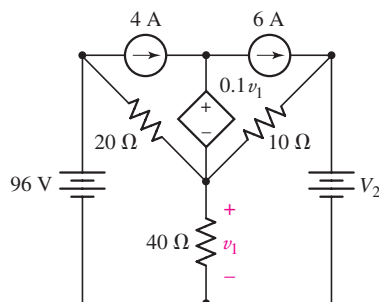

■ FIGURE 4.79

56. Replace the dependent voltage source in the circuit of Fig. 4.79 with a dependent current source oriented such that the arrow points upward. The controlling expression  $0.1v_1$  remains unchanged. The value  $V_2$  is zero. (a) Determine the total number of simultaneous equations required to obtain the power dissipated by the  $40\ \Omega$  resistor if nodal analysis is employed. (b) Is mesh analysis preferred instead? Explain.
57. After studying the circuit of Fig. 4.80, determine the total number of simultaneous equations that must be solved to determine voltages  $v_1$  and  $v_3$  using (a) nodal analysis; (b) mesh analysis.

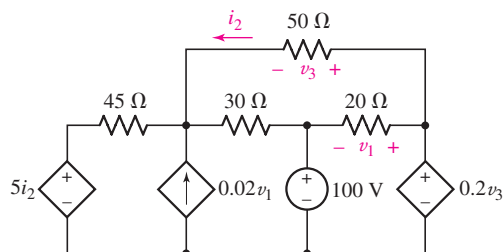

■ FIGURE 4.80



58. From the perspective of determining voltages and currents associated with all components, (a) design a five-node, four-mesh circuit that is analyzed more easily using nodal techniques. (b) Modify your circuit by replacing only one component such that it is now more easily analyzed using mesh techniques.

#### 4.6 Computer-Aided Circuit Analysis



59. Employ PSpice (or similar CAD tool) to verify the solution of Exercise 8. Submit a printout of a properly labeled schematic with the answer highlighted, along with your hand calculations.



60. Employ PSpice (or similar CAD tool) to verify the solution of Exercise 10. Submit a printout of a properly labeled schematic with the two nodal voltages highlighted, along with your hand calculations solving for the same quantities.



61. Employ PSpice (or similar CAD tool) to verify the voltage across the  $5\ \Omega$  resistor in the circuit of Exercise 13. Submit a printout of a properly labeled schematic with the answer highlighted, along with your hand calculations.

62. Verify numerical values for each nodal voltage in Exercise 15 by employing PSpice or a similar CAD tool. Submit a printout of an appropriately labeled schematic with the nodal voltages highlighted, along with your hand calculations.
63. Verify the numerical values for  $i_1$  and  $v_x$  as indicated in the circuit accompanying Exercise 17, using PSpice or a similar CAD tool. Submit a printout of a properly labeled schematic with the answers highlighted, along with hand calculations.
64. (a) Generate an input deck for SPICE to determine the voltage  $v_9$  as labeled in Fig. 4.81. Submit a printout of the output file with the solution highlighted. (b) Verify your answer by hand.

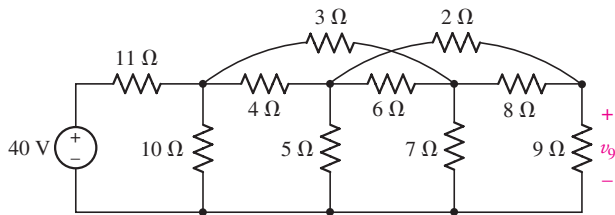

FIGURE 4.81

### Chapter-Integrating Exercises

65. (a) Design a circuit employing only 9 V batteries and standard 5% tolerance value resistors that provide voltages of 1.5 V, 4.5 V, and 5 V and at least one mesh current of 1 mA. (b) Verify your design using PSpice or similar CAD tool.
66. A decorative string of multicolored outdoor lights is installed on a home in a quiet residential area. After plugging the 12 V ac adapter into the electrical socket, the homeowner immediately notes that two bulbs are burned out. (a) Are the individual lights connected in series or parallel? *Explain.* (b) Simulate the string by writing a SPICE input deck, assuming 44 lights, 12 V dc power supply, 24 AWG soft solid copper wire, and individual bulbs rated at 10 mW each. Submit a printout of the output file, with the power supplied by the 12 V supply highlighted. (c) Verify your simulation with hand calculations.
67. Consider the circuit depicted in Fig. 4.82. Employ either nodal or mesh analysis as a design tool to obtain a value of 200 mA for  $i_1$ , if elements A, B, C, D, E, and F must be either current or voltage sources with nonzero values.

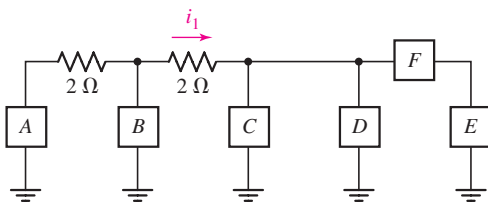
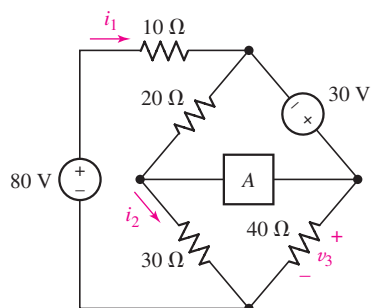

FIGURE 4.82

68. (a) Under what circumstances does the presence of an independent voltage source greatly simplify nodal analysis? *Explain.* (b) Under what circumstances does the presence of an independent current source significantly simplify mesh analysis? *Explain.* (c) On which fundamental physical principle do we base nodal analysis? (d) On which fundamental physical principle do we base mesh analysis?

69. Referring to Fig. 4.83, (a) determine whether nodal or mesh analysis is more appropriate in determining  $i_2$  if element A is replaced with a short circuit, then carry out the analysis. (b) Verify your answer with an appropriate PSpice simulation. Submit a properly labeled schematic along with the answer highlighted.



■ FIGURE 4.83

70. The element marked A in the circuit of Fig. 4.83 is replaced by a 2.5 V independent voltage source with the positive reference terminal connected to the common node of the 20 Ω and 30 Ω resistors. (a) Determine whether mesh or nodal analysis is more straightforward for determining the voltage marked  $v_3$ . (b) Verify your answer using PSpice. (c) Would your conclusion for part (a) change if the current  $i_2$  were required as well? *Explain.*

# Handy Circuit Analysis Techniques

## INTRODUCTION

The techniques of nodal and mesh analysis described in Chap. 4 are reliable and extremely powerful methods. However, both require that we develop a complete set of equations to describe a particular circuit as a general rule, even if only one current, voltage, or power quantity is of interest. In this chapter, we investigate several different techniques for isolating specific parts of a circuit in order to simplify the analysis. After examining each of these techniques, we focus on how one might go about selecting one method over another.

## 5.1 LINEARITY AND SUPERPOSITION

All of the circuits which we plan to analyze can be classified as *linear circuits*, so this is a good time to be more specific in defining exactly what we mean by that. Having done this, we can then consider the most important consequence of linearity, the principle of *superposition*. This principle is very basic and will appear repeatedly in our study of linear circuit analysis. As a matter of fact, the nonapplicability of superposition to nonlinear circuits is the very reason they are so difficult to analyze!

The principle of superposition states that the *response* (a desired current or voltage) in a linear circuit having more than one independent source can be obtained by adding the responses caused by the separate independent sources *acting alone*.

### Linear Elements and Linear Circuits

We define a *linear element* as a passive element that has a linear voltage-current relationship. By a “linear voltage-current relationship”

## KEY CONCEPTS

Superposition: Determining the *Individual Contributions* of Different Sources to Any Current or Voltage

Source Transformation as a Means of Simplifying Circuits

Thévenin’s Theorem

Norton’s Theorem

Thévenin and Norton Equivalent Networks

Maximum Power Transfer

$\Delta \leftrightarrow Y$  Transformations for Resistive Networks

Selecting a Particular Combination of Analysis Techniques

Performing dc Sweep Simulations Using PSpice



we simply mean that multiplication of the current through the element by a constant  $K$  results in the multiplication of the voltage across the element by the same constant  $K$ . At this time, only one passive element has been defined (the resistor), and its voltage-current relationship

$$v(t) = Ri(t)$$

is clearly linear. As a matter of fact, if  $v(t)$  is plotted as a function of  $i(t)$ , the result is a straight line.

We define a **linear dependent source** as a dependent current or voltage source whose output current or voltage is proportional only to the first power of a specified current *or* voltage variable in the circuit (or to the *sum* of such quantities).

We now define a **linear circuit** as a circuit composed entirely of independent sources, linear dependent sources, and linear elements. From this definition, it is possible to show<sup>1</sup> that “the response is proportional to the source,” or that multiplication of all independent source voltages and currents by a constant  $K$  increases all the current and voltage responses by the same factor  $K$  (including the dependent source voltage or current outputs).

## The Superposition Principle

The most important consequence of linearity is **superposition**.

Let us explore the superposition principle by considering first the circuit of Fig. 5.1, which contains two independent sources, the current generators that force the currents  $i_a$  and  $i_b$  into the circuit. Sources are often called *forcing functions* for this reason, and the nodal voltages that they produce can be termed *response functions*, or simply *responses*. Both the forcing functions and the responses may be functions of time. The two nodal equations for this circuit are

$$0.7v_1 - 0.2v_2 = i_a \quad [1]$$

$$-0.2v_1 + 1.2v_2 = i_b \quad [2]$$

Now let us perform experiment  $x$ . We change the two forcing functions to  $i_{ax}$  and  $i_{bx}$ ; the two unknown voltages will now be different, so we will call them  $v_{1x}$  and  $v_{2x}$ . Thus,

$$0.7v_{1x} - 0.2v_{2x} = i_{ax} \quad [3]$$

$$-0.2v_{1x} + 1.2v_{2x} = i_{bx} \quad [4]$$

We next perform experiment  $y$  by changing the source currents to  $i_{ay}$  and  $i_{by}$  and measure the responses  $v_{1y}$  and  $v_{2y}$ :

$$0.7v_{1y} - 0.2v_{2y} = i_{ay} \quad [5]$$

$$-0.2v_{1y} + 1.2v_{2y} = i_{by} \quad [6]$$

(1) The proof involves first showing that the use of nodal analysis on the linear circuit can produce only linear equations of the form

$$a_1v_1 + a_2v_2 + \dots + a_Nv_N = b$$

where the  $a_i$  are constants (combinations of resistance or conductance values, constants appearing in dependent source expressions, 0, or  $\pm 1$ ), the  $v_i$  are the unknown node voltages (responses), and  $b$  is an independent source value or a sum of independent source values. Given a set of such equations, if we multiply all the  $b$ 's by  $K$ , then it is evident that the solution of this new set of equations will be the node voltages  $Kv_1, Kv_2, \dots, Kv_N$ .

The dependent voltage source  $v_s = 0.6i_1 - 14v_2$  is linear, but  $v_s = 0.6i_1^2$  and  $v_s = 0.6i_1v_2$  are not.

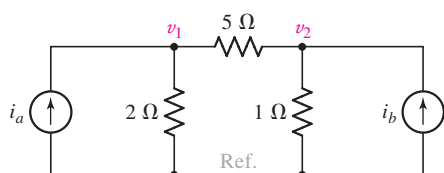

■ FIGURE 5.1 A circuit with two independent current sources.

These three sets of equations describe the same circuit with three different sets of source currents. Let us *add* or “*superpose*” the last two sets of equations. Adding Eqs. [3] and [5],

$$(0.7v_{1x} + 0.7v_{1y}) - (0.2v_{2x} + 0.2v_{2y}) = i_{ax} + i_{ay} \quad [7]$$

$$0.7v_1 - 0.2v_2 = i_a \quad [1]$$

and adding Eqs. [4] and [6],

$$-(0.2v_{1x} + 0.2v_{1y}) + (1.2v_{2x} + 1.2v_{2y}) = i_{bx} + i_{by} \quad [8]$$

$$-0.2v_1 + 1.2v_2 = i_b \quad [2]$$

where Eq. [1] has been written immediately below Eq. [7] and Eq. [2] below Eq. [8] for easy comparison.

The linearity of all these equations allows us to compare Eq. [7] with Eq. [1] and Eq. [8] with Eq. [2] and draw an interesting conclusion. If we select  $i_{ax}$  and  $i_{ay}$  such that their sum is  $i_a$  and select  $i_{bx}$  and  $i_{by}$  such that their sum is  $i_b$ , then the desired responses  $v_1$  and  $v_2$  may be found by adding  $v_{1x}$  to  $v_{1y}$  and  $v_{2x}$  to  $v_{2y}$ , respectively. In other words, we can perform experiment  $x$  and note the responses, perform experiment  $y$  and note the responses, and finally add the two sets of responses. This leads to the fundamental concept involved in the superposition principle: to look at each independent source (and the response it generates) one at a time with the other independent sources “turned off” or “zeroed out.”

If we reduce a voltage source to zero volts, we have effectively created a short circuit (Fig. 5.2a). If we reduce a current source to zero amps, we have effectively created an open circuit (Fig. 5.2b). Thus, the *superposition theorem* can be stated as:

In any linear resistive network, the voltage across or the current through any resistor or source may be calculated by adding algebraically all the individual voltages or currents caused by the separate independent sources acting alone, with all other independent voltage sources replaced by short circuits and all other independent current sources replaced by open circuits.

Thus, if there are  $N$  independent sources, we must perform  $N$  experiments, each having only one of the independent sources active and the others inactive/turned off/zeroed out. Note that *dependent* sources are in general active in every experiment.

There is also no reason that an independent source must assume only its given value or a zero value in the several experiments; it is necessary only for the sum of the several values to be equal to the original value. An inactive source almost always leads to the simplest circuit, however.

The circuit we have just used as an example should indicate that a much stronger theorem might be written; a *group* of independent sources may be made active and inactive collectively, if we wish. For example, suppose there are three independent sources. The theorem states that we may find a given response by considering each of the three sources acting alone and adding the three results. Alternatively, we may find the response due to the first and second sources operating with the third inactive, and then add to this the response caused by the third source acting alone. This amounts to treating several sources collectively as a sort of “supersource.”

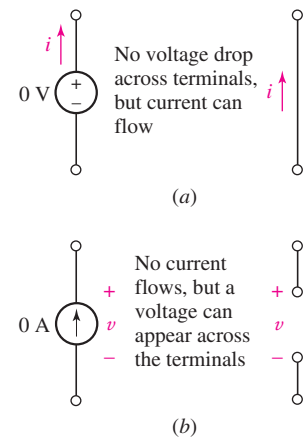

■ FIGURE 5.2 (a) A voltage source set to zero acts like a short circuit. (b) A current source set to zero acts like an open circuit.



## EXAMPLE 5.1

For the circuit of Fig. 5.3a, use superposition to determine the unknown branch current  $i_x$ .

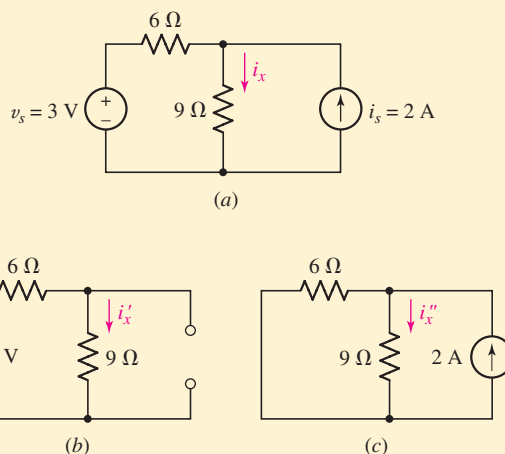

■ FIGURE 5.3 (a) An example circuit with two independent sources for which the branch current  $i_x$  is desired; (b) same circuit with current source open-circuited; (c) original circuit with voltage source short-circuited.

First set the current source equal to zero and redraw the circuit as shown in Fig. 5.3b. The portion of  $i_x$  due to the voltage source has been designated  $i'_x$  to avoid confusion and is easily found to be 0.2 A.

Next set the voltage source in Fig. 5.3a to zero and again redraw the circuit, as shown in Fig. 5.3c. Current division lets us determine that  $i''_x$  (the portion of  $i_x$  due to the 2 A current source) is 0.8 A.

Now compute the total current  $i_x$  by adding the two individual components:

$$i_x = i_{x|3V} + i_{x|2A} = i'_x + i''_x$$

or

$$i_x = \frac{3}{6+9} + 2 \left( \frac{6}{6+9} \right) = 0.2 + 0.8 = 1.0 \text{ A}$$

Another way of looking at Example 5.1 is that the 3 V source and the 2 A source are each performing work on the circuit, resulting in a total current  $i_x$  flowing through the 9 Ω resistor. *However, the contribution of the 3 V source to  $i_x$  does not depend on the contribution of the 2 A source, and vice versa.* For example, if we double the output of the 2 A source to 4 A, it will now contribute 1.6 A to the total current  $i_x$  flowing through the 9 Ω resistor. However, the 3 V source will still contribute only 0.2 A to  $i_x$ , for a new total current of  $0.2 + 1.6 = 1.8$  A.



## PRACTICE

5.1 For the circuit of Fig. 5.4, use superposition to compute the current  $i_x$ .

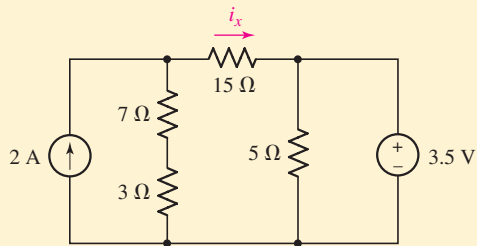

FIGURE 5.4

Ans: 660 mA.

As we will see, superposition does not generally reduce our workload when considering a particular circuit, since it leads to the analysis of several new circuits to obtain the desired response. However, it is particularly useful in identifying the significance of various parts of a more complex circuit. It also forms the basis of phasor analysis, which is introduced in Chap. 10.

## EXAMPLE 5.2

Referring to the circuit of Fig. 5.5a, determine the maximum positive current to which the source  $I_x$  can be set before any resistor exceeds its power rating and overheats.

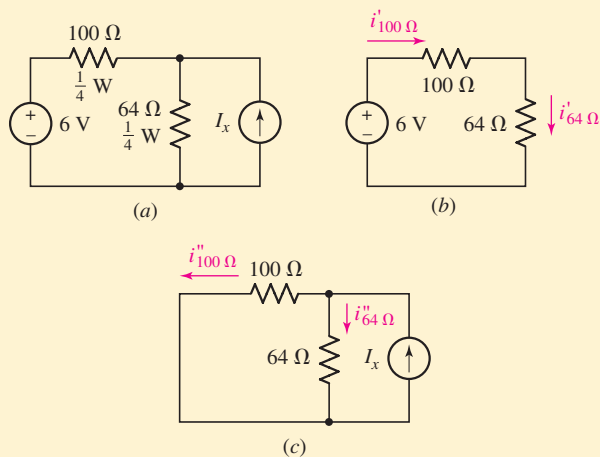

FIGURE 5.5 (a) A circuit with two resistors each rated at  $\frac{1}{4}$  W. (b) Circuit with only the 6 V source active. (c) Circuit with the source  $I_x$  active.

► **Identify the goal of the problem.**

Each resistor is rated to a maximum of 250 mW. If the circuit allows this value to be exceeded (by forcing too much current through either resistor), excessive heating will occur—possibly leading to

(Continued on next page)

an accident. The 6 V source cannot be changed, so we are looking for an equation involving  $I_x$  and the maximum current through each resistor.

► **Collect the known information.**

Based on its 250 mW power rating, the maximum current the 100  $\Omega$  resistor can tolerate is

$$\sqrt{\frac{P_{\max}}{R}} = \sqrt{\frac{0.250}{100}} = 50 \text{ mA}$$

and, similarly, the current through the 64  $\Omega$  resistor must be less than 62.5 mA.

► **Devise a plan.**

Either nodal or mesh analysis may be applied to the solution of this problem, but superposition may give us a slight edge, since we are primarily interested in the effect of the current source.

► **Construct an appropriate set of equations.**

Using superposition, we redraw the circuit as in Fig. 5.5b and find that the 6 V source contributes a current

$$i'_{100 \Omega} = \frac{6}{100 + 64} = 36.59 \text{ mA}$$

to the 100  $\Omega$  resistor and, since the 64  $\Omega$  resistor is in series,  $i'_{64 \Omega} = 36.59$  mA as well.

Recognizing the current divider in Fig. 5.5c, we note that  $i''_{64 \Omega}$  will add to  $i'_{64 \Omega}$ , but  $i''_{100 \Omega}$  is *opposite* in direction to  $i'_{100 \Omega}$ . Therefore,  $I_x$  can safely contribute  $62.5 - 36.59 = 25.91$  mA to the 64  $\Omega$  resistor current, and  $50 - (-36.59) = 86.59$  mA to the 100  $\Omega$  resistor current.

The 100  $\Omega$  resistor therefore places the following constraint on  $I_x$ :

$$I_x < (86.59 \times 10^{-3}) \left( \frac{100 + 64}{64} \right)$$

and the 64  $\Omega$  resistor requires that

$$I_x < (25.91 \times 10^{-3}) \left( \frac{100 + 64}{100} \right)$$

► **Attempt a solution.**

Considering the 100  $\Omega$  resistor first, we see that  $I_x$  is limited to  $I_x < 221.9$  mA. The 64  $\Omega$  resistor limits  $I_x$  such that  $I_x < 42.49$  mA. In order to satisfy both constraints,  $I_x$  must be less than 42.49 mA. If the value is increased, the 64  $\Omega$  resistor will overheat long before the 100  $\Omega$  resistor does.

► **Verify the solution. Is it reasonable or expected?**

One particularly useful way to evaluate our solution is to perform a dc sweep analysis in PSpice as described after the next example. An interesting question, however, is whether we would have expected the 64  $\Omega$  resistor to overheat first.

Originally we found that the 100  $\Omega$  resistor has a smaller maximum current, so it might be reasonable to expect it to limit  $I_x$ . However, because  $I_x$  *opposes* the current sent by the 6 V source through the 100  $\Omega$  resistor but *adds* to the 6 V source's contribution to the current through the 64  $\Omega$  resistor, it turns out to work the other way—it's the 64  $\Omega$  resistor that sets the limit on  $I_x$ .

## EXAMPLE 5.3

In the circuit of Fig. 5.6a, use the superposition principle to determine the value of  $i_x$ .

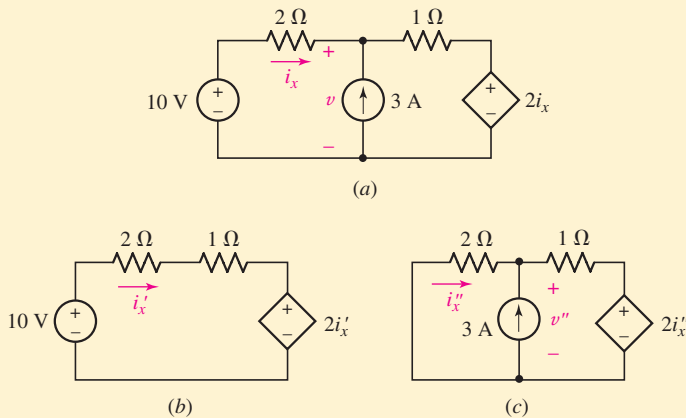

FIGURE 5.6 (a) An example circuit with two independent sources and one dependent source for which the branch current  $i_x$  is desired. (b) Circuit with the 3 A source open-circuited. (c) Original circuit with the 10 V source short-circuited.

First open-circuit the 3 A source (Fig. 5.6b). The single mesh equation is

$$-10 + 2i'_x + i'_x + 2i'_x = 0$$

so that

$$i'_x = 2 \text{ A}$$

Next, short-circuit the 10 V source (Fig. 5.6c) and write the single-node equation

$$\frac{v''}{2} + \frac{v'' - 2i''_x}{1} = 3$$

and relate the dependent-source-controlling quantity to  $v''$ :

$$v'' = 2(-i''_x)$$

Solving, we find

$$i''_x = -0.6 \text{ A}$$

and, thus,

$$i_x = i'_x + i''_x = 2 + (-0.6) = 1.4 \text{ A}$$

Note that in redrawing each subcircuit, we are always careful to use some type of notation to indicate that we are not working with the original variables. This prevents the possibility of rather disastrous errors when we add the individual results.

## PRACTICE

5.2 For the circuit of Fig. 5.7, use superposition to obtain the voltage across each current source.

Ans:  $v_{1|2\text{A}} = 9.180 \text{ V}$ ,  $v_{2|2\text{A}} = -1.148 \text{ V}$ ,  $v_{1|3\text{V}} = 1.967 \text{ V}$ ,  $v_{2|3\text{V}} = -0.246 \text{ V}$ ,  
 $v_1 = 11.147 \text{ V}$ ,  $v_2 = -1.394 \text{ V}$ .

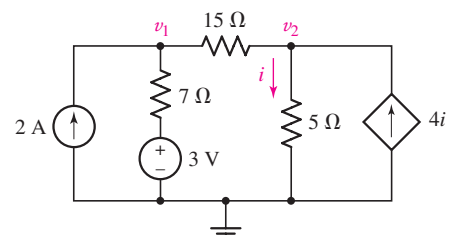

FIGURE 5.7

### Summary of Basic Superposition Procedure

1. **Select one of the independent sources. Set all other independent sources to zero.** This means voltage sources are replaced with short circuits and current sources are replaced with open circuits. Leave dependent sources in the circuit.
2. **Relabel voltages and currents using suitable notation** (e.g.,  $v'$ ,  $i_2''$ ). Be sure to relabel controlling variables of dependent sources to avoid confusion.
3. **Analyze the simplified circuit to find the desired currents and/or voltages.**
4. **Repeat steps 1 through 3 until each independent source has been considered.**
5. **Add the partial currents and/or voltages obtained from the separate analyses.** Pay careful attention to voltage signs and current directions when summing.
6. **Do not add power quantities.** If power quantities are required, calculate only after partial voltages and/or currents have been summed.

Note that step 1 may be altered in several ways. First, independent sources can be considered in groups as opposed to individually if it simplifies the analysis, as long as no independent source is included in more than one subcircuit. Second, it is technically not necessary to set sources to zero, although this is almost always the best route. For example, a 3 V source may appear in two subcircuits as a 1.5 V source, since  $1.5 + 1.5 = 3$  V just as  $0 + 3 = 3$  V. Because it is unlikely to simplify our analysis, however, there is little point to such an exercise.

## COMPUTER-AIDED ANALYSIS

Although PSpice is extremely useful in verifying that we have analyzed a complete circuit correctly, it can also assist us in determining the contribution of each source to a particular response. To do this, we employ what is known as a *dc parameter sweep*.

Consider the circuit presented in Example 5.2, when we were asked to determine the maximum positive current that could be obtained from the current source without exceeding the power rating of either resistor in the circuit. The circuit is shown redrawn using the Orcad Capture CIS schematic tool in Fig. 5.8. Note that no value has been assigned to the current source.

After the schematic has been entered and saved, the next step is to specify the dc sweep parameters. This option allows us to specify a range of values for a voltage or current source (in the present case, the current source  $I_x$ ), rather than a specific value. Selecting **New Simulation Profile** under **PSpice**, we provide a name for our profile and are then provided with the dialog box shown in Fig. 5.9.

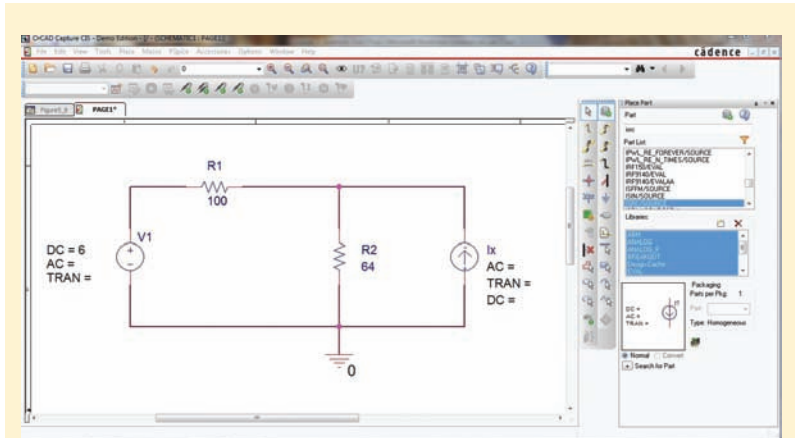

■ FIGURE 5.8 The circuit from Example 5.2.

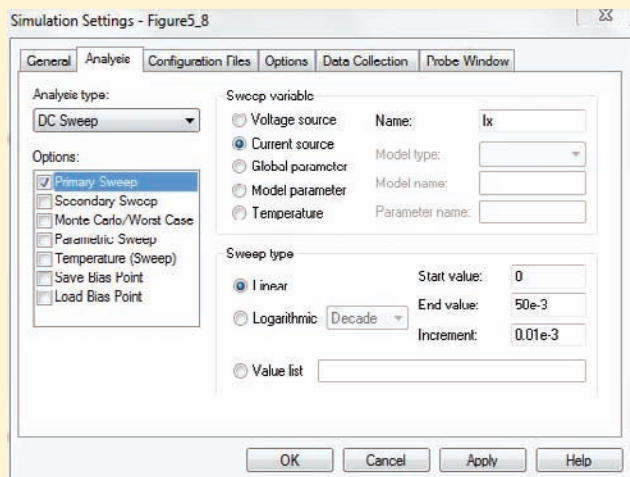

■ FIGURE 5.9 DC Sweep dialog box shown with  $I_x$  selected as the sweep variable.

Under **Analysis Type**, we pull down the **DC Sweep** option, specify the “sweep variable” as **Current Source**, and then type in  $I_x$  in the **Name** box. There are several options under Sweep Type: **Linear**, **Logarithmic**, and **Value List**. The last option allows us to specify each value to assign to  $I_x$ . In order to generate a smooth plot, however, we choose to perform a **Linear** sweep, with a **Start Value** of 0 mA, an **End Value** of 50 mA, and a value of 0.01 mA for the **Increment**.

After we perform the simulation, the graphical output package Probe is automatically launched. When the window appears, the horizontal axis (corresponding to our variable,  $I_x$ ) is displayed, but the vertical axis variable must be chosen. Selecting **Add Trace** from the **Trace** menu, we click on **I(R1)**, then type an asterisk in the **Trace Expression** box, click on **I(R1)** once again, insert yet another asterisk, and finally type in 100. This asks Probe to plot the power absorbed by the 100  $\Omega$  resistor. In a similar fashion, we repeat the process to add the power

*(Continued on next page)*

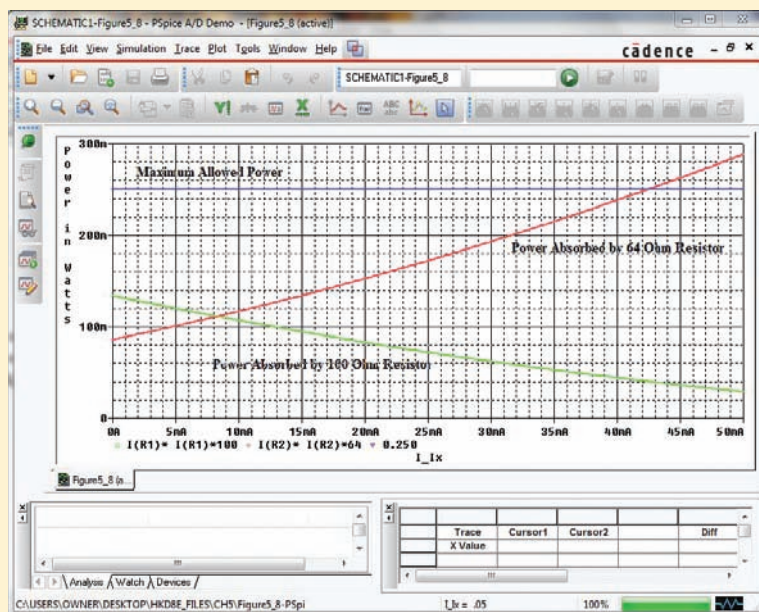

(a)

Trace	Cursor1	Cursor2	Diff	Max	Min
(R1)* I(R1)*100	39.989m	133.820m	-93.851m	133.820m	39.989m
(R2)* I(R2)*64	250.146m	85.692m	164.454m	250.146m	85.692m
0.250	250.000m	250.000m	0.000	250.000m	250.000m

(b)

■ FIGURE 5.10 (a) Probe output with text labels identifying the power absorbed by the two resistors individually. A horizontal line indicating 250 mW has also been included, as well as text labels to improve clarity. (b) Cursor dialog box.

absorbed by the  $64\ \Omega$  resistor, resulting in a plot similar to that shown in Fig. 5.10a. A horizontal reference line at 250 mW was also added to the plot by typing 0.250 in the **Trace Expression** box after selecting **Add Trace** from the **Trace** menu a third time.

We see from the plot that the  $64\ \Omega$  resistor *does* exceed its 250 mW power rating in the vicinity of  $I_x = 43$  mA. In contrast, however, we also see that regardless of the value of the current source  $I_x$  (provided that it is between 0 and 50 mA), the  $100\ \Omega$  resistor will never dissipate 250 mW; in fact, the absorbed power *decreases* with increasing current from the current source. If we desire a more precise answer, we can make use of the cursor tool, which is invoked by selecting **Trace, Cursor, Display** from the menu bar. Figure 5.10b shows the result of dragging cursor 1 to 42.52 A, where the  $64\ \Omega$  resistor is dissipating just over its maximum rated power of 250 mW. Increased precision can be obtained by decreasing the increment value used in the dc sweep.

This technique is very useful in analyzing electronic circuits, where we might need, for example, to determine what input voltage is required

to a complicated amplifier circuit in order to obtain a zero output voltage. We also notice that there are several other types of parameter sweeps that we can perform, including a dc voltage sweep. The ability to vary temperature is useful only when dealing with component models that have a temperature parameter built in, such as diodes and transistors.

Unfortunately, it usually turns out that little if any time is saved in analyzing a circuit containing one or more dependent sources by use of the superposition principle, for there must always be at least two sources in operation: one independent source and all the dependent sources.

*We must constantly be aware of the limitations of superposition.* It is applicable only to linear responses, and thus the most common nonlinear response—power—is not subject to superposition. For example, consider two 1 V batteries in series with a 1  $\Omega$  resistor. The power delivered to the resistor is 4 W, but if we mistakenly try to apply superposition, we might say that each battery alone furnished 1 W and thus the calculated power is only 2 W. This is incorrect, but a surprisingly easy mistake to make.



## 5.2 SOURCE TRANSFORMATIONS

### Practical Voltage Sources

So far, we've only worked with *ideal* sources—elements whose terminal voltage is independent of the current flowing through them. To see the relevance of this fact, consider a simple independent (“ideal”) 9 V source connected to a 1  $\Omega$  resistor. The 9 volt source will force a current of 9 amperes through the 1  $\Omega$  resistor (perhaps this seems reasonable enough), but the same source would apparently force 9,000,000 amperes through a 1 m $\Omega$  resistor (which hopefully does not seem reasonable). On paper, there's nothing to stop us from reducing the resistor value all the way to 0  $\Omega$  ... but that would lead to a contradiction, as the source would be “trying” to maintain 9 V across a dead short, which Ohm's law tells us can't happen ( $V = 9 = RI = 0$ ?).

**What happens in the real world when we do this type of experiment?** For example, if we try to start a car with the headlights already on, we most likely notice the headlights dim as the battery is asked to supply a large ( $\sim 100$  A or more) starter current in parallel with the current running to the headlights. If we model the 12 V battery with an ideal 12 V source as in Fig. 5.11a, our observation cannot be explained. Another way of saying this is that our model breaks down when the load draws a large current from the source.

To better approximate the behavior of a real device, the ideal voltage source must be modified to account for the lowering of its terminal voltage when large currents are drawn from it. Let us suppose that we observe experimentally that our car battery has a terminal voltage of 12 V when no current is flowing through it, and a reduced voltage of 11 V when 100 A is flowing. How could we model this behavior? Well, a more accurate model might be an ideal voltage source of 12 V in series with a resistor across which 1 V appears when 100 A flows through it. A quick calculation shows that the resistor must be  $1 \text{ V}/100 \text{ A} = 0.01 \Omega$ , and the ideal voltage source and this series resistor constitute a *practical voltage source* (Fig. 5.11b).

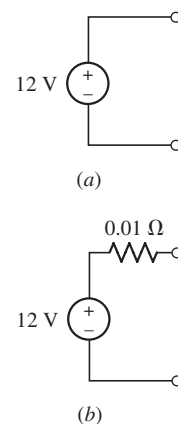

■ FIGURE 5.11 (a) An ideal 12 V dc voltage source used to model a car battery. (b) A more accurate model that accounts for the observed reduction in terminal voltage at large currents.

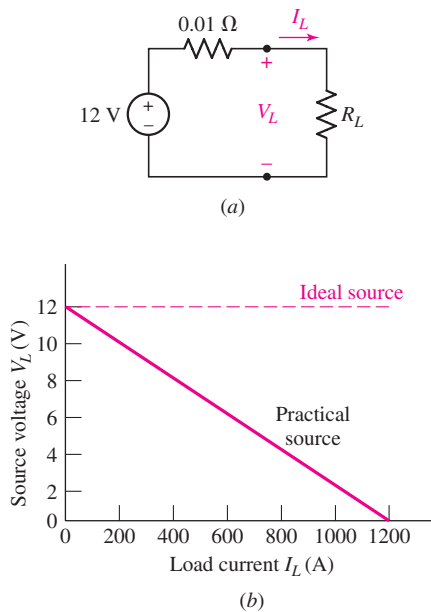

■ FIGURE 5.12 (a) A practical source, which approximates the behavior of a certain 12 V automobile battery, is shown connected to a load resistor  $R_L$ . (b) The relationship between  $i_L$  and  $v_L$  is linear.

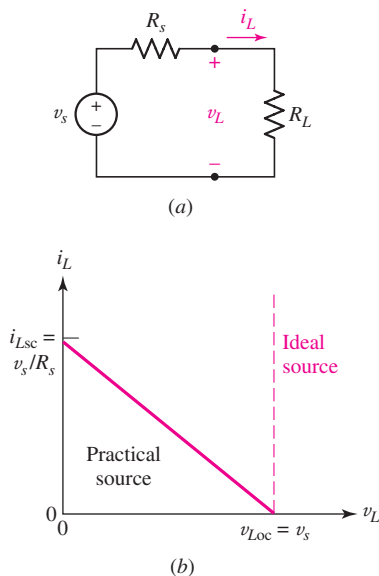

■ FIGURE 5.13 (a) A general practical voltage source connected to a load resistor  $R_L$ . (b) The terminal voltage of a practical voltage source decreases as  $i_L$  increases and  $R_L = v_L/i_L$  decreases. The terminal voltage of an ideal voltage source (also plotted) remains the same for any current delivered to a load.

Thus, we are using the series combination of two ideal circuit elements, an independent voltage source and a resistor, to model a real device.

We do not expect to find such an arrangement of ideal elements inside our car battery, of course. Any real device is characterized by a certain current-voltage relationship at its terminals, and our problem is to develop some combination of ideal elements that can furnish a similar current-voltage characteristic, at least over some useful range of current, voltage, or power.

In Fig. 5.12a, we show our two-piece practical model of the car battery now connected to some load resistor  $R_L$ . The terminal voltage of the practical source is the same as the voltage across  $R_L$  and is marked<sup>2</sup>  $V_L$ . Figure 5.12b shows a plot of load voltage  $V_L$  as a function of the load current  $I_L$  for this practical source. The KVL equation for the circuit of Fig. 5.12a may be written in terms of  $I_L$  and  $V_L$ :

$$12 = 0.01I_L + V_L$$

and thus

$$V_L = -0.01I_L + 12$$

This is a linear equation in  $I_L$  and  $V_L$ , and the plot in Fig. 5.12b is a straight line. Each point on the line corresponds to a different value of  $R_L$ . For example, the midpoint of the straight line is obtained when the load resistance is equal to the internal resistance of the practical source, or  $R_L = 0.01 \Omega$ . Here, the load voltage is exactly one-half the ideal source voltage.

When  $R_L = \infty$  and no current whatsoever is being drawn by the load, the practical source is open-circuited and the terminal voltage, or open-circuit voltage, is  $V_{Loc} = 12$  V. If, on the other hand,  $R_L = 0$ , thereby short-circuiting the load terminals, then a load current or short-circuit current,  $I_{Lsc} = 1200$  A, would flow. (*In practice, such an experiment would probably result in the destruction of the short circuit, the battery, and any measuring instruments incorporated in the circuit!*)

Since the plot of  $V_L$  versus  $I_L$  is a straight line for this practical voltage source, we should note that the values of  $V_{Loc}$  and  $I_{Lsc}$  uniquely determine the entire  $V_L$ - $I_L$  curve.

The horizontal broken line of Fig. 5.12b represents the  $V_L$ - $I_L$  plot for an ideal voltage source; the terminal voltage remains constant for any value of load current. For the practical voltage source, the terminal voltage has a value near that of the ideal source only when the load current is relatively small.

Let us now consider a general practical voltage source, as shown in Fig. 5.13a. The voltage of the ideal source is  $v_s$ , and a resistance  $R_s$ , called an *internal resistance* or *output resistance*, is placed in series with it. Again, we must note that the resistor is not really present as a separate component but merely serves to account for a terminal voltage that decreases as the load current increases. Its presence enables us to model the behavior of a physical voltage source more closely.

The linear relationship between  $v_L$  and  $i_L$  is

$$v_L = v_s - R_s i_L \quad [9]$$

(2) From this point on we will endeavor to adhere to the standard convention of referring to strictly dc quantities using capital letters, whereas lowercase letters denote a quantity that we know to possess some time-varying component. However, in describing general theorems which apply to either dc or ac, we will continue to use lowercase to emphasize the general nature of the concept.



and this is plotted in Fig. 5.13*b*. The open-circuit voltage ( $R_L = \infty$ , so  $i_L = 0$ ) is

$$v_{Loc} = v_s \quad [10]$$

and the short-circuit current ( $R_L = 0$ , so  $v_L = 0$ ) is

$$i_{Lsc} = \frac{v_s}{R_s} \quad [11]$$

Once again, these values are the intercepts for the straight line in Fig. 5.13*b*, and they serve to define it completely.

## Practical Current Sources

An ideal current source is also nonexistent in the real world; there is no physical device that will deliver a constant current regardless of the load resistance to which it is connected or the voltage across its terminals. Certain transistor circuits will deliver a constant current to a wide range of load resistances, but the load resistance can always be made sufficiently large that the current through it becomes very small. Infinite power is simply never available (unfortunately).

A practical current source is defined as an ideal current source in parallel with an internal resistance  $R_p$ . Such a source is shown in Fig. 5.14*a*, and the current  $i_L$  and voltage  $v_L$  associated with a load resistance  $R_L$  are indicated. Application of KCL yields

$$i_L = i_s - \frac{v_L}{R_p} \quad [12]$$

which is again a linear relationship. The open-circuit voltage and the short-circuit current are

$$v_{Loc} = R_p i_s \quad [13]$$

and

$$i_{Lsc} = i_s \quad [14]$$

The variation of load current with changing load voltage may be investigated by changing the value of  $R_L$  as shown in Fig. 5.14*b*. The straight line is traversed from the short-circuit, or “northwest,” end to the open-circuit termination at the “southeast” end by increasing  $R_L$  from zero to infinite ohms. The midpoint occurs for  $R_L = R_p$ . The load current  $i_L$  and the ideal source current are approximately equal only for small values of load voltage, which are obtained with values of  $R_L$  that are small compared to  $R_p$ .

## Equivalent Practical Sources

It may be no surprise that we can improve upon models to increase their accuracy; at this point we now have a practical voltage source model and also a practical current source model. Before we proceed, however, let's take a moment to compare Fig. 5.13*b* and Fig. 5.14*b*. One is for a circuit with a voltage source and the other, with a current source, *but the graphs are indistinguishable!*

It turns out that this is no coincidence. In fact, we are about to show that a practical voltage source *can be* electrically equivalent to a practical current source—meaning that a load resistor  $R_L$  connected to either will have

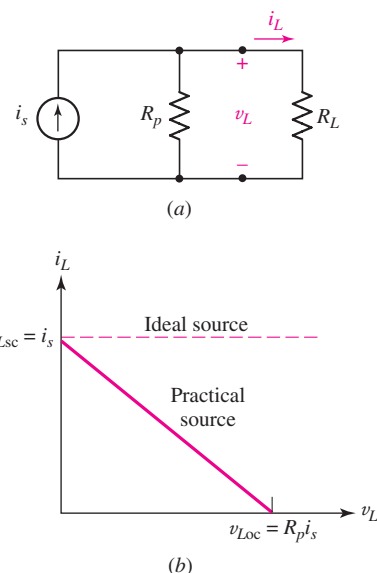

■ FIGURE 5.14 (a) A general practical current source connected to a load resistor  $R_L$ . (b) The load current provided by the practical current source is shown as a function of the load voltage.

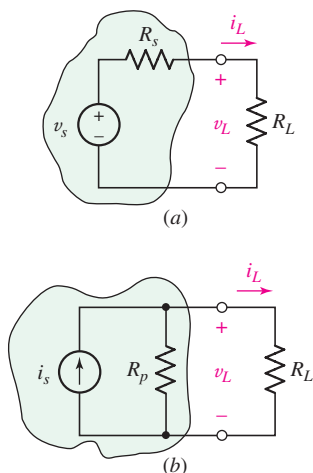

■ FIGURE 5.15 (a) A given practical voltage source connected to a load  $R_L$ . (b) The equivalent practical current source connected to the same load.

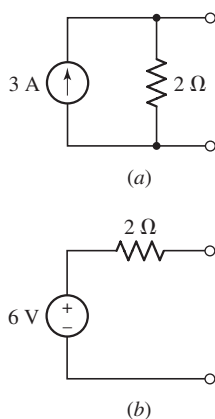

■ FIGURE 5.16 (a) A given practical current source. (b) The equivalent practical voltage source.



the same  $v_L$  and  $i_L$ . This means we can replace one practical source with the other and the rest of the circuit will not know the difference.

Consider the practical voltage source and resistor  $R_L$  shown in Fig. 5.15a, and the circuit composed of a practical current source and resistor  $R_L$  shown in Fig. 5.15b. A simple calculation shows that the voltage across the load  $R_L$  of Fig. 5.15a is

$$v_L = v_s \frac{R_L}{R_s + R_L} \quad [15]$$

A similar calculation shows that the voltage across the load  $R_L$  in Fig. 5.15b is

$$v_L = \left( i_s \frac{R_p}{R_p + R_L} \right) \cdot R_L$$

The two practical sources are electrically equivalent, then, if

$$R_s = R_p \quad [16]$$

and

$$v_s = R_p i_s = R_s i_s \quad [17]$$

where we now let  $R_s$  represent the internal resistance of either practical source, which is the conventional notation.

Let's try this with the practical current source shown in Fig. 5.16a. Since its internal resistance is  $2 \Omega$ , the internal resistance of the equivalent practical voltage source is also  $2 \Omega$ ; the voltage of the ideal voltage source contained within the practical voltage source is  $(2)(3) = 6 \text{ V}$ . The equivalent practical voltage source is shown in Fig. 5.16b.

To check the equivalence, let us visualize a  $4 \Omega$  resistor connected to each source. In both cases a current of  $1 \text{ A}$ , a voltage of  $4 \text{ V}$ , and a power of  $4 \text{ W}$  are associated with the  $4 \Omega$  load. However, we should note very carefully that the ideal current source is delivering a total power of  $12 \text{ W}$ , while the ideal voltage source is delivering only  $6 \text{ W}$ . Furthermore, the internal resistance of the practical current source is absorbing  $8 \text{ W}$ , whereas the internal resistance of the practical voltage source is absorbing only  $2 \text{ W}$ . Thus we see that the two practical sources are equivalent only with respect to what transpires at the load terminals; they are *not* equivalent internally!

## EXAMPLE 5.4

**Compute the current through the  $4.7 \text{ k}\Omega$  resistor in Fig. 5.17a after transforming the  $9 \text{ mA}$  source into an equivalent voltage source.**

It's not just the  $9 \text{ mA}$  source at issue, but also the resistance in parallel with it ( $5 \text{ k}\Omega$ ). We remove these components, leaving two terminals "dangling." We then replace them with a voltage source in series with a  $5 \text{ k}\Omega$  resistor. The value of the voltage source must be  $(0.09)(5000) = 45 \text{ V}$ .

Redrawing the circuit as in Fig. 5.17b, we can write a simple KVL equation

$$-45 + 5000I + 4700I + 3000I + 3 = 0$$

which is easily solved to yield  $I = 3.307 \text{ mA}$ .

We can check our answer of course by analyzing the circuit of Fig. 5.17a using either nodal or mesh techniques.

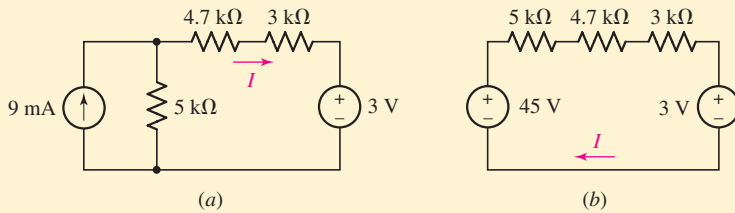

■ FIGURE 5.17 (a) A circuit with both a voltage source and a current source. (b) The circuit after the 9 mA source is transformed into an equivalent voltage source.

## PRACTICE

5.3 For the circuit of Fig. 5.18, compute the current  $I_X$  through the 47 kΩ resistor after performing a source transformation on the voltage source.

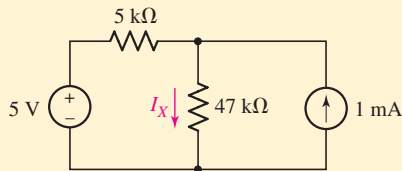

■ FIGURE 5.18

Ans: 192  $\mu$ A.

## EXAMPLE 5.5

Calculate the current through the 2  $\Omega$  resistor in Fig. 5.19a by making use of source transformations to first simplify the circuit.

We begin by transforming each current source into a voltage source (Fig. 5.19b), the strategy being to convert the circuit into a simple loop.

We must be careful to retain the 2  $\Omega$  resistor for two reasons: first, the dependent source controlling variable appears across it, and second, we desire the current flowing through it. However, we can combine the 17  $\Omega$  and 9  $\Omega$  resistors, since they appear in series. We also see that the 3  $\Omega$  and 4  $\Omega$  resistors may be combined into a single 7  $\Omega$  resistor, which can then be used to transform the 15 V source into a 15/7 A source as in Fig. 5.19c.

Finally, we note that the two 7  $\Omega$  resistors can be combined into a single 3.5  $\Omega$  resistor, which may be used to transform the 15/7 A current source into a 7.5 V voltage source. The result is a simple loop circuit, shown in Fig. 5.19d.

The current  $I$  can now be found using KVL:

$$-7.5 + 3.5I - 51V_x + 28I + 9 = 0$$

where

$$V_x = 2I$$

Thus,

$$I = 21.28 \text{ mA}$$

(Continued on next page)

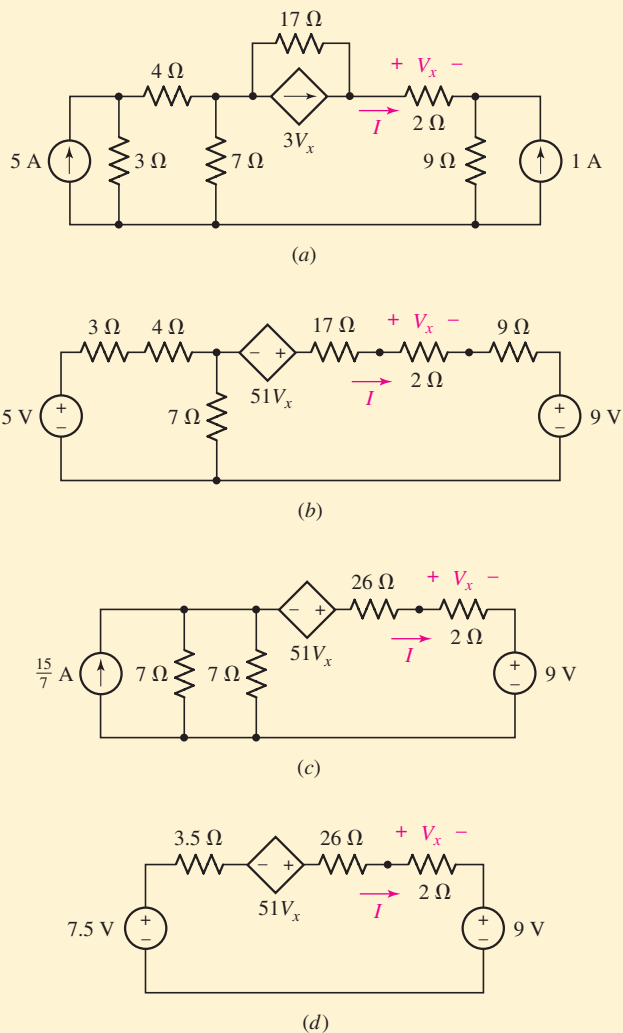

■ FIGURE 5.19 (a) A circuit with two independent current sources and one dependent source. (b) The circuit after each source is transformed into a voltage source. (c) The circuit after further combinations. (d) The final circuit.

## PRACTICE

5.4 For the circuit of Fig. 5.20, compute the voltage  $V$  across the 1 MΩ resistor using repeated source transformations.

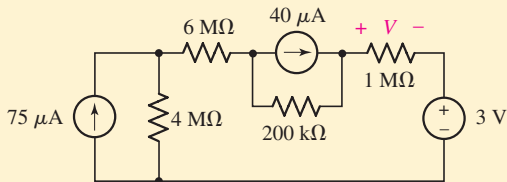

■ FIGURE 5.20

Ans: 27.2 V.

## Several Key Points

We conclude our discussion of practical sources and source transformations with a few observations. First, when we transform a voltage source, we must be sure that the source is in fact *in series* with the resistor under consideration. For example, in the circuit of Fig. 5.21, it is perfectly valid to perform a source transformation on the voltage source using the  $10\ \Omega$  resistor, as they are in series. However, it would be incorrect to attempt a source transformation using the  $60\ \text{V}$  source and the  $30\ \Omega$  resistor—a very common type of error.



In a similar fashion, when we transform a current source and resistor combination, we must be sure that they are in fact *in parallel*. Consider the current source shown in Fig. 5.22a. We may perform a source transformation including the  $3\ \Omega$  resistor, as they are in parallel, but after the transformation there may be some ambiguity as to where to place the resistor. In such circumstances, it is helpful to first redraw the components to be transformed as in Fig. 5.22b. Then the transformation to a voltage source in series with a resistor may be drawn correctly as shown in Fig. 5.22c; the resistor may in fact be drawn above or below the voltage source.



It is also worthwhile to consider the unusual case of a current source in series with a resistor, and its dual, the case of a voltage source in parallel

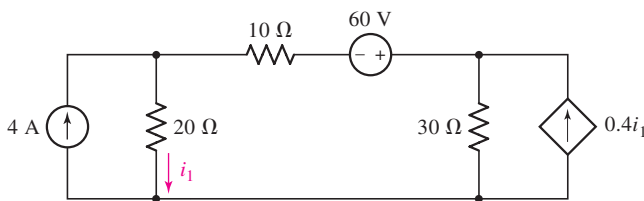

■ FIGURE 5.21 An example circuit to illustrate how to determine if a source transformation can be performed.

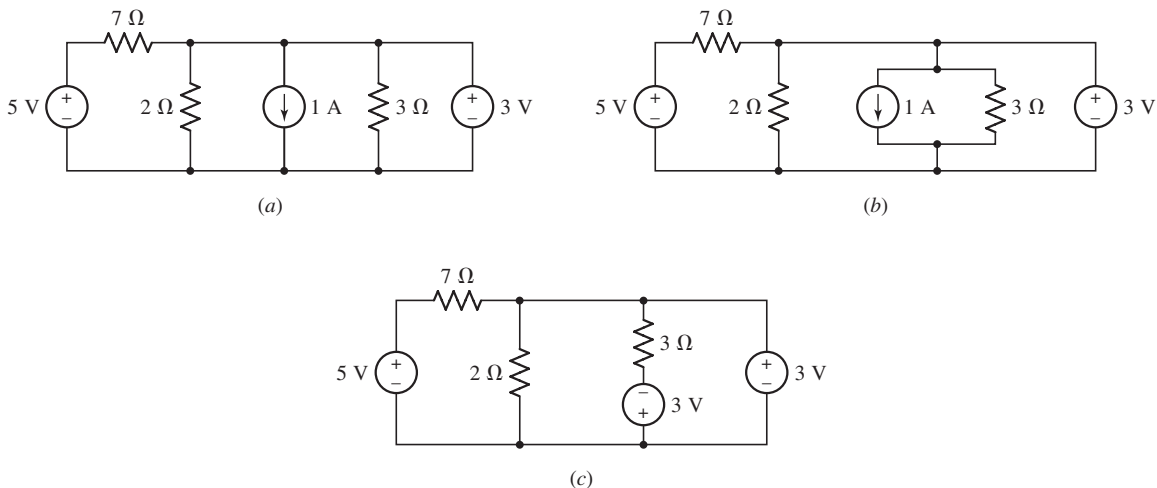

■ FIGURE 5.22 (a) A circuit with a current source to be transformed to a voltage source. (b) Circuit redrawn so as to avoid errors. (c) Transformed source/resistor combination.



with a resistor. Let's start with the simple circuit of Fig. 5.23a, where we are interested only in the voltage across the resistor marked  $R_2$ . We note that regardless of the value of resistor  $R_1$ ,  $V_{R_2} = I_x R_2$ . Although we might be tempted to perform an inappropriate source transformation on such a circuit, in fact *we may simply omit resistor  $R_1$*  (provided that it is of no interest to us itself). A similar situation arises with a voltage source in parallel with a resistor, as depicted in Fig. 5.23b. Again, if we are only interested in some quantity regarding resistor  $R_2$ , we may find ourselves tempted to perform some strange (and incorrect) source transformation on the voltage source and resistor  $R_1$ . In reality, we may omit resistor  $R_1$  from our circuit as far as resistor  $R_2$  is concerned—its presence does not alter the voltage across, the current through, or the power dissipated by resistor  $R_2$ .

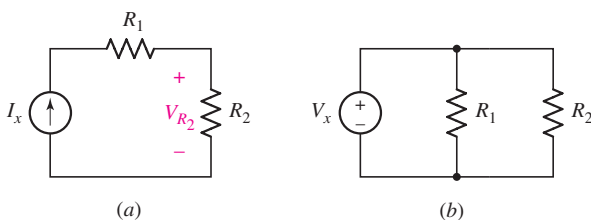

■ FIGURE 5.23 (a) Circuit with a resistor  $R_1$  in series with a current source. (b) A voltage source in parallel with two resistors.

### Summary of Source Transformation

1. **A common goal in source transformation is to end up with either all current sources or all voltage sources in the circuit.** This is especially true if it makes nodal or mesh analysis easier.
2. **Repeated source transformations can be used to simplify a circuit by allowing resistors and sources to eventually be combined.**
3. **The resistor value does not change during a source transformation, but it is not the same resistor.** This means that currents or voltages associated with the original resistor are irretrievably lost when we perform a source transformation.
4. **If the voltage or current associated with a particular resistor is used as a controlling variable for a dependent source, it should not be included in any source transformation.** The original resistor must be retained in the final circuit, untouched.
5. **If the voltage or current associated with a particular element is of interest, that element should not be included in any source transformation.** The original element must be retained in the final circuit, untouched.
6. **In a source transformation, the head of the current source arrow corresponds to the “+” terminal of the voltage source.**
7. **A source transformation on a current source and resistor requires that the two elements be in parallel.**
8. **A source transformation on a voltage source and resistor requires that the two elements be in series.**

### 5.3 THÉVENIN AND NORTON EQUIVALENT CIRCUITS

Now that we have been introduced to source transformations and the superposition principle, it is possible to develop two more techniques that will greatly simplify the analysis of many linear circuits. The first of these theorems is named after L. C. Thévenin, a French engineer working in telegraphy who published the theorem in 1883; the second may be considered a corollary of the first and is credited to E. L. Norton, a scientist with the Bell Telephone Laboratories.

Let us suppose that we need to make only a partial analysis of a circuit. For example, perhaps we need to determine the current, voltage, and power delivered to a single “load” resistor by the remainder of the circuit, which may consist of a sizable number of sources and resistors (Fig. 5.24a). Or, perhaps we wish to find the response for different values of the load resistance. Thévenin’s theorem tells us that it is possible to replace everything except the load resistor with an independent voltage source in series with a resistor (Fig. 5.24b); the response measured *at the load resistor* will be unchanged. Using Norton’s theorem, we obtain an equivalent composed of an independent current source in parallel with a resistor (Fig. 5.24c).

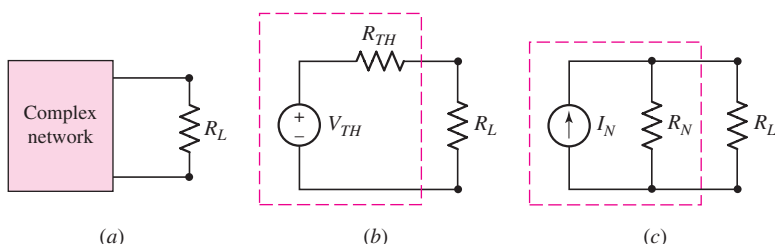

■ FIGURE 5.24 (a) A complex network including a load resistor  $R_L$ . (b) A Thévenin equivalent network connected to the load resistor  $R_L$ . (c) A Norton equivalent network connected to the load resistor  $R_L$ .

Thus, one of the main uses of Thévenin’s and Norton’s theorems is the replacement of a large part of a circuit, often a complicated and uninteresting part, with a very simple equivalent. The new, simpler circuit enables us to make rapid calculations of the voltage, current, and power which the original circuit is able to deliver to a load. It also helps us to choose the best value of this load resistance. In a transistor power amplifier, for example, the Thévenin or Norton equivalent enables us to determine the maximum power that can be taken from the amplifier and delivered to the speakers.

#### EXAMPLE 5.6

Consider the circuit shown in Fig. 5.25a. Determine the Thévenin equivalent of network A, and compute the power delivered to the load resistor  $R_L$ .

The dashed regions separate the circuit into networks A and B; our main interest is in network B, which consists only of the load resistor  $R_L$ . Network A may be simplified by making repeated source transformations.

(Continued on next page)

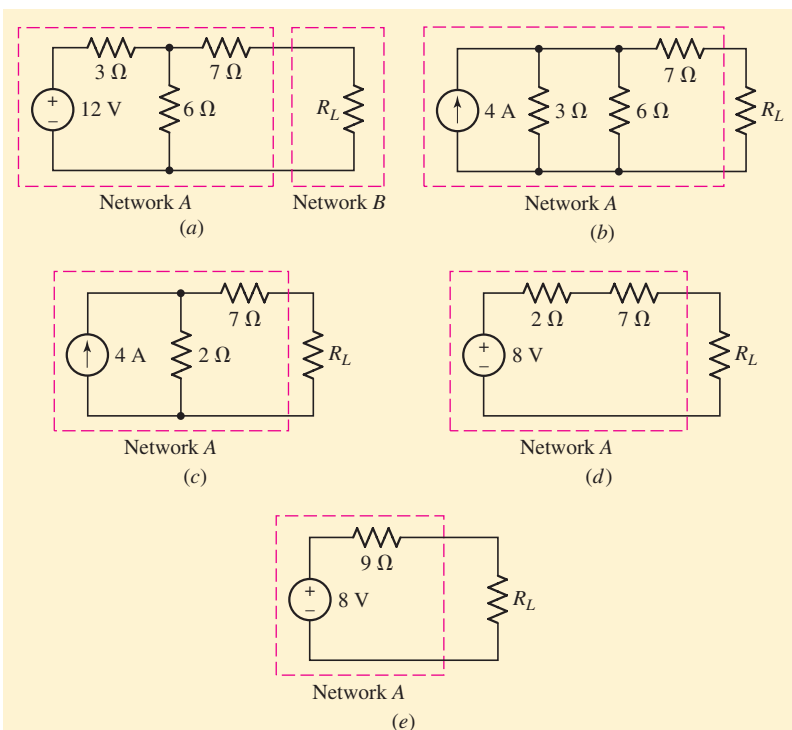

■ FIGURE 5.25 (a) A circuit separated into two networks. (b)–(d) Intermediate steps to simplifying network A. (e) The Thévenin equivalent circuit.

We first treat the 12 V source and the 3 Ω resistor as a practical voltage source and replace it with a practical current source consisting of a 4 A source in parallel with 3 Ω (Fig. 5.25b). The parallel resistances are then combined into 2 Ω (Fig. 5.25c), and the practical current source that results is transformed back into a practical voltage source (Fig. 5.25d). The final result is shown in Fig. 5.25e.

From the viewpoint of the load resistor  $R_L$ , this network A (the Thévenin equivalent) is equivalent to the original network A; from our viewpoint, the circuit is much simpler, and we can now easily compute the power delivered to the load:

$$P_L = \left( \frac{8}{9 + R_L} \right)^2 R_L$$

Furthermore, we can see from the equivalent circuit that the maximum voltage that can be obtained across  $R_L$  is 8 V and corresponds to  $R_L = \infty$ . A quick transformation of network A to a practical current source (the Norton equivalent) indicates that the maximum current that may be delivered to the load is 8/9 A, which occurs when  $R_L = 0$ . Neither of these facts is readily apparent from the original circuit.

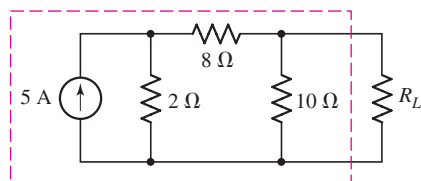

■ FIGURE 5.26

## PRACTICE

5.5 Using repeated source transformations, determine the Norton equivalent of the highlighted network in the circuit of Fig. 5.26.

Ans: 1 A, 5 Ω.



## Thévenin's Theorem

Using the technique of source transformation to find a Thévenin or Norton equivalent network worked well enough in Example 5.6, but it can rapidly become impractical in situations where dependent sources are present or the circuit is composed of a large number of elements. An alternative is to employ Thévenin's theorem (or Norton's theorem) instead. We will state the theorem<sup>3</sup> as a somewhat formal procedure and then consider various ways to make the approach more practical depending on the situation we face.

### A Statement of Thévenin's Theorem

1. **Given any linear circuit, rearrange it in the form of two networks,  $A$  and  $B$ , connected by two wires.** Network  $A$  is the network to be simplified;  $B$  will be left untouched.
2. **Disconnect network  $B$ .** Define a voltage  $v_{oc}$  as the voltage now appearing across the terminals of network  $A$ .
3. **Turn off or "zero out" every independent source in network  $A$  to form an inactive network.** Leave dependent sources unchanged.
4. **Connect an independent voltage source with value  $v_{oc}$  in series with the inactive network.** Do not complete the circuit; leave the two terminals disconnected.
5. **Connect network  $B$  to the terminals of the new network  $A$ .** All currents and voltages in  $B$  will remain unchanged.

Note that if either network contains a dependent source, *its control variable must be in the same network*.

Let us see if we can apply Thévenin's theorem successfully to the circuit we considered in Fig. 5.25. We have already found the Thévenin equivalent of the circuit to the left of  $R_L$  in Example 5.6, but we want to see if there is an easier way to obtain the same result.



### EXAMPLE 5.7

#### Use Thévenin's theorem to determine the Thévenin equivalent for that part of the circuit in Fig. 5.25a to the left of $R_L$ .

We begin by disconnecting  $R_L$ , and note that no current flows through the  $7\ \Omega$  resistor in the resulting partial circuit shown in Fig. 5.27a. Thus,  $V_{oc}$  appears across the  $6\ \Omega$  resistor (with no current through the  $7\ \Omega$  resistor there is no voltage drop across it), and voltage division enables us to determine that

$$V_{oc} = 12 \left( \frac{6}{3+6} \right) = 8\ \text{V}$$

(3) A proof of Thévenin's theorem in the form in which we have stated it is rather lengthy, and therefore it has been placed in Appendix 3, where the curious may peruse it.

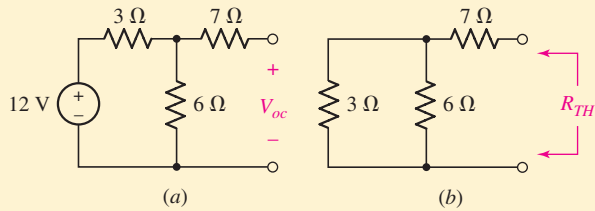

■ FIGURE 5.27 (a) The circuit of Fig. 5.25a with network  $B$  (the resistor  $R_L$ ) disconnected and the voltage across the connecting terminals labeled as  $V_{oc}$ . (b) The independent source in Fig. 5.25a has been killed, and we look into the terminals where network  $B$  was connected to determine the effective resistance of network  $A$ .

Turning off network  $A$  (i.e., replacing the 12 V source with a short circuit) and looking back into the dead network, we see a 7  $\Omega$  resistor connected in series with the parallel combination of 6  $\Omega$  and 3  $\Omega$  (Fig. 5.27b).

Thus, the inactive network can be represented here by a 9  $\Omega$  resistor, referred to as the **Thévenin equivalent resistance** of network  $A$ . The Thévenin equivalent then is  $V_{oc}$  in series with a 9  $\Omega$  resistor, which agrees with our previous result.

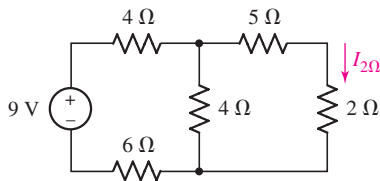

■ FIGURE 5.28

## PRACTICE

5.6 Use Thévenin's theorem to find the current through the 2  $\Omega$  resistor in the circuit of Fig. 5.28. (*Hint*: Designate the 2  $\Omega$  resistor as network  $B$ .)

Ans:  $V_{TH} = 2.571$  V,  $R_{TH} = 7.857$   $\Omega$ ,  $I_{2\Omega} = 260.8$  mA.

## A Few Key Points

The equivalent circuit we have learned how to obtain is completely independent of network  $B$ : we have been instructed to first remove network  $B$  and then measure the open-circuit voltage produced by network  $A$ , an operation that certainly does not depend on network  $B$  in any way. The  $B$  network is mentioned only to indicate that an equivalent for  $A$  may be obtained no matter what arrangement of elements is connected to the  $A$  network; the  $B$  network represents this general network.

There are several points about the theorem which deserve emphasis.

- The only restriction that we must impose on  $A$  or  $B$  is that all *dependent* sources in  $A$  have their control variables in  $A$ , and similarly for  $B$ .
- No restrictions are imposed on the complexity of  $A$  or  $B$ ; either one may contain any combination of independent voltage or current sources, linear dependent voltage or current sources, resistors, or any other circuit elements which are linear.
- The dead network  $A$  can be represented by a single equivalent resistance  $R_{TH}$ , which we will call the Thévenin equivalent resistance.

This holds true whether or not dependent sources exist in the inactive  $A$  network, an idea we will explore shortly.

- A Thévenin equivalent consists of two components: a voltage source in series with a resistance. Either may be zero, although this is not usually the case.

## Norton's Theorem

Norton's theorem bears a close resemblance to Thévenin's theorem and may be stated as follows:

### A Statement of Norton's Theorem

1. **Given any linear circuit, rearrange it in the form of two networks,  $A$  and  $B$ , connected by two wires.** Network  $A$  is the network to be simplified;  $B$  will be left untouched. As before, if either network contains a dependent source, *its controlling variable must be in the same network*.
2. **Disconnect network  $B$ , and short the terminals of  $A$ .** Define a current  $i_{sc}$  as the current now flowing through the shorted terminals of network  $A$ .
3. **Turn off or “zero out” every independent source in network  $A$  to form an inactive network.** Leave dependent sources unchanged.
4. **Connect an independent current source with value  $i_{sc}$  in parallel with the inactive network.** Do not complete the circuit; leave the two terminals disconnected.
5. **Connect network  $B$  to the terminals of the new network  $A$ .** All currents and voltages in  $B$  will remain unchanged.

The Norton equivalent of a linear network is the Norton current source  $i_{sc}$  in parallel with the Thévenin resistance  $R_{TH}$ . Thus, we see that in fact it is possible to obtain the Norton equivalent of a network by performing a source transformation on the Thévenin equivalent. This results in a direct relationship between  $v_{oc}$ ,  $i_{sc}$ , and  $R_{TH}$ :

$$v_{oc} = R_{TH}i_{sc} \quad [18]$$

In circuits containing dependent sources, we will often find it more convenient to determine either the Thévenin or Norton equivalent by finding both the open-circuit voltage and the short-circuit current and then determining the value of  $R_{TH}$  as their quotient. It is therefore advisable to become adept at finding both open-circuit voltages and short-circuit currents, even in the simple problems that follow. If the Thévenin and Norton equivalents are determined independently, Eq. [18] can serve as a useful check.

Let's consider three different examples of the determination of a Thévenin or Norton equivalent circuit.



## EXAMPLE 5.8

Find the Thévenin and Norton equivalent circuits for the network faced by the 1 k $\Omega$  resistor in Fig. 5.29a.

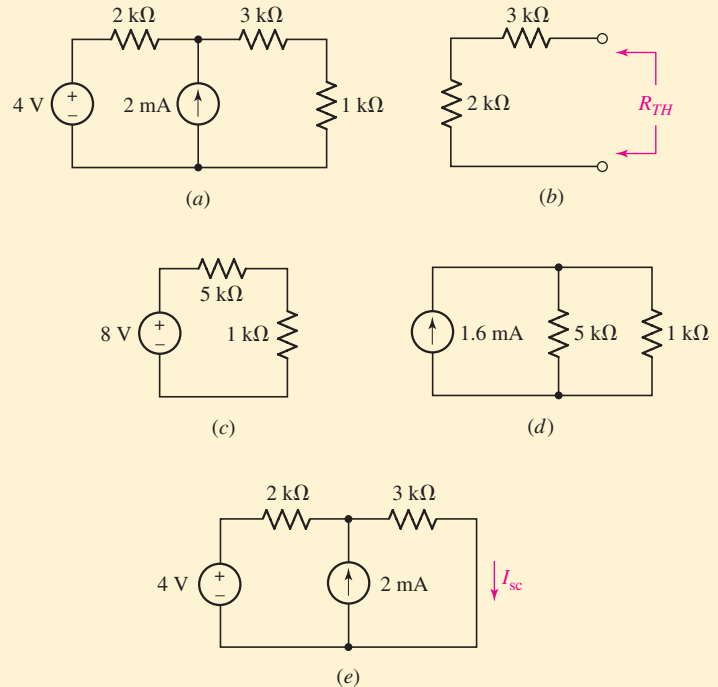

FIGURE 5.29 (a) A given circuit in which the 1 k $\Omega$  resistor is identified as network  $B$ . (b) Network  $A$  with all independent sources killed. (c) The Thévenin equivalent is shown for network  $A$ . (d) The Norton equivalent is shown for network  $A$ . (e) Circuit for determining  $I_{sc}$ .

From the wording of the problem statement, network  $B$  is the 1 k $\Omega$  resistor, so network  $A$  is everything else.

Choosing to find the Thévenin equivalent of network  $A$  first, we apply superposition, noting that no current flows through the 3 k $\Omega$  resistor once network  $B$  is disconnected. With the current source set to zero,  $V_{oc|_{4V}} = 4$  V. With the voltage source set to zero,

$$V_{oc|_{2mA}} = (0.002)(2000) = 4 \text{ V. Thus, } V_{oc} = 4 + 4 = 8 \text{ V.}$$

To find  $R_{TH}$ , set both sources to zero as in Fig. 5.29b. By inspection,  $R_{TH} = 2 \text{ k}\Omega + 3 \text{ k}\Omega = 5 \text{ k}\Omega$ . The complete Thévenin equivalent, with network  $B$  reconnected, is shown in Fig. 5.29c.

The Norton equivalent is found by a simple source transformation of the Thévenin equivalent, resulting in a current source of  $8/5000 = 1.6$  mA in parallel with a 5 k $\Omega$  resistor (Fig. 5.29d).

**Check:** Find the Norton equivalent directly from Fig. 5.29a. Removing the 1 k $\Omega$  resistor and shorting the terminals of network  $A$ , we

find  $I_{sc}$  as shown in Fig. 5.29e by superposition and current division:

$$\begin{aligned} I_{sc} &= I_{sc|4V} + I_{sc|2mA} = \frac{4}{2+3} + (2)\frac{2}{2+3} \\ &= 0.8 + 0.8 = 1.6 \text{ mA} \end{aligned}$$

which completes the check.

## PRACTICE

5.7 Determine the Thévenin and Norton equivalents of the circuit of Fig. 5.30.

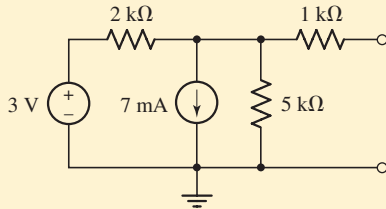

FIGURE 5.30

Ans:  $-7.857 \text{ V}$ ,  $-3.235 \text{ mA}$ ,  $2.429 \text{ k}\Omega$ .

## When Dependent Sources Are Present

Technically speaking, there does not always have to be a “network  $B$ ” for us to invoke either Thévenin’s theorem or Norton’s theorem; we could instead be asked to find the equivalent of a network with two terminals not yet connected to another network. If there *is* a network  $B$  that we do not want to involve in the simplification procedure, however, we must use a little caution if it contains dependent sources. In such situations, the controlling variable and the associated element(s) must be included in network  $B$  and excluded from network  $A$ . Otherwise, there will be no way to analyze the final circuit because the controlling quantity will be lost.

If network  $A$  contains a dependent source, then again we must ensure that the controlling variable and its associated element(s) cannot be in network  $B$ . Up to now, we have only considered circuits with resistors and independent sources. Although technically speaking it is correct to leave a dependent source in the “inactive” network when creating a Thévenin or Norton equivalent, in practice this does not result in any kind of simplification. What we really want is an independent voltage source in series with a single resistor, or an independent current source in parallel with a single resistor—in other words, a two-component equivalent. In the following examples, we consider various means of reducing networks with dependent sources and resistors into a single resistance.



## EXAMPLE 5.9

Determine the Thévenin equivalent of the circuit in Fig. 5.31a.

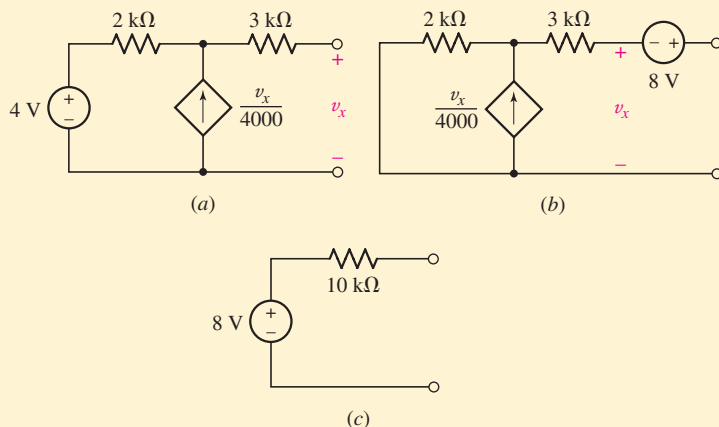

■ FIGURE 5.31 (a) A given network whose Thévenin equivalent is desired. (b) A possible, but rather useless, form of the Thévenin equivalent. (c) The best form of the Thévenin equivalent for this linear resistive network.

To find  $V_{oc}$  we note that  $v_x = V_{oc}$  and that the dependent source current must pass through the  $2\text{ k}\Omega$  resistor, since no current can flow through the  $3\text{ k}\Omega$  resistor. Using KVL around the outer loop:

$$-4 + 2 \times 10^3 \left( -\frac{v_x}{4000} \right) + 3 \times 10^3 (0) + v_x = 0$$

and

$$v_x = 8\text{ V} = V_{oc}$$

By Thévenin's theorem, then, the equivalent circuit could be formed with the inactive  $A$  network in series with an  $8\text{ V}$  source, as shown in Fig. 5.31b. This is correct, but not very simple and not very helpful; in the case of linear resistive networks, we really want a simpler equivalent for the inactive  $A$  network, namely,  $R_{TH}$ .

The dependent source prevents us from determining  $R_{TH}$  directly for the inactive network through resistance combination; we therefore seek  $I_{sc}$ . Upon short-circuiting the output terminals in Fig. 5.31a, it is apparent that  $V_x = 0$  and the dependent current source is not active. Hence,  $I_{sc} = 4/(5 \times 10^3) = 0.8\text{ mA}$ . Thus,

$$R_{TH} = \frac{V_{oc}}{I_{sc}} = \frac{8}{0.8 \times 10^{-3}} = 10\text{ k}\Omega$$

and the acceptable Thévenin equivalent of Fig. 5.31c is obtained.

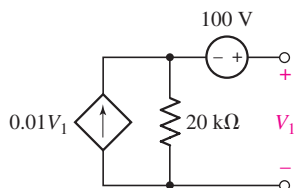

■ FIGURE 5.32

## PRACTICE

5.8 Find the Thévenin equivalent for the network of Fig. 5.32. (*Hint*: a quick source transformation on the dependent source might help.)

Ans:  $-502.5\text{ mV}$ ,  $-100.5\ \Omega$ .

Note: a negative resistance might seem strange—and it is! Such a thing is physically possible only if, for example, we do a bit of clever electronic circuit design to create something that behaves like the dependent current source we represented in Fig. 5.32.

As another example, let us consider a network having a dependent source but no independent source.

## EXAMPLE 5.10

Find the Thévenin equivalent of the circuit shown in Fig. 5.33a.

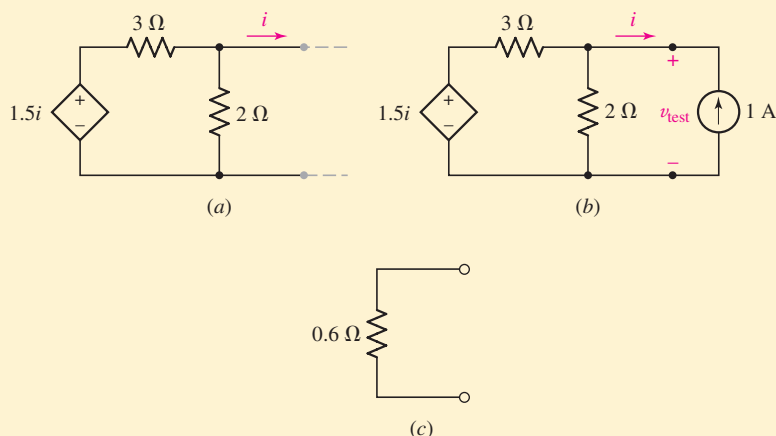

■ FIGURE 5.33 (a) A network with no independent sources. (b) A hypothetical measurement to obtain  $R_{TH}$ . (c) The Thévenin equivalent to the original circuit.

The rightmost terminals are already open-circuited, hence  $i = 0$ . Consequently, the dependent source is inactive, so  $v_{oc} = 0$ .

We next seek the value of  $R_{TH}$  represented by this two-terminal network. However, we cannot find  $v_{oc}$  and  $i_{sc}$  and take their quotient, for there is no independent source in the network and both  $v_{oc}$  and  $i_{sc}$  are zero. Let us, therefore, be a little tricky.

We apply a  $1\ \text{A}$  source externally, measure the voltage  $v_{\text{test}}$  that results, and then set  $R_{TH} = v_{\text{test}}/1$ . Referring to Fig. 5.33b, we see that  $i = -1\ \text{A}$ . Applying nodal analysis,

$$\frac{v_{\text{test}} - 1.5(-1)}{3} + \frac{v_{\text{test}}}{2} = 1$$

so that

$$v_{\text{test}} = 0.6\ \text{V}$$

and thus

$$R_{TH} = 0.6\ \Omega$$

The Thévenin equivalent is shown in Fig. 5.33c.

## A Quick Recap of Procedures

We have now looked at three examples in which we determined a Thévenin or Norton equivalent circuit. The first example (Fig. 5.29) contained only independent sources and resistors, and several different methods could have been applied to it. One would involve calculating  $R_{TH}$  for the inactive network and then  $V_{oc}$  for the live network. We could also have found  $R_{TH}$  and  $I_{sc}$ , or  $V_{oc}$  and  $I_{sc}$ .

# PRACTICAL APPLICATION

## The Digital Multimeter

One of the most common pieces of electrical test equipment is the DMM, or digital multimeter (Fig. 5.34), which is designed to measure voltage, current, and resistance values.



■ FIGURE 5.34 A handheld digital multimeter.

In a voltage measurement, two leads from the DMM are connected across the appropriate circuit element, as depicted in Fig. 5.35. The positive reference terminal of the meter is typically marked “V/Ω,” and the negative reference terminal—often referred to as the *common terminal*—is typically designated by “COM.” The convention is to use a red lead for the positive reference terminal and a black lead for the common terminal.

From our discussion of Thévenin and Norton equivalents, it may now be apparent that the DMM has its own

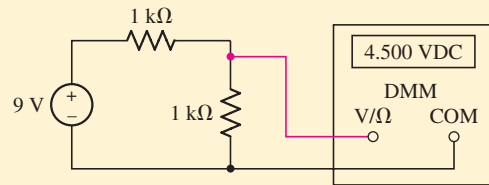

■ FIGURE 5.35 A DMM connected to measure voltage.

Thévenin equivalent resistance. This Thévenin equivalent resistance will appear in parallel with our circuit, and its value can affect the measurement (Fig. 5.36). The DMM does not supply power to the circuit to measure voltage, so its Thévenin equivalent consists of only a resistance, which we will name  $R_{DMM}$ .

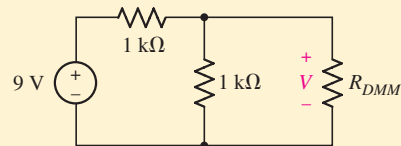

■ FIGURE 5.36 DMM in Fig. 5.35 shown as its Thévenin equivalent resistance,  $R_{DMM}$ .

The input resistance of a good DMM is typically  $10\text{ M}\Omega$  or more. The measured voltage  $V$  thus appears across  $1\text{ k}\Omega \parallel 10\text{ M}\Omega = 999.9\ \Omega$ . Using voltage division, we find that  $V = 4.4998$  volts, slightly less than the expected value of 4.5 volts. Thus, the finite input resistance of the voltmeter introduces a small error in the measured value.

In the second example (Fig. 5.31), both independent and dependent sources were present, and the method we used required us to find  $V_{oc}$  and  $I_{sc}$ . We could not easily find  $R_{TH}$  for the inactive network because the dependent source could not be made inactive.

The last example did not contain any independent sources, and therefore the Thévenin and Norton equivalents do not contain an independent source. We found  $R_{TH}$  by applying 1 A and finding  $v_{test} = 1 \times R_{TH}$ . We could also apply 1 V and determine  $i = 1/R_{TH}$ . These two related techniques can be applied to any circuit with dependent sources, *as long as all independent sources are set to zero first*.

Two other methods have a certain appeal because they can be used for any of the three types of networks considered. In the first, simply replace network  $B$  with a voltage source  $v_s$ , define the current leaving its positive terminal as  $i$ , analyze network  $A$  to obtain  $i$ , and put the equation in the form  $v_s = ai + b$ . Then,  $a = R_{TH}$  and  $b = v_{oc}$ .





To measure current, the DMM must be placed in series with a circuit element, generally requiring that we cut a wire (Fig. 5.37). One DMM lead is connected to the common terminal of the meter, and the other lead is placed in a connector usually marked “A” to signify current measurement. Again, the DMM does not supply power to the circuit in this type of measurement.

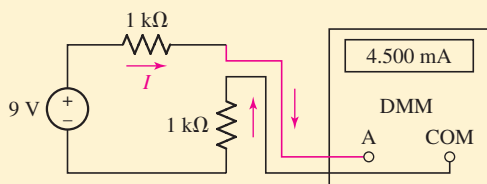

■ FIGURE 5.37 A DMM connected to measure current.

We see that the Thévenin equivalent resistance ( $R_{DMM}$ ) of the DMM is in series with our circuit, so its value can affect the measurement. Writing a simple KVL equation around the loop,

$$-9 + 1000I + R_{DMM}I + 1000I = 0$$

Note that since we have reconfigured the meter to perform a current measurement, the Thévenin equivalent resistance is not the same as when the meter is configured to measure voltages. In fact, we would ideally like  $R_{DMM}$  to be  $0 \Omega$  for current measurements, and  $\infty$  for voltage measurements. If  $R_{DMM}$  is now  $0.1 \Omega$ , we see that the measured current  $I$  is  $4.4998 \text{ mA}$ , which is only slightly different from the expected value of  $4.5 \text{ mA}$ . Depending on the number of digits that can be displayed by

the meter, we may not even notice the effect of nonzero DMM resistance on our measurement.

The same meter can be used to determine resistance, provided no independent sources are active during the measurement. Internally, a known current is passed through the resistor being measured, and the voltmeter circuitry is used to measure the resulting voltage. Replacing the DMM with its Norton equivalent (which now includes an active independent current source to generate the predetermined current), we see that  $R_{DMM}$  appears in parallel with our unknown resistor  $R$  (Fig. 5.38).

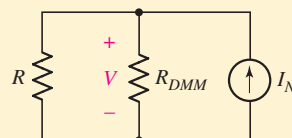

■ FIGURE 5.38 DMM in resistance measurement configuration replaced by its Norton equivalent, showing  $R_{DMM}$  in parallel with the unknown resistor  $R$  to be measured.

As a result, the DMM actually measures  $R \parallel R_{DMM}$ . If  $R_{DMM} = 10 \text{ M}\Omega$  and  $R = 10 \Omega$ ,  $R_{\text{measured}} = 9.99999 \Omega$ , which is more than accurate enough for most purposes. However, if  $R = 10 \text{ M}\Omega$ ,  $R_{\text{measured}} = 5 \text{ M}\Omega$ . The input resistance of a DMM therefore places a practical upper limit on the values of resistance that can be measured, and special techniques must be used to measure larger resistances. We should note that if a digital multimeter is *programmed* with knowledge of  $R_{DMM}$ , it is possible to compensate and allow measurement of larger resistances.

We could also apply a current source  $i_s$ , let its voltage be  $v$ , and then determine  $i_s = cv - d$ , where  $c = 1/R_{TH}$  and  $d = i_{sc}$  (the minus sign arises from assuming both current source arrows are directed into the same node). Both of these last two procedures are universally applicable, but some other method can usually be found that is easier and more rapid.

Although we are devoting our attention almost entirely to the analysis of linear circuits, it is good to know that Thévenin’s and Norton’s theorems are both valid if network  $B$  is nonlinear; only network  $A$  must be linear.

## PRACTICE

5.9 Find the Thévenin equivalent for the network of Fig. 5.39. (*Hint:* Try a  $1 \text{ V}$  test source.)

Ans:  $I_{\text{test}} = 50 \text{ mA}$  so  $R_{TH} = 20 \Omega$ .

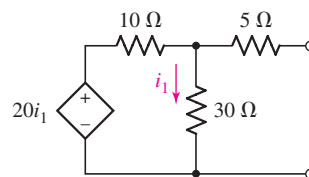

■ FIGURE 5.39 See Practice Problem 5.9.

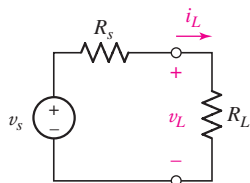

■ FIGURE 5.40 A practical voltage source connected to a load resistor  $R_L$ .

## 5.4 MAXIMUM POWER TRANSFER

A very useful power theorem may be developed with reference to a practical voltage or current source. For the practical voltage source (Fig. 5.40), the power delivered to the load  $R_L$  is

$$p_L = i_L^2 R_L = \frac{v_s^2 R_L}{(R_s + R_L)^2} \quad [19]$$

To find the value of  $R_L$  that absorbs maximum power from the given practical source, we differentiate with respect to  $R_L$ :

$$\frac{dp_L}{dR_L} = \frac{(R_s + R_L)^2 v_s^2 - v_s^2 R_L (2)(R_s + R_L)}{(R_s + R_L)^4}$$

and equate the derivative to zero, obtaining

$$2R_L(R_s + R_L) = (R_s + R_L)^2$$

or

$$R_s = R_L$$

Since the values  $R_L = 0$  and  $R_L = \infty$  both give a minimum ( $p_L = 0$ ), and since we have already developed the equivalence between practical voltage and current sources, we have therefore proved the following **maximum power transfer theorem**:

An independent voltage source in series with a resistance  $R_s$ , or an independent current source in parallel with a resistance  $R_s$ , delivers maximum power to a load resistance  $R_L$  such that  $R_L = R_s$ .

An alternative way to view the maximum power theorem is possible in terms of the Thévenin equivalent resistance of a network:

A network delivers maximum power to a load resistance  $R_L$  when  $R_L$  is equal to a the Thévenin equivalent resistance of the network.

Thus, the maximum power transfer theorem tells us that a  $2\ \Omega$  resistor draws the greatest power (4.5 W) from either practical source of Fig. 5.16, whereas a resistance of  $0.01\ \Omega$  receives the maximum power (3.6 kW) in Fig. 5.11.



There is a distinct difference between *drawing* maximum power from a *source* and *delivering* maximum power to a *load*. If the load is sized such that its Thévenin resistance is equal to the Thévenin resistance of the network to which it is connected, it will receive maximum power from that network. *Any change to the load resistance will reduce the power delivered to the load*. However, consider just the Thévenin equivalent of the network itself. We draw the maximum possible power from the voltage source by drawing the maximum possible current—which is achieved by shorting the network terminals! However, in this extreme example *we deliver zero power* to the “load”—a short circuit in this case—as  $p = i^2 R$ , and we just set  $R = 0$  by shorting the network terminals.

A minor amount of algebra applied to Eq. [19] coupled with the maximum power transfer requirement that  $R_L = R_s = R_{TH}$  will provide

$$P_{\max} |_{\text{delivered to load}} = \frac{v_s^2}{4R_s} = \frac{v_{TH}^2}{4R_{TH}}$$

where  $v_{TH}$  and  $R_{TH}$  recognize that the practical voltage source of Fig. 5.40 can also be viewed as a Thévenin equivalent of some specific source.

It is also not uncommon for the maximum power theorem to be misinterpreted. It is designed to help us select an optimum load in order to maximize power absorption. If the load resistance is already specified, however, the maximum power theorem is of no assistance. If for some reason we can affect the size of the Thévenin equivalent resistance of the network connected to our load, setting it equal to the load does not guarantee maximum power transfer to our predetermined load. A quick consideration of the power lost in the Thévenin resistance will clarify this point.



### EXAMPLE 5.11

The circuit shown in Fig. 5.41 is a model for the common-emitter bipolar junction transistor amplifier. Choose a load resistance so that maximum power is transferred to it from the amplifier, and calculate the actual power absorbed.

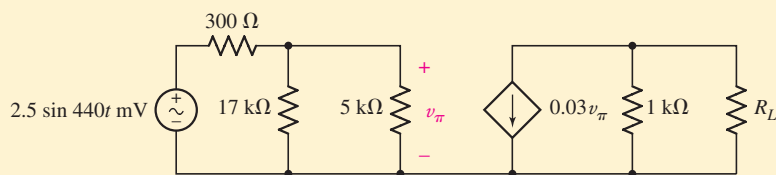

FIGURE 5.41 A small-signal model of the common-emitter amplifier, with the load resistance unspecified.

Since it is the load resistance we are asked to determine, the maximum power theorem applies. The first step is to find the Thévenin equivalent of the rest of the circuit.

We first determine the Thévenin equivalent resistance, which requires that we remove  $R_L$  and short-circuit the independent source as in Fig. 5.42a.

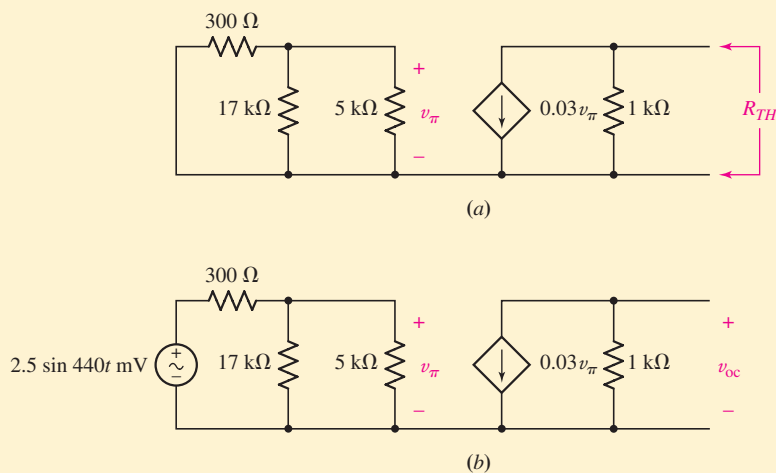

FIGURE 5.42 (a) Circuit with  $R_L$  removed and independent source short-circuited. (b) Circuit for determining  $v_{TH}$ .

(Continued on next page)

Since  $v_\pi = 0$ , the dependent current source is an open circuit, and  $R_{TH} = 1 \text{ k}\Omega$ . This can be verified by connecting an independent 1 A current source across the  $1 \text{ k}\Omega$  resistor;  $v_\pi$  will still be zero, so the dependent source remains inactive and hence contributes nothing to  $R_{TH}$ .

In order to obtain maximum power delivered into the load,  $R_L$  should be set to  $R_{TH} = 1 \text{ k}\Omega$ .

To find  $v_{TH}$  we consider the circuit shown in Fig. 5.42b, which is Fig. 5.41 with  $R_L$  removed. We may write

$$v_{oc} = -0.03v_\pi(1000) = -30v_\pi$$

where the voltage  $v_\pi$  may be found from simple voltage division:

$$v_\pi = (2.5 \times 10^{-3} \sin 440t) \left( \frac{3864}{300 + 3864} \right)$$

so that our Thévenin equivalent is a voltage  $-69.6 \sin 440t \text{ mV}$  in series with  $1 \text{ k}\Omega$ .

The maximum power is given by

$$p_{\max} = \frac{v_{TH}^2}{4R_{TH}} = \boxed{1.211 \sin^2 440t \text{ }\mu\text{W}}$$

## PRACTICE

5.10 Consider the circuit of Fig. 5.43.

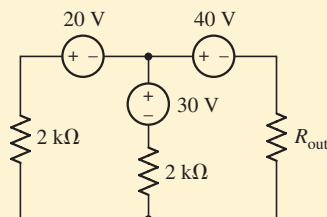

FIGURE 5.43

- If  $R_{out} = 3 \text{ k}\Omega$ , find the power delivered to it.
- What is the maximum power that can be delivered to any  $R_{out}$ ?
- What two different values of  $R_{out}$  will have exactly 20 mW delivered to them?

Ans: 230 mW; 306 mW; 59.2 kΩ and 16.88 Ω.

## 5.5 DELTA-WYE CONVERSION

We saw previously that identifying parallel and series combinations of resistors can often lead to a significant reduction in the complexity of a circuit. In situations where such combinations do not exist, we can often make use of source transformations to enable such simplifications. There is another useful technique, called  $\Delta$ - $Y$  (*delta-wye*) conversion, that arises out of network theory.

Consider the circuits in Fig. 5.44. There are no series or parallel combinations that can be made to further simplify any of the circuits (note that 5.44a and 5.44b are identical, as are 5.44c and 5.44d), and without any

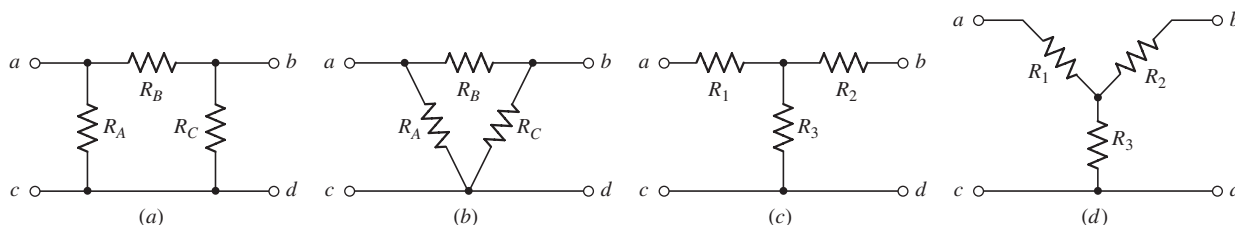

■ FIGURE 5.44 (a)  $\Pi$  network consisting of three resistors and three unique connections. (b) Same network drawn as a  $\Delta$  network. (c) A T network consisting of three resistors. (d) Same network drawn as a Y network.

sources present, no source transformations can be performed. However, it is possible to convert between these two types of networks.

We first define two voltages  $v_{ac}$  and  $v_{bc}$ , and three currents  $i_1$ ,  $i_2$ , and  $i_3$  as depicted in Fig. 5.45. If the two networks are equivalent, then the terminal voltages and currents must be equal (there is no current  $i_2$  in the T-connected network). A set of relationships between  $R_A$ ,  $R_B$ ,  $R_C$  and  $R_1$ ,  $R_2$ , and  $R_3$  can now be defined simply by performing mesh analysis. For example, for the network of Fig. 5.45a we may write

$$R_A i_1 - R_A i_2 = v_{ac} \quad [20]$$

$$-R_A i_1 + (R_A + R_B + R_C) i_2 - R_C i_3 = 0 \quad [21]$$

$$-R_C i_2 + R_C i_3 = -v_{bc} \quad [22]$$

and for the network of Fig. 5.45b we have

$$(R_1 + R_3) i_1 - R_3 i_3 = v_{ac} \quad [23]$$

$$-R_3 i_1 + (R_2 + R_3) i_3 = -v_{bc} \quad [24]$$

We next remove  $i_2$  from Eqs. [20] and [22] using Eq. [21], resulting in

$$\left( R_A - \frac{R_A^2}{R_A + R_B + R_C} \right) i_1 - \frac{R_A R_C}{R_A + R_B + R_C} i_3 = v_{ac} \quad [25]$$

and

$$-\frac{R_A R_C}{R_A + R_B + R_C} i_1 + \left( R_C - \frac{R_C^2}{R_A + R_B + R_C} \right) i_3 = -v_{bc} \quad [26]$$

Comparing terms between Eq. [25] and Eq. [23], we see that

$$R_3 = \frac{R_A R_C}{R_A + R_B + R_C}$$

In a similar fashion, we may find expressions for  $R_1$  and  $R_2$  in terms of  $R_A$ ,  $R_B$ , and  $R_C$ , as well as expressions for  $R_A$ ,  $R_B$ , and  $R_C$  in terms of  $R_1$ ,  $R_2$ , and  $R_3$ ; we leave the remainder of the derivations as an exercise for the reader. Thus, to convert from a Y network to a  $\Delta$  network, the new resistor values are calculated using

$$\begin{aligned} R_A &= \frac{R_1 R_2 + R_2 R_3 + R_3 R_1}{R_2} \\ R_B &= \frac{R_1 R_2 + R_2 R_3 + R_3 R_1}{R_3} \\ R_C &= \frac{R_1 R_2 + R_2 R_3 + R_3 R_1}{R_1} \end{aligned}$$

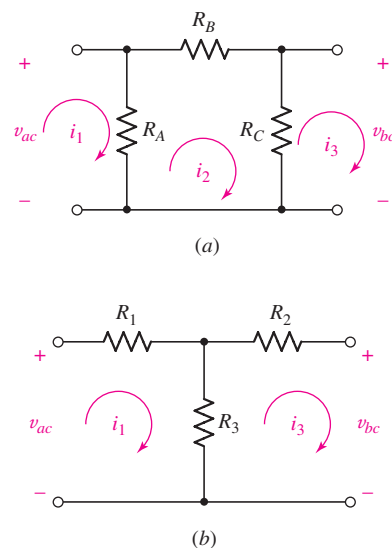

■ FIGURE 5.45 (a) Labeled  $\Pi$  network; (b) labeled T network.

and to convert from a  $\Delta$  network to a Y network,

$$R_1 = \frac{R_A R_B}{R_A + R_B + R_C}$$

$$R_2 = \frac{R_B R_C}{R_A + R_B + R_C}$$

$$R_3 = \frac{R_C R_A}{R_A + R_B + R_C}$$

Application of these equations is straightforward, although identifying the actual networks sometimes requires a little concentration.

### EXAMPLE 5.12

**Use the technique of  $\Delta$ -Y conversion to find the Thévenin equivalent resistance of the circuit in Fig. 5.46a.**

We see that the network in Fig. 5.46a is composed of two  $\Delta$ -connected networks that share the  $3\ \Omega$  resistor. We must be careful at this point not to be too eager, attempting to convert both  $\Delta$ -connected networks to two Y-connected networks. The reason for this may be more obvious after we convert the top network consisting of the  $1\ \Omega$ ,  $4\ \Omega$ , and  $3\ \Omega$  resistors into a Y-connected network (Fig. 5.46b).

Note that in converting the upper network to a Y-connected network, we have removed the  $3\ \Omega$  resistor. As a result, there is no way to convert the original  $\Delta$ -connected network consisting of the  $2\ \Omega$ ,  $5\ \Omega$ , and  $3\ \Omega$  resistors into a Y-connected network.

We proceed by combining the  $\frac{3}{8}\ \Omega$  and  $2\ \Omega$  resistors and the  $\frac{3}{2}\ \Omega$  and  $5\ \Omega$  resistors (Fig. 5.46c). We now have a  $\frac{19}{8}\ \Omega$  resistor in parallel with a  $\frac{13}{2}\ \Omega$  resistor, and this parallel combination is in series with the  $\frac{1}{2}\ \Omega$  resistor. Thus, we can replace the original network of Fig. 5.46a with a single  $\frac{159}{71}\ \Omega$  resistor (Fig. 5.46d).

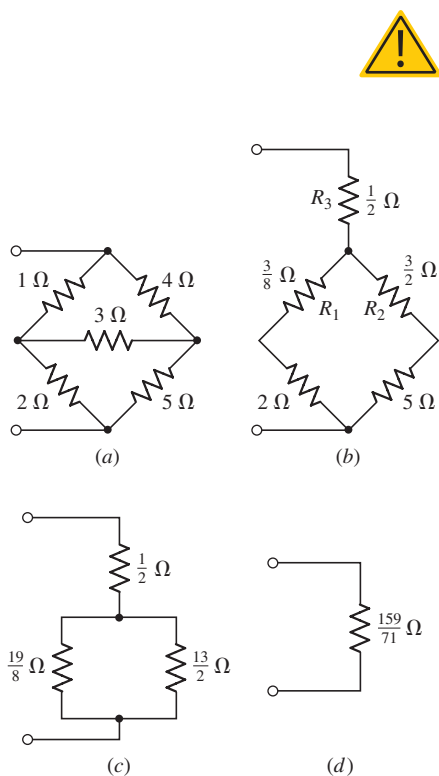

■ FIGURE 5.46 (a) A given resistive network whose input resistance is desired. (b) The upper  $\Delta$  network is replaced by an equivalent Y network. (c, d) Series and parallel combinations result in a single resistance value.

### PRACTICE

5.11 Use the technique of Y- $\Delta$  conversion to find the Thévenin equivalent resistance of the circuit of Fig. 5.47.

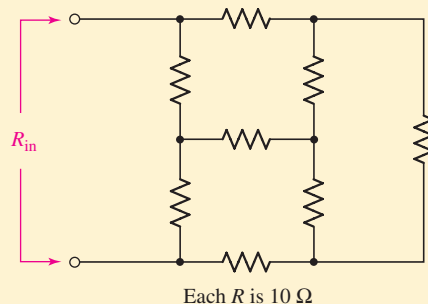

■ FIGURE 5.47

Ans:  $11.43\ \Omega$ .

## 5.6 SELECTING AN APPROACH: A SUMMARY OF VARIOUS TECHNIQUES

In Chap. 3, we were introduced to Kirchhoff's current law (KCL) and Kirchhoff's voltage law (KVL). These two laws apply to any circuit we will ever encounter, provided that we take care to consider the entire system that the circuits represent. The reason for this is that KCL and KVL enforce charge and energy conservation, respectively, which are fundamental principles. Based on KCL, we developed the very powerful method of nodal analysis. A similar technique based on KVL (unfortunately only applicable to planar circuits) is known as mesh analysis and is also a useful circuit analysis approach.

For the most part, this text is concerned with developing analytical skills that apply to *linear* circuits. If we know a circuit is constructed of only linear components (in other words, all voltages and currents are related by linear functions), then we can often simplify circuits prior to employing either mesh or nodal analysis. Perhaps the most important result that comes from the knowledge that we are dealing with a completely linear system is that the principle of superposition applies: given a number of independent sources acting on our circuit, we can add the contribution of each source independently of the other sources. This technique is extremely pervasive throughout the field of engineering, and we will encounter it often. In many real situations, we will find that although several "sources" are acting simultaneously on our "system," typically one of them dominates the system response. Superposition allows us to quickly identify that source, provided that we have a reasonably accurate linear model of the system.

However, from a circuit analysis standpoint, unless we are asked to find which independent source contributes the most to a particular response, we find that rolling up our sleeves and launching straight into either nodal or mesh analysis is often a more straightforward tactic. The reason for this is that applying superposition to a circuit with 12 independent sources will require us to redraw the original circuit 12 times, and often we will have to apply nodal or mesh analysis to each partial circuit, anyway.

The technique of source transformations, on the other hand, is often a very useful tool in circuit analysis. Performing source transformations can allow us to consolidate resistors or sources that are not in series or parallel in the original circuit. Source transformations may also allow us to convert all or at least most of the sources in the original circuit to the same type (either all voltage sources or all current sources), so nodal or mesh analysis is more straightforward.

Thévenin's theorem is extremely important for a number of reasons. In working with electronic circuits, we are always aware of the Thévenin equivalent resistance of different parts of our circuit, especially the input and output resistances of amplifier stages. The reason for this is that matching of resistances is frequently the best route to optimizing the performance of a given circuit. We have seen a small preview of this in our discussion of maximum power transfer, where the load resistance should be chosen to match the Thévenin equivalent resistance of the network to which the load is connected. In terms of day-to-day circuit analysis, however, we find that converting part of a circuit to its Thévenin or Norton equivalent is almost as much work as analyzing the complete circuit. Therefore, as in the case of

superposition, Thévenin's and Norton's theorems are typically applied only when we require specialized information about part of our circuit.

## SUMMARY AND REVIEW

Although we asserted in Chap. 4 that nodal analysis and mesh analysis are sufficient to analyze any circuit we might encounter (provided we have the means to relate voltage and current for any passive element, such as Ohm's law for resistors), the simple truth is that often we do not really need *all* voltages, or *all* currents. Sometimes, it is simply *one* element, or a *small portion* of a larger circuit, that has our attention. Perhaps there is some uncertainty in the final value of a particular element, and we'd like to see how the circuit performs over the range of expected values. In such instances, we can exploit the fact that at the moment we have confined ourselves to *linear* circuits. This allows the development of other tools: *superposition*, where individual contributions of sources can be identified; *source transformations*, where a voltage source in series with a resistor can be replaced with a current source in parallel with a resistor; and the most powerful of all—*Thévenin* (and *Norton*) *equivalents*.

An interesting offshoot of these topics is the idea of *maximum power transfer*. Assuming we can represent our (arbitrarily complex) circuit by two networks, one passive and one active, maximum power transfer to the passive network is achieved when its Thévenin resistance is equal to the Thévenin resistance of the active network. Finally, we introduced the concept of delta-wye conversion, a process that allows us to simplify some resistive networks which at face value are not reducible using standard series-parallel combination techniques.

We are still faced with the perpetual question, “*Which tool should I use to analyze this circuit?*” The answer typically lies in the type of information required about our circuit. Experience will eventually guide us a bit, but it is not always true that there is one “best” approach. Certainly one issue to focus on is whether one or more components might be changed—this can suggest whether superposition, a Thévenin equivalent, or a partial simplification such as can be achieved with source or delta-wye transformation is the most practical route.

We conclude this chapter by reviewing key points, along with identifying relevant example(s).

- The principle of superposition states that the *response* in a linear circuit can be obtained by adding the individual responses caused by the separate *independent* sources *acting alone*. (Examples 5.1, 5.2, 5.3)
- Superposition is most often used when it is necessary to determine the individual contribution of each source to a particular response. (Examples 5.2, 5.3)
- A practical model for a real voltage source is a resistor in series with an independent voltage source. A practical model for a real current source is a resistor in parallel with an independent current source.
- Source transformations allow us to convert a practical voltage source into a practical current source, and vice versa. (Example 5.4)



- Repeated source transformations can greatly simplify analysis of a circuit by providing the means to combine resistors and sources. (Example 5.5)
- The Thévenin equivalent of a network is a resistor in series with an independent voltage source. The Norton equivalent is the same resistor in parallel with an independent current source. (Example 5.6)
- There are several ways to obtain the Thévenin equivalent resistance, depending on whether or not dependent sources are present in the network. (Examples 5.7, 5.8, 5.9, 5.10)
- Maximum power transfer occurs when the load resistor matches the Thévenin equivalent resistance of the network to which it is connected. (Example 5.11)
- When faced with a  $\Delta$ -connected resistor network, it is straightforward to convert it to a Y-connected network. This can be useful in simplifying the network prior to analysis. Conversely, a Y-connected resistor network can be converted to a  $\Delta$ -connected network to assist in simplification of the network. (Example 5.12)

## READING FURTHER

A book about battery technology, including characteristics of built-in resistance:

D. Linden, *Handbook of Batteries*, 2nd ed. New York: McGraw-Hill, 1995.

An excellent discussion of pathological cases and various circuit analysis theorems can be found in:

R. A. DeCarlo and P. M. Lin, *Linear Circuit Analysis*, 2nd ed. New York: Oxford University Press, 2001.

## EXERCISES

### 5.1 Linearity and Superposition

1. Linear systems are so easy to work with that engineers often construct linear models of real (nonlinear) systems to assist in analysis and design. Such models are often surprisingly accurate over a limited range. For example, consider the simple exponential function  $e^x$ . The Taylor series representation of this function is

$$e^x \approx 1 + x + \frac{x^2}{2} + \frac{x^3}{6} + \dots$$

- (a) Construct a linear model for this function by truncating the Taylor series expansion after the linear term. (b) Evaluate your model function at  $x = 0.000001, 0.0001, 0.01, 0.1$ , and  $1.0$ . (c) For which values of  $x$  does your model yield a “reasonable” approximation to  $e^x$ ? *Explain your reasoning.*
2. Construct a linear approximation to the function  $y(t) = 4 \sin 2t$ . (a) Evaluate your approximation at  $t = 0, 0.001, 0.01, 0.1$ , and  $1.0$ . (b) For which values of  $t$  does your model provide a “reasonable” approximation to the actual (nonlinear) function  $y(t)$ ? *Explain your reasoning.*
3. Considering the circuit of Fig. 5.48, employ superposition to determine the two components of  $i_8$  arising from the action of the two independent sources, respectively.

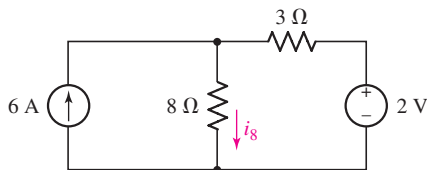

■ FIGURE 5.48

4. (a) Employ superposition to determine the current labeled  $i$  in the circuit of Fig. 5.49. (b) Express the contribution the 1 V source makes to the total current  $i$  in terms of a percentage. (c) Changing only the value of the 10 A source, adjust the circuit of Fig. 5.49 so that the two sources contribute equally to the current  $i$ .

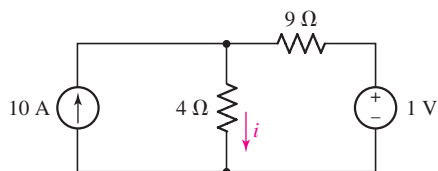

■ FIGURE 5.49

5. (a) Employ superposition to obtain the individual contributions each of the two sources in Fig. 5.50 makes to the current labeled  $i_x$ . (b) Adjusting only the value of the rightmost current source, alter the circuit so that the two sources contribute equally to  $i_x$ .

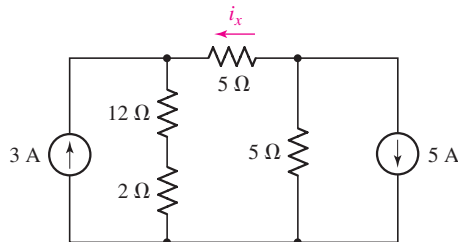

■ FIGURE 5.50

6. (a) Determine the individual contributions of each of the two current sources in the circuit of Fig. 5.51 to the nodal voltage  $v_1$ . (b) Determine the percentage contribution of each of the two sources to the power dissipated by the 2 Ω resistor.

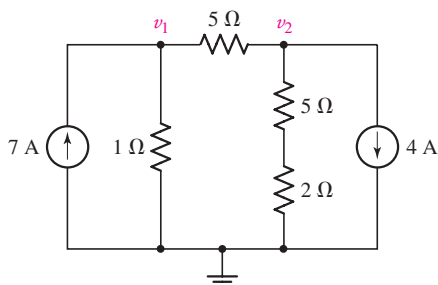

■ FIGURE 5.51

7. (a) Determine the individual contributions of each of the two current sources shown in Fig. 5.52 to the nodal voltage labeled  $v_2$ . (b) Instead of performing two separate PSpice simulations, verify your answer by using a single dc sweep. Submit a labeled schematic, relevant Probe output, and a short description of the results.

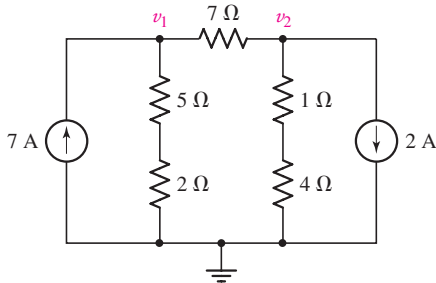

■ FIGURE 5.52

8. After studying the circuit of Fig. 5.53, change both voltage source values such that (a)  $i_1$  doubles; (b) the direction of  $i_1$  reverses, but its magnitude is unchanged; (c) both sources contribute equally to the power dissipated by the 6 Ω resistor.

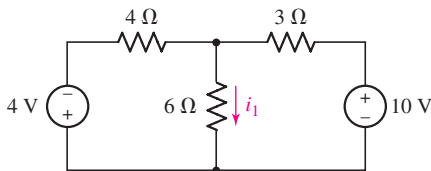

■ FIGURE 5.53

9. Consider the three circuits shown in Fig. 5.54. Analyze each circuit, and demonstrate that  $V_x = V'_x + V''_x$  (i.e., superposition is most useful when sources are set to zero, but the principle is in fact much more general than that).

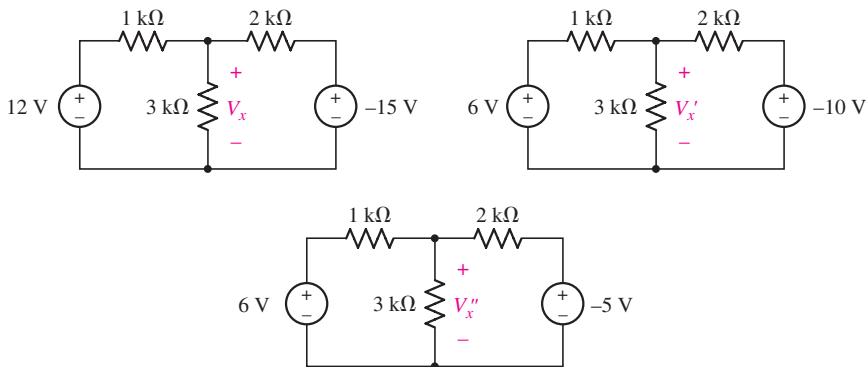

■ FIGURE 5.54

10. (a) Using superposition, determine the voltage labeled  $v_x$  in the circuit represented in Fig. 5.55. (b) To what value should the 2 A source be changed to reduce  $v_x$  by 10%? (c) Verify your answers by performing three dc sweeps in PSpice (one for each source). Submit a labeled schematic, relevant Probe output, and a short description of the results.

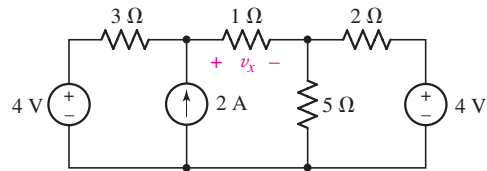

■ FIGURE 5.55

11. Employ superposition principles to obtain a value for the current  $I_x$  as labeled in Fig. 5.56.

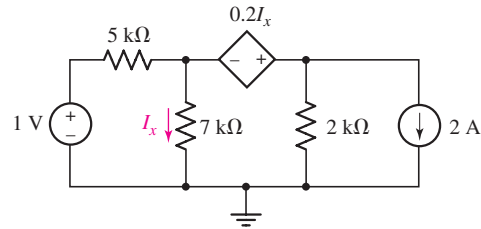

■ FIGURE 5.56

12. (a) Employ superposition to determine the individual contribution from each independent source to the voltage  $v$  as labeled in the circuit shown in Fig. 5.57.  
 (b) Compute the power absorbed by the  $2\ \Omega$  resistor.

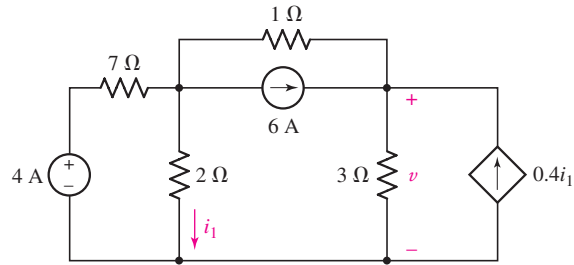

■ FIGURE 5.57

## 5.2 Source Transformations

13. Perform an appropriate source transformation on each of the circuits depicted in Fig. 5.58, taking care to retain the  $4\ \Omega$  resistor in each final circuit.

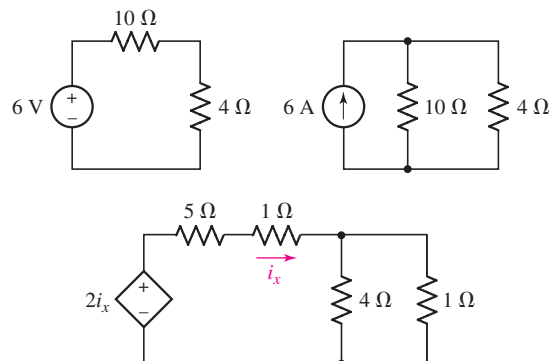

■ FIGURE 5.58

14. For the circuit of Fig. 5.59, plot  $i_L$  versus  $v_L$  corresponding to the range of  $0 \leq R \leq \infty$ .
15. Determine the current labeled  $I$  in the circuit of Fig. 5.60 by first performing source transformations and parallel-series combinations as required to reduce the circuit to only two elements.

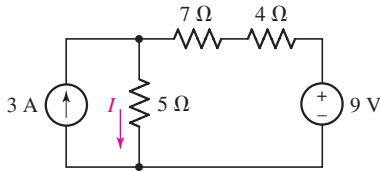

■ FIGURE 5.60

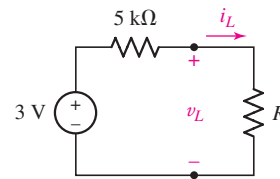

■ FIGURE 5.59

16. Verify that the power absorbed by the  $7 \Omega$  resistor in Fig. 5.22a remains the same after the source transformation illustrated in Fig. 5.22c.
17. (a) Determine the current labeled  $i$  in the circuit of Fig. 5.61 after first transforming the circuit such that it contains only resistors and voltage sources. (b) Simulate each circuit to verify the same current flows in both cases.

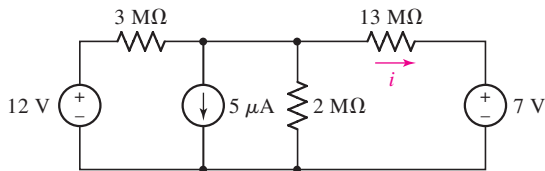

■ FIGURE 5.61

18. (a) Using repeated source transformations, reduce the circuit of Fig. 5.62 to a voltage source in series with a resistor, both of which are in series with the  $6 \text{ M}\Omega$  resistor. (b) Calculate the power dissipated by the  $6 \text{ M}\Omega$  resistor using your simplified circuit.

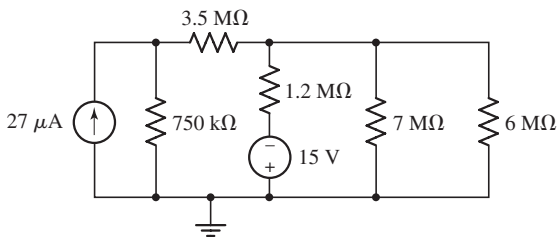

■ FIGURE 5.62

19. (a) Using as many source transformations and element combination techniques as required, simplify the circuit of Fig. 5.63 so that it contains only the  $7 \text{ V}$  source, a single resistor, and one other voltage source. (b) Verify that the  $7 \text{ V}$  source delivers the same amount of power in both circuits.

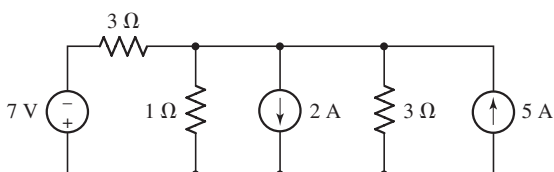

■ FIGURE 5.63



20. (a) Making use of repeated source transformations, reduce the circuit of Fig. 5.64 such that it contains a single voltage source, the  $17\ \Omega$  resistor, and one other resistor. (b) Calculate the power dissipated by the  $17\ \Omega$  resistor. (c) Verify your results by simulating both circuits with PSpice or another suitable CAD tool.

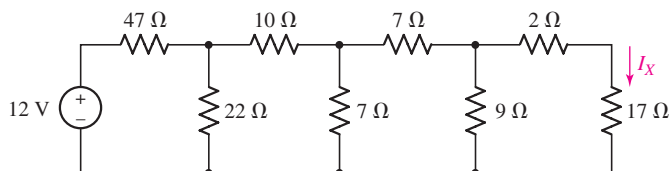

■ FIGURE 5.64

21. Make use of source transformations to first convert all three sources in Fig. 5.65 to voltage sources, then simplify the circuit as much as possible and calculate the voltage  $V_x$  which appears across the  $4\ \Omega$  resistor. Be sure to draw and label your simplified circuit.

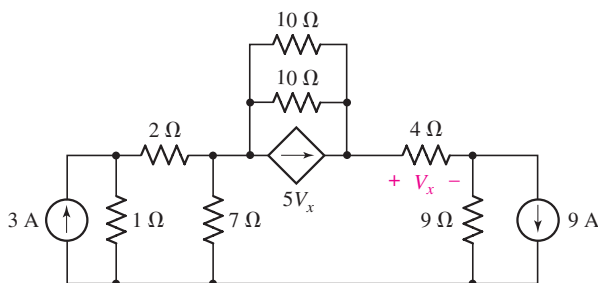

■ FIGURE 5.65



22. (a) With the assistance of source transformations, alter the circuit of Fig. 5.66 such that it contains only current sources. (b) Simplify your new circuit as much as possible, and calculate the power dissipated in the  $7\ \Omega$  resistor. (c) Verify your solution by simulating both circuits with PSpice or another appropriate CAD tool.

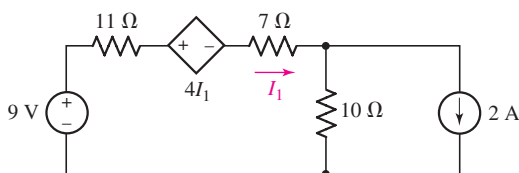

■ FIGURE 5.66

23. Transform the dependent source in Fig. 5.67 to a voltage source, then calculate  $V_0$ .

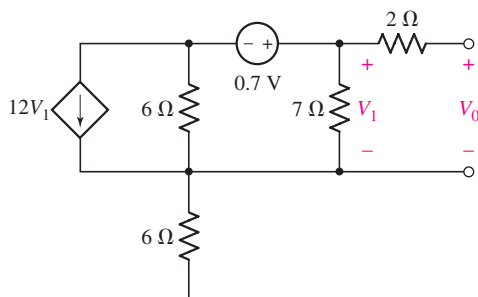

■ FIGURE 5.67

24. With regard to the circuit represented in Fig. 5.68, first transform both voltage sources to current sources, reduce the number of elements as much as possible, and determine the voltage  $v_3$ .

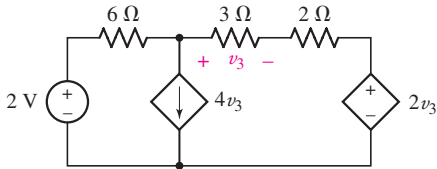

■ FIGURE 5.68

### 5.3 Thévenin and Norton Equivalent Circuits

25. Referring to Fig. 5.69, determine the Thévenin equivalent of the network connected to  $R_L$ . (b) Determine  $v_L$  for  $R_L = 1\ \Omega$ ,  $3.5\ \Omega$ ,  $6.257\ \Omega$ , and  $9.8\ \Omega$ .
26. (a) With respect to the circuit depicted in Fig. 5.69, obtain the Norton equivalent of the network connected to  $R_L$ . (b) Plot the power dissipated in resistor  $R_L$  as a function of  $i_L$  corresponding to the range of  $0 < R_L < 5\ \Omega$ . (c) Using your graph, estimate at what value of  $R_L$  does the dissipated power reach its maximum value.
27. (a) Obtain the Norton equivalent of the network connected to  $R_L$  in Fig. 5.70. (b) Obtain the Thévenin equivalent of the same network. (c) Use either to calculate  $i_L$  for  $R_L = 0\ \Omega$ ,  $1\ \Omega$ ,  $4.923\ \Omega$ , and  $8.107\ \Omega$ .
28. (a) Determine the Thévenin equivalent of the circuit depicted in Fig. 5.71 by first finding  $V_{oc}$  and  $I_{sc}$  (defined as flowing into the positive reference terminal of  $V_{oc}$ ). (b) Connect a  $4.7\ \text{k}\Omega$  resistor to the open terminals of your new network and calculate the power it dissipates.
29. Referring to the circuit of Fig. 5.71: (a) Determine the Norton equivalent of the circuit by first finding  $V_{oc}$  and  $I_{sc}$  (defined as flowing into the positive reference terminal of  $V_{oc}$ ). (b) Connect a  $1.7\ \text{k}\Omega$  resistor to the open terminals of your new network and calculate the power supplied to that resistor.
30. (a) Employ Thévenin's theorem to obtain a simple two-component equivalent of the circuit shown in Fig. 5.72. (b) Use your equivalent circuit to determine the power delivered to a  $100\ \Omega$  resistor connected to the open terminals. (c) Verify your solution by analyzing the original circuit with the same  $100\ \Omega$  resistor connected across the open terminals.

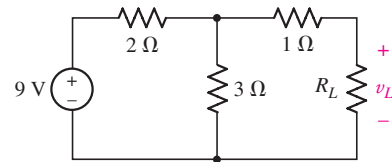

■ FIGURE 5.69

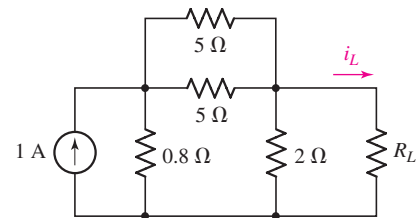

■ FIGURE 5.70

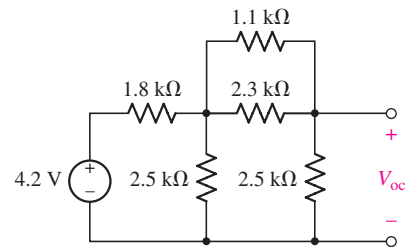

■ FIGURE 5.71

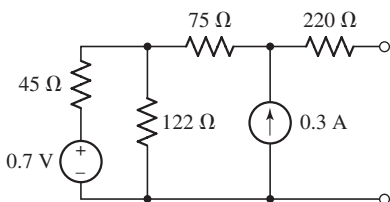

■ FIGURE 5.72

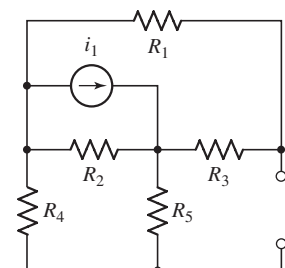

■ FIGURE 5.73



31. (a) Employ Thévenin's theorem to obtain a two-component equivalent for the network shown in Fig. 5.73. (b) Determine the power supplied to a  $1\ \text{M}\Omega$  resistor connected to the network if  $i_1 = 19\ \mu\text{A}$ ,  $R_1 = R_2 = 1.6\ \text{M}\Omega$ ,  $R_2 = 3\ \text{M}\Omega$ , and  $R_4 = R_5 = 1.2\ \text{M}\Omega$ . (c) Verify your solution by simulating both circuits with PSpice or another appropriate CAD tool.

32. Determine the Thévenin equivalent of the network shown in Fig. 5.74 as seen looking into the two open terminals.

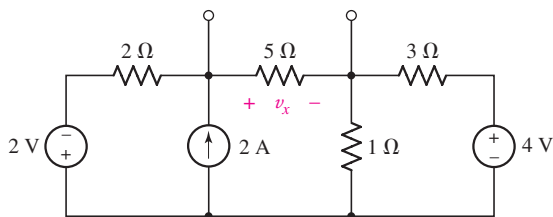

■ FIGURE 5.74

33. (a) Determine the Norton equivalent of the circuit depicted in Fig. 5.74 as seen looking into the two open terminals. (b) Compute power dissipated in a 5 Ω resistor connected in parallel with the existing 5 Ω resistor. (c) Compute the current flowing through a short circuit connecting the two terminals.



34. For the circuit of Fig. 5.75: (a) Employ Norton's theorem to reduce the network connected to  $R_L$  to only two components. (b) Calculate the downward-directed current flowing through  $R_L$  if it is a 3.3 kΩ resistor. (c) Verify your answer by simulating both circuits with PSpice or a comparable CAD tool.

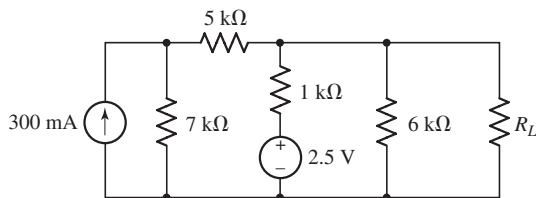

■ FIGURE 5.75

35. (a) Obtain a value for the Thévenin equivalent resistance seen looking into the open terminals of the circuit in Fig. 5.76 by first finding  $V_{oc}$  and  $I_{sc}$ . (b) Connect a 1 A test source to the open terminals of the original circuit after shorting the voltage source, and use this to obtain  $R_{TH}$ . (c) Connect a 1 V test source to the open terminals of the original circuit after again zeroing the 2 V source, and use this now to obtain  $R_{TH}$ .

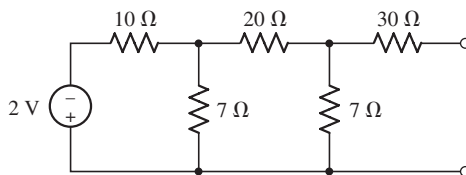

■ FIGURE 5.76

36. Refer to the circuit depicted in Fig. 5.77. (a) Obtain a value for the Thévenin equivalent resistance seen looking into the open terminals by first finding  $V_{oc}$  and  $I_{sc}$ . (b) Connect a 1 A test source to the open terminals of the original

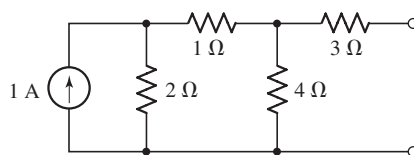

■ FIGURE 5.77



circuit after deactivating the other current source, and use this to obtain  $R_{TH}$ .  
 (c) Connect a 1 V test source to the open terminals of the original circuit, once again zeroing out the original source, and use this now to obtain  $R_{TH}$ .

37. Obtain a value for the Thévenin equivalent resistance seen looking into the open terminals of the circuit in Fig. 5.78 by (a) finding  $V_{oc}$  and  $I_{sc}$ , and then taking their ratio; (b) setting all independent sources to zero and using resistor combination techniques; (c) connecting an unknown current source to the terminals, deactivating (zero out) all other sources, finding an algebraic expression for the voltage that develops across the source, and taking the ratio of the two quantities.

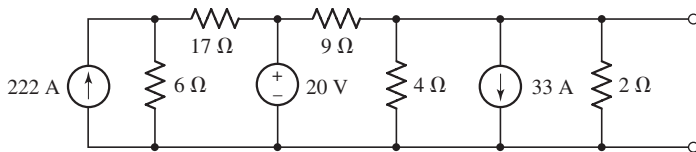

■ FIGURE 5.78

38. With regard to the network depicted in Fig. 5.79, determine the Thévenin equivalent as seen by an element connected to terminals (a)  $a$  and  $b$ ; (b)  $a$  and  $c$ ; (c)  $b$  and  $c$ . (d) Verify your answers using PSpice or other suitable CAD tool. (Hint: Connect a test source to the terminals of interest.)

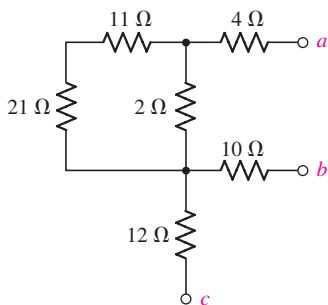

■ FIGURE 5.79

39. Determine the Thévenin and Norton equivalents of the circuit represented in Fig. 5.80 from the perspective of the open terminals. (There should be no dependent sources in your answer.)  
 40. Determine the Norton equivalent of the circuit drawn in Fig. 5.81 as seen by terminals  $a$  and  $b$ . (There should be no dependent sources in your answer.)  
 41. With regard to the circuit of Fig. 5.82, determine the power dissipated by (a) a 1 k $\Omega$  resistor connected between  $a$  and  $b$ ; (b) a 4.7 k $\Omega$  resistor connected between  $a$  and  $b$ ; (c) a 10.54 k $\Omega$  resistor connected between  $a$  and  $b$ .

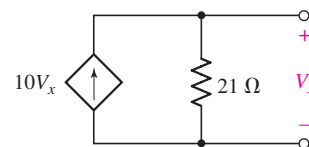

■ FIGURE 5.80

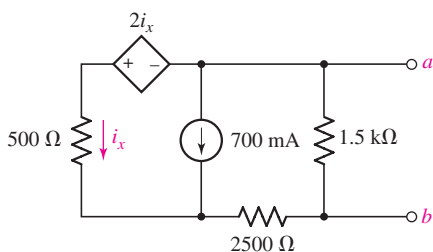

■ FIGURE 5.81

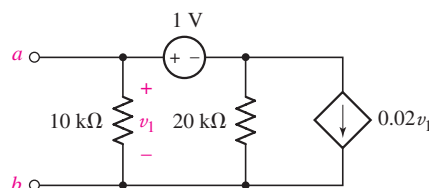

■ FIGURE 5.82

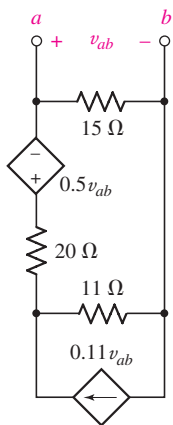

■ FIGURE 5.83

42. Determine the Thévenin and Norton equivalents of the circuit shown in Fig. 5.83, as seen by an unspecified element connected between terminals  $a$  and  $b$ .
43. Referring to the circuit of Fig. 5.84, determine the Thévenin equivalent resistance of the circuit to the right of the dashed line. This circuit is a common-source transistor amplifier, and you are calculating its input resistance.

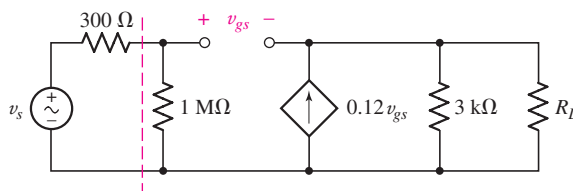

■ FIGURE 5.84

44. Referring to the circuit of Fig. 5.85, determine the Thévenin equivalent resistance of the circuit to the right of the dashed line. This circuit is a common-collector transistor amplifier, and you are calculating its input resistance.

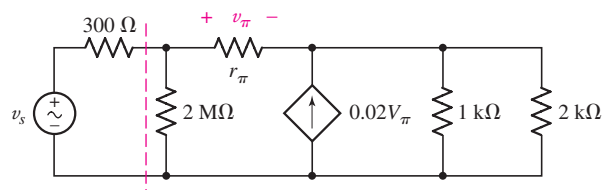

■ FIGURE 5.85

45. The circuit shown in Fig. 5.86 is a reasonably accurate model of an operational amplifier. In cases where  $R_i$  and  $A$  are very large and  $R_o \sim 0$ , a resistive load (such as a speaker) connected between ground and the terminal labeled  $v_{out}$  will see a voltage  $-R_f/R_1$  times larger than the input signal  $v_{in}$ . Find the Thévenin equivalent of the circuit, taking care to label  $v_{out}$ .

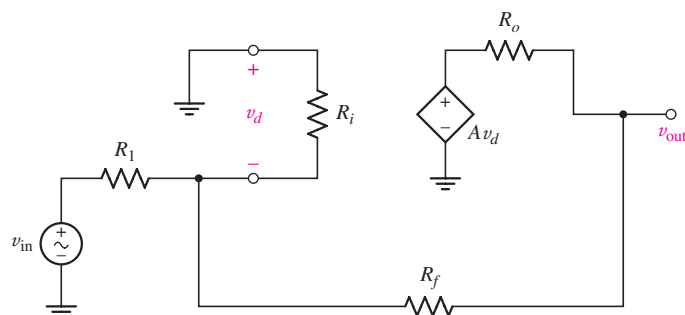

■ FIGURE 5.86

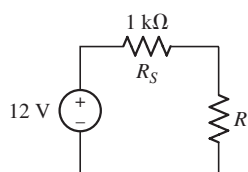

■ FIGURE 5.87

## 5.4 Maximum Power Transfer

46. (a) For the simple circuit of Fig. 5.87, graph the power dissipated by the resistor  $R$  as a function of  $R/R_S$ , if  $0 \leq R \leq 3000 \Omega$ . (b) Graph the first derivative of the power versus  $R/R_S$ , and verify that maximum power is transferred to  $R$  when it is equal to  $R_S$ .

47. For the circuit drawn in Fig. 5.88, (a) determine the Thévenin equivalent connected to  $R_{\text{out}}$ . (b) Choose  $R_{\text{out}}$  such that maximum power is delivered to it.
48. Study the circuit of Fig. 5.89. (a) Determine the Norton equivalent connected to resistor  $R_{text{out}}$ . (b) Select a value for  $R_{\text{out}}$  such that maximum power will be delivered to it.

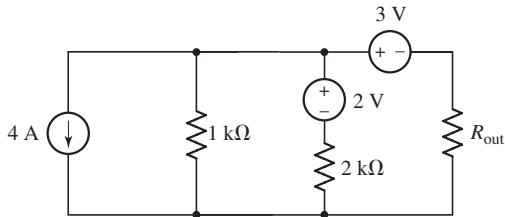

■ FIGURE 5.89

49. Assuming that we can determine the Thévenin equivalent resistance of our wall socket, why don't toaster, microwave oven, and TV manufacturers match each appliance's Thévenin equivalent resistance to this value? Wouldn't it permit maximum power transfer from the utility company to our household appliances?
50. For the circuit of Fig. 5.90, what value of  $R_L$  will ensure it absorbs the maximum possible amount of power?

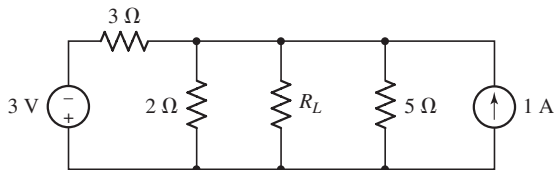

■ FIGURE 5.90

51. With reference to the circuit of Fig. 5.91, (a) calculate the power absorbed by the 9 Ω resistor; (b) adjust the size of the 5 Ω resistor so that the new network delivers maximum power to the 9 Ω resistor.

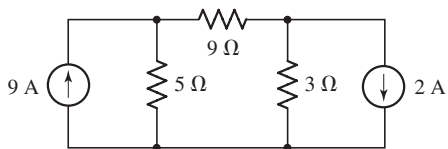

■ FIGURE 5.91

52. Referring to the circuit of Fig. 5.92, (a) determine the power absorbed by the 3.3 Ω resistor; (b) replace the 3.3 Ω resistor with another resistor such that it absorbs maximum power from the rest of the circuit.

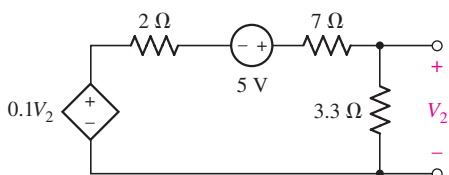

■ FIGURE 5.92

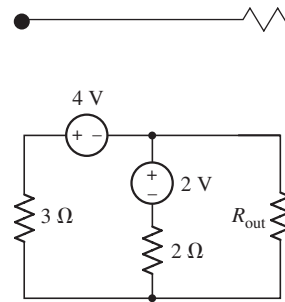

■ FIGURE 5.88

53. Select a value for  $R_L$  in Fig. 5.93 such that it is ensured to absorb maximum power from the circuit.

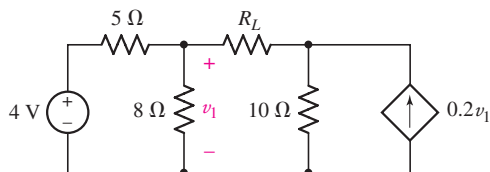

■ FIGURE 5.93

54. Determine what value of resistance would absorb maximum power from the circuit of Fig. 5.94 when connected across terminals  $a$  and  $b$ .

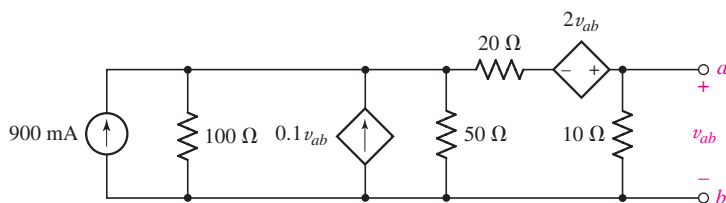

■ FIGURE 5.94

## 5.5 Delta-Wye Conversion

55. Derive the equations required to convert from a Y-connected network to a  $\Delta$ -connected network.
56. Convert the  $\Delta$ - (or “ $\Pi$ -”) connected networks in Fig. 5.95 to Y-connected networks.

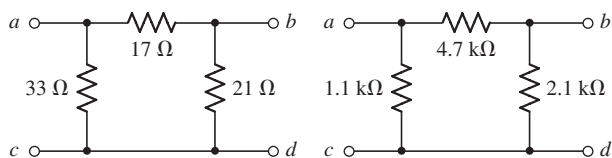

■ FIGURE 5.95

57. Convert the Y- (or “T-”) connected networks in Fig. 5.96 to  $\Delta$ -connected networks.

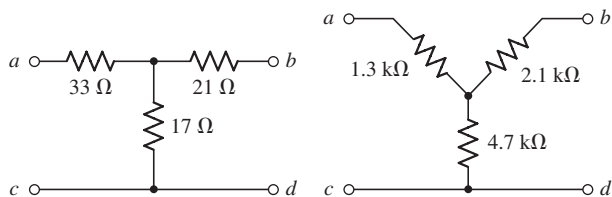

■ FIGURE 5.96

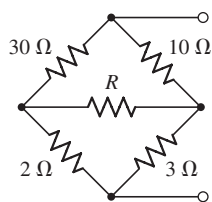

■ FIGURE 5.97

58. For the network of Fig. 5.97, select a value of  $R$  such that the network has an equivalent resistance of  $9\ \Omega$ . Round your answer to two significant figures.

59. For the network of Fig. 5.98, select a value of  $R$  such that the network has an equivalent resistance of  $70.6 \Omega$ .

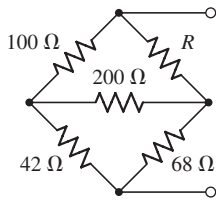

■ FIGURE 5.98

60. Determine the effective resistance  $R_{in}$  of the network exhibited in Fig. 5.99.

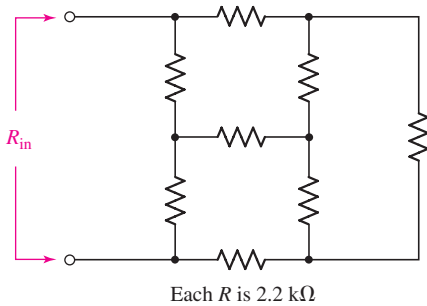

■ FIGURE 5.99

61. Calculate  $R_{in}$  as indicated in Fig. 5.100.

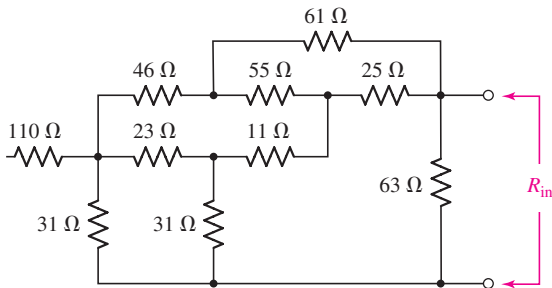

■ FIGURE 5.100

62. Employ  $\Delta/Y$  conversion techniques as appropriate to determine  $R_{in}$  as labeled in Fig. 5.101.

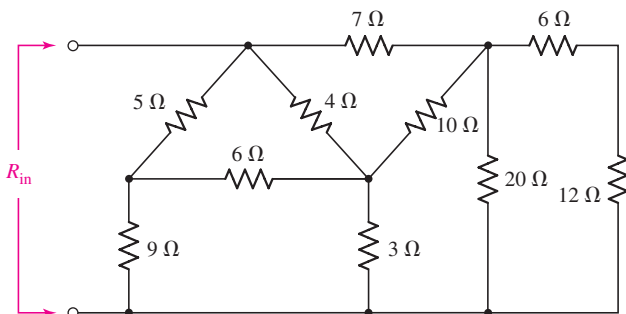

■ FIGURE 5.101

63. (a) Determine the two-component Thévenin equivalent of the network in Fig. 5.102. (b) Calculate the power dissipated by a  $1\ \Omega$  resistor connected between the open terminals.

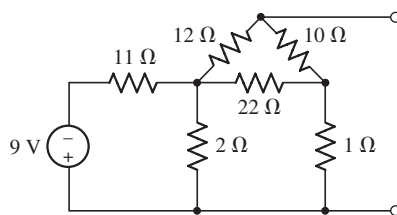

■ FIGURE 5.102



64. (a) Use appropriate techniques to obtain both the Thévenin and Norton equivalents of the network drawn in Fig. 5.103. (b) Verify your answers by simulating each of the three circuits connected to a  $1\ \Omega$  resistor.

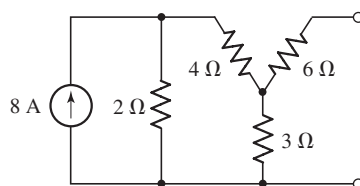

■ FIGURE 5.103



65. (a) Replace the network in Fig. 5.104 with an equivalent three-resistor  $\Delta$  network. (b) Perform a PSpice analysis to verify that your answer is in fact equivalent. (Hint: Try adding a load resistor.)

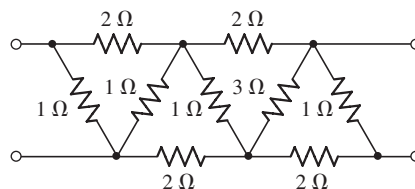

■ FIGURE 5.104

## 5.6 Selecting an Approach: A Summary of Various Techniques

66. Determine the power absorbed by a resistor connected between the open terminal of the circuit shown in Fig. 5.105 if it has a value of (a)  $1\ \Omega$ ; (b)  $100\ \Omega$ ; (c)  $2.65\ \text{k}\Omega$ ; (d)  $1.13\ \text{M}\Omega$ .

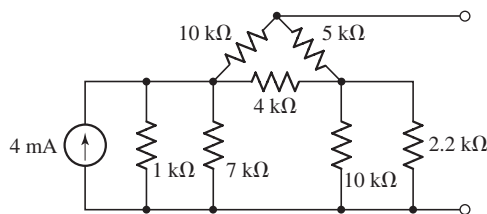

■ FIGURE 5.105

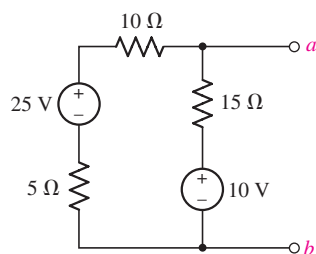

■ FIGURE 5.106

67. It is known that a load resistor of some type will be connected between terminals  $a$  and  $b$  of the network of Fig. 5.106. (a) Change the value of the  $25\ \text{V}$  source such that both voltage sources contribute equally to the power delivered to the load resistor, assuming its value is chosen such that it absorbs maximum power. (b) Calculate the value of the load resistor.

68. A  $2.57\ \Omega$  load is connected between terminals  $a$  and  $b$  of the network drawn in Fig. 5.106. Unfortunately, the power delivered to the load is only 50% of the required amount. Altering only voltage sources, modify the circuit so that the required power is delivered and both sources contribute equally.
69. A load resistor is connected across the open terminals of the circuit shown in Fig. 5.107, and its value was chosen carefully to ensure maximum power transfer from the rest of the circuit. (a) What is the value of the resistor? (b) If the power absorbed by the load resistor is three times as large as required, modify the circuit so that it performs as desired, without losing the maximum power transfer condition already enjoyed.

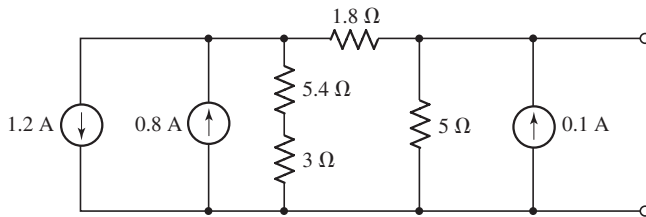

■ FIGURE 5.107

70. A backup is required for the circuit depicted in Fig. 5.107. It is unknown what will be connected to the open terminals, or whether it will be purely linear. If a simple battery is to be used, what no-load (“open circuit”) voltage should it have, and what is the maximum tolerable internal resistance?

### Chapter-Integrating Exercises

71. Three 45 W light bulbs originally wired in a Y network configuration with a 120 V ac source connected across each port are rewired as a  $\Delta$  network. The neutral, or center, connection is not used. If the intensity of each light is proportional to the power it draws, design a new 120 V ac power circuit so that the three lights have the same intensity in the  $\Delta$  configuration as they did when connected in a Y configuration. Verify your design using PSpice by comparing the power drawn by each light in your circuit (modeled as an appropriately chosen resistor value) with the power each would draw in the original Y-connected circuit.
72. (a) Explain in general terms how source transformation can be used to simplify a circuit prior to analysis. (b) Even if source transformations can greatly simplify a particular circuit, when might it not be worth the effort? (c) Multiplying all the independent sources in a circuit by the same scaling factor results in all other voltages and currents being scaled by the same amount. Explain why we don't scale the dependent sources as well. (d) In a general circuit, if we set an independent voltage source to zero, what current can flow through it? (e) In a general circuit, if we set an independent current source to zero, what voltage can be sustained across its terminals?
73. The load resistor in Fig. 5.108 can safely dissipate up to 1 W before overheating and bursting into flame. The lamp can be treated as a  $10.6\ \Omega$  resistor if less than 1 A flows through it and a  $15\ \Omega$  resistor if more than 1 A flows through it. What is the maximum permissible value of  $I_s$ ? Verify your answer with PSpice.

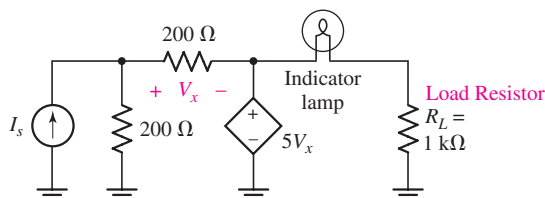

■ FIGURE 5.108



DP

74. A certain red LED has a maximum current rating of 35 mA, and if this value is exceeded, overheating and catastrophic failure will result. The resistance of the LED is a nonlinear function of its current, but the manufacturer warrants a minimum resistance of  $47\ \Omega$  and a maximum resistance of  $117\ \Omega$ . Only 9 V batteries are available to power the LED. Design a suitable circuit to deliver the maximum power possible to the LED without damaging it. Use only combinations of the standard resistor values given in the inside front cover.

DP

75. As part of a security system, a very thin  $100\ \Omega$  wire is attached to a window using nonconducting epoxy. Given only a box of 12 rechargeable 1.5 V AAA batteries, one thousand  $1\ \Omega$  resistors, and a 2900 Hz piezo buzzer that draws 15 mA at 6 V, design a circuit with no moving parts that will set off the buzzer if the window is broken (and hence the thin wire as well). Note that the buzzer requires a dc voltage of at least 6 V (maximum 28 V) to operate.



# The Operational Amplifier

## INTRODUCTION

At this point we have a good set of circuit analysis tools at our disposal, but have focused primarily on somewhat general circuits composed of only sources and resistors. In this chapter, we introduce a new component which, although technically nonlinear, can be treated effectively with linear models. This element, known as the *operational amplifier* or *op amp* for short, finds daily usage in a large variety of electronic applications. It also provides us a new element to use in building circuits, and another opportunity to test out our developing analytical skills.

## 6.1 BACKGROUND

The origins of the operational amplifier date to the 1940s, when basic circuits were constructed using vacuum tubes to perform mathematical operations such as addition, subtraction, multiplication, division, differentiation, and integration. This enabled the construction of analog (as opposed to digital) computers tasked with the solution of complex differential equations. The first commercially available op amp *device* is generally considered to be the K2-W, manufactured by Philbrick Researches, Inc. of Boston from about 1952 through the early 1970s (Fig. 6.1a). These early vacuum tube devices weighed 3 oz (85 g), measured  $1\frac{33}{64}$  in  $\times$   $2\frac{9}{64}$  in  $\times$   $4\frac{7}{64}$  in (3.8 cm  $\times$  5.4 cm  $\times$  10.4 cm), and sold for about US\$22. In contrast, integrated circuit (IC) op amps such as the Fairchild KA741 weigh less than 500 mg, measure 5.7 mm  $\times$  4.9 mm  $\times$  1.8 mm, and sell for approximately US\$0.22.

Compared to op amps based on vacuum tubes, modern IC op amps are constructed using perhaps 25 or more transistors all on the same silicon “chip,” as well as resistors and capacitors needed to obtain the desired performance characteristics. As a result, they run at

## KEY CONCEPTS

Characteristics of Ideal Op Amps

Inverting and Noninverting Amplifiers

Summing and Difference Amplifier Circuits

Cascaded Op Amp Stages

Using Op Amps to Build Voltage and Current Sources

Nonideal Characteristics of Op Amps

Voltage Gain and Feedback

Basic Comparator and Instrumentation Amplifier Circuits



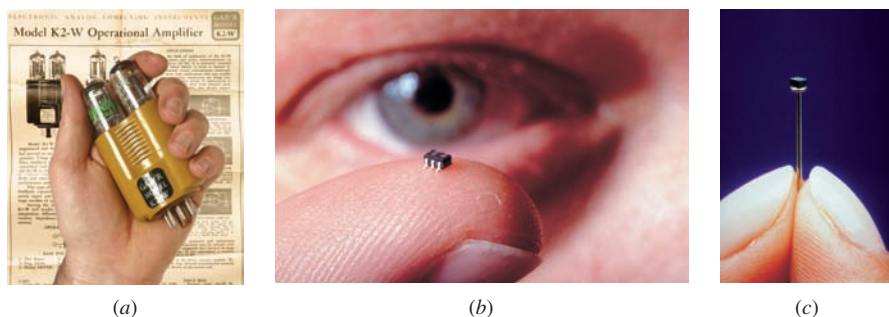

■ FIGURE 6.1 (a) A Philbrick K2-W op amp, based on a matched pair of 12AX7A vacuum tubes. (b) LMV321 op amp, used in a variety of phone and game applications. (c) LMC6035 operational amplifier, which packs 114 transistors into a package so small that it fits on the head of a pin. (b–c) Copyright © 2011 National Semiconductor Corporation ([www.national.com](http://www.national.com)). All rights reserved. Used with permission.

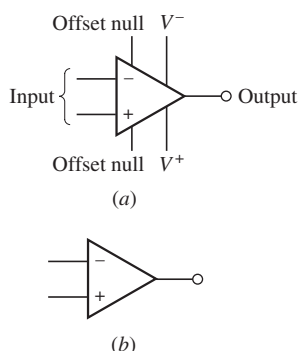

■ FIGURE 6.2 (a) Electrical symbol for the op amp. (b) Minimum required connections to be shown on a circuit schematic.

much lower dc supply voltages ( $\pm 18$  V, for example, as opposed to  $\pm 300$  V for the K2-W), are more reliable, and considerably smaller (Fig. 6.1b,c). In some cases, the IC may contain several op amps. In addition to the output pin and the two inputs, other pins enable power to be supplied to run the transistors, and for external adjustments to be made to balance and compensate the op amp. The symbol commonly used for an op amp is shown in Fig. 6.2a. At this point, we are not concerned with the internal circuitry of the op amp or the IC, but only with the voltage and current relationships that exist between the input and output terminals. Thus, for the time being we will use a simpler electrical symbol, shown in Fig. 6.2b. Two input terminals are shown on the left, and a single output terminal appears at the right. The terminal marked by a “+” is referred to as the *noninverting input*, and the “–” marked terminal is called the *inverting input*.

## 6.2 THE IDEAL OP AMP: A CORDIAL INTRODUCTION

In practice, we find that most op amps perform so well that we can often make the assumption that we are dealing with an “ideal” op amp. The characteristics of an *ideal op amp* form the basis for two fundamental rules that at first may seem somewhat unusual:

### Ideal Op Amp Rules

1. No current ever flows into either input terminal.
2. There is no voltage difference between the two input terminals.

In a real op amp, a very small leakage current will flow into the input (sometimes as low as 40 femtoamperes). It is also possible to obtain a very small voltage across the two input terminals. However, compared to other voltages and currents in most circuits, such values are so small that including them in the analysis does not typically affect our calculations.

When analyzing op amp circuits, we should keep one other point in mind. As opposed to the circuits that we have studied so far, an op amp circuit always has an *output* that depends on some type of *input*. Therefore, we will analyze op amp circuits with the goal of obtaining an expression for the output in terms of the input quantities. *We will find that it is usually a good idea to begin the analysis of an op amp circuit at the input, and proceed from there.*



The circuit shown in Fig. 6.3 is known as an *inverting amplifier*. We choose to analyze this circuit using KVL, beginning with the input voltage source. The current labeled  $i$  flows only through the two resistors  $R_1$  and  $R_f$ ; ideal op amp rule 1 states that no current flows into the inverting input terminal. Thus, we can write

$$-v_{\text{in}} + R_1 i + R_f i + v_{\text{out}} = 0$$

which can be rearranged to obtain an equation that relates the output to the input:

$$v_{\text{out}} = v_{\text{in}} - (R_1 + R_f)i \quad [1]$$

Given  $v_{\text{in}} = 5 \sin 3t$  mV,  $R_1 = 4.7 \text{ k}\Omega$ , and  $R_f = 47 \text{ k}\Omega$ , we require one additional equation that expresses  $i$  only in terms of  $v_{\text{out}}$ ,  $v_{\text{in}}$ ,  $R_1$ , and/or  $R_f$ .

This is a good time to mention that we have not yet made use of ideal op amp rule 2. Since the noninverting input is grounded, it is at zero volts. By ideal op amp rule 2, the inverting input is therefore also at zero volts! *This does not mean that the two inputs are physically shorted together, and we should be careful not to make such an assumption.* Rather, the two input voltages simply track each other: if we try to change the voltage at one pin, the other pin will be driven by internal circuitry to the same value. Thus, we can write one more KVL equation:

$$-v_{\text{in}} + R_1 i + 0 = 0$$

or

$$i = \frac{v_{\text{in}}}{R_1} \quad [2]$$

Combining Eq. [2] with Eq. [1], we obtain an expression for  $v_{\text{out}}$  in terms of  $v_{\text{in}}$ :

$$v_{\text{out}} = -\frac{R_f}{R_1} v_{\text{in}} \quad [3]$$

Substituting  $v_{\text{in}} = 5 \sin 3t$  mV,  $R_1 = 4.7 \text{ k}\Omega$ , and  $R_f = 47 \text{ k}\Omega$ ,

$$v_{\text{out}} = -50 \sin 3t \quad \text{mV}$$

Since  $R_f > R_1$ , this circuit amplifies the input voltage signal  $v_{\text{in}}$ . If we choose  $R_f < R_1$ , the signal will be attenuated instead. We also note that the output voltage has the opposite sign of the input voltage,<sup>1</sup> hence the name “inverting amplifier.” The output is sketched in Fig. 6.4, along with the input waveform for comparison.

At this point, it is worth mentioning that the ideal op amp seems to be violating KCL. Specifically, in the above circuit no current flows into or out of either input terminal, but somehow current is able to flow into the output pin! This would imply that the op amp is somehow able to either create electrons out of nowhere or store them forever (depending on the direction of current flow). Obviously, this is not possible. The conflict arises because we have been treating the op amp the same way we treated passive elements

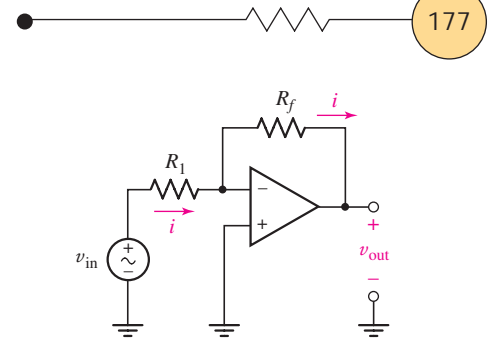

FIGURE 6.3 An op amp used to construct an inverting amplifier circuit. The current  $i$  flows to ground through the output pin of the op amp.



The fact that the inverting input terminal finds itself at zero volts in this type of circuit configuration leads to what is often referred to as a “virtual ground.” This does not mean that the pin is actually grounded, which is sometimes a source of confusion for students. The op amp makes whatever internal adjustments are necessary to prevent a voltage difference between the input terminals. The input terminals are not shorted together.

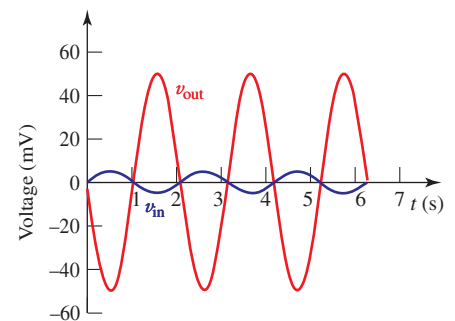
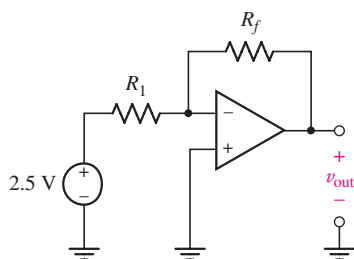

FIGURE 6.4 Input and output waveforms of the inverting amplifier circuit.

(1) Or, “the output is  $180^\circ$  out of phase with the input,” which sounds more impressive.



■ FIGURE 6.5 An inverting amplifier circuit with a 2.5 V input.

such as the resistor. In reality, however, the op amp cannot function unless it is connected to external power sources. It is through those power sources that we can direct current flow through the output terminal.

Although we have shown that the inverting amplifier circuit of Fig. 6.3 can amplify an ac signal (a sine wave in this case having a frequency of 3 rad/s and an amplitude of 5 mV), it works just as well with dc inputs. We consider this type of situation in Fig. 6.5, where values for  $R_1$  and  $R_f$  are to be selected to obtain an output voltage of  $-10$  V.

This is the same circuit as shown in Fig. 6.3, but with a 2.5 V dc input. Since no other change has been made, the expression we presented as Eq. [3] is valid for this circuit as well. To obtain the desired output, we seek a ratio of  $R_f$  to  $R_1$  of  $10/2.5$ , or 4. Since it is only the ratio that is important here, we simply need to pick a convenient value for one resistor, and the other resistor value is then fixed at the same time. For example, we could choose  $R_1 = 100 \Omega$  (so  $R_f = 400 \Omega$ ), or even  $R_f = 8 \text{ M}\Omega$  (so  $R_1 = 2 \text{ M}\Omega$ ). In practice, other constraints (such as bias current) may limit our choices.

This circuit configuration therefore acts as a convenient type of voltage amplifier (or *attenuator*, if the ratio of  $R_f$  to  $R_1$  is less than 1), but does have the sometimes inconvenient property of inverting the sign of the input. There is an alternative, however, which is analyzed just as easily—the non-inverting amplifier shown in Fig. 6.6. We examine such a circuit in the following example.

### EXAMPLE 6.1

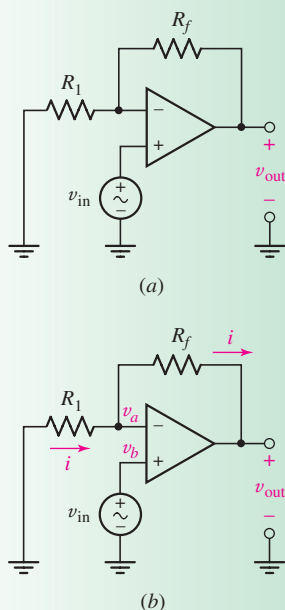

■ FIGURE 6.6 (a) An op amp used to construct a noninverting amplifier circuit. (b) Circuit with the current through  $R_1$  and  $R_f$  defined, as well as both input voltages labeled.

Sketch the output waveform of the noninverting amplifier circuit in Fig. 6.6a. Use  $v_{in} = 5 \sin 3t$  mV,  $R_1 = 4.7 \text{ k}\Omega$ , and  $R_f = 47 \text{ k}\Omega$ .

#### ► Identify the goal of the problem.

We require an expression for  $v_{out}$  that only depends on the known quantities  $v_{in}$ ,  $R_1$ , and  $R_f$ .

#### ► Collect the known information.

Since values have been specified for the resistors and the input waveform, we begin by labeling the current  $i$  and the two input voltages as shown in Fig. 6.6b. We will assume that the op amp is an ideal op amp.

#### ► Devise a plan.

Although mesh analysis is a favorite technique of students, it turns out to be more practical in most op amp circuits to apply nodal analysis, since there is no direct way to determine the current flowing out of the op amp output.

#### ► Construct an appropriate set of equations.

Note that we are using ideal op amp rule 1 implicitly by defining the same current through both resistors: no current flows into the inverting input terminal. Employing nodal analysis to obtain our expression for  $v_{out}$  in terms of  $v_{in}$ , we thus find that

At node  $a$ :

$$0 = \frac{v_a}{R_1} + \frac{v_a - v_{\text{out}}}{R_f} \quad [4]$$

At node  $b$ :

$$v_b = v_{\text{in}} \quad [5]$$

► **Determine if additional information is required.**

Our goal is to obtain a single expression that relates the input and output voltages, although neither Eq. [4] nor Eq. [5] appears to do so. However, we have not yet employed ideal op amp rule 2, and we will find that in almost every op amp circuit *both* rules need to be invoked in order to obtain such an expression.

Thus, we recognize that  $v_a = v_b = v_{\text{in}}$ , and Eq. [4] becomes

$$0 = \frac{v_{\text{in}}}{R_1} + \frac{v_{\text{in}} - v_{\text{out}}}{R_f}$$

► **Attempt a solution.**

Rearranging, we obtain an expression for the output voltage in terms of the input voltage  $v_{\text{in}}$ :

$$v_{\text{out}} = \left(1 + \frac{R_f}{R_1}\right) v_{\text{in}} = 11v_{\text{in}} = 55 \sin 3t \text{ mV}$$

► **Verify the solution. Is it reasonable or expected?**

The output waveform is sketched in Fig. 6.7, along with the input waveform for comparison. In contrast to the output waveform of the inverting amplifier circuit, we note that the input and output are in phase for the noninverting amplifier. This should not be entirely unexpected: it is implicit in the name “noninverting amplifier.”

## PRACTICE

6.1 Derive an expression for  $v_{\text{out}}$  in terms of  $v_{\text{in}}$  for the circuit shown in Fig. 6.8.

Ans:  $v_{\text{out}} = v_{\text{in}}$ . The circuit is known as a “voltage follower,” since the output voltage tracks or “follows” the input voltage.

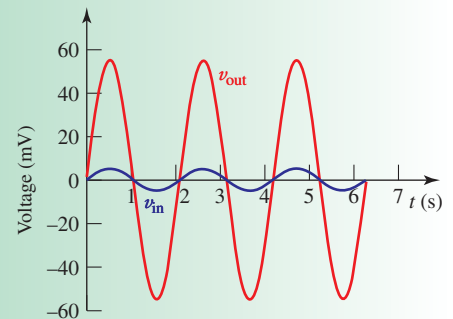

■ FIGURE 6.7 Input and output waveforms for the noninverting amplifier circuit.

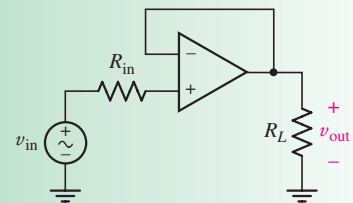

■ FIGURE 6.8

Just like the inverting amplifier, the noninverting amplifier works with dc as well as ac inputs, but has a voltage gain of  $v_{\text{out}}/v_{\text{in}} = 1 + (R_f/R_1)$ . Thus, if we set  $R_f = 9 \Omega$  and  $R_1 = 1 \Omega$ , we obtain an output  $v_{\text{out}}$  which is 10 times larger than the input voltage  $v_{\text{in}}$ . In contrast to the inverting amplifier, the output and input of the noninverting amplifier always have the same sign, and the output voltage cannot be less than the input; the minimum gain is 1. Which amplifier we choose depends on the application we are considering. In the special case of the voltage follower circuit shown in Fig. 6.8,

which represents a noninverting amplifier with  $R_1$  set to  $\infty$  and  $R_f$  set to zero, the output is identical to the input in both sign *and* magnitude. This may seem rather pointless as a general type of circuit, but we should keep in mind that *the voltage follower draws no current from the input* (in the ideal case)—it therefore can act as a **buffer** between the voltage  $v_{in}$  and some resistive load  $R_L$  connected to the output of the op amp.

We mentioned earlier that the name “operational amplifier” originates from using such devices to perform arithmetical operations on analog (i.e., nondigitized, real-time, real-world) signals. As we see in the following two circuits, this includes both addition and subtraction of input voltage signals.

## EXAMPLE 6.2

**Obtain an expression for  $v_{out}$  in terms of  $v_1$ ,  $v_2$ , and  $v_3$  for the op amp circuit in Fig. 6.9, also known as a *summing amplifier*.**

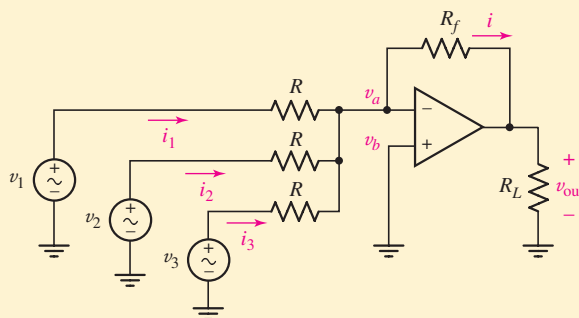

■ FIGURE 6.9 Basic summing amplifier circuit with three inputs.

We first note that this circuit is similar to the inverting amplifier circuit of Fig. 6.3. Again, the goal is to obtain an expression for  $v_{out}$  (which in this case appears across a load resistor  $R_L$ ) in terms of the inputs ( $v_1$ ,  $v_2$ , and  $v_3$ ).

Since no current can flow into the inverting input terminal, we can write

$$i = i_1 + i_2 + i_3$$

Therefore, we can write the following equation at the node labeled  $v_a$ :

$$0 = \frac{v_a - v_{out}}{R_f} + \frac{v_a - v_1}{R} + \frac{v_a - v_2}{R} + \frac{v_a - v_3}{R}$$

This equation contains both  $v_{out}$  and the input voltages, but unfortunately it also contains the nodal voltage  $v_a$ . To remove this unknown quantity from our expression, we need to write an additional equation that relates  $v_a$  to  $v_{out}$ , the input voltages,  $R_f$ , and/or  $R$ . At this point, we remember that we have not yet used ideal op amp rule 2, and that we will almost certainly require the use of both rules when analyzing an op amp circuit. Thus, since  $v_a = v_b = 0$ , we can write the following:

$$0 = \frac{v_{out}}{R_f} + \frac{v_1}{R} + \frac{v_2}{R} + \frac{v_3}{R}$$

Rearranging, we obtain the following expression for  $v_{\text{out}}$ :

$$v_{\text{out}} = -\frac{R_f}{R}(v_1 + v_2 + v_3) \quad [6]$$

In the special case where  $v_2 = v_3 = 0$ , we see that our result agrees with Eq. [3], which was derived for essentially the same circuit.

There are several interesting features about the result we have just derived. First, if we select  $R_f$  so that it is equal to  $R$ , then the output is the (negative of the) sum of the three input signals  $v_1$ ,  $v_2$ , and  $v_3$ . Further, we can select the ratio of  $R_f$  to  $R$  to multiply this sum by a fixed constant. So, for example, if the three voltages represented signals from three separate scales calibrated so that  $-1 \text{ V} = 1 \text{ lb}$ , we could set  $R_f = R/2.205$  to obtain a voltage signal that represented the combined weight in kilograms (to within about 1 percent accuracy due to our conversion factor).

Also, we notice that  $R_L$  did not appear in our final expression. As long as its value is not too low, the operation of the circuit will not be affected; at present, we have not considered a detailed enough model of an op amp to predict such an occurrence. This resistor represents the Thévenin equivalent of whatever we use to monitor the amplifier output. If our output device is a simple voltmeter, then  $R_L$  represents the Thévenin equivalent resistance seen looking into the voltmeter terminals (typically  $10 \text{ M}\Omega$  or more). Or, our output device might be a speaker (typically  $8 \Omega$ ), in which case we hear the sum of the three separate sources of sound;  $v_1$ ,  $v_2$ , and  $v_3$  might represent microphones in that case.

One word of caution: It is frequently tempting to assume that the current labeled  $i$  in Fig. 6.9 flows not only through  $R_f$  but through  $R_L$  also. Not true! It is very possible that current is flowing through the output terminal of the op amp as well, so that *the currents through the two resistors are not the same*. It is for this reason that we almost universally avoid writing KCL equations at the output pin of an op amp, which leads to the preference of nodal over mesh analysis when working with most op amp circuits.



For convenience, we summarize the most common op amp circuits in Table 1.

## PRACTICE

6.2 Derive an expression for  $v_{\text{out}}$  in terms of  $v_1$  and  $v_2$  for the circuit shown in Fig. 6.10, also known as a **difference amplifier**.

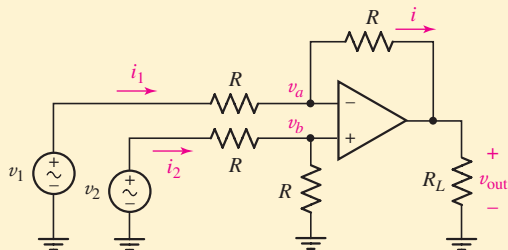

FIGURE 6.10

Ans:  $v_{\text{out}} = v_2 - v_1$ . *Hint:* Use voltage division to obtain  $v_b$ .

TABLE 6.1 Summary of Basic Op Amp Circuits

Name	Circuit Schematic	Input-Output Relation
Inverting Amplifier		$v_{\text{out}} = -\frac{R_f}{R_1} v_{\text{in}}$
Noninverting Amplifier		$v_{\text{out}} = \left(1 + \frac{R_f}{R_1}\right) v_{\text{in}}$
Voltage Follower (also known as a Unity Gain Amplifier)		$v_{\text{out}} = v_{\text{in}}$
Summing Amplifier		$v_{\text{out}} = -\frac{R_f}{R} (v_1 + v_2 + v_3)$
Difference Amplifier		$v_{\text{out}} = v_2 - v_1$



# PRACTICAL APPLICATION

## A Fiber Optic Intercom

A point-to-point intercom system can be constructed using a number of different approaches, depending on the intended application environment. Low-power radio frequency (RF) systems work very well and are generally cost-effective, but are subject to interference from other RF sources and are also prone to eavesdropping. Use of a simple wire to connect the two intercom systems instead can eliminate a great deal of the RF interference as well as increase privacy. However, wires are subject to corrosion and short circuits when the plastic insulation wears, and their weight can be a concern in aircraft and related applications (Fig. 6.11).



■ FIGURE 6.11 The application environment often dictates design constraints. (© Michael Melford/Riser/Getty Images.)

An alternative design would be to convert the electrical signal from the microphone to an optical signal, which could then be transmitted through a thin ( $\sim 50 \mu\text{m}$  diameter) optical fiber. The optical signal is then converted back to an electrical signal, which is amplified and delivered to a speaker. A schematic diagram of such a system is shown in Fig. 6.12; two such systems would be needed for two-way communication.

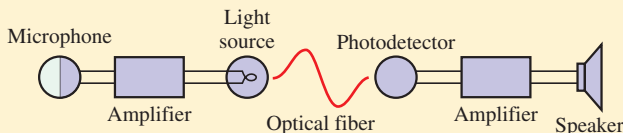

■ FIGURE 6.12 Schematic diagram of one-half of a simple fiber optic intercom.

We can consider the design of the transmission and reception circuits separately, since the two circuits are in fact electrically independent. Figure 6.13 shows a simple

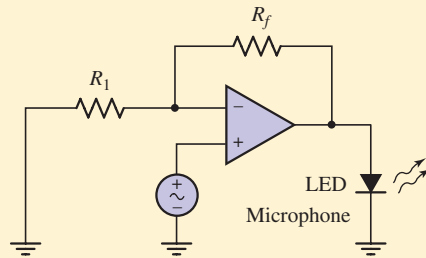

■ FIGURE 6.13 Circuit used to convert the electrical microphone signal into an optical signal for transmission through a fiber.

signal generation circuit consisting of a microphone, a light-emitting diode (LED), and an op amp used in a noninverting amplifier circuit to drive the LED; not shown are the power connections required for the op amp itself. The light output of the LED is roughly proportional to its current, although less so for very small and very large values of current.

We know the gain of the amplifier is given by

$$\frac{v_{\text{out}}}{v_{\text{in}}} = 1 + \frac{R_f}{R_1}$$

which is independent of the resistance of the LED. In order to select values for  $R_f$  and  $R_1$ , we need to know the input voltage from the microphone and the necessary output voltage to power the LED. A quick measurement indicates that the typical voltage output of the microphone peaks at 40 mV when someone is using a normal speaking voice. The LED manufacturer recommends operating at approximately 1.6 V, so we design for a gain of  $1.6/0.04 = 40$ . Arbitrarily choosing  $R_1 = 1 \text{ k}\Omega$  leads to a required value of  $39 \text{ k}\Omega$  for  $R_f$ .

The circuit of Fig. 6.14 is the receiver part of our one-way intercom system. It converts the optical signal from the fiber into an electrical signal, amplifying it so that an audible sound emanates from the speaker.

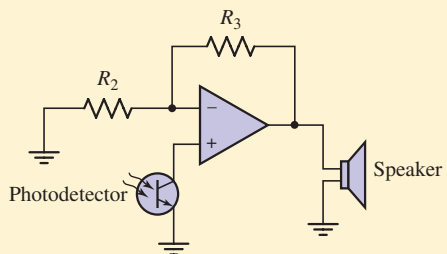

■ FIGURE 6.14 Receiver circuit used to convert the optical signal into an audio signal.

(Continued on next page)

After coupling the LED output of the transmitting circuit to the optical fiber, a signal of approximately 10 mV is measured from the photodetector. The speaker is rated for a maximum of 100 mW and has an equivalent resistance of  $8 \Omega$ . This equates to a maximum speaker voltage of 894 mV, so we need to select values of  $R_2$  and  $R_3$  to obtain a gain of  $894/10 = 89.4$ . With the arbitrary

selection of  $R_2 = 10 \text{ k}\Omega$ , we find that a value of  $884 \text{ k}\Omega$  completes our design.

This circuit will work in practice, although the non-linear characteristics of the LED lead to a noticeable distortion of the audio signal. We leave improved designs for more advanced texts.

### 6.3 CASCADED STAGES

Although the op amp is an extremely versatile device, there are numerous applications in which a single op amp will not suffice. In such instances, it is often possible to meet application requirements by cascading several individual op amps together in the same circuit. An example of this is shown in Fig. 6.15, which consists of the summing amplifier circuit of Fig. 6.9 with only two input sources, and the output fed into a simple inverting amplifier. The result is a two-stage op amp circuit.

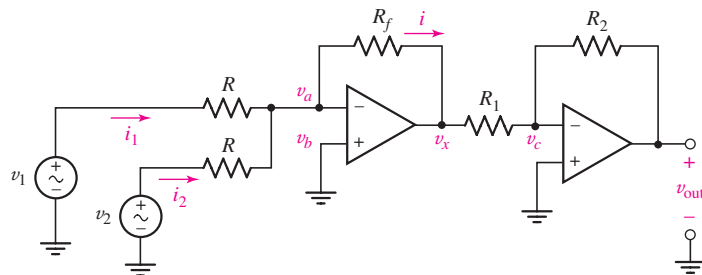

■ FIGURE 6.15 A two-stage op amp circuit consisting of a summing amplifier cascaded with an inverting amplifier circuit.

We have already analyzed each of these op amp circuits separately. Based on our previous experience, if the two op amp circuits were disconnected, we would expect

$$v_x = -\frac{R_f}{R}(v_1 + v_2) \quad [7]$$

and

$$v_{\text{out}} = -\frac{R_2}{R_1}v_x \quad [8]$$

In fact, since the two circuits are connected at a single point and the voltage  $v_x$  is not influenced by the connection, we can combine Eqs. [7] and [8] to obtain

$$v_{\text{out}} = \frac{R_2 R_f}{R_1 R}(v_1 + v_2) \quad [9]$$

which describes the input-output characteristics of the circuit shown in Fig. 6.15. We may not always be able to reduce such a circuit to familiar stages, however, so it is worth seeing how the two-stage circuit of Fig. 6.15 can be analyzed as a whole.

When analyzing cascaded circuits, it is sometimes helpful to begin with the last stage and work backward toward the input stage. Referring to ideal op amp rule 1, the same current flows through  $R_1$  and  $R_2$ . Writing the appropriate nodal equation at the node labeled  $v_c$  yields

$$0 = \frac{v_c - v_x}{R_1} + \frac{v_c - v_{\text{out}}}{R_2} \quad [10]$$

Applying ideal op amp rule 2, we can set  $v_c = 0$  in Eq. [10], resulting in

$$0 = \frac{v_x}{R_1} + \frac{v_{\text{out}}}{R_2} \quad [11]$$

Since our goal is an expression for  $v_{\text{out}}$  in terms of  $v_1$  and  $v_2$ , we proceed to the first op amp in order to obtain an expression for  $v_x$  in terms of the two input quantities.

Applying ideal op amp rule 1 at the inverting input of the first op amp,

$$0 = \frac{v_a - v_x}{R_f} + \frac{v_a - v_1}{R} + \frac{v_a - v_2}{R} \quad [12]$$

Ideal op amp rule 2 allows us to replace  $v_a$  in Eq. [12] with zero, since  $v_a = v_b = 0$ . Thus, Eq. [12] becomes

$$0 = \frac{v_x}{R_f} + \frac{v_1}{R} + \frac{v_2}{R} \quad [13]$$

We now have an equation for  $v_{\text{out}}$  in terms of  $v_x$  (Eq. [11]), and an equation for  $v_x$  in terms of  $v_1$  and  $v_2$  (Eq. [13]). These equations are identical to Eqs. [7] and [8], respectively, which means that cascading the two separate circuits as in Fig. 6.15 did not affect the input-output relationship of either stage. Combining Eqs. [11] and [13], we find that the input-output relationship for the cascaded op amp circuit is

$$v_{\text{out}} = \frac{R_2}{R_1} \frac{R_f}{R} (v_1 + v_2) \quad [14]$$

which is identical to Eq. [9].

Thus, the cascaded circuit acts as a summing amplifier, but without a phase reversal between the input and output. By choosing the resistor values carefully, we can either amplify or attenuate the sum of the two input voltages. If we select  $R_2 = R_1$  and  $R_f = R$ , we can also obtain an amplifier circuit where  $v_{\text{out}} = v_1 + v_2$ , if desired.

## EXAMPLE 6.3

A multiple-tank gas propellant fuel system is installed in a small lunar orbit runabout. The amount of fuel in any tank is monitored by measuring the tank pressure (in psia).<sup>2</sup> Technical details for tank capacity as well as sensor pressure and voltage range are given in Table 6.2. Design a circuit which provides a positive dc voltage signal proportional to the total fuel remaining, such that 1 V = 100 percent.



© Corbis

TABLE 6.2 Technical Data for Tank Pressure Monitoring System

Tank 1 Capacity	10,000 psia
Tank 2 Capacity	10,000 psia
Tank 3 Capacity	2000 psia
Sensor Pressure Range	0 to 12,500 psia
Sensor Voltage Output	0 to 5 Vdc

We see from Table 6.2 that the system has three separate gas tanks, requiring three separate sensors. Each sensor is rated up to 12,500 psia, with a corresponding output of 5 V. Thus, when tank 1 is full, its sensor will provide a voltage signal of  $5 \times (10,000/12,500) = 4$  V; the same is true for the sensor monitoring tank 2. The sensor connected to tank 3, however, will only provide a maximum voltage signal of  $5 \times (2000/12,500) = 800$  mV.

One possible solution is the circuit shown in Fig. 6.16a, which employs a summing amplifier stage with  $v_1$ ,  $v_2$ , and  $v_3$  representing the three sensor outputs, followed by an inverting amplifier to adjust the voltage sign and magnitude. Since we are not told the output resistance of the sensor, we employ a buffer for each one as shown in Fig. 6.16b; the result is (in the ideal case) no current flow from the sensor.

To keep the design as simple as possible, we begin by choosing  $R_1$ ,  $R_2$ ,  $R_3$ , and  $R_4$  to be 1 k $\Omega$ ; any value will do as long as all four resistors are equal. Thus, the output of the summing stage is

$$v_x = -(v_1 + v_2 + v_3)$$

The final stage must invert this voltage and scale it such that the output voltage is 1 V when all three tanks are full. The full condition results in  $v_x = -(4 + 4 + 0.8) = -8.8$  V. Thus, the final stage needs a voltage ratio of  $R_6/R_5 = 1/8.8$ . Arbitrarily choosing  $R_6 = 1$  k $\Omega$ , we find that a value of 8.8 k $\Omega$  for  $R_5$  completes the design.

(2) Pounds per square inch, absolute. This is a differential pressure measurement relative to a vacuum reference.

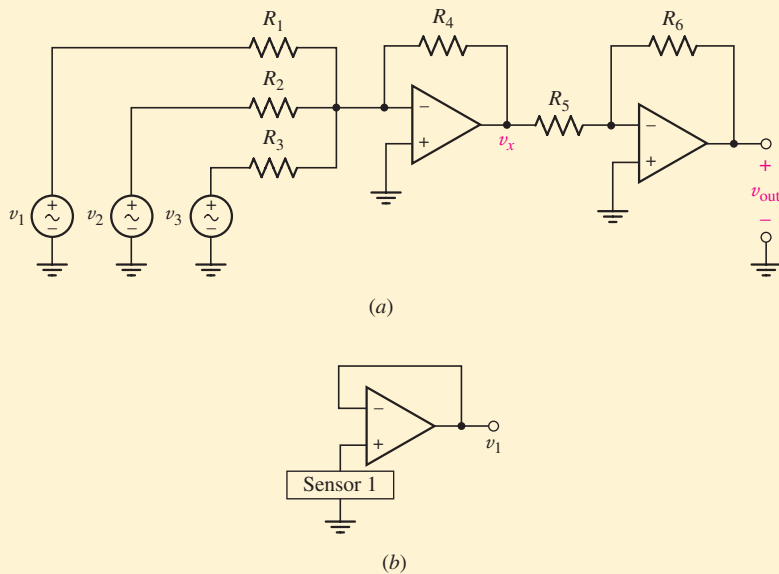

■ FIGURE 6.16 (a) A proposed circuit to provide a total fuel remaining readout. (b) Buffer design to avoid errors associated with the internal resistance of the sensor and limitations on its ability to provide current. One such buffer is used for each sensor, providing the inputs  $v_1$ ,  $v_2$ , and  $v_3$  to the summing amplifier stage.

## PRACTICE

6.3 An historic bridge is showing signs of deterioration. Until renovations can be performed, it is decided that only cars weighing less than 1600 kg will be allowed across. To monitor this, a four-pad weighing system is designed. There are four independent voltage signals, one from each wheel pad, with  $1 \text{ mV} = 1 \text{ kg}$ . Design a circuit to provide a positive voltage signal to be displayed on a DMM (digital multimeter) that represents the total weight of a vehicle, such that  $1 \text{ mV} = 1 \text{ kg}$ . You may assume there is no need to buffer the wheel pad voltage signals.

Ans: See Fig. 6.17.

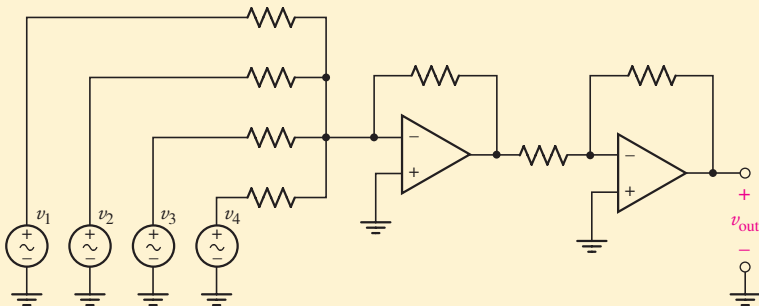

■ FIGURE 6.17 One possible solution to Practice Problem 6.3; all resistors are  $10 \text{ k}\Omega$  (although any value will do as long as they are all equal). Input voltages  $v_1$ ,  $v_2$ ,  $v_3$ , and  $v_4$  represent the voltage signals from the four wheel pad sensors, and  $v_{\text{out}}$  is the output signal to be connected to the positive input terminal of the DMM. All five voltages are referenced to ground, and the common terminal of the DMM should be connected to ground as well.

## 6.4 CIRCUITS FOR VOLTAGE AND CURRENT SOURCES

In this and previous chapters we have often made use of ideal current and voltage sources, which we assume provide the same value of current or voltage, respectively, regardless of how they are connected in a circuit. Our assumption of independence has its limits, of course, as mentioned in Sec. 5.2 when we discussed practical sources which included a “built-in” or inherent resistance. The effect of such a resistance was a reduction of the voltage output of a voltage source as more current was demanded, or a diminished current output as more voltage was required from a current source. As discussed in this section, it is possible to construct circuits with more reliable characteristics using op amps.

### A Reliable Voltage Source

One of the most common means of providing a stable and consistent reference voltage is to make use of a nonlinear device known as a *Zener diode*. Its symbol is a triangle with a Z-like line across the top of the triangle, as shown for a 1N750 in the circuit of Fig. 6.18a. Diodes are characterized by

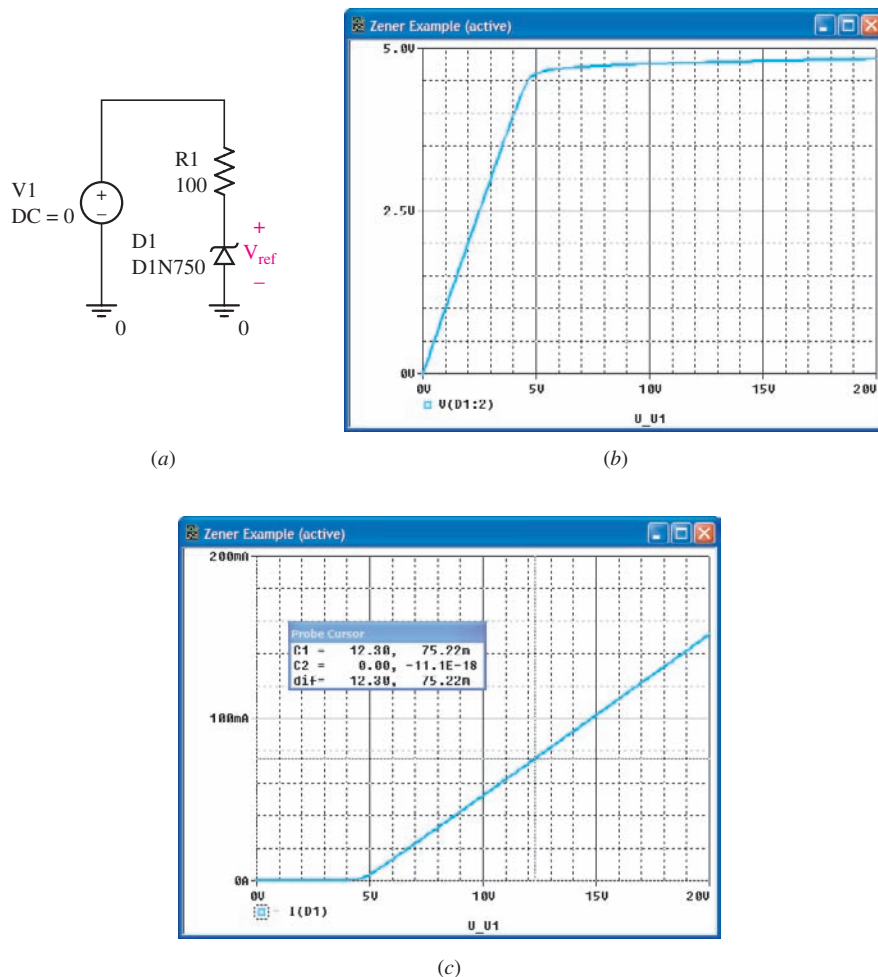

■ FIGURE 6.18 (a) PSPICE schematic of a simple voltage reference circuit based on the 1N750 Zener diode. (b) Simulation of the circuit showing the diode voltage  $V_{ref}$  as a function of the driving voltage  $V_1$ . (c) Simulation of the diode current, showing that its maximum rating is exceeded when  $V_1$  exceeds 12.3 V. (Note that performing this calculation assuming an *ideal* Zener diode yields 12.2 V.)

a strongly asymmetric current-voltage relationship. For small voltages, they either conduct essentially zero current—or experience an exponentially increasing current—depending on the voltage polarity. In this way, they distinguish themselves from the simple resistor, where the magnitude of the current is the same for either voltage polarity and hence the resistor current-voltage relationship is symmetric. Consequently, the terminals of a diode are not interchangeable, and have unique names: the **anode** (the flat part of the triangle) and the **cathode** (the point of the triangle).

A **Zener diode** is a special type of diode designed to be used with a positive voltage at the cathode with respect to the anode; when connected this way, the diode is said to be *reverse biased*. For low voltages, the diode acts like a resistor with a small linear increase in current flow as the voltage is increased. Once a certain voltage ( $V_{BR}$ ) is reached, however—known as the *reverse breakdown voltage* or **Zener voltage** of the diode—the voltage does not significantly increase further, but essentially any current can flow up to the maximum rating of the diode (75 mA for a 1N750, whose Zener voltage is 4.7 V).

Let's consider the simulation result presented in Fig. 6.18*b*, which shows the voltage  $V_{ref}$  across the diode as the voltage source V1 is swept from 0 to 20 V. Provided V1 remains above 5 V, *the voltage across our diode is essentially constant*. Thus, we could replace V1 with a 9 V battery, and not be too concerned with changes in our voltage reference as the battery voltage begins to drop as it discharges. The purpose of R1 in this circuit is simply to provide the necessary voltage drop between the battery and the diode; its value should be chosen to ensure that the diode is operating at its Zener voltage but below its maximum rated current. For example, Fig. 6.18*c* shows that the 75 mA rating is exceeded in our circuit if the source voltage V1 is much greater than 12 V. Thus, the value of resistor R1 should be sized corresponding to the source voltage available, as we explore in Example 6.4.

### EXAMPLE 6.4

**Design a circuit based on the 1N750 Zener diode that runs on a single 9 V battery and provides a reference voltage of 4.7 V.**

The 1N750 has a maximum current rating of 75 mA, and a Zener voltage of 4.7 V. The voltage of a 9 V battery can vary slightly depending on its state of charge, but we neglect this for the present design.

A simple circuit such as the one shown in Fig. 6.19*a* is adequate for our purposes; the only issue is determining a suitable value for the resistor  $R_{ref}$ .

If 4.7 V is dropped across the diode, then  $9 - 4.7 = 4.3$  V must be dropped across  $R_{ref}$ . Thus,

$$R_{ref} = \frac{9 - V_{ref}}{I_{ref}} = \frac{4.3}{I_{ref}}$$

We determine  $R_{ref}$  by specifying a current value. We know that  $I_{ref}$  should not be allowed to exceed 75 mA for this diode, and large currents will discharge the battery more quickly. However, as seen in Fig. 6.19*b*, we cannot simply select  $I_{ref}$  arbitrarily; very low currents do not allow

(Continued on next page)

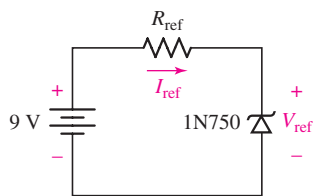

(a)

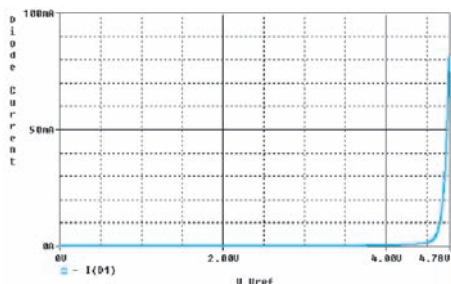

(b)

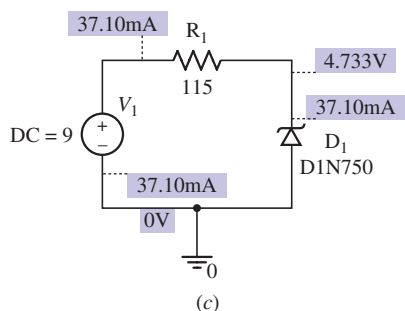

(c)

■ FIGURE 6.19 (a) A voltage reference circuit based on the 1N750 Zener diode. (b) Diode  $I$ - $V$  relationship. (c) PSpice simulation of the final design.

the diode to operate in the Zener breakdown region. In the absence of a detailed equation for the diode's current-voltage relationship (which is clearly nonlinear), we design for 50 percent of the maximum rated current as a rule of thumb. Thus,

$$R_{\text{ref}} = \frac{4.3}{0.0375} = 115 \Omega$$

Detailed “tweaking” can be obtained by performing a PSpice simulation of the final circuit, although we see from Fig. 6.19c that our first pass is reasonably close (within 1 percent) to our target value.

The basic Zener diode voltage reference circuit of Fig. 6.18a works very well in many situations, but we are limited somewhat in the value of the voltage depending on which Zener diodes are available. Also, we often find that the circuit shown is not well suited to applications requiring more than a few milliamperes of current. In such instances, we may use the Zener reference circuit in conjunction with a simple amplifier stage, as shown in Fig. 6.20. The result is a stable voltage that can be controlled by adjusting the value of either  $R_1$  or  $R_f$ , without having to switch to a different Zener diode.

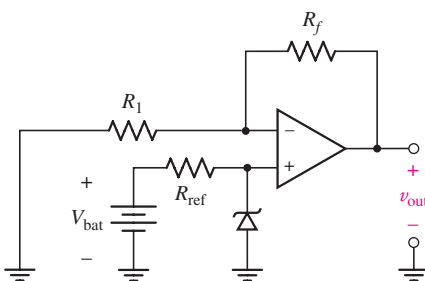

■ FIGURE 6.20 An op amp-based voltage source using a Zener voltage reference.

## PRACTICE

6.4 Design a circuit to provide a reference voltage of 6 V using a 1N750 Zener diode and a noninverting amplifier.

Ans: Using the circuit topology shown in Fig. 6.20, choose  $V_{\text{bat}} = 9 \text{ V}$ ,  $R_{\text{ref}} = 115 \Omega$ ,  $R_1 = 1 \text{ k}\Omega$ , and  $R_f = 268 \Omega$ .

## A Reliable Current Source

Consider the circuit shown in Fig. 6.21a, where  $V_{\text{ref}}$  is provided by a regulated voltage source such as the one shown in Fig. 6.19a. The reader may recognize this circuit as a simple inverting amplifier configuration, assuming we tap the output pin of the op amp. We can also use this circuit as a current source, however, where  $R_L$  represents a resistive load.

The input voltage  $V_{\text{ref}}$  appears across reference resistor  $R_{\text{ref}}$ , since the noninverting input of the op amp is connected to ground. With no current



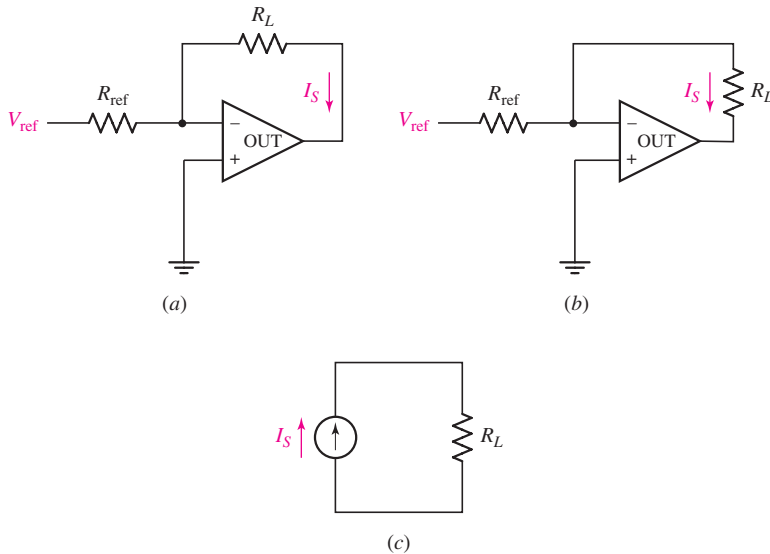

■ FIGURE 6.21 (a) An op amp-based current source, controlled by the reference voltage  $V_{\text{ref}}$ . (b) Circuit redrawn to highlight load. (c) Circuit model. Resistor  $R_L$  represents the Norton equivalent of an unknown passive load circuit.

flowing into the inverting input, the current flowing through the load resistor  $R_L$  is simply

$$I_s = \frac{V_{\text{ref}}}{R_{\text{ref}}}$$

In other words, the current supplied to  $R_L$  does not depend on its resistance—the primary attribute of an ideal current source. It is also worth noting that we are not tapping the output voltage of the op amp here as a quantity of interest. Instead, we may view the load resistor  $R_L$  as the Norton (or Thévenin) equivalent of some unknown passive load circuit, which receives power from the op amp circuit. Redrawing the circuit slightly as in Fig. 6.21b, we see that it has a great deal in common with the more familiar circuit of Fig. 6.21c. In other words, we may use this op amp circuit as an independent current source with essentially ideal characteristics, up to the maximum rated output current of the op amp selected.

## EXAMPLE 6.5

### Design a current source that will deliver 1 mA to an arbitrary resistive load.

Basing our design on the circuits of Fig. 6.20 and Fig. 6.21a, we know that the current through our load  $R_L$  will be given by

$$I_s = \frac{V_{\text{ref}}}{R_{\text{ref}}}$$

where values for  $V_{\text{ref}}$  and  $R_{\text{ref}}$  must be selected, and a circuit to provide  $V_{\text{ref}}$  must also be designed. If we use a 1N750 Zener diode in series with a 9 V

(Continued on next page)

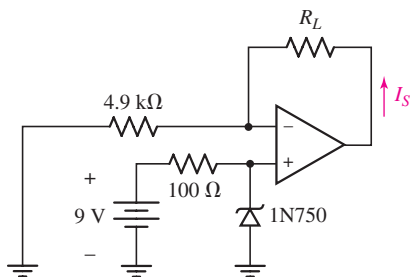

■ FIGURE 6.22 One possible design for the desired current source. Note the change in current direction from Fig. 6.21b.

battery and a  $100\ \Omega$  resistor, we know from Fig. 6.18b that a voltage of 4.9 V will exist across the diode. Thus,  $V_{\text{ref}} = 4.9\ \text{V}$ , dictating a value of  $4.9/10^{-3} = 4.9\ \text{k}\Omega$  for  $R_{\text{ref}}$ . The complete circuit is shown in Fig. 6.22.

Note that if we had assumed a diode voltage of 4.7 V instead, the error in our designed current would only be a few percent, well within the typical 5 to 10 percent tolerance in resistor values we might expect.

The only issue remaining is whether 1 mA can in fact be provided to any value of  $R_L$ . For the case of  $R_L = 0$ , the output of the op amp will be 4.9 V, which is not unreasonable. As the load resistor is increased, however, the op amp output voltage increases. Eventually we must reach some type of limit, as discussed in Sec. 6.5.

## PRACTICE

6.5 Design a current source capable of providing  $500\ \mu\text{A}$  to a resistive load.

Ans: See Fig. 6.23 for one possible solution.

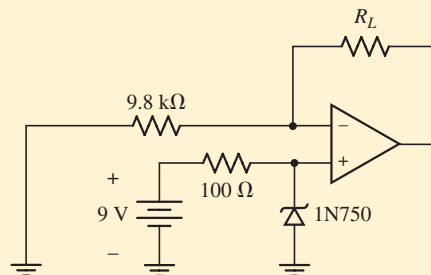

■ FIGURE 6.23 One possible solution to Practice Problem 6.5.

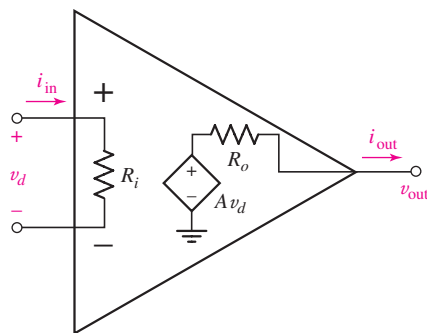

■ FIGURE 6.24 A more detailed model for the op amp.

## 6.5 PRACTICAL CONSIDERATIONS

### A More Detailed Op Amp Model

Reduced to its essentials, the op amp can be thought of as a voltage-controlled dependent voltage source. The dependent voltage source provides the output of the op amp, and the voltage on which it depends is applied to the input terminals. A schematic diagram of a reasonable model for a practical op amp is shown in Fig. 6.24; it includes a dependent voltage source with voltage gain  $A$ , an output resistance  $R_o$ , and an input resistance  $R_i$ . Table 6.3 gives typical values for these parameters for several types of commercially available op amps.

The parameter  $A$  is referred to as the *open-loop voltage gain* of the op amp, and is typically in the range of  $10^5$  to  $10^6$ . We notice that all of the op amps listed in Table 6.3 have extremely large open-loop voltage gain, especially compared to the voltage gain of 11 that characterized the noninverting amplifier circuit of Example 6.1. It is important to remember the distinction

TABLE 6.3 Typical Parameter Values for Several Types of Op Amps

Part Number	$\mu\text{A741}$	LM324	LF411	AD549K	OPA690
Description	General purpose	Low-power quad	Low-offset, low-drift JFET input	Ultralow input bias current	Wideband video frequency op amp
Open loop gain $A$	$2 \times 10^5$ V/V	$10^5$ V/V	$2 \times 10^5$ V/V	$10^6$ V/V	2800 V/V
Input resistance	2 M $\Omega$	*	1 T $\Omega$	10 T $\Omega$	190 k $\Omega$
Output resistance	75 $\Omega$	*	$\sim 1$ $\Omega$	$\sim 15$ $\Omega$	*
Input bias current	80 nA	45 nA	50 pA	75 fA	3 $\mu\text{A}$
Input offset voltage	1.0 mV	2.0 mV	0.8 mV	0.150 mV	$\pm 1.0$ mV
CMRR	90 dB	85 dB	100 dB	100 dB	65 dB
Slew rate	0.5 V/ $\mu\text{s}$	*	15 V/ $\mu\text{s}$	3 V/ $\mu\text{s}$	1800 V/ $\mu\text{s}$
PSpice Model	✓	✓	✓		

\* Not provided by manufacturer.  
 ✓ Indicates that a PSpice model is included in Orcad Capture CIS Lite Edition 16.3.

between the open-loop voltage gain of the op amp itself, and the **closed-loop voltage gain** that characterizes a particular op amp circuit. The “loop” in this case refers to an *external* path between the output pin and the inverting input pin; it can be a wire, a resistor, or another type of element, depending on the application.

The  $\mu\text{A741}$  is a very common op amp, originally produced by Fairchild Corporation in 1968. It is characterized by an open-loop voltage gain of 200,000, an input resistance of 2 M $\Omega$ , and an output resistance of 75  $\Omega$ . In order to evaluate how well the ideal op amp model approximates the behavior of this particular device, let’s revisit the inverting amplifier circuit of Fig. 6.3.

## EXAMPLE 6.6

Using the appropriate values for the  $\mu\text{A741}$  op amp in the model of Fig. 6.24, reanalyze the inverting amplifier circuit of Fig. 6.3.

We begin by replacing the ideal op amp symbol of Fig. 6.3 with the detailed model, resulting in the circuit shown in Fig. 6.25.

Note that we can no longer invoke the ideal op amp rules, since we are not using the ideal op amp model. Thus, we write two nodal equations:

$$0 = \frac{-v_d - v_{in}}{R_1} + \frac{-v_d - v_{out}}{R_f} + \frac{-v_d}{R_i}$$

$$0 = \frac{v_{out} + v_d}{R_f} + \frac{v_{out} - Av_d}{R_o}$$

Performing some straightforward but rather lengthy algebra, we eliminate  $v_d$  and combine these two equations to obtain the following

(Continued on next page)



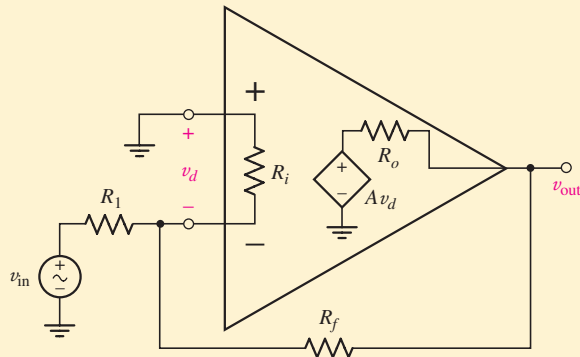

■ FIGURE 6.25 Inverting amplifier circuit drawn using detailed op amp model.

expression for  $v_{out}$  in terms of  $v_{in}$ :

$$v_{out} = \left[ \frac{R_o + R_f}{R_o - AR_f} \left( \frac{1}{R_1} + \frac{1}{R_f} + \frac{1}{R_i} \right) - \frac{1}{R_f} \right]^{-1} \frac{v_{in}}{R_1} \quad [15]$$

Substituting  $v_{in} = 5 \sin 3t$  mV,  $R_1 = 4.7$  k $\Omega$ ,  $R_f = 47$  k $\Omega$ ,  $R_o = 75$   $\Omega$ ,  $R_i = 2$  M $\Omega$ , and  $A = 2 \times 10^5$ , we obtain

$$v_{out} = -9.999448v_{in} = -49.99724 \sin 3t \quad \text{mV}$$

Upon comparing this to the expression found assuming an ideal op amp ( $v_{out} = -10v_{in} = -50 \sin 3t$  mV), we see that the ideal op amp is indeed a reasonably accurate model. Further, assuming an ideal op amp leads to a significant reduction in the algebra required to perform the circuit analysis. Note that if we allow  $A \rightarrow \infty$ ,  $R_o \rightarrow 0$ , and  $R_i \rightarrow \infty$ , Eq. [15] reduces to

$$v_{out} = -\frac{R_f}{R_1}v_{in}$$

which is what we derived earlier for the inverting amplifier when assuming the op amp was ideal.

## PRACTICE

6.6 Assuming a finite open-loop gain ( $A$ ), a finite input resistance ( $R_i$ ), and zero output resistance ( $R_o$ ), derive an expression for  $v_{out}$  in terms of  $v_{in}$  for the op amp circuit of Fig. 6.3.

Ans:  $v_{out}/v_{in} = -AR_fR_i/[ (1+A)R_1R_i + R_1R_f + R_fR_i ]$ .

## Derivation of the Ideal Op Amp Rules

We have seen that the ideal op amp can be a reasonably accurate model for the behavior of practical devices. However, using our more detailed model which includes a finite open-loop gain, finite input resistance, and nonzero output resistance, it is actually straightforward to derive the two ideal op amp rules.

Referring to Fig. 6.24, we see that the open circuit output voltage of a practical op amp can be expressed as

$$v_{out} = Av_d \quad [16]$$

Rearranging this equation, we find that  $v_d$ , sometimes referred to as the **differential input voltage**, can be written as

$$v_d = \frac{v_{\text{out}}}{A} \quad [17]$$

As we might expect, there are practical limits to the output voltage  $v_{\text{out}}$  that can be obtained from a real op amp. As described in the next section, we must connect our op amp to external dc voltage supplies in order to power the internal circuitry. These external voltage supplies represent the maximum value of  $v_{\text{out}}$ , and are typically in the range of 5 to 24 V. If we divide 24 V by the open-loop gain of the  $\mu\text{A}741$  ( $2 \times 10^5$ ), we obtain  $v_d = 120 \mu\text{V}$ . Although this is not the same as zero volts, such a small value compared to the output voltage of 24 V is *practically* zero. An ideal op amp would have infinite open-loop gain, resulting in  $v_d = 0$  regardless of  $v_{\text{out}}$ ; this leads to ideal op amp rule 2.

Ideal op amp rule 1 states that “No current ever flows into either input terminal.” Referring to Fig. 6.23, the input current of an op amp is simply

$$i_{\text{in}} = \frac{v_d}{R_i}$$

We have just determined that  $v_d$  is typically a very small voltage. As we can see from Table 6.3, the input resistance of an op amp is very large, ranging from the megaohms to the teraohms! Using the value of  $v_d = 120 \mu\text{V}$  from above and  $R_i = 2 \text{ M}\Omega$ , we compute an input current of 60 pA. This is an extremely small current, and we would require a specialized ammeter (known as a picoammeter) to measure it. We see from Table 6.3 that the typical input current (more accurately termed the **input bias current**) of a  $\mu\text{A}741$  is 80 nA, three orders of magnitude larger than our estimate. This is a shortcoming of the op amp model we are using, which is not designed to provide accurate values for input bias current. Compared to the other currents flowing in a typical op amp circuit, however, either value is essentially zero. More modern op amps (such as the AD549) have even lower input bias currents. Thus, we conclude that ideal op amp rule 1 is a fairly reasonable assumption.

From our discussion, it is clear that an ideal op amp has infinite open-loop voltage gain, and infinite input resistance. However, we have not yet considered the output resistance of the op amp and its possible effects on our circuit. Referring to Fig. 6.24, we see that

$$v_{\text{out}} = Av_d - R_o i_{\text{out}}$$

where  $i_{\text{out}}$  flows from the output pin of the op amp. Thus, a nonzero value of  $R_o$  acts to reduce the output voltage, an effect which becomes more pronounced as the output current increases. For this reason, an *ideal* op amp has an output resistance of zero ohms. The  $\mu\text{A}741$  has a maximum output resistance of  $75 \Omega$ , and more modern devices such as the AD549 have even lower output resistance.

## Common-Mode Rejection

The op amp is occasionally referred to as a *difference amplifier*, since the output is proportional to the voltage difference between the two input

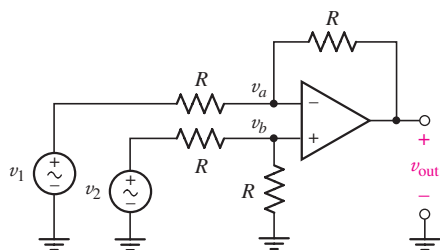

■ FIGURE 6.26 An op amp connected as a difference amplifier.

terminals. This means that if we apply identical voltages to both input terminals, we expect the output voltage to be zero. This ability of the op amp is one of its most attractive qualities, and is known as **common-mode rejection**. The circuit shown in Fig. 6.26 is connected to provide an output voltage

$$v_{\text{out}} = v_2 - v_1$$

If  $v_1 = 2 + 3 \sin 3t$  volts and  $v_2 = 2$  volts, we would expect the output to be  $-3 \sin 3t$  volts; the 2 V component common to  $v_1$  and  $v_2$  would not be amplified, nor does it appear in the output.

For practical op amps, we do in fact find a small contribution to the output in response to common-mode signals. In order to compare one op amp type to another, it is often helpful to express the ability of an op amp to reject common-mode signals through a parameter known as the common-mode rejection ratio, or **CMRR**. Defining  $v_{\text{ocm}}$  as the output obtained when both inputs are equal ( $v_1 = v_2 = v_{\text{CM}}$ ), we can determine  $A_{\text{CM}}$ , the common-mode gain of the op amp

$$A_{\text{CM}} = \left| \frac{v_{\text{ocm}}}{v_{\text{CM}}} \right|$$

We then define CMRR in terms of the ratio of differential-mode gain  $A$  to the common-mode gain  $A_{\text{CM}}$ , or

$$\text{CMRR} \equiv \left| \frac{A}{A_{\text{CM}}} \right| \quad [18]$$

although this is often expressed in decibels (dB), a logarithmic scale:

$$\text{CMRR}_{\text{(dB)}} \equiv 20 \log_{10} \left| \frac{A}{A_{\text{CM}}} \right| \quad \text{dB} \quad [19]$$

Typical values for several different op amps are provided in Table 6.3; a value of 100 dB corresponds to an absolute ratio of  $10^5$  for  $A$  to  $A_{\text{CM}}$ .

## Negative Feedback

We have seen that the open-loop gain of an op amp is very large, ideally infinite. In practical situations, however, its exact value can vary from the value specified by the manufacturer as typical. Temperature, for example, can have a number of significant effects on the performance of an op amp, so that the operating behavior in  $-20^\circ\text{C}$  weather may be significantly different from the behavior observed on a warm sunny day. Also, there are typically small variations between devices fabricated at different times. If we design a circuit in which the output voltage is the open-loop gain times the voltage at one of the input terminals, the output voltage could therefore be difficult to predict with a reasonable degree of precision, and might be expected to change depending on the ambient temperature.

A solution to such potential problems is to employ the technique of **negative feedback**, which is the process of subtracting a small portion of the output from the input. If some event changes the characteristics of the amplifier such that the output tries to increase, the input is decreasing at the same time. Too much negative feedback will prevent any useful amplification, but a small amount provides stability. An example of negative

feedback is the unpleasant sensation we feel as our hand draws near a flame. The closer we move toward the flame, the larger the negative signal sent from our hand. Overdoing the proportion of negative feedback, however, might cause us to abhor heat, and eventually freeze to death. **Positive feedback** is the process where some fraction of the output signal is added back to the input. A common example is when a microphone is directed toward a speaker—a very soft sound is rapidly amplified over and over until the system “screams.” Positive feedback generally leads to an unstable system.

All of the circuits considered in this chapter incorporate negative feedback through the presence of a resistor between the output pin and the inverting input. The resulting loop between the output and the input reduces the dependency of the output voltage on the actual value of the open-loop gain (as seen in Example 6.6). This obviates the need to measure the precise open-loop gain of each op amp we use, as small variations in  $A$  will not significantly impact the operation of the circuit. Negative feedback also provides increased stability in situations where  $A$  is sensitive to the op amp’s surroundings. For example, if  $A$  suddenly increases in response to a change in the ambient temperature, a larger feedback voltage is added to the inverting input. This acts to reduce the differential input voltage  $v_d$ , and therefore the change in output voltage  $Av_d$  is smaller. We should note that the closed-loop circuit gain is always less than the open-loop device gain; this is the price we pay for stability and reduced sensitivity to parameter variations.



## Saturation

So far, we have treated the op amp as a purely linear device, assuming that its characteristics are independent of the way in which it is connected in a circuit. In reality, it is necessary to supply power to an op amp in order to run the internal circuitry, as shown in Fig. 6.27. A positive supply, typically in the range of 5 to 24 V dc, is connected to the terminal marked  $V^+$ , and a negative supply of equal magnitude is connected to the terminal marked  $V^-$ . There are also a number of applications where a single voltage supply is acceptable, as well as situations where the two voltage magnitudes may be unequal. The op amp manufacturer will usually specify a maximum power supply voltage, beyond which damage to the internal transistors will occur.

The power supply voltages are a critical choice when designing an op amp circuit, because they represent the maximum possible output voltage of the op amp.<sup>3</sup> For example, consider the op amp circuit shown in Fig. 6.26, now connected as a noninverting amplifier having a gain of 10. As shown in the PSpice simulation in Fig. 6.28, we do in fact observe linear behavior from the op amp, but only in the range of  $\pm 1.71$  V for the input voltage. Outside of this range, the output voltage is no longer proportional to the input, reaching a peak magnitude of 17.6 V. This important nonlinear effect is known as **saturation**, which refers to the fact that further increases in the input voltage do not result in a change in the output voltage. This phenomenon refers to the fact that the output of a real op amp cannot exceed its

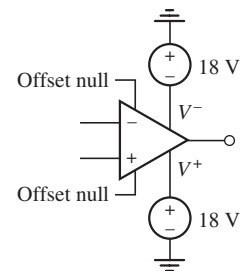

■ FIGURE 6.27 Op amp with positive and negative voltage supplies connected. Two 18 V supplies are used as an example; note the polarity of each source.

(3) In practice, we find the maximum output voltage is slightly less than the supply voltage by as much as a volt or so.

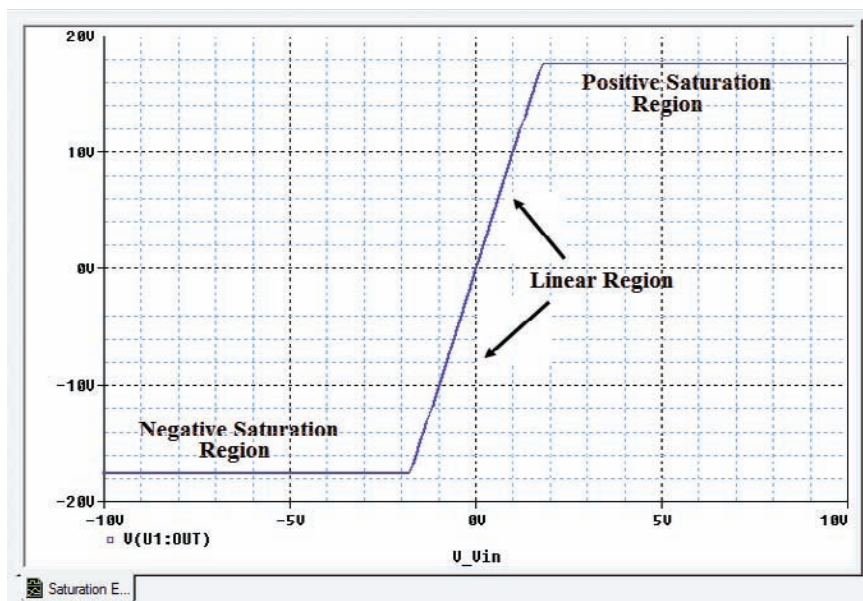

■ FIGURE 6.28 Simulated input-output characteristics of a  $\mu A741$  connected as a noninverting amplifier with a gain of 10, and powered by  $\pm 18$  V supplies.

supply voltages. For example, if we choose to run the op amp with a  $+9$  V supply and a  $-5$  V supply, then our output voltage will be limited to the range of  $-5$  to  $+9$  V. The output of the op amp is a linear response bounded by the positive and negative saturation regions, and as a general rule, we try to design our op amp circuits so that we do not accidentally enter the saturation region. This requires us to select the operating voltage carefully based on the closed-loop gain and maximum expected input voltage.

## Input Offset Voltage

As we are discovering, there are a number of practical considerations to keep in mind when working with op amps. One particular nonideality worth mentioning is the tendency for real op amps to have a nonzero output even when the two input terminals are shorted together. The value of the output under such conditions is known as the offset voltage, and the input voltage required to reduce the output to zero is referred to as the *input offset voltage*. Referring to Table 6.3, we see that typical values for the input offset voltage are on the order of a few millivolts or less.

Most op amps are provided with two pins marked either “offset null” or “balance.” These terminals can be used to adjust the output voltage by connecting them to a variable resistor. A variable resistor is a three-terminal device commonly used for such applications as volume controls on radios. The device comes with a knob that can be rotated to select the actual value of resistance, and has three terminals. Measured between the two extreme terminals, its resistance is fixed regardless of the position of the knob. Using the middle terminal and one of the end terminals creates a resistor whose value depends on the knob position. Figure 6.29 shows a typical circuit used to adjust the output voltage of an op amp; the manufacturer’s data sheet may suggest alternative circuitry for a particular device.

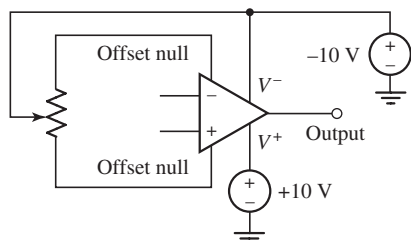

■ FIGURE 6.29 Suggested external circuitry for obtaining a zero output voltage. The  $\pm 10$  V supplies are shown as an example; the actual supply voltages used in the final circuit would be chosen in practice.



## Slew Rate

Up to now, we have tacitly assumed that the op amp will respond equally well to signals of any frequency, although perhaps we would not be surprised to find that in practice there is some type of limitation in this regard. Since we know that op amp circuits work well at dc, which is essentially zero frequency, it is the performance as the signal frequency is *increased* that we must consider. One measure of the frequency performance of an op amp is its *slew rate*, which is the rate at which the output voltage can respond to changes in the input; it is most often expressed in  $V/\mu s$ . The typical slew rate specification for several commercially available devices is provided in Table 6.3, showing values on the order of a few volts per microsecond. One notable exception is the OPA690, which is designed as a high-speed op amp for video applications requiring operation at several hundred MHz. As can be seen, a respectable slew rate of  $1800 V/\mu s$  is not unrealistic for this device, although its other parameters, particularly input bias current and CMRR, suffer somewhat as a result.

The PSpice simulations shown in Fig. 6.30 illustrate the degradation in performance of an op amp due to slew rate limitations. The circuit simulated is an LF411 configured as a noninverting amplifier with a gain of 2 and powered by  $\pm 15 V$  supplies. The input waveform is shown in green, and has

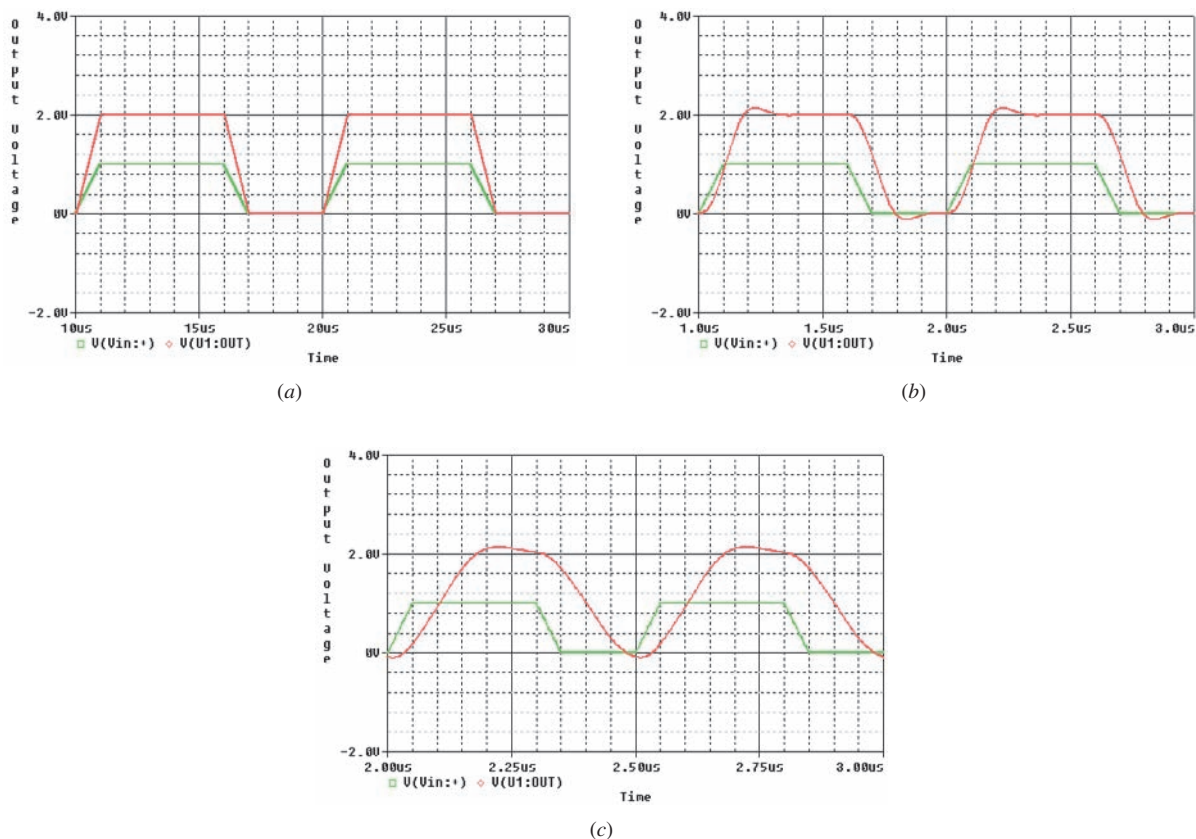

■ FIGURE 6.30 Simulated performance of an LF411 op amp connected as a noninverting amplifier having a gain of 2, with  $\pm 15 V$  supplies and a pulsed input waveform. (a) Rise and fall times =  $1 \mu s$ , pulse width =  $5 \mu s$ ; (b) rise and fall times =  $100 ns$ , pulse width =  $500 ns$ ; (c) rise and fall times =  $50 ns$ , pulse width =  $250 ns$ .

a peak voltage of 1 V; the output voltage is shown in red. The simulation of Fig. 6.30a corresponds to a rise and fall time of 1  $\mu\text{s}$  which, although a short time span for humans, is easily coped with by the LF411. As the rise and fall times are decreased by a factor of 10 to 100 ns (Fig. 6.30b), we begin to see that the LF411 is having a small difficulty in tracking the input. In the case of a 50 ns rise and fall time (Fig. 6.30c), we see that not only is there a significant delay between the output and the input, but the waveform is noticeably distorted as well—not a good feature of an amplifier. This observed behavior is consistent with the typical slew rate of 15 V/ $\mu\text{s}$  specified in Table 6.3, which indicates that the output might be expected to require roughly 130 ns to change from 0 to 2 V (or 2 V to 0 V).

## Packaging

Modern op amps are available in a number of different types of packages. Some styles are better suited to high temperatures, and there are a variety of different ways to mount ICs on printed-circuit boards. Figure 6.31 shows several different styles of the LM741, manufactured by National Semiconductor. The label “NC” next to a pin means “no connection.” The package styles shown in the figure are standard configurations, and are used for a large number of different integrated circuits; occasionally there are more pins available on a package than required.

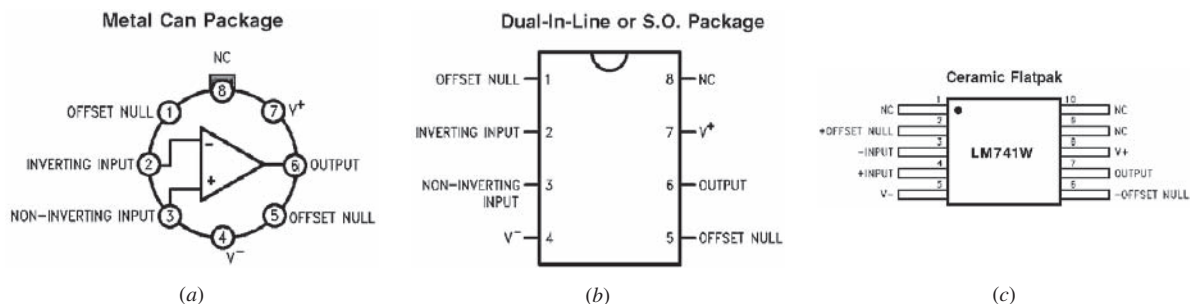

■ FIGURE 6.31 Several different package styles for the LM741 op amp: (a) metal can; (b) dual-in-line package; (c) ceramic flatpak. (Copyright © 2011 National Semiconductor Corporation ([www.national.com](http://www.national.com)). All rights reserved. Used with permission.)

## COMPUTER-AIDED ANALYSIS

As we have just seen, PSpice can be enormously helpful in predicting the output of an op amp circuit, especially in the case of time-varying inputs. We will find, however, that our ideal op amp model agrees fairly well with PSpice simulations as a general rule.



When performing a PSpice simulation of an op amp circuit, we must be careful to remember that positive and negative dc supplies must be connected to the device (with the exception of the LM324, which is designed to be a single-supply op amp). Although the model shows the offset null pins used to zero the output voltage, PSpice does not build in any offset, so these pins are typically left floating (unconnected).

Table 6.3 shows the different op amp part numbers available in the Evaluation version of PSpice; other models are available in the commercial version of the software and from some manufacturers.

## EXAMPLE 6.7

Simulate the circuit of Fig. 6.3 using PSpice. Determine the point(s) at which saturation begins if  $\pm 15$  V dc supplies are used to power the device. Compare the gain calculated by PSpice to what was predicted using the ideal op amp model.

We begin by drawing the inverting amplifier circuit of Fig. 6.3 using the schematic capture tool as shown in Fig. 6.32. Note that two separate 15 V dc supplies are required to power the op amp.

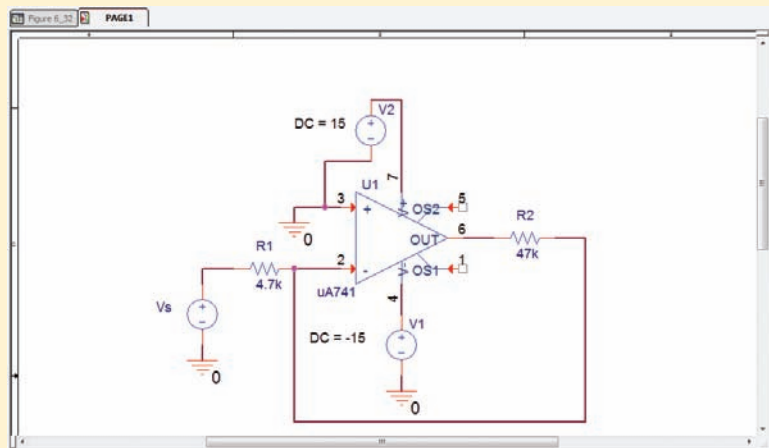

FIGURE 6.32 The inverting amplifier of Fig. 6.3 drawn using a  $\mu$ A741 op amp.

Our previous analysis using an ideal op amp model predicted a gain of  $-10$ . With an input of  $5 \sin 3t$  mV, this led to an output voltage of  $-50 \sin 3t$  mV. However, an implicit assumption in the analysis was that *any* voltage input would be amplified by a factor of  $-10$ . Based on practical considerations, we expect this to be true for *small* input voltages, but the output will eventually saturate to a value comparable to the corresponding power supply voltage.

We perform a dc sweep from  $-2$  to  $+2$  volts, as shown in Fig. 6.33; this is a slightly larger range than the supply voltage divided by the gain, so we expect our results to include the positive and negative saturation regions.

Using the cursor tool on the simulation results shown in Fig. 6.34a, the input-output characteristic of the amplifier is indeed linear over a wide input range, corresponding approximately to  $-1.45 < V_s < +1.45$  V (Fig. 6.34b): This range is slightly less than the range defined by dividing the positive and negative supply voltages by the gain. Outside this range, the output of the op amp saturates, with only a slight dependence on the input voltage. In the two saturation regions, then, the circuit does not perform as a linear amplifier.

Increasing the number of cursor digits (**Tools, Options, Number of Cursor Digits**) to 10, we find that at an input voltage of  $V_s = 1.0$  V, the

(Continued on next page)

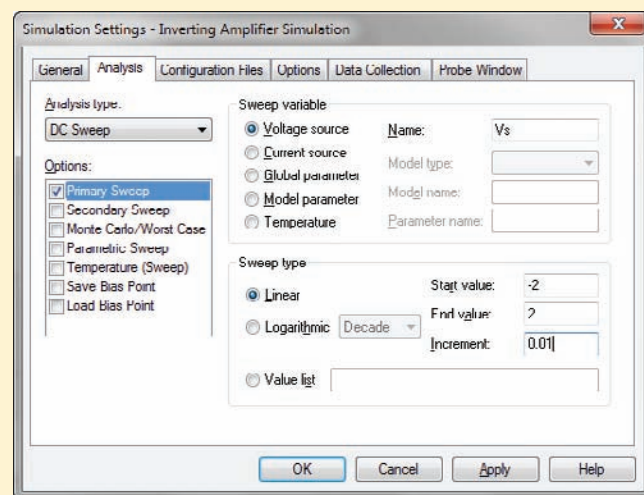

■ FIGURE 6.33 DC sweep setup window.

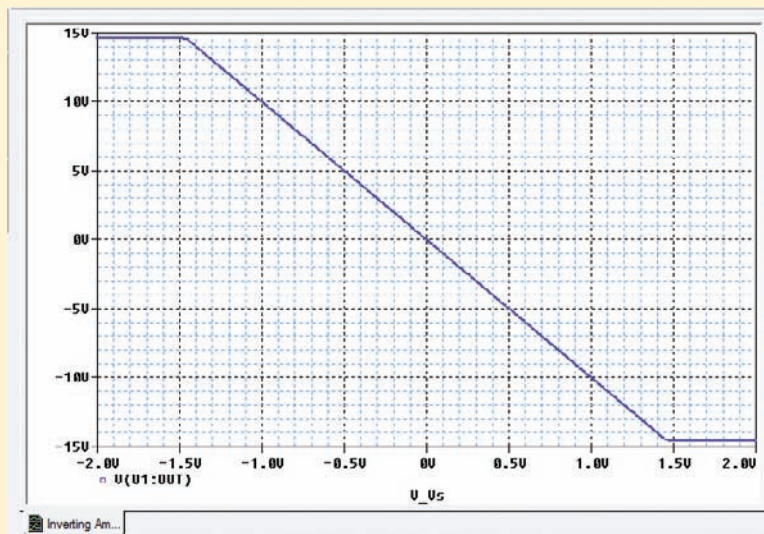

(a)

Trace	Cursor1	Cursor2	Diff
X Value	-1.454	1.454	-2.908
V(U1:OUT)	14.51	-14.51	29.02

(b)

■ FIGURE 6.34 (a) Output voltage of the inverting amplifier circuit, with the onset of saturation identified with the cursor tool. (b) Close-up of the cursor window.

output voltage is  $-9.99548340$ , slightly less than the value of  $-10$  predicted from the ideal op amp model, and slightly different from the value of  $-9.999448$  obtained in Example 6.6 using an analytical model. Still, the results predicted by the PSpice  $\mu A741$  model are within a few

hundredths of a percent of either analytical model, demonstrating that the ideal op amp model is indeed a remarkably accurate approximation for modern operational amplifier integrated circuits.

### PRACTICE

6.7 Simulate the remaining op amp circuits described in this chapter, and compare the results to those predicted using the ideal op amp model.

## 6.6 COMPARATORS AND THE INSTRUMENTATION AMPLIFIER

### The Comparator

Every op amp circuit we have discussed up to now has featured an electrical connection between the output pin and the inverting input pin. This is known as *closed-loop* operation, and is used to provide negative feedback as discussed previously. Closed loop is the preferred method of using an op amp as an amplifier, as it serves to isolate the circuit performance from variations in the open-loop gain that arise from changes in temperature or manufacturing differences. There are a number of applications, however, where it is advantageous to use an op amp in an *open-loop* configuration. Devices intended for such applications are frequently referred to as **comparators**, as they are designed slightly differently from regular op amps in order to improve their speed in open-loop operation.

Figure 6.35a shows a simple comparator circuit where a 2.5 V reference voltage is connected to the noninverting input, and the voltage being compared ( $v_{in}$ ) is connected to the inverting input. Since the op amp has a very large open-loop gain  $A$  ( $10^5$  or greater, typically, as seen in Table 6.3), it does not take a large voltage difference between the input terminals to drive it into saturation. In fact, a differential input voltage as small as the supply voltage divided by  $A$  is required—approximately  $\pm 120 \mu\text{V}$  in the case of the circuit in Fig. 6.35a and  $A = 10^5$ . The distinctive output of the comparator circuit is shown in Fig. 6.35b, where the response swings

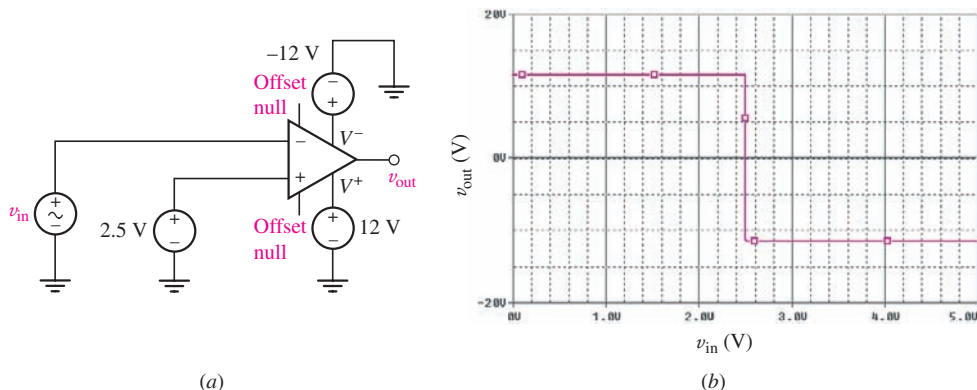
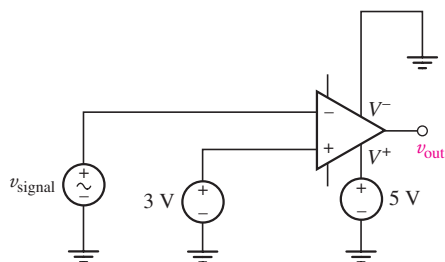

FIGURE 6.35 (a) An example comparator circuit with a 2.5 V reference voltage. (b) Graph of input-output characteristic.

between positive and negative saturation, with essentially no linear “amplification” region. Thus, a positive 12 V output from the comparator indicates that the input voltage is *less than* the reference voltage, and a negative 12 V output indicates an input voltage *greater than* the reference. Opposite behavior is obtained if we connect the reference voltage to the inverting input instead.

### EXAMPLE 6.8



■ FIGURE 6.36 One possible design for the required circuit.

**Design a circuit that provides a “logic 1” 5 V output if a certain voltage signal drops below 3 V, and zero volts otherwise.**

Since we want the output of our comparator to swing between 0 and 5 V, we will use an op amp with a single-ended +5 V supply, connected as shown in Fig. 6.36. We connect a +3 V reference voltage to the noninverting input, which may be provided by two 1.5 V batteries in series, or a suitable Zener diode reference circuit. The input voltage signal (designated  $v_{\text{signal}}$ ) is then connected to the inverting input. In reality, the saturation voltage range of a comparator circuit will be slightly less than that of the supply voltages, so that some adjustment may be required in conjunction with simulation or testing.

### PRACTICE

6.8 Design a circuit that provides a 12 V output if a certain voltage ( $v_{\text{signal}}$ ) exceeds 0 V, and a  $-2$  V output otherwise.

Ans: One possible solution is shown in Fig. 6.37.

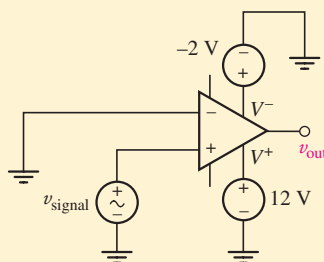

■ FIGURE 6.37 One possible solution to Practice Problem 6.8.

## The Instrumentation Amplifier

The basic comparator circuit acts on the voltage difference between the two input terminals to the device, although it does not technically amplify signals as the output is not proportional to the input. The difference amplifier of Fig. 6.10 also acts on the voltage difference between the inverting and noninverting inputs, and as long as care is taken to avoid saturation, *does* provide an output directly proportional to this difference. When dealing with a very small input voltage, however, a better alternative is a device

known as an *instrumentation amplifier*, which is actually three op amp devices in a single package.

An example of the common instrumentation amplifier configuration is shown in Fig. 6.38a, and its symbol is shown in Fig. 6.38b. Each input is fed directly into a voltage follower stage, and the output of both voltage followers is fed into a difference amplifier stage. It is particularly well suited to applications where the input voltage signal is very small (for example, on the order of millivolts), such as that produced by thermocouples or strain gauges, and where a significant common-mode noise signal of several volts may be present.

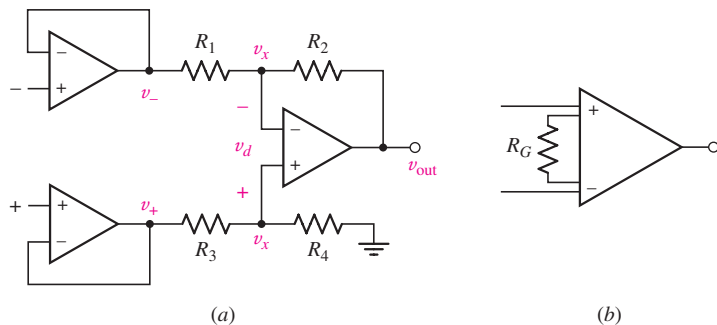

■ FIGURE 6.38 (a) The basic instrumentation amplifier. (b) Commonly used symbol.

If components of the instrumentation amplifier are fabricated all on the same silicon “chip,” then it is possible to obtain well-matched device characteristics and to achieve precise ratios for the two sets of resistors. In order to maximize the CMRR of the instrumentation amplifier, we expect  $R_4/R_3 = R_2/R_1$ , so that equal amplification of common-mode components of the input signals is obtained. To explore this further, we identify the voltage at the output of the top voltage follower as “ $v_-$ ,” and the voltage at the output of the bottom voltage follower as “ $v_+$ .” Assuming all three op amps are ideal and naming the voltage at either input of the difference stage  $v_x$ , we may write the following nodal equations:

$$\frac{v_x - v_-}{R_1} + \frac{v_x - v_{\text{out}}}{R_2} = 0 \quad [20]$$

and

$$\frac{v_x - v_+}{R_3} + \frac{v_x}{R_4} = 0 \quad [21]$$

Solving Eq. [21] for  $v_x$ , we find that

$$v_x = \frac{v_+}{1 + R_3/R_4} \quad [22]$$

and upon substituting into Eq. [20], obtain an expression for  $v_{\text{out}}$  in terms of the input:

$$v_{\text{out}} = \frac{R_4}{R_3} \left( \frac{1 + R_2/R_1}{1 + R_4/R_3} \right) v_+ - \frac{R_2}{R_1} v_- \quad [23]$$

From Eq. [23] it is clear that the general case allows amplification of common-mode components to the two inputs. In the specific case where

$R_4/R_3 = R_2/R_1 = K$ , however, Eq. [23] reduces to  $K(v_+ - v_-) = Kv_d$ , so that (assuming ideal op amps) only the difference is amplified and the gain is set by the resistor ratio. Since these resistors are internal to the instrumentation amplifier and not accessible to the user, devices such as the AD622 allow the gain to be set anywhere in the range of 1 to 1000 by connecting an external resistor between two pins (shown as  $R_G$  in Fig. 6.38b).

## SUMMARY AND REVIEW

In this chapter we introduced a new circuit element—a three-terminal device—called the operational amplifier (or more commonly, the *op amp*). In many circuit analysis situations it is approximated as an ideal device, which leads to two rules that are applied. We studied several op amp circuits in detail, including the *inverting amplifier* with gain  $R_f/R_1$ , the *noninverting amplifier* with gain  $1 + R_f/R_1$ , and the *summing amplifier*. We were also introduced to the *voltage follower* and the *difference amplifier*, although the analysis of these two circuits was left for the reader. The concept of cascaded stages was found to be particularly useful, as it allows a design to be broken down into distinct units, each of which has a specific function. We took a slight detour and introduced briefly a two-terminal nonlinear circuit element, the *Zener diode*, as it provides a practical and straightforward voltage reference. We then used this element to construct practical voltage and current sources using op amps, removing some of the mystery as to their origins.

Modern op amps have nearly ideal characteristics, as we found when we opted for a more detailed model based on a dependent source. Still, nonidealities are encountered occasionally, so we considered the role of *negative feedback* in reducing the effect of temperature and manufacturing-related variations in various parameters, *common-mode rejection*, and *saturation*. One of the most interesting nonideal characteristics of any op amp is *slew rate*. By simulating three different cases, we were able to see how the output voltage can struggle to follow the form of the input voltage signal once its frequency becomes high enough. We concluded the chapter with two special cases: the *comparator*, which intentionally makes use of our ability to saturate a practical (nonideal) op amp, and the instrumentation amplifier, which is routinely used to amplify very small voltages.

This is a good point to pause, take a breath, and recap some of the key points. At the same time, we will highlight relevant examples as an aid to the reader.

- There are two fundamental rules that must be applied when analyzing *ideal* op amp circuits:
  1. No current ever flows into either input terminal. (Example 6.1)
  2. No voltage ever exists between the input terminals.
- Op amp circuits are usually analyzed for an output voltage in terms of some input quantity or quantities. (Examples 6.1, 6.2)
- Nodal analysis is typically the best choice in analyzing op amp circuits, and it is usually better to begin at the input, and work toward the output. (Examples 6.1, 6.2)



- ❑ The output current of an op amp cannot be assumed; it must be found after the output voltage has been determined independently. (Example 6.2)

- ❑ The gain of an inverting op amp circuit is given by the equation

$$v_{\text{out}} = -\frac{R_f}{R_1} v_{\text{in}}$$

- ❑ The gain of a noninverting op amp circuit is given by the equation

$$v_{\text{out}} = \left(1 + \frac{R_f}{R_1}\right) v_{\text{in}}$$

(Example 6.1)

- ❑ Cascaded stages may be analyzed one stage at a time to relate the output to the input. (Example 6.3)
- ❑ Zener diodes provide a convenient voltage reference. They are not symmetric, however, meaning the two terminals are not interchangeable. (Example 6.4)
- ❑ Op amps can be used to construct current sources which are independent of the load resistance over a specific current range. (Example 6.5)
- ❑ A resistor is almost always connected from the output pin of an op amp to its inverting input pin, which incorporates negative feedback into the circuit for increased stability.
- ❑ The ideal op amp model is based on the approximation of infinite open-loop gain  $A$ , infinite input resistance  $R_i$ , and zero output resistance  $R_o$ . (Example 6.6)
- ❑ In practice, the output voltage range of an op amp is limited by the supply voltages used to power the device. (Example 6.7)
- ❑ Comparators are op amps designed to be driven into saturation. These circuits operate in open loop, and hence have no external feedback resistor. (Example 6.8)

## READING FURTHER

Two very readable books which deal with a variety of op amp applications are:

R. Mancini (ed.), *Op Amps Are For Everyone*, 2nd ed. Amsterdam: Newnes, 2003. Also available on the Texas Instruments website ([www.ti.com](http://www.ti.com)).

W. G. Jung, *Op Amp Cookbook*, 3rd ed. Upper Saddle River, N.J.: Prentice-Hall, 1997.

Characteristics of Zener and other types of diodes are covered in Chapter 1 of

W. H. Hayt, Jr., and G. W. Neudeck, *Electronic Circuit Analysis and Design*, 2nd ed. New York: Wiley, 1995.

One of the first reports of the implementation of an “operational amplifier” can be found in

J. R. Ragazzini, R. M. Randall, and F. A. Russell, “Analysis of problems in dynamics by electronic circuits,” *Proceedings of the IRE* **35**(5), 1947, pp. 444–452.

And an early applications guide for the op amp can be found on the Analog Devices, Inc. website ([www.analog.com](http://www.analog.com)):

George A. Philbrick Researches, Inc., *Applications Manual for Computing Amplifiers for Modelling, Measuring, Manipulating & Much Else*.  
Norwood, Mass.: Analog Devices, 1998.

## EXERCISES

### 6.2 The Ideal Op Amp

- For the op amp circuit shown in Fig. 6.39, calculate  $v_{out}$  if (a)  $R_1 = R_2 = 100 \Omega$  and  $v_{in} = 5 \text{ V}$ ; (b)  $R_2 = 200R_1$  and  $v_{in} = 1 \text{ V}$ ; (c)  $R_1 = 4.7 \text{ k}\Omega$ ,  $R_2 = 47 \text{ k}\Omega$ , and  $v_{in} = 20 \sin 5t \text{ V}$ .

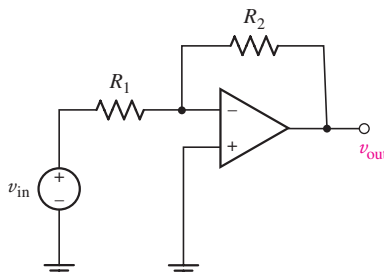

■ FIGURE 6.39

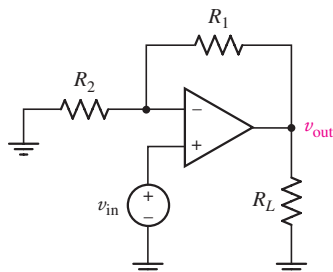

■ FIGURE 6.40

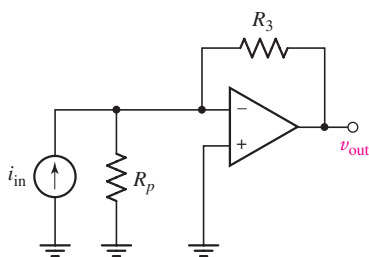

■ FIGURE 6.41

- Determine the power dissipated by a  $100 \Omega$  resistor connected between ground and the output pin of the op amp of Fig. 6.39 if  $v_{in} = 4 \text{ V}$  and (a)  $R_1 = 2R_2$ ; (b)  $R_1 = 1 \text{ k}\Omega$  and  $R_2 = 22 \text{ k}\Omega$ ; (c)  $R_1 = 100 \Omega$  and  $R_2 = 101 \Omega$ .
- Connect a  $1 \Omega$  resistor between ground and the output terminal of the op amp of Fig. 6.39, and sketch  $v_{out}(t)$  if (a)  $R_1 = R_2 = 10 \Omega$  and  $v_{in} = 5 \sin 10t \text{ V}$ ; (b)  $R_1 = 0.2R_2 = 1 \text{ k}\Omega$ , and  $v_{in} = 5 \cos 10t \text{ V}$ ; (c)  $R_1 = 10 \Omega$ ,  $R_2 = 200 \Omega$ , and  $v_{in} = 1.5 + 5e^{-t} \text{ V}$ .
- For the circuit of Fig. 6.40, calculate  $v_{out}$  if (a)  $R_1 = R_2 = 100 \text{ k}\Omega$ ,  $R_L = 100 \Omega$ , and  $v_{in} = 5 \text{ V}$ ; (b)  $R_1 = 0.1R_2$ ,  $R_L = \infty$ , and  $v_{in} = 2 \text{ V}$ ; (c)  $R_1 = 1 \text{ k}\Omega$ ,  $R_2 = 0$ ,  $R_L = 1 \Omega$ , and  $v_{in} = 43.5 \text{ V}$ .
- (a) Design a circuit which converts a voltage  $v_1(t) = 9 \cos 5t \text{ V}$  into  $9 \sin 5t \text{ V}$ . (b) Verify your design by analyzing the final circuit.
- A certain load resistor requires a constant  $5 \text{ V}$  dc supply. Unfortunately, its resistance value changes with temperature. Design a circuit which supplies the requisite voltage if only  $9 \text{ V}$  batteries and standard 10% tolerance resistor values are available.
- For the circuit of Fig. 6.40,  $R_1 = R_L = 50 \Omega$ . Calculate the value of  $R_2$  required to deliver  $5 \text{ W}$  to  $R_L$  if  $V_{in}$  equals (a)  $5 \text{ V}$ ; (b)  $1.5 \text{ V}$ . (c) Repeat parts (a) and (b) if  $R_L$  is reduced to  $22 \Omega$ .
- Calculate  $v_{out}$  as labeled in the schematic of Fig. 6.41 if (a)  $i_{in} = 1 \text{ mA}$ ,  $R_p = 2.2 \text{ k}\Omega$ , and  $R_3 = 1 \text{ k}\Omega$ ; (b)  $i_{in} = 2 \text{ A}$ ,  $R_p = 1.1 \Omega$ , and  $R_3 = 8.5 \Omega$ . (c) For each case, state whether the circuit is wired as a noninverting or an inverting amplifier. *Explain your reasoning.*
- (a) Design a circuit using only a single op amp which adds two voltages  $v_1$  and  $v_2$  and provides an output voltage twice their sum (i.e.,  $v_{out} = 2v_1 + 2v_2$ ). (b) Verify your design by analyzing the final circuit.
- (a) Design a circuit that provides a current  $i$  which is equal in magnitude to the sum of three input voltages  $v_1$ ,  $v_2$ , and  $v_3$ . (Compare volts to amperes.) (b) Verify your design by analyzing the final circuit.

DP

DP

DP

DP

11. (a) Design a circuit that provides a voltage  $v_{\text{out}}$  which is equal to the difference between two voltages  $v_2$  and  $v_1$  (i.e.,  $v_{\text{out}} = v_2 - v_1$ ), if you have only the following resistors from which to choose: two  $1.5 \text{ k}\Omega$  resistors, four  $6 \text{ k}\Omega$  resistors, or three  $500 \Omega$  resistors. (b) Verify your design by analyzing the final circuit.
12. Analyze the circuit of Fig. 6.42 and determine a value for  $V_1$ , which is referenced to ground.

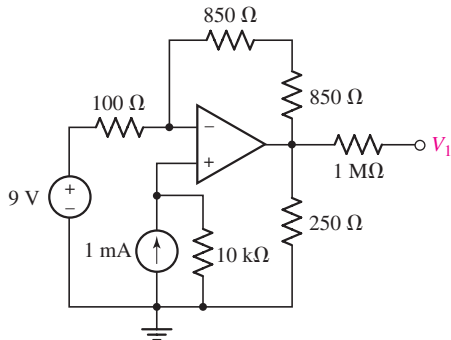

FIGURE 6.42

13. Derive an expression for  $v_{\text{out}}$  as a function of  $v_1$  and  $v_2$  for the circuit represented in Fig. 6.43.

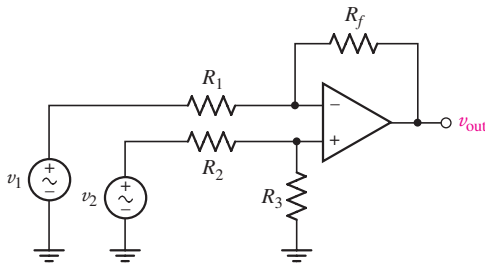

FIGURE 6.43

14. Explain what is wrong with each diagram in Fig. 6.44 if the two op amps are known to be perfectly ideal.

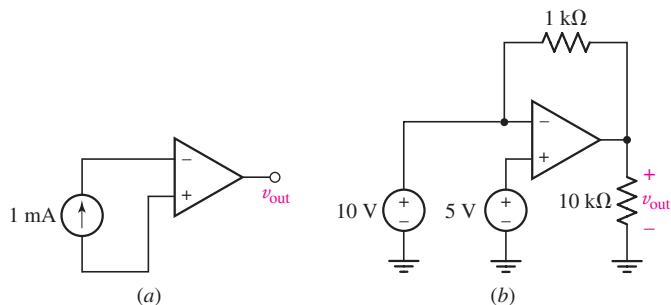

FIGURE 6.44

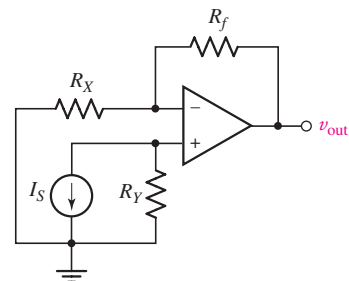
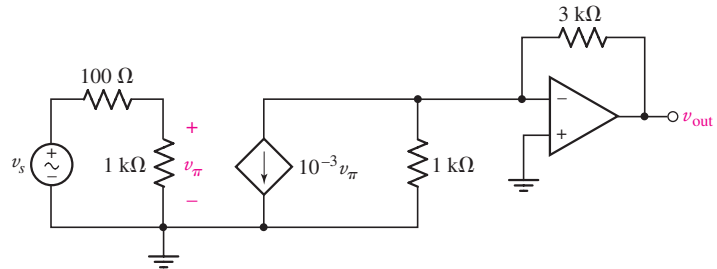

FIGURE 6.45

15. For the circuit depicted in Fig. 6.45, calculate  $v_{\text{out}}$  if  $I_s = 2 \text{ mA}$ ,  $R_Y = 4.7 \text{ k}\Omega$ ,  $R_X = 1 \text{ k}\Omega$ , and  $R_f = 500 \Omega$ .
16. Consider the amplifier circuit shown in Fig. 6.45. What value of  $R_f$  will yield  $v_{\text{out}} = 2 \text{ V}$  when  $I_s = 10 \text{ mA}$  and  $R_Y = 2R_X = 500 \Omega$ ?

17. With respect to the circuit shown in Fig. 6.46, calculate  $v_{out}$  if  $v_s$  equals  
 (a)  $2 \cos 100t$  mV; (b)  $2 \sin(4t + 19^\circ)$  V.



■ FIGURE 6.46

### 6.3 Cascaded Stages

18. Calculate  $v_{out}$  as labeled in the circuit of Fig. 6.47 if  $R_x = 1$  k $\Omega$ .

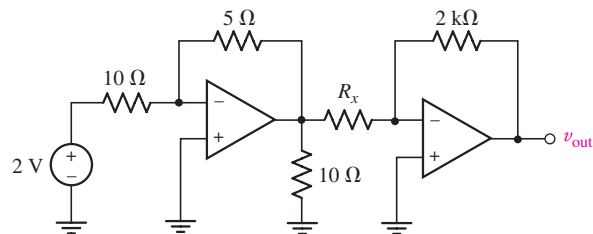

■ FIGURE 6.47

19. For the circuit of Fig. 6.47, determine the value of  $R_x$  that will result in a value of  $v_{out} = 10$  V.  
 20. Referring to Fig. 6.48, sketch  $v_{out}$  as a function of (a)  $v_{in}$  over the range of  $-2$  V  $\leq v_{in} \leq +2$  V, if  $R_4 = 2$  k $\Omega$ ; (b)  $R_4$  over the range of  $1$  k $\Omega \leq R_4 \leq 10$  k $\Omega$ , if  $v_{in} = 300$  mV.

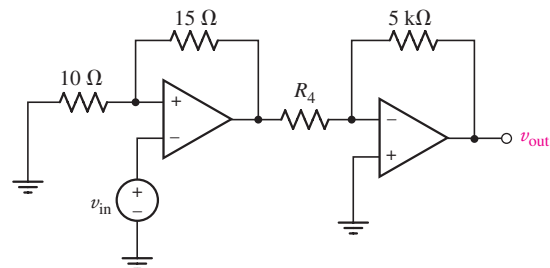

■ FIGURE 6.48

21. Obtain an expression for  $v_{out}$  as labeled in the circuit of Fig. 6.49 if  $v_1$  equals  
 (a) 0 V; (b) 1 V; (c)  $-5$  V; (d)  $2 \sin 100t$  V.

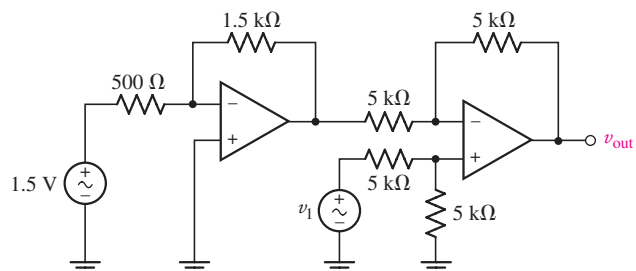

■ FIGURE 6.49

22. The 1.5 V source of Fig. 6.49 is disconnected, and the output of the circuit shown in Fig. 6.48 is connected to the left-hand terminal of the 500  $\Omega$  resistor instead. Calculate  $v_{\text{out}}$  if  $R_4 = 2 \text{ k}\Omega$  and (a)  $v_{\text{in}} = 2 \text{ V}$ ,  $v_1 = 1 \text{ V}$ ; (b)  $v_{\text{in}} = 1 \text{ V}$ ,  $v_1 = 0$ ; (c)  $v_{\text{in}} = 1 \text{ V}$ ,  $v_1 = -1 \text{ V}$ .
23. For the circuit shown in Fig. 6.50, compute  $v_{\text{out}}$  if (a)  $v_1 = 2v_2 = 0.5v_3 = 2.2 \text{ V}$  and  $R_1 = R_2 = R_3 = 50 \text{ k}\Omega$ ; (b)  $v_1 = 0$ ,  $v_2 = -8 \text{ V}$ ,  $v_3 = 9 \text{ V}$ , and  $R_1 = 0.5R_2 = 0.4R_3 = 100 \text{ k}\Omega$ .

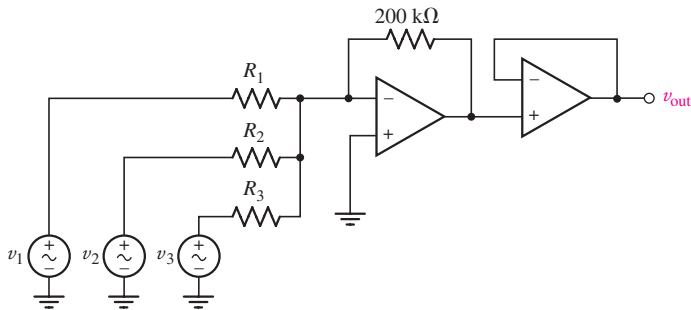

■ FIGURE 6.50

24. (a) Design a circuit which will add the voltages produced by three separate pressure sensors, each in the range of  $0 \leq v_{\text{sensor}} \leq 5 \text{ V}$ , and produce a positive voltage  $v_{\text{out}}$  linearly correlated to the voltage sum such that  $v_{\text{out}} = 0$  when all three voltages are zero, and  $v_{\text{out}} = 2 \text{ V}$  when all three voltages are at their maximum. (b) Verify your design by analyzing the final circuit.
25. (a) Design a circuit which produces an output voltage  $v_{\text{out}}$  proportional to the difference of two positive voltages  $v_1$  and  $v_2$  such that  $v_{\text{out}} = 0$  when both voltages are equal, and  $v_{\text{out}} = 10 \text{ V}$  when  $v_1 - v_2 = 1 \text{ V}$ . (b) Verify your design by analyzing the final circuit.
26. (a) Three pressure-sensitive sensors are used to double-check the weight readings obtained from the suspension systems of a long-range jet airplane. Each sensor is calibrated such that  $10 \mu\text{V}$  corresponds to 1 kg. Design a circuit which adds the three voltage signals to produce an output voltage calibrated such that 10 V corresponds to 400,000 kg, the maximum takeoff weight of the aircraft. (b) Verify your design by analyzing the final circuit.
27. (a) The oxygen supply to a particular bathysphere consists of four separate tanks, each equipped with a pressure sensor capable of measuring between 0 (corresponding to 0 V output) and 500 bar (corresponding to 5 V output). Design a circuit which produces a voltage proportional to the total pressure in all tanks, such that 1.5 V corresponds to 0 bar and 3 V corresponds to 2000 bar. (b) Verify your design by analyzing the final circuit.
28. For the circuit shown in Fig. 6.51, let  $v_{\text{in}} = 8 \text{ V}$ , and select values for  $R_1$ ,  $R_2$ , and  $R_3$  to ensure an output voltage  $v_{\text{out}} = 4 \text{ V}$ .

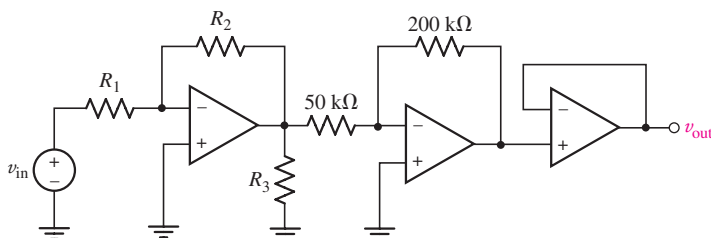

■ FIGURE 6.51

29. For the circuit of Fig. 6.52, derive an expression for  $v_{out}$  in terms of  $v_{in}$ .

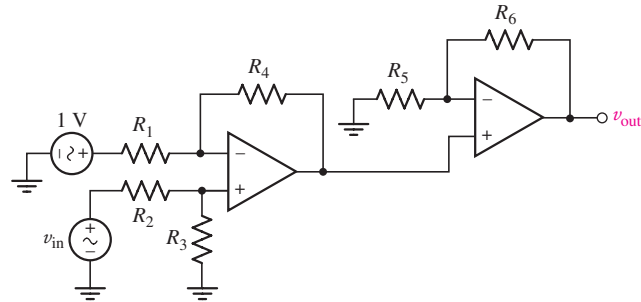

■ FIGURE 6.52

#### 6.4 Circuits for Voltage and Current Sources



30. Construct a circuit based on the 1N4740 diode which provides a reference voltage of 10 V if only 9 V batteries are available. Note that the breakdown voltage of this diode is equal to 10 V at a current of 25 mA.



31. Employ a 1N4733 Zener diode to construct a circuit which provides a 4 V reference voltage to a 1 k $\Omega$  load, if only 9 V batteries are available as sources. Note that the Zener breakdown voltage of this diode is 5.1 V at a current of 76 mA.



32. (a) Design a circuit which provides a 5 V dc reference voltage to an unknown (nonzero resistance) load, if only a 9 V battery is available as a supply.



(b) Verify your design with an appropriate simulation. As part of this, determine the acceptable range for the load resistor.



33. A particular passive network can be represented by a Thévenin equivalent resistance between 10  $\Omega$  and 125  $\Omega$  depending on the operating temperature.



(a) Design a circuit which provides a constant 2.2 V to this network regardless of temperature. (b) Verify your design with an appropriate simulation (resistance can be varied from within a single simulation, as described in Chap. 8).



34. Calculate the voltage  $V_1$  as labeled in the circuit of Fig. 6.53 if the battery is rated at  $V_{batt}$  equal to (a) 9 V; (b) 12 V. (c) Verify your solutions with appropriate simulations, commenting on the possible origin of any discrepancies.

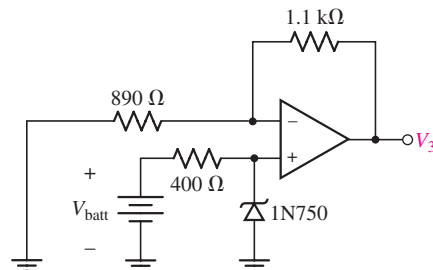

■ FIGURE 6.53



35. (a) Design a current source based on the 1N750 diode which is capable of providing a dc current of 750  $\mu$ A to a load  $R_L$ , such that 1 k $\Omega$  <  $R_L$  < 50 k $\Omega$ . (b) Verify your design with an appropriate simulation (note that resistance can be varied within a single simulation, as described in Chap. 8).



36. (a) Design a current source able to provide a dc current of 50 mA to an unspecified load. Use a 1N4733 diode ( $V_{br} = 5.1$  V at 76 mA). (b) Use an appropriate simulation to determine the permissible range of load resistance for your design.



37. (a) Design a current source able to provide a dc current of 10 mA to an unspecified load. Use a 1N4747 diode ( $V_{br} = 20$  V at 12.5 mA). (b) Use an appropriate simulation to determine the permissible range of load resistance for your design.



38. The circuit depicted in Fig. 6.54 is known as a Howland current source. Derive expressions for  $v_{out}$  and  $I_L$ , respectively as a function of  $V_1$  and  $V_2$ .

39. For the circuit depicted in Fig. 6.54, known as a Howland current source, set  $V_2 = 0$ ,  $R_1 = R_3$ , and  $R_2 = R_4$ ; then solve for the current  $I_L$  when  $R_1 = 2R_2 = 1$  k $\Omega$  and  $R_L = 100$   $\Omega$ .

## 6.5 Practical Considerations

40. (a) Employ the parameters listed in Table 6.3 for the  $\mu$ A741 op amp to analyze the circuit of Fig. 6.55 and compute a value for  $v_{out}$ . (b) Compare your result to what is predicted using the ideal op amp model.

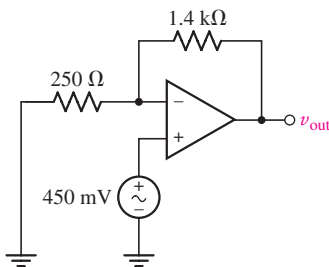

FIGURE 6.55

41. (a) Employ the parameters listed in Table 6.3 for the  $\mu$ A741 op amp to analyze the circuit of Fig. 6.10 if  $R = 1.5$  k $\Omega$ ,  $v_1 = 2$  V, and  $v_2 = 5$  V. (b) Compare your solution to what is predicted using the ideal op amp model.

42. Define the following terms, and explain when and how each can impact the performance of an op amp circuit: (a) common-mode rejection ratio; (b) slew rate; (c) saturation; (d) feedback.

43. For the circuit of Fig. 6.56, replace the 470  $\Omega$  resistor with a short circuit, and compute  $v_{out}$  using (a) the ideal op amp model; (b) the parameters listed in Table 6.3 for the  $\mu$ A741 op amp; (c) an appropriate PSpice simulation. (d) Compare the values obtained in parts (a) to (c) and comment on the possible origin of any discrepancies.



44. If the circuit of Fig. 6.55 is analyzed using the detailed model of an op amp (as opposed to the ideal op amp model), calculate the value of open-loop gain  $A$  required to achieve a closed-loop gain within 2% of its ideal value.



45. Replace the 2 V source in Fig. 6.56 with a sinusoidal voltage source having a magnitude of 3 V and radian frequency  $\omega = 2\pi f$ . (a) Which device, a  $\mu$ A741 op amp or an LF411 op amp, will track the source frequency better over the range  $1$  Hz  $< f < 10$  MHz? Explain. (b) Compare the frequency performance of the circuit over the range  $1$  Hz  $< f < 10$  MHz using appropriate PSpice simulations, and compare the results to your prediction in part (a).



46. (a) For the circuit of Fig. 6.56, if the op amp (assume LF411) is powered by matched 9 V supplies, estimate the maximum value to which the 470  $\Omega$  resistor can be increased before saturation effects become apparent. (b) Verify your prediction with an appropriate simulation.

47. For the circuit of Fig. 6.55, calculate the differential input voltage and the input bias current if the op amp is a(n) (a)  $\mu$ A741; (b) LF411; (c) AD549K; (d) OPA690.

48. Calculate the common-mode gain for each device listed in Table 6.3. Express your answer in units of V/V, not dB.

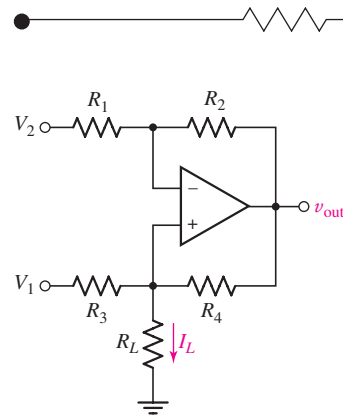

FIGURE 6.54

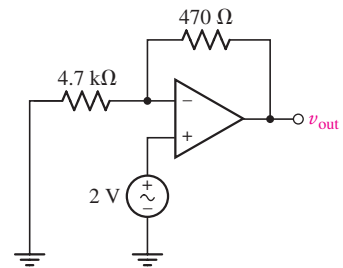

FIGURE 6.56

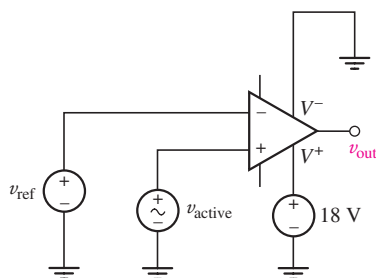

FIGURE 6.57

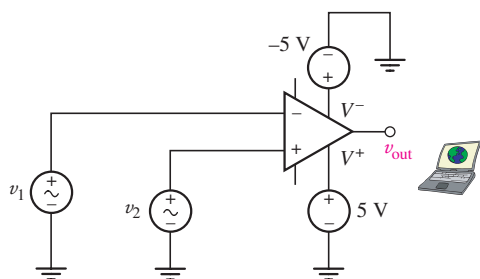

FIGURE 6.58

## 6.6 Comparators and the Instrumentation Amplifier

DP

49. Human skin, especially when damp, is a reasonable conductor of electricity. If we assume a resistance of less than  $10\text{ M}\Omega$  for a fingertip pressed across two terminals, design a circuit which provides a  $+1\text{ V}$  output if this nonmechanical switch is “closed” and  $-1\text{ V}$  if it is “open.”

50. Design a circuit which provides an output voltage  $v_{\text{out}}$  based on the behavior of another voltage  $v_{\text{in}}$ , such that

$$v_{\text{out}} = \begin{cases} +2.5\text{ V} & v_{\text{in}} > 1\text{ V} \\ 1.2\text{ V} & \text{otherwise} \end{cases}$$

51. For the instrumentation amplifier shown in Fig. 6.38a, assume that the three internal op amps are ideal, and determine the CMRR of the circuit if (a)  $R_1 = R_3$  and  $R_2 = R_4$ ; (b) all four resistors have different values.

52. For the circuit depicted in Fig. 6.57, sketch the expected output voltage  $v_{\text{out}}$  as a function of  $v_{\text{active}}$  for  $-5\text{ V} \leq v_{\text{active}} \leq +5\text{ V}$ , if  $v_{\text{ref}}$  is equal to (a)  $-3\text{ V}$ ; (b)  $+3\text{ V}$ .

53. For the circuit depicted in Fig. 6.58, (a) sketch the expected output voltage  $v_{\text{out}}$  as a function of  $v_1$  for  $-5\text{ V} \leq v_1 \leq +5\text{ V}$ , if  $v_2 = +2\text{ V}$ ; (b) sketch the expected output voltage  $v_{\text{out}}$  as a function of  $v_2$  for  $-5\text{ V} \leq v_2 \leq +5\text{ V}$ , if  $v_1 = +2\text{ V}$ .

54. For the circuit depicted in Fig. 6.59, sketch the expected output voltage  $v_{\text{out}}$  as a function of  $v_{\text{active}}$ , if  $-2\text{ V} \leq v_{\text{active}} \leq +2\text{ V}$ . Verify your solution using a  $\mu\text{A}741$  (although it is slow compared to op amps designed specifically for use as comparators, its PSpice model works well, and as this is a dc application speed is not an issue). Submit a properly labeled schematic with your results.

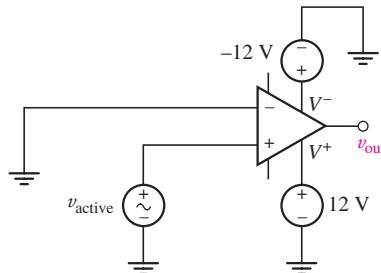

FIGURE 6.59

DP

55. In digital logic applications, a  $+5\text{ V}$  signal represents a logic “1” state, and a  $0\text{ V}$  signal represents a logic “0” state. In order to process real-world information using a digital computer, some type of interface is required, which typically includes an analog-to-digital (A/D) converter—a device that converts analog signals into digital signals. Design a circuit that acts as a simple 1-bit A/D, with any signal less than  $1.5\text{ V}$  resulting in a logic “0” and any signal greater than  $1.5\text{ V}$  resulting in a logic “1.”

DP

56. A common application for instrumentation amplifiers is to measure voltages in resistive strain gauge circuits. These strain sensors work by exploiting the changes in resistance that result from geometric distortions, as in Eq. [6] of Chap. 2. They are often part of a bridge circuit, as shown in Fig. 6.60a, where the strain gauge is identified as  $R_G$ . (a) Show that  $V_{\text{out}} = V_{\text{in}} \left[ \frac{R_2}{R_1 + R_2} - \frac{R_3}{R_3 + R_{\text{Gauge}}} \right]$ . (b) Verify that  $V_{\text{out}} = 0$  when the three fixed-value resistors  $R_1$ ,  $R_2$ , and  $R_3$  are all chosen to be equal to the unstrained gauge resistance  $R_{\text{Gauge}}$ . (c) For the intended application, the gauge selected has an unstrained resistance of  $5\text{ k}\Omega$ , and a maximum resistance increase of



50 m $\Omega$  is expected. Only  $\pm 12$  V supplies are available. Using the instrumentation amplifier of Fig. 6.60b, design a circuit that will provide a voltage signal of +1 V when the strain gauge is at its maximum loading.

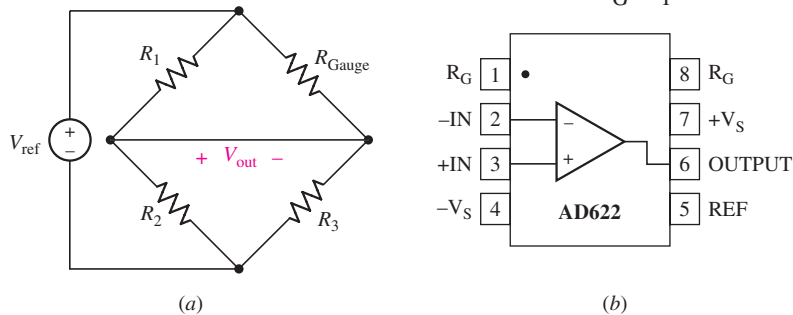

FIGURE 6.60

© Analog Devices.

### Chapter-Integrating Exercises

- DP** 57. (a) You're given an electronic switch which requires 5 V at 1 mA in order to close; it is open with no voltage present at its input. If the only microphone available produces a peak voltage of 250 mV, design a circuit which will energize the switch when someone speaks into the microphone. Note that the audio level of a general voice may not correspond to the peak voltage of the microphone. (b) Discuss any issues that may need to be addressed if your circuit were to be implemented.
- DP** 58. You've formed a band, despite advice to the contrary. Actually, the band is pretty good except for the fact that the lead singer (who owns the drum set, the microphones, and the garage where you practice) is a bit tone-deaf. Design a circuit that takes the output from each of the five microphones your band uses, and adds the voltages to create a single voltage signal which is fed to the amplifier. Except not all voltages should be equally amplified. One microphone output should be attenuated such that its peak voltage is 10% of any other microphone's peak voltage.
- DP** 59. Cadmium sulfide (CdS) is commonly used to fabricate resistors whose value depends on the intensity of light shining on the surface. In Fig. 6.61 a CdS "photocell" is used as the feedback resistor  $R_f$ . In total darkness, it has a resistance of 100 k $\Omega$ , and a resistance of 10 k $\Omega$  under a light intensity of 6 candela.  $R_L$  represents a circuit that is activated when a voltage of 1.5 V or less is applied to its terminals. Choose  $R_1$  and  $V_S$  so that the circuit represented by  $R_L$  is activated by a light of 2 candela or brighter.

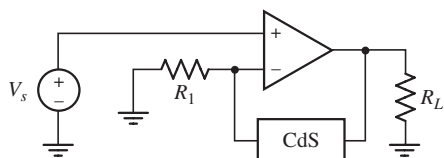

FIGURE 6.61



DP

60. A fountain outside a certain office building is designed to reach a maximum height of 5 meters at a flow rate of 100 l/s. A variable position valve in line with the water supply to the fountain can be controlled electrically, such that 0 V applied results in the valve being fully open, and 5 V results in the valve being closed. In adverse wind conditions the maximum height of the fountain needs to be adjusted; if the wind velocity exceeds 50 km/h, the height cannot exceed 2 meters. A wind velocity sensor is available which provides a voltage calibrated such that 1 V corresponds to a wind velocity of 25 km/h. Design a circuit which uses the velocity sensor to control the fountain according to specifications.
61. For the circuit of Fig. 6.43, let all resistor values equal  $5 \text{ k}\Omega$ . Sketch  $v_{\text{out}}$  as a function of time if (a)  $v_1 = 5 \sin 5t \text{ V}$  and  $v_2 = 5 \cos 5t \text{ V}$ ; (b)  $v_1 = 4e^{-t} \text{ V}$  and  $v_2 = 5e^{-2t} \text{ V}$ ; (c)  $v_1 = 2 \text{ V}$  and  $v_2 = e^{-t} \text{ V}$ .

# Capacitors and Inductors

## INTRODUCTION

In this chapter we introduce two new passive circuit elements, the *capacitor* and the *inductor*, each of which has the ability to both store and deliver *finite* amounts of energy. They differ from ideal sources in this respect, since they cannot sustain a finite average power flow over an infinite time interval. Although they are classed as linear elements, the current-voltage relationships for these new elements are time-dependent, leading to many interesting circuits. The range of capacitance and inductance values we might encounter can be huge, so that at times they may dominate circuit behavior, and at other times be essentially insignificant. Such issues continue to be relevant in modern circuit applications, particularly as computer and communication systems move to increasingly higher operating frequencies and component densities.

## 7.1 THE CAPACITOR

### Ideal Capacitor Model

Previously, we termed independent and dependent sources *active* elements, and the linear resistor a *passive* element, although our definitions of active and passive are still slightly fuzzy and need to be brought into sharper focus. We now define an **active element** as an element that is capable of furnishing an average power greater than zero to some external device, where the average is taken over an infinite time interval. Ideal sources are active elements, and the operational amplifier is also an active device. A **passive element**, however, is defined as an element that cannot supply an average power that is greater than zero over an infinite time interval. The resistor falls into this category; the energy it receives is usually transformed into heat, and it never supplies energy.

## KEY CONCEPTS

The Voltage-Current Relationship of an Ideal Capacitor

The Current-Voltage Relationship of an Ideal Inductor

Calculating Energy Stored in Capacitors and Inductors

Response of Capacitors and Inductors to Time-Varying Waveforms

Series and Parallel Combinations

Op Amp Circuits with Capacitors

PSpice Modeling of Energy Storage Elements



We now introduce a new passive circuit element, the *capacitor*. We define capacitance  $C$  by the voltage-current relationship

$$i = C \frac{dv}{dt} \quad [1]$$

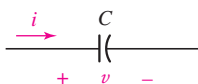

■ FIGURE 7.1 Electrical symbol and current-voltage conventions for a capacitor.

where  $v$  and  $i$  satisfy the conventions for a passive element, as shown in Fig. 7.1. We should bear in mind that  $v$  and  $i$  are functions of time; if needed, we can emphasize this fact by writing  $v(t)$  and  $i(t)$  instead. From Eq. [1], we may determine the unit of capacitance as an ampere-second per volt, or coulomb per volt. We will now define the *farad*<sup>1</sup> (F) as one coulomb per volt, and use this as our unit of capacitance.

The ideal capacitor defined by Eq. [1] is only a mathematical model of a real device. A capacitor consists of two conducting surfaces on which charge may be stored, separated by a thin insulating layer that has a very large resistance. If we assume that this resistance is sufficiently large that it may be considered infinite, then equal and opposite charges placed on the capacitor “plates” can never recombine, at least by any path within the element. The construction of the physical device is suggested by the circuit symbol shown in Fig. 7.1.

Let us visualize some external device connected to this capacitor and causing a positive current to flow into one plate of the capacitor and out of the other plate. Equal currents are entering and leaving the two terminals, and this is no more than we expect for any circuit element. Now let us examine the interior of the capacitor. The positive current entering one plate represents positive charge moving toward that plate through its terminal lead; this charge cannot pass through the interior of the capacitor, and it therefore accumulates on the plate. As a matter of fact, the current and the increasing charge are related by the familiar equation

$$i = \frac{dq}{dt}$$

Now let us consider this plate as an overgrown node and apply Kirchhoff’s current law. It apparently does not hold; current is approaching the plate from the external circuit, but it is not flowing out of the plate into the “internal circuit.” This dilemma bothered a famous Scottish scientist, James Clerk Maxwell, more than a century ago. The unified electromagnetic theory that he subsequently developed hypothesizes a “displacement current” that is present wherever an electric field or a voltage is varying with time. The displacement current flowing internally between the capacitor plates is exactly equal to the conduction current flowing in the capacitor leads; Kirchhoff’s current law is therefore satisfied if we include both conduction and displacement currents. However, circuit analysis is not concerned with this internal displacement current, and since it is fortunately equal to the conduction current, we may consider Maxwell’s hypothesis as relating the conduction current to the changing voltage across the capacitor.

A capacitor constructed of two parallel conducting plates of area  $A$ , separated by a distance  $d$ , has a capacitance  $C = \epsilon A/d$ , where  $\epsilon$  is the permittivity, a constant of the insulating material between the plates; this assumes

(1) Named in honor of Michael Faraday.

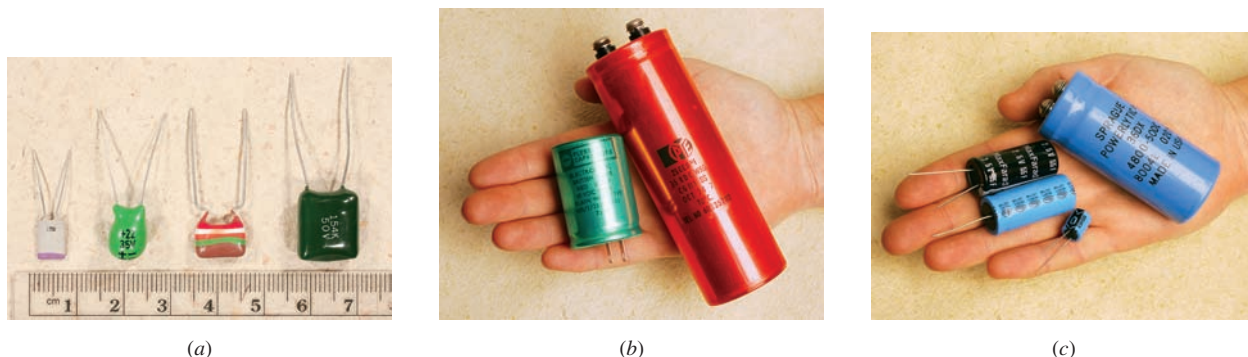

■ FIGURE 7.2 Several examples of commercially available capacitors. (a) Left to right: 270 pF ceramic, 20  $\mu\text{F}$  tantalum, 15 nF polyester, 150 nF polyester. (b) Left: 2000  $\mu\text{F}$  40 VDC rated electrolytic, 25,000  $\mu\text{F}$  35 VDC rated electrolytic. (c) Clockwise from smallest: 100  $\mu\text{F}$  63 VDC rated electrolytic, 2200  $\mu\text{F}$  50 VDC rated electrolytic, 55 F 2.5 VDC rated electrolytic, and 4800  $\mu\text{F}$  50 VDC rated electrolytic. Note that generally speaking larger capacitance values require larger packages, with one notable exception above. What was the tradeoff in that case?

the linear dimensions of the conducting plates are all very much greater than  $d$ . For air or vacuum,  $\epsilon = \epsilon_0 = 8.854 \text{ pF/m}$ . Most capacitors employ a thin dielectric layer with a larger permittivity than air in order to minimize the device size. Examples of various types of commercially available capacitors are shown in Fig. 7.2, although we should remember that any two conducting surfaces not in direct contact with each other may be characterized by a nonzero (although probably small) capacitance. We should also note that a capacitance of several hundred *microfarads* ( $\mu\text{F}$ ) is considered “large.”

Several important characteristics of our new mathematical model can be discovered from the defining equation, Eq. [1]. A constant voltage across a capacitor results in zero current passing through it; a capacitor is thus an “open circuit to dc.” This fact is pictorially represented by the capacitor symbol. It is also apparent that a sudden jump in the voltage requires an infinite current. Since this is physically impossible, we will therefore prohibit the voltage across a capacitor to change in zero time.



## EXAMPLE 7.1

**Determine the current  $i$  flowing through the capacitor of Fig. 7.1 for the two voltage waveforms of Fig. 7.3 if  $C = 2 \text{ F}$ .**

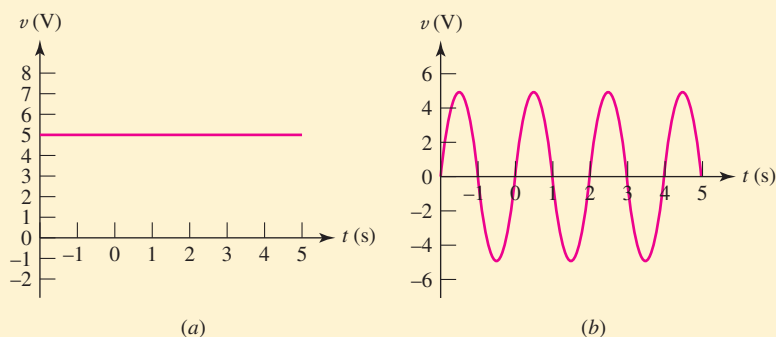

■ FIGURE 7.3 (a) A dc voltage applied to the terminals of the capacitor. (b) A sinusoidal voltage waveform applied to the capacitor terminals.

(Continued on next page)

The current  $i$  is related to the voltage  $v$  across the capacitor by Eq. [1]:

$$i = C \frac{dv}{dt}$$

For the voltage waveform depicted in Fig. 7.3a,  $dv/dt = 0$ , so  $i = 0$ ; the result is plotted in Fig. 7.4a. For the case of the sinusoidal waveform of Fig. 7.3b, we expect a cosine current waveform to flow in response, having the same frequency and twice the magnitude (since  $C = 2$  F). The result is plotted in Fig. 7.4b.

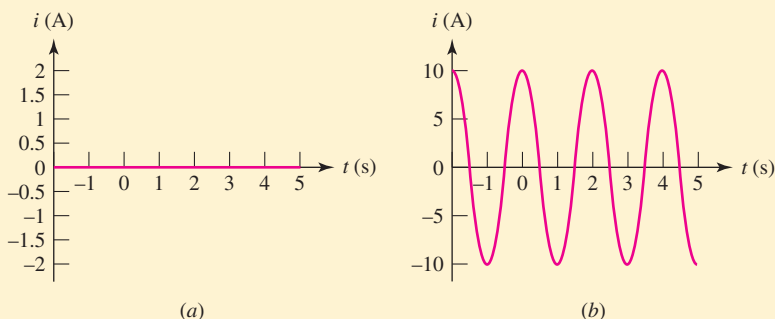

■ FIGURE 7.4 (a)  $i = 0$  as the voltage applied is dc. (b) The current has a cosine form in response to a sine wave voltage.

### PRACTICE

7.1 Determine the current flowing through a 5 mF capacitor in response to a voltage  $v$  equal to: (a)  $-20$  V; (b)  $2e^{-5t}$  V.

Ans: 0 A;  $-50e^{-5t}$  mA.

## Integral Voltage-Current Relationships

The capacitor voltage may be expressed in terms of the current by integrating Eq. [1]. We first obtain

$$dv = \frac{1}{C} i(t) dt$$

and then integrate<sup>2</sup> between the times  $t_0$  and  $t$  and between the corresponding voltages  $v(t_0)$  and  $v(t)$ :

$$v(t) = \frac{1}{C} \int_{t_0}^t i(t') dt' + v(t_0) \quad [2]$$

Equation [2] may also be written as an indefinite integral plus a constant of integration:

$$v(t) = \frac{1}{C} \int i dt + k$$

(2) Note that we are employing the mathematically correct procedure of defining a *dummy variable*  $t'$  in situations where the integration variable  $t$  is also a limit.

Finally, in many situations we will find that  $v(t_0)$ , the voltage initially across the capacitor, is not able to be discerned. In such instances it is mathematically convenient to set  $t_0 = -\infty$  and  $v(-\infty) = 0$ , so that

$$v(t) = \frac{1}{C} \int_{-\infty}^t i dt'$$

Since the integral of the current over any time interval is the corresponding charge accumulated on the capacitor plate into which the current is flowing, we may also define capacitance as

$$q(t) = Cv(t)$$

where  $q(t)$  and  $v(t)$  represent instantaneous values of the charge on either plate and the voltage between the plates, respectively.

## EXAMPLE 7.2

**Find the capacitor voltage that is associated with the current shown graphically in Fig. 7.5a. The value of the capacitance is  $5 \mu\text{F}$ .**

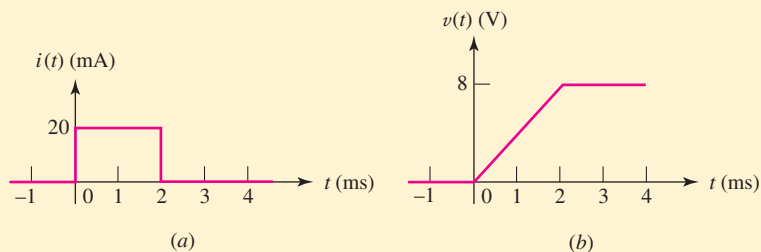

■ FIGURE 7.5 (a) The current waveform applied to a  $5 \mu\text{F}$  capacitor. (b) The resultant voltage waveform obtained by graphical integration.

Equation [2] is the appropriate expression here:

$$v(t) = \frac{1}{C} \int_{t_0}^t i(t') dt' + v(t_0)$$

but now it needs to be interpreted graphically. To do this, we note that the difference in voltage between times  $t$  and  $t_0$  is proportional to the area under the current curve defined by the same two times. The constant of proportionality is  $1/C$ .

From Fig. 7.5a, we see three separate intervals:  $t \leq 0$ ,  $0 \leq t \leq 2$  ms, and  $t \geq 2$  ms. Defining the first interval more specifically as between  $-\infty$  and 0, so that  $t_0 = -\infty$ , we note two things, both a consequence of the fact that the current has always been zero up to  $t = 0$ : First,

$$v(t_0) = v(-\infty) = 0$$

Second, the integral of the current between  $t_0 = -\infty$  and 0 is simply zero, since  $i = 0$  in that interval. Thus,

$$v(t) = 0 + v(-\infty) \quad -\infty \leq t \leq 0$$

or

$$v(t) = 0 \quad t \leq 0$$

(Continued on next page)

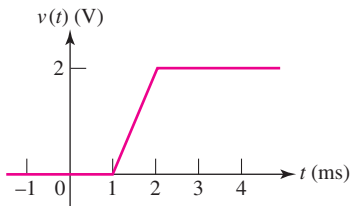

■ FIGURE 7.6

If we now consider the time interval represented by the rectangular pulse, we obtain

$$v(t) = \frac{1}{5 \times 10^{-6}} \int_0^t 20 \times 10^{-3} dt' + v(0)$$

Since  $v(0) = 0$ ,

$$v(t) = 4000t \quad 0 \leq t \leq 2 \text{ ms}$$

For the semi-infinite interval following the pulse, the integral of  $i(t)$  is once again zero, so that

$$v(t) = 8 \quad t \geq 2 \text{ ms}$$

The results are expressed much more simply in a sketch than by these analytical expressions, as shown in Fig. 7.5b.

### PRACTICE

7.2 Determine the current through a 100 pF capacitor if its voltage as a function of time is given by Fig. 7.6.

Ans: 0 A,  $-\infty \leq t \leq 1$  ms; 200 nA,  $1 \text{ ms} \leq t \leq 2$  ms; 0 A,  $t \geq 2$  ms.

## Energy Storage

To determine the energy stored in a capacitor, we begin with the power delivered to it:

$$p = vi = Cv \frac{dv}{dt}$$

The change in energy stored in its electric field is simply

$$\int_{t_0}^t p dt' = C \int_{t_0}^t v \frac{dv}{dt'} dt' = C \int_{v(t_0)}^{v(t)} v' dv' = \frac{1}{2} C \{ [v(t)]^2 - [v(t_0)]^2 \}$$

and thus

$$w_C(t) - w_C(t_0) = \frac{1}{2} C \{ [v(t)]^2 - [v(t_0)]^2 \} \quad [3]$$

where the stored energy is  $w_C(t_0)$  in joules (J) and the voltage at  $t_0$  is  $v(t_0)$ . If we select a zero-energy reference at  $t_0$ , implying that the capacitor voltage is also zero at that instant, then

$$w_C(t) = \frac{1}{2} C v^2 \quad [4]$$

Let us consider a simple numerical example. As sketched in Fig. 7.7, a sinusoidal voltage source is in parallel with a 1 M $\Omega$  resistor and a 20  $\mu$ F capacitor. The parallel resistor may be assumed to represent the finite resistance of the dielectric between the plates of the physical capacitor (an ideal capacitor has infinite resistance).



## EXAMPLE 7.3

Find the maximum energy stored in the capacitor of Fig. 7.7 and the energy dissipated in the resistor over the interval  $0 < t < 0.5$  s.

► **Identify the goal of the problem.**

The energy stored in the capacitor varies with time; we are asked for the *maximum* value over a specific time interval. We are also asked to find the *total* amount of energy dissipated by the resistor over this interval. These are actually two completely different questions.

► **Collect the known information.**

The only source of energy in the circuit is the independent voltage source, which has a value of  $100 \sin 2\pi t$  V. We are only interested in the time interval of  $0 < t < 0.5$  s. The circuit is properly labeled.

► **Devise a plan.**

Determine the energy in the capacitor by evaluating the voltage. To find the energy dissipated in the resistor during the same time interval, integrate the dissipated *power*;  $p_R = i_R^2 \cdot R$ .

► **Construct an appropriate set of equations.**

The energy stored in the capacitor is simply

$$w_C(t) = \frac{1}{2} C v^2 = 0.1 \sin^2 2\pi t \quad \text{J}$$

We obtain an expression for the power dissipated by the resistor in terms of the current  $i_R$ :

$$i_R = \frac{v}{R} = 10^{-4} \sin 2\pi t \quad \text{A}$$

and so

$$p_R = i_R^2 R = (10^{-4})^2 (10^6) \sin^2 2\pi t$$

so that the energy dissipated in the resistor between 0 and 0.5 s is

$$w_R = \int_0^{0.5} p_R dt = \int_0^{0.5} 10^{-2} \sin^2 2\pi t dt \quad \text{J}$$

► **Determine if additional information is required.**

We have an expression for the energy stored in the capacitor; a sketch is shown in Fig. 7.8. The expression derived for the energy dissipated by the resistor does not involve any unknown quantities, and so may also be readily evaluated.

► **Attempt a solution.**

From our sketch of the expression for the energy stored in the capacitor, we see that it increases from zero at  $t = 0$  to a maximum of 100 mJ at  $t = \frac{1}{4}$  s, and then decreases to zero in another  $\frac{1}{4}$  s. Thus,  $w_{C_{\max}} = 100$  mJ. Evaluating our integral expression for the energy dissipated in the resistor, we find that  $w_R = 2.5$  mJ.

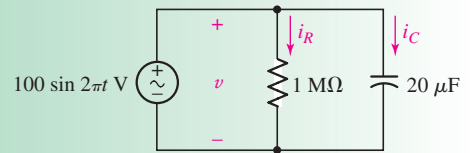

■ FIGURE 7.7 A sinusoidal voltage source is applied to a parallel RC network. The  $1 \text{ M}\Omega$  resistor might represent the finite resistance of the “real” capacitor’s dielectric layer.

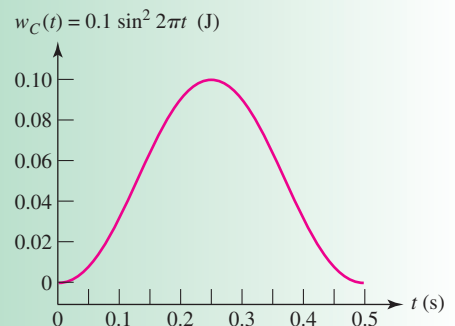

■ FIGURE 7.8 A sketch of the energy stored in the capacitor as a function of time.

(Continued on next page)

► **Verify the solution. Is it reasonable or expected?**

We do not expect to calculate a *negative* stored energy, which is borne out in our sketch. Further, since the maximum value of  $\sin 2\pi t$  is 1, the maximum energy expected anywhere would be  $(1/2)(20 \times 10^{-6})(100)^2 = 100 \text{ mJ}$ .

The resistor dissipated 2.5 mJ in the period of 0 to 500 ms, although the capacitor stored a maximum of 100 mJ at one point during that interval. What happened to the “other” 97.5 mJ? To answer this, we compute the capacitor current

$$i_C = 20 \times 10^{-6} \frac{dv}{dt} = 0.004\pi \cos 2\pi t$$

and the current  $i_s$  defined as flowing *into* the voltage source

$$i_s = -i_C - i_R$$

both of which are plotted in Fig. 7.9. We observe that the current flowing through the resistor is a small fraction of the source current, not entirely surprising as  $1 \text{ M}\Omega$  is a relatively large resistance value. As current flows from the source, a small amount is diverted to the resistor, with the rest flowing into the capacitor as it charges. After  $t = 250 \text{ ms}$ , the source current is seen to change sign; current is now flowing from the capacitor back into the source. Most of the energy stored in the capacitor is being returned to the ideal voltage source, except for the small fraction dissipated in the resistor.

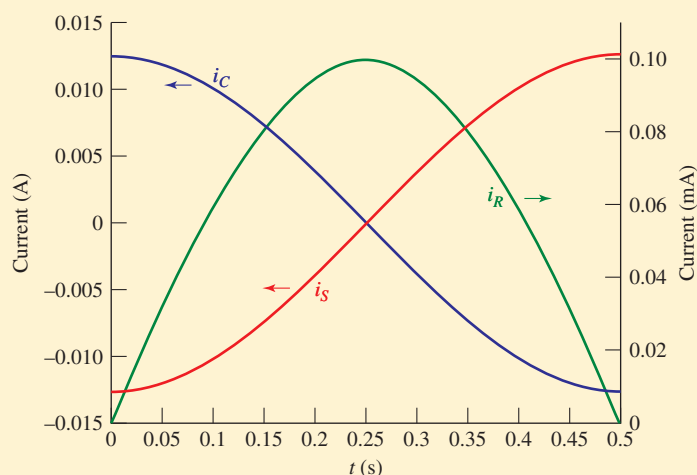

■ FIGURE 7.9 Plot of the resistor, capacitor, and source currents during the interval of 0 to 500 ms.

**PRACTICE**

7.3 Calculate the energy stored in a  $1000 \mu\text{F}$  capacitor at  $t = 50 \mu\text{s}$  if the voltage across it is  $1.5 \cos 10^5 t$  volts.

Ans:  $90.52 \mu\text{J}$ .

### Important Characteristics of an Ideal Capacitor

1. There is no current through a capacitor if the voltage across it is not changing with time. A capacitor is therefore an *open circuit to dc*.
2. A finite amount of energy can be stored in a capacitor even if the current through the capacitor is zero, such as when the voltage across it is constant.
3. It is impossible to change the voltage across a capacitor by a finite amount in zero time, as this requires an infinite current through the capacitor. (A capacitor resists an abrupt change in the voltage across it in a manner analogous to the way a spring resists an abrupt change in its displacement.)
4. A capacitor never dissipates energy, but only stores it. Although this is true for the *mathematical model*, it is not true for a *physical* capacitor due to finite resistances associated with the dielectric as well as the packaging.

## 7.2 THE INDUCTOR

### Ideal Inductor Model

In the early 1800s the Danish scientist Oersted showed that a current-carrying conductor produced a magnetic field (compass needles were affected in the presence of a wire when current was flowing). Shortly thereafter, Ampère made some careful measurements which demonstrated that this magnetic field was *linearly* related to the current which produced it. The next step occurred some 20 years later when the English experimentalist Michael Faraday and the American inventor Joseph Henry discovered almost simultaneously<sup>3</sup> that a changing magnetic field could induce a voltage in a neighboring circuit. They showed that this voltage was proportional to the time rate of change of the current producing the magnetic field. The constant of proportionality is what we now call the *inductance*, symbolized by  $L$ , and therefore

$$v = L \frac{di}{dt} \quad [5]$$

where we must realize that  $v$  and  $i$  are both functions of time. When we wish to emphasize this, we may do so by using the symbols  $v(t)$  and  $i(t)$ .

The circuit symbol for the inductor is shown in Fig. 7.10, and it should be noted that the passive sign convention is used, just as it was with the resistor and the capacitor. The unit in which inductance is measured is the **henry** (H), and the defining equation shows that the henry is just a shorter expression for a volt-second per ampere.

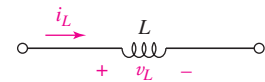

■ FIGURE 7.10 Electrical symbol and current-voltage conventions for an inductor.

(3) Faraday won.

The inductor whose inductance is defined by Eq. [5] is a mathematical model; it is an *ideal* element which we may use to approximate the behavior of a *real* device. A physical inductor may be constructed by winding a length of wire into a coil. This serves effectively to increase the current that is causing the magnetic field and also to increase the “number” of neighboring circuits into which Faraday’s voltage may be induced. The result of this twofold effect is that the inductance of a coil is approximately proportional to the square of the number of complete turns made by the conductor out of which it is formed. For example, an inductor or “coil” that has the form of a long helix of very small pitch is found to have an inductance of  $\mu N^2 A/s$ , where  $A$  is the cross-sectional area,  $s$  is the axial length of the helix,  $N$  is the number of complete turns of wire, and  $\mu$  (mu) is a constant of the material inside the helix, called the permeability. For free space (and very closely for air),  $\mu = \mu_0 = 4\pi \times 10^{-7}$  H/m =  $4\pi$  nH/cm. Several examples of commercially available inductors are shown in Fig. 7.11.



Let us now scrutinize Eq. [5] to determine some of the electrical characteristics of the mathematical model. This equation shows that the voltage across an inductor is proportional to the time rate of change of the current through it. In particular, it shows that there is no voltage across an inductor carrying a constant current, regardless of the magnitude of this current. Accordingly, we may view an inductor as a *short circuit to dc*.

Another fact that can be obtained from Eq. [5] is that a sudden or discontinuous change in the current must be associated with an infinite voltage across the inductor. In other words, if we wish to produce an abrupt change in an inductor current, we must apply an infinite voltage. Although an infinite-voltage forcing function might be amusing theoretically, it can never be a part of the phenomena displayed by a real physical device. As we

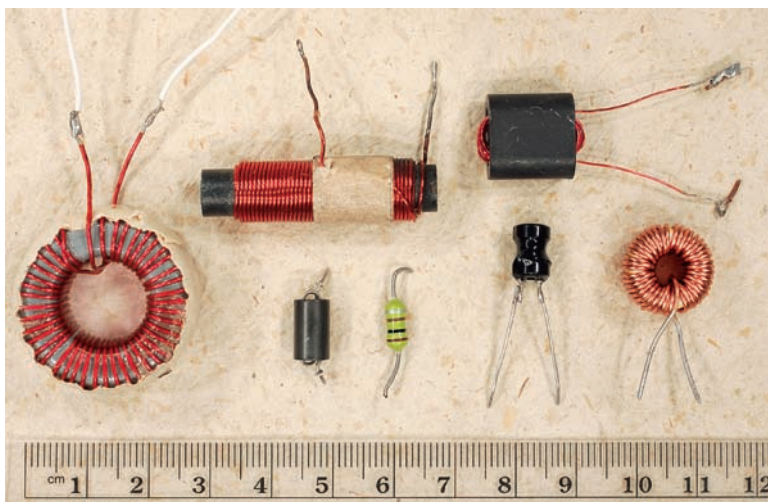

(a)



(b)

■ FIGURE 7.11 (a) Several different types of commercially available inductors, sometimes also referred to as “chokes.” Clockwise, starting from far left: 287  $\mu$ H ferrite core toroidal inductor, 266  $\mu$ H ferrite core cylindrical inductor, 215  $\mu$ H ferrite core inductor designed for VHF frequencies, 85  $\mu$ H iron powder core toroidal inductor, 10  $\mu$ H bobbin-style inductor, 100  $\mu$ H axial lead inductor, and 7  $\mu$ H lossy-core inductor used for RF suppression. (b) An 11 H inductor, measuring 10 cm (tall)  $\times$  8 cm (wide)  $\times$  8 cm (deep).



shall see shortly, an abrupt change in the inductor current also requires an abrupt change in the energy stored in the inductor, and this sudden change in energy requires infinite power at that instant; infinite power is again not a part of the real physical world. In order to avoid infinite voltage and infinite power, an inductor current must not be allowed to jump *instantaneously* from one value to another.

If an attempt is made to open-circuit a physical inductor through which a finite current is flowing, an arc may appear across the switch. This is useful in the ignition system of some automobiles, where the current through the spark coil is interrupted by the distributor and the arc appears across the spark plug. Although this does not occur instantaneously, it happens in a very short timespan, leading to the creation of a large voltage. The presence of a large voltage across a short distance equates to a very large electric field; the stored energy is dissipated in ionizing the air in the path of the arc.

Equation [5] may also be interpreted (and solved, if necessary) by graphical methods, as seen in Example 7.4.

### EXAMPLE 7.4

**Given the waveform of the current in a 3 H inductor as shown in Fig. 7.12a, determine the inductor voltage and sketch it.**

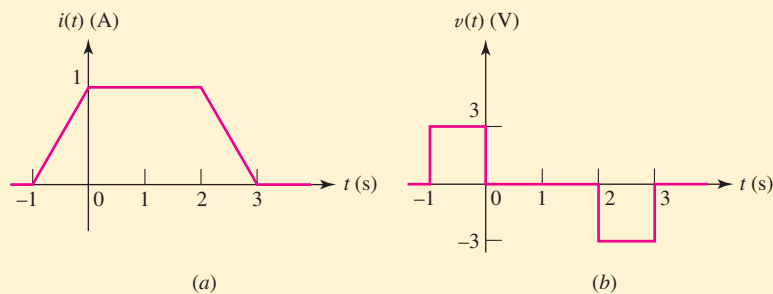

■ FIGURE 7.12 (a) The current waveform in a 3 H inductor. (b) The corresponding voltage waveform,  $v = 3 di/dt$ .

Defining the voltage  $v$  and the current  $i$  to satisfy the passive sign convention, we may obtain  $v$  from Fig. 7.12a using Eq. [5]:

$$v = 3 \frac{di}{dt}$$

Since the current is zero for  $t < -1$  s, the voltage is zero in this interval. The current then begins to increase at the linear rate of 1 A/s, and thus a constant voltage of  $L di/dt = 3$  V is produced. During the following 2 s interval, the current is constant and the voltage is therefore zero. The final decrease of the current results in  $di/dt = -1$  A/s, yielding  $v = -3$  V. For  $t > 3$  s,  $i(t)$  is a constant (zero), so that  $v(t) = 0$  for that interval. The complete voltage waveform is sketched in Fig. 7.12b.

**PRACTICE**

7.4 The current through a 200 mH inductor is shown in Fig. 7.13. Assume the passive sign convention, and find  $v_L$  at  $t$  equal to (a) 0; (b) 2 ms; (c) 6 ms.

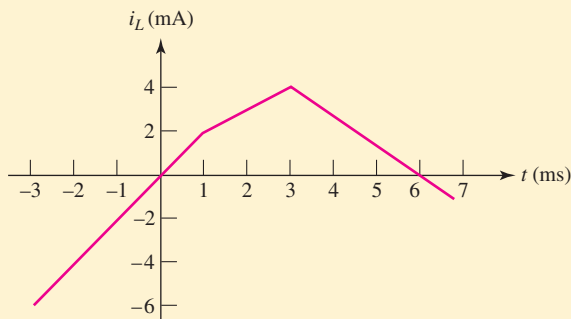

■ FIGURE 7.13

Ans: 0.4 V; 0.2 V;  $-0.267$  V.

Let us now investigate the effect of a more rapid rise and decay of the current between the 0 and 1 A values.

**EXAMPLE 7.5**

**Find the inductor voltage that results from applying the current waveform shown in Fig. 7.14a to the inductor of Example 7.4.**

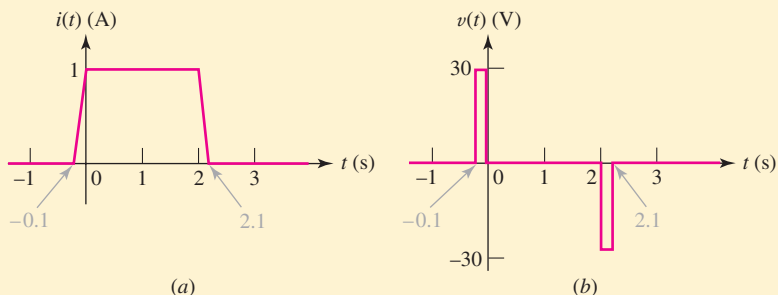

■ FIGURE 7.14 (a) The time required for the current of Fig. 7.12a to change from 0 to 1 and from 1 to 0 is decreased by a factor of 10. (b) The resultant voltage waveform. The pulse widths are exaggerated for clarity.

Note that the intervals for the rise and fall have decreased to 0.1 s. Thus, the magnitude of each derivative will be 10 times larger; this condition is shown in the current and voltage sketches of Fig. 7.14a and b. In the voltage waveforms of Fig. 7.13b and 7.14b, it is interesting to note that the area under each voltage pulse is  $3 \text{ V} \cdot \text{s}$ .

Just for curiosity's sake, let's continue in the same vein for a moment. A further decrease in the rise and fall times of the current waveform will produce a proportionally larger voltage magnitude, but only within the interval

in which the current is increasing or decreasing. An abrupt change in the current will cause the infinite voltage “spikes” (each having an area of  $3 \text{ V} \cdot \text{s}$ ) that are suggested by the waveforms of Fig. 7.15a and b; or, from the equally valid but opposite point of view, these infinite voltage spikes are required to produce the abrupt changes in the current.

### PRACTICE

7.5 The current waveform of Fig. 7.14a has equal rise and fall times of duration  $0.1 \text{ s}$  ( $100 \text{ ms}$ ). Calculate the maximum positive and negative voltages across the same inductor if the rise and fall times, respectively, are changed to (a)  $1 \text{ ms}$ ,  $1 \text{ ms}$ ; (b)  $12 \mu\text{s}$ ,  $64 \mu\text{s}$ ; (c)  $1 \text{ s}$ ,  $1 \text{ ns}$ .

Ans:  $3 \text{ kV}$ ,  $-3 \text{ kV}$ ;  $250 \text{ kV}$ ,  $-46.88 \text{ kV}$ ;  $3 \text{ V}$ ,  $-3 \text{ GV}$ .

## Integral Voltage-Current Relationships

We have defined inductance by a simple differential equation,

$$v = L \frac{di}{dt}$$

and we have been able to draw several conclusions about the characteristics of an inductor from this relationship. For example, we have found that we may consider an inductor to be a short circuit to direct current, and we have agreed that we cannot permit an inductor current to change abruptly from one value to another, because this would require that an infinite voltage and power be associated with the inductor. The simple defining equation for inductance contains still more information, however. Rewritten in a slightly different form,

$$di = \frac{1}{L} v dt$$

it invites integration. Let us first consider the limits to be placed on the two integrals. We desire the current  $i$  at time  $t$ , and this pair of quantities therefore provides the upper limits on the integrals appearing on the left and right sides of the equation, respectively; the lower limits may also be kept general by merely assuming that the current is  $i(t_0)$  at time  $t_0$ . Thus,

$$\int_{i(t_0)}^{i(t)} di' = \frac{1}{L} \int_{t_0}^t v(t') dt'$$

which leads to the equation

$$i(t) - i(t_0) = \frac{1}{L} \int_{t_0}^t v dt'$$

or

$$i(t) = \frac{1}{L} \int_{t_0}^t v dt' + i(t_0) \quad [6]$$

Equation [5] expresses the inductor voltage in terms of the current, whereas Eq. [6] gives the current in terms of the voltage. Other forms are

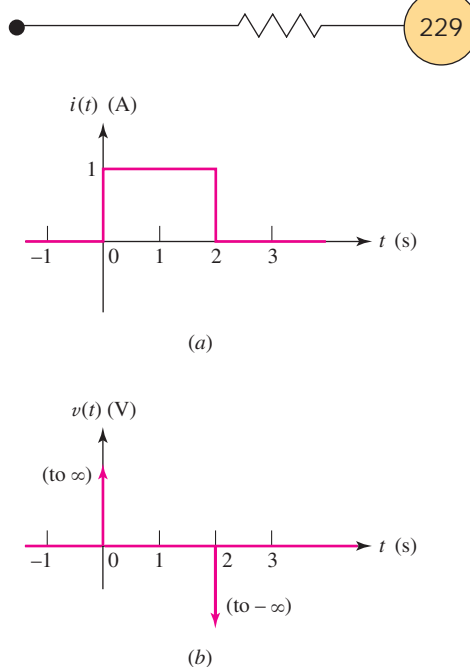

FIGURE 7.15 (a) The time required for the current of Fig. 7.14a to change from 0 to 1 and from 1 to 0 is decreased to zero; the rise and fall are abrupt. (b) The resultant voltage across the  $3 \text{ H}$  inductor consists of a positive and a negative infinite spike.

also possible for the latter equation. We may write the integral as an indefinite integral and include a constant of integration  $k$ :

$$i(t) = \frac{1}{L} \int v dt + k \quad [7]$$

We also may assume that we are solving a realistic problem in which the selection of  $t_0$  as  $-\infty$  ensures no current or energy in the inductor. Thus, if  $i(t_0) = i(-\infty) = 0$ , then

$$i(t) = \frac{1}{L} \int_{-\infty}^t v dt' \quad [8]$$

Let us investigate the use of these several integrals by working a simple example where the voltage across an inductor is specified.

### EXAMPLE 7.6

**The voltage across a 2 H inductor is known to be  $6 \cos 5t$  V. Determine the resulting inductor current if  $i(t = -\pi/2) = 1$  A.**

From Eq. [6],

$$i(t) = \frac{1}{2} \int_{t_0}^t 6 \cos 5t' dt' + i(t_0)$$

or

$$\begin{aligned} i(t) &= \frac{1}{2} \left( \frac{6}{5} \right) \sin 5t - \frac{1}{2} \left( \frac{6}{5} \right) \sin 5t_0 + i(t_0) \\ &= 0.6 \sin 5t - 0.6 \sin 5t_0 + i(t_0) \end{aligned}$$

The first term indicates that the inductor current varies sinusoidally; the second and third terms together represent a constant which becomes known when the current is numerically specified at some instant of time. Using the fact that the current is 1 A at  $t = -\pi/2$  s, we identify  $t_0$  as  $-\pi/2$  with  $i(t_0) = 1$ , and find that

$$i(t) = 0.6 \sin 5t - 0.6 \sin(-2.5\pi) + 1$$

or

$$i(t) = 0.6 \sin 5t + 1.6$$

Alternatively, from Eq. [6],

$$i(t) = 0.6 \sin 5t + k$$

and we establish the numerical value of  $k$  by forcing the current to be 1 A at  $t = -\pi/2$ :

$$1 = 0.6 \sin(-2.5\pi) + k$$

or

$$k = 1 + 0.6 = 1.6$$

and so, as before,

$$i(t) = 0.6 \sin 5t + 1.6$$



Equation [8] is going to cause trouble with this particular voltage. We based the equation on the assumption that the current was zero when  $t = -\infty$ . To be sure, this must be true in the real, physical world, but we are working in the land of the mathematical model; our elements and forcing functions are all idealized. The difficulty arises after we integrate, obtaining

$$i(t) = 0.6 \sin 5t' \Big|_{-\infty}^t$$

and attempt to evaluate the integral at the lower limit:

$$i(t) = 0.6 \sin 5t - 0.6 \sin(-\infty)$$

The sine of  $\pm\infty$  is indeterminate, and therefore we cannot evaluate our expression. Equation [8] is only useful if we are evaluating functions which approach zero as  $t \rightarrow -\infty$ .

### PRACTICE

7.6 A 100 mH inductor has voltage  $v_L = 2e^{-3t}$  V across its terminals. Determine the resulting inductor current if  $i_L(-0.5) = 1$  A.

Ans:  $-\frac{20}{3}e^{-3t} + 30.9$  A.

We should not make any snap judgments, however, as to which single form of Eqs. [6], [7], and [8] we are going to use forever after; each has its advantages, depending on the problem and the application. Equation [6] represents a long, general method, but it shows clearly that the constant of integration is a current. Equation [7] is a somewhat more concise expression of Eq. [6], but the nature of the integration constant is suppressed. Finally, Eq. [8] is an excellent expression, since no constant is necessary; however, it applies only when the current is zero at  $t = -\infty$  and when the analytical expression for the current is not indeterminate there.



## Energy Storage

Let us now turn our attention to power and energy. The absorbed power is given by the current-voltage product

$$p = vi = Li \frac{di}{dt}$$

The energy  $w_L$  accepted by the inductor is stored in the magnetic field around the coil. The change in this energy is expressed by the integral of the power over the desired time interval:

$$\begin{aligned} \int_{t_0}^t p dt' &= L \int_{t_0}^t i \frac{di}{dt'} dt' = L \int_{i(t_0)}^{i(t)} i' di' \\ &= \frac{1}{2} L \{ [i(t)]^2 - [i(t_0)]^2 \} \end{aligned}$$

Thus,

$$w_L(t) - w_L(t_0) = \frac{1}{2} L \{ [i(t)]^2 - [i(t_0)]^2 \} \quad [9]$$

where we have again assumed that the current is  $i(t_0)$  at time  $t_0$ . In using the energy expression, it is customary to assume that a value of  $t_0$  is selected at which the current is zero; it is also customary to assume that the energy is zero at this time. We then have simply

$$w_L(t) = \frac{1}{2}Li^2 \quad [10]$$

where we now understand that our reference for zero energy is any time at which the inductor current is zero. At any subsequent time at which the current is zero, we also find no energy stored in the coil. Whenever the current is not zero, and regardless of its direction or sign, energy is stored in the inductor. It follows, therefore, that energy may be delivered to the inductor for a part of the time and recovered from the inductor later. All the stored energy may be recovered from an ideal inductor; there are no storage charges or agent's commissions in the mathematical model. A physical coil, however, must be constructed out of real wire and thus will always have a resistance associated with it. Energy can no longer be stored and recovered without loss.

These ideas may be illustrated by a simple example. In Fig. 7.16, a 3 H inductor is shown in series with a 0.1  $\Omega$  resistor and a sinusoidal current source,  $i_s = 12 \sin \frac{\pi t}{6}$  A. The resistor should be interpreted as the resistance of the wire which must be associated with the physical coil.

### EXAMPLE 7.7

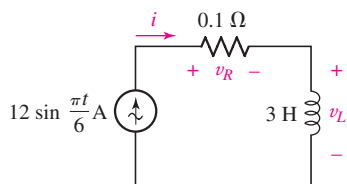

■ FIGURE 7.16 A sinusoidal current is applied as a forcing function to a series  $RL$  circuit. The 0.1  $\Omega$  represents the inherent resistance of the wire from which the inductor is fabricated.

**Find the maximum energy stored in the inductor of Fig. 7.16, and calculate how much energy is dissipated in the resistor in the time during which the energy is being stored in, and then recovered from, the inductor.**

The energy stored in the inductor is

$$w_L = \frac{1}{2}Li^2 = 216 \sin^2 \frac{\pi t}{6} \quad \text{J}$$

and this energy increases from zero at  $t = 0$  to 216 J at  $t = 3$  s. Thus, the maximum energy stored in the inductor is 216 J.

After reaching its peak value at  $t = 3$  s, the energy has completely left the inductor 3 s later. Let us see what price we have paid in this coil for the privilege of storing and removing 216 J in these 6 seconds. The power dissipated in the resistor is easily found as

$$p_R = i^2R = 14.4 \sin^2 \frac{\pi t}{6} \quad \text{W}$$

and the energy converted into heat in the resistor within this 6 s interval is therefore

$$w_R = \int_0^6 p_R dt = \int_0^6 14.4 \sin^2 \frac{\pi}{6} t dt$$

or

$$w_R = \int_0^6 14.4 \left( \frac{1}{2} \right) \left( 1 - \cos \frac{\pi}{3} t \right) dt = 43.2 \text{ J}$$

Thus, we have expended 43.2 J in the process of storing and then recovering 216 J in a 6 s interval. This represents 20 percent of the maximum stored energy, but it is a reasonable value for many coils having this large an inductance. For coils having an inductance of about 100  $\mu\text{H}$ , we might expect a figure closer to 2 or 3 percent.

### PRACTICE

7.7 Let  $L = 25 \text{ mH}$  for the inductor of Fig. 7.10. (a) Find  $v_L$  at  $t = 12 \text{ ms}$  if  $i_L = 10te^{-100t} \text{ A}$ . (b) Find  $i_L$  at  $t = 0.1 \text{ s}$  if  $v_L = 6e^{-12t} \text{ V}$  and  $i_L(0) = 10 \text{ A}$ . If  $i_L = 8(1 - e^{-40t}) \text{ mA}$ , find (c) the power being delivered to the inductor at  $t = 50 \text{ ms}$  and (d) the energy stored in the inductor at  $t = 40 \text{ ms}$ .

Ans:  $-15.06 \text{ mV}$ ;  $24.0 \text{ A}$ ;  $7.49 \mu\text{W}$ ;  $0.510 \mu\text{J}$ .

We summarize by listing four key characteristics of an inductor which result from its defining equation  $v = L di/dt$ :

#### Important Characteristics of an Ideal Inductor

1. There is no voltage across an inductor if the current through it is not changing with time. An inductor is therefore a *short circuit to dc*.
2. A finite amount of energy can be stored in an inductor even if the voltage across the inductor is zero, such as when the current through it is constant.
3. It is impossible to change the current through an inductor by a finite amount in zero time, for this requires an infinite voltage across the inductor. (An inductor resists an abrupt change in the current through it in a manner analogous to the way a mass resists an abrupt change in its velocity.)
4. The inductor never dissipates energy, but only stores it. Although this is true for the *mathematical* model, it is not true for a *physical* inductor due to series resistances.

It is interesting to anticipate our discussion of *duality* in Sec. 7.6 by rereading the previous four statements with certain words replaced by their “duals.” If *capacitor* and *inductor*, *capacitance* and *inductance*, *voltage* and *current*, *across* and *through*, *open circuit* and *short circuit*, *spring* and *mass*, and *displacement* and *velocity* are interchanged (in either direction), the four statements previously given for capacitors are obtained.

# PRACTICAL APPLICATION

## In Search of the Missing Element

So far, we have been introduced to three different two-terminal passive elements: the *resistor*, the *capacitor*, and the *inductor*. Each has been defined in terms of its current-voltage relationship ( $v = Ri$ ,  $i = C dv/dt$ , and  $v = L di/dt$ , respectively). From a more fundamental perspective, however, we can view these three elements as part of a larger picture relating four basic quantities, namely, charge  $q$ , current  $i$ , voltage  $v$ , and flux linkage  $\varphi$ . Charge, current, and voltage are discussed in Chap. 2. Flux linkage is the product of magnetic flux and the number of turns of conducting wire linked by the flux, and it can be expressed in terms of the voltage  $v$  across the coil as  $\varphi = \int v dt$  or  $v = d\varphi/dt$ .

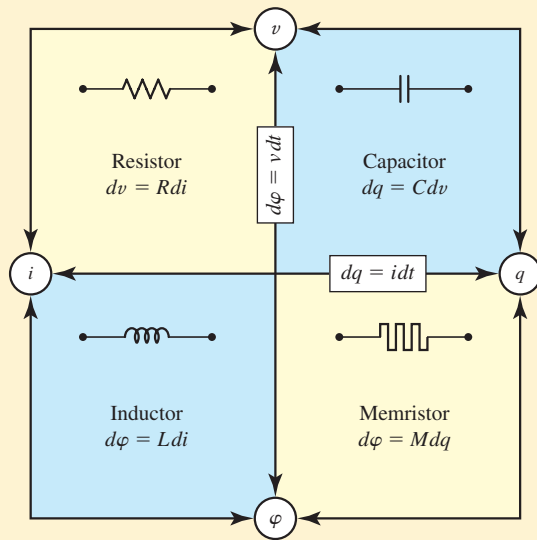

■ FIGURE 7.17 A graphical representation of the four basic two-terminal passive elements (resistor, capacitor, inductor, and memristor) and their interrelationships. Note that flux linkage is more commonly represented by the Greek letter  $\lambda$  to distinguish it from flux: then  $\lambda = N\varphi$  where  $N$  is the number of turns and  $\varphi$  is the flux. (Reprinted by permission from Macmillan Publishers Ltd. Nature Publishing Group, “Electronics: The Fourth Element,” Volume 453, pg. 42, 2008.)

Figure 7.17 graphically represents how these four quantities are interrelated. First, apart from any circuit elements and their characteristics, we have  $dq = i dt$  (Chap. 2) and now  $d\varphi = v dt$ . Charge is related to voltage in the context of a capacitor, since  $C = dq/dv$  or  $dq = C dv$ . The element we call a resistor provides a

direct relationship between voltage and current, which for consistency can be expressed as  $dv = R di$ . Continuing our counterclockwise journey around the perimeter of Fig. 7.17, we note that our original expression connecting the voltage and current associated with an inductor can be written in terms of current  $i$  and flux linkage  $\varphi$ , since rearranging yields  $v dt = L di$ , and we know  $d\varphi = v dt$ . Thus, for the inductor, we can write  $d\varphi = L di$ .

So far, we have traveled from  $q$  to  $v$  with the aid of a capacitor,  $v$  to  $i$  using the resistor, and  $i$  to  $\varphi$  using the inductor. However, we have not yet used any element to connect  $\varphi$  and  $q$ , although symmetry suggests such a thing should be possible. In the early 1970s, Leon Chua found himself thinking along these lines, and postulated a new device—a “missing” two-terminal circuit element—and named it the *memristor*.<sup>1</sup> He went on to demonstrate that the electrical characteristics of a memristor should be nonlinear, and depend on its history—in other words, a memristor might be characterized by having a memory (hence its name). Independent of his work, others had proposed a similar device, not so much for its practical use in real circuits, but for its potential in device modeling and signal processing.

Not a great deal was heard of this hypothetical element afterward, at least until Dmitri Strukov and coworkers at HP Labs in Palo Alto published a short paper in 2008 claiming to have “found” the memristor.<sup>2</sup> They offer several reasons why it took almost four decades to realize the general type of device Chua hypothesized in 1971, but one of the most interesting has to do with size. In making their prototype memristor, *nanotechnology* (the art of fabricating devices with at least one dimension less than 1000 nm, which is approximately 1% of the diameter of human hair) played a key role. A 5 nm thick oxide layer sandwiched between platinum electrodes comprises the entire device. The nonlinear electrical characteristics of the prototype immediately generated considerable excitement, most notably for its potential applications in integrated circuits, where devices are already approaching their smallest realistic size; and many believe new types of devices will be required to further extend integrated circuit density and functionality. Whether the memristor is the circuit element that will allow this remains to be seen—despite the report of a prototype, there remains much work to be done before it becomes practical.

(1) L. O. Chua, “Memristor—The missing circuit element,” *IEEE Transactions on Circuit Theory* CT-18 (5), 1971, p. 507.

(2) D. B. Strukov, G. S. Snider, D. R. Stewart, and R. S. Williams, “The missing memristor found,” *Nature* 453, 2008, p. 80.

## 7.3 INDUCTANCE AND CAPACITANCE COMBINATIONS

Now that we have added the inductor and capacitor to our list of passive circuit elements, we need to decide whether or not the methods we have developed for resistive circuit analysis are still valid. It will also be convenient to learn how to replace series and parallel combinations of either of these elements with simpler equivalents, just as we did with resistors in Chap. 3.

We look first at Kirchhoff's two laws, both of which are axiomatic. However, when we hypothesized these two laws, we did so with no restrictions as to the types of elements constituting the network. Both, therefore, remain valid.

### Inductors in Series

Now we may extend the procedures we have derived for reducing various combinations of resistors into one equivalent resistor to the analogous cases of inductors and capacitors. We shall first consider an ideal voltage source applied to the series combination of  $N$  inductors, as shown in Fig. 7.18a. We desire a single equivalent inductor, with inductance  $L_{\text{eq}}$ , which may replace the series combination so that the source current  $i(t)$  is unchanged. The equivalent circuit is sketched in Fig. 7.18b. Applying KVL to the original circuit,

$$\begin{aligned} v_s &= v_1 + v_2 + \cdots + v_N \\ &= L_1 \frac{di}{dt} + L_2 \frac{di}{dt} + \cdots + L_N \frac{di}{dt} \\ &= (L_1 + L_2 + \cdots + L_N) \frac{di}{dt} \end{aligned}$$

or, written more concisely,

$$v_s = \sum_{n=1}^N v_n = \sum_{n=1}^N L_n \frac{di}{dt} = \frac{di}{dt} \sum_{n=1}^N L_n$$

But for the equivalent circuit we have

$$v_s = L_{\text{eq}} \frac{di}{dt}$$

and thus the equivalent inductance is

$$L_{\text{eq}} = L_1 + L_2 + \cdots + L_N$$

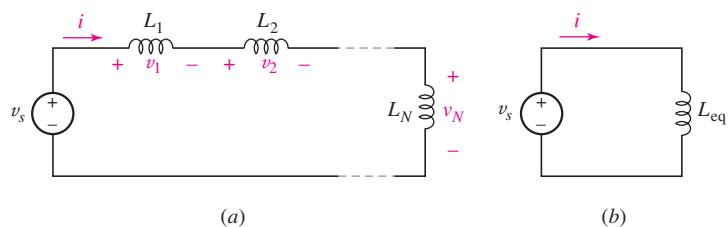

■ FIGURE 7.18 (a) A circuit containing  $N$  inductors in series. (b) The desired equivalent circuit, in which  $L_{\text{eq}} = L_1 + L_2 + \cdots + L_N$ .

or

$$L_{\text{eq}} = \sum_{n=1}^N L_n \quad [11]$$

The inductor which is equivalent to several inductors connected in series is one whose inductance is the sum of the inductances in the original circuit. *This is exactly the same result we obtained for resistors in series.*

## Inductors in Parallel

The combination of a number of parallel inductors is accomplished by writing the single nodal equation for the original circuit, shown in Fig. 7.19a,

$$\begin{aligned} i_s &= \sum_{n=1}^N i_n = \sum_{n=1}^N \left[ \frac{1}{L_n} \int_{t_0}^t v dt' + i_n(t_0) \right] \\ &= \left( \sum_{n=1}^N \frac{1}{L_n} \right) \int_{t_0}^t v dt' + \sum_{n=1}^N i_n(t_0) \end{aligned}$$

and comparing it with the result for the equivalent circuit of Fig. 7.19b,

$$i_s = \frac{1}{L_{\text{eq}}} \int_{t_0}^t v dt' + i_s(t_0)$$

Since Kirchhoff's current law demands that  $i_s(t_0)$  be equal to the sum of the branch currents at  $t_0$ , the two integral terms must also be equal; hence,

$$L_{\text{eq}} = \frac{1}{1/L_1 + 1/L_2 + \cdots + 1/L_N} \quad [12]$$

For the special case of two inductors in parallel,

$$L_{\text{eq}} = \frac{L_1 L_2}{L_1 + L_2} \quad [13]$$

and we note that inductors in parallel combine exactly as do resistors in parallel.

## Capacitors in Series

In order to find a capacitor that is equivalent to  $N$  capacitors in series, we use the circuit of Fig. 7.20a and its equivalent in Fig. 7.20b to write

$$\begin{aligned} v_s &= \sum_{n=1}^N v_n = \sum_{n=1}^N \left[ \frac{1}{C_n} \int_{t_0}^t i dt' + v_n(t_0) \right] \\ &= \left( \sum_{n=1}^N \frac{1}{C_n} \right) \int_{t_0}^t i dt' + \sum_{n=1}^N v_n(t_0) \end{aligned}$$

and

$$v_s = \frac{1}{C_{\text{eq}}} \int_{t_0}^t i dt' + v_s(t_0)$$

However, Kirchhoff's voltage law establishes the equality of  $v_s(t_0)$  and the sum of the capacitor voltages at  $t_0$ ; thus

$$C_{\text{eq}} = \frac{1}{1/C_1 + 1/C_2 + \cdots + 1/C_N} \quad [14]$$

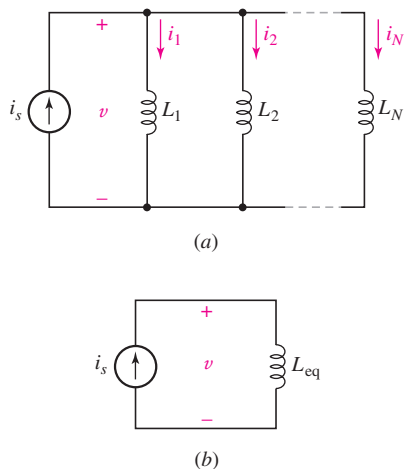

■ FIGURE 7.19 (a) The parallel combination of  $N$  inductors. (b) The equivalent circuit, where  $L_{\text{eq}} = [1/L_1 + 1/L_2 + \cdots + 1/L_N]^{-1}$ .

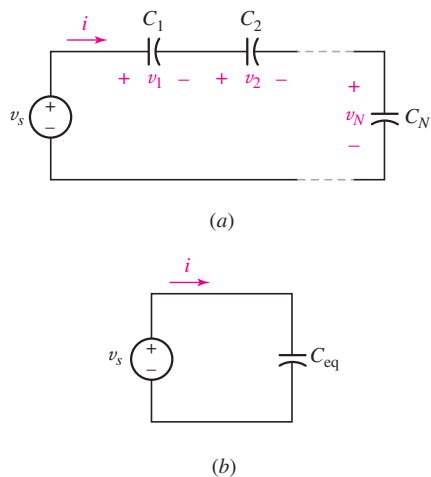

■ FIGURE 7.20 (a) A circuit containing  $N$  capacitors in series. (b) The desired equivalent circuit, where  $C_{\text{eq}} = [1/C_1 + 1/C_2 + \cdots + 1/C_N]^{-1}$ .

and capacitors in series combine as do conductances in series, or resistors in parallel. The special case of two capacitors in series, of course, yields

$$C_{\text{eq}} = \frac{C_1 C_2}{C_1 + C_2} \quad [15]$$

## Capacitors in Parallel

Finally, the circuits of Fig. 7.21 enable us to establish the value of the capacitor which is equivalent to  $N$  parallel capacitors as

$$C_{\text{eq}} = C_1 + C_2 + \cdots + C_N \quad [16]$$

and it is no great source of amazement to note that capacitors in parallel combine in the same manner in which we combine resistors in series, that is, by simply adding all the individual capacitances.

These formulas are well worth memorizing. The formulas applying to series and parallel combinations of inductors are identical to those for resistors, so they typically seem “obvious.” Care should be exercised, however, in the case of the corresponding expressions for series and parallel combinations of capacitors, as they are opposite those of resistors and inductors, frequently leading to errors when calculations are made too hastily.

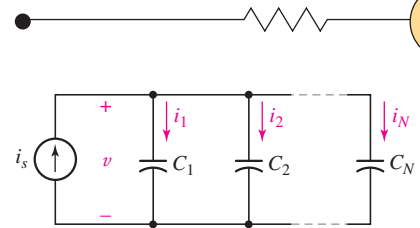

(a)

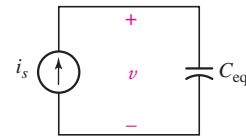

(b)

■ FIGURE 7.21 (a) The parallel combination of  $N$  capacitors. (b) The equivalent circuit, where  $C_{\text{eq}} = C_1 + C_2 + \cdots + C_N$ .



### Simplify the network of Fig. 7.22a using series-parallel combinations.

The  $6 \mu\text{F}$  and  $3 \mu\text{F}$  series capacitors are first combined into a  $2 \mu\text{F}$  equivalent, and this capacitor is then combined with the  $1 \mu\text{F}$  element with which it is in parallel to yield an equivalent capacitance of  $3 \mu\text{F}$ . In addition, the  $3 \text{ H}$  and  $2 \text{ H}$  inductors are replaced by an equivalent  $1.2 \text{ H}$  inductor, which is then added to the  $0.8 \text{ H}$  element to give a total equivalent inductance of  $2 \text{ H}$ . The much simpler (and probably less expensive) equivalent network is shown in Fig. 7.22b.

### PRACTICE

7.8 Find  $C_{\text{eq}}$  for the network of Fig. 7.23.

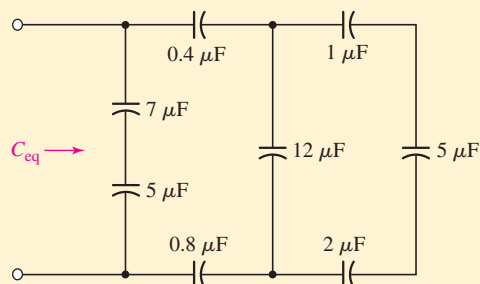

■ FIGURE 7.23

Ans:  $3.18 \mu\text{F}$ .

### EXAMPLE 7.8

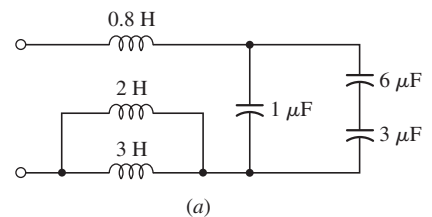

(a)

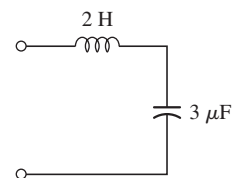

(b)

■ FIGURE 7.22 (a) A given LC network. (b) A simpler equivalent circuit.

The network shown in Fig. 7.24 contains three inductors and three capacitors, but no series or parallel combinations of either the inductors or the capacitors can be achieved. Simplification of this network cannot be accomplished using the techniques presented here.

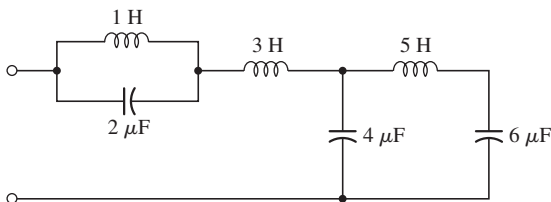

■ FIGURE 7.24 An LC network in which no series or parallel combinations of either the inductors or the capacitors can be made.

## 7.4 CONSEQUENCES OF LINEARITY

Next let us turn to nodal and mesh analysis. Since we already know that we may safely apply Kirchhoff's laws, we can apply them in writing a set of equations that are both sufficient and independent. They will be constant-coefficient linear integrodifferential equations, however, which are hard enough to pronounce, let alone solve. Consequently, we shall write them now to gain familiarity with the use of Kirchhoff's laws in RLC circuits and discuss the solution of the simpler cases in subsequent chapters.

### EXAMPLE 7.9

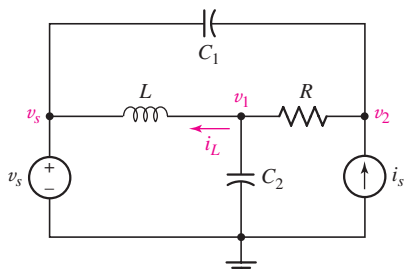

■ FIGURE 7.25 A four-node RLC circuit with node voltages assigned.

#### Write appropriate nodal equations for the circuit of Fig. 7.25.

Node voltages are already chosen, so we sum currents leaving the central node:

$$\frac{1}{L} \int_{t_0}^t (v_1 - v_s) dt' + i_L(t_0) + \frac{v_1 - v_2}{R} + C_2 \frac{dv_1}{dt} = 0$$

where  $i_L(t_0)$  is the value of the inductor current at the time the integration begins. At the right-hand node,

$$C_1 \frac{d(v_2 - v_s)}{dt} + \frac{v_2 - v_1}{R} - i_s = 0$$

Rewriting these two equations, we have

$$\begin{aligned} \frac{v_1}{R} + C_2 \frac{dv_1}{dt} + \frac{1}{L} \int_{t_0}^t v_1 dt' - \frac{v_2}{R} &= \frac{1}{L} \int_{t_0}^t v_s dt' - i_L(t_0) \\ -\frac{v_1}{R} + \frac{v_2}{R} + C_1 \frac{dv_2}{dt} &= C_1 \frac{dv_s}{dt} + i_s \end{aligned}$$

These are the promised integrodifferential equations, and we note several interesting points about them. First, the source voltage  $v_s$  happens to enter the equations as an integral and as a derivative, but not simply as  $v_s$ . Since both sources are specified for all time, we should be able to evaluate the derivative or integral. Second, the initial value of the inductor current,  $i_L(t_0)$ , acts as a (constant) source current at the center node.



## PRACTICE

7.9 If  $v_C(t) = 4 \cos 10^5 t$  V in the circuit in Fig. 7.26, find  $v_s(t)$ .

Ans:  $-2.4 \cos 10^5 t$  V.

We will not attempt the solution of integrodifferential equations here. It is worthwhile pointing out, however, that when the voltage forcing functions are sinusoidal functions of time, it will be possible to define a voltage-current ratio (called **impedance**) or a current-voltage ratio (called **admittance**) for each of the three passive elements. The factors operating on the two node voltages in the preceding equations will then become simple multiplying factors, and the equations will be linear algebraic equations once again. These we may solve by determinants or a simple elimination of variables as before.

We may also show that the benefits of linearity apply to *RLC* circuits as well. In accordance with our previous definition of a linear circuit, these circuits are also linear because the voltage-current relationships for the inductor and capacitor are linear relationships. For the inductor, we have

$$v = L \frac{di}{dt}$$

and multiplication of the current by some constant  $K$  leads to a voltage that is also greater by a factor  $K$ . In the integral formulation,

$$i(t) = \frac{1}{L} \int_{t_0}^t v dt' + i(t_0)$$

it can be seen that, if each term is to increase by a factor of  $K$ , then the initial value of the current must also increase by this same factor.

A corresponding investigation of the capacitor shows that it, too, is linear. Thus, a circuit composed of independent sources, linear dependent sources, and linear resistors, inductors, and capacitors is a linear circuit.

In this linear circuit the response is again proportional to the forcing function. The proof of this statement is accomplished by first writing a general system of integrodifferential equations. Let us place all the terms having the form of  $Ri$ ,  $L di/dt$ , and  $1/C \int i dt$  on the left side of each equation, and keep the independent source voltages on the right side. As a simple example, one of the equations might have the form

$$Ri + L \frac{di}{dt} + \frac{1}{C} \int_{t_0}^t i dt' + v_C(t_0) = v_s$$

If every independent source is now increased by a factor  $K$ , then the right side of each equation is greater by the factor  $K$ . Now each term on the left side is either a linear term involving some loop current or an initial capacitor voltage. In order to cause all the responses (loop currents) to increase by a factor  $K$ , it is apparent that we must also increase the initial capacitor voltages by a factor  $K$ . That is, we must treat the initial capacitor voltage as an independent source voltage and increase it also by a factor  $K$ . In a similar manner, initial inductor currents appear as independent source currents in nodal analysis.

The principle of proportionality between source and response can thus be extended to the general *RLC* circuit, and it follows that the principle of superposition also applies. It should be emphasized that initial inductor

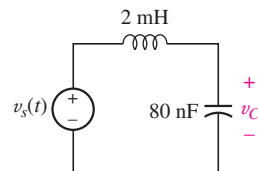

FIGURE 7.26

currents and capacitor voltages must be treated as independent sources in applying the superposition principle; each initial value must take its turn in being rendered inactive. In Chap. 5 we learned that the principle of superposition is a natural consequence of the linear nature of resistive circuits. The resistive circuits are linear because the voltage-current relationship for the resistor is linear and Kirchhoff's laws are linear.

Before we can apply the superposition principle to  $RLC$  circuits, however, it is first necessary to develop methods of solving the equations describing these circuits when only one independent source is present. At this time we should feel convinced that a linear circuit will possess a response whose amplitude is proportional to the amplitude of the source. We should be prepared to apply superposition later, considering an inductor current or capacitor voltage specified at  $t = t_0$  as a source that must be deactivated when its turn comes.

Thévenin's and Norton's theorems are based on the linearity of the initial circuit, the applicability of Kirchhoff's laws, and the superposition principle. The general  $RLC$  circuit conforms perfectly to these requirements, and it follows, therefore, that all linear circuits that contain any combinations of independent voltage and current sources, linear dependent voltage and current sources, and linear resistors, inductors, and capacitors may be analyzed with the use of these two theorems, if we wish.

## 7.5 SIMPLE OP AMP CIRCUITS WITH CAPACITORS

In Chap. 6 we were introduced to several different types of amplifier circuits based on the ideal op amp. In almost every case, we found that the output was related to the input voltage by some combination of resistance ratios. If we replace one or more of these resistors with a capacitor, it is possible to obtain some interesting circuits in which the output is proportional to either the derivative or integral of the input voltage. Such circuits find widespread use in practice. For example, a velocity sensor can be connected to an op amp circuit that provides a signal proportional to the acceleration, or an output signal can be obtained that represents the total charge incident on a metal electrode during a specific period of time by simply integrating the measured current.

To create an integrator using an ideal op amp, we ground the noninverting input, install an ideal capacitor as a feedback element from the output back to the inverting input, and connect a signal source  $v_s$  to the inverting input through an ideal resistor as shown in Fig. 7.27.

Performing nodal analysis at the inverting input,

$$0 = \frac{v_a - v_s}{R_1} + i$$

We can relate the current  $i$  to the voltage across the capacitor,

$$i = C_f \frac{dv_{C_f}}{dt}$$

resulting in

$$0 = \frac{v_a - v_s}{R_1} + C_f \frac{dv_{C_f}}{dt}$$

Invoking ideal op amp rule 2, we know that  $v_a = v_b = 0$ , so

$$0 = \frac{-v_s}{R_1} + C_f \frac{dv_{C_f}}{dt}$$

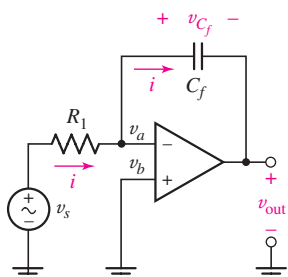

■ FIGURE 7.27 An ideal op amp connected as an integrator.

Integrating and solving for  $v_{\text{out}}$ , we obtain

$$v_{C_f} = v_a - v_{\text{out}} = 0 - v_{\text{out}} = \frac{1}{R_1 C_f} \int_0^t v_s dt' + v_{C_f}(0)$$

or

$$v_{\text{out}} = -\frac{1}{R_1 C_f} \int_0^t v_s dt' - v_{C_f}(0) \quad [17]$$

We therefore have combined a resistor, a capacitor, and an op amp to form an integrator. Note that the first term of the output is  $1/RC$  times the negative of the integral of the input from  $t' = 0$  to  $t$ , and the second term is the negative of the initial value of  $v_{C_f}$ . The value of  $(RC)^{-1}$  can be made equal to unity, if we wish, by choosing  $R = 1 \text{ M}\Omega$  and  $C = 1 \mu\text{F}$ , for example; other selections may be made that will increase or decrease the output voltage.

Before we leave the integrator circuit, we might anticipate a question from an inquisitive reader, “*Could we use an inductor in place of the capacitor and obtain a differentiator?*” Indeed we could, but circuit designers usually avoid the use of inductors whenever possible because of their size, weight, cost, and associated resistance and capacitance. Instead, it is possible to interchange the positions of the resistor and capacitor in Fig. 7.27 and obtain a differentiator.

### EXAMPLE 7.10

Derive an expression for the output voltage of the op amp circuit shown in Fig. 7.28.

We begin by writing a nodal equation at the inverting input pin, with  $v_{C_1} \triangleq v_a - v_s$ :

$$0 = C_1 \frac{dv_{C_1}}{dt} + \frac{v_a - v_{\text{out}}}{R_f}$$

Invoking ideal op amp rule 2,  $v_a = v_b = 0$ . Thus,

$$C_1 \frac{dv_{C_1}}{dt} = \frac{v_{\text{out}}}{R_f}$$

Solving for  $v_{\text{out}}$ ,

$$v_{\text{out}} = R_f C_1 \frac{dv_{C_1}}{dt}$$

Since  $v_{C_1} = v_a - v_s = -v_s$ ,

$$v_{\text{out}} = -R_f C_1 \frac{dv_s}{dt}$$

So, simply by swapping the resistor and capacitor in the circuit of Fig. 7.27, we obtain a differentiator instead of an integrator.

### PRACTICE

7.10 Derive an expression for  $v_{\text{out}}$  in terms of  $v_s$  for the circuit shown in Fig. 7.29.

Ans:  $v_{\text{out}} = -L_f/R_1 dv_s/dt$ .

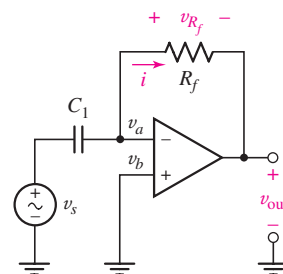

FIGURE 7.28 An ideal op amp connected as a differentiator.

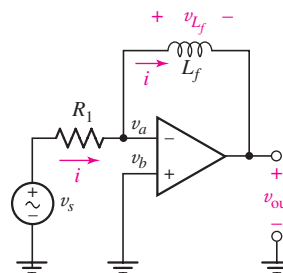

FIGURE 7.29

## 7.6 DUALITY

The concept of **duality** applies to many fundamental engineering concepts. In this section, we shall define duality in terms of the circuit equations. Two circuits are “duals” if the mesh equations that characterize one of them have the *same mathematical form* as the nodal equations that characterize the other. They are said to be exact duals if each mesh equation of one circuit is numerically identical with the corresponding nodal equation of the other; the current and voltage variables themselves cannot be identical, of course. Duality itself merely refers to any of the properties exhibited by dual circuits.

Let us use the definition to construct an exact dual circuit by writing the two mesh equations for the circuit shown in Fig. 7.30. Two mesh currents  $i_1$  and  $i_2$  are assigned, and the mesh equations are

$$3i_1 + 4 \frac{di_1}{dt} - 4 \frac{di_2}{dt} = 2 \cos 6t \quad [18]$$

$$-4 \frac{di_1}{dt} + 4 \frac{di_2}{dt} + \frac{1}{8} \int_0^t i_2 dt' + 5i_2 = -10 \quad [19]$$

We may now construct the two equations that describe the exact dual of our circuit. We wish these to be nodal equations, and thus begin by replacing the mesh currents  $i_1$  and  $i_2$  in Eqs. [18] and [19] by the two nodal voltages  $v_1$  and  $v_2$ , respectively. We obtain

$$3v_1 + 4 \frac{dv_1}{dt} - 4 \frac{dv_2}{dt} = 2 \cos 6t \quad [20]$$

$$-4 \frac{dv_1}{dt} + 4 \frac{dv_2}{dt} + \frac{1}{8} \int_0^t v_2 dt' + 5v_2 = -10 \quad [21]$$

and we now seek the circuit represented by these two nodal equations.

Let us first draw a line to represent the reference node, and then we may establish two nodes at which the positive references for  $v_1$  and  $v_2$  are located. Equation [20] indicates that a current source of  $2 \cos 6t$  A is connected between node 1 and the reference node, oriented to provide a current entering node 1. This equation also shows that a 3 S conductance appears between node 1 and the reference node. Turning to Eq. [21], we first consider the nonmutual terms, i.e., those terms which do not appear in Eq. [20], and they instruct us to connect an 8 H inductor and a 5 S conductance (in parallel) between node 2 and the reference. The two similar terms in Eqs. [20] and [21] represent a 4 F capacitor present mutually at nodes 1 and 2; the circuit is completed by connecting this capacitor between the two nodes. The constant term on the right side of Eq. [21] is the value of the inductor current at  $t = 0$ ; in other words,  $i_L(0) = 10$  A. The dual circuit is shown in Fig. 7.31; since the two sets of equations are numerically identical, the circuits are exact duals.

Dual circuits may be obtained more readily than by this method, for the equations need not be written. In order to construct the dual of a given circuit, we think of the circuit in terms of its mesh equations. With each mesh we must associate a nonreference node, and, in addition, we must supply the reference node. On a diagram of the given circuit we therefore place a

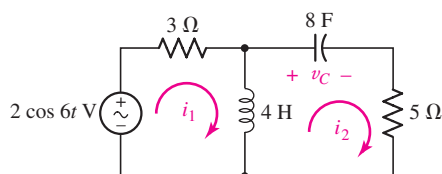

■ FIGURE 7.30 A given circuit to which the definition of duality may be applied to determine the dual circuit. Note that  $v_C(0) = 10$  V.

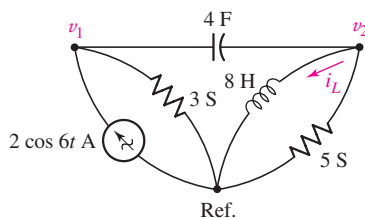

■ FIGURE 7.31 The exact dual of the circuit of Fig. 7.30.

node in the center of each mesh and supply the reference node as a line near the diagram or a loop enclosing the diagram. Each element that appears jointly in two meshes is a mutual element and gives rise to identical terms, except for sign, in the two corresponding mesh equations. It must be replaced by an element that supplies the dual term in the two corresponding nodal equations. This dual element must therefore be connected directly between the two nonreference nodes that are within the meshes in which the given mutual element appears.

The nature of the dual element itself is easily determined; the mathematical form of the equations will be the same only if inductance is replaced by capacitance, capacitance by inductance, conductance by resistance, and resistance by conductance. Thus, the 4 H inductor which is common to meshes 1 and 2 in the circuit of Fig. 7.30 appears as a 4 F capacitor connected directly between nodes 1 and 2 in the dual circuit.

Elements that appear only in one mesh must have duals that appear between the corresponding node and the reference node. Referring again to Fig. 7.30, the voltage source  $2 \cos 6t$  V appears only in mesh 1; its *dual* is a current source  $2 \cos 6t$  A, which is connected only to node 1 and the reference node. Since the voltage source is clockwise-sensed, the current source must be into-the-nonreference-node-sensed. Finally, provision must be made for the dual of the initial voltage present across the 8 F capacitor in the given circuit. The equations have shown us that the dual of this initial voltage across the capacitor is an initial current through the inductor in the dual circuit; the numerical values are the same, and the correct sign of the initial current may be determined most readily by considering both the initial voltage in the given circuit and the initial current in the dual circuit as sources. Thus, if  $v_C$  in the given circuit is treated as a source, it would appear as  $-v_C$  on the right side of the mesh equation; in the dual circuit, treating the current  $i_L$  as a source would yield a term  $-i_L$  on the right side of the nodal equation. Since each has the same sign when treated as a source, then, if  $v_C(0) = 10$  V,  $i_L(0)$  must be 10 A.

The circuit of Fig. 7.30 is repeated in Fig. 7.32, and its exact dual is constructed on the circuit diagram itself by merely drawing the dual of each given element between the two nodes that are inside the two meshes that are common to the given element. A reference node that surrounds the given circuit may be helpful. After the dual circuit is redrawn in more standard form, it appears as shown in Fig. 7.31.

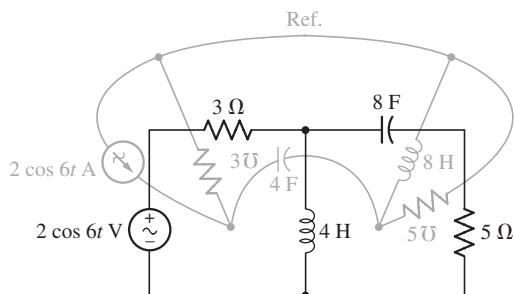

■ FIGURE 7.32 The dual of the circuit of Fig. 7.30 is constructed directly from the circuit diagram.

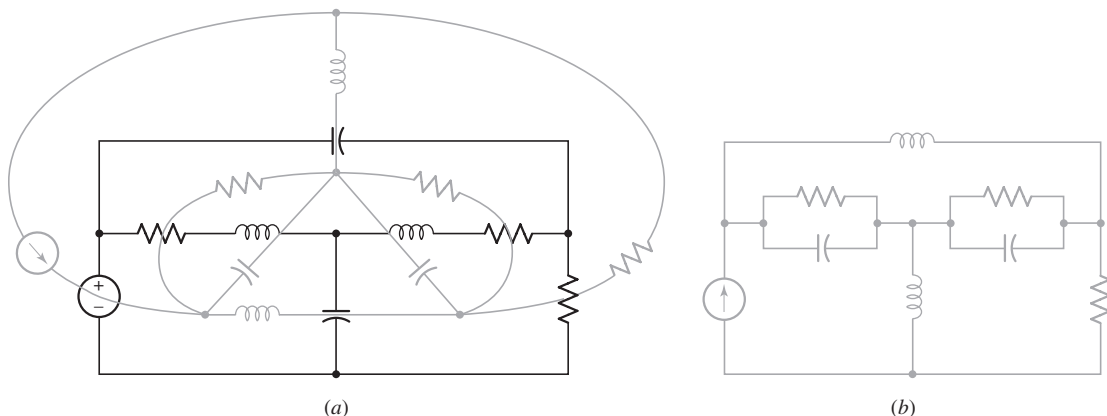

FIGURE 7.33 (a) The dual (in gray) of a given circuit (in black) is constructed on the given circuit. (b) The dual circuit is drawn in more conventional form for comparison to the original.

An additional example of the construction of a dual circuit is shown in Fig. 7.33a and b. Since no particular element values are specified, these two circuits are duals, but not necessarily exact duals. The original circuit may be recovered from the dual by placing a node in the center of each of the five meshes of Fig. 7.33b and proceeding as before.

The concept of duality may also be carried over into the language by which we describe circuit analysis or operation. For example, if we are given a voltage source in series with a capacitor, we might wish to make the important statement, “*The voltage source causes a current to flow through the capacitor.*” The dual statement is, “*The current source causes a voltage to exist across the inductor.*” The dual of a less carefully worded statement, such as “*The current goes round and round the series circuit,*” may require a little inventiveness.<sup>4</sup>

Practice in using dual language can be obtained by reading Thévenin’s theorem in this sense; Norton’s theorem should result.

We have spoken of dual elements, dual language, and dual circuits. What about a dual network? Consider a resistor  $R$  and an inductor  $L$  in series. The dual of this two-terminal network exists and is most readily obtained by connecting some ideal source to the given network. The dual circuit is then obtained as the dual source in parallel with a conductance  $G$  with the same magnitude as  $R$ , and a capacitance  $C$  having the same magnitude as  $L$ . We consider the dual network as the two-terminal network that is connected to the dual source; it is thus a pair of terminals between which  $G$  and  $C$  are connected in parallel.

Before leaving the definition of duality, we should point out that duality is defined on the basis of mesh and nodal equations. Since nonplanar circuits cannot be described by a system of mesh equations, a circuit that cannot be drawn in planar form does not possess a dual.

We shall use duality principally to reduce the work that we must do to analyze the simple standard circuits. After we have analyzed the series  $RL$  circuit, the parallel  $RC$  circuit requires less attention, not because it is less important, but because the analysis of the dual network is already known. Since the analysis of some complicated circuit is not apt to be well known, duality will usually not provide us with any quick solution.

(4) Someone suggested, “The voltage is across all over the parallel circuit.”

## PRACTICE

7.11 Write the single nodal equation for the circuit of Fig. 7.34a, and show, by direct substitution, that  $v = -80e^{-10^6 t}$  mV is a solution. Knowing this, find (a)  $v_1$ ; (b)  $v_2$ ; and (c)  $i$  for the circuit of Fig. 7.34b.

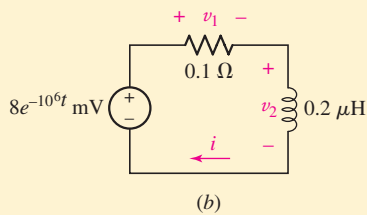
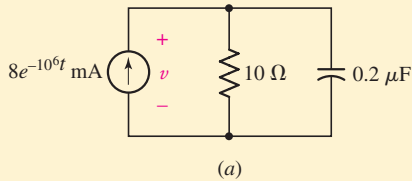

FIGURE 7.34

Ans:  $-8e^{-10^6 t}$  mV;  $16e^{-10^6 t}$  mV;  $-80e^{-10^6 t}$  mA.

## 7.7 MODELING CAPACITORS AND INDUCTORS WITH PSpICE

When using PSpice to analyze circuits containing inductors and capacitors, it is frequently necessary to be able to specify the initial condition of each element [i.e.,  $v_C(0)$  and  $i_L(0)$ ]. This is achieved by double-clicking on the element symbol, resulting in the dialog box shown in Fig. 7.35a. At the far right (not shown), we find the value of the capacitance, which defaults to 1 nF. We can also specify the initial condition (IC), set to 2 V in Fig. 7.35a. Clicking on the right mouse button and selecting **Display** results in the dialog box shown in Fig. 7.35b, which allows the initial condition to be displayed on the schematic. The procedure for setting the initial condition of an inductor is essentially the same. We should also note that when a capacitor is first placed in the schematic, it appears horizontally; the positive reference terminal for the initial voltage is the *left* terminal.

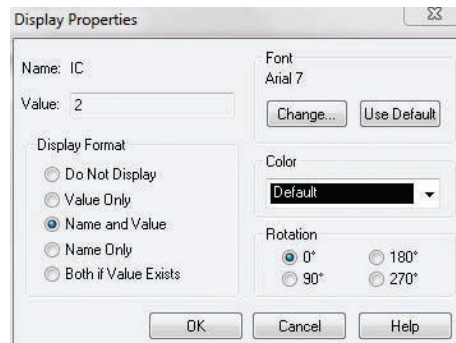
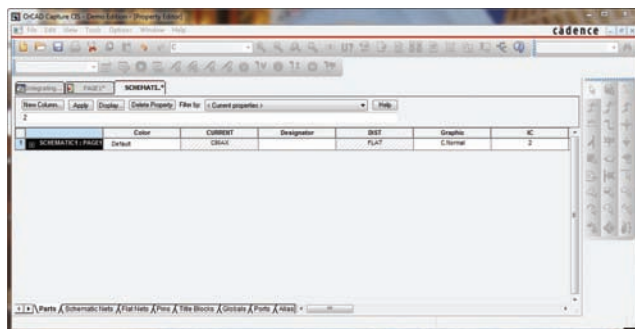
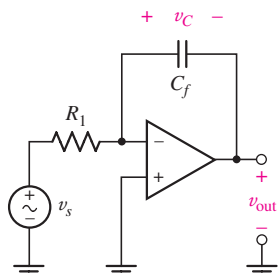

FIGURE 7.35 (a) Capacitor property editor window. (b) Display Properties dialog box, obtained by right-clicking in the IC box.

## EXAMPLE 7.11



■ FIGURE 7.36 An integrating op amp circuit.

Simulate the output voltage waveform of the circuit in Fig. 7.36 if  $v_s = 1.5 \sin 100t$  V,  $R_1 = 10$  k $\Omega$ ,  $C_f = 4.7$   $\mu$ F, and  $v_C(0) = 2$  V.

We begin by drawing the circuit schematic, making sure to set the initial voltage across the capacitor (Fig. 7.37). Note that we had to convert the frequency from 100 rad/s to  $100/2\pi = 15.92$  Hz.

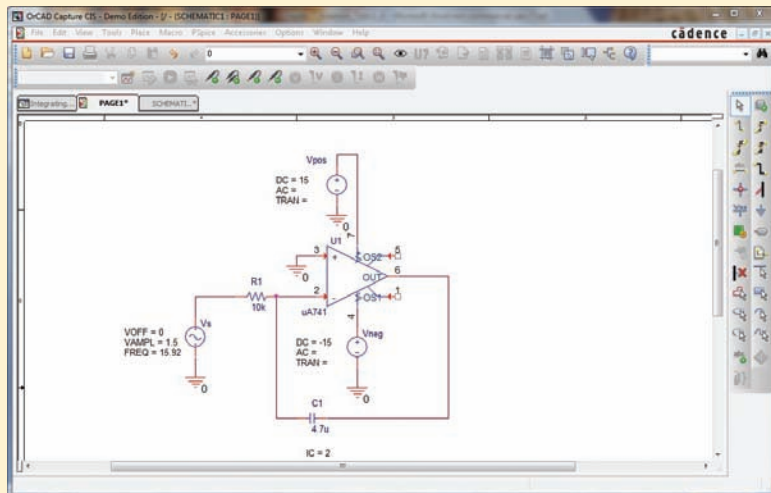

■ FIGURE 7.37 The schematic representation of the circuit shown in Fig. 7.36, with the initial capacitor voltage set to 2 V.

In order to obtain time-varying voltages and currents, we need to perform what is referred to as a *transient analysis*. Under the **PSpice** menu, we create a **New Simulation Profile** named **op amp integrator**, which leads to the dialog box recreated in Fig. 7.38. **Run to time** represents the

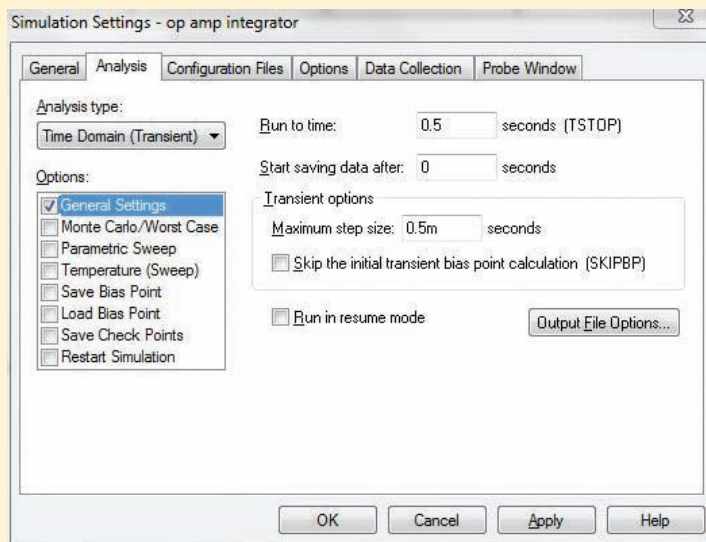

■ FIGURE 7.38 Dialog box for setting up a transient analysis. We choose a final time of 0.5 s to obtain several periods of the output waveform ( $1/15.92 \approx 0.06$  s).



time at which the simulation is terminated; PSpice will select its own discrete times at which to calculate the various voltages and currents. Occasionally we obtain an error message stating that the transient solution could not converge, or the output waveform does not appear as smooth as we would like. In such situations, it is useful to set a value for **Maximum step size**, which has been set to 0.5 ms in this example.

From our earlier analysis and Eq. [17], we expect the output to be proportional to the negative integral of the input waveform, i.e.,  $v_{\text{out}} = 0.319 \cos 100t - 2.319 \text{ V}$ , as shown in Fig. 7.39. The initial condition of 2 V across the capacitor has combined with a constant term from the integration to result in a *nonzero average value* for the output, unlike the input which has an average value of zero.

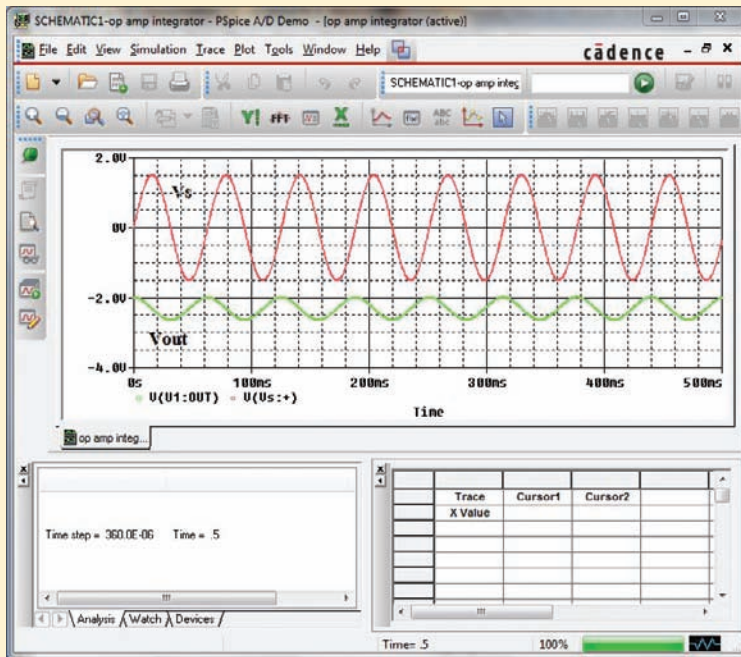

■ FIGURE 7.39 Probe output for the simulated integrator circuit along with the input waveform for comparison.

## SUMMARY AND REVIEW

A large number of practical circuits can be effectively modeled using only resistors and voltage/current sources. However, most interesting everyday occurrences somehow involve something changing with time, and in such cases intrinsic capacitances and/or inductances can become important. We employ such energy storage elements consciously as well, for example, in the design of frequency-selective filters, capacitor banks, and electric vehicle motors. An *ideal* capacitor is modeled as having infinite shunt resistance, and a current which depends on the time rate of change of the terminal voltage. Capacitance is measured in units of *farads* (F). Conversely, an *ideal* inductor is modeled as having zero series resistance, and a terminal voltage which depends on the time rate of change of the current. Inductance is measured in

units of *henrys* (H). Either element can *store energy*; the amount of energy present in a capacitor (stored in its electric field) is proportional to the *square* of the terminal voltage, and the amount of energy present in an inductor (stored in its magnetic field) is proportional to the *square* of its current.

As we found for resistors, we can simplify some connections of capacitors (or inductors) using series/parallel combinations. The validity of such equivalents arises from KCL and KVL. Once we have simplified a circuit as much as possible (taking care not to “combine away” a component which is used to define a current or voltage of interest to us), nodal and mesh analysis can be applied to circuits with capacitors and inductors. However, the resulting integrodifferential equations are often nontrivial to solve, and so we will consider some practical approaches in the next two chapters. Simple circuits, however, such as those which involve a single operational amplifier, can be analyzed easily. We found (to our surprise) that such circuits can be used as signal *integrators* or *differentiators*. Consequently, they provide an output signal that tells us how some input quantity (accumulating charge during ion implantation into a silicon wafer, for example) varies with time.

As a final note, capacitors and inductors provide a particularly strong example of the concept known as *duality*. KCL and KVL, mesh and nodal analysis are other examples. Circuits are rarely analyzed using this idea, but it is nevertheless important, since the implication is that we only need to learn roughly “half” of the complete set of concepts, and then determine how to translate the remainder. Some people find this helpful; others don’t. Regardless, capacitors and inductors are straightforward to model in PSpice and other circuit simulation tools, allowing us to check our answers. The difference between those elements and resistors in such software packages is that we must take care to *set the initial condition properly*.

As an additional review aid, here we list some key points from the chapter, and identify relevant example(s).

- The current through a capacitor is given by  $i = C dv/dt$ . (Example 7.1)
- The voltage across a capacitor is related to its current by

$$v(t) = \frac{1}{C} \int_{t_0}^t i(t') dt' + v(t_0)$$

(Example 7.2)

- A capacitor is an *open circuit* to dc voltages. (Example 7.1)
- The voltage across an inductor is given by  $v = L di/dt$ . (Examples 7.4, 7.5)
- The current through an inductor is related to its voltage by

$$i(t) = \frac{1}{L} \int_{t_0}^t v dt' + i(t_0)$$

(Example 7.6)

- An inductor is a *short circuit* to dc currents. (Examples 7.4, 7.5)
- The energy presently stored in a capacitor is given by  $\frac{1}{2}Cv^2$ , whereas the energy presently stored in an inductor is given by  $\frac{1}{2}Li^2$ ; both are referenced to a time at which no energy was stored. (Examples 7.3, 7.7)
- Series and parallel combinations of inductors can be combined using the same equations as for resistors. (Example 7.8)

- Series and parallel combinations of capacitors work the *opposite* way as they do for resistors. (Example 7.8)
- Since capacitors and inductors are linear elements, KVL, KCL, superposition, Thévenin's and Norton's theorems, and nodal and mesh analysis apply to their circuits as well. (Example 7.9)
- A capacitor as the feedback element in an inverting op amp leads to an output voltage proportional to the *integral* of the input voltage. Swapping the input resistor and the feedback capacitor leads to an output voltage proportional to the *derivative* of the input voltage. (Example 7.10)
- PSpice allows us to set the initial voltage across a capacitor, and the initial current through an inductor. A transient analysis provides details of the time-dependent response of circuits containing these types of elements. (Example 7.11)

## READING FURTHER

A detailed guide to characteristics and selection of various capacitor and inductor types can be found in:

H. B. Drexler, *Passive Electronic Component Handbook*, 2nd ed., C. A. Harper, ed. New York: McGraw-Hill, 2003, pp. 69–203.

C. J. Kaiser, *The Inductor Handbook*, 2nd ed. Olathe, Kans.: C.J. Publishing, 1996.

Two books that describe capacitor-based op amp circuits are:

R. Mancini (ed.), *Op Amps Are For Everyone*, 2nd ed. Amsterdam: Newnes, 2003.

W. G. Jung, *Op Amp Cookbook*, 3rd ed. Upper Saddle River, N.J.: Prentice-Hall, 1997.

## EXERCISES

### 7.1 The Capacitor

1. Making use of the passive sign convention, determine the current flowing through a 220 nF capacitor for  $t \geq 0$  if its voltage  $v_C(t)$  is given by (a)  $-3.35$  V; (b)  $16.2e^{-9t}$  V; (c)  $8 \cos 0.01t$  mV; (d)  $5 + 9 \sin 0.08t$  V.
2. Sketch the current flowing through a 13 pF capacitor for  $t \geq 0$  as a result of the waveforms shown in Fig. 7.40. Assume the passive sign convention.

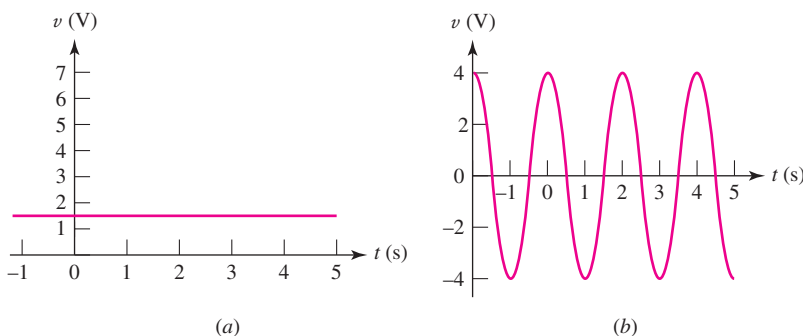

■ FIGURE 7.40

3. (a) If the voltage waveform depicted in Fig. 7.41 is applied across the terminals of a  $1\ \mu\text{F}$  electrolytic capacitor, graph the resulting current, assuming the passive sign convention. (b) Repeat part (a) if the capacitor is replaced with a  $17.5\ \text{pF}$  capacitor.

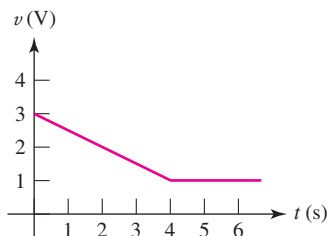

■ FIGURE 7.41

4. A capacitor is constructed from two copper plates, each measuring  $1\ \text{mm} \times 2.5\ \text{mm}$  and  $155\ \mu\text{m}$  thick. The two plates are placed such that they face each other and are separated by a  $1\ \mu\text{m}$  gap. Calculate the resulting capacitance if (a) the intervening dielectric has a permittivity of  $1.35\epsilon_0$ ; (b) the intervening dielectric has a permittivity of  $3.5\epsilon_0$ ; (c) the plate separation is increased by  $3.5\ \mu\text{m}$  and the gap is filled with air; (d) the plate area is doubled and the  $1\ \mu\text{m}$  gap is filled with air.
5. Two pieces of gadolinium, each measuring  $100\ \mu\text{m} \times 750\ \mu\text{m}$  and  $604\ \text{nm}$  thick, are used to construct a capacitor. The two plates are arranged such that they face each other and are separated by a  $100\ \text{nm}$  gap. Calculate the resulting capacitance if (a) the intervening dielectric has a permittivity of  $13.8\epsilon_0$ ; (b) the intervening dielectric has a permittivity of  $500\epsilon_0$ ; (c) the plate separation is increased by  $100\ \text{nm}$  and the gap is filled with air; (d) the plate area is quadrupled and the  $100\ \text{nm}$  gap is filled with air.
- DP** 6. Design a  $100\ \text{nF}$  capacitor constructed from  $1\ \mu\text{m}$  thick gold foil, and which fits entirely within a volume equal to that of a standard AAA battery, if the only dielectric available has a permittivity of  $3.1\epsilon_0$ .
- DP** 7. Design a capacitor whose capacitance can be varied mechanically with a simple vertical motion, between the values of  $100\ \text{nF}$  and  $300\ \text{nF}$ .
- DP** 8. Design a capacitor whose capacitance can be varied mechanically over the range of  $50\ \text{nF}$  and  $100\ \text{nF}$  by rotating a knob  $90^\circ$ .
9. A silicon  $pn$  junction diode is characterized by a junction capacitance defined as

$$C_j = \frac{K_s \epsilon_0 A}{W}$$

where  $K_s = 11.8$  for silicon,  $\epsilon_0$  is the vacuum permittivity,  $A$  = the cross-sectional area of the junction, and  $W$  is known as the depletion width of the junction. Width  $W$  depends not only on how the diode is fabricated, but also on the voltage applied to its two terminals. It can be computed using

$$W = \sqrt{\frac{2K_s \epsilon_0}{qN} (V_{\text{bi}} - V_A)}$$

Thus, diodes are frequently used in electronic circuits, since they can be thought of as voltage-controlled capacitors. Assuming parameter values of  $N = 10^{18}\ \text{cm}^{-3}$ ,  $V_{\text{bi}} = 0.57\ \text{V}$ , and using  $q = 1.6 \times 10^{-19}\ \text{C}$ , calculate the capacitance of a diode with cross-sectional area  $A = 1\ \mu\text{m} \times 1\ \mu\text{m}$  at applied voltages of  $V_A = -1, -5,$  and  $-10$  volts.

10. Assuming the passive sign convention, sketch the voltage which develops across the terminals of a  $2.5\ \text{F}$  capacitor in response to the current waveforms shown in Fig. 7.42.

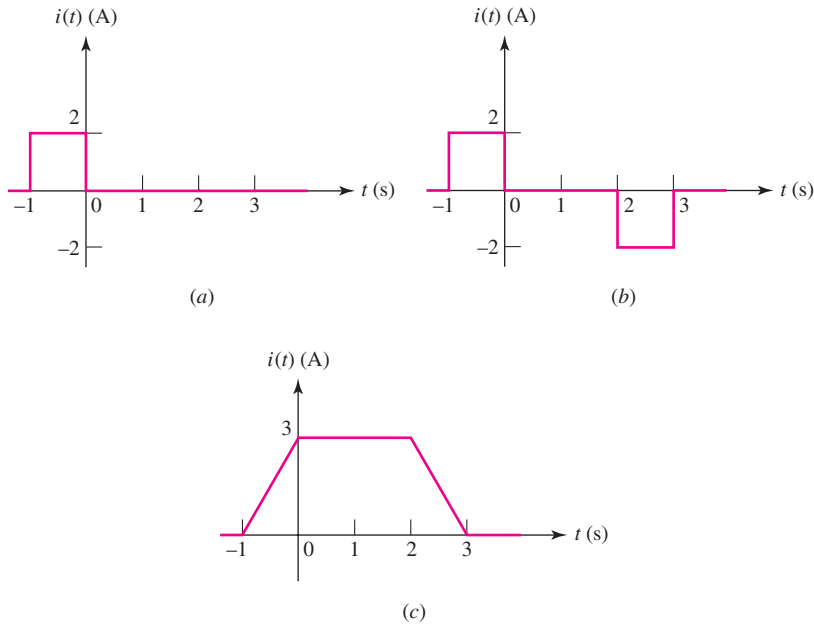

■ FIGURE 7.42

11. The current flowing through a 33 mF capacitor is shown graphically in Fig. 7.43. (a) Assuming the passive sign convention, sketch the resulting voltage waveform across the device. (b) Compute the voltage at 300 ms, 600 ms, and 1.1 s.

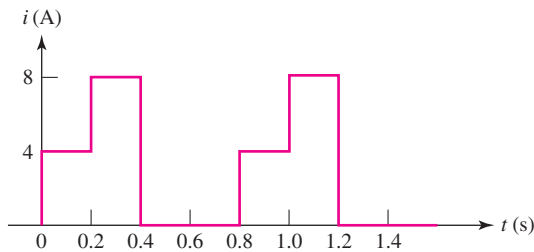

■ FIGURE 7.43

12. Calculate the energy stored in a capacitor at time  $t = 1$  s if (a)  $C = 1.4$  F and  $v_C = 8$  V,  $t > 0$ ; (b)  $C = 23.5$  pF and  $v_C = 0.8$  V,  $t > 0$ ; (c)  $C = 17$  nF,  $v_C(1) = 12$  V,  $v_C(0) = 2$  V, and  $w_C(0) = 295$  nJ.
13. A 137 pF capacitor is connected to a voltage source such that  $v_C(t) = 12e^{-2t}$  V,  $t \geq 0$  and  $v_C(t) = 12$  V,  $t < 0$ . Calculate the energy stored in the capacitor at  $t$  equal to (a) 0; (b) 200 ms; (c) 500 ms; (d) 1 s.
14. Calculate the power dissipated in the  $40\ \Omega$  resistor and the voltage labeled  $v_C$  in each of the circuits depicted in Fig. 7.44.

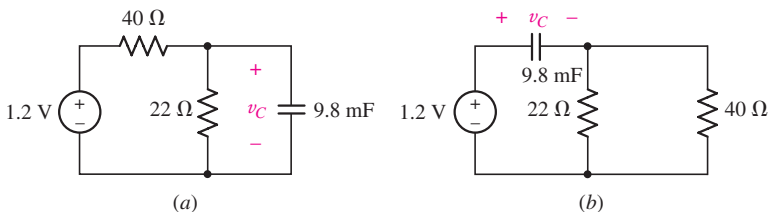

■ FIGURE 7.44

15. For each circuit shown in Fig. 7.45, calculate the voltage labeled  $v_C$ .

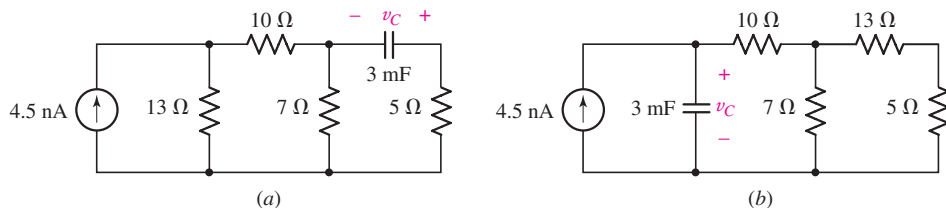

FIGURE 7.45

## 7.2 The Inductor



16. Design a 30 nH inductor using 29 AWG solid soft copper wire. Include a sketch of your design and label geometrical parameters as necessary for clarity. Assume the coil is filled with air only.

17. If the current flowing through a 75 mH inductor has the waveform shown in Fig. 7.46, (a) sketch the voltage which develops across the inductor terminals for  $t \geq 0$ , assuming the passive sign convention; and (b) calculate the voltage at  $t = 1$  s, 2.9 s, and 3.1 s.

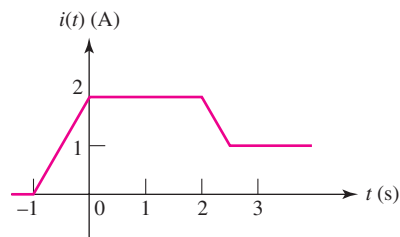

FIGURE 7.46

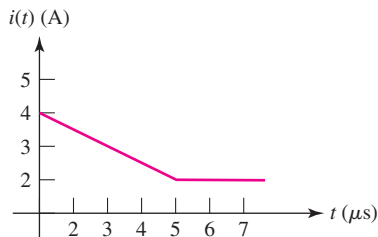

FIGURE 7.47

18. The current through a 17 nH aluminum inductor is shown in Fig. 7.47. Sketch the resulting voltage waveform for  $t \geq 0$ , assuming the passive sign convention.

19. Determine the voltage for  $t \geq 0$  which develops across the terminals of a 4.2 mH inductor, if the current (defined consistent with the passive sign convention) is (a)  $-10$  mA; (b)  $3 \sin 6t$  A; (c)  $11 + 115\sqrt{2} \cos(100\pi t - 9^\circ)$  A; (d)  $13e^{-t}$  nA; (e)  $3 + te^{-14t}$  A.

20. Determine the voltage for  $t \geq 0$  which develops across the terminals of an 8 pH inductor, if the current (defined consistent with the passive sign convention) is (a) 8 mA; (b) 800 mA; (c) 8 A; (d)  $4e^{-t}$  A; (e)  $-3 + te^{-t}$  A.

21. Calculate  $v_L$  and  $i_L$  for each of the circuits depicted in Fig. 7.48, if  $i_s = 1$  mA and  $v_s = 2.1$  V.

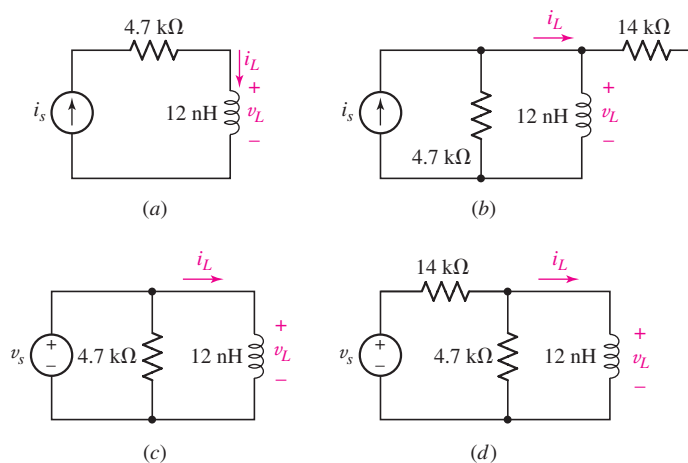
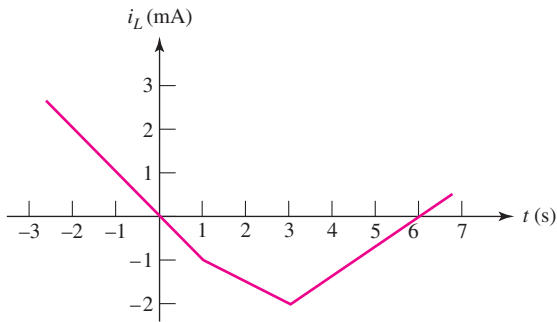

FIGURE 7.48

22. The current waveform shown in Fig. 7.14 has a rise time of 0.1 (100 ms) and a fall time of the same duration. If the current is applied to the “+” voltage reference terminal of a 200 nH inductor, sketch the expected voltage waveform if the rise and fall times are changed, respectively, to (a) 200 ms, 200 ms; (b) 10 ms, 50 ms; (c) 10 ns, 20 ns.
23. Determine the inductor voltage which results from the current waveform shown in Fig. 7.49 (assuming the passive sign convention) at  $t$  equal to (a)  $-1$  s; (b) 0 s; (c) 1.5 s; (d) 2.5 s; (e) 4 s; (f) 5 s.



■ FIGURE 7.49

24. Determine the current flowing through a 6 mH inductor if the voltage (defined such that it is consistent with the passive sign convention) is given by (a) 5 V; (b)  $100 \sin 120\pi t$ ,  $t \geq 0$  and 0,  $t < 0$ .
25. The voltage across a 2 H inductor is given by  $v_L = 4.3t$ ,  $0 \leq t \leq 50$  ms. With the knowledge that  $i_L(-0.1) = 100 \mu\text{A}$ , calculate the current (assuming it is defined consistent with the passive sign convention) at  $t$  equal to (a) 0; (b) 1.5 ms; (c) 45 ms.
26. Calculate the energy stored in a 1 nH inductor if the current flowing through it is (a) 0 mA; (b) 1 mA; (c) 20 A; (d)  $5 \sin 6t$  mA,  $t > 0$ .
27. Determine the amount of energy stored in a 33 mH inductor at  $t = 1$  ms as a result of a current  $i_L$  given by (a) 7 A; (b)  $3 - 9e^{-10^3 t}$  mA.
28. Making the assumption that the circuits in Fig. 7.50 have been connected for a very long time, determine the value for each current labeled  $i_x$ .

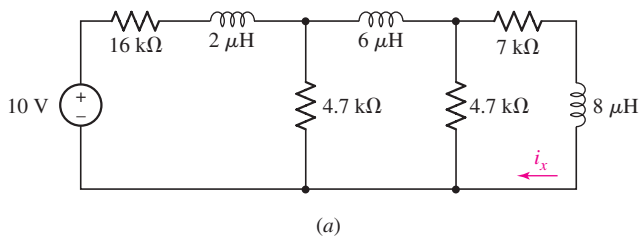

(a)

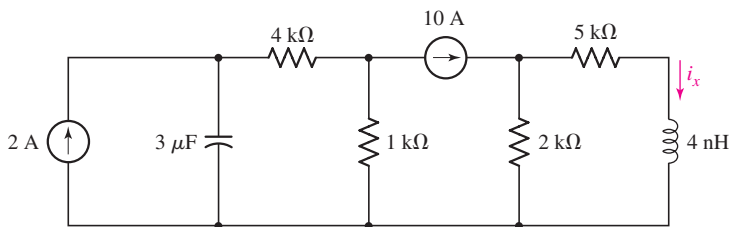

(b)

■ FIGURE 7.50

29. Calculate the voltage labeled  $v_x$  in Fig. 7.51, assuming the circuit has been running a very long time, if (a) a  $10\ \Omega$  resistor is connected between terminals  $x$  and  $y$ ; (b) a  $1\ \text{H}$  inductor is connected between terminals  $x$  and  $y$ ; (c) a  $1\ \text{F}$  capacitor is connected between terminals  $x$  and  $y$ ; (d) a  $4\ \text{H}$  inductor in parallel with a  $1\ \Omega$  resistor is connected between terminals  $x$  and  $y$ .

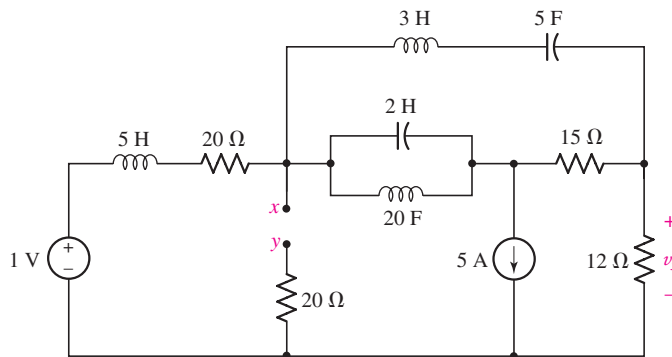

■ FIGURE 7.51

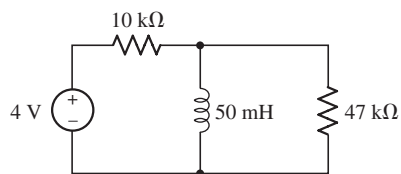

■ FIGURE 7.52

30. For the circuit shown in Fig. 7.52, (a) compute the Thévenin equivalent seen by the inductor; (b) determine the power being dissipated by both resistors; (c) calculate the energy stored in the inductor.

### 7.3 Inductance and Capacitance Combinations

31. If each capacitor has a value of  $1\ \text{F}$ , determine the equivalent capacitance of the network shown in Fig. 7.53.
32. Determine an equivalent inductance for the network shown in Fig. 7.54 if each inductor has value  $L$ .

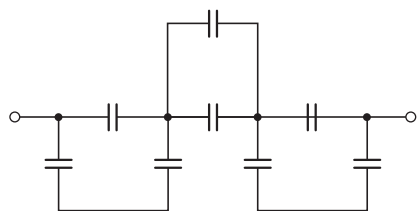

■ FIGURE 7.53

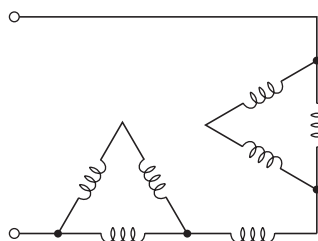

■ FIGURE 7.54

- DP 33. Using as many  $1\ \text{nH}$  inductors as you like, design two networks, each of which has an equivalent inductance of  $1.25\ \text{nH}$ .
34. Compute the equivalent capacitance  $C_{eq}$  as labeled in Fig. 7.55.

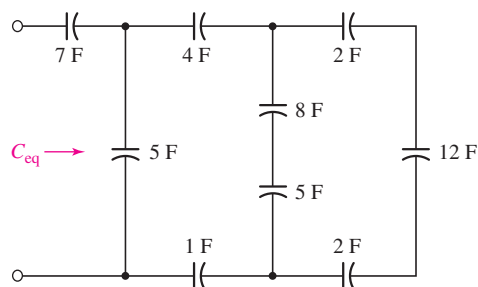

■ FIGURE 7.55



35. Determine the equivalent capacitance  $C_{eq}$  of the network shown in Fig. 7.56.

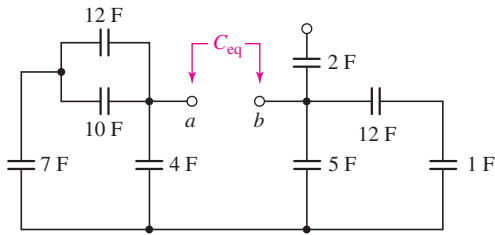

■ FIGURE 7.56

36. Apply combinatorial techniques as appropriate to obtain a value for the equivalent inductance  $L_{eq}$  as labeled on the network of Fig. 7.57.

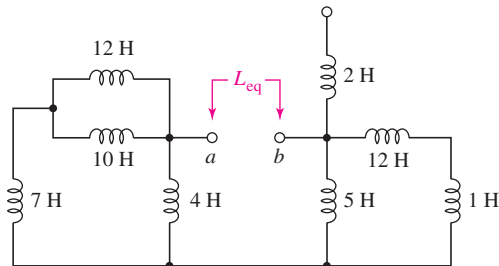

■ FIGURE 7.57

37. Reduce the circuit depicted in Fig. 7.58 to as few components as possible.

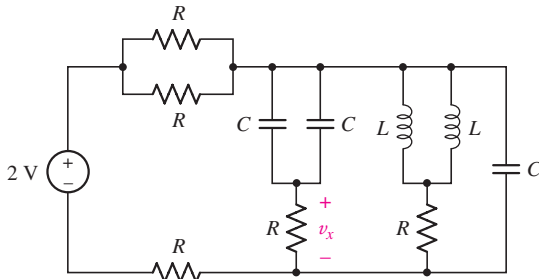

■ FIGURE 7.58

38. Refer to the network shown in Fig. 7.59 and find (a)  $R_{eq}$  if each element is a  $10 \Omega$  resistor; (b)  $L_{eq}$  if each element is a  $10 \text{ H}$  inductor; and (c)  $C_{eq}$  if each element is a  $10 \text{ F}$  capacitor.
39. Determine the equivalent inductance seen looking into the terminals marked  $a$  and  $b$  of the network represented in Fig. 7.60.

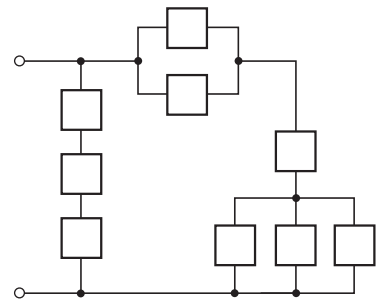

■ FIGURE 7.59

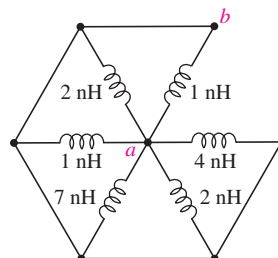

■ FIGURE 7.60

40. Reduce the circuit represented in Fig. 7.61 to the smallest possible number of components.

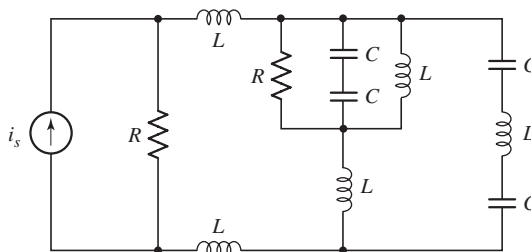

■ FIGURE 7.61

41. Reduce the network of Fig. 7.62 to the smallest possible number of components if each inductor is 1 nH and each capacitor is 1 mF.

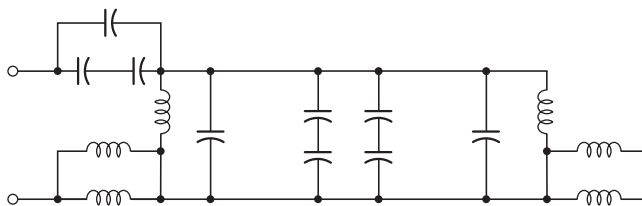

■ FIGURE 7.62

42. For the network of Fig. 7.63,  $L_1 = 1$  H,  $L_2 = L_3 = 2$  H,  $L_4 = L_5 = L_6 = 3$  H. (a) Find the equivalent inductance. (b) Derive an expression for a general network of this type having  $N$  stages, assuming stage  $N$  is composed of  $N$  inductors, each having inductance  $N$  henrys.

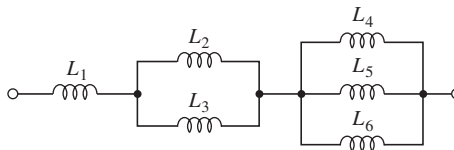

■ FIGURE 7.63

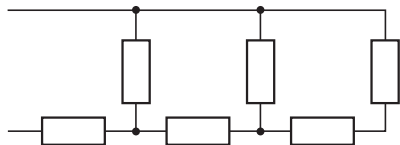

■ FIGURE 7.64

43. Extend the concept of  $\Delta$ -Y transformations to simplify the network of Fig. 7.64 if each element is a 2 pF capacitor.
44. Extend the concept of  $\Delta$ -Y transformations to simplify the network of Fig. 7.64 if each element is a 1 nH inductor.

## 7.4 Consequences of Linearity

45. With regard to the circuit represented in Fig. 7.65, (a) write a complete set of nodal equations and (b) write a complete set of mesh equations.

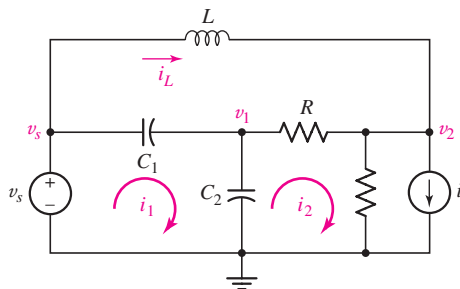

■ FIGURE 7.65

46. (a) Write nodal equations for the circuit of Fig. 7.66. (b) Write mesh equations for the same circuit.
47. In the circuit shown in Fig. 7.67, let  $i_s = 60e^{-200t}$  mA with  $i_1(0) = 20$  mA.  
 (a) Find  $v(t)$  for all  $t$ . (b) Find  $i_1(t)$  for  $t \geq 0$ . (c) Find  $i_2(t)$  for  $t \geq 0$ .
48. Let  $v_s = 100e^{-80t}$  V and  $v_1(0) = 20$  V in the circuit of Fig. 7.68. (a) Find  $i(t)$  for all  $t$ . (b) Find  $v_1(t)$  for  $t \geq 0$ . (c) Find  $v_2(t)$  for  $t \geq 0$ .

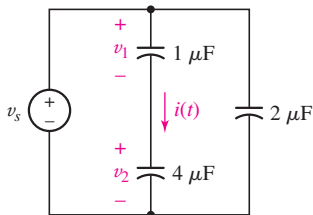

■ FIGURE 7.68

49. If it is assumed that all the sources in the circuit of Fig. 7.69 have been connected and operating for a very long time, use the superposition principle to find  $v_C(t)$  and  $v_L(t)$ .

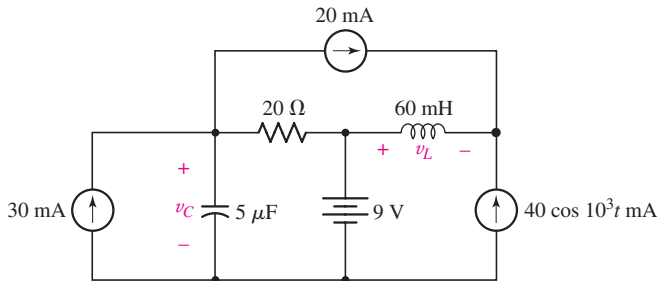

■ FIGURE 7.69

50. For the circuit of Fig. 7.70, assume no energy is stored at  $t = 0$ , and write a complete set of nodal equations.

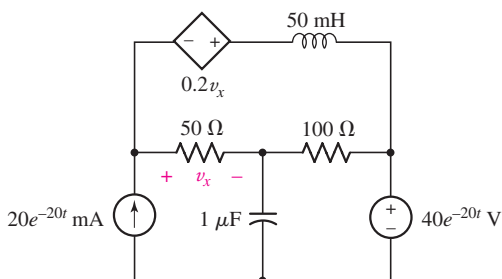

■ FIGURE 7.70

## 7.5 Simple Op Amp Circuits with Capacitors

51. Interchange the location of  $R_1$  and  $C_f$  in the circuit of Fig. 7.27, and assume that  $R_i = \infty$ ,  $R_o = 0$ , and  $A = \infty$  for the op amp. (a) Find  $v_{out}(t)$  as a function of  $v_s(t)$ . (b) Obtain an equation relating  $v_o(t)$  and  $v_s(t)$  if  $A$  is not assumed to be infinite.
52. For the integrating amplifier circuit of Fig. 7.27,  $R_1 = 100$  k $\Omega$ ,  $C_f = 500$   $\mu$ F, and  $v_s = 20 \sin 540t$  mV. Calculate  $v_{out}$  if (a)  $A = \infty$ ,  $R_i = \infty$ , and  $R_o = 0$ ; (b)  $A = 5000$ ,  $R_i = 1$  M $\Omega$ , and  $R_o = 3$   $\Omega$ .

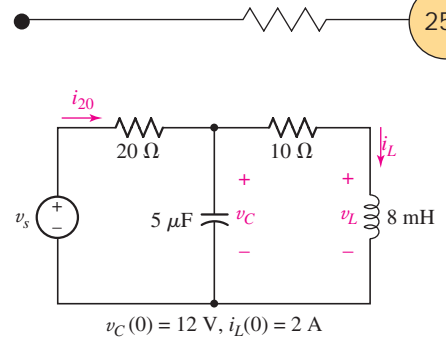

■ FIGURE 7.66

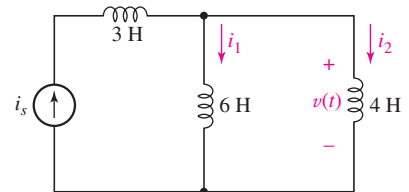

■ FIGURE 7.67

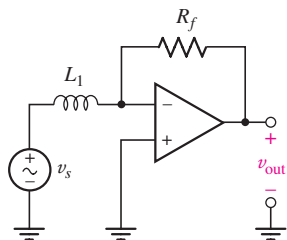

FIGURE 7.71

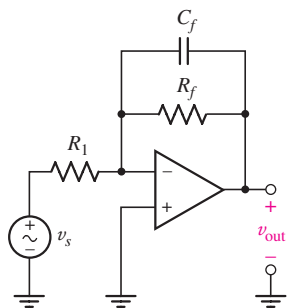

FIGURE 7.72

53. Derive an expression for  $v_{out}$  in terms of  $v_s$  for the amplifier circuit shown in Fig. 7.71.

54. In practice, circuits such as those depicted in Fig. 7.27 may not function correctly unless there is a conducting pathway between the output and input terminals of the op amp. (a) Analyze the modified integrating amplifier circuit shown in Fig. 7.72 to obtain an expression for  $v_{out}$  in terms of  $v_s$ , and (b) compare this expression to Eq. [17].

DP

55. A new piece of equipment designed to make crystals from molten constituents is experiencing too many failures (cracked products). The production manager wants to monitor the cooling rate to see if this is related to the problem. The system has two output terminals available, where the voltage across them is linearly proportional to the crucible temperature such that 30 mV corresponds to 30°C and 1 V corresponds to 1000°C. Design a circuit whose voltage output represents the cooling rate, calibrated such that 1 V = 1°C/s.

DP

56. A confectionary company has decided to increase the production rate of its milk chocolate bars to compensate for a recent increase in the cost of raw materials. However, the wrapping unit cannot accept more than 1 bar per second, or it drops bars. A 200 mV peak-to-peak sinusoidal voltage signal is available from the bar-making system which feeds into the wrapping unit, such that its frequency matches the bar production frequency (i.e., 1 Hz = 1 bar/s). Design a circuit that provides a voltage output sufficient to power a 12 V audible alarm when the production rate exceeds the capacity of the wrapping unit.

DP

57. One problem satellites face is exposure to high-energy particles, which can cause damage to sensitive electronics as well as solar arrays used to provide power. A new communications satellite is equipped with a high-energy proton detector measuring 1 cm × 1 cm. It provides a current directly equal to the number of protons impinging the surface per second. Design a circuit whose output voltage provides a running total of the number of proton hits, calibrated such that 1 V = 1 million hits.

DP

58. The output of a velocity sensor attached to a sensitive piece of mobile equipment is calibrated to provide a signal such that 10 mV corresponds to linear motion at 1 m/s. If the equipment is subjected to sudden shock, it can be damaged. Since force = mass × acceleration, monitoring of the rate of change of velocity can be used to determine if the equipment is transported improperly. (a) Design a circuit to provide a voltage proportional to the linear acceleration such that 10 mV = 1 m/s<sup>2</sup>. (b) How many sensor-circuit combinations does this application require?

DP

59. A floating sensor in a certain fuel tank is connected to a variable resistor (often called a potentiometer) such that a full tank (100 liters) corresponds to 1 Ω and an empty tank corresponds to 10 Ω. (a) Design a circuit that provides an output voltage which indicates the amount of fuel remaining, so that 1 V = empty and 5 V = full. (b) Design a circuit to indicate the rate of fuel consumption by providing a voltage output calibrated to yield 1 V = 1 l/s.

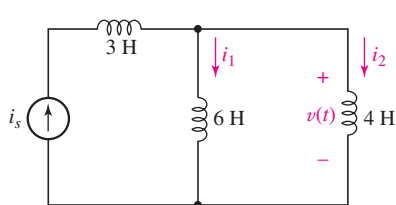

FIGURE 7.73

## 7.6 Duality

60. (a) Draw the exact dual of the circuit depicted in Fig. 7.73. (b) Label the new (dual) variables. (c) Write nodal equations for both circuits.

61. (a) Draw the exact dual of the simple circuit shown in Fig. 7.74. (b) Label the new (dual) variables. (c) Write mesh equations for both circuits.

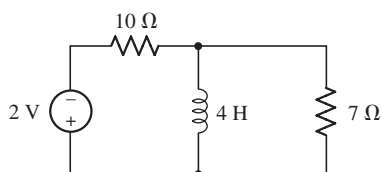
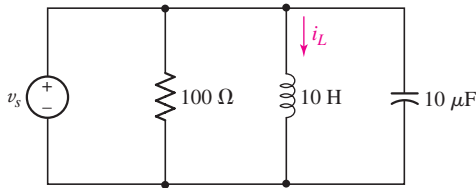

FIGURE 7.74

62. (a) Draw the exact dual of the simple circuit shown in Fig. 7.75. (b) Label the new (dual) variables. (c) Write mesh equations for both circuits.



■ FIGURE 7.75

63. (a) Draw the exact dual of the simple circuit shown in Fig. 7.76. (b) Label the new (dual) variables. (c) Write nodal and mesh equations for both circuits.

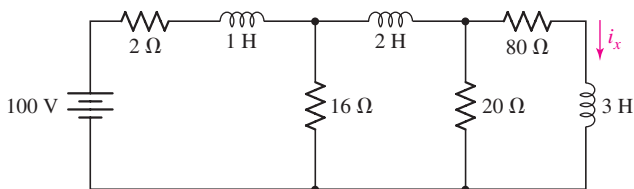

■ FIGURE 7.76

64. Draw the exact dual of the circuit shown in Fig. 7.77. Keep it neat!

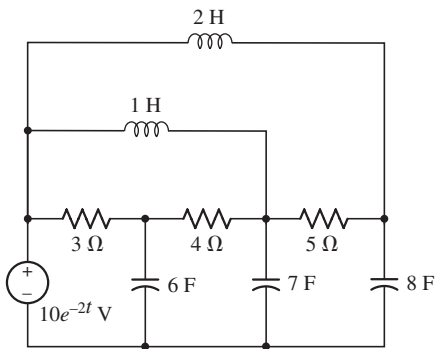

■ FIGURE 7.77

## 7.7 Modeling Capacitors and Inductors with PSpice

65. Taking the bottom node in the circuit of Fig. 7.78 as the reference terminal, calculate (a) the current through the inductor and (b) the power dissipated by the 7 Ω resistor. (c) Verify your answers with an appropriate PSpice simulation.

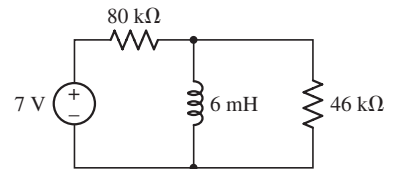

■ FIGURE 7.78

66. For the four-element circuit shown in Fig. 7.79, (a) calculate the power absorbed in each resistor; (b) determine the voltage across the capacitor; (c) compute the energy stored in the capacitor; and (d) verify your answers with an appropriate PSpice simulation. (Recall that calculations can be performed in Probe.)

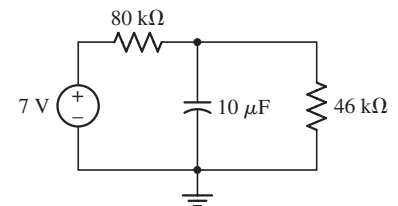

■ FIGURE 7.79



67. (a) Compute  $i_L$  and  $v_x$  as indicated in the circuit of Fig. 7.80. (b) Determine the energy stored in the inductor and in the capacitor. (c) Verify your answers with an appropriate PSpice simulation.

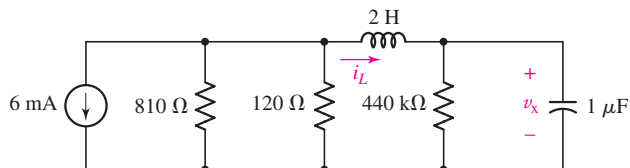

■ FIGURE 7.80

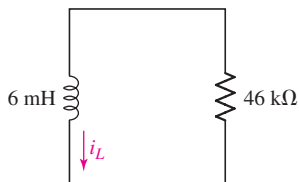

■ FIGURE 7.81

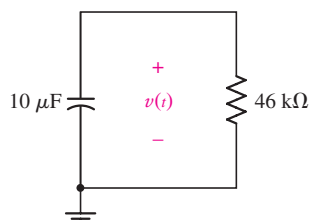

■ FIGURE 7.82



68. For the circuit depicted in Fig. 7.81, the value of  $i_L(0) = 1$  mA. (a) Compute the energy stored in the element at  $t = 0$ . (b) Perform a transient simulation of the circuit over the range of  $0 \leq t \leq 500$  ns. Determine the value of  $i_L$  at  $t = 0$ , 130 ns, 260 ns, and 500 ns. (c) What fraction of the initial energy remains in the inductor at  $t = 130$  ns? At  $t = 500$  ns?



69. Assume an initial voltage of 9 V across the  $10 \mu\text{F}$  capacitor shown in Fig. 7.82 (i.e.,  $v(0) = 9$  V). (a) Compute the initial energy stored in the capacitor. (b) For  $t > 0$ , do you expect the energy to remain in the capacitor? Explain. (c) Perform a transient simulation of the circuit over the range of  $0 \leq t \leq 2.5$  s and determine  $v(t)$  at  $t = 460$  ms, 920 ms, and 2.3 s. (c) What fraction of the initial energy remains stored in the capacitor at  $t = 460$  ms? At  $t = 2.3$  s?



70. Referring to the circuit of Fig. 7.83, (a) calculate the energy stored in each energy storage element; (b) verify your answers with an appropriate PSpice simulation.

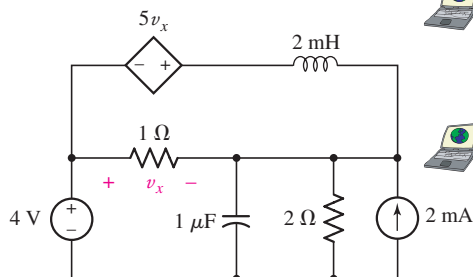

■ FIGURE 7.83



71. For the circuit of Fig. 7.28, (a) sketch  $v_{\text{out}}$  over the range of  $0 \leq t \leq 5$  ms if  $R_f = 1$  k $\Omega$ ,  $C_1 = 100$  mF, and  $v_s$  is a 1 kHz sinusoidal source having a peak voltage of 2 V. (b) Verify your answer with an appropriate transient simulation, plotting both  $v_s$  and  $v_{\text{out}}$  in Probe. (Hint: Between plotting traces, add a second y axis using **Plot, Add Y Axis**. This allows both traces to be seen clearly.)



72. (a) Sketch the output function  $v_{\text{out}}$  of the amplifier circuit in Fig. 7.29 over the range of  $0 \leq t \leq 100$  ms if  $v_s$  is a 60 Hz sinusoidal source having a peak voltage of 400 mV,  $R_1$  is 1 k $\Omega$ , and  $L_f$  is 80 nH. (b) Verify your answer with an appropriate transient simulation, plotting both  $v_s$  and  $v_{\text{out}}$  in Probe. (Hint: Between plotting traces, add a second y axis using **Plot, Add Y Axis**. This allows both traces to be seen clearly.)



73. For the circuit of Fig. 7.71, (a) sketch  $v_{\text{out}}$  over the range of  $0 \leq t \leq 2.5$  ms if  $R_f = 100$  k $\Omega$ ,  $L_1 = 100$  mH, and  $v_s$  is a 2 kHz sinusoidal source having a peak voltage of 5 V. (b) Verify your answer with an appropriate transient simulation, plotting both  $v_s$  and  $v_{\text{out}}$  in Probe. (Hint: Between plotting traces, add a second y axis using **Plot, Add Y Axis**. This allows both traces to be seen clearly.)



74. Consider the modified integrator depicted in Fig. 7.72. Take  $R_1 = 100 \Omega$ ,  $R_f = 10$  M $\Omega$ , and  $C_1 = 10$  mF. The source  $v_s$  provides a 10 Hz sinusoidal voltage having a peak amplitude of 0.5 V. (a) Sketch  $v_{\text{out}}$  over the range of  $0 \leq t \leq 500$  ms. (b) Verify your answer with an appropriate transient simulation, plotting both  $v_s$  and  $v_{\text{out}}$  in Probe. (Hint: Between plotting traces, add a second y axis using **Plot, Add Y Axis**. This allows both traces to be seen clearly.)

### Chapter-Integrating Exercises

# Basic $RL$ and $RC$ Circuits

## INTRODUCTION

In Chap. 7 we wrote equations for the response of several circuits containing both inductance and capacitance, but we did not solve any of them. Now we are ready to proceed with the solution of the simpler circuits, namely, those which contain only resistors and inductors, or only resistors and capacitors.

Although the circuits we are about to consider have a very elementary appearance, they are also of practical importance. Networks of this form find use in electronic amplifiers, automatic control systems, operational amplifiers, communications equipment, and many other applications. Familiarity with these simple circuits will enable us to predict the accuracy with which the output of an amplifier can follow an input that is changing rapidly with time, or to predict how quickly the speed of a motor will change in response to a change in its field current. Our understanding of simple  $RL$  and  $RC$  circuits will also enable us to suggest modifications to the amplifier or motor in order to obtain a more desirable response.

### 8.1 THE SOURCE-FREE $RL$ CIRCUIT

The analysis of circuits containing inductors and/or capacitors is dependent upon the formulation and solution of the integrodifferential equations that characterize the circuits. We will call the special type of equation we obtain a *homogeneous linear differential equation*, which is simply a differential equation in which every term is of the first degree in the dependent variable or one of its derivatives. A solution is obtained when we have found an expression for the

## KEY CONCEPTS

$RL$  and  $RC$  Time Constants

Natural and Forced Response

Calculating the Time-Dependent Response to DC Excitation

How to Determine Initial Conditions and Their Effect on the Circuit Response

Analyzing Circuits with Step Function Input and with Switches

Construction of Pulse Waveforms Using Unit-Step Functions

The Response of Sequentially Switched Circuits



dependent variable that satisfies both the differential equation and also the prescribed energy distribution in the inductors or capacitors at a prescribed instant of time, usually  $t = 0$ .

The solution of the differential equation represents a response of the circuit, and it is known by many names. Since this response depends upon the general “nature” of the circuit (the types of elements, their sizes, the interconnection of the elements), it is often called a *natural response*. However, any real circuit we construct cannot store energy forever; the resistances intrinsically associated with inductors and capacitors will eventually convert all stored energy into heat. The response must eventually die out, and for this reason it is frequently referred to as the *transient response*. Finally, we should also be familiar with the mathematicians’ contribution to the nomenclature; they call the solution of a homogeneous linear differential equation a *complementary function*.

When we consider independent sources acting on a circuit, part of the response will resemble the nature of the particular source (or *forcing function*) used; this part of the response, called the *particular solution*, the *steady-state response*, or the *forced response*, will be “complemented” by the complementary response produced in the source-free circuit. The complete response of the circuit will then be given by the sum of the complementary function and the particular solution. In other words, the complete response is the sum of the natural response and the forced response. The source-free response may be called the *natural response*, the *transient response*, the *free response*, or the *complementary function*, but because of its more descriptive nature, we will most often call it the *natural response*.

We will consider several different methods of solving these differential equations. The mathematical manipulation, however, is not circuit analysis. Our greatest interest lies in the solutions themselves, their meaning, and their interpretation, and we will try to become sufficiently familiar with the form of the response that we are able to write down answers for new circuits by just plain thinking. Although complicated analytical methods are needed when simpler methods fail, a well-developed intuition is an invaluable resource in such situations.

We begin our study of transient analysis by considering the simple series  $RL$  circuit shown in Fig. 8.1. Let us designate the time-varying current as  $i(t)$ ; we will represent the value of  $i(t)$  at  $t = 0$  as  $I_0$ ; in other words,  $i(0) = I_0$ . We therefore have

$$Ri + v_L = Ri + L \frac{di}{dt} = 0$$

or

$$\frac{di}{dt} + \frac{R}{L}i = 0 \quad [1]$$

Our goal is an expression for  $i(t)$  which satisfies this equation *and* also has the value  $I_0$  at  $t = 0$ . The solution may be obtained by several different methods.

## A Direct Approach

One very direct method of solving a differential equation consists of writing the equation in such a way that the variables are separated, and then

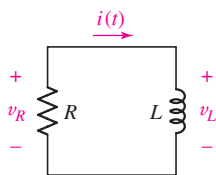

■ FIGURE 8.1 A series  $RL$  circuit for which  $i(t)$  is to be determined, subject to the initial condition that  $i(0) = I_0$ .

It may seem pretty strange to discuss a time-varying current flowing in a circuit with no sources! Keep in mind that we only know the current at the time specified as  $t = 0$ ; we don't know the current prior to that time. In the same vein, we don't know what the circuit looked like prior to  $t = 0$ , either. In order for a current to be flowing, a source had to have been present at some point, but we are not privy to this information. Fortunately, it is not required in order to analyze the circuit we are given.



integrating each side of the equation. The variables in Eq. [1] are  $i$  and  $t$ , and it is apparent that the equation may be multiplied by  $dt$ , divided by  $i$ , and arranged with the variables separated:

$$\frac{di}{i} = -\frac{R}{L} dt \quad [2]$$

Since the current is  $I_0$  at  $t = 0$  and  $i(t)$  at time  $t$ , we may equate the two definite integrals which are obtained by integrating each side between the corresponding limits:

$$\int_{I_0}^{i(t)} \frac{di'}{i'} = \int_0^t -\frac{R}{L} dt'$$

Performing the indicated integration,

$$\ln i' \Big|_{I_0}^i = -\frac{R}{L} t' \Big|_0^t$$

which results in

$$\ln i - \ln I_0 = -\frac{R}{L}(t - 0)$$

After a little manipulation, we find that the current  $i(t)$  is given by

$$i(t) = I_0 e^{-Rt/L} \quad [3]$$

We check our solution by first showing that substitution of Eq. [3] in Eq. [1] yields the identity  $0 = 0$ , and then showing that substitution of  $t = 0$  in Eq. [3] produces  $i(0) = I_0$ . Both steps are necessary; the solution must satisfy the differential equation which characterizes the circuit, and it must also satisfy the initial condition.



### EXAMPLE 8.1

If the inductor of Fig. 8.2 has a current  $i_L = 2$  A at  $t = 0$ , find an expression for  $i_L(t)$  valid for  $t > 0$ , and its value at  $t = 200 \mu\text{s}$ .

This is the identical type of circuit just considered, so we expect an inductor current of the form

$$i_L = I_0 e^{-Rt/L}$$

where  $R = 200 \Omega$ ,  $L = 50$  mH and  $I_0$  is the initial current flowing through the inductor at  $t = 0$ . Thus,

$$i_L(t) = 2e^{-4000t}$$

Substituting  $t = 200 \times 10^{-6}$  s, we find that  $i_L(t) = 898.7$  mA, less than half the initial value.

### PRACTICE

8.1 Determine the current  $i_R$  through the resistor of Fig. 8.3 at  $t = 1$  ns if  $i_R(0) = 6$  A.

Ans: 812 mA.

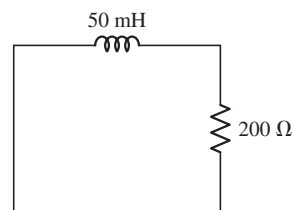

FIGURE 8.2 A simple  $RL$  circuit in which energy is stored in the inductor at  $t = 0$ .

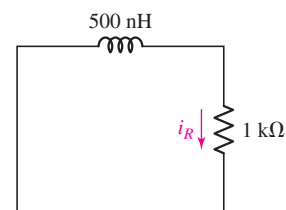

FIGURE 8.3 Circuit for Practice Problem 8.1.

## An Alternative Approach

The solution may also be obtained by a slight variation of the method we just described. After separating the variables, we now also include a constant of integration. Thus,

$$\int \frac{di}{i} = - \int \frac{R}{L} dt + K$$

and integration gives us

$$\ln i = -\frac{R}{L}t + K \quad [4]$$

The constant  $K$  cannot be evaluated by substitution of Eq. [4] in the original differential equation [1]; the identity  $0 = 0$  will result, because Eq. [4] is a solution of Eq. [1] for *any* value of  $K$  (try it out on your own). The constant of integration must be selected to satisfy the initial condition  $i(0) = I_0$ . Thus, at  $t = 0$ , Eq. [4] becomes

$$\ln I_0 = K$$

and we use this value for  $K$  in Eq. [4] to obtain the desired response

$$\ln i = -\frac{R}{L}t + \ln I_0$$

or

$$i(t) = I_0 e^{-Rt/L}$$

as before.

## A More General Solution Approach

Either of these methods can be used when the variables are separable, but this is not always the situation. In the remaining cases we will rely on a very powerful method, the success of which will depend upon our intuition or experience. We simply guess or assume a form for the solution and then test our assumptions, first by substitution in the differential equation, and then by applying the given initial conditions. Since we cannot be expected to guess the exact numerical expression for the solution, we will assume a solution containing several unknown constants and select the values for these constants in order to satisfy the differential equation and the initial conditions. Many of the differential equations encountered in circuit analysis have a solution which may be represented by the exponential function or by the sum of several exponential functions. Let us assume a solution of Eq. [1] in exponential form,

$$i(t) = Ae^{s_1 t} \quad [5]$$

where  $A$  and  $s_1$  are constants to be determined. After substituting this assumed solution in Eq. [1], we have

$$As_1 e^{s_1 t} + A \frac{R}{L} e^{s_1 t} = 0$$

or

$$\left(s_1 + \frac{R}{L}\right) A e^{s_1 t} = 0 \quad [6]$$

In order to satisfy this equation for all values of time, it is necessary that  $A = 0$ , or  $s_1 = -\infty$ , or  $s_1 = -R/L$ . But if  $A = 0$  or  $s_1 = -\infty$ , then every response is zero; neither can be a solution to our problem. Therefore, we must choose

$$s_1 = -\frac{R}{L} \quad [7]$$

and our assumed solution takes on the form

$$i(t) = A e^{-Rt/L}$$

The remaining constant must be evaluated by applying the initial condition  $i(0) = I_0$ . Thus,  $A = I_0$ , and the final form of the assumed solution is (again)

$$i(t) = I_0 e^{-Rt/L}$$

A summary of the basic approach is outlined in Fig. 8.4.

### A Direct Route: The Characteristic Equation

In fact, there is a more direct route that we can take. In obtaining Eq. [7], we solved

$$s_1 + \frac{R}{L} = 0 \quad [8]$$

which is known as the **characteristic equation**. We can obtain the characteristic equation directly from the differential equation, without the need for substitution of our trial solution. Consider the general first-order differential equation

$$a \frac{df}{dt} + bf = 0$$

where  $a$  and  $b$  are constants. We substitute  $s^1$  for  $df/dt$  and  $s^0$  for  $f$ , resulting in

$$a \frac{df}{dt} + bf = (as + b)f = 0$$

From this we may directly obtain the characteristic equation

$$as + b = 0$$

which has the single root  $s = -b/a$ . The solution to our differential equation is then

$$f = A e^{-bt/a}$$

This basic procedure is easily extended to second-order differential equations, as we will explore in Chap. 9.

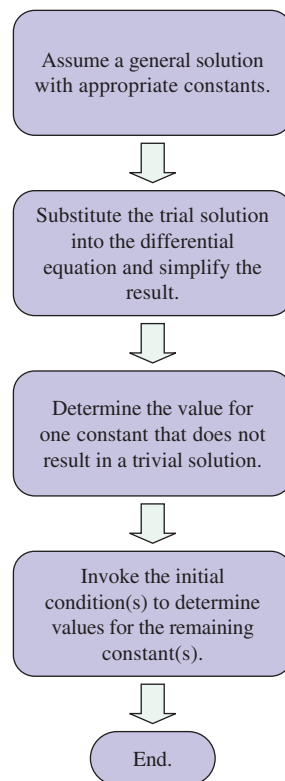

■ FIGURE 8.4 Flowchart for the general approach to solution of first-order differential equations where, based on experience, we can guess the form of the solution.

## EXAMPLE 8.2

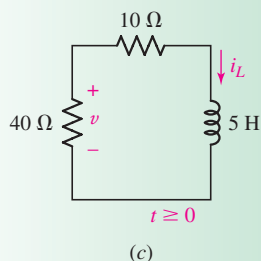
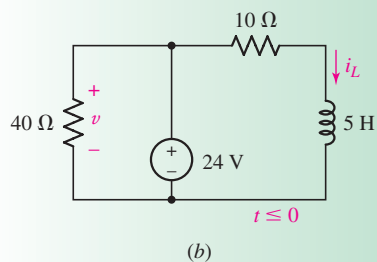
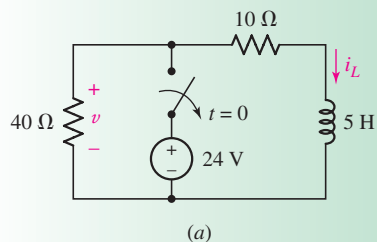

FIGURE 8.5 (a) A simple  $RL$  circuit with a switch thrown at time  $t = 0$ . (b) The circuit as it exists prior to  $t = 0$ . (c) The circuit after the switch is thrown, and the 24 V source is removed.



For the circuit of Fig. 8.5a, find the voltage labeled  $v$  at  $t = 200$  ms.

► **Identify the goal of the problem.**

The schematic of Fig. 8.5a actually represents *two different* circuits: one with the switch closed (Fig. 8.5b) and one with the switch open (Fig. 8.5c). We are asked to find  $v(0.2)$  for the circuit shown in Fig. 8.5c.

► **Collect the known information.**

Both new circuits are drawn and labeled correctly. We next make the assumption that the circuit in Fig. 8.5b has been connected for a long time, so that any transients have dissipated. We may make such an assumption as a general rule unless instructed otherwise. This circuit determines  $i_L(0)$ .

► **Devise a plan.**

The circuit of Fig. 8.5c may be analyzed by writing a KVL equation. Ultimately we want a differential equation with only  $v$  and  $t$  as variables; we will then solve the differential equation for  $v(t)$ .

► **Construct an appropriate set of equations.**

Referring to Fig. 8.5c, we write

$$-v + 10i_L + 5 \frac{di_L}{dt} = 0$$

Substituting  $i_L = -v/40$ , we find that

$$\frac{5}{40} \frac{dv}{dt} + \left( \frac{10}{40} + 1 \right) v = 0$$

or, more simply,

$$\frac{dv}{dt} + 10v = 0 \quad [9]$$

► **Determine if additional information is required.**

From previous experience, we know that a complete expression for  $v$  will require knowledge of  $v$  at a specific instant of time, with  $t = 0$  being the most convenient. We might be tempted to look at Fig. 8.5b and write  $v(0) = 24$  V, but this is only true *just before the switch opens*. The resistor voltage can change to any value in the instant that the switch is thrown; only the inductor current must remain unchanged.

In the circuit of Fig. 8.5b,  $i_L = 24/10 = 2.4$  A since the inductor acts like a short circuit to a dc current. Therefore,  $i_L(0) = 2.4$  A in the circuit of Fig. 8.5c, as well—a key point in analyzing this type of circuit. Therefore, in the circuit of Fig. 8.5c,  $v(0) = (40)(-2.4) = -96$  V.

► **Attempt a solution.**

Any of the three basic solution techniques can be brought to bear; let's start by writing the characteristic equation corresponding to Eq. [9]:

$$s + 10 = 0$$

Solving, we find that  $s = -10$ , so

$$v(t) = Ae^{-10t} \quad [10]$$

(which, upon substitution into the left-hand side of Eq. [9], results in

$$-10Ae^{-10t} + 10Ae^{-10t} = 0$$

as expected.)

We find  $A$  by setting  $t = 0$  in Eq. [10] and employing the fact that  $v(0) = -96$  V. Thus,

$$v(t) = -96e^{-10t} \quad [11]$$

and so  $v(0.2) = -12.99$  V, down from a maximum of  $-96$  V.

► **Verify the solution. Is it reasonable or expected?**

Instead of writing a differential equation in  $v$ , we could have written our differential equation in terms of  $i_L$ :

$$40i_L + 10i_L + 5 \frac{di_L}{dt} = 0$$

or

$$\frac{di_L}{dt} + 10i_L = 0$$

which has the solution  $i_L = Be^{-10t}$ . With  $i_L(0) = 2.4$ , we find that  $i_L(t) = 2.4e^{-10t}$ . Since  $v = -40i_L$ , we once again obtain Eq. [11]. We should note: it is **no coincidence** that the inductor current and the resistor voltage have the same exponential dependence!

### PRACTICE

8.2 Determine the inductor voltage  $v$  in the circuit of Fig. 8.6 for  $t > 0$ .

Ans:  $-25e^{-2t}$  V.

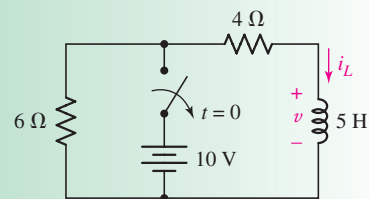

FIGURE 8.6 Circuit for Practice Problem 8.2.

## Accounting for the Energy

Before we turn our attention to the interpretation of the response, let us return to the circuit of Fig. 8.1, and check the power and energy relationships. The power being dissipated in the resistor is

$$p_R = i^2 R = I_0^2 R e^{-2Rt/L}$$

and the total energy turned into heat in the resistor is found by integrating the instantaneous power from zero time to infinite time:

$$\begin{aligned} w_R &= \int_0^{\infty} p_R dt = I_0^2 R \int_0^{\infty} e^{-2Rt/L} dt \\ &= I_0^2 R \left( \frac{-L}{2R} \right) e^{-2Rt/L} \Big|_0^{\infty} = \frac{1}{2} L I_0^2 \end{aligned}$$

This is the result we expect, because the total energy stored initially in the inductor is  $\frac{1}{2} L I_0^2$ , and there is no longer any energy stored in the inductor at infinite time since its current eventually drops to zero. All the initial energy therefore is accounted for by dissipation in the resistor.

## 8.2 PROPERTIES OF THE EXPONENTIAL RESPONSE

Let us now consider the nature of the response in the series  $RL$  circuit. We have found that the inductor current is represented by

$$i(t) = I_0 e^{-Rt/L}$$

At  $t = 0$ , the current has value  $I_0$ , but as time increases, the current decreases and approaches zero. The shape of this decaying exponential is seen by the plot of  $i(t)/I_0$  versus  $t$  shown in Fig. 8.7. Since the function we are plotting is  $e^{-Rt/L}$ , the curve will not change if  $R/L$  remains unchanged. Thus, the same curve must be obtained for every series  $RL$  circuit having the same  $L/R$  ratio. Let us see how this ratio affects the shape of the curve.

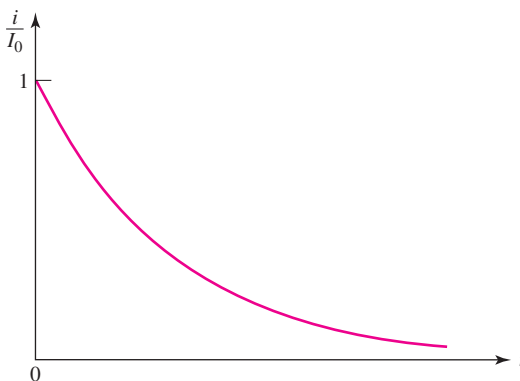

■ FIGURE 8.7 A plot of  $e^{-Rt/L}$  versus  $t$ .

If we double the ratio of  $L$  to  $R$ , the exponent will be unchanged only if  $t$  is also doubled. In other words, the original response will occur at a later time, and the new curve is obtained by moving each point on the original curve twice as far to the right. With this larger  $L/R$  ratio, the current takes longer to decay to any given fraction of its original value. We might have a tendency to say that the “width” of the curve is doubled, or that the width is proportional to  $L/R$ . However, we find it difficult to define our term *width*, because each curve extends from  $t = 0$  to  $\infty$ ! Instead, let us consider the time that would be required for the current to drop to zero *if it continued to drop at its initial rate*.

The initial rate of decay is found by evaluating the derivative at zero time:

$$\left. \frac{d}{dt} \frac{i}{I_0} \right|_{t=0} = -\frac{R}{L} e^{-Rt/L} \Big|_{t=0} = -\frac{R}{L}$$

We designate the value of time it takes for  $i/I_0$  to drop from unity to zero, assuming a constant rate of decay, by the Greek letter  $\tau$  (tau). Thus,

$$\left( \frac{R}{L} \right) \tau = 1$$

or

$$\tau = \frac{L}{R}$$

[12]

The ratio  $L/R$  has the units of seconds, since the exponent  $-Rt/L$  must be dimensionless. This value of time  $\tau$  is called the **time constant** and is shown pictorially in Fig. 8.8. The time constant of a series  $RL$  circuit may be found graphically from the response curve; it is necessary only to draw the tangent to the curve at  $t = 0$  and determine the intercept of this tangent line with the time axis. This is often a convenient way of approximating the time constant from the display on an oscilloscope.

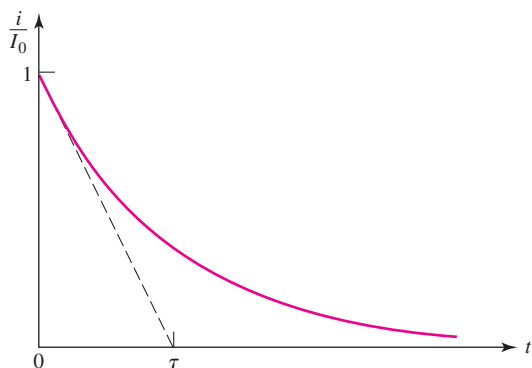

■ FIGURE 8.8 The time constant  $\tau$  is  $L/R$  for a series  $RL$  circuit. It is the time required for the response curve to drop to zero if it decays at a constant rate equal to its initial rate of decay.

An equally important interpretation of the time constant  $\tau$  is obtained by determining the value of  $i(t)/I_0$  at  $t = \tau$ . We have

$$\frac{i(\tau)}{I_0} = e^{-1} = 0.3679 \quad \text{or} \quad i(\tau) = 0.3679I_0$$

Thus, in one time constant the response has dropped to 36.8 percent of its initial value; the value of  $\tau$  may also be determined graphically from this fact, as indicated by Fig. 8.9. It is convenient to measure the decay of the current at intervals of one time constant, and recourse to a hand calculator shows that  $i(t)/I_0$  is 0.3679 at  $t = \tau$ , 0.1353 at  $t = 2\tau$ , 0.04979 at  $t = 3\tau$ , 0.01832 at  $t = 4\tau$ , and 0.006738 at  $t = 5\tau$ . At some point three to five time constants after zero time, most of us would agree that the current is a

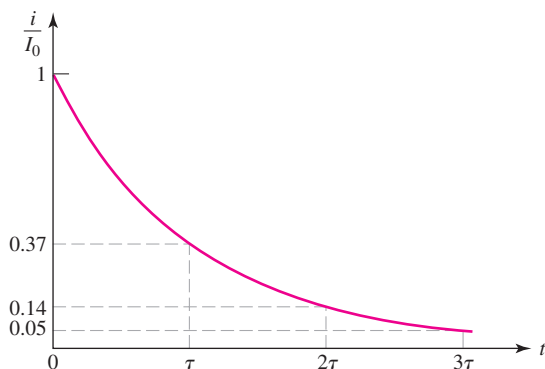

■ FIGURE 8.9 The current in a series  $RL$  circuit is reduced to 37 percent of its initial value at  $t = \tau$ , 14 percent at  $t = 2\tau$ , and 5 percent at  $t = 3\tau$ .



negligible fraction of its former self. Thus, if we are asked, “How long does it take for the current to decay to zero?” our answer might be, “About five time constants.” At that point, the current is less than 1 percent of its original value!

### PRACTICE

8.3 In a source-free series  $RL$  circuit, find the numerical value of the ratio: (a)  $i(2\tau)/i(\tau)$ ; (b)  $i(0.5\tau)/i(0)$ ; (c)  $t/\tau$  if  $i(t)/i(0) = 0.2$ ; (d)  $t/\tau$  if  $i(0) - i(t) = i(0) \ln 2$ .

Ans: 0.368; 0.607; 1.609; 1.181.

## COMPUTER-AIDED ANALYSIS

The transient analysis capability of PSpice is very useful when considering the response of source-free circuits. In this example, we make use of a special feature that allows us to vary a component parameter, similar to the way we varied the dc voltage in other simulations. We do this by adding the component **PARAM** to our schematic; it may be placed anywhere, as we will not wire it into the circuit. Our complete  $RL$  circuit is shown in Fig. 8.10, which includes an initial inductor current of 1 mA.

In order to relate our resistor value to the proposed parameter sweep, we must perform three tasks. First, we provide a name for our parameter, which we choose to call Resistance for the sake of simplicity. This is accomplished by double-clicking on the **PARAMETERS:** label in the schematic, which opens the Property Editor for this pseudo-component. Clicking on **New Column** results in the dialog box shown in Fig. 8.11a, in which we enter *Resistance* under **Name** and a placeholder value of 1 under **Value**. Our second task consists of linking the

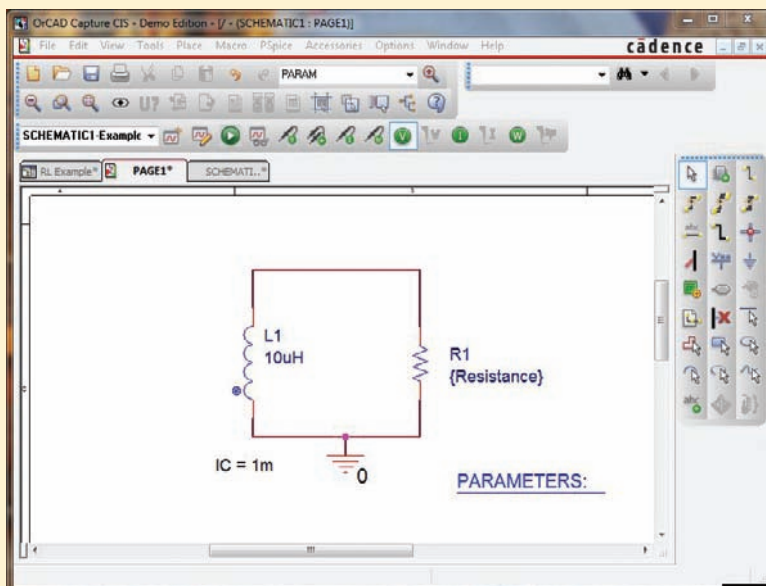

■ FIGURE 8.10 Simple  $RL$  circuit drawn using the schematic capture tool.



value of R1 to our parameter sweep, which we accomplish by double-clicking on the default value of R1 on the schematic, resulting in the dialog box of Fig. 8.11*b*. Under **Value**, we simply enter  $\{Resistance\}$ . (Note the curly brackets are required.)

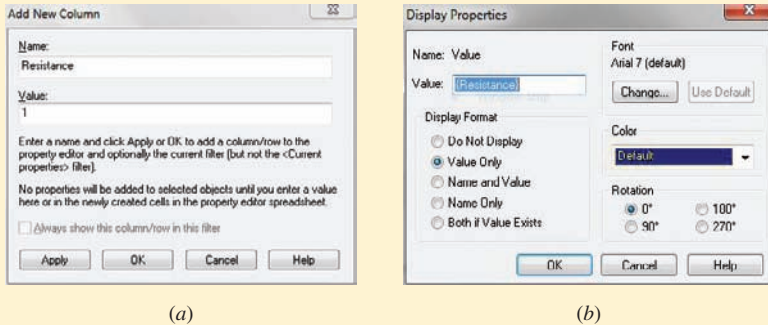

■ FIGURE 8.11 (a) Add New Column dialog box in the Property Editor for PARAM. (b) Resistor value dialog box.

Our third task consists of setting up the simulation, which includes setting transient analysis parameters as well as the values we desire for R1. Under **PSpice** we select **New Simulation Profile** (Fig. 8.12*a*), in which we select **Time Domain (Transient)** for **Analysis type**, 300 ns for **Run to time**, and tick the **Parametric Sweep** box under **Options**. This last action results in the dialog box shown in Fig. 8.12*b*, in which we select **Global parameter** for **Sweep variable** and enter *Resistance* for **Parameter name**. The final setup step required is to select **Logarithmic** under **Sweep type**, a **Start value** of 10, an **End value** of 1000, and 1 **Points/Decade**; alternatively we could list the desired resistor values using **Value list**.

After running the simulation, the notification box shown in Fig. 8.13 appears, listing the available data sets for plotting (**Resistance** = 10, 100, and 1000 in this case). A particular data set is selected by highlighting it; we select all three for this example. Upon selecting the

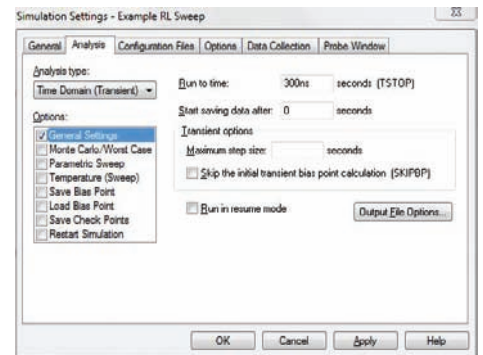

(a)

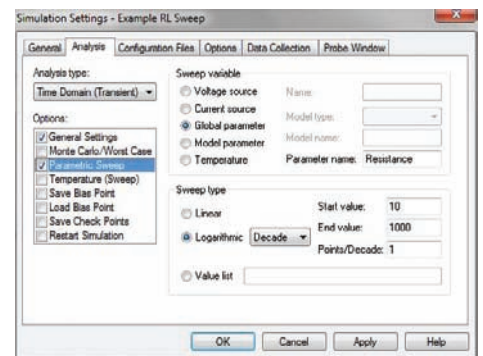

(b)

■ FIGURE 8.12 (a) Simulation dialog box. (b) Parameter sweep dialog box.

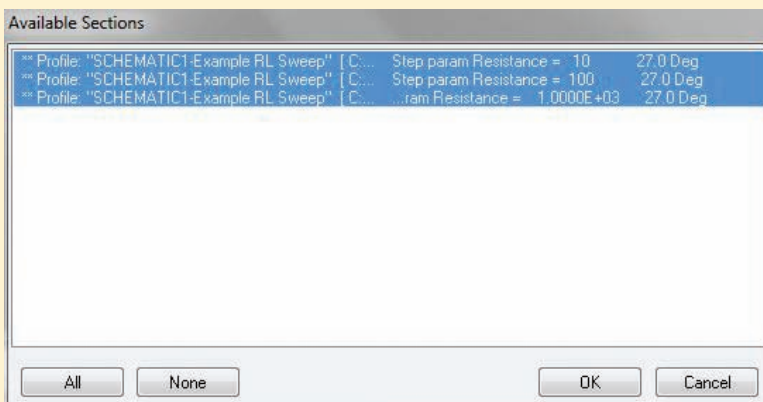

■ FIGURE 8.13 Available data sections dialog box.

(Continued on next page)

inductor current from our **Trace** variable choices in Probe, we obtain three graphs at once, as shown (after labeling by hand) in Fig. 8.14.

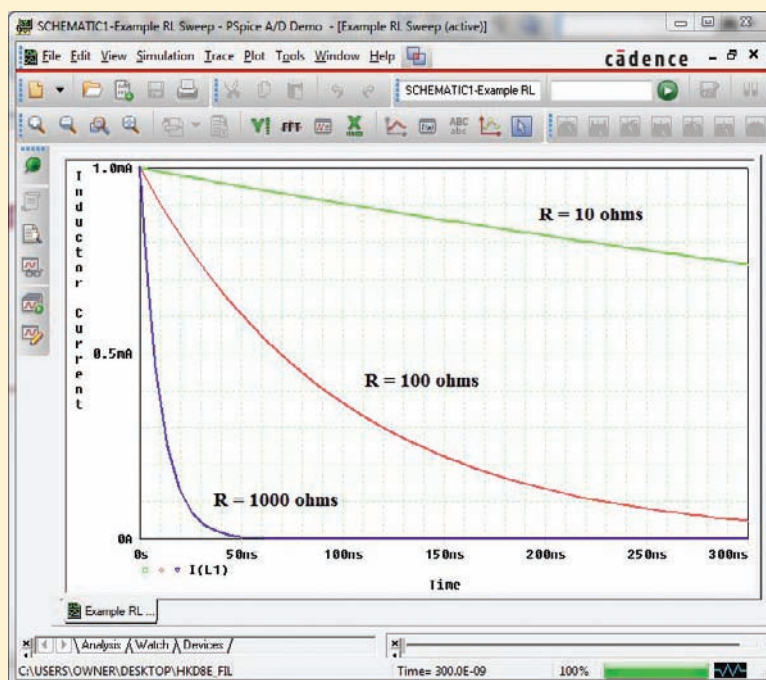

■ FIGURE 8.14 Probe output for the three resistances.

Why does a larger value of the time constant  $L/R$  produce a response curve that decays more slowly? Let us consider the effect of each element.

In terms of the time constant  $\tau$ , the response of the series  $RL$  circuit may be written simply as

$$i(t) = I_0 e^{-t/\tau}$$

An increase in  $L$  allows a greater energy storage for the same initial current, and this larger energy requires a longer time to be dissipated in the resistor. We may also increase  $L/R$  by reducing  $R$ . In this case, the power flowing into the resistor is less for the same initial current; again, a greater time is required to dissipate the stored energy. This effect is seen clearly in our simulation result of Fig. 8.14.

### 8.3 THE SOURCE-FREE RC CIRCUIT

Circuits based on resistor-capacitor combinations are more common than their resistor-inductor analogs. The principal reasons for this are the smaller losses present in a physical capacitor, lower cost, better agreement between the simple mathematical model and the actual device behavior, and also smaller size and lighter weight, both of which are particularly important for integrated-circuit applications.

Let us see how closely the analysis of the parallel (or is it series?)  $RC$  circuit shown in Fig. 8.15 corresponds to that of the  $RL$  circuit. We will assume an initial stored energy in the capacitor by selecting

$$v(0) = V_0$$

The total current leaving the node at the top of the circuit diagram must be zero, so we may write

$$C \frac{dv}{dt} + \frac{v}{R} = 0$$

Division by  $C$  gives us

$$\frac{dv}{dt} + \frac{v}{RC} = 0 \quad [13]$$

Equation [13] has a familiar form; comparison with Eq. [1]

$$\frac{di}{dt} + \frac{R}{L}i = 0 \quad [1]$$

shows that the replacement of  $i$  by  $v$  and  $L/R$  by  $RC$  produces the identical equation we considered previously. It should, for the  $RC$  circuit we are now analyzing is the dual of the  $RL$  circuit we considered first. This *duality* forces  $v(t)$  for the  $RC$  circuit and  $i(t)$  for the  $RL$  circuit to have identical expressions if the resistance of one circuit is equal to the reciprocal of the resistance of the other circuit, and if  $L$  is numerically equal to  $C$ . Thus, the response of the  $RL$  circuit

$$i(t) = i(0)e^{-Rt/L} = I_0e^{-Rt/L}$$

enables us to immediately write

$$v(t) = v(0)e^{-t/RC} = V_0e^{-t/RC} \quad [14]$$

for the  $RC$  circuit.

Suppose instead that we had selected the current  $i$  as our variable in the  $RC$  circuit, rather than the voltage  $v$ . Applying Kirchhoff's voltage law,

$$\frac{1}{C} \int_{t_0}^t i dt' - v_0(t_0) + Ri = 0$$

we obtain an integral equation as opposed to a differential equation. However, taking the time derivative of both sides of this equation,

$$\frac{i}{C} + R \frac{di}{dt} = 0 \quad [15]$$

and replacing  $i$  with  $v/R$ , we obtain Eq. [13] again:

$$\frac{v}{RC} + \frac{dv}{dt} = 0$$

Equation [15] could have been used as our starting point, but the application of duality principles would not have been as natural.

Let us discuss the physical nature of the voltage response of the  $RC$  circuit as expressed by Eq. [14]. At  $t = 0$  we obtain the correct initial condition, and as  $t$  becomes infinite, the voltage approaches zero. This latter result agrees with our thinking that if there were any voltage remaining across the capacitor, then energy would continue to flow into the resistor and be dissipated as heat. *Thus, a final voltage of zero is necessary.* The time constant of the  $RC$

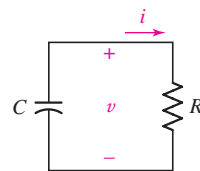

FIGURE 8.15 A parallel  $RC$  circuit for which  $v(t)$  is to be determined, subject to the initial condition that  $v(0) = V_0$ .

circuit may be found by using the duality relationships on the expression for the time constant of the  $RL$  circuit, or it may be found by simply noting the time at which the response has dropped to 37 percent of its initial value:

$$\frac{\tau}{RC} = 1$$

so that

$$\tau = RC \quad [16]$$



Our familiarity with the negative exponential and the significance of the time constant  $\tau$  enables us to sketch the response curve readily (Fig. 8.16). Larger values of  $R$  or  $C$  provide larger time constants and slower dissipation of the stored energy. A larger resistance will dissipate a smaller power with a given voltage across it, thus requiring a greater time to convert the stored energy into heat; a larger capacitance stores a larger energy with a given voltage across it, again requiring a greater time to lose this initial energy.

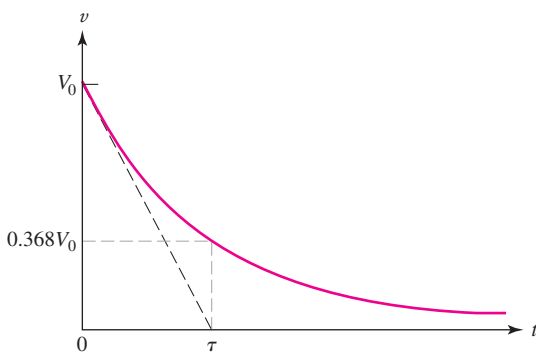

■ FIGURE 8.16 The capacitor voltage  $v(t)$  in the parallel  $RC$  circuit is plotted as a function of time. The initial value of  $v(t)$  is  $V_0$ .

### EXAMPLE 8.3

**For the circuit of Fig. 8.17a, find the voltage labeled  $v$  at  $t = 200 \mu\text{s}$ .**

To find the requested voltage, we will need to draw and analyze two separate circuits: one corresponding to before the switch is thrown (Fig. 8.17b), and one corresponding to after the switch is thrown (Fig. 8.17c).

The sole purpose of analyzing the circuit of Fig. 8.17b is to obtain an initial capacitor voltage; we assume any transients in that circuit died out long ago, leaving a purely dc circuit. With no current through either the capacitor or the  $4 \Omega$  resistor, then,

$$v(0) = 9 \text{ V} \quad [17]$$

We next turn our attention to the circuit of Fig. 8.17c, recognizing that

$$\tau = RC = (2 + 4)(10 \times 10^{-6}) = 60 \times 10^{-6} \text{ s}$$

Thus, from Eq. [14],

$$v(t) = v(0)e^{-t/RC} = v(0)e^{-t/60 \times 10^{-6}} \quad [18]$$

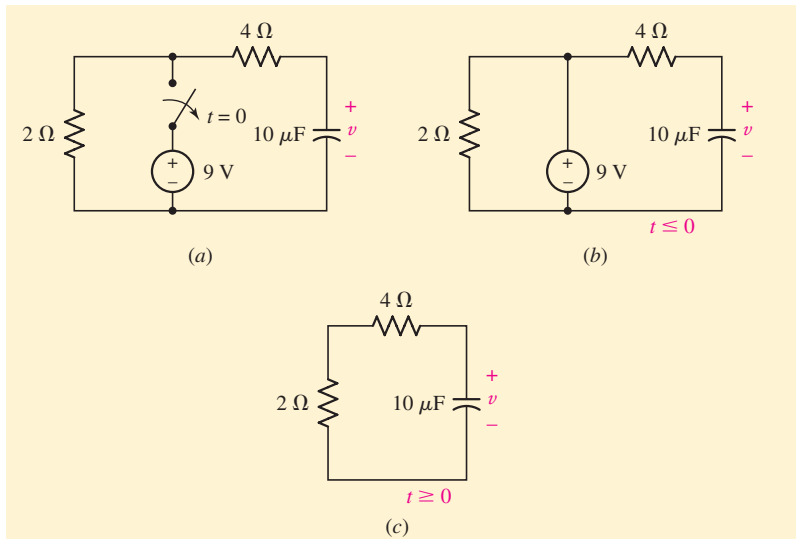

■ FIGURE 8.17 (a) A simple  $RC$  circuit with a switch thrown at time  $t = 0$ . (b) The circuit as it exists prior to  $t = 0$ . (c) The circuit after the switch is thrown, and the 9 V source is removed.

The capacitor voltage must be the same in both circuits at  $t = 0$ ; no such restriction is placed on any other voltage or current. Substituting Eq. [17] into Eq. [18],

$$v(t) = 9e^{-t/60 \times 10^{-6}} \text{ V}$$

so that  $v(200 \times 10^{-6}) = 321.1 \text{ mV}$  (less than 4 percent of its maximum value).

### PRACTICE

8.4 Noting carefully how the circuit changes once the switch in the circuit of Fig. 8.18 is thrown, determine  $v(t)$  at  $t = 0$  and at  $t = 160 \mu\text{s}$ .

Ans: 50 V, 18.39 V.

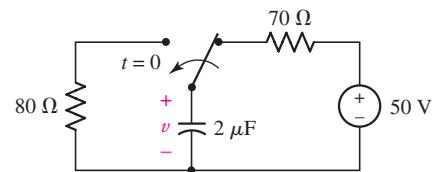

■ FIGURE 8.18

## 8.4 A MORE GENERAL PERSPECTIVE

As seen indirectly from Examples 8.2 and 8.3, regardless of how many resistors we have in the circuit, we obtain a single time constant (either  $\tau = L/R$  or  $\tau = RC$ ) when only one energy storage element is present. We can formalize this by realizing that the value needed for  $R$  is in fact the Thévenin equivalent resistance seen by our energy storage element. (Strange as it may seem, it is even possible to compute a time constant for a circuit containing dependent sources!)

### General $RL$ Circuits

As an example, consider the circuit shown in Fig. 8.19. The equivalent resistance the inductor faces is

$$R_{\text{eq}} = R_3 + R_4 + \frac{R_1 R_2}{R_1 + R_2}$$

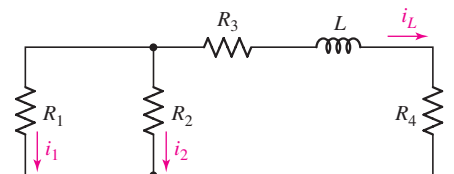

■ FIGURE 8.19 A source-free circuit containing one inductor and several resistors is analyzed by determining the time constant  $\tau = L/R_{\text{eq}}$ .

We could also write

$$\tau = \frac{L}{R_{TH}},$$

where  $R_{TH}$  is the Thévenin equivalent resistance “seen” by the inductor  $L$ .

and the time constant is therefore

$$\tau = \frac{L}{R_{eq}} \quad [19]$$

If several inductors are present in a circuit and can be combined using series and/or parallel combination, then Eq. [19] can be further generalized to

$$\tau = \frac{L_{eq}}{R_{eq}} \quad [20]$$

where  $L_{eq}$  represents the equivalent inductance.

### Slicing Thinly: The Distinction Between $0^+$ and $0^-$

Let's return to the circuit of Fig. 8.19, and assume that some finite amount of energy is stored in the inductor at  $t = 0$ , so that  $i_L(0) \neq 0$ .

The inductor current  $i_L$  is

$$i_L = i_L(0)e^{-t/\tau}$$

and this represents what we might call the basic solution to the problem. It is quite possible that some current or voltage other than  $i_L$  is needed, such as the current  $i_2$  in  $R_2$ . We can always apply Kirchhoff's laws and Ohm's law to the resistive portion of the circuit without any difficulty, but current division provides the quickest answer in this circuit:

$$i_2 = -\frac{R_1}{R_1 + R_2}[i_L(0)e^{-t/\tau}]$$

It may also happen that we know the initial value of some current *other* than the inductor current. Since *the current in a resistor may change instantaneously*, we will indicate the instant after any change that might have occurred at  $t = 0$  by the use of the symbol  $0^+$ ; in more mathematical language,  $i_1(0^+)$  is the limit from the right of  $i_1(t)$  as  $t$  approaches zero.<sup>1</sup> Thus, if we are given the initial value of  $i_1$  as  $i_1(0^+)$ , then the initial value of  $i_2$  is

$$i_2(0^+) = i_1(0^+) \frac{R_1}{R_2}$$

From these values, we obtain the necessary initial value of  $i_L$ :

$$i_L(0^+) = -[i_1(0^+) + i_2(0^+)] = -\frac{R_1 + R_2}{R_2}i_1(0^+)$$

and the expression for  $i_2$  becomes

$$i_2 = i_1(0^+) \frac{R_1}{R_2} e^{-t/\tau}$$

Let us see if we can obtain this last expression more directly. Since the inductor current decays exponentially as  $e^{-t/\tau}$ , *every current throughout the circuit must follow the same functional behavior*. This is made clear by considering the inductor current as a source current that is being applied to a resistive network. Every current and voltage in the resistive network must have the same time dependence. Using these ideas, we therefore express  $i_2$  as

$$i_2 = Ae^{-t/\tau}$$

where

$$\tau = \frac{L}{R_{eq}}$$

(1) Note that this is a notational convenience *only*. When faced with  $t = 0^+$  or its companion  $t = 0^-$  in an equation, we simply use the value zero. This notation allows us to clearly differentiate between the time before and after an event, such as a switch opening or closing, or a power supply being turned on or off.



and  $A$  must be determined from a knowledge of the initial value of  $i_2$ . Since  $i_1(0^+)$  is known, the voltage across  $R_1$  and  $R_2$  is known, and

$$R_2 i_2(0^+) = R_1 i_1(0^+)$$

leads to

$$i_2(0^+) = i_1(0^+) \frac{R_1}{R_2}$$

Therefore,

$$i_2(t) = i_1(0^+) \frac{R_1}{R_2} e^{-t/\tau}$$

A similar sequence of steps will provide a rapid solution to a large number of problems. We first recognize the time dependence of the response as an exponential decay, determine the appropriate time constant by combining resistances, write the solution with an unknown amplitude, and then determine the amplitude from a given initial condition.

This same technique can be applied to any circuit with one inductor and any number of resistors, as well as to those special circuits containing two or more inductors and also two or more resistors that may be simplified by resistance or inductance combination to one inductor and one resistor.

### EXAMPLE 8.4

Determine both  $i_1$  and  $i_L$  in the circuit shown in Fig. 8.20a for  $t > 0$ .

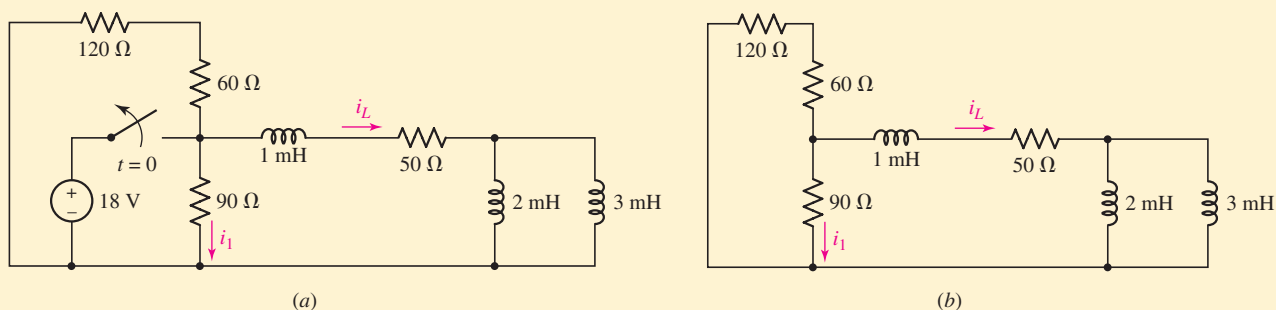

■ FIGURE 8.20 (a) A circuit with multiple resistors and inductors. (b) After  $t = 0$ , the circuit simplifies to an equivalent resistance of  $110 \Omega$  in series with  $L_{\text{eq}} = 2.2 \text{ mH}$ .

After  $t = 0$ , when the voltage source is disconnected as shown in Fig. 8.20b, we easily calculate an equivalent inductance,

$$L_{\text{eq}} = \frac{2 \times 3}{2 + 3} + 1 = 2.2 \text{ mH}$$

an equivalent resistance, in series with the equivalent inductance,

$$R_{\text{eq}} = \frac{90(60 + 120)}{90 + 180} + 50 = 110 \Omega$$

(Continued on next page)

and the time constant,

$$\tau = \frac{L_{\text{eq}}}{R_{\text{eq}}} = \frac{2.2 \times 10^{-3}}{110} = 20 \mu\text{s}$$

Thus, the form of the natural response is  $Ke^{-50,000t}$ , where  $K$  is an unknown constant. Considering the circuit just prior to the switch opening ( $t = 0^-$ ),  $i_L = 18/50$  A. Since  $i_L(0^+) = i_L(0^-)$ , we know that  $i_L = 18/50$  A or 360 mA at  $t = 0^+$  and so

$$i_L = \begin{cases} 360 \text{ mA} & t < 0 \\ 360e^{-50,000t} \text{ mA} & t \geq 0 \end{cases}$$

There is no restriction on  $i_1$  changing instantaneously at  $t = 0$ , so its value at  $t = 0^-$  (18/90 A or 200 mA) is not relevant to finding  $i_1$  for  $t > 0$ . Instead, we must find  $i_1(0^+)$  through our knowledge of  $i_L(0^+)$ . Using current division,

$$i_1(0^+) = -i_L(0^+) \frac{120 + 60}{120 + 60 + 90} = -240 \text{ mA}$$

Hence,

$$i_1 = \begin{cases} 200 \text{ mA} & t < 0 \\ -240e^{-50,000t} \text{ mA} & t \geq 0 \end{cases}$$

We can verify our analysis using PSpice and the switch model **Sw\_tOpen**, although it should be remembered that this part is actually just two resistance values: one corresponding to before the switch opens at the specified time (the default value is 10 mΩ), and one for after the switch opens (the default value is 1 MΩ). If the equivalent resistance of the remainder of the circuit is comparable to either value, the values should be edited by double-clicking on the switch symbol in the circuit schematic. Note that there is also a switch model that closes at a specified time: **Sw\_tClose**.

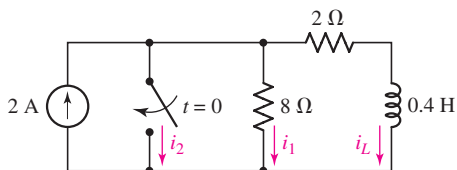

FIGURE 8.21

### PRACTICE

8.5 At  $t = 0.15$  s in the circuit of Fig. 8.21, find the value of (a)  $i_L$ ; (b)  $i_1$ ; (c)  $i_2$ .

Ans: 0.756 A; 0; 1.244 A.

We have now considered the task of finding the natural response of any circuit which can be represented by an equivalent inductor in series with an equivalent resistor. *A circuit containing several resistors and several inductors does not always possess a form which allows either the resistors or the inductors to be combined into single equivalent elements.* In such instances, there is no single negative exponential term or single time constant associated with the circuit. Rather, there will, in general, be several negative





exponential terms, the number of terms being equal to the number of inductors that remain after all possible inductor combinations have been made.

## General RC Circuits

Many of the  $RC$  circuits for which we would like to find the natural response contain more than a single resistor and capacitor. Just as we did for the  $RL$  circuits, we first consider those cases in which the given circuit may be reduced to an equivalent circuit consisting of only one resistor and one capacitor.

Let us suppose first that we are faced with a circuit containing a single capacitor, but any number of resistors. It is possible to replace the two-terminal resistive network which is across the capacitor terminals with an equivalent resistor, and we may then write down the expression for the capacitor voltage immediately. In such instances, the circuit has an effective time constant given by

$$\tau = R_{\text{eq}}C$$

where  $R_{\text{eq}}$  is the equivalent resistance of the network. An alternative perspective is that  $R_{\text{eq}}$  is in fact the Thévenin equivalent resistance “seen” by the capacitor.

If the circuit has more than one capacitor, but they may be replaced somehow using series and/or parallel combinations with an equivalent capacitance  $C_{\text{eq}}$ , then the circuit has an effective time constant given by

$$\tau = RC_{\text{eq}}$$

with the general case expressed as

$$\tau = R_{\text{eq}}C_{\text{eq}}$$

It is worth noting, however, that parallel capacitors replaced by an equivalent capacitance would have to have identical initial conditions.



## EXAMPLE 8.5

Find  $v(0^+)$  and  $i_1(0^+)$  for the circuit shown in Fig. 8.22a if  $v(0^-) = V_0$ .

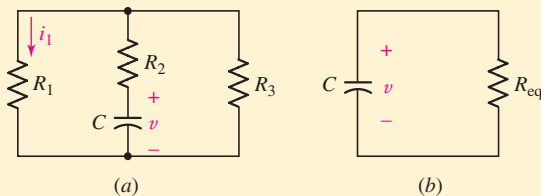

■ FIGURE 8.22 (a) A given circuit containing one capacitor and several resistors. (b) The resistors have been replaced by a single equivalent resistor; the time constant is simply  $\tau = R_{\text{eq}}C$ .

We first simplify the circuit of Fig. 8.22a to that of Fig. 8.22b, enabling us to write

$$v = V_0 e^{-t/R_{\text{eq}}C}$$

(Continued on next page)

where

$$v(0^+) = v(0^-) = V_0 \quad \text{and} \quad R_{\text{eq}} = R_2 + \frac{R_1 R_3}{R_1 + R_3}$$

Every current and voltage in the resistive portion of the network must have the form  $Ae^{-t/R_{\text{eq}}C}$ , where  $A$  is the initial value of that current or voltage. Thus, the current in  $R_1$ , for example, may be expressed as

$$i_1 = i_1(0^+)e^{-t/\tau}$$

where

$$\tau = \left( R_2 + \frac{R_1 R_3}{R_1 + R_3} \right) C$$

and  $i_1(0^+)$  remains to be determined from the initial condition. Any current flowing in the circuit at  $t = 0^+$  must come from the capacitor. Therefore, since  $v$  cannot change instantaneously,  $v(0^+) = v(0^-) = V_0$  and

$$i_1(0^+) = \frac{V_0}{R_2 + R_1 R_3 / (R_1 + R_3)} \frac{R_3}{R_1 + R_3}$$

## PRACTICE

8.6 Find values of  $v_C$  and  $v_o$  in the circuit of Fig. 8.23 at  $t$  equal to (a)  $0^-$ ; (b)  $0^+$ ; (c) 1.3 ms.

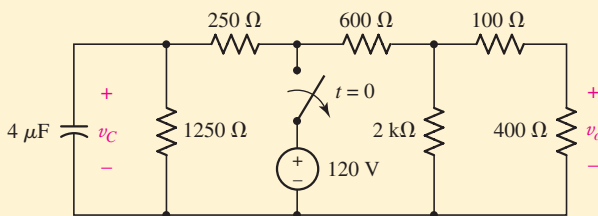

FIGURE 8.23

Ans: 100 V, 38.4 V; 100 V, 25.6 V; 59.5 V, 15.22 V.

Our method can be applied to circuits with one energy storage element and one or more dependent sources as well. In such instances, we may write an appropriate KCL or KVL equation along with any necessary supporting equations, distill this down into a single differential equation, and extract the characteristic equation to find the time constant. Alternatively, we may begin by finding the Thévenin equivalent resistance of the network connected to the capacitor or inductor, and use this in calculating the appropriate  $RL$  or  $RC$  time constant—unless the dependent source is controlled by a voltage or current associated with the energy storage element, in which case the Thévenin approach cannot be used.

## EXAMPLE 8.6

For the circuit of Fig. 8.24a, find the voltage labeled  $v_C$  for  $t > 0$  if  $v_C(0^-) = 2$  V.

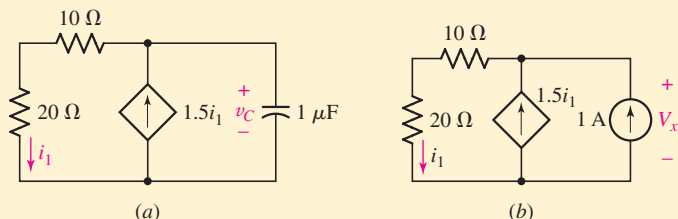

FIGURE 8.24 (a) A simple RC circuit containing a dependent source not controlled by a capacitor voltage or current. (b) Circuit for finding the Thévenin equivalent of the network connected to the capacitor.

The dependent source is not controlled by a capacitor voltage or current, so we can start by finding the Thévenin equivalent of the network to the left of the capacitor. Connecting a 1 A test source as in Fig. 8.24b,

$$V_x = (1 + 1.5i_1)(30)$$

where

$$i_1 = \left(\frac{1}{20}\right) \frac{20}{10 + 20} V_x = \frac{V_x}{30}$$

Performing a little algebra, we find that  $V_x = -60$  V, so the network has a Thévenin equivalent resistance of  $-60 \Omega$  (unusual, but not impossible when dealing with a dependent source). Our circuit therefore has a *negative* time constant

$$\tau = -60(1 \times 10^{-6}) = -60 \mu\text{s}$$

The capacitor voltage is therefore

$$v_C(t) = Ae^{t/60 \times 10^{-6}} \quad \text{V}$$

where  $A = v_C(0^+) = v_C(0^-) = 2$  V. Thus,

$$v_C(t) = 2e^{t/60 \times 10^{-6}} \quad \text{V} \quad [21]$$

which, interestingly enough is unstable: it grows exponentially with time. This cannot continue indefinitely; one or more elements in the circuit will eventually fail.

*Alternatively*, we could write a simple KCL equation for the top node of Fig. 8.24a

$$v_C = 30 \left( 1.5i_1 - 10^{-6} \frac{dv_C}{dt} \right) \quad [22]$$

where

$$i_1 = \frac{v_C}{30} \quad [23]$$

(Continued on next page)

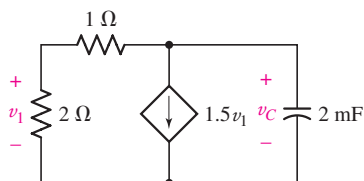

■ FIGURE 8.25 Circuit for Practice Problem 8.7.

Substituting Eq. [23] into Eq. [22] and performing some algebra, we obtain

$$\frac{dv_C}{dt} - \frac{1}{60 \times 10^{-6}} v_C = 0$$

which has the characteristic equation

$$s - \frac{1}{60 \times 10^{-6}} = 0$$

Thus,

$$s = \frac{1}{60 \times 10^{-6}}$$

and so

$$v_C(t) = Ae^{t/60 \times 10^{-6}} \quad \text{V}$$

as we found before. Substitution of  $A = v_C(0^+) = 2$  results in Eq. [21], our expression for the capacitor voltage for  $t > 0$ .

### PRACTICE

8.7 (a) Regarding the circuit of Fig. 8.25, determine the voltage  $v_C(t)$  for  $t > 0$  if  $v_C(0^-) = 11$  V. (b) Is the circuit “stable”?

Ans: (a)  $v_C(t) = 11e^{-2 \times 10^3 t/3}$  V,  $t > 0$ . (b) Yes; it decays (exponentially) rather than grows with time.

Some circuits containing a number of both resistors and capacitors may be replaced by an equivalent circuit containing only one resistor and one capacitor; it is necessary that the original circuit be one which can be broken into two parts, one containing all resistors and the other containing all capacitors, such that the two parts are connected by only two ideal conductors. Otherwise, multiple time constants and multiple exponential terms will be required to describe the behavior of the circuit (one time constant for each energy storage element remaining in the circuit after it is reduced as much as possible).

As a parting comment, we should be wary of certain situations involving only ideal elements which are suddenly connected together. For example, we may imagine connecting two ideal capacitors in series having unequal voltages prior to  $t = 0$ . This poses a problem using our mathematical model of an ideal capacitor; however, real capacitors have resistances associated with them through which energy can be dissipated.



## 8.5 THE UNIT-STEP FUNCTION

We have been studying the response of  $RL$  and  $RC$  circuits when no sources or forcing functions were present. We termed this response the *natural response*, because its form depends only on the nature of the circuit. The reason that any response at all is obtained arises from the presence of initial

energy storage within the inductive or capacitive elements in the circuit. In some cases we were confronted with circuits containing sources and switches; we were informed that certain switching operations were performed at  $t = 0$  in order to remove all the sources from the circuit, while leaving known amounts of energy stored here and there. In other words, we have been solving problems in which energy sources are suddenly *removed* from the circuit; now we must consider that type of response which results when energy sources are suddenly *applied* to a circuit.

We will focus on the response which occurs when the energy sources suddenly applied are dc sources. Since every electrical device is intended to be energized at least once, and since most devices are turned on and off many times in the course of their lifetimes, our study applies to many practical cases. Even though we are now restricting ourselves to dc sources, there are still many cases in which these simpler examples correspond to the operation of physical devices. For example, the first circuit we will analyze could represent the buildup of the current when a dc motor is started. The generation and use of the rectangular voltage pulses needed to represent a number or a command in a microprocessor provide many examples in the field of electronic or transistor circuitry. Similar circuits are found in the synchronization and sweep circuits of television receivers, in communication systems using pulse modulation, and in radar systems, to name but a few examples.

We have been speaking of the “sudden application” of an energy source, and by this phrase we imply its application in zero time.<sup>2</sup> The operation of a switch in series with a battery is thus equivalent to a forcing function which is zero up to the instant that the switch is closed and is equal to the battery voltage thereafter. The forcing function has a break, or discontinuity, at the instant the switch is closed. Certain special forcing functions which are discontinuous or have discontinuous derivatives are called *singularity functions*, the two most important of these singularity functions being the *unit-step function* and the *unit-impulse function*.

We define the unit-step forcing function as a function of time which is zero for all values of its argument less than zero and which is unity for all positive values of its argument. If we let  $(t - t_0)$  be the argument and represent the unit-step function by  $u$ , then  $u(t - t_0)$  must be zero for all values of  $t$  less than  $t_0$ , and it must be unity for all values of  $t$  greater than  $t_0$ . At  $t = t_0$ ,  $u(t - t_0)$  changes *abruptly* from 0 to 1. Its value at  $t = t_0$  is not defined, but its value is known for all instants of time that are arbitrarily close to  $t = t_0$ . We often indicate this by writing  $u(t_0^-) = 0$  and  $u(t_0^+) = 1$ . The concise mathematical definition of the unit-step forcing function is

$$u(t - t_0) = \begin{cases} 0 & t < t_0 \\ 1 & t > t_0 \end{cases}$$

and the function is shown graphically in Fig. 8.26. Note that a vertical line of unit length is shown at  $t = t_0$ . Although this “riser” is not strictly a part of the definition of the unit step, it is usually shown in each drawing.

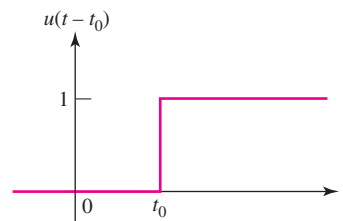

■ FIGURE 8.26 The unit-step forcing function,  $u(t - t_0)$ .

(2) Of course, this is not physically possible. However, if the time scale over which such an event occurs is very short compared to all other relevant time scales that describe the operation of a circuit, this is approximately true, and mathematically convenient.

We also note that the unit step need not be a time function. For example,  $u(x - x_0)$  could be used to denote a unit-step function where  $x$  might be a distance in meters, for example, or a frequency.

Very often in circuit analysis a discontinuity or a switching action takes place at an instant that is defined as  $t = 0$ . In that case  $t_0 = 0$ , and we then represent the corresponding unit-step forcing function by  $u(t - 0)$ , or more simply  $u(t)$ . This is shown in Fig. 8.27. Thus

$$u(t) = \begin{cases} 0 & t < 0 \\ 1 & t > 0 \end{cases}$$

The unit-step forcing function is in itself dimensionless. If we wish it to represent a voltage, it is necessary to multiply  $u(t - t_0)$  by some constant voltage, such as 5 V. Thus,  $v(t) = 5u(t - 0.2)$  V is an ideal voltage source which is zero before  $t = 0.2$  s and a constant 5 V after  $t = 0.2$  s. This forcing function is shown connected to a general network in Fig. 8.28a.

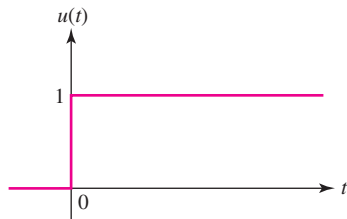

■ FIGURE 8.27 The unit-step forcing function  $u(t)$  is shown as a function of  $t$ .

### Physical Sources and the Unit-Step Function

Perhaps we should ask what physical source is the equivalent of this discontinuous forcing function. By equivalent, we mean simply that the voltage-current characteristics of the two networks are identical. For the step-voltage source of Fig. 8.28a, the voltage-current characteristic is simple: the voltage is zero prior to  $t = 0.2$  s, it is 5 V after  $t = 0.2$  s, and the current may be any (finite) value in either time interval. Our first thoughts might produce the attempt at an equivalent shown in Fig. 8.28b, a 5 V dc source in series with a switch which closes at  $t = 0.2$  s. This network is not equivalent for  $t < 0.2$  s, however, because the voltage across the battery and switch is completely unspecified in this time interval. The “equivalent” source is an open circuit, and the voltage across it *may be anything*. After  $t = 0.2$  s, the networks are equivalent, and if this is the only time interval in which we are interested, and if the initial currents which flow from the two networks are identical at  $t = 0.2$  s, then Fig. 8.28b becomes a useful equivalent of Fig. 8.28a.



In order to obtain an exact equivalent for the voltage-step forcing function, we may provide a single-pole double-throw switch. Before  $t = 0.2$  s, the switch serves to ensure zero voltage across the input terminals of the general network. After  $t = 0.2$  s, the switch is thrown to provide a constant input voltage of 5 V. At  $t = 0.2$  s, the voltage is indeterminate (as is the step forcing function), and the battery is momentarily short-circuited (it is

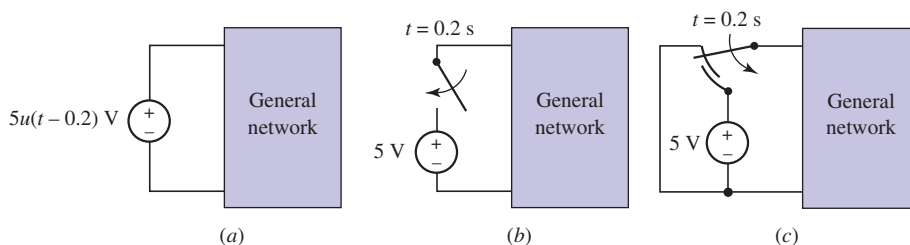

■ FIGURE 8.28 (a) A voltage-step forcing function is shown as the source driving a general network. (b) A simple circuit which, although not the exact equivalent of part (a), may be used as its equivalent in many cases. (c) An exact equivalent of part (a).

fortunate that we are dealing with mathematical models!). This exact equivalent of Fig. 8.28a is shown in Fig. 8.28c.

Figure 8.29a shows a current-step forcing function driving a general network. If we attempt to replace this circuit by a dc source in parallel with a switch (which opens at  $t = t_0$ ), we must realize that the circuits are equivalent after  $t = t_0$  but that the responses after  $t = t_0$  are alike only if the initial conditions are the same. The circuit in Fig. 8.29b implies no voltage exists across the current source terminals for  $t < t_0$ . This is not the case for the circuit of Fig. 8.29a. However, we may often use the circuits of Fig. 8.29a and b interchangeably. The exact equivalent of Fig. 8.29a is the dual of the circuit of Fig. 8.28c; the exact equivalent of Fig. 8.29b cannot be constructed with current- and voltage-step forcing functions alone.<sup>3</sup>

## The Rectangular Pulse Function

Some very useful forcing functions may be obtained by manipulating the unit-step forcing function. Let us define a rectangular voltage pulse by the following conditions:

$$v(t) = \begin{cases} 0 & t < t_0 \\ V_0 & t_0 < t < t_1 \\ 0 & t > t_1 \end{cases}$$

The pulse is drawn in Fig. 8.30. Can this pulse be represented in terms of the unit-step forcing function? Let us consider the difference of the two unit steps,  $u(t - t_0) - u(t - t_1)$ . The two step functions are shown in Fig. 8.31a, and their difference is a rectangular pulse. The source  $V_0u(t - t_0) - V_0u(t - t_1)$  which provides us with the desired voltage is indicated in Fig. 8.31b.

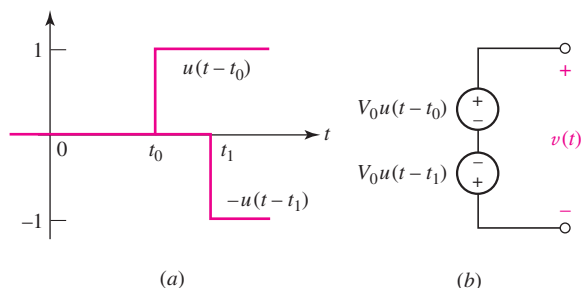

■ FIGURE 8.31 (a) The unit steps  $u(t - t_0)$  and  $-u(t - t_1)$ . (b) A source which yields the rectangular voltage pulse of Fig. 8.30.

If we have a sinusoidal voltage source  $V_m \sin \omega t$  which is suddenly connected to a network at  $t = t_0$ , then an appropriate voltage forcing function would be  $v(t) = V_m u(t - t_0) \sin \omega t$ . If we wish to represent one burst of energy from the transmitter for a radio-controlled car operating at 47 MHz (295 Mrad/s), we may turn the sinusoidal source off 70 ns later by a second unit-step forcing function.<sup>4</sup> The voltage pulse is thus

$$v(t) = V_m [u(t - t_0) - u(t - t_0 - 7 \times 10^{-8})] \sin(295 \times 10^6 t)$$

This forcing function is sketched in Fig. 8.32.

(3) The equivalent can be drawn if the current through the switch prior to  $t = t_0$  is known.

(4) Apparently, we're pretty good at the controls of this car. A reaction time of 70 ns?

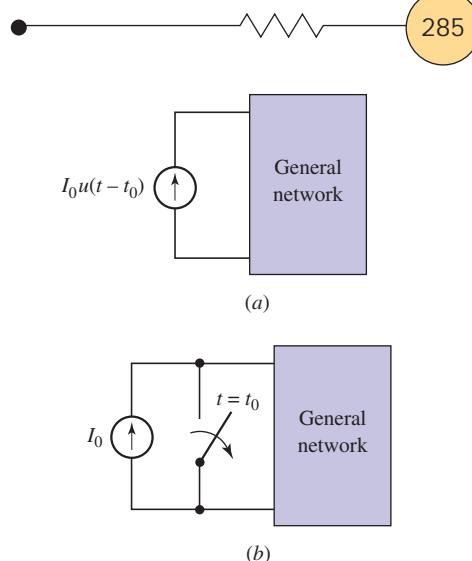

■ FIGURE 8.29 (a) A current-step forcing function is applied to a general network. (b) A simple circuit which, although not the exact equivalent of part (a), may be used as its equivalent in many cases.

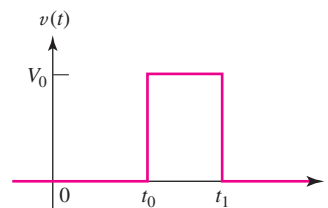

■ FIGURE 8.30 A useful forcing function, the rectangular voltage pulse.

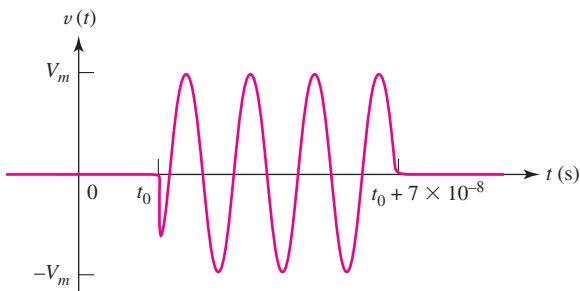

■ FIGURE 8.32 A 47 MHz radio-frequency pulse, described by  $v(t) = V_m[u(t - t_0) - u(t - t_0 - 7 \times 10^{-8})] \sin(259 \times 10^6 t)$ .

### PRACTICE

8.8 Evaluate each of the following at  $t = 0.8$ : (a)  $3u(t) - 2u(-t) + 0.8u(1 - t)$ ; (b)  $[4u(t)]u(-t)$ ; (c)  $2u(t) \sin \pi t$ .

Ans: 3.8; 0; 1.176.

## 8.6 DRIVEN RL CIRCUITS

We are now ready to subject a simple network to the sudden application of a dc source. The circuit consists of a battery whose voltage is  $V_0$  in series with a switch, a resistor  $R$ , and an inductor  $L$ . The switch is closed at  $t = 0$ , as indicated on the circuit diagram of Fig. 8.33a. It is evident that the current  $i(t)$  is zero before  $t = 0$ , and we are therefore able to replace the battery and switch by a voltage-step forcing function  $V_0 u(t)$ , which also produces no response prior to  $t = 0$ . After  $t = 0$ , the two circuits are clearly identical. Hence, we seek the current  $i(t)$  either in the given circuit of Fig. 8.33a or in the equivalent circuit of Fig. 8.33b.

We will find  $i(t)$  at this time by writing the appropriate circuit equation and then solving it by separation of the variables and integration. After we obtain the answer and investigate the two parts of which it is composed, we will see that there is physical significance to each of these two terms. With a more intuitive understanding of how each term originates, we will be able to produce more rapid and more meaningful solutions to every problem involving the sudden application of any source.

Applying Kirchhoff's voltage law to the circuit of Fig. 8.33b, we have

$$Ri + L \frac{di}{dt} = V_0 u(t)$$

Since the unit-step forcing function is discontinuous at  $t = 0$ , we will first consider the solution for  $t < 0$  and then for  $t > 0$ . The application of zero voltage since  $t = -\infty$  forces a zero response, so that

$$i(t) = 0 \quad t < 0$$

For positive time, however,  $u(t)$  is unity and we must solve the equation

$$Ri + L \frac{di}{dt} = V_0 \quad t > 0$$

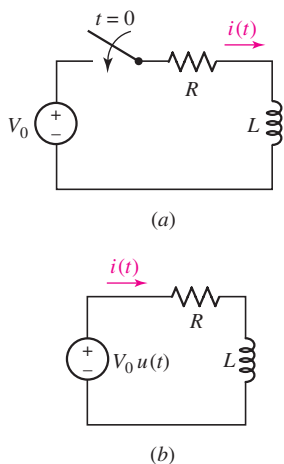

■ FIGURE 8.33 (a) The given circuit. (b) An equivalent circuit, possessing the same response  $i(t)$  for all time.



The variables may be separated in several simple algebraic steps, yielding

$$\frac{L di}{V_0 - Ri} = dt$$

and each side may be integrated directly:

$$-\frac{L}{R} \ln(V_0 - Ri) = t + k$$

In order to evaluate  $k$ , an initial condition must be invoked. Prior to  $t = 0$ ,  $i(t)$  is zero, and thus  $i(0^-) = 0$ . Since the current in an inductor cannot change by a finite amount in zero time without being associated with an infinite voltage, we thus have  $i(0^+) = 0$ . Setting  $i = 0$  at  $t = 0$ , we obtain

$$-\frac{L}{R} \ln V_0 = k$$

and, hence,

$$-\frac{L}{R} [\ln(V_0 - Ri) - \ln V_0] = t$$

Rearranging,

$$\frac{V_0 - Ri}{V_0} = e^{-Rt/L}$$

or

$$i = \frac{V_0}{R} - \frac{V_0}{R} e^{-Rt/L} \quad t > 0 \quad [24]$$

Thus, an expression for the response valid for all  $t$  would be

$$i = \left( \frac{V_0}{R} - \frac{V_0}{R} e^{-Rt/L} \right) u(t) \quad [25]$$

## A More Direct Procedure

This is the desired solution, but it has not been obtained in the simplest manner. In order to establish a more direct procedure, let us try to interpret the two terms appearing in Eq. [25]. The exponential term has the functional form of the natural response of the  $RL$  circuit; it is a negative exponential, it approaches zero as time increases, and it is characterized by the time constant  $L/R$ . The functional form of this part of the response is thus identical with that which is obtained in the source-free circuit. However, the amplitude of this exponential term depends on the source voltage  $V_0$ . We might generalize, then, that the response will be the sum of two terms, where one term has a functional form identical to that of the source-free response, but has an amplitude that depends on the forcing function. But what of the other term?

Equation [25] also contains a constant term,  $V_0/R$ . Why is it present? The answer is simple: the natural response approaches zero as the energy is gradually dissipated, but the total response must not approach zero. Eventually the circuit behaves as a resistor and an inductor in series with a battery. Since the inductor looks like a short circuit to dc, the only current now

flowing is  $V_0/R$ . This current is a part of the response that is directly attributable to the forcing function, and we call it the *forced response*. It is the response that is present a long time after the switch is closed.



The complete response is composed of two parts, the *natural response* and the *forced response*. The natural response is a characteristic of the circuit and not of the sources. Its form may be found by considering the source-free circuit, and it has an amplitude that depends on both the initial amplitude of the source and the initial energy storage. The forced response has the characteristics of the forcing function; it is found by pretending that all switches were thrown a long time ago. Since we are presently concerned only with switches and dc sources, the forced response is merely the solution of a simple dc circuit problem.

### EXAMPLE 8.7

**For the circuit of Fig. 8.34, find  $i(t)$  for  $t = \infty$ ,  $3^-$ ,  $3^+$ , and  $100 \mu\text{s}$  after the source changes value.**

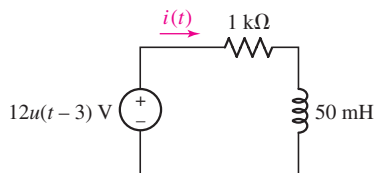

■ FIGURE 8.34 A simple RL circuit driven by a voltage-step forcing function.

Long after any transients have died out ( $t \rightarrow \infty$ ), the circuit is a simple dc circuit driven by a 12 V voltage source. The inductor appears as a short circuit, so

$$i(\infty) = \frac{12}{1000} = 12 \text{ mA}$$

What is meant by  $i(3^-)$ ? This is simply a notational convenience to indicate the instant before the voltage source changes value. For  $t < 3$ ,  $u(t - 3) = 0$ . Thus,  $i(3^-) = 0$  as well.

At  $t = 3^+$ , the forcing function  $12u(t - 3) = 12 \text{ V}$ . However, since the inductor current cannot change in zero time,  $i(3^+) = i(3^-) = 0$ .

The most straightforward approach to analyzing the circuit for  $t > 3 \text{ s}$  is to rewrite Eq. [25] as

$$i(t') = \left( \frac{V_0}{R} - \frac{V_0}{R} e^{-Rt'/L} \right) u(t')$$

and note that this equation applies to our circuit as well if we shift the time axis such that

$$t' = t - 3$$

Therefore, with  $V_0/R = 12 \text{ mA}$  and  $R/L = 20,000 \text{ s}^{-1}$ ,

$$i(t - 3) = (12 - 12e^{-20,000(t-3)}) u(t - 3) \quad \text{mA} \quad [26]$$

which can be written more simply as

$$i(t) = (12 - 12e^{-20,000(t-3)}) u(t - 3) \quad \text{mA} \quad [27]$$

since the unit-step function forces a zero value for  $t < 3$ , as required. Substituting  $t = 3.0001 \text{ s}$  into Eq. [26] or [27], we find that  $i = 10.38 \text{ mA}$  at a time  $100 \mu\text{s}$  after the source changes value.

**PRACTICE**

8.9 The voltage source  $60 - 40u(t)$  V is in series with a  $10\ \Omega$  resistor and a 50 mH inductor. Find the magnitudes of the inductor current and voltage at  $t$  equal to (a)  $0^-$ ; (b)  $0^+$ ; (c)  $\infty$ ; (d) 3 ms.

Ans: 6 A, 0 V; 6 A, 40 V; 2 A, 0 V; 4.20 A, 22.0 V.

**Developing an Intuitive Understanding**

The reason for the two responses, forced and natural, may be seen from physical arguments. We know that our circuit will eventually assume the forced response. However, at the instant the switches are thrown, the initial inductor currents (or, in  $RC$  circuits, the voltages across the capacitors) will have values that depend only on the energy stored in these elements. These currents or voltages cannot be expected to be the same as the currents and voltages demanded by the forced response. Hence, there must be a transient period during which the currents and voltages change from their given initial values to their required final values. The portion of the response that provides the transition from initial to final values is the natural response (often called the *transient* response, as we found earlier). If we describe the response of the simple source-free  $RL$  circuit in these terms, then we should say that the forced response is zero and that the natural response serves to connect the initial response dictated by the stored energy with the zero value of the forced response.

This description is appropriate only for those circuits in which the natural response eventually dies out. This always occurs in physical circuits where some resistance is associated with every element, but there are a number of “pathologic” circuits in which the natural response is nonvanishing as time becomes infinite. Those circuits in which trapped currents circulate around inductive loops, or voltages are trapped in series strings of capacitors, are examples.

**8.7 NATURAL AND FORCED RESPONSE**

There is also an excellent mathematical reason for considering the complete response to be composed of two parts—the forced response and the natural response. The reason is based on the fact that the solution of any linear differential equation may be expressed as the sum of two parts: the *complementary solution* (natural response) and the *particular solution* (forced response). Without delving into the general theory of differential equations, let us consider a general equation of the type met in the previous section:

$$\frac{di}{dt} + Pi = Q$$

or

$$di + Pi\ dt = Q\ dt \quad [28]$$

We may identify  $Q$  as a forcing function and express it as  $Q(t)$  to emphasize its general time dependence. Let us simplify the discussion by

assuming that  $P$  is a positive constant. Later, we will also assume that  $Q$  is constant, thus restricting ourselves to dc forcing functions.

In any standard text on elementary differential equations, it is shown that if both sides of Eq. [28] are multiplied by a suitable “integrating factor,” then each side becomes an exact differential that can be integrated directly to obtain the solution. We are not separating the variables, but merely arranging them in such a way that integration is possible. For this equation, the integrating factor is  $e^{\int P dt}$  or simply  $e^{Pt}$ , since  $P$  is a constant. We multiply each side of the equation by this integrating factor and obtain

$$e^{Pt} di + iPe^{Pt} dt = Qe^{Pt} dt \quad [29]$$

The form of the left side may be simplified by recognizing it as the exact differential of  $ie^{Pt}$ :

$$d(ie^{Pt}) = e^{Pt} di + iPe^{Pt} dt$$

so that Eq. [29] becomes

$$d(ie^{Pt}) = Qe^{Pt} dt$$

Integrating each side,

$$ie^{Pt} = \int Qe^{Pt} dt + A$$

where  $A$  is a constant of integration. Multiplication by  $e^{-Pt}$  produces the solution for  $i(t)$ ,

$$i = e^{-Pt} \int Qe^{Pt} dt + Ae^{-Pt} \quad [30]$$

If our forcing function  $Q(t)$  is known, then we can obtain the functional form of  $i(t)$  by evaluating the integral. We will not evaluate such an integral for each problem, however; instead, we are interested in using Eq. [30] to draw several very general conclusions.

## The Natural Response

We note first that, for a source-free circuit,  $Q$  must be zero, and the solution is the natural response

$$i_n = Ae^{-Pt} \quad [31]$$

We will find that the constant  $P$  is never negative for a circuit with only resistors, inductors, and capacitors; its value depends only on the passive circuit elements<sup>5</sup> and their interconnection in the circuit. *The natural response therefore approaches zero as time increases without limit.* This must be the case for the simple  $RL$  circuit, because the initial energy is gradually dissipated in the resistor, leaving the circuit in the form of heat. There are also idealized circuits in which  $P$  is zero; in these circuits the natural response does not die out.

We therefore find that one of the two terms making up the complete response has the form of the natural response; it has an amplitude which will

(5) If the circuit contains a dependent source or a negative resistance,  $P$  may be negative.

depend on (but *not* always be equal to) the initial value of the complete response and thus on the initial value of the forcing function also.

## The Forced Response

We next observe that the first term of Eq. [30] depends on the functional form of  $Q(t)$ , the forcing function. Whenever we have a circuit in which the natural response dies out as  $t$  becomes infinite, this first term must completely describe the form of the response after the natural response has disappeared. This term is typically called the forced response; it is also called the *steady-state response*, the *particular solution*, or the *particular integral*.

For the present, we have elected to consider only those problems involving the sudden application of dc sources, and  $Q(t)$  will therefore be a constant for all values of time. If we wish, we can now evaluate the integral in Eq. [30], obtaining the forced response

$$i_f = \frac{Q}{P} \quad [32]$$

and the complete response

$$i(t) = \frac{Q}{P} + Ae^{-Pt} \quad [33]$$

For the  $RL$  series circuit,  $Q/P$  is the constant current  $V_0/R$  and  $1/P$  is the time constant  $\tau$ . We should see that the forced response might have been obtained without evaluating the integral, because it must be the complete response at infinite time; it is merely the source voltage divided by the series resistance. The forced response is thus obtained by inspection of the final circuit.

## Determination of the Complete Response

Let us use the simple  $RL$  series circuit to illustrate how to determine the complete response by the addition of the natural and forced responses. The circuit shown in Fig. 8.35 was analyzed earlier, but by a longer method. The desired response is the current  $i(t)$ , and we first express this current as the sum of the natural and the forced current,

$$i = i_n + i_f$$

The functional form of the natural response must be the same as that obtained without any sources. We therefore replace the step-voltage source by a short circuit and recognize the old  $RL$  series loop. Thus,

$$i_n = Ae^{-Rt/L}$$

where the amplitude  $A$  is yet to be determined; since the initial condition applies to the *complete* response, we cannot simply assume  $A = i(0)$ .

We next consider the forced response. In this particular problem the forced response must be constant, because the source is a constant  $V_0$  for all positive values of time. After the natural response has died out, there can be no voltage across the inductor; hence, a voltage  $V_0$  appears across  $R$ , and the forced response is simply

$$i_f = \frac{V_0}{R}$$

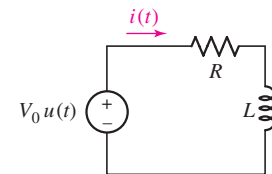

■ FIGURE 8.35 A series  $RL$  circuit that is used to illustrate the method by which the complete response is obtained as the sum of the natural and forced responses.



Note that the forced response is determined completely; there is no unknown amplitude. We next combine the two responses to obtain

$$i = Ae^{-Rt/L} + \frac{V_0}{R}$$

and apply the initial condition to evaluate  $A$ . The current is zero prior to  $t = 0$ , and it cannot change value instantaneously since it is the current flowing through an inductor. Thus, the current is zero immediately after  $t = 0$ , and

$$0 = A + \frac{V_0}{R}$$

so

$$i = \frac{V_0}{R}(1 - e^{-Rt/L}) \quad [34]$$

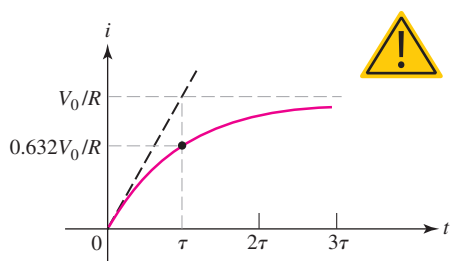

■ FIGURE 8.36 The current flowing through the inductor of Fig. 8.35 is shown graphically. A line extending the initial slope meets the constant forced response at  $t = \tau$ .

Note carefully that  $A$  is not the initial value of  $i$ , since  $A = -V_0/R$ , while  $i(0) = 0$ . In considering source-free circuits, we found that  $A$  was the initial value of the response. When forcing functions are present, however, we must first find the initial value of the response and then substitute this in the equation for the complete response to find  $A$ .

This response is plotted in Fig. 8.36, and we can see the manner in which the current builds up from its initial value of zero to its final value of  $V_0/R$ . The transition is effectively accomplished in a time  $3\tau$ . If our circuit represents the field coil of a large dc motor, we might have  $L = 10$  H and  $R = 20$   $\Omega$ , obtaining  $\tau = 0.5$  s. The field current is thus established in about 1.5 s. In one time constant, the current has attained 63.2 percent of its final value.

## EXAMPLE 8.8

Determine  $i(t)$  for all values of time in the circuit of Fig. 8.37.

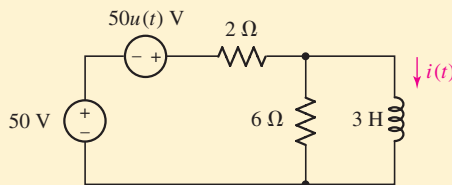

■ FIGURE 8.37 The circuit of Example 8.8.

The circuit contains a dc voltage source as well as a step-voltage source. We might choose to replace everything to the left of the inductor by the Thévenin equivalent, but instead let us merely recognize the form of that equivalent as a resistor in series with some voltage source. The circuit contains only one energy storage element, the inductor. We first note that

$$\tau = \frac{L}{R_{\text{eq}}} = \frac{3}{1.5} = 2 \text{ s}$$

and recall that

$$i = i_f + i_n$$

The natural response is therefore a negative exponential as before:

$$i_n = Ke^{-t/2} \quad \text{A} \quad t > 0$$

Since the forcing function is a dc source, the forced response will be a constant current. The inductor acts like a short circuit to dc, so that

$$i_f = \frac{100}{2} = 50 \text{ A}$$

Thus,

$$i = 50 + Ke^{-0.5t} \quad \text{A} \quad t > 0$$

In order to evaluate  $K$ , we must establish the initial value of the inductor current. Prior to  $t = 0$ , this current is 25 A, and it cannot change instantaneously. Thus,

$$25 = 50 + K$$

or

$$K = -25$$

Hence,

$$i = 50 - 25e^{-0.5t} \quad \text{A} \quad t > 0$$

We complete the solution by also stating

$$i = 25 \text{ A} \quad t < 0$$

or by writing a single expression valid for all  $t$ ,

$$i = 25 + 25(1 - e^{-0.5t})u(t) \quad \text{A}$$

The complete response is sketched in Fig. 8.38. Note how the natural response serves to connect the response for  $t < 0$  with the constant forced response.

### PRACTICE

8.10 A voltage source,  $v_s = 20u(t)$  V, is in series with a  $200 \Omega$  resistor and a 4 H inductor. Find the magnitude of the inductor current at  $t$  equal to (a)  $0^-$ ; (b)  $0^+$ ; (c) 8 ms; (d) 15 ms.

Ans: 0; 0; 33.0 mA; 52.8 mA.

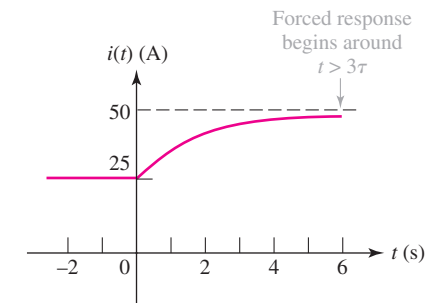
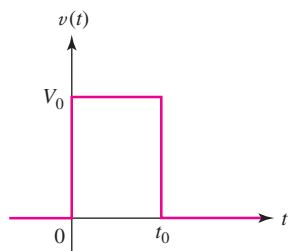

FIGURE 8.38 The response  $i(t)$  of the circuit shown in Fig. 8.37 is sketched for values of times less and greater than zero.

As a final example of this method by which the complete response of any circuit subjected to a transient may be written down *almost by inspection*, let us again consider the simple  $RL$  series circuit, but subjected to a voltage pulse.

## EXAMPLE 8.9



(a)

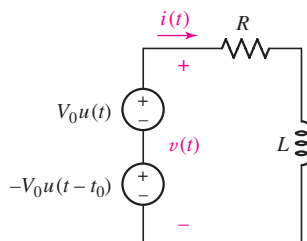

(b)

■ FIGURE 8.39 (a) A rectangular voltage pulse which is to be used as the forcing function in a simple series  $RL$  circuit. (b) The series  $RL$  circuit, showing the representation of the forcing function by the series combination of two independent voltage-step sources. The current  $i(t)$  is desired.

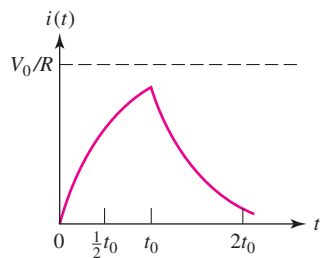

(a)

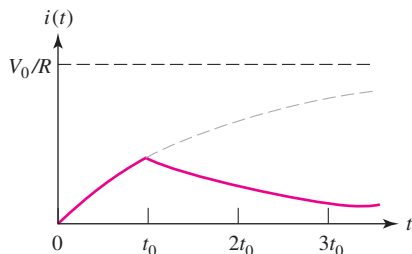

(b)

■ FIGURE 8.40 Two possible response curves are shown for the circuit of Fig. 8.39b to the pulse waveform of Fig. 8.39a, the current waveform itself is sensitive to both the circuit time constant  $\tau$  and the voltage pulse duration  $t_0$ . Two possible curves are shown in Fig. 8.40.

**Find the current response in a simple series  $RL$  circuit when the forcing function is a rectangular voltage pulse of amplitude  $V_0$  and duration  $t_0$ .**

We represent the forcing function as the sum of two step-voltage sources  $V_0 u(t)$  and  $-V_0 u(t - t_0)$ , as indicated in Fig. 8.39a and b, and we plan to obtain the response by using superposition. Let  $i_1(t)$  designate that part of  $i(t)$  which is due to the upper source  $V_0 u(t)$  acting alone, and let  $i_2(t)$  represent that part due to  $-V_0 u(t - t_0)$  acting alone. Then,

$$i(t) = i_1(t) + i_2(t)$$

Our object is now to write each of the partial responses  $i_1$  and  $i_2$  as the sum of a natural and a forced response. The response  $i_1(t)$  is familiar; this problem was solved in Eq. [34]:

$$i_1(t) = \frac{V_0}{R}(1 - e^{-Rt/L}) \quad t > 0$$

Note that this solution is only valid for  $t > 0$  as indicated;  $i_1 = 0$  for  $t < 0$ .

We now turn our attention to the other source and its response  $i_2(t)$ . Only the polarity of the source and the time of its application are different. There is no need therefore to determine the form of the natural response and the forced response; the solution for  $i_1(t)$  enables us to write

$$i_2(t) = -\frac{V_0}{R}[1 - e^{-R(t-t_0)/L}] \quad t > t_0$$

where the applicable range of  $t$ ,  $t > t_0$ , must again be indicated; and  $i_2 = 0$  for  $t < t_0$ .

We now add the two solutions, but do so carefully, since each is valid over a different interval of time. Thus,

$$i(t) = 0 \quad t < 0 \quad [35]$$

$$i(t) = \frac{V_0}{R}(1 - e^{-Rt/L}) \quad 0 < t < t_0 \quad [36]$$

and

$$i(t) = \frac{V_0}{R}(1 - e^{-Rt/L}) - \frac{V_0}{R}(1 - e^{-R(t-t_0)/L}) \quad t > t_0$$

or more compactly,

$$i(t) = \frac{V_0}{R}e^{-Rt/L}(e^{Rt_0/L} - 1) \quad t > t_0 \quad [37]$$

Although Eqs. [35] through [37] completely describe the response of the circuit in Fig. 8.39b to the pulse waveform of Fig. 8.39a, the current waveform itself is sensitive to both the circuit time constant  $\tau$  and the voltage pulse duration  $t_0$ . Two possible curves are shown in Fig. 8.40.



The left curve is drawn for the case where the time constant is only one-half as large as the length of the applied pulse; the rising portion of the exponential has therefore almost reached  $V_0/R$  before the decaying exponential begins. The opposite situation is shown to the right; there, the time constant is twice  $t_0$  and the response never has a chance to reach the larger amplitudes.

The procedure we have been using to find the response of an  $RL$  circuit after dc sources have been switched on or off (or in or out of the circuit) at some instant of time is summarized in the following. We assume that the circuit is reducible to a single equivalent resistance  $R_{\text{eq}}$  in series with a single equivalent inductance  $L_{\text{eq}}$  when all independent sources are set equal to zero. The response we seek is represented by  $f(t)$ .

1. With all independent sources zeroed out, simplify the circuit to determine  $R_{\text{eq}}$ ,  $L_{\text{eq}}$ , and the time constant  $\tau = L_{\text{eq}}/R_{\text{eq}}$ .
2. Viewing  $L_{\text{eq}}$  as a short circuit, use dc analysis methods to find  $i_L(0^-)$ , the inductor current just prior to the discontinuity.
3. Again viewing  $L_{\text{eq}}$  as a short circuit, use dc analysis methods to find the forced response. This is the value approached by  $f(t)$  as  $t \rightarrow \infty$ ; we represent it by  $f(\infty)$ .
4. Write the total response as the sum of the forced and natural responses:  $f(t) = f(\infty) + Ae^{-t/\tau}$ .
5. Find  $f(0^+)$  by using the condition that  $i_L(0^+) = i_L(0^-)$ . If desired,  $L_{\text{eq}}$  may be replaced by a current source  $i_L(0^+)$  [an open circuit if  $i_L(0^+) = 0$ ] for this calculation. With the exception of inductor currents (and capacitor voltages), other currents and voltages in the circuit may change abruptly.
6.  $f(0^+) = f(\infty) + A$  and  $f(t) = f(\infty) + [f(0^+) - f(\infty)]e^{-t/\tau}$ , or total response = final value + (initial value – final value)  $e^{-t/\tau}$ .

### PRACTICE

8.11 The circuit shown in Fig. 8.41 has been in the form shown for a very long time. The switch opens at  $t = 0$ . Find  $i_R$  at  $t$  equal to (a)  $0^-$ ; (b)  $0^+$ ; (c)  $\infty$ ; (d) 1.5 ms.

Ans: 0; 10 mA; 4 mA; 5.34 mA.

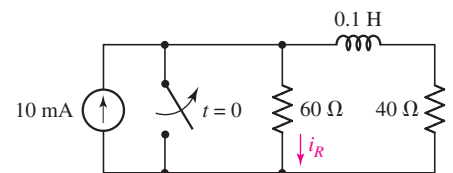

FIGURE 8.41

## 8.8 DRIVEN RC CIRCUITS

The complete response of any  $RC$  circuit may also be obtained as the sum of the natural and the forced response. Since the procedure is virtually identical to what we have already discussed in detail for  $RL$  circuits, the best approach at this stage is to illustrate it by working a relevant example completely, where the goal is not just a capacitor-related quantity but the current associated with a resistor as well.

## EXAMPLE 8.10

Find the capacitor voltage  $v_C(t)$  and the current  $i(t)$  in the  $200\ \Omega$  resistor of Fig. 8.42 for all time.

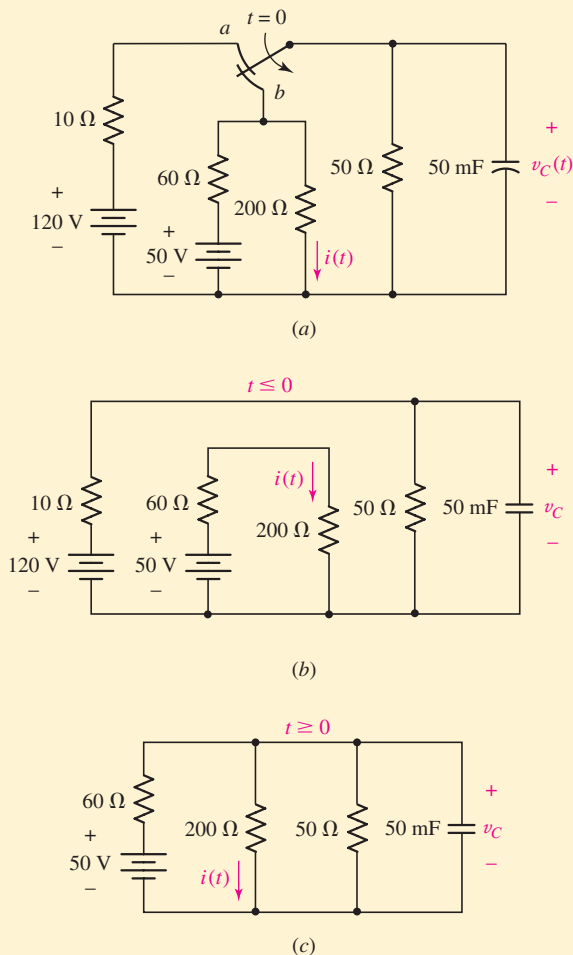

FIGURE 8.42 (a) An RC circuit in which the complete responses  $v_C$  and  $i$  are obtained by adding a forced response and a natural response. (b) Circuit for  $t \leq 0$ . (c) Circuit for  $t \geq 0$ .

We begin by considering the state of the circuit at  $t < 0$ , corresponding to the switch at position *a* as represented in Fig. 8.42*b*. As usual, we assume no transients are present, so that only a forced response due to the  $120\text{ V}$  source is relevant to finding  $v_C(0^-)$ . Simple voltage division then gives us the initial voltage,

$$v_C(0) = \frac{50}{50 + 10}(120) = 100\text{ V}$$

Since the capacitor voltage cannot change instantaneously, this voltage is equally valid at  $t = 0^-$  and  $t = 0^+$ .

The switch is now thrown to *b*, and the complete response is

$$v_C = v_{Cf} + v_{Cn}$$

The corresponding circuit has been redrawn in Fig. 8.42c for convenience. The form of the natural response is obtained by replacing the 50 V source by a short circuit and evaluating the equivalent resistance to find the time constant (in other words, we are finding the Thévenin equivalent resistance “seen” by the capacitor):

$$R_{\text{eq}} = \frac{1}{\frac{1}{50} + \frac{1}{200} + \frac{1}{60}} = 24 \, \Omega$$

Thus,

$$v_{Cn} = Ae^{-t/R_{\text{eq}}C} = Ae^{-t/1.2}$$

In order to evaluate the forced response with the switch at *b*, we wait until all the voltages and currents have stopped changing, thus treating the capacitor as an open circuit, and use voltage division once more:

$$\begin{aligned} v_{Cf} &= 50 \left( \frac{200 \parallel 50}{60 + 200 \parallel 50} \right) \\ &= 50 \left( \frac{(50)(200)/250}{60 + (50)(200)/250} \right) = 20 \, \text{V} \end{aligned}$$

Consequently,

$$v_C = 20 + Ae^{-t/1.2} \quad \text{V}$$

and from the initial condition already obtained,

$$100 = 20 + A$$

or

$$v_C = 20 + 80e^{-t/1.2} \quad \text{V} \quad t \geq 0$$

and

$$v_C = 100 \, \text{V} \quad t < 0$$

This response is sketched in Fig. 8.43a; again the natural response is seen to form a transition from the initial to the final response.

Next we attack  $i(t)$ . This response need not remain constant during the instant of switching. With the contact at *a*, it is evident that  $i = 50/260 = 192.3$  milliamperes. When the switch moves to position *b*, the forced response for this current becomes

$$i_f = \frac{50}{60 + (50)(200)/(50 + 200)} \left( \frac{50}{50 + 200} \right) = 0.1 \, \text{ampere}$$

The form of the natural response is the same as that which we already determined for the capacitor voltage:

$$i_n = Ae^{-t/1.2}$$

Combining the forced and natural responses, we obtain

$$i = 0.1 + Ae^{-t/1.2} \quad \text{amperes}$$

(Continued on next page)

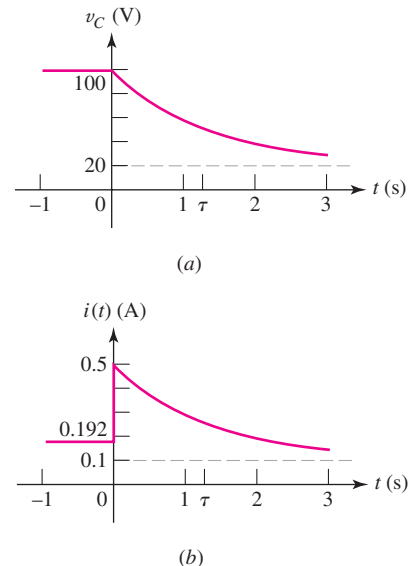

■ FIGURE 8.43 The responses (a)  $v_C$  and (b)  $i$  are plotted as functions of time for the circuit of Fig. 8.42.

To evaluate  $A$ , we need to know  $i(0^+)$ . This is found by fixing our attention on the energy-storage element (the capacitor). The fact that  $v_C$  must remain 100 V during the switching interval is the governing condition which establishes the other currents and voltages at  $t = 0^+$ . Since  $v_C(0^+) = 100$  V, and since the capacitor is in parallel with the  $200\ \Omega$  resistor, we find  $i(0^+) = 0.5$  ampere,  $A = 0.4$  ampere, and thus

$$i(t) = 0.1923 \text{ ampere} \quad t < 0$$

$$i(t) = 0.1 + 0.4e^{-t/1.2} \quad \text{ampere} \quad t > 0$$

or

$$i(t) = 0.1923 + (-0.0923 + 0.4e^{-t/1.2})u(t) \quad \text{amperes}$$

where the last expression is correct for all  $t$ .

The complete response for all  $t$  may also be written concisely by using  $u(-t)$ , which is unity for  $t < 0$  and 0 for  $t > 0$ . Thus,

$$i(t) = 0.1923u(-t) + (0.1 + 0.4e^{-t/1.2})u(t) \quad \text{amperes}$$

This response is sketched in Fig. 8.43*b*. Note that only four numbers are needed to write the functional form of the response for this single-energy-storage-element circuit, or to prepare the sketch: the constant value prior to switching (0.1923 ampere), the instantaneous value just after switching (0.5 ampere), the constant forced response (0.1 ampere), and the time constant (1.2 s). The appropriate negative exponential function is then easily written or drawn.

### PRACTICE

8.12 For the circuit of Fig. 8.44, find  $v_C(t)$  at  $t$  equal to (a)  $0^-$ ; (b)  $0^+$ ; (c)  $\infty$ ; (d) 0.08 s.

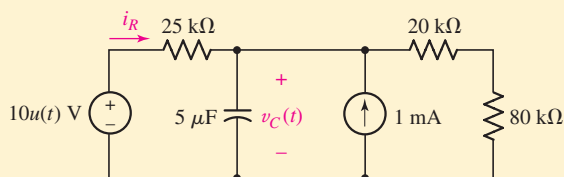

FIGURE 8.44

Ans: 20 V; 20 V; 28 V; 24.4 V.

We conclude by listing the duals of the statements given at the end of Sec. 8.7.

The procedure we have been using to find the response of an *RC* circuit after dc sources have been switched on or off, or in or out of the circuit, at some instant of time, say  $t = 0$ , is summarized in the following. We assume that the circuit is reducible to a single equivalent resistance  $R_{eq}$  in parallel with a single equivalent capacitance  $C_{eq}$  when all independent sources are set equal to zero. The response we seek is represented by  $f(t)$ .

1. With all independent sources zeroed out, simplify the circuit to determine  $R_{\text{eq}}$ ,  $C_{\text{eq}}$ , and the time constant  $\tau = R_{\text{eq}}C_{\text{eq}}$ .
2. Viewing  $C_{\text{eq}}$  as an open circuit, use dc analysis methods to find  $v_C(0^-)$ , the capacitor voltage just prior to the discontinuity.
3. Again viewing  $C_{\text{eq}}$  as an open circuit, use dc analysis methods to find the forced response. This is the value approached by  $f(t)$  as  $t \rightarrow \infty$ ; we represent it by  $f(\infty)$ .
4. Write the total response as the sum of the forced and natural responses:  $f(t) = f(\infty) + Ae^{-t/\tau}$ .
5. Find  $f(0^+)$  by using the condition that  $v_C(0^+) = v_C(0^-)$ . If desired,  $C_{\text{eq}}$  may be replaced by a voltage source  $v_C(0^+)$  [a short circuit if  $v_C(0^+) = 0$ ] for this calculation. With the exception of capacitor voltages (and inductor currents), other voltages and currents in the circuit may change abruptly.
6.  $f(0^+) = f(\infty) + A$  and  $f(t) = f(\infty) + [f(0^+) - f(\infty)]e^{-t/\tau}$ , or total response = final value + (initial value – final value)  $e^{-t/\tau}$ .

As we have just seen, the same basic steps that apply to the analysis of  $RL$  circuits can be applied to  $RC$  circuits as well. Up to now, we have confined ourselves to the analysis of circuits with dc forcing functions only, despite the fact that Eq. [30] holds for more general functions such as  $Q(t) = 9 \cos(5t - 7^\circ)$  or  $Q(t) = 2e^{-5t}$ . Before concluding this section, we explore one such non-dc scenario.

## EXAMPLE 8.11

**Determine an expression for  $v(t)$  in the circuit of Fig. 8.45 valid for  $t > 0$ .**

Based on experience, we expect a complete response of the form

$$v(t) = v_f + v_n$$

where  $v_f$  will likely resemble our forcing function and  $v_n$  will have the form  $Ae^{-t/\tau}$ .

What is the circuit time constant  $\tau$ ? We replace our source with an open circuit and find the Thévenin equivalent resistance in parallel with the capacitor:

$$R_{\text{eq}} = 4.7 + 10 = 14.7 \, \Omega$$

Thus, our time constant is  $\tau = R_{\text{eq}}C = 323.4 \, \mu\text{s}$ , or equivalently  $1/\tau = 3.092 \times 10^3 \, \text{s}^{-1}$ .

There are several ways to proceed, although perhaps the most straightforward is to perform a source transformation, resulting in a voltage source  $23.5e^{-2000t}u(t)$  V in series with  $14.7 \, \Omega$  and  $22 \, \mu\text{F}$ . (Note this does not change the time constant.)

Writing a simple KVL equation for  $t > 0$ , we find that

$$23.5e^{-2000t} = (14.7)(22 \times 10^{-6}) \frac{dv}{dt} + v$$

(Continued on next page)

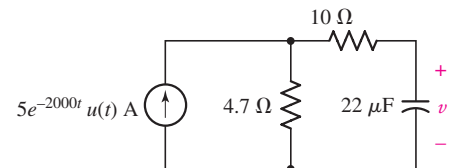
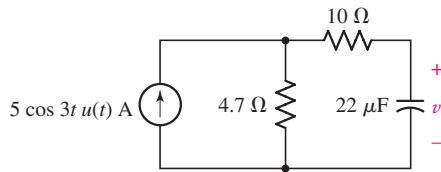

FIGURE 8.45 A simple  $RC$  circuit driven by an exponentially decaying forcing function.



■ FIGURE 8.46 A simple  $RC$  circuit driven by a sinusoidal forcing function.

A little rearranging results in

$$\frac{dv}{dt} + 3.092 \times 10^3 v = 72.67 \times 10^3 e^{-2000t}$$

which, upon comparison with Eqs. [28] and [30], allows us to write the complete response as

$$v(t) = e^{-Pt} \int Qe^{Pt} dt + Ae^{-Pt}$$

where in our case  $P = 1/\tau = 3.092 \times 10^3$  and  $Q(t) = 72.67 \times 10^3 e^{-2000t}$ . We therefore find that

$$v(t) = e^{-3092t} \int 72.67 \times 10^3 e^{-2000t} e^{3092t} dt + Ae^{-3092t} \quad \text{V}$$

Performing the indicated integration,

$$v(t) = 66.55e^{-2000t} + Ae^{-3092t} \quad \text{V} \quad [38]$$

Our only source is controlled by a step function with zero value for  $t < 0$ , so we know that  $v(0^-) = 0$ . Since  $v$  is a capacitor voltage,  $v(0^+) = v(0^-)$ , and we therefore find our initial condition  $v(0) = 0$  easily enough. Substituting this into Eq. [38], we find  $A = -66.55$  V and so

$$v(t) = 66.55(e^{-2000t} - e^{-3092t}) \quad \text{V} \quad t > 0$$

## PRACTICE

8.13 Determine the capacitor voltage  $v$  in the circuit of Fig. 8.46 for  $t > 0$ .

Ans:  $23.5 \cos 3t + 22.8 \times 10^{-3} \sin 3t - 23.5e^{-3092t}$  V.

## 8.9 PREDICTING THE RESPONSE OF SEQUENTIALLY SWITCHED CIRCUITS

In Example 8.9 we briefly considered the response of an  $RL$  circuit to a pulse waveform, in which a source was effectively switched into and subsequently switched out of the circuit. This type of situation is common in practice, as few circuits are designed to be energized only once (passenger vehicle airbag triggering circuits, for example). In predicting the response of simple  $RL$  and  $RC$  circuits subjected to pulses and series of pulses—sometimes referred to as *sequentially switched circuits*—the key is the relative size of the circuit time constant to the various times that define the pulse sequence. The underlying principle behind the analysis will be whether the energy storage element has time to fully charge before the pulse ends, and whether it has time to fully discharge before the next pulse begins.

Consider the circuit shown in Fig. 8.47a, which is connected to a pulsed voltage source described by seven separate parameters defined in Fig. 8.47b. The waveform is bounded by two values,  $V_1$  and  $V_2$ . The time  $t_r$  required to change from  $V_1$  to  $V_2$  is called the *rise time (TR)*, and the time  $t_f$  required to change from  $V_2$  to  $V_1$  is called the *fall time (TF)*. The duration  $W_p$  of the pulse is referred to as the *pulse width (PW)*, and the *period T* of the waveform (**PER**) is the time it takes for the pulse to repeat. Note also that SPICE allows a time delay (**TD**) before the pulse train

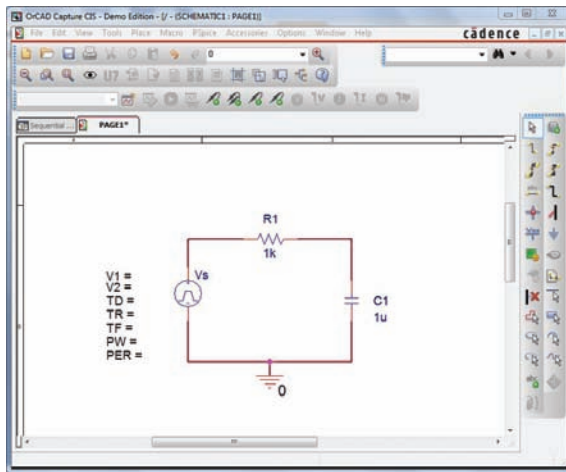

(a)

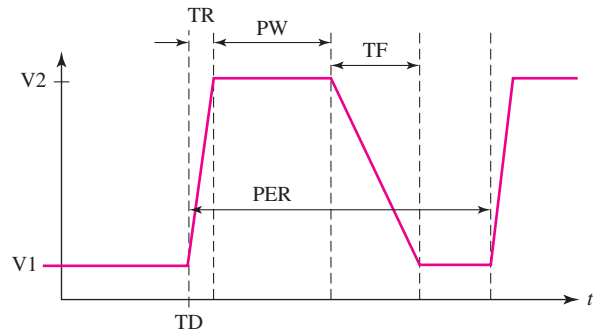

(b)

■ FIGURE 8.47 (a) Schematic of a simple  $RC$  circuit connected to a pulsed voltage waveform. (b) Diagram of the SPICE **VPULSE** parameter definitions.

begins, which can be useful in allowing initial transient responses to decay for some circuit configurations.

For the purposes of this discussion, we set a zero time delay,  $V1 = 0$ , and  $V2 = 9\text{ V}$ . The circuit time constant is  $\tau = RC = 1\text{ ms}$ , so we set the rise and fall times to be  $1\text{ ns}$ . Although SPICE will not allow a voltage to change in zero time since it solves the differential equations using discrete time intervals, compared to our circuit time constant  $1\text{ ns}$  is a reasonable approximation to “instantaneous.”

We will consider four basic cases, summarized in Table 8.1. In the first two cases, the pulse width  $W_p$  is much longer than the circuit time constant  $\tau$ , so we expect the transients resulting from the beginning of the pulse to die out before the pulse is over. In the latter two cases, the opposite is true: the pulse width is so short that the capacitor does not have time to fully charge before the pulse ends. A similar issue arises when we consider the response of the circuit when the time between pulses ( $T - W_p$ ) is either short (Case II) or long (Case III) compared to the circuit time constant.

**TABLE 8.1** Four Separate Cases of Pulse Width and Period Relative to the Circuit Time Constant of  $1\text{ ms}$

Case	Pulse Width $W_p$	Period $T$
I	$10\text{ ms } (\tau \ll W_p)$	$20\text{ ms } (\tau \ll T - W_p)$
II	$10\text{ ms } (\tau \ll W_p)$	$10.1\text{ ms } (\tau \gg T - W_p)$
III	$0.1\text{ ms } (\tau \gg W_p)$	$10.1\text{ ms } (\tau \ll T - W_p)$
IV	$0.1\text{ ms } (\tau \gg W_p)$	$0.2\text{ ms } (\tau \gg T - W_p)$

We qualitatively sketch the circuit response for each of the four cases in Fig. 8.48, arbitrarily selecting the capacitor voltage as the quantity of interest as any voltage or current is expected to have the same time dependence.

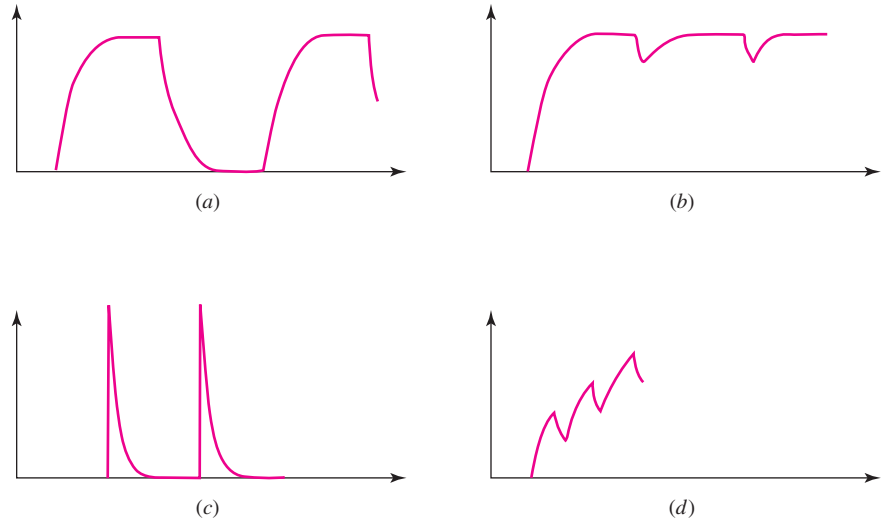

■ FIGURE 8.48 Capacitor voltage for the RC circuit, with pulse width and period as in (a) Case I; (b) Case II; (c) Case III; and (d) Case IV.

In Case I, the capacitor has time to both fully charge and fully discharge (Fig. 8.48a), whereas in Case II (Fig. 8.48b), when the time between pulses is reduced, it no longer has time to fully discharge. In contrast, the capacitor does not have time to fully charge in either Case III (Fig. 8.48c) or Case IV (Fig. 8.48d).

### Case I: Time Enough to Fully Charge and Fully Discharge

We can obtain exact values for the response in each case, of course, by performing a series of analyses. We consider Case I first. Since the capacitor has time to fully charge, the forced response will correspond to the 9 V dc driving voltage. The complete response to the first pulse is therefore

$$v_C(t) = 9 + Ae^{-1000t} \quad \text{V}$$

With  $v_C(0) = 0$ ,  $A = -9$  V and so

$$v_C(t) = 9(1 - e^{-1000t}) \quad \text{V} \quad [39]$$

in the interval of  $0 < t < 10$  ms. At  $t = 10$  ms, the source drops suddenly to 0 V, and the capacitor begins to discharge through the resistor. In this time interval we are faced with a simple “source-free” RC circuit, and we can write the response as

$$v_C(t) = Be^{-1000(t-0.01)} \quad 10 < t < 20 \text{ ms} \quad [40]$$

where  $B = 8.99959$  V is found by substituting  $t = 10$  ms in Eq. [39]; we will be pragmatic here and round this to 9 V, noting that the value calculated is consistent with our assumption that the initial transient dissipates before the pulse ends.

At  $t = 20$  ms, the voltage source jumps immediately back to 9 V. The capacitor voltage just prior to this event is given by substituting  $t = 20$  ms in Eq. [40], leading to  $v_C(20 \text{ ms}) = 408.6 \mu\text{V}$ , essentially zero compared to the peak value of 9 V.



If we keep to our convention of rounding to four significant digits, the capacitor voltage at the beginning of the second pulse is zero, which is the same as our starting point. Thus, Eqs. [39] and [40] form the basis of the response for all subsequent pulses, and we may write

$$v_C(t) = \begin{cases} 9(1 - e^{-1000t}) \text{ V} & 0 \leq t \leq 10 \text{ ms} \\ 9e^{-1000(t-0.01)} \text{ V} & 10 < t \leq 20 \text{ ms} \\ 9(1 - e^{-1000(t-0.02)}) \text{ V} & 20 < t \leq 30 \text{ ms} \\ 9e^{-1000(t-0.03)} \text{ V} & 30 < t \leq 40 \text{ ms} \end{cases}$$

and so on.

### Case II: Time Enough to Fully Charge But Not Fully Discharge

Next we consider what happens if the capacitor is not allowed to completely discharge (Case II). Equation [39] still describes the situation in the interval of  $0 < t < 10$  ms, and Eq. [40] describes the capacitor voltage in the interval between pulses, which has been reduced to  $10 < t < 10.1$  ms.

Just prior to the onset of the second pulse at  $t = 10.1$  ms,  $v_C$  is now 8.144 V; the capacitor has only had 0.1 ms to discharge, and therefore still retains 82 percent of its maximum energy when the next pulse begins. Thus, in the next interval,

$$v_C(t) = 9 + Ce^{-1000(t-10.1 \times 10^{-3})} \quad \text{V} \quad 10.1 < t < 20.1 \text{ ms}$$

where  $v_C(10.1 \text{ ms}) = 9 + C = 8.144 \text{ V}$ , so  $C = -0.856 \text{ V}$  and

$$v_C(t) = 9 - 0.856e^{-1000(t-10.1 \times 10^{-3})} \quad \text{V} \quad 10.1 < t < 20.1 \text{ ms}$$

which reaches the peak value of 9 V much more quickly than for the previous pulse.

### Case III: No Time to Fully Charge But Time to Fully Discharge

What if it isn't clear that the transient will dissipate before the end of the voltage pulse? In fact, this situation arises in Case III. Just as we wrote for Case I,

$$v_C(t) = 9 + Ae^{-1000t} \quad \text{V} \quad [41]$$

still applies to this situation, but now only in the interval  $0 < t < 0.1$  ms. Our initial condition has not changed, so  $A = -9 \text{ V}$  as before. Now, however, just before this first pulse ends at  $t = 0.1$  ms, we find that  $v_C = 0.8565 \text{ V}$ . This is a far cry from the maximum of 9 V possible if we allow the capacitor time to fully charge, and is a direct result of the pulse lasting only one-tenth of the circuit time constant.

The capacitor now begins to discharge, so that

$$v_C(t) = Be^{-1000(t-1 \times 10^{-4})} \quad \text{V} \quad 0.1 < t < 10.1 \text{ ms} \quad [42]$$

We have already determined that  $v_C(0.1^- \text{ ms}) = 0.8565 \text{ V}$ , so  $v_C(0.1^+ \text{ ms}) = 0.8565 \text{ V}$  and substitution into Eq. [42] yields  $B = 0.8565 \text{ V}$ . Just prior to the onset of the second pulse at  $t = 10.1$  ms, the capacitor voltage has decayed to essentially 0 V; this is the initial condition at the start of the second pulse and so Eq. [41] can be rewritten as

$$v_C(t) = 9 - 9e^{-1000(t-10.1 \times 10^{-3})} \quad \text{V} \quad 10.1 < t < 10.2 \text{ ms} \quad [43]$$

to describe the corresponding response.

### Case IV: No Time to Fully Charge or Even Fully Discharge

In the last case, we consider the situation where the pulse width and period are so short that the capacitor can neither fully charge nor fully discharge in any one period. Based on experience, we can write

$$v_C(t) = 9 - 9e^{-1000t} \quad \text{V} \quad 0 < t < 0.1 \text{ ms} \quad [44]$$

$$v_C(t) = 0.8565e^{-1000(t-1 \times 10^{-4})} \quad \text{V} \quad 0.1 < t < 0.2 \text{ ms} \quad [45]$$

$$v_C(t) = 9 + Ce^{-1000(t-2 \times 10^{-4})} \quad \text{V} \quad 0.2 < t < 0.3 \text{ ms} \quad [46]$$

$$v_C(t) = De^{-1000(t-3 \times 10^{-4})} \quad \text{V} \quad 0.3 < t < 0.4 \text{ ms} \quad [47]$$

Just prior to the onset of the second pulse at  $t = 0.2 \text{ ms}$ , the capacitor voltage has decayed to  $v_C = 0.7750 \text{ V}$ ; with insufficient time to fully discharge, it retains a large fraction of the little energy it had time to store initially. For the interval of  $0.2 < t < 0.3 \text{ ms}$ , substitution of  $v_C(0.2^+) = v_C(0.2^-) = 0.7750 \text{ V}$  into Eq. [46] yields  $C = -8.225 \text{ V}$ . Continuing, we evaluate Eq. [46] at  $t = 0.3 \text{ ms}$  and calculate  $v_C = 1.558 \text{ V}$  just prior to the end of the second pulse. Thus,  $D = 1.558 \text{ V}$  and our

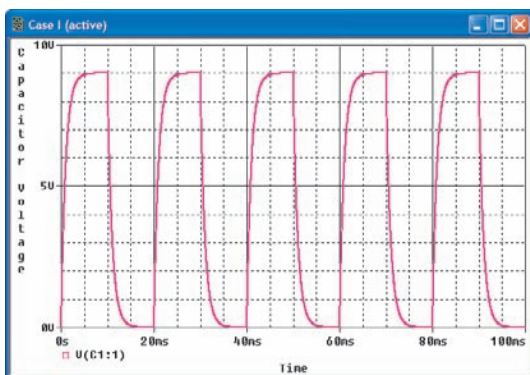

(a)

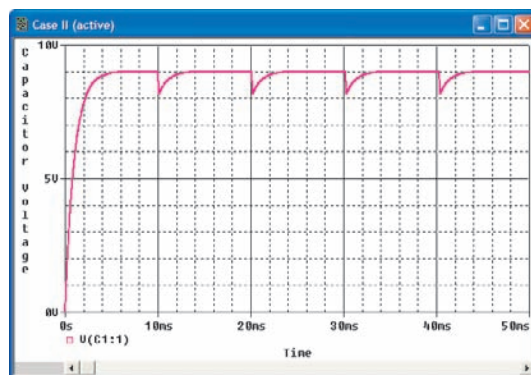

(b)

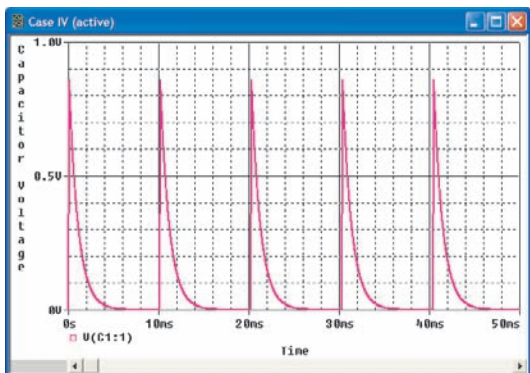

(c)

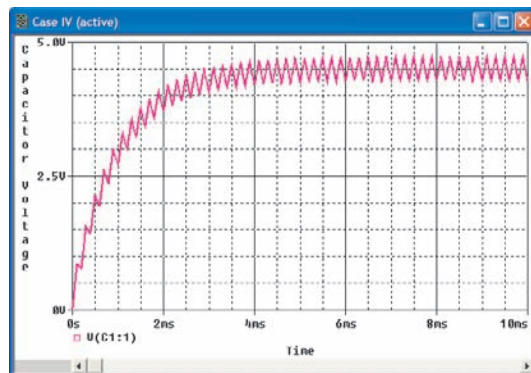

(d)

■ FIGURE 8.49 PSPice simulation results corresponding to (a) Case I; (b) Case II; (c) Case III; (d) Case IV.

capacitor is slowly charging to ever increase voltage levels over several pulses. At this stage it might be useful if we plot the detailed responses, so we show the PSpice simulation results of Cases I through IV in Fig. 8.49. Note in particular that in Fig. 8.49d, the small charge/discharge transient response similar in shape to that shown in Fig. 8.49a–c is superimposed on a charging-type response of the form  $(1 - e^{-t/\tau})$ . Thus, it takes about 3 to 5 circuit time constants for the capacitor to charge to its maximum value in situations where a single period does not allow it to fully charge or discharge!

What we have not yet done is predict the behavior of the response for  $t \gg 5\tau$ , although we would be interested in doing so, especially if it was not necessary to consider a very long sequence of pulses one at a time. We note that the response of Fig. 8.49d has an *average* value of 4.50 V from about 4 ms onward. This is exactly half the value we would expect if the voltage source pulse width allowed the capacitor to fully charge. In fact, this long-term average value can be computed by multiplying the dc capacitor voltage by the ratio of the pulse width to the period.



### PRACTICE

8.14 With regard to Fig. 8.50a, sketch  $i_L(t)$  in the range of  $0 < t < 6$  s for (a)  $v_S(t) = 3u(t) - 3u(t - 2) + 3u(t - 4) - 3u(t - 6) + \dots$ ; (b)  $v_S(t) = 3u(t) - 3u(t - 2) + 3u(t - 2.1) - 3u(t - 4.1) + \dots$ .

Ans: See Fig. 8.50b; see Fig. 8.50c.

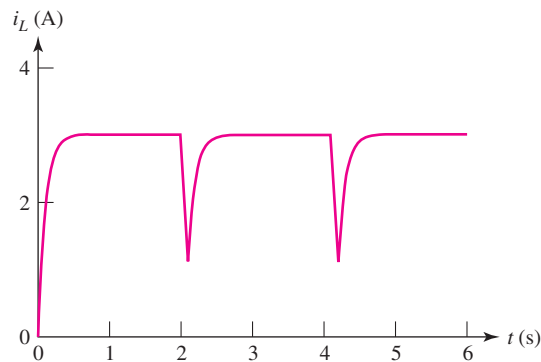
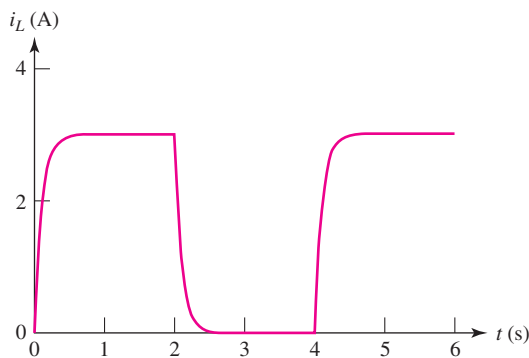
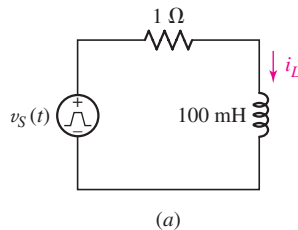
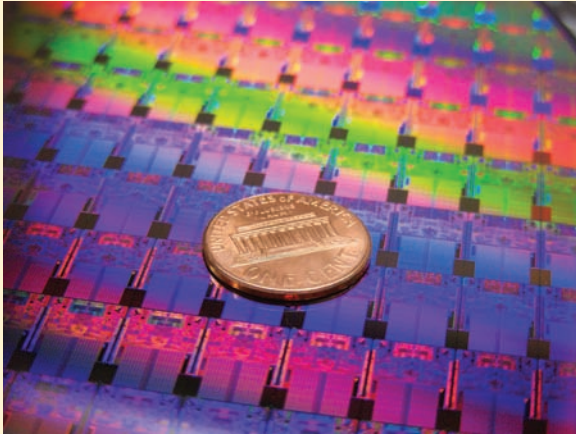

FIGURE 8.50 (a) Circuit for Practice Problem 8.14; (b) solution to part (a); (c) solution to part (b).

# PRACTICAL APPLICATION

## Frequency Limits in Digital Integrated Circuits

Modern digital integrated circuits such as programmable array logic (PALs) and microprocessors (Fig. 8.51) are composed of interconnected transistor circuits known as *gates*.



■ FIGURE 8.51 A silicon wafer with multiple, identical integrated circuit dies. Each die is smaller than a US 1 cent coin. Reprinted with permission of Intel Corporation.

Digital signals are represented symbolically by combinations of ones and zeros, and can be either data or instructions (such as “add” or “subtract”). Electrically, we represent a logic “1” by a “high” voltage, and a logic “0” by a “low” voltage. In practice, there is a range of voltages that correspond to each; for example, in the 7400 series of TTL logic integrated circuits, any voltage

between 2 and 5 V will be interpreted as a logic “1,” and any voltage between 0 and 0.8 V will be interpreted as a logic “0.” Voltages between 0.8 and 2 V do not correspond to either logic state, as shown in Fig. 8.52.

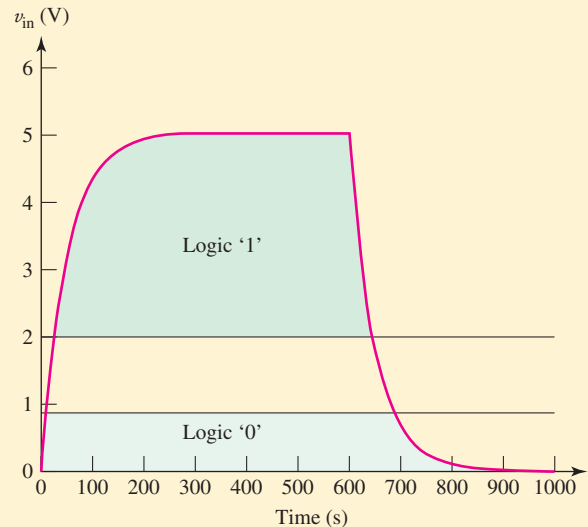

■ FIGURE 8.52 Charge/discharge characteristic of a pathway capacitance identifying the TTL voltage ranges for logic “1” and logic “0,” respectively.

A key parameter in digital circuits is the speed at which we can effectively use them. In this sense, “speed” refers to how quickly we can switch a gate from one logic state to another (either logic “0” to logic “1” or vice

## SUMMARY AND REVIEW

In this chapter we learned that circuits containing a single energy storage element (either an inductor or a capacitor) can be described by a characteristic time scale, namely, the *circuit time constant* ( $\tau = L/R$ , or  $\tau = RC$ , respectively). If we attempt to change the amount of energy stored in the element (either charging or discharging), *every* voltage and current in the circuit will include an exponential term of the form  $e^{-t/\tau}$ . After approximately *5 time constants* from the moment we attempted to alter the amount of stored energy, the *transient* response has *essentially disappeared* and we are left simply with a *forced* response which arises from the independent sources driving the circuit at times  $t > 0$ . When determining the forced response in a purely dc circuit, we may treat inductors as short circuits and capacitors as open circuits.

versa), and the time delay required to convey the output of one gate to the input of the next gate. Although transistors contain “built-in” capacitances that affect their switching speed, it is the *interconnect pathways* that presently limit the speed of the fastest digital integrated circuits. We can model the interconnect pathway between two logic gates using a simple  $RC$  circuit (although as feature sizes continue to decrease in modern designs, more detailed models are required to accurately predict circuit performance). For example, consider a  $2000\ \mu\text{m}$  long pathway  $2\ \mu\text{m}$  wide. We can model this pathway in a typical silicon-based integrated circuit as having a capacitance of  $0.5\ \text{pF}$  and a resistance of  $100\ \Omega$ , shown schematically in Fig. 8.53.

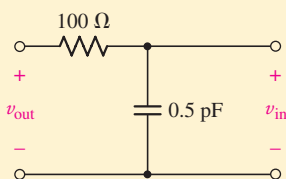

■ FIGURE 8.53 Circuit model for an integrated circuit pathway.

Let’s assume the voltage  $v_{\text{out}}$  represents the output voltage of a gate that is changing from a logic “0” state to a logic “1” state. The voltage  $v_{\text{in}}$  appears across the input of a second gate, and we are interested in how long it takes  $v_{\text{in}}$  to reach the same value as  $v_{\text{out}}$ .

Assuming the  $0.5\ \text{pF}$  capacitance that characterizes the interconnect pathway is initially discharged [i.e.,  $v_{\text{in}}(0) = 0$ ], calculating the  $RC$  time constant for our

pathway as  $\tau = RC = 50\ \text{ps}$ , and defining  $t = 0$  as when  $v_{\text{out}}$  changes, we obtain the expression

$$v_{\text{in}}(t) = Ae^{-t/\tau} + v_{\text{out}}(0)$$

Setting  $v_{\text{in}}(0) = 0$ , we find that  $A = -v_{\text{out}}(0)$  so that

$$v_{\text{in}}(t) = v_{\text{out}}(0)[1 - e^{-t/\tau}]$$

Upon examining this equation, we see that  $v_{\text{in}}$  will reach the value  $v_{\text{out}}(0)$  after  $\sim 5\tau$  or  $250\ \text{ps}$ . If the voltage  $v_{\text{out}}$  changes again before this transient time period is over, then the capacitance does not have sufficient time to fully charge. In such situations,  $v_{\text{in}}$  will be less than  $v_{\text{out}}(0)$ . Assuming that  $v_{\text{out}}(0)$  equals the minimum logic “1” voltage, for example, this means that  $v_{\text{in}}$  will not correspond to a logic “1.” If  $v_{\text{out}}$  now suddenly changes to  $0\ \text{V}$  (logic “0”), the capacitance will begin to discharge so that  $v_{\text{in}}$  decreases further. Thus, by switching our logic states too quickly, we are unable to transfer the information from one gate to another.

The fastest speed at which we can change logic states is therefore  $(5\tau)^{-1}$ . This can be expressed in terms of the maximum operating frequency:

$$f_{\text{max}} = \frac{1}{2(5\tau)} = 2\ \text{GHz}$$

where the factor of 2 represents a charge/discharge period. If we desire to operate our integrated circuit at a higher frequency so that calculations can be performed faster, we need to reduce the interconnect capacitance and/or the interconnect resistance.

We started our analysis with so-called source-free circuits to introduce the idea of time constants without unnecessary distractions; such circuits have zero forced response and a transient response derived entirely from the energy stored at  $t = 0$ . We reasoned that a capacitor cannot change its voltage in zero time (or an infinite current results), and indicated this by introducing the notation  $v_C(0^+) = v_C(0^-)$ . Similarly, the current through an inductor cannot change in zero time, or  $i_L(0^+) = i_L(0^-)$ . The *complete* response is always the sum of the transient response and the forced response. Applying the initial condition to the complete response allows us to determine the unknown constant which multiplies the transient term.

We spent a little time discussing modeling switches, both analytically and within the context of PSpice. A common mathematical representation makes use of the unit-step function  $u(t - t_0)$ , which has zero value for  $t < t_0$ , unity value for  $t > t_0$ , and is indeterminate for  $t = t_0$ . Unit-step

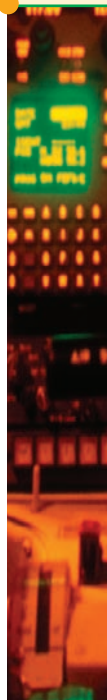

functions can “activate” a circuit (connecting sources so current can flow) for values of  $t$  preceding a specific time as well as after. Combinations of step functions can be used to create pulses and more complex waveforms. In the case of sequentially switched circuits, where sources are connected and disconnected repeatedly, we found the behavior of the circuits to depend strongly on both period and pulse width as they compare to the circuit time constant.

This is a good time to highlight some key points worth reviewing, along with relevant example(s).

- The response of a circuit having sources suddenly switched in or out of a circuit containing capacitors and inductors will always be composed of two parts: a *natural* response and a *forced* response.
- The form of the natural response (also referred to as the *transient response*) depends only on the component values and the way they are wired together. (Examples 8.1, 8.2)
- A circuit reduced to a single equivalent capacitance  $C$  and a single equivalent resistance  $R$  will have a natural response given by  $v(t) = V_0 e^{-t/\tau}$ , where  $\tau = RC$  is the circuit time constant. (Examples 8.3, 8.5)
- A circuit reduced to a single equivalent inductance  $L$  and a single equivalent resistance  $R$  will have a natural response given by  $i(t) = I_0 e^{-t/\tau}$ , where  $\tau = L/R$  is the circuit time constant. (Example 8.4)
- Circuits with dependent sources can be represented by a resistance using Thévenin procedures.
- The unit-step function is a useful way to model the closing or opening of a switch, provided we are careful to keep an eye on the initial conditions. (Examples 8.7, 8.9)
- The form of the forced response mirrors the form of the forcing function. Therefore, a dc forcing function always leads to a constant forced response. (Examples 8.7, 8.8)
- The *complete* response of an *RL* or *RC* circuit excited by a dc source will have the form  $f(0^+) = f(\infty) + A$  and  $f(t) = f(\infty) + [f(0^+) - f(\infty)]e^{-t/\tau}$ , or total response = final value + (initial value – final value) $e^{-t/\tau}$ . (Examples 8.9, 8.10, 8.11)
- The complete response for an *RL* or *RC* circuit may also be determined by writing a single differential equation for the quantity of interest and solving. (Examples 8.2, 8.11)
- When dealing with sequentially switched circuits, or circuits connected to pulsed waveforms, the relevant issue is whether the energy storage element has sufficient time to fully charge and to fully discharge, as measured relative to the circuit time constant.

## READING FURTHER

A guide to solution techniques for differential equations can be found in:

W. E. Boyce and R. C. DiPrima, *Elementary Differential Equations and Boundary Value Problems*, 7th ed. New York: Wiley, 2002.

A detailed description of transients in electric circuits is given in:

E. Weber, *Linear Transient Analysis Volume I*. New York: Wiley, 1954.  
(Out of print, but in many university libraries.)

## EXERCISES

### 8.1 The Source-Free $RL$ Circuit

- Setting  $R = 1 \text{ k}\Omega$  and  $L = 1 \text{ nH}$  for the circuit represented in Fig. 8.1, and with the knowledge that  $i(0) = -3 \text{ mA}$ , (a) write an expression for  $i(t)$  valid for all  $t \geq 0$ ; (b) compute  $i(t)$  at  $t = 0$ ,  $t = 1 \text{ ps}$ ,  $2 \text{ ps}$ , and  $5 \text{ ps}$ ; and (c) calculate the energy stored in the inductor at  $t = 0$ ,  $t = 1 \text{ ps}$ , and  $t = 5 \text{ ps}$ .
- If  $i(0) = 1 \text{ A}$  and  $R = 100 \Omega$  for the circuit of Fig. 8.1, (a) select  $L$  such that  $i(50 \text{ ms}) = 368 \text{ mA}$ ; (b) compute the energy stored in the inductor at  $t = 0$ ,  $50 \text{ ms}$ ,  $100 \text{ ms}$ , and  $150 \text{ ms}$ .
- Referring to the circuit shown in Fig. 8.1, select values for both elements such that  $L/R = 1$  and (a) calculate  $v_R(t)$  at  $t = 0, 1, 2, 3, 4$ , and  $5 \text{ s}$ ; (b) compute the power dissipated in the resistor at  $t = 0, 1 \text{ s}$ , and  $5 \text{ s}$ . (c) At  $t = 5 \text{ s}$ , what is the percentage of the initial energy still stored in the inductor?
- The circuit depicted in Fig. 8.1 is constructed from components whose value is unknown. If a current  $i(0)$  of  $6 \mu\text{A}$  initially flows through the inductor, and it is determined that  $i(1 \text{ ms}) = 2.207 \mu\text{A}$ , calculate the ratio of  $R$  to  $L$ .
- Determine the characteristic equation of each of the following differential equations:

$$(a) 5v + 14 \frac{dv}{dt} = 0; \quad (b) -9 \frac{di}{dt} - 18i = 0;$$

$$(c) \frac{di}{dt} + 18i + \frac{R}{B}i = 0; \quad (d) \frac{d^2f}{dt^2} + 8 \frac{df}{dt} + 2f = 0.$$

- For the following characteristic equations, write corresponding differential equations and find all roots, whether real, imaginary, or complex:  
(a)  $4s + 9 = 0$ ; (b)  $2s - 4 = 0$ ; (c)  $s^2 + 7s + 1 = 0$ ; (d)  $5s^2 + 8s + 18 = 0$ .
- With the assumption that the switch in the circuit of Fig. 8.54 has been closed a long, long, long time, calculate  $i_L(t)$  at (a) the instant just before the switch opens; (b) the instant just after the switch opens; (c)  $t = 15.8 \mu\text{s}$ ; (d)  $t = 31.5 \mu\text{s}$ ; (e)  $t = 78.8 \mu\text{s}$ .

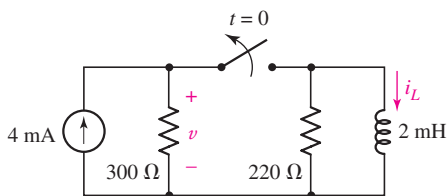

■ FIGURE 8.54

- The switch in Fig. 8.54 has been closed since Catfish Hunter last pitched for the New York Yankees. Calculate the voltage labeled  $v$  as well as the energy stored in the inductor at (a) the instant just prior to the switch being thrown open; (b) the instant just after the switch is opened; (c)  $t = 8 \mu\text{s}$ ; (d)  $t = 80 \mu\text{s}$ .
- The switch in the circuit of Fig. 8.55 has been closed a ridiculously long time before suddenly being thrown open at  $t = 0$ . (a) Obtain expressions for  $i_L$  and  $v$  in the circuit of Fig. 8.55 which are valid for all  $t \geq 0$ . (b) Calculate  $i_L(t)$  and

$v(t)$  at the instant just prior to the switch opening, at the instant just after the switch opening, and at  $t = 470 \mu\text{s}$ .

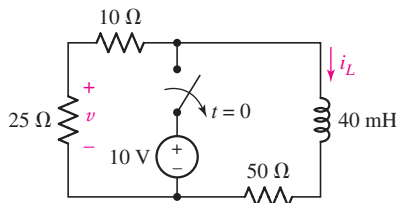

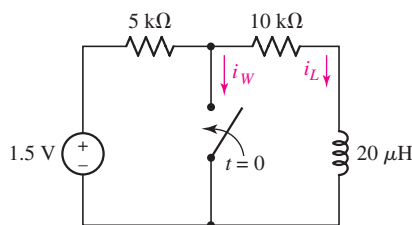

■ FIGURE 8.55

10. Assuming the switch initially has been open for a really, really long time, (a) obtain an expression for  $i_W$  in the circuit of Fig. 8.56 which is valid for all  $t \geq 0$ ; (b) calculate  $i_W$  at  $t = 0$  and  $t = 1.3 \text{ ns}$ .



■ FIGURE 8.56

## 8.2 Properties of the Exponential Response

11. (a) Graph the function  $f(t) = 10e^{-2t}$  over the range of  $0 \leq t \leq 2.5 \text{ s}$  using linear scales for both  $y$  and  $x$  axes. (b) Replot with a logarithmic scale for the  $y$  axis. [Hint: the function `semilogy()` can be helpful here.] (c) What are the units of the 2 in the argument of the exponential? (d) At what time does the function reach a value of 9? 8? 1?
12. The current  $i(t)$  flowing through a  $1 \Omega$  resistor is given by  $i(t) = 5e^{-10t} \text{ mA}$ ,  $t \geq 0$ . (a) Determine the values of  $t$  for which the resistor voltage magnitude is equal to 5 V, 2.5 V, 0.5 V, and 5 mV. (b) Graph the function over the range of  $0 \leq t \leq 1 \text{ s}$  using linear scales for both axes. (c) Draw a tangent to your curve at  $t = 100 \text{ ms}$ , and determine where the tangent intersects the time axis.
13. The thickness of a solar cell must be chosen carefully to ensure photons are properly absorbed; even metals can be partly transparent when rolled out into very thin foils. If the incident light flux (number of photons per unit area per unit time) at the solar cell surface ( $x = 0$ ) is given by  $\Phi_0$ , and the intensity of light a distance  $x$  inside the solar cell is given by  $\Phi(x)$ , the behavior of  $\Phi(x)$  is described by the equation  $d\Phi/dx + \alpha\Phi = 0$ . Here,  $\alpha$ , known as the absorption coefficient, is a constant specific to a given semiconductor material. (a) What is the SI unit for  $\alpha$ ? (b) Obtain an expression for  $\Phi(x)$  in terms of  $\Phi_0$ ,  $\alpha$ , and  $x$ . (c) How thick should the solar cell be made in order to absorb at least 38% of the incident light? Express your answer in terms of  $\alpha$ . (d) What happens to the light which enters the solar cell at  $x = 0$  but is not absorbed?
-  14. For the circuit of Fig. 8.5, compute the time constant if the  $10 \Omega$  resistor is replaced with (a) a short circuit; (b) a  $1 \Omega$  resistor; (c) a series connection of two  $5 \Omega$  resistors; (d) a  $100 \Omega$  resistor. (e) Verify your answers with a suitable parameter sweep simulation. (Hint: the cursor tool might come in handy, and the answer does not depend on the initial current you choose for the inductor.)
-  15. Design a circuit which will produce a voltage of 1 V at some initial time, and a voltage of 368 mV at a time 5 seconds later. You may specify an initial inductor current without showing how it arises.



### 8.3 The Source-Free RC Circuit

16. The resistor in the circuit of Fig. 8.57 has been included to model the dielectric layer separating the plates of the 3.1 nF capacitor, and has a value of 55 M $\Omega$ . The capacitor is storing 200 mJ of energy just prior to  $t = 0$ . (a) Write an expression for  $v(t)$  valid for  $t \geq 0$ . (b) Compute the energy remaining in the capacitor at  $t = 170$  ms. (c) Graph  $v(t)$  over the range of  $0 < t < 850$  ms, and identify the value of  $v(t)$  when  $t = 2\tau$ .

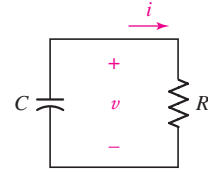

FIGURE 8.57

17. The resistor in the circuit of Fig. 8.57 has a value of 1  $\Omega$  and is connected to a 22 mF capacitor. The capacitor dielectric has infinite resistance, and the device is storing 891 mJ of energy just prior to  $t = 0$ . (a) Write an expression for  $v(t)$  valid for  $t \geq 0$ . (b) Compute the energy remaining in the capacitor at  $t = 11$  ms and 33 ms. (c) If it is determined that the capacitor dielectric is much leakier than expected, having a resistance as low as 100 k $\Omega$ , repeat parts (a) and (b).

18. Calculate the time constant of the circuit depicted in Fig. 8.57 if  $C = 10$  mF and  $R$  is equal to (a) 1  $\Omega$ ; (b) 10  $\Omega$ ; (c) 100  $\Omega$ . (d) Verify your answers with an appropriate parameter sweep simulation. (Hint: the cursor tool might come in handy, and the time constant does not depend on the initial voltage across the capacitor.)

19. Design a capacitor-based circuit that will provide (a) a voltage of 9 V at some time  $t = 0$ , and a voltage of 1.2 V at a time 4 ms later; (b) a current of 1 mA at some time  $t = 0$ , and a reduced current of 50  $\mu$ A at a time 100 ns later. (You can choose to design two separate circuits if desired, and do not need to show how the initial capacitor voltage is set.)

20. It is safe to assume that the switch drawn in the circuit of Fig. 8.58 has been closed such a long time that any transients which might have arisen from first connecting the voltage source have disappeared. (a) Determine the circuit time constant. (b) Calculate the voltage  $v(t)$  at  $t = \tau$ ,  $2\tau$ , and  $5\tau$ .

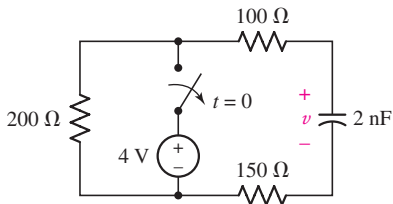

FIGURE 8.58

21. We can safely assume the switch in the circuit of Fig. 8.59 was closed a very long time prior to being thrown open at  $t = 0$ . (a) Determine the circuit time constant. (b) Obtain an expression for  $i_1(t)$  which is valid for  $t > 0$ . (c) Determine the power dissipated by the 12  $\Omega$  resistor at  $t = 500$  ms.

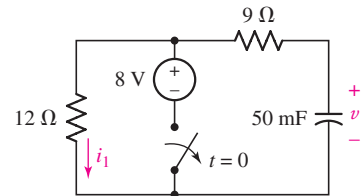

FIGURE 8.59

22. The switch above the 12 V source in the circuit of Fig. 8.60 has been closed since just after the wheel was invented. It is finally thrown open at  $t = 0$ . (a) Compute the circuit time constant. (b) Obtain an expression for  $v(t)$  valid for  $t > 0$ . (c) Calculate the energy stored in the capacitor 170 ms after the switch is opened.

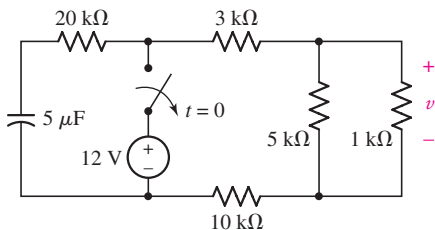
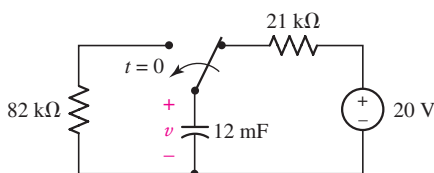

FIGURE 8.60

23. For the circuit represented schematically in Fig. 8.61, (a) calculate  $v(t)$  at  $t = 0$ ,  $t = 984$  s, and  $t = 1236$  s; (b) determine the energy still stored in the capacitor at  $t = 100$  s.



■ FIGURE 8.61

24. For the circuit depicted in Fig. 8.62, (a) compute the circuit time constant; (b) determine  $v$  in the instant just before the switch is closed; (c) obtain an expression for  $v(t)$  valid for  $t > 0$ ; (d) calculate  $v(3$  ms).

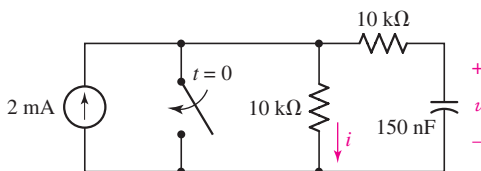

■ FIGURE 8.62

25. The switch drawn in Fig. 8.62 has been open a ponderously long time. (a) Determine the value of the current labeled  $i$  just prior to the switch being closed. (b) Obtain the value of  $i$  just after the switch is closed. (c) Compute the power dissipated in each resistor over the range of  $0 < t < 15$  ms. (d) Graph your answer to part (c).

### 8.4 A More General Perspective

26. (a) Obtain an expression for  $v(t)$ , the voltage which appears across resistor  $R_3$  in the circuit of Fig. 8.63, which is valid for  $t > 0$ . (b) If  $R_1 = 2R_2 = 3R_3 = 4R_4 = 1.2$  k $\Omega$ ,  $L = 1$  mH, and  $i_L(0^-) = 3$  mA, calculate  $v(t = 500$  ns).

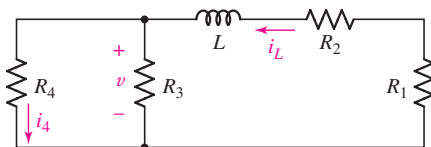

■ FIGURE 8.63

27. For the circuit of Fig. 8.64, determine  $i_x$ ,  $i_L$ , and  $v_L$  at  $t$  equal to (a)  $0^-$ ; (b)  $0^+$ .

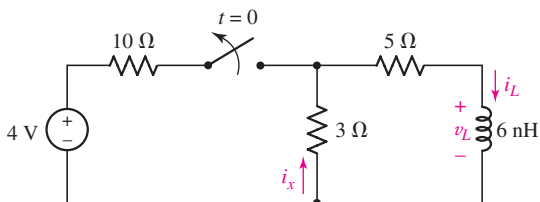

■ FIGURE 8.64

28. The switch shown in Fig. 8.65 has been closed for 6 years prior to being flipped open at  $t = 0$ . Determine  $i_L$ ,  $v_L$ , and  $v_R$  at  $t$  equal to (a)  $0^-$ ; (b)  $0^+$ ; (c)  $1 \mu\text{s}$ ; (d)  $10 \mu\text{s}$ .

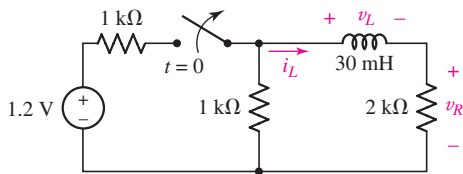

FIGURE 8.65

29. Obtain expressions for both  $i_1(t)$  and  $i_L(t)$  as labeled in Fig. 8.66, which are valid for  $t > 0$ .

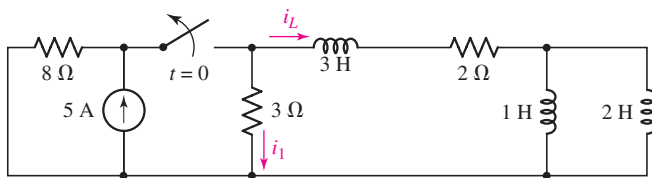

FIGURE 8.66

30. The voltage across the resistor in a simple source-free  $RL$  circuit is given by  $5e^{-90t}$  V,  $t > 0$ . The inductor value is not known. (a) At what time will the inductor voltage be exactly one-half of its maximum value? (b) At what time will the inductor current reach 10% of its maximum value?
31. Referring to Fig. 8.67, calculate the currents  $i_1$  and  $i_2$  at  $t$  equal to (a) 1 ms; (b) 3 ms.

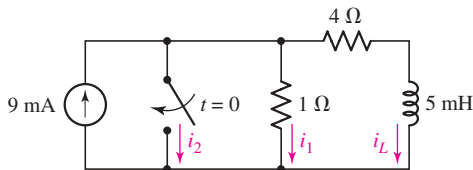

FIGURE 8.67

32. (a) Obtain an expression for  $v_x$  as labeled in the circuit of Fig. 8.68. (b) Evaluate  $v_x$  at  $t = 5$  ms. (c) Verify your answer with an appropriate PSpice simulation. (Hint: employ the part named `Sw_tClose`.)

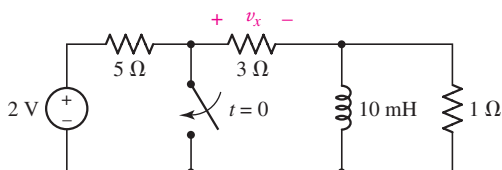
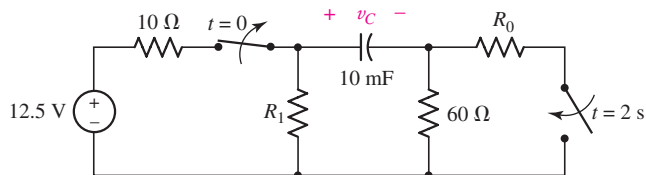

FIGURE 8.68

33. Design a complete circuit which provides a voltage  $v_{ab}$  across two terminals labeled  $a$  and  $b$ , respectively, such that  $v_{ab} = 5$  V at  $t = 0^-$ , 2 V at  $t = 1$  s, and less than 60 mV at  $t = 5$ . Verify the operation of your circuit using an appropriate PSpice simulation. (Hint: employ the part named `Sw_tOpen` or `Sw_tClose` as appropriate.)



34. For the part **Sw tOpen**, PSpice actually employs a sequence of simulations where the part is first replaced with a resistor having value  $1\text{ M}\Omega$ , and then replaced with a resistor having value  $10\text{ m}\Omega$  corresponding to when the switch opens. (a) Evaluate the reliability of these default values by simulating the circuit of Fig. 8.55, and evaluating  $i_L$  at  $t = 1\text{ ns}$ . (b) Repeat part (a) with **RCLOSED** changed to  $1\ \Omega$ . Did this change your answer? (c) Repeat part (a) with **ROPEN** changed to  $100\text{ k}\Omega$  and **RCLOSED** reset to its default value. Did this change your answer? (*Hint*: double-click on the part to access its attributes.)
35. Select values for the resistors  $R_0$  and  $R_1$  in the circuit of Fig. 8.69 such that  $v_C(0.65) = 5.22\text{ V}$  and  $v_C(2.21) = 1\text{ V}$ .



■ FIGURE 8.69

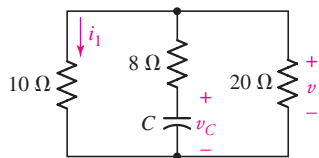

■ FIGURE 8.70

36. A quick measurement determines that the capacitor voltage  $v_C$  in the circuit of Fig. 8.70 is  $2.5\text{ V}$  at  $t = 0^-$ . (a) Determine  $v_C(0^+)$ ,  $i_1(0^+)$ , and  $v(0^+)$ . (b) Select a value of  $C$  so that the circuit time constant is equal to  $14\text{ s}$ .
37. Determine  $v_C(t)$  and  $v_o(t)$  as labeled in the circuit represented by Fig. 8.71 for  $t$  equal to (a)  $0^-$ ; (b)  $0^+$ ; (c)  $10\text{ ms}$ ; (d)  $12\text{ ms}$ .

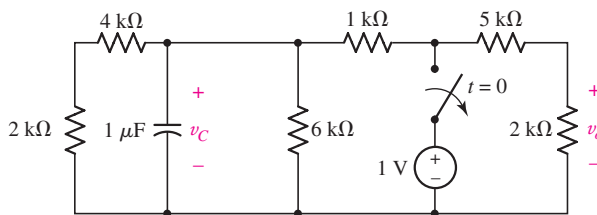

■ FIGURE 8.71

38. For the circuit shown in Fig. 8.72, determine (a)  $v_C(0^-)$ ; (b)  $v_C(0^+)$ ; (c) the circuit time constant; (d)  $v_C(3\text{ ms})$ .

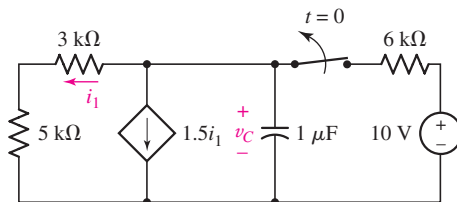

■ FIGURE 8.72

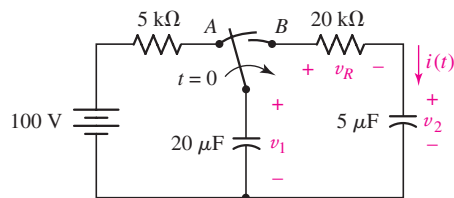

■ FIGURE 8.73

39. The switch in Fig. 8.73 is moved from  $A$  to  $B$  at  $t = 0$  after being at  $A$  for a long time. This places the two capacitors in series, thus allowing equal and opposite dc voltages to be trapped on the capacitors. (a) Determine  $v_1(0^-)$ ,  $v_2(0^-)$ , and  $v_R(0^-)$ . (b) Find  $v_1(0^+)$ ,  $v_2(0^+)$ , and  $v_R(0^+)$ . (c) Determine the time constant of  $v_R(t)$ . (d) Find  $v_R(t)$ ,  $t > 0$ . (e) Find  $i(t)$ . (f) Find  $v_1(t)$  and  $v_2(t)$  from  $i(t)$  and the initial values. (g) Show that the stored energy at  $t = \infty$  plus the total energy dissipated in the  $20\text{ k}\Omega$  resistor is equal to the energy stored in the capacitors at  $t = 0$ .

40. The inductor in Fig. 8.74 is storing 54 nJ at  $t = 0^-$ . Compute the energy remaining at  $t$  equal to (a)  $0^+$ ; (b) 1 ms; (c) 5 ms.

### 8.5 The Unit-Step Function

41. Evaluate the following functions at  $t = -2, 0,$  and  $+2$ : (a)  $f(t) = 3u(t)$ ; (b)  $g(t) = 5u(-t) + 3$ ; (c)  $h(t) = 5u(t - 3)$ ; (d)  $z(t) = 7u(1 - t) + 4u(t + 3)$ .
42. Evaluate the following functions at  $t = -1, 0,$  and  $+3$ : (a)  $f(t) = tu(1 - t)$ ; (b)  $g(t) = 8 + 2u(2 - t)$ ; (c)  $h(t) = u(t + 1) - u(t - 1) + u(t + 2) - u(t - 4)$ ; (d)  $z(t) = 1 + u(3 - t) + u(t - 2)$ .
43. Sketch the following functions over the range  $-3 \leq t \leq 3$ : (a)  $v(t) = 3 - u(2 - t) - 2u(t)$  V; (b)  $i(t) = u(t) - u(t - 0.5) + u(t - 1) - u(t - 1.5) + u(t - 2) - u(t - 2.5)$  A; (c)  $q(t) = 8u(-t)$  C.
44. Use step functions to construct an equation that describes the waveform sketched in Fig. 8.75.

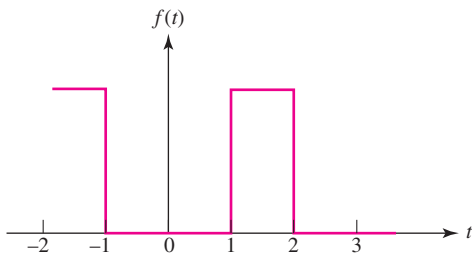

■ FIGURE 8.75

45. Employing step functions as appropriate, describe the voltage waveform graphed in Fig. 8.76.

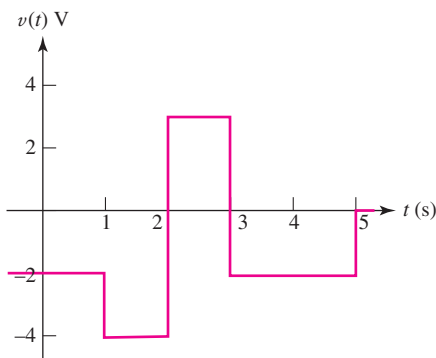

■ FIGURE 8.76

### 8.6 Driven RL Circuits

46. With reference to the simple circuit depicted in Fig. 8.77, compute  $i(t)$  for (a)  $t = 0^-$ ; (b)  $t = 0^+$ ; (c)  $t = 1^-$ ; (d)  $t = 1^+$ ; (e)  $t = 2$  ms.

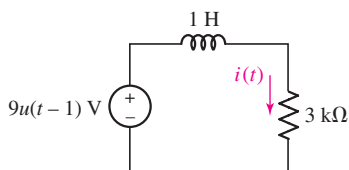

■ FIGURE 8.77

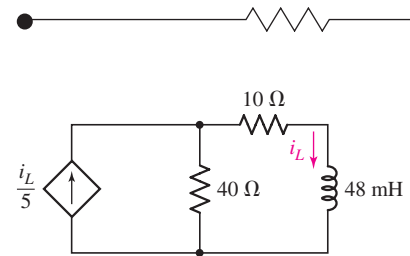

■ FIGURE 8.74



47. For the circuit given in Fig. 8.78, (a) determine  $v_L(0^-)$ ,  $v_L(0^+)$ ,  $i_L(0^-)$ , and  $i_L(0^+)$ ; (b) calculate  $i_L(150 \text{ ns})$ . (c) Verify your answer to part (b) with an appropriate PSpice simulation.

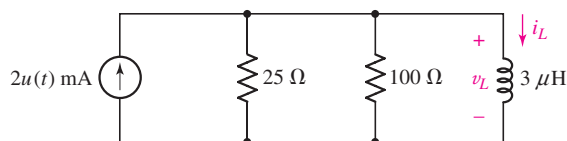

■ FIGURE 8.78

48. The circuit depicted in Fig. 8.79 contains two independent sources, one of which is only active for  $t > 0$ . (a) Obtain an expression for  $i_L(t)$  valid for all  $t$ ; (b) calculate  $i_L(t)$  at  $t = 10 \mu\text{s}$ ,  $20 \mu\text{s}$ , and  $50 \mu\text{s}$ .

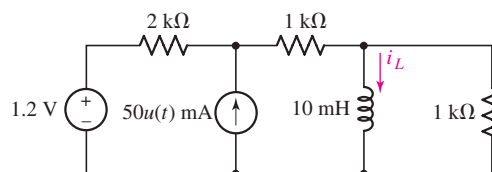

■ FIGURE 8.79

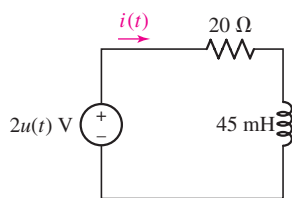

■ FIGURE 8.80

49. The circuit shown in Fig. 8.80 is powered by a source which is inactive for  $t < 0$ . (a) Obtain an expression for  $i(t)$  valid for all  $t$ . (b) Graph your answer over the range of  $-1 \text{ ms} \leq t \leq 10 \text{ ms}$ .

50. For the circuit shown in Fig. 8.81, (a) obtain an expression for  $i(t)$  valid for all time; (b) obtain an expression for  $v_R(t)$  valid for all time; and (c) graph both  $i(t)$  and  $v_R(t)$  over the range of  $-1 \text{ s} \leq t \leq 6 \text{ s}$ .

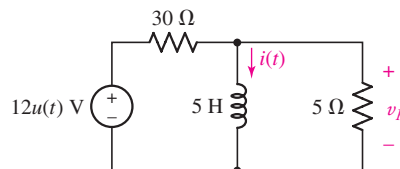

■ FIGURE 8.81

## 8.7 Natural and Forced Response

51. For the two-source circuit of Fig. 8.82, note that one source is always on. (a) Obtain an expression for  $i(t)$  valid for all  $t$ ; (b) determine at what time the energy stored in the inductor reaches 99% of its maximum value.

52. (a) Obtain an expression for  $i_L$  as labeled in Fig. 8.83 which is valid for all values of  $t$ . (b) Sketch your result over the range  $-1 \text{ ms} \leq t \leq 3 \text{ ms}$ .

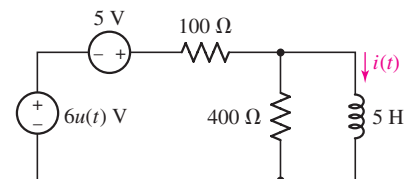

■ FIGURE 8.82

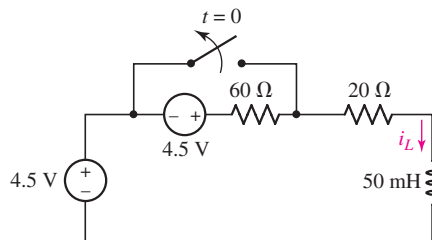

■ FIGURE 8.83

53. Obtain an expression for  $i(t)$  as labeled in the circuit diagram of Fig. 8.84, and determine the power being dissipated in the  $40\ \Omega$  resistor at  $t = 2.5\ \text{ms}$ .

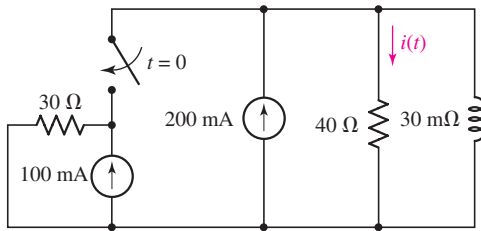

■ FIGURE 8.84

54. Obtain an expression for  $i_1$  as indicated in Fig. 8.85 that is valid for all values of  $t$ .

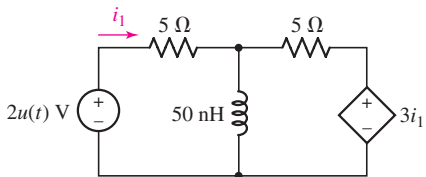

■ FIGURE 8.85

55. Plot the current  $i(t)$  in Fig. 8.86 if (a)  $R = 10\ \Omega$ ; (b)  $R = 1\ \Omega$ . In which case does the inductor (temporarily) store the most energy? *Explain.*

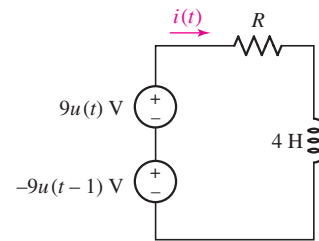

■ FIGURE 8.86

## 8.8 Driven RC Circuits

56. (a) Obtain an expression for  $v_C$  in the circuit of Fig. 8.87 valid for all values of  $t$ . (b) Sketch  $v_C(t)$  over the range  $0 \leq t \leq 4\ \mu\text{s}$ .
57. Obtain an equation which describes the behavior of  $i_A$  as labeled in Fig. 8.88 over the range of  $-1\ \text{ms} \leq t \leq 5\ \text{ms}$ .

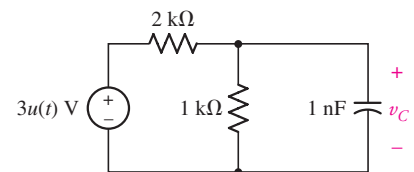

■ FIGURE 8.87

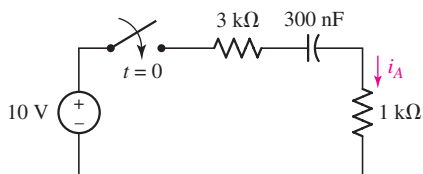

■ FIGURE 8.88



58. The switch in the circuit of Fig. 8.89 has been closed an incredibly long time, before being thrown open at  $t = 0$ . (a) Evaluate the current labeled  $i_x$  at  $t = 70\ \text{ms}$ . (b) Verify your answer with an appropriate PSpice simulation.

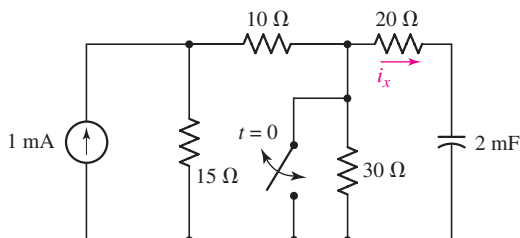

■ FIGURE 8.89



59. The switch in the circuit of Fig. 8.89 has been open a really, really incredibly long time, before being closed without further fanfare at  $t = 0$ . (a) Evaluate the current labeled  $i_x$  at  $t = 70$  ms. (b) Verify your answer with an appropriate PSpice simulation.
60. The “make-before-break” switch shown in Fig. 8.90 has been in position  $a$  since the first episode of “Jonny Quest” aired on television. It is moved to position  $b$ , finally, at time  $t = 0$ . (a) Obtain expressions for  $i(t)$  and  $v_C(t)$  valid for all values of  $t$ . (b) Determine the energy remaining in the capacitor at  $t = 33 \mu\text{s}$ .

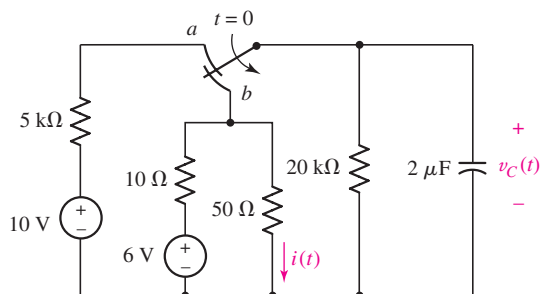

■ FIGURE 8.90

61. The switch in the circuit of Fig. 8.91, often called a *make-before-break* switch (since during switching it briefly makes contact to both parts of the circuit to ensure a smooth electrical transition), moves to position  $b$  at  $t = 0$  only after being in position  $a$  long enough to ensure all initial transients arising from turning on the sources have long since decayed. (a) Determine the power received by the  $5 \Omega$  resistor at  $t = 0^-$ . (b) Determine the power dissipated in the  $3 \Omega$  resistor at  $t = 2$  ms.

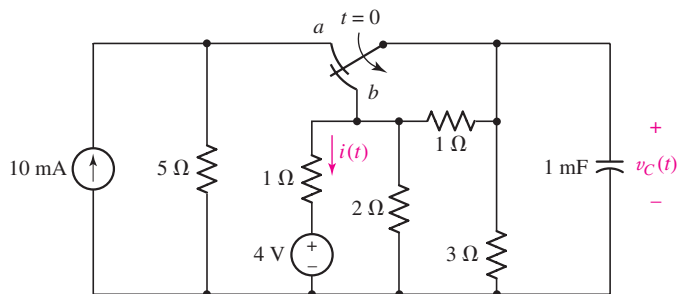

■ FIGURE 8.91

62. Referring to the circuit represented in Fig. 8.92, (a) obtain an equation which describes  $v_C$  valid for all values of  $t$ ; (b) determine the energy remaining in the capacitor at  $t = 0^+$ ,  $t = 25 \mu\text{s}$ , and  $t = 150 \mu\text{s}$ .

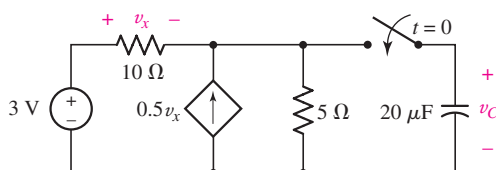

■ FIGURE 8.92



63. The dependent source shown in Fig. 8.92 is unfortunately installed upside down during manufacturing, so that the terminal corresponding to the arrowhead is actually wired to the negative reference terminal of the voltage source. This is not detected by the quality assurance team so the unit ships out wired improperly. The capacitor is initially discharged. If the  $5\ \Omega$  resistor is only rated to  $2\ \text{W}$ , after what time  $t$  is the circuit likely to fail?
64. For the circuit represented in Fig. 8.93, (a) obtain an expression for  $v$  which is valid for all values of  $t$ ; (b) sketch your result for  $0 \leq t \leq 3\ \text{s}$ .

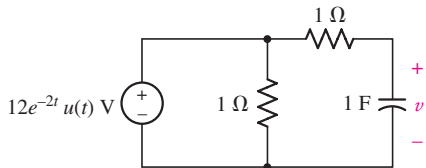

■ FIGURE 8.93

65. Obtain an expression for the voltage  $v_x$  as labeled in the op amp circuit of Fig. 8.94.

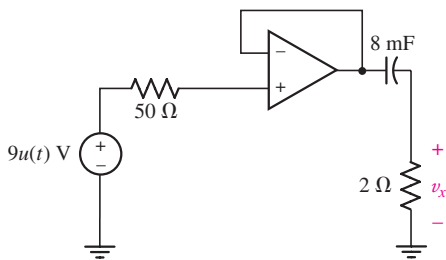

■ FIGURE 8.94

## 8.9 Predicting the Response of Sequentially Switched Circuits

66. Sketch the current  $i_L$  of the circuit in Fig. 8.50a if the  $100\ \text{mH}$  inductor is replaced by a  $1\ \text{nH}$  inductor, and is subjected to the waveform  $v_s(t)$  equal to  
 (a)  $5u(t) - 5u(t - 10^{-9}) + 5u(t - 2 \times 10^{-9})\ \text{V}$ ,  $0 \leq t \leq 4\ \text{ns}$ ;  
 (b)  $9u(t) - 5u(t - 10^{-8}) + 5u(t - 2 \times 10^{-8})\ \text{V}$ ,  $0 \leq t \leq 40\ \text{ns}$ .
67. The  $100\ \text{mH}$  inductor in the circuit of Fig. 8.50a is replaced with a  $1\ \text{H}$  inductor. Sketch the inductor current  $i_L$  if the source  $v_s(t)$  is equal to  
 (a)  $5u(t) - 5u(t - 0.01) + 5u(t - 0.02)\ \text{V}$ ,  $0 \leq t \leq 40\ \text{ms}$ ;  
 (b)  $5u(t) - 5u(t - 10) + 5u(t - 10.1)\ \text{V}$ ,  $0 \leq t \leq 11\ \text{s}$ .

-  68. Sketch the voltage  $v_C$  across the capacitor of Fig. 8.95 for at least 3 periods if  $R = 1\ \Omega$ ,  $C = 1\ \text{F}$ , and  $v_s(t)$  is a pulsed waveform having (a) minimum of  $0\ \text{V}$ , maximum of  $2\ \text{V}$ , rise and fall times of  $1\ \text{ms}$ , pulse width of  $10\ \text{s}$ , and period of  $10\ \text{s}$ ; (b) minimum of  $0\ \text{V}$ , maximum of  $2\ \text{V}$ , rise and fall times of  $1\ \text{ms}$ , pulse width of  $10\ \text{ms}$ , and period of  $10\ \text{ms}$ . (c) Verify your answers with appropriate PSpice simulations.

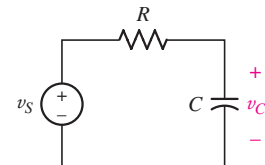

■ FIGURE 8.95

-  69. Sketch the voltage  $v_C$  across the capacitor of Fig. 8.95 for at least 3 periods if  $R = 1\ \Omega$ ,  $C = 1\ \text{F}$ , and  $v_s(t)$  is a pulsed waveform having (a) minimum of  $0\ \text{V}$ , maximum of  $2\ \text{V}$ , rise and fall times of  $1\ \text{ms}$ , pulse width of  $10\ \text{s}$ , and period of  $10\ \text{ms}$ ; (b) minimum of  $0\ \text{V}$ , maximum of  $2\ \text{V}$ , rise and fall times of  $1\ \text{ms}$ , pulse width of  $10\ \text{ms}$ , and period of  $10\ \text{s}$ . (c) Verify your answers with appropriate PSpice simulations.

## Chapter-Integrating Exercises

70. The circuit in Fig. 8.96 contains two switches that always move in perfect synchronization. However, when switch *A* opens, switch *B* closes, and vice versa. Switch *A* is initially open, while switch *B* is initially closed; they change positions every 40 ms. Using the bottom node as the reference node, determine the voltage across the capacitor at *t* equal to (a)  $0^-$ ; (b)  $0^+$ ; (c)  $40^-$  ms; (d)  $40^+$  ms; (e) 50 ms.

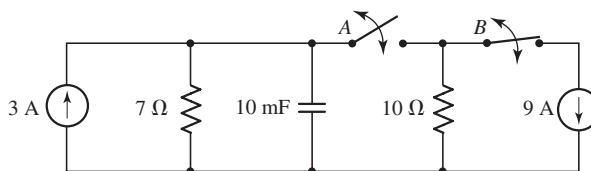

■ FIGURE 8.96

71. In the circuit of Fig. 8.96, when switch *A* opens, switch *B* closes, and vice versa. Switch *A* is initially open, while switch *B* is initially closed; they change positions every 400 ms. Determine the energy in the capacitor at *t* equal to (a)  $0^-$ ; (b)  $0^+$ ; (c) 200 ms; (d)  $400^-$  ms; (e)  $400^+$  ms; (f) 700 ms.

72. Refer to the circuit of Fig. 8.97, which contains a voltage-controlled dependent voltage source in addition to two resistors. (a) Compute the circuit time constant. (b) Obtain an expression for  $v_x$  valid for all *t*. (c) Plot the power dissipated in the resistor over the range of 6 time constants. (d) Repeat parts (a) to (c) if the dependent source is installed in the circuit upside down. (e) Are both circuit configurations “stable”? *Explain*.

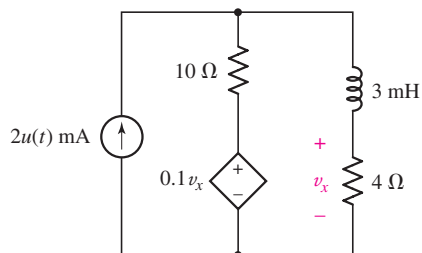

■ FIGURE 8.97

73. In the circuit of Fig. 8.97, a 3 mF capacitor is accidentally installed instead of the inductor. Unfortunately, that’s not the end of the problems, as it’s later determined that the real capacitor is not really well modeled by an ideal capacitor, and the dielectric has a resistance of 10 kΩ (which should be viewed as connected in parallel to the ideal capacitor). (a) Compute the circuit time constant with and without taking the dielectric resistance into account. By how much does the dielectric change your answer? (b) Calculate  $v_x$  at  $t = 200$  ms. Does the dielectric resistance affect your answer significantly? *Explain*.

74. For the circuit of Fig. 8.98, assuming an ideal op amp, derive an expression for  $v_o(t)$  if  $v_s$  is equal to (a)  $4u(t)$  V; (b)  $4e^{-130,000t}u(t)$  V.

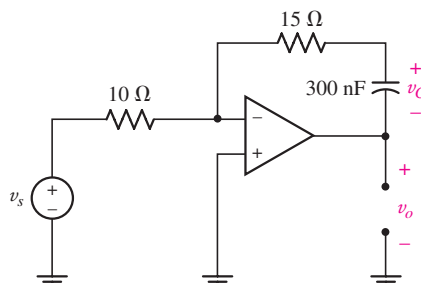

■ FIGURE 8.98

# The *RLC* Circuit

## INTRODUCTION

In Chap. 8 we studied circuits which contained only **one** energy storage element, combined with a passive network which partly determined how long it took either the capacitor or the inductor to charge/discharge. The differential equations which resulted from analysis were always first-order. In this chapter, we consider more complex circuits which contain **both** an inductor **and** a capacitor. The result is a **second-order** differential equation for any voltage or current of interest. What we learned in Chap. 8 is easily extended to the study of these so-called *RLC* circuits, although now we need **two** initial conditions to solve each differential equation. Such circuits occur routinely in a wide variety of applications, including oscillators and frequency filters. They are also very useful in modeling a number of practical situations, such as automobile suspension systems, temperature controllers, and even the response of an airplane to changes in elevator and aileron positions.

## 9.1 THE SOURCE-FREE PARALLEL CIRCUIT

There are two basic types of *RLC* circuits: *parallel connected*, and *series connected*. We could start with either, but somewhat arbitrarily choose to begin by considering parallel *RLC* circuits. This particular combination of ideal elements is a reasonable model for portions of many communication networks. It represents, for example, an important part of certain electronic amplifiers found in radios, and enables the amplifiers to produce a large voltage amplification over a narrow band of signal frequencies (with almost zero amplification outside this band).

Just as we did with *RL* and *RC* circuits, we first consider the natural response of a parallel *RLC* circuit, where one or both of the

## KEY CONCEPTS

Resonant Frequency and Damping Factor of Series and Parallel *RLC* Circuits

Overdamped Response

Critically Damped Response

Underdamped Response

Making Use of Two Initial Conditions

Complete (Natural + Forced) Response of *RLC* Circuits

Representing Differential Equations Using Op Amp Circuits



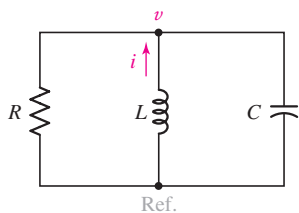

■ FIGURE 9.1 The source-free parallel *RLC* circuit.

energy storage elements have some nonzero initial energy (the origin of which for now is unimportant). This is represented by the inductor current and the capacitor voltage, both specified at  $t = 0^+$ . Once we're comfortable with this part of *RLC* circuit analysis, we can easily include dc sources, switches, or step sources in the circuit. Then we find the total response, which will be the sum of the natural response and the forced response.

Frequency selectivity of this kind enables us to listen to the transmission of one station while rejecting the transmission of any other station. Other applications include the use of parallel *RLC* circuits in frequency multiplexing and harmonic-suppression filters. However, even a simple discussion of these principles requires an understanding of such terms as *resonance*, *frequency response*, and *impedance*, which we have not yet discussed. Let it suffice to say, therefore, that an understanding of the natural behavior of the parallel *RLC* circuit is fundamentally important to future studies of communications networks and filter design, as well as many other applications.

When a *physical* capacitor is connected in parallel with an inductor and the capacitor has associated with it a finite resistance, the resulting network can be shown to have an equivalent circuit model like that shown in Fig. 9.1. The presence of this resistance can be used to model energy loss in the capacitor; over time, all real capacitors will eventually discharge, even if disconnected from a circuit. Energy losses in the physical inductor can also be taken into account by adding an ideal resistor (in series with the ideal inductor). For simplicity, however, we restrict our discussion to the case of an essentially ideal inductor in parallel with a “leaky” capacitor.

### Obtaining the Differential Equation for a Parallel *RLC* Circuit

In the following analysis we will assume that energy may be stored initially in both the inductor and the capacitor; in other words, nonzero initial values of both inductor current and capacitor voltage may be present. With reference to the circuit of Fig. 9.1, we may then write the single nodal equation

$$\frac{v}{R} + \frac{1}{L} \int_{t_0}^t v \, dt' - i(t_0) + C \frac{dv}{dt} = 0 \quad [1]$$

Note that the minus sign is a consequence of the assumed direction for  $i$ . We must solve Eq. [1] subject to the initial conditions

$$i(0^+) = I_0 \quad [2]$$

and

$$v(0^+) = V_0 \quad [3]$$

When both sides of Eq. [1] are differentiated once with respect to time, the result is the linear second-order homogeneous differential equation

$$C \frac{d^2v}{dt^2} + \frac{1}{R} \frac{dv}{dt} + \frac{1}{L}v = 0 \quad [4]$$

whose solution  $v(t)$  is the desired natural response.

### Solution of the Differential Equation

There are a number of interesting ways to solve Eq. [4]. Most of these methods we will leave to a course in differential equations, selecting only the quickest and simplest method to use now. We will assume a solution, relying upon our

intuition and modest experience to select one of the several possible forms that are suitable. Our experience with first-order equations might suggest that we at least try the exponential form once more. Thus, we *assume*

$$v = Ae^{st} \quad [5]$$

being as general as possible by allowing  $A$  and  $s$  to be complex numbers if necessary. Substituting Eq. [5] in Eq. [4], we obtain

$$CA s^2 e^{st} + \frac{1}{R} A s e^{st} + \frac{1}{L} A e^{st} = 0$$

or

$$A e^{st} \left( C s^2 + \frac{1}{R} s + \frac{1}{L} \right) = 0$$

In order for this equation to be satisfied for all time, at least one of the three factors must be zero. If either of the first two factors is set equal to zero, then  $v(t) = 0$ . This is a trivial solution of the differential equation which cannot satisfy our given initial conditions. We therefore equate the remaining factor to zero:

$$C s^2 + \frac{1}{R} s + \frac{1}{L} = 0 \quad [6]$$

This equation is usually called the *auxiliary equation* or the **characteristic equation**, as we discussed in Sec. 8.1. If it can be satisfied, then our assumed solution is correct. Since Eq. [6] is a quadratic equation, there are two solutions, identified as  $s_1$  and  $s_2$ :

$$s_1 = -\frac{1}{2RC} + \sqrt{\left(\frac{1}{2RC}\right)^2 - \frac{1}{LC}} \quad [7]$$

and

$$s_2 = -\frac{1}{2RC} - \sqrt{\left(\frac{1}{2RC}\right)^2 - \frac{1}{LC}} \quad [8]$$

If *either* of these two values is used for  $s$  in the assumed solution, then that solution satisfies the given differential equation; it thus becomes a valid solution of the differential equation.

Let us assume that we replace  $s$  by  $s_1$  in Eq. [5], obtaining

$$v_1 = A_1 e^{s_1 t}$$

and, similarly,

$$v_2 = A_2 e^{s_2 t}$$

The former satisfies the differential equation

$$C \frac{d^2 v_1}{dt^2} + \frac{1}{R} \frac{dv_1}{dt} + \frac{1}{L} v_1 = 0$$

and the latter satisfies

$$C \frac{d^2 v_2}{dt^2} + \frac{1}{R} \frac{dv_2}{dt} + \frac{1}{L} v_2 = 0$$

Adding these two differential equations and combining similar terms, we have

$$C \frac{d^2 (v_1 + v_2)}{dt^2} + \frac{1}{R} \frac{d(v_1 + v_2)}{dt} + \frac{1}{L} (v_1 + v_2) = 0$$

Linearity triumphs, and it is seen that the *sum* of the two solutions is also a solution. We thus have the general form of the natural response

$$v(t) = A_1 e^{s_1 t} + A_2 e^{s_2 t} \quad [9]$$

where  $s_1$  and  $s_2$  are given by Eqs. [7] and [8];  $A_1$  and  $A_2$  are two arbitrary constants which are to be selected to satisfy the two specified initial conditions.

## Definition of Frequency Terms

The form of the natural response as given in Eq. [9] offers little insight into the nature of the curve we might obtain if  $v(t)$  were plotted as a function of time. The relative amplitudes of  $A_1$  and  $A_2$ , for example, will certainly be important in determining the shape of the response curve. Furthermore, the constants  $s_1$  and  $s_2$  can be real numbers or conjugate complex numbers, depending upon the values of  $R$ ,  $L$ , and  $C$  in the given network. These two cases will produce fundamentally different response forms. Therefore, it will be helpful to make some simplifying substitutions in Eq. [9].

Since the exponents  $s_1 t$  and  $s_2 t$  must be dimensionless,  $s_1$  and  $s_2$  must have the unit of some dimensionless quantity “per second.” From Eqs. [7] and [8] we therefore see that the units of  $1/2RC$  and  $1/\sqrt{LC}$  must also be  $s^{-1}$  (i.e., seconds<sup>-1</sup>). Units of this type are called **frequencies**.

Let us define a new term,  $\omega_0$  (omega-sub-zero, or just omega-zero):

$$\omega_0 = \frac{1}{\sqrt{LC}} \quad [10]$$

and reserve the term **resonant frequency** for it. On the other hand, we will call  $1/2RC$  the **neper frequency**, or the **exponential damping coefficient**, and represent it by the symbol  $\alpha$  (alpha):

$$\alpha = \frac{1}{2RC} \quad [11]$$

This latter descriptive expression is used because  $\alpha$  is a measure of how rapidly the natural response decays or damps out to its steady, final value (usually zero). Finally,  $s$ ,  $s_1$ , and  $s_2$ , which are quantities that will form the basis for some of our later work, are called **complex frequencies**.

We should note that  $s_1$ ,  $s_2$ ,  $\alpha$ , and  $\omega_0$  are merely symbols used to simplify the discussion of *RLC* circuits; they are not mysterious new properties of any kind. It is easier, for example, to say “*alpha*” than it is to say “*the reciprocal of 2RC*.”

Let us collect these results. The natural response of the parallel *RLC* circuit is

$$v(t) = A_1 e^{s_1 t} + A_2 e^{s_2 t} \quad [9]$$

where

$$s_1 = -\alpha + \sqrt{\alpha^2 - \omega_0^2} \quad [12]$$

$$s_2 = -\alpha - \sqrt{\alpha^2 - \omega_0^2} \quad [13]$$

$$\alpha = \frac{1}{2RC} \quad [11]$$

$$\omega_0 = \frac{1}{\sqrt{LC}} \quad [10]$$

and  $A_1$  and  $A_2$  must be found by applying the given initial conditions.

We note two basic scenarios possible with Eqs. [12] and [13] depending on the relative sizes of  $\alpha$  and  $\omega_0$  (dictated by the values of  $R$ ,  $L$ , and  $C$ ). If  $\alpha > \omega_0$ ,  $s_1$  and  $s_2$  will both be real numbers, leading to what is referred to as an **overdamped response**. In the opposite case, where  $\alpha < \omega_0$ , both  $s_1$  and  $s_2$  will have nonzero imaginary components, leading to what is known as an **underdamped response**. Both of these situations are considered separately in the following sections, along with the special case of  $\alpha = \omega_0$ , which leads to what is called a **critically damped response**. We should also note that the general response comprised by Eqs. [9] through [13] describes not only the voltage but all three branch currents in the parallel  $RLC$  circuit; the constants  $A_1$  and  $A_2$  will be different for each, of course.

The ratio of  $\alpha$  to  $\omega_0$  is called the *damping ratio* by control system engineers and is designated by  $\zeta$  (zeta).

Overdamped:  $\alpha > \omega_0$   
 Critically damped:  $\alpha = \omega_0$   
 Underdamped:  $\alpha < \omega_0$



### EXAMPLE 9.1

Consider a parallel  $RLC$  circuit having an inductance of 10 mH and a capacitance of 100  $\mu\text{F}$ . Determine the resistor values that would lead to overdamped and underdamped responses.

We first calculate the resonant frequency of the circuit:

$$\omega_0 = \sqrt{\frac{1}{LC}} = \sqrt{\frac{1}{(10 \times 10^{-3})(100 \times 10^{-6})}} = 10^3 \text{ rad/s}$$

An *overdamped* response will result if  $\alpha > \omega_0$ ; an *underdamped* response will result if  $\alpha < \omega_0$ . Thus,

$$\frac{1}{2RC} > 10^3$$

and so

$$R < \frac{1}{(2000)(100 \times 10^{-6})}$$

or

$$R < 5 \Omega$$

leads to an overdamped response;  $R > 5 \Omega$  leads to an underdamped response.

### PRACTICE

9.1 A parallel  $RLC$  circuit contains a 100  $\Omega$  resistor and has the parameter values  $\alpha = 1000 \text{ s}^{-1}$  and  $\omega_0 = 800 \text{ rad/s}$ . Find (a)  $C$ ; (b)  $L$ ; (c)  $s_1$ ; (d)  $s_2$ .

Ans: 5  $\mu\text{F}$ ; 312.5 mH;  $-400 \text{ s}^{-1}$ ;  $-1600 \text{ s}^{-1}$ .

## 9.2 THE OVERDAMPED PARALLEL RLC CIRCUIT

A comparison of Eqs. [10] and [11] shows that  $\alpha$  will be greater than  $\omega_0$  if  $LC > 4R^2C^2$ . In this case the radical used in calculating  $s_1$  and  $s_2$  will be real, and both  $s_1$  and  $s_2$  will be real. Moreover, the following inequalities

$$\sqrt{\alpha^2 - \omega_0^2} < \alpha$$

$$\left(-\alpha - \sqrt{\alpha^2 - \omega_0^2}\right) < \left(-\alpha + \sqrt{\alpha^2 - \omega_0^2}\right) < 0$$

may be applied to Eqs. [12] and [13] to show that both  $s_1$  and  $s_2$  are *negative* real numbers. Thus, the response  $v(t)$  can be expressed as the (algebraic) sum of two decreasing exponential terms, both of which approach zero as time increases. In fact, since the absolute value of  $s_2$  is larger than that of  $s_1$ , the term containing  $s_2$  has the more rapid rate of decrease, and, for large values of time, we may write the limiting expression

$$v(t) \rightarrow A_1 e^{s_1 t} \rightarrow 0 \quad \text{as } t \rightarrow \infty$$

The next step is to determine the arbitrary constants  $A_1$  and  $A_2$  in conformance with the initial conditions. We select a parallel RLC circuit with  $R = 6 \Omega$ ,  $L = 7 \text{ H}$ , and, for ease of computation,  $C = \frac{1}{42} \text{ F}$ . The initial energy storage is specified by choosing an initial voltage across the circuit  $v(0) = 0$  and an initial inductor current  $i(0) = 10 \text{ A}$ , where  $v$  and  $i$  are defined in Fig. 9.2.

We may easily determine the values of the several parameters

$$\alpha = 3.5 \quad \omega_0 = \sqrt{6} \quad (\text{all } s^{-1})$$

$$s_1 = -1 \quad s_2 = -6$$

and immediately write the general form of the natural response

$$v(t) = A_1 e^{-t} + A_2 e^{-6t} \quad [14]$$

### Finding Values for $A_1$ and $A_2$

Only the evaluation of the two constants  $A_1$  and  $A_2$  remains. If we knew the response  $v(t)$  at two different values of time, these two values could be substituted in Eq. [14] and  $A_1$  and  $A_2$  easily found. However, we know only one instantaneous value of  $v(t)$ ,

$$v(0) = 0$$

and, therefore,

$$0 = A_1 + A_2 \quad [15]$$

We can obtain a second equation relating  $A_1$  and  $A_2$  by taking the derivative of  $v(t)$  with respect to time in Eq. [14], determining the initial value of this derivative through the use of the remaining initial condition  $i(0) = 10$ , and equating the results. So, taking the derivative of both sides of Eq. [14],

$$\frac{dv}{dt} = -A_1 e^{-t} - 6A_2 e^{-6t}$$

and evaluating the derivative at  $t = 0$ ,

$$\left. \frac{dv}{dt} \right|_{t=0} = -A_1 - 6A_2$$

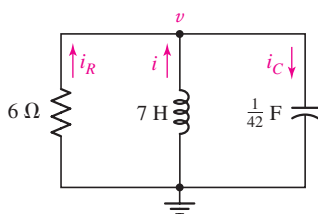

■ FIGURE 9.2 A parallel RLC circuit used as a numerical example. The circuit is overdamped.





we obtain a second equation. Although this may appear to be helpful, we do not have a numerical value for the initial value of the derivative, so we do not yet have two equations in two unknowns . . . Or do we? The expression  $dv/dt$  suggests a capacitor current, since

$$i_C = C \frac{dv}{dt}$$

Kirchhoff's current law must hold at any instant in time, as it is based on conservation of electrons. Thus, we may write

$$-i_C(0) + i(0) + i_R(0) = 0$$

Substituting our expression for capacitor current and dividing by  $C$ ,

$$\left. \frac{dv}{dt} \right|_{t=0} = \frac{i_C(0)}{C} = \frac{i(0) + i_R(0)}{C} = \frac{i(0)}{C} = 420 \text{ V/s}$$

since zero initial voltage across the resistor requires zero initial current through it. We thus have our second equation,

$$420 = -A_1 - 6A_2 \quad [16]$$

and simultaneous solution of Eqs. [15] and [16] provides the two amplitudes  $A_1 = 84$  and  $A_2 = -84$ . Therefore, the final numerical solution for the natural response of this circuit is

$$v(t) = 84(e^{-t} - e^{-6t}) \quad \text{V} \quad [17]$$

For the remainder of our discussions concerning  $RLC$  circuits, we will always require two initial conditions in order to completely specify the response. One condition will usually be very easy to apply—either a voltage or current at  $t = 0$ . It is the second condition that usually requires a little effort. Although we will often have both an initial current and an initial voltage at our disposal, one of these will need to be applied indirectly through the derivative of our assumed solution.

## EXAMPLE 9.2

Find an expression for  $v_C(t)$  valid for  $t > 0$  in the circuit of Fig. 9.3a.

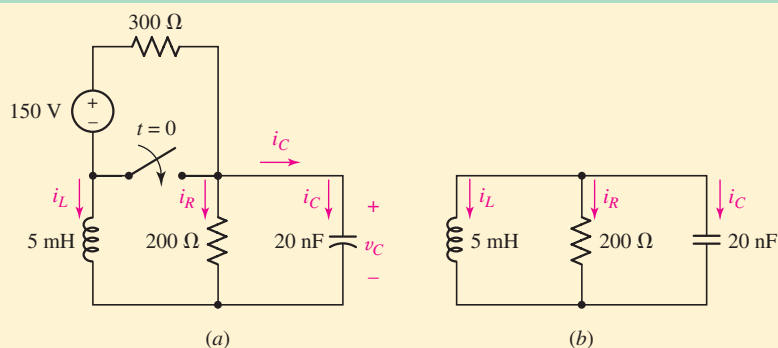

■ FIGURE 9.3 (a) An  $RLC$  circuit that becomes source-free at  $t = 0$ . (b) The circuit for  $t > 0$ , in which the 150 V source and the 300  $\Omega$  resistor have been shorted out by the switch, and so are of no further relevance to  $v_C$ .

### ► Identify the goal of the problem.

We are asked to find the capacitor voltage after the switch is thrown. This action leads to no sources remaining connected to either the inductor or the capacitor.

(Continued on next page)

► **Collect the known information.**

After the switch is thrown, the capacitor is left in parallel with a  $200\ \Omega$  resistor and a  $5\ \text{mH}$  inductor (Fig. 9.3b). Thus,  $\alpha = 1/2RC = 125,000\ \text{s}^{-1}$ ,  $\omega_0 = 1/\sqrt{LC} = 100,000\ \text{rad/s}$ ,  $s_1 = -\alpha + \sqrt{\alpha^2 - \omega_0^2} = -50,000\ \text{s}^{-1}$  and  $s_2 = -\alpha - \sqrt{\alpha^2 - \omega_0^2} = -200,000\ \text{s}^{-1}$ .

► **Devise a plan.**

Since  $\alpha > \omega_0$ , the circuit is overdamped and so we expect a capacitor voltage of the form

$$v_C(t) = A_1 e^{s_1 t} + A_2 e^{s_2 t}$$

We know  $s_1$  and  $s_2$ ; we need to obtain and invoke two initial conditions to determine  $A_1$  and  $A_2$ . To do this, we will analyze the circuit at  $t = 0^-$  (Fig. 9.4a) to find  $i_L(0^-)$  and  $v_C(0^-)$ . We will then analyze the circuit at  $t = 0^+$  with the assumption that neither value changes.

► **Construct an appropriate set of equations.**

From Fig. 9.4a, in which the inductor has been replaced with a short circuit and the capacitor with an open circuit, we see that

$$i_L(0^-) = -\frac{150}{200 + 300} = -300\ \text{mA}$$

and

$$v_C(0^-) = 150 \frac{200}{200 + 300} = 60\ \text{V}$$

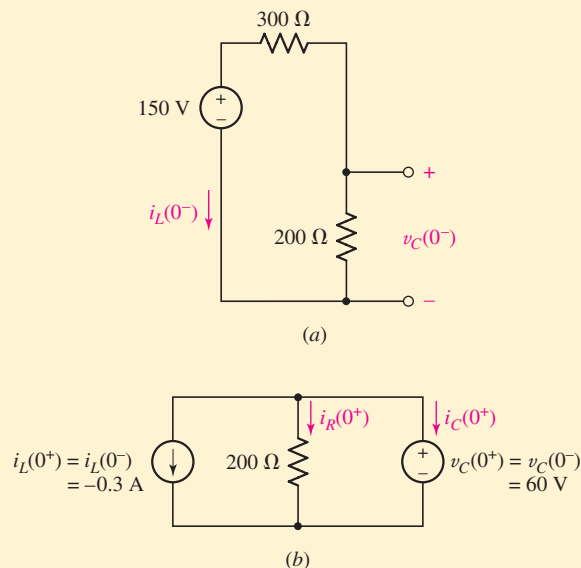

■ FIGURE 9.4 (a) The equivalent circuit at  $t = 0^-$ ; (b) equivalent circuit at  $t = 0^+$ , drawn using ideal sources to represent the initial inductor current and initial capacitor voltage.

In Fig. 9.4b, we draw the circuit at  $t = 0^+$ , representing the inductor current and capacitor voltage by ideal sources for simplicity. Since neither can change in zero time, we know that  $v_C(0^+) = 60$  V.

► **Determine if additional information is required.**

We have an equation for the capacitor voltage:  $v_C(t) = A_1 e^{-50,000t} + A_2 e^{-200,000t}$ . We now know  $v_C(0) = 60$  V, but a third equation is still required. Differentiating our capacitor voltage equation, we find

$$\frac{dv_C}{dt} = -50,000A_1 e^{-50,000t} - 200,000A_2 e^{-200,000t}$$

which can be related to the capacitor current as  $i_C = C(dv_C/dt)$ . Returning to Fig. 9.4b, KCL yields

$$i_C(0^+) = -i_L(0^+) - i_R(0^+) = 0.3 - [v_C(0^+)/200] = 0$$

► **Attempt a solution.**

Application of our first initial condition yields

$$v_C(0) = A_1 + A_2 = 60$$

and application of our second initial condition yields

$$i_C(0) = -20 \times 10^{-9}(50,000A_1 + 200,000A_2) = 0$$

Solving,  $A_1 = 80$  V and  $A_2 = -20$  V, so that

$$v_C(t) = 80e^{-50,000t} - 20e^{-200,000t} \text{ V, } t > 0$$

► **Verify the solution. Is it reasonable or expected?**

At the very least, we can check our solution at  $t = 0$ , verifying that  $v_C(0) = 60$  V. Differentiating and multiplying by  $20 \times 10^{-9}$ , we can also verify that  $i_C(0) = 0$ . Also, since we have a source-free circuit for  $t > 0$ , we expect that  $v_C(t)$  must eventually decay to zero as  $t$  approaches  $\infty$ , which our solution does.

## PRACTICE

9.2 After being open for a long time, the switch in Fig. 9.5 closes at  $t = 0$ . Find (a)  $i_L(0^-)$ ; (b)  $v_C(0^-)$ ; (c)  $i_R(0^+)$ ; (d)  $i_C(0^+)$ ; (e)  $v_C(0.2)$ .

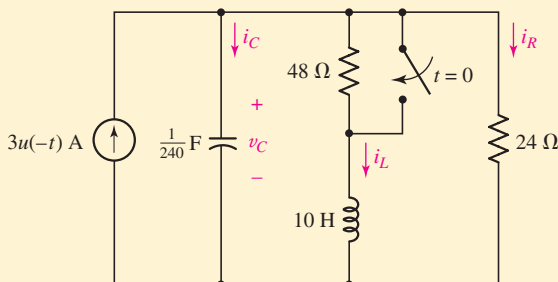

■ FIGURE 9.5

Ans: 1 A; 48 V; 2 A; -3 A; -17.54 V.

As noted previously, the form of the overdamped response applies to any voltage or current quantity, as we explore in the following example.

### EXAMPLE 9.3

The circuit of Fig. 9.6a reduces to a simple parallel RLC circuit after  $t = 0$ . Determine an expression for the resistor current  $i_R$  valid for all time.

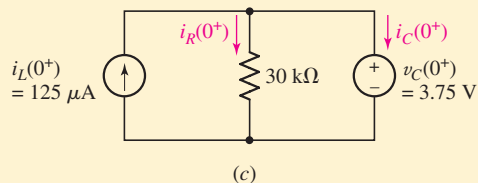
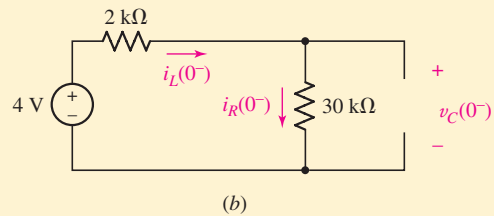
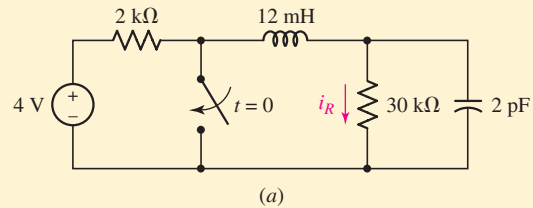

■ FIGURE 9.6 (a) Circuit for which  $i_R$  is required. (b) Equivalent circuit for  $t = 0^-$ . (c) Equivalent circuit for  $t = 0^+$ .

For  $t > 0$ , we have a parallel RLC circuit with  $R = 30 \text{ k}\Omega$ ,  $L = 12 \text{ mH}$ , and  $C = 2 \text{ pF}$ . Thus,  $\alpha = 8.333 \times 10^6 \text{ s}^{-1}$  and  $\omega_0 = 6.455 \times 10^6 \text{ rad/s}$ . We therefore expect an overdamped response, with  $s_1 = -3.063 \times 10^6 \text{ s}^{-1}$  and  $s_2 = -13.60 \times 10^6 \text{ s}^{-1}$ , so that

$$i_R(t) = A_1 e^{s_1 t} + A_2 e^{s_2 t}, \quad t > 0 \quad [18]$$

To determine numerical values for  $A_1$  and  $A_2$ , we first analyze the circuit at  $t = 0^-$ , as drawn in Fig. 9.6b. We see that  $i_L(0^-) = i_R(0^-) = 4/32 \times 10^3 = 125 \mu\text{A}$ , and  $v_C(0^-) = 4 \times 30/32 = 3.75 \text{ V}$ .

In drawing the circuit at  $t = 0^+$  (Fig. 9.6c), we only know that  $i_L(0^+) = 125 \mu\text{A}$  and  $v_C(0^+) = 3.75 \text{ V}$ . However, by Ohm's law we can calculate that  $i_R(0^+) = 3.75/30 \times 10^3 = 125 \mu\text{A}$ , our first initial condition. Thus,

$$i_R(0) = A_1 + A_2 = 125 \times 10^{-6} \quad [19]$$

How do we obtain a *second* initial condition? If we multiply Eq. [18] by  $30 \times 10^3$ , we obtain an expression for  $v_C(t)$ . Taking the derivative and multiplying by 2 pF yield an expression for  $i_C(t)$ :

$$i_C = C \frac{dv_C}{dt} = (2 \times 10^{-12})(30 \times 10^3)(A_1 s_1 e^{s_1 t} + A_2 s_2 e^{s_2 t})$$

By KCL,

$$i_C(0^+) = i_L(0^+) - i_R(0^+) = 0$$

Thus,

$$-(2 \times 10^{-12})(30 \times 10^3)(3.063 \times 10^6 A_1 + 13.60 \times 10^6 A_2) = 0 \quad [20]$$

Solving Eqs. [19] and [20], we find that  $A_1 = 161.3 \mu\text{A}$  and  $A_2 = -36.34 \mu\text{A}$ . Thus,

$$i_R = \begin{cases} 125 \mu\text{A} & t < 0 \\ 161.3e^{-3.063 \times 10^6 t} - 36.34e^{-13.6 \times 10^6 t} \mu\text{A} & t > 0 \end{cases}$$

### PRACTICE

9.3 Determine the current  $i_R$  through the resistor of Fig. 9.7 for  $t > 0$  if  $i_L(0^-) = 6 \text{ A}$  and  $v_C(0^+) = 0 \text{ V}$ . The configuration of the circuit prior to  $t = 0$  is not known.

Ans:  $i_R(t) = 2.437(e^{-7.823 \times 10^{10} t} - e^{-0.511 \times 10^{10} t}) \text{ A}$ .

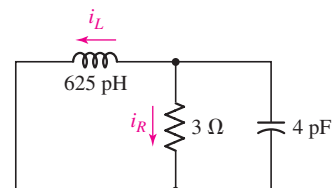

FIGURE 9.7 Circuit for Practice Problem 9.3.

## Graphical Representation of the Overdamped Response

Now let us return to Eq. [17] and see what additional information we can determine about this circuit. We may interpret the first exponential term as having a time constant of 1 s and the other exponential, a time constant of  $\frac{1}{6}$  s. Each starts with unity amplitude, but the latter decays more rapidly;  $v(t)$  is never negative. As time becomes infinite, each term approaches zero, and the response itself dies out as it should. We therefore have a response curve which is zero at  $t = 0$ , is zero at  $t = \infty$ , and is never negative; since it is not everywhere zero, it must possess at least one maximum, and this is not a difficult point to determine exactly. We differentiate the response

$$\frac{dv}{dt} = 84(-e^{-t} + 6e^{-6t})$$

set the derivative equal to zero to determine the time  $t_m$  at which the voltage becomes maximum,

$$0 = -e^{-t_m} + 6e^{-6t_m}$$

manipulate once,

$$e^{5t_m} = 6$$

and obtain

$$t_m = 0.358 \text{ s}$$

and

$$v(t_m) = 48.9 \text{ V}$$

A reasonable sketch of the response may be made by plotting the two exponential terms  $84e^{-t}$  and  $84e^{-6t}$  and then taking their difference. This technique is illustrated by the curves of Fig. 9.8; the two exponentials are shown lightly, and their difference, the total response  $v(t)$ , is drawn as a colored line. The curves also verify our previous prediction that the functional behavior of  $v(t)$  for very large  $t$  is  $84e^{-t}$ , the exponential term containing the smaller magnitude of  $s_1$  and  $s_2$ .

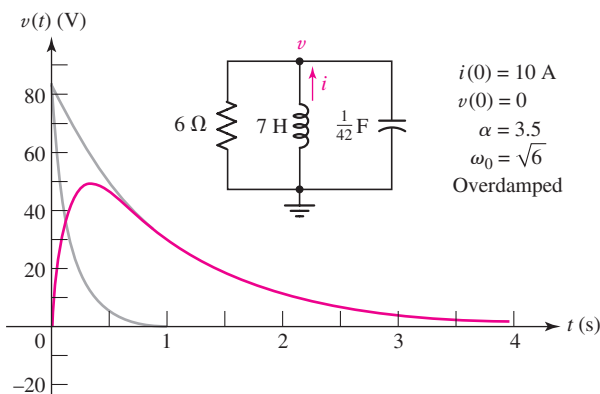

■ FIGURE 9.8 The response  $v(t) = 84(e^{-t} - e^{-6t})$  of the network shown in Fig. 9.2.

A frequently asked question is the length of time it actually takes for the transient part of the response to disappear (or “*damp out*”). In practice, it is often desirable to have this transient response approach zero as rapidly as possible, that is, to minimize the **settling time**  $t_s$ . Theoretically, of course,  $t_s$  is infinite, because  $v(t)$  never settles to zero in a finite time. However, a negligible response is present after the magnitude of  $v(t)$  has settled to values that remain less than 1 percent of its maximum absolute value  $|v_m|$ . The time that is required for this to occur we define as the settling time. Since  $|v_m| = v_m = 48.9 \text{ V}$  for our example, the settling time is the time required for the response to drop to 0.489 V. Substituting this value for  $v(t)$  in Eq. [17] and neglecting the second exponential term, known to be negligible here, the settling time is found to be 5.15 s.



### EXAMPLE 9.4

**For  $t > 0$ , the capacitor current of a certain source-free parallel RLC circuit is given by  $i_C(t) = 2e^{-2t} - 4e^{-t}$  A. Sketch the current in the range  $0 < t < 5$  s, and determine the settling time.**

We first sketch the two terms as shown in Fig. 9.9, then subtract them to find  $i_C(t)$ . The maximum value is clearly  $|-2| = 2$  A. We therefore need to find the time at which  $|i_C|$  has decreased to 20 mA, or

$$2e^{-2t_s} - 4e^{-t_s} = -0.02 \quad [21]$$

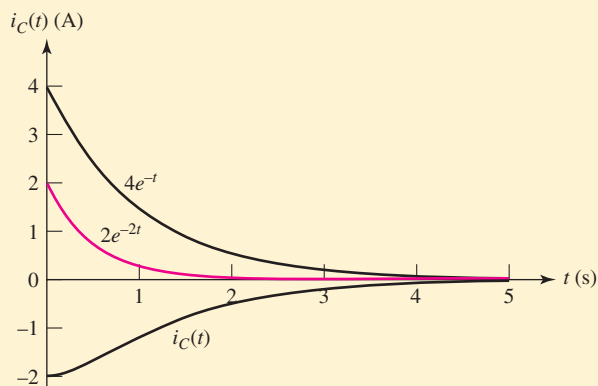

■ FIGURE 9.9 The current response  $i_C(t) = 2e^{-2t} - 4e^{-t}$  A, sketched alongside its two components.

This equation can be solved using an iterative solver routine on a scientific calculator, which returns the solution  $t_s = 5.296$  s. If such an option is not available, however, we can approximate Eq. [21] for  $t \geq t_s$  as

$$-4e^{-t_s} = -0.02 \quad [22]$$

Solving,

$$t_s = -\ln\left(\frac{0.02}{4}\right) = 5.298 \text{ s} \quad [23]$$

which is reasonably close (better than 0.1% accuracy) to the exact solution.

## PRACTICE

9.4 (a) Sketch the voltage  $v_R(t) = 2e^{-t} - 4e^{-3t}$  V in the range  $0 < t < 5$  s. (b) Estimate the settling time. (c) Calculate the maximum positive value and the time at which it occurs.

Ans: See Fig. 9.10; 5.9 s; 544 mV, 896 ms.

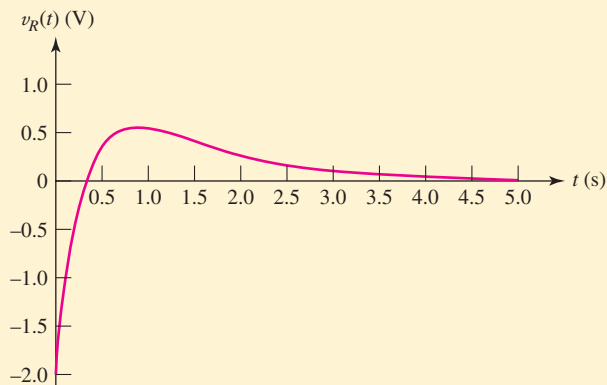

■ FIGURE 9.10 Response sketched for Practice Problem 9.4a.

### 9.3 CRITICAL DAMPING

The overdamped case is characterized by

$$\alpha > \omega_0$$

or

$$LC > 4R^2C^2$$

and leads to negative real values for  $s_1$  and  $s_2$  and to a response expressed as the algebraic sum of two negative exponentials.

Now let us adjust the element values until  $\alpha$  and  $\omega_0$  are equal. This is a very special case which is termed **critical damping**. If we were to attempt to construct a parallel RLC circuit that is critically damped, we would be attempting an essentially impossible task, for we could never make  $\alpha$  exactly equal to  $\omega_0$ . For completeness, however, we will discuss the critically damped circuit here, because it shows an interesting transition between overdamping and underdamping.

Critical damping is achieved when

$$\text{or } \left. \begin{array}{l} \alpha = \omega_0 \\ LC = 4R^2C^2 \\ L = 4R^2C \end{array} \right\} \text{critical damping}$$

We can produce critical damping by changing the value of any of the three elements in the numerical example discussed at the end of Sec. 9.1. We will select  $R$ , increasing its value until critical damping is obtained, and thus leave  $\omega_0$  unchanged. The necessary value of  $R$  is  $7\sqrt{6}/2 \Omega$ ;  $L$  is still 7 H, and  $C$  remains  $\frac{1}{42}$  F. We thus find

$$\alpha = \omega_0 = \sqrt{6} \text{ s}^{-1}$$

$$s_1 = s_2 = -\sqrt{6} \text{ s}^{-1}$$

and recall the initial conditions that were specified,  $v(0) = 0$  and  $i(0) = 10$  A.

#### Form of a Critically Damped Response

We proceed to attempt to construct a response as the sum of two exponentials,

$$v(t) \stackrel{?}{=} A_1 e^{-\sqrt{6}t} + A_2 e^{-\sqrt{6}t}$$

which may be written as

$$v(t) \stackrel{?}{=} A_3 e^{-\sqrt{6}t}$$

At this point, some of us might be feeling that something's wrong. We have a response that contains only one arbitrary constant, but there are two initial conditions,  $v(0) = 0$  and  $i(0) = 10$  amperes, *both of which* must be satisfied by this single constant. If we select  $A_3 = 0$ , then  $v(t) = 0$ , which is consistent with our initial capacitor voltage. However, although there is no energy stored in the capacitor at  $t = 0^+$ , we have 350 J of energy initially stored in the inductor. This energy will lead to a transient current flowing out of the inductor, giving rise to a nonzero voltage across all three elements. This seems to be in direct conflict with our proposed solution.

"Impossible" is a pretty strong term. We make this statement because in practice it is unusual to obtain components that are closer than 1 percent of their specified values. Thus, obtaining  $L$  *precisely* equal to  $4R^2C$  is theoretically possible, but not very likely, even if we're willing to measure a drawer full of components until we find the right ones.



If a mistake has not led to our difficulties, we must have begun with an incorrect assumption, and only one assumption has been made. We originally hypothesized that the differential equation could be solved by assuming an exponential solution, and this turns out to be incorrect for this single special case of critical damping. When  $\alpha = \omega_0$ , the differential equation, Eq. [4], becomes

$$\frac{d^2v}{dt^2} + 2\alpha \frac{dv}{dt} + \alpha^2 v = 0$$

The solution of this equation is not a tremendously difficult process, but we will avoid developing it here, since the equation is a standard type found in the usual differential-equation texts. The solution is

$$v = e^{-\alpha t} (A_1 t + A_2) \quad [24]$$

It should be noted that the solution is still expressed as the sum of two terms, where one term is the familiar negative exponential and the second is  $t$  times a negative exponential. We should also note that the solution contains the *two* expected arbitrary constants.

### Finding Values for $A_1$ and $A_2$

Let us now complete our numerical example. After we substitute the known value of  $\alpha$  in Eq. [24], obtaining

$$v = A_1 t e^{-\sqrt{6}t} + A_2 e^{-\sqrt{6}t}$$

we establish the values of  $A_1$  and  $A_2$  by first imposing the initial condition on  $v(t)$  itself,  $v(0) = 0$ . Thus,  $A_2 = 0$ . This simple result occurs because the initial value of the response  $v(t)$  was selected as zero; the more general case will require the solution of two equations simultaneously. The second initial condition must be applied to the derivative  $dv/dt$  just as in the overdamped case. We therefore differentiate, remembering that  $A_2 = 0$ :

$$\frac{dv}{dt} = A_1 t (-\sqrt{6}) e^{-\sqrt{6}t} + A_1 e^{-\sqrt{6}t}$$

evaluate at  $t = 0$ :

$$\left. \frac{dv}{dt} \right|_{t=0} = A_1$$

and express the derivative in terms of the initial capacitor current:

$$\left. \frac{dv}{dt} \right|_{t=0} = \frac{i_C(0)}{C} = \frac{i_R(0)}{C} + \frac{i(0)}{C}$$

where reference directions for  $i_C$ ,  $i_R$ , and  $i$  are defined in Fig. 9.2. Thus,

$$A_1 = 420 \text{ V}$$

The response is, therefore,

$$v(t) = 420t e^{-2.45t} \quad \text{V} \quad [25]$$



## Graphical Representation of the Critically Damped Response

Before plotting this response in detail, let us again try to anticipate its form by qualitative reasoning. The specified initial value is zero, and Eq. [25] concurs. It is not immediately apparent that the response also approaches zero as  $t$  becomes infinitely large, because  $te^{-2.45t}$  is an indeterminate form. However, this obstacle is easily overcome by use of L'Hôpital's rule, which yields

$$\lim_{t \rightarrow \infty} v(t) = 420 \lim_{t \rightarrow \infty} \frac{t}{e^{2.45t}} = 420 \lim_{t \rightarrow \infty} \frac{1}{2.45e^{2.45t}} = 0$$

and once again we have a response that begins and ends at zero and has positive values at all other times. A maximum value  $v_m$  again occurs at time  $t_m$ ; for our example,

$$t_m = 0.408 \text{ s} \quad \text{and} \quad v_m = 63.1 \text{ V}$$

This maximum is larger than that obtained in the overdamped case, and is a result of the smaller losses that occur in the larger resistor; the time of the maximum response is slightly later than it was with overdamping. The settling time may also be determined by solving

$$\frac{v_m}{100} = 420t_s e^{-2.45t_s}$$

for  $t_s$  (by trial-and-error methods or a calculator's SOLVE routine):

$$t_s = 3.12 \text{ s}$$



which is a considerably smaller value than that which arose in the overdamped case (5.15 s). As a matter of fact, it can be shown that, for given values of  $L$  and  $C$ , the selection of that value of  $R$  which provides critical damping will always give a shorter settling time than any choice of  $R$  that produces an overdamped response. However, a slight improvement (reduction) in settling time may be obtained by a further slight increase in resistance; a slightly underdamped response that will undershoot the zero axis before it dies out will yield the shortest settling time.

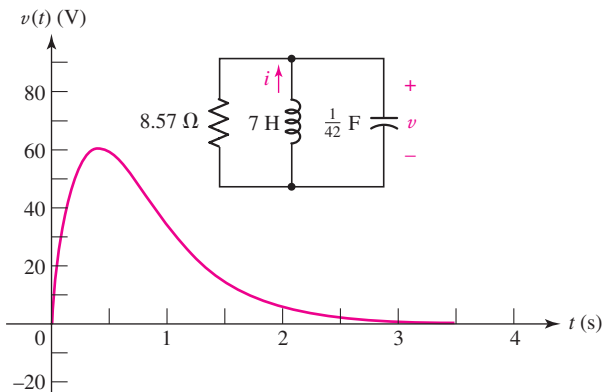

■ FIGURE 9.11 The response  $v(t) = 420te^{-2.45t}$  of the network shown in Fig. 9.2 with  $R$  changed to provide critical damping.

The response curve for critical damping is drawn in Fig. 9.11; it may be compared with the overdamped (and underdamped) case by reference to Fig. 9.16.

## EXAMPLE 9.5

Select a value for  $R_1$  such that the circuit of Fig. 9.12 will be characterized by a critically damped response for  $t > 0$ , and a value for  $R_2$  such that  $v(0) = 2$  V.

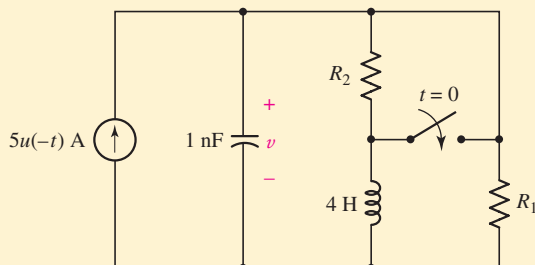

■ FIGURE 9.12 A circuit that reduces to a parallel  $RLC$  circuit after the switch is thrown.

We note that at  $t = 0^-$ , the current source is on, and the inductor can be treated as a short circuit. Thus,  $v(0^-)$  appears across  $R_2$ , and is given by

$$v(0^-) = 5R_2$$

and a value of  $400 \text{ m}\Omega$  should be selected for  $R_2$  to obtain  $v(0) = 2$  V.

After the switch is thrown, the current source has turned itself off and  $R_2$  is shorted. We are left with a parallel  $RLC$  circuit comprised of  $R_1$ , a  $4 \text{ H}$  inductor, and a  $1 \text{ nF}$  capacitor.

We may now calculate (for  $t > 0$ )

$$\begin{aligned} \alpha &= \frac{1}{2RC} \\ &= \frac{1}{2 \times 10^{-9} R_1} \end{aligned}$$

and

$$\begin{aligned} \omega_0 &= \frac{1}{\sqrt{LC}} \\ &= \frac{1}{\sqrt{4 \times 10^{-9}}} \\ &= 15,810 \text{ rad/s} \end{aligned}$$

Therefore, to establish a critically damped response in the circuit for  $t > 0$ , we need to set  $R_1 = 31.63 \text{ k}\Omega$ . (Note: since we have rounded to four significant figures, the pedantic can rightly argue that this is still not **exactly** a critically damped response—a difficult situation to create.)

## PRACTICE

9.5 (a) Choose  $R_1$  in the circuit of Fig. 9.13 so that the response after  $t = 0$  will be critically damped. (b) Now select  $R_2$  to obtain  $v(0) = 100$  V. (c) Find  $v(t)$  at  $t = 1$  ms.

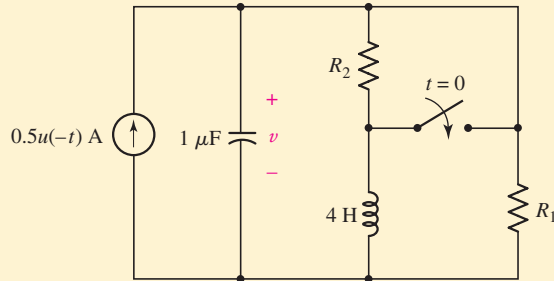

FIGURE 9.13

Ans: 1 k $\Omega$ ; 250  $\Omega$ ; -212 V.

## 9.4 THE UNDERDAMPED PARALLEL RLC CIRCUIT

Let us continue the process begun in Sec. 9.3 by increasing  $R$  once more to obtain what we will refer to as an *underdamped* response. Thus, the damping coefficient  $\alpha$  decreases while  $\omega_0$  remains constant,  $\alpha^2$  becomes smaller than  $\omega_0^2$ , and the radicand appearing in the expressions for  $s_1$  and  $s_2$  becomes negative. This causes the response to take on a much different character, but it is fortunately not necessary to return to the basic differential equation again. By using complex numbers, the exponential response turns into a *damped sinusoidal response*; this response is composed entirely of real quantities, the complex quantities being necessary only for the derivation.<sup>1</sup>

### The Form of the Underdamped Response

We begin with the exponential form

$$v(t) = A_1 e^{s_1 t} + A_2 e^{s_2 t}$$

where

$$s_{1,2} = -\alpha \pm \sqrt{\alpha^2 - \omega_0^2}$$

and then let

$$\sqrt{\alpha^2 - \omega_0^2} = \sqrt{-1} \sqrt{\omega_0^2 - \alpha^2} = j \sqrt{\omega_0^2 - \alpha^2}$$

where  $j \equiv \sqrt{-1}$ .

We now take the new radical, which is real for the underdamped case, and call it  $\omega_d$ , the *natural resonant frequency*:

$$\omega_d = \sqrt{\omega_0^2 - \alpha^2}$$

The response may now be written as

$$v(t) = e^{-\alpha t} (A_1 e^{j\omega_d t} + A_2 e^{-j\omega_d t}) \quad [26]$$

Electrical engineers use “ $j$ ” instead of “ $i$ ” to represent  $\sqrt{-1}$  to avoid confusion with currents.

(1) A review of complex numbers is presented in Appendix 5.

or, in the longer but equivalent form,

$$v(t) = e^{-\alpha t} \left\{ (A_1 + A_2) \left[ \frac{e^{j\omega_d t} + e^{-j\omega_d t}}{2} \right] + j(A_1 - A_2) \left[ \frac{e^{j\omega_d t} - e^{-j\omega_d t}}{j2} \right] \right\}$$

Applying identities described in Appendix 5, the term in the first square brackets in the preceding equation is identically equal to  $\cos \omega_d t$ , and the second is identically  $\sin \omega_d t$ . Hence,

$$v(t) = e^{-\alpha t} [(A_1 + A_2) \cos \omega_d t + j(A_1 - A_2) \sin \omega_d t]$$

and the multiplying factors may be assigned new symbols:

$$v(t) = e^{-\alpha t} (B_1 \cos \omega_d t + B_2 \sin \omega_d t) \quad [27]$$

where Eqs. [26] and [27] are identical.

It may seem a little odd that our expression originally appeared to have a complex component, and now is purely real. However, we should remember that we originally allowed for  $A_1$  and  $A_2$  to be complex as well as  $s_1$  and  $s_2$ . In any event, if we are dealing with the underdamped case, we have now left complex numbers behind. This must be true since  $\alpha$ ,  $\omega_d$ , and  $t$  are real quantities, so that  $v(t)$  itself must be a real quantity (which might be presented on an oscilloscope, a voltmeter, or a sheet of graph paper). Equation [27] is the desired functional form for the underdamped response, and its validity may be checked by direct substitution in the original differential equation; this exercise is left to the doubters. The two real constants  $B_1$  and  $B_2$  are again selected to fit the given initial conditions.



We return to our simple parallel  $RLC$  circuit of Fig. 9.2 with  $R = 6 \Omega$ ,  $C = 1/42 \text{ F}$ , and  $L = 7 \text{ H}$ , but now increase the resistance further to  $10.5 \Omega$ . Thus,

$$\alpha = \frac{1}{2RC} = 2 \text{ s}^{-1}$$

$$\omega_0 = \frac{1}{\sqrt{LC}} = \sqrt{6} \text{ s}^{-1}$$

and

$$\omega_d = \sqrt{\omega_0^2 - \alpha^2} = \sqrt{2} \text{ rad/s}$$

Except for the evaluation of the arbitrary constants, the response is now known:

$$v(t) = e^{-2t} (B_1 \cos \sqrt{2}t + B_2 \sin \sqrt{2}t)$$

### Finding Values for $B_1$ and $B_2$

The determination of the two constants proceeds as before. If we still assume that  $v(0) = 0$  and  $i(0) = 10$ , then  $B_1$  must be zero. Hence

$$v(t) = B_2 e^{-2t} \sin \sqrt{2}t$$

The derivative is

$$\frac{dv}{dt} = \sqrt{2} B_2 e^{-2t} \cos \sqrt{2}t - 2 B_2 e^{-2t} \sin \sqrt{2}t$$

and at  $t = 0$  it becomes

$$\left. \frac{dv}{dt} \right|_{t=0} = \sqrt{2}B_2 = \frac{i_C(0)}{C} = 420$$

where  $i_C$  is defined in Fig. 9.2. Therefore,

$$v(t) = 210\sqrt{2}e^{-2t} \sin \sqrt{2}t$$

## Graphical Representation of the Underdamped Response

Notice that, as before, this response function has an initial value of zero because of the initial voltage condition we imposed, and a final value of zero because the exponential term vanishes for large values of  $t$ . As  $t$  increases from zero through small positive values,  $v(t)$  increases as  $210\sqrt{2} \sin \sqrt{2}t$ , because the exponential term remains essentially equal to unity. But, at some time  $t_m$ , the exponential function begins to decrease more rapidly than  $\sin \sqrt{2}t$  is increasing; thus  $v(t)$  reaches a maximum  $v_m$  and begins to decrease. We should note that  $t_m$  is not the value of  $t$  for which  $\sin \sqrt{2}t$  is a maximum, but must occur somewhat before  $\sin \sqrt{2}t$  reaches its maximum.



When  $t = \pi/\sqrt{2}$ ,  $v(t)$  is zero. Thus, in the interval  $\pi/\sqrt{2} < t < \sqrt{2}\pi$ , the response is negative, becoming zero again at  $t = \sqrt{2}\pi$ . Hence,  $v(t)$  is an oscillatory function of time and crosses the time axis an infinite number of times at  $t = n\pi/\sqrt{2}$ , where  $n$  is any positive integer. In our example, however, the response is only slightly underdamped, and the exponential term causes the function to die out so rapidly that most of the zero crossings will not be evident in a sketch.

The oscillatory nature of the response becomes more noticeable as  $\alpha$  decreases. If  $\alpha$  is zero, which corresponds to an infinitely large resistance, then  $v(t)$  is an undamped sinusoid that oscillates with constant amplitude. There is never a time at which  $v(t)$  drops and stays below 1 percent of its maximum value; the settling time is therefore infinite. This is not perpetual motion; we have merely assumed an initial energy in the circuit and have not provided any means to dissipate this energy. It is transferred from its initial location in the inductor to the capacitor, then returns to the inductor, and so on, forever.

## The Role of Finite Resistance

A finite  $R$  in the parallel RLC circuit acts as a kind of electrical transfer agent. Every time energy is transferred from  $L$  to  $C$  or from  $C$  to  $L$ , the agent exacts a commission. Before long, the agent has taken all the energy, wantonly dissipating every last joule. The  $L$  and  $C$  are left without a joule of their own, without voltage and without current. Actual parallel RLC circuits can be made to have effective values of  $R$  so large that a natural undamped sinusoidal response can be maintained for years without supplying any additional energy.

Returning to our specific numerical problem, differentiation locates the first maximum of  $v(t)$ ,

$$v_{m_1} = 71.8 \text{ V} \quad \text{at} \quad t_{m_1} = 0.435 \text{ s}$$

the succeeding minimum,

$$v_{m_2} = -0.845 \text{ V} \quad \text{at} \quad t_{m_2} = 2.66 \text{ s}$$

and so on. The response curve is shown in Fig. 9.14. Additional response curves for increasingly more underdamped circuits are shown in Fig. 9.15.

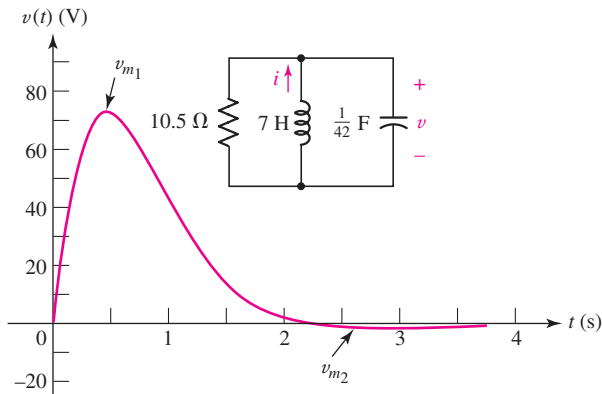

■ FIGURE 9.14 The response  $v(t) = 210\sqrt{2}e^{-2t} \sin \sqrt{2}t$  of the network shown in Fig. 9.2 with  $R$  increased to produce an underdamped response.

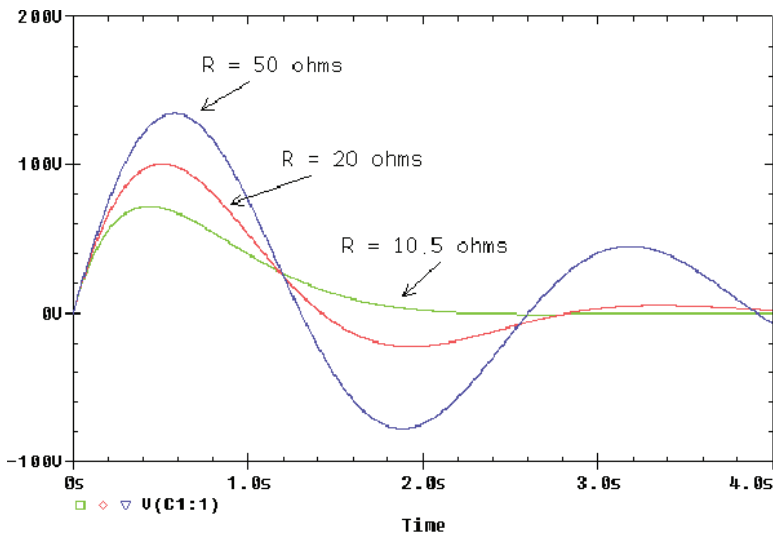

■ FIGURE 9.15 Simulated underdamped voltage response of the network for three different resistance values, showing an increase in the oscillatory behavior as  $R$  is increased.

The settling time may be obtained by a trial-and-error solution, and for  $R = 10.5 \Omega$ , it turns out to be 2.92 s, somewhat smaller than for critical damping. Note that  $t_s$  is *greater* than  $t_{m2}$  because the magnitude of  $v_{m2}$  is greater than 1 percent of the magnitude of  $v_{m1}$ . This suggests that a slight decrease in  $R$  would reduce the magnitude of the undershoot and permit  $t_s$  to be less than  $t_{m2}$ .

The overdamped, critically damped, and underdamped responses for this network as simulated by PSpice are shown on the same graph in Fig. 9.16. A comparison of the three curves makes the following general

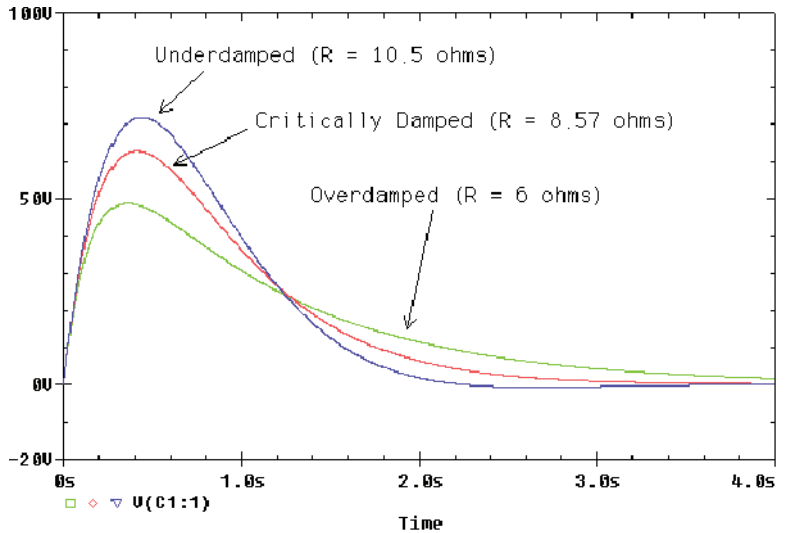

■ FIGURE 9.16 Simulated overdamped, critically damped, and underdamped voltage response for the example network, obtained by varying the value of the parallel resistance  $R$ .

conclusions plausible:

- When the damping is changed by increasing the size of the parallel resistance, the maximum magnitude of the response is greater and the amount of damping is smaller.
- The response becomes oscillatory when underdamping is present, and the minimum settling time is obtained for slight underdamping.

## EXAMPLE 9.6

**Determine  $i_L(t)$  for the circuit of Fig. 9.17a, and plot the waveform.**

At  $t = 0$ , both the 3 A source and the  $48 \Omega$  resistor are removed, leaving the circuit shown in Fig. 9.17b. Thus,  $\alpha = 1.2 \text{ s}^{-1}$  and  $\omega_0 = 4.899 \text{ rad/s}$ . Since  $\alpha < \omega_0$ , the circuit is *underdamped*, and we therefore expect a response of the form

$$i_L(t) = e^{-\alpha t}(B_1 \cos \omega_d t + B_2 \sin \omega_d t) \quad [28]$$

where  $\omega_d = \sqrt{\omega_0^2 - \alpha^2} = 4.750 \text{ rad/s}$ . The only remaining step is to find  $B_1$  and  $B_2$ .

Figure 9.17c shows the circuit as it exists at  $t = 0^-$ . We may replace the inductor with a short circuit and the capacitor with an open circuit; the result is  $v_C(0^-) = 97.30 \text{ V}$  and  $i_L(0^-) = 2.027 \text{ A}$ . Since neither quantity can change in zero time,  $v_C(0^+) = 97.30 \text{ V}$  and  $i_L(0^+) = 2.027 \text{ A}$ .

Substituting  $i_L(0) = 2.027$  into Eq. [28] yields  $B_1 = 2.027 \text{ A}$ . To determine the other constant, we first differentiate Eq. [28]:

$$\frac{di_L}{dt} = e^{-\alpha t}(-B_1 \omega_d \sin \omega_d t + B_2 \omega_d \cos \omega_d t) - \alpha e^{-\alpha t}(B_1 \cos \omega_d t + B_2 \sin \omega_d t) \quad [29]$$



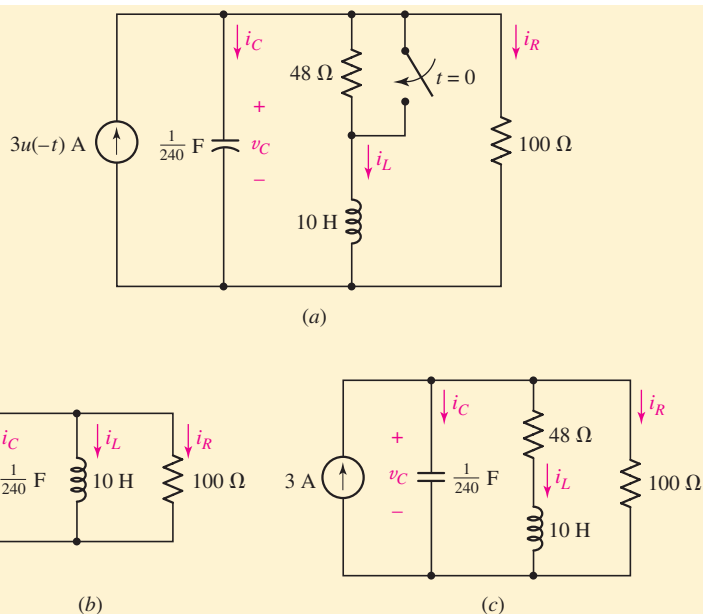

■ FIGURE 9.17 (a) A parallel  $RLC$  circuit for which the current  $i_L(t)$  is desired. (b) Circuit for  $t \geq 0$ . (c) Circuit for determining the initial conditions.

and note that  $v_L(t) = L(di_L/dt)$ . Referring to the circuit of Fig. 9.17b, we see that  $v_L(0^+) = v_C(0^+) = 97.3$  V. Thus, multiplying Eq. [29] by  $L = 10$  H and setting  $t = 0$ , we find that

$$v_L(0) = 10(B_2\omega_d) - 10\alpha B_1 = 97.3$$

Solving,  $B_2 = 2.561$  A, so that

$$i_L = e^{-1.2t}(2.027 \cos 4.75t + 2.561 \sin 4.75t) \quad \text{A}$$

which we have plotted in Fig. 9.18.

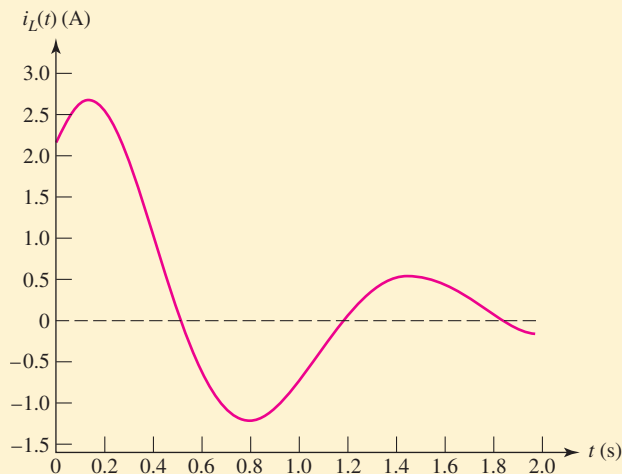

■ FIGURE 9.18 Plot of  $i_L(t)$ , showing obvious signs of being an underdamped response.

## PRACTICE

9.6 The switch in the circuit of Fig. 9.19 has been in the left position for a long time; it is moved to the right at  $t = 0$ . Find (a)  $dv/dt$  at  $t = 0^+$ ; (b)  $v$  at  $t = 1$  ms; (c)  $t_0$ , the first value of  $t$  greater than zero at which  $v = 0$ .

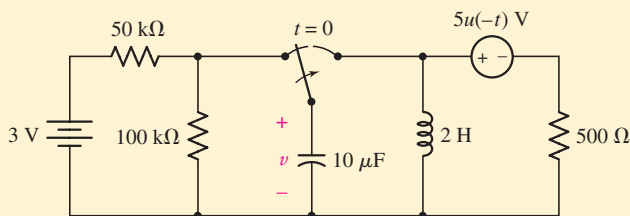

FIGURE 9.19

Ans:  $-1400$  V/s;  $0.695$  V;  $1.609$  ms.

## COMPUTER-AIDED ANALYSIS

One useful feature in Probe is the ability to perform mathematical operations on the voltages and currents that result from a simulation. In this example, we will make use of that ability to show the transfer of energy in a parallel  $RLC$  circuit from a capacitor that initially stores a specific amount of energy ( $1.25 \mu\text{J}$ ) to an inductor that initially stores no energy.

We choose a  $100$  nF capacitor and a  $7 \mu\text{H}$  inductor, which immediately enables us to calculate  $\omega_0 = 1.195 \times 10^6 \text{ s}^{-1}$ . In order to consider overdamped, critically damped, and underdamped cases, we need to select the parallel resistance in such a way as to obtain  $\alpha > \omega_0$  (*overdamped*),  $\alpha = \omega_0$  (*critically damped*), and  $\alpha < \omega_0$  (*underdamped*). From our previous discussions, we know that for a parallel  $RLC$  circuit  $\alpha = (2RC)^{-1}$ . We select  $R = 4.1833 \Omega$  as a close approximation to the critically damped case; obtaining  $\alpha$  precisely equal to  $\omega_0$  is effectively impossible. If we increase the resistance, the energy stored in the other two elements is dissipated more slowly, resulting in an underdamped response. We select  $R = 100 \Omega$  so that we are well into this regime, and use  $R = 1 \Omega$  (a very small resistance) to obtain an overdamped response.

We therefore plan to run three separate simulations, varying only the resistance  $R$  between them. The  $1.25 \mu\text{J}$  of energy initially stored in the capacitor equates to an initial voltage of  $5$  V, and so we set the initial condition of our capacitor accordingly.

Once Probe is launched, we select **Add** under the **Trace** menu. We wish to plot the energy stored in both the inductor and the capacitor as a function of time. For the capacitor,  $w = \frac{1}{2}Cv^2$ , so we click in the **Trace Expression** window, type in “ $0.5*100\text{E}-9*$ ” (without the quotes), click on  $V(C1:1)$ , return to the **Trace Expression** window and enter “ $*$ ”, click on  $V(C1:1)$  once again, and then select **Ok**. We repeat the sequence to obtain the energy stored in the inductor, using  $7\text{E}-6$  instead of  $100\text{E}-9$ , and clicking on  $I(L1:1)$  instead of  $V(C1:1)$ .

The Probe output plots for three separate simulations are provided in Fig. 9.20. In Fig. 9.20a, we see that the energy remaining in the circuit is continuously transferred back and forth between the capacitor and the inductor until it is (eventually) completely dissipated by the resistor. Decreasing the resistance to  $4.1833 \Omega$  yields a critically damped circuit, resulting in the energy plot of Fig. 9.20b. The oscillatory energy transfer between the capacitor and the inductor has been dramatically reduced. We see that the energy transferred to the inductor peaks at approximately  $0.8 \mu\text{s}$ , and then drops to zero. The overdamped response is plotted in Fig. 9.20c. We note that the energy is dissipated much more quickly in the case of the overdamped response, and that very little energy is transferred to the inductor, since most of it is now quickly dissipated in the resistor.

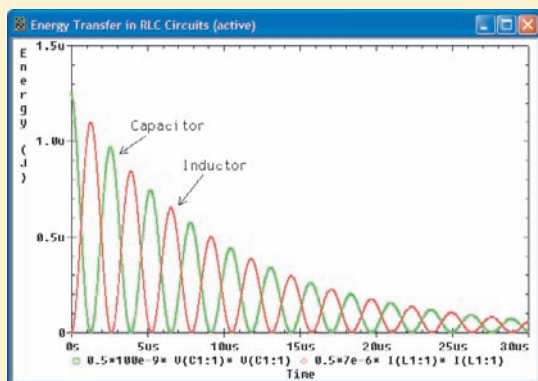

(a)

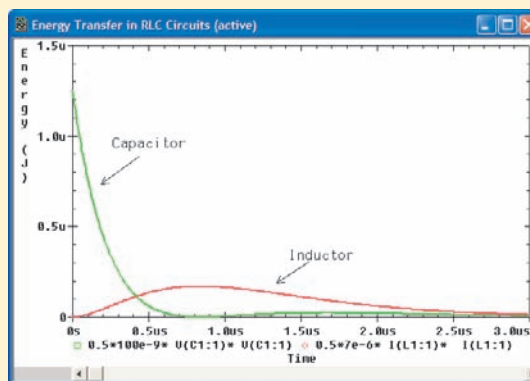

(b)

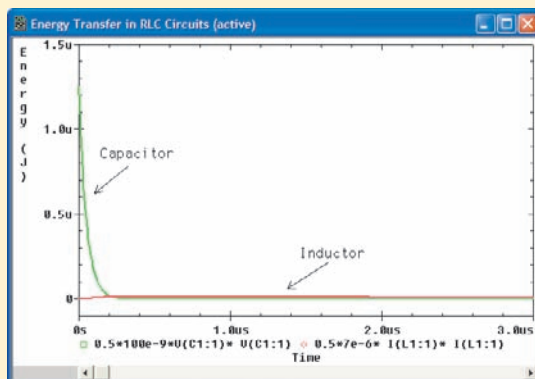

(c)

■ FIGURE 9.20 Energy transfer in a parallel *RLC* circuit with (a)  $R = 100 \Omega$  (underdamped); (b)  $R = 4.1833 \Omega$  (critically damped); and (c)  $R = 1 \Omega$  (overdamped).

## 9.5 THE SOURCE-FREE SERIES *RLC* CIRCUIT

We now wish to determine the natural response of a circuit model composed of an ideal resistor, an ideal inductor, and an ideal capacitor connected in *series*. The ideal resistor may represent a physical resistor connected into a series *LC* or *RLC* circuit; it may represent the ohmic losses and the losses in the ferromagnetic core of the inductor; or it may be used to represent all these and other energy-absorbing devices.

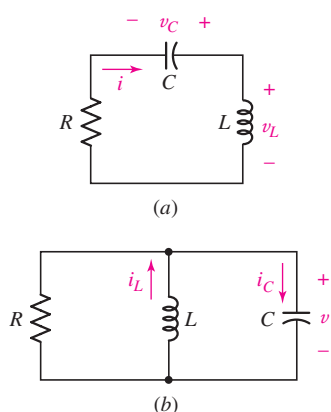

■ FIGURE 9.21 (a) The series  $RLC$  circuit which is the dual of (b) a parallel  $RLC$  circuit. Element values are, of course, not identical in the two circuits.

The series  $RLC$  circuit is the *dual* of the parallel  $RLC$  circuit, and this single fact is sufficient to make its analysis a trivial affair. Figure 9.21a shows the series circuit. The fundamental integrodifferential equation is

$$L \frac{di}{dt} + Ri + \frac{1}{C} \int_{t_0}^t i dt' - v_C(t_0) = 0$$

and should be compared with the analogous equation for the parallel  $RLC$  circuit, drawn again in Fig. 9.21b,

$$C \frac{dv}{dt} + \frac{1}{R}v + \frac{1}{L} \int_{t_0}^t v dt' - i_L(t_0) = 0$$

The respective second-order equations obtained by differentiating these two equations with respect to time are also duals:

$$L \frac{d^2i}{dt^2} + R \frac{di}{dt} + \frac{1}{C}i = 0 \quad [30]$$

$$C \frac{d^2v}{dt^2} + \frac{1}{R} \frac{dv}{dt} + \frac{1}{L}v = 0 \quad [31]$$

Our complete discussion of the parallel  $RLC$  circuit is directly applicable to the series  $RLC$  circuit; the initial conditions on capacitor voltage and inductor current are equivalent to the initial conditions on inductor current and capacitor voltage; the *voltage* response becomes a *current* response. It is therefore possible to reread the previous four sections using dual language and thereby obtain a complete description of the series  $RLC$  circuit. This process, however, is apt to induce a mild neurosis after the first few paragraphs and does not really seem to be necessary.

## A Brief Résumé of the Series Circuit Response

In terms of the circuit shown in Fig. 9.21a, the *overdamped response* is

$$i(t) = A_1 e^{s_1 t} + A_2 e^{s_2 t}$$

where

$$s_{1,2} = -\frac{R}{2L} \pm \sqrt{\left(\frac{R}{2L}\right)^2 - \frac{1}{LC}} = -\alpha \pm \sqrt{\alpha^2 - \omega_0^2}$$

and thus

$$\alpha = \frac{R}{2L}$$

$$\omega_0 = \frac{1}{\sqrt{LC}}$$

The form of the *critically damped response* is

$$i(t) = e^{-\alpha t} (A_1 t + A_2)$$

and the *underdamped response* may be written

$$i(t) = e^{-\alpha t} (B_1 \cos \omega_d t + B_2 \sin \omega_d t)$$

TABLE 9.1 Summary of Relevant Equations for Source-Free RLC Circuits

Type	Condition	Criteria	$\alpha$	$\omega_0$	Response
Parallel Series	Overdamped	$\alpha > \omega_0$	$\frac{1}{2RC}$ $\frac{R}{2L}$	$\frac{1}{\sqrt{LC}}$	$A_1 e^{s_1 t} + A_2 e^{s_2 t}$ , where $s_{1,2} = -\alpha \pm \sqrt{\alpha^2 - \omega_0^2}$
Parallel Series	Critically damped	$\alpha = \omega_0$	$\frac{1}{2RC}$ $\frac{R}{2L}$	$\frac{1}{\sqrt{LC}}$	$e^{-\alpha t} (A_1 t + A_2)$
Parallel Series	Underdamped	$\alpha < \omega_0$	$\frac{1}{2RC}$ $\frac{R}{2L}$	$\frac{1}{\sqrt{LC}}$	$e^{-\alpha t} (B_1 \cos \omega_d t + B_2 \sin \omega_d t)$ , where $\omega_d = \sqrt{\omega_0^2 - \alpha^2}$

where

$$\omega_d = \sqrt{\omega_0^2 - \alpha^2}$$

It is evident that if we work in terms of the parameters  $\alpha$ ,  $\omega_0$ , and  $\omega_d$ , the mathematical forms of the responses for the dual situations are identical. An increase in  $\alpha$  in either the series or parallel circuit, while keeping  $\omega_0$  constant, tends toward an overdamped response. The only caution that we need exert is in the computation of  $\alpha$ , which is  $1/2RC$  for the parallel circuit and  $R/2L$  for the series circuit; thus,  $\alpha$  is increased by increasing the series resistance or decreasing the parallel resistance. The key equations for parallel and series RLC circuits are summarized in Table 9.1 for convenience.



## EXAMPLE 9.7

Given the series RLC circuit of Fig. 9.22 in which  $L = 1$  H,  $R = 2$  k $\Omega$ ,  $C = 1/401$   $\mu$ F,  $i(0) = 2$  mA, and  $v_C(0) = 2$  V, find and sketch  $i(t)$ ,  $t > 0$ .

We find that  $\alpha = R/2L = 1000$  s $^{-1}$  and  $\omega_0 = 1/\sqrt{LC} = 20,025$  rad/s. This indicates an *underdamped* response; we therefore calculate the value of  $\omega_d$  and obtain 20,000 rad/s. Except for the evaluation of the two arbitrary constants, the response is now known:

$$i(t) = e^{-1000t} (B_1 \cos 20,000t + B_2 \sin 20,000t)$$

Since we know that  $i(0) = 2$  mA, we may substitute this value into our equation for  $i(t)$  to obtain

$$B_1 = 0.002 \text{ A}$$

and thus

$$i(t) = e^{-1000t} (0.002 \cos 20,000t + B_2 \sin 20,000t) \quad \text{A}$$

(Continued on next page)

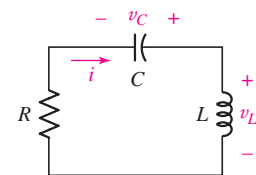

FIGURE 9.22 A simple source-free RLC circuit with energy stored in both the inductor and the capacitor at  $t = 0$ .

The remaining initial condition must be applied to the derivative; thus,

$$\begin{aligned} \frac{di}{dt} &= e^{-1000t}(-40 \sin 20,000t + 20,000B_2 \cos 20,000t \\ &\quad - 2 \cos 20,000t - 1000B_2 \sin 20,000t) \end{aligned}$$

and

$$\begin{aligned} \left. \frac{di}{dt} \right|_{t=0} &= 20,000B_2 - 2 = \frac{v_L(0)}{L} \\ &= \frac{v_C(0) - Ri(0)}{L} \\ &= \frac{2 - 2000(0.002)}{1} = -2 \text{ A/s} \end{aligned}$$

so that

$$B_2 = 0$$

The desired response is therefore

$$i(t) = 2e^{-1000t} \cos 20,000t \quad \text{mA}$$

A good sketch may be made by first drawing in the two portions of the exponential *envelope*,  $2e^{-1000t}$  and  $-2e^{-1000t}$  mA, as shown by the broken lines in Fig. 9.23. The location of the quarter-cycle points of the sinusoidal wave at  $20,000t = 0, \pi/2, \pi$ , etc., or  $t = 0.07854k$  ms,  $k = 0, 1, 2, \dots$ , by light marks on the time axis then permits the oscillatory curve to be sketched in quickly.

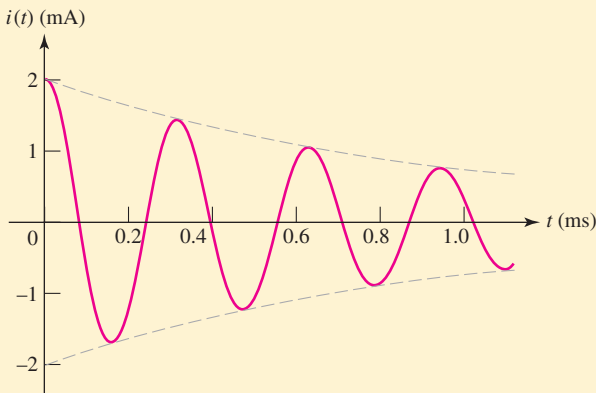

■ FIGURE 9.23 The current response in an underdamped series RLC circuit for which  $\alpha = 1000 \text{ s}^{-1}$ ,  $\omega_0 = 20,000 \text{ s}^{-1}$ ,  $i(0) = 2 \text{ mA}$ , and  $v_C(0) = 2 \text{ V}$ . The graphical construction is simplified by drawing in the envelope, shown as a pair of broken lines.

The settling time can be determined easily here by using the upper portion of the envelope. That is, we set  $2e^{-1000t_s}$  mA equal to 1 percent of its maximum value, 2 mA. Thus,  $e^{-1000t_s} = 0.01$ , and  $t_s = 4.61$  ms is the approximate value that is usually used.

## PRACTICE

9.7 With reference to the circuit shown in Fig. 9.24, find (a)  $\alpha$ ; (b)  $\omega_0$ ; (c)  $i(0^+)$ ; (d)  $di/dt|_{t=0^+}$ ; (e)  $i(12 \text{ ms})$ .

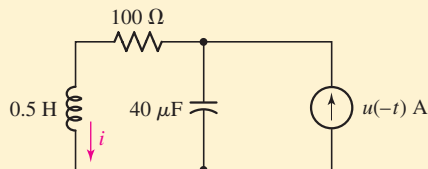

FIGURE 9.24

Ans:  $100 \text{ s}^{-1}$ ;  $224 \text{ rad/s}$ ;  $1 \text{ A}$ ;  $0$ ;  $-0.1204 \text{ A}$ .

As a final example, we pause to consider situations where the circuit includes a dependent source. If no controlling current or voltage associated with the dependent source is of interest, we may simply find the Thévenin equivalent connected to the inductor and capacitor. Otherwise, we are likely faced with having to write an appropriate integrodifferential equation, take the indicated derivative, and solve the resulting differential equation as best we can.

## EXAMPLE 9.8

Find an expression for  $v_C(t)$  in the circuit of Fig. 9.25a, valid for  $t > 0$ .

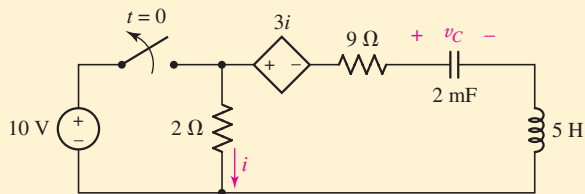

(a)

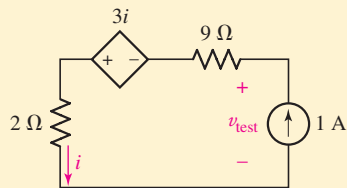

(b)

FIGURE 9.25 (a) An RLC circuit containing a dependent source.  
(b) Circuit for finding  $R_{\text{eq}}$ .

As we are interested only in  $v_C(t)$ , it is perfectly acceptable to begin by finding the Thévenin equivalent resistance connected in series with the

(Continued on next page)

inductor and capacitor at  $t = 0^+$ . We do this by connecting a 1 A source as shown in Fig. 9.25b, from which we deduce that

$$v_{\text{test}} = 11i - 3i = 8i = 8(1) = 8 \text{ V}$$

Thus,  $R_{\text{eq}} = 8 \Omega$ , so  $\alpha = R/2L = 0.8 \text{ s}^{-1}$  and  $\omega_0 = 1/\sqrt{LC} = 10 \text{ rad/s}$ , meaning that we expect an underdamped response with  $\omega_d = 9.968 \text{ rad/s}$  and the form

$$v_C(t) = e^{-0.8t}(B_1 \cos 9.968t + B_2 \sin 9.968t) \quad [32]$$

In considering the circuit at  $t = 0^-$ , we note that  $i_L(0^-) = 0$  due to the presence of the capacitor. By Ohm's law,  $i(0^-) = 5 \text{ A}$ , so

$$v_C(0^+) = v_C(0^-) = 10 - 3i = 10 - 15 = -5 \text{ V}$$

This last condition substituted into Eq. [32] yields  $B_1 = -5 \text{ V}$ . Taking the derivative of Eq. [32] and evaluating at  $t = 0$  yield

$$\left. \frac{dv_C}{dt} \right|_{t=0} = -0.8B_1 + 9.968B_2 = 4 + 9.968B_2 \quad [33]$$

We see from Fig. 9.25a that

$$i = -C \frac{dv_C}{dt}$$

Thus, making use of the fact that  $i(0^+) = i_L(0^-) = 0$  in Eq. [33] yields  $B_2 = -0.4013 \text{ V}$ , and we may write

$$v_C(t) = -e^{-0.8t}(5 \cos 9.968t + 0.4013 \sin 9.968t) \quad \text{V} \quad t > 0$$

The PSpice simulation of this circuit, shown in Fig. 9.26, confirms our analysis.

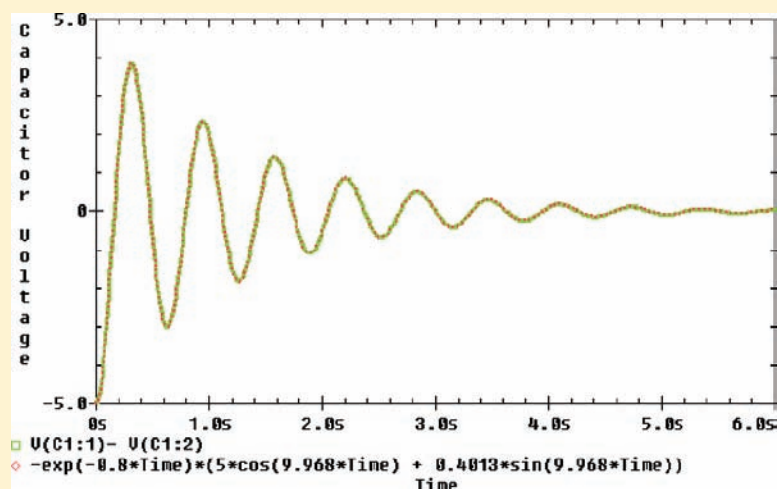

FIGURE 9.26 PSpice simulation of the circuit shown in Fig. 9.25a. The analytical result is plotted using a dashed red line.



**PRACTICE**

9.8 Find an expression for  $i_L(t)$  in the circuit of Fig. 9.27, valid for  $t > 0$ , if  $v_C(0^-) = 10$  V and  $i_L(0^-) = 0$ . Note that although it is not helpful to apply Thévenin techniques in this instance, the action of the dependent source links  $v_C$  and  $i_L$  such that a first-order linear differential equation results.

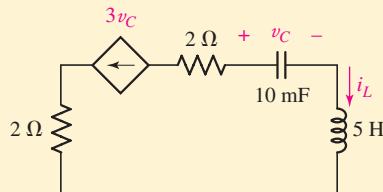

FIGURE 9.27 Circuit for Practice Problem 9.8.

Ans:  $i_L(t) = -30e^{-300t}$  A,  $t > 0$ .

## 9.6 THE COMPLETE RESPONSE OF THE RLC CIRCUIT

We now consider those *RLC* circuits in which dc sources are switched into the network and produce forced responses that do not necessarily vanish as time becomes infinite.

The general solution is obtained by the same procedure that was followed for *RL* and *RC* circuits. The basic steps are (not necessarily in this order) as follows:

1. Determine the initial conditions.
2. Obtain a numerical value for the forced response.
3. Write the appropriate form of the natural response with the necessary number of arbitrary constants.
4. Add the forced response and natural response to form the complete response.
5. Evaluate the response and its derivative at  $t = 0$ , and employ the initial conditions to solve for the values of the unknown constants.

We note that *it is generally this last step that causes the most trouble for students*, as the circuit must be carefully evaluated at  $t = 0$  to make full use of the initial conditions. Consequently, although the determination of the initial conditions is basically no different for a circuit containing dc sources from what it is for the source-free circuits that we have already covered in some detail, this topic will receive particular emphasis in the examples that follow.

Most of the confusion in determining and applying the initial conditions arises for the simple reason that we do not have a rigorous set of rules laid down for us to follow. At some point in each analysis, a situation usually arises in which some thinking is involved that is more or less unique to that particular problem. This is almost always the source of the difficulty.



### The Easy Part

The *complete* response (arbitrarily assumed to be a voltage response) of a second-order system consists of a *forced* response,

$$v_f(t) = V_f$$

which is a constant for dc excitation, and a *natural* response,

$$v_n(t) = Ae^{s_1 t} + Be^{s_2 t}$$

Thus,

$$v(t) = V_f + Ae^{s_1 t} + Be^{s_2 t}$$

We assume that  $s_1$ ,  $s_2$ , and  $V_f$  have already been determined from the circuit and the given forcing functions;  $A$  and  $B$  remain to be found. The last equation shows the functional interdependence of  $A$ ,  $B$ ,  $v$ , and  $t$ ; and substitution of the known value of  $v$  at  $t = 0^+$  thus provides us with a single equation relating  $A$  and  $B$ ,  $v(0^+) = V_f + A + B$ . *This is the easy part.*

### The Other Part

Another relationship between  $A$  and  $B$  is necessary, unfortunately, and this is normally obtained by taking the derivative of the response,

$$\frac{dv}{dt} = 0 + s_1 A e^{s_1 t} + s_2 B e^{s_2 t}$$

and inserting the known value of  $dv/dt$  at  $t = 0^+$ . We thus have two equations relating  $A$  and  $B$ , and these may be solved simultaneously to evaluate the two constants.

The only remaining problem is that of determining the values of  $v$  and  $dv/dt$  at  $t = 0^+$ . Let us suppose that  $v$  is a capacitor voltage,  $v_C$ . Since  $i_C = C dv_C/dt$ , we should recognize the relationship between the initial value of  $dv/dt$  and the initial value of some capacitor current. If we can establish a value for this initial capacitor current, then we will automatically establish the value of  $dv/dt$ . Students are usually able to get  $v(0^+)$  very easily, but are inclined to stumble a bit in finding the initial value of  $dv/dt$ . If we had selected an inductor current  $i_L$  as our response, then the initial value of  $di_L/dt$  would be intimately related to the initial value of some inductor voltage. Variables other than capacitor voltages and inductor currents are determined by expressing their initial values and the initial values of their derivatives in terms of the corresponding values for  $v_C$  and  $i_L$ .

We will illustrate the procedure and find all these values by the careful analysis of the circuit shown in Fig. 9.28. To simplify the analysis, an unusual value of capacitance is used again.

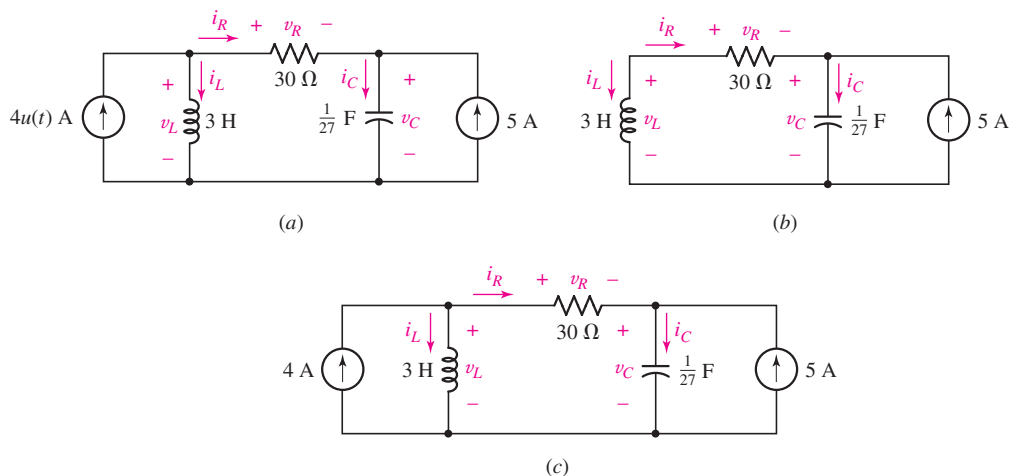

■ FIGURE 9.28 (a) An RLC circuit that is used to illustrate several procedures by which the initial conditions may be obtained. The desired response is nominally taken to be  $v_C(t)$ . (b)  $t = 0^-$ . (c)  $t > 0$ .

## EXAMPLE 9.9

There are three passive elements in the circuit shown in Fig. 9.28a, and a voltage and a current are defined for each. Find the values of these six quantities at both  $t = 0^-$  and  $t = 0^+$ .

Our object is to find the value of each current and voltage at both  $t = 0^-$  and  $t = 0^+$ . Once these quantities are known, the initial values of the derivatives may be found easily.

1.  $t = 0^-$  At  $t = 0^-$ , only the right-hand current source is active as depicted in Fig. 9.28b. The circuit is assumed to have been in this state forever, so all currents and voltages are constant. Thus, a dc current through the inductor requires zero voltage across it:

$$v_L(0^-) = 0$$

and a dc voltage across the capacitor ( $-v_R$ ) requires zero current through it:

$$i_C(0^-) = 0$$

We next apply Kirchhoff's current law to the right-hand node to obtain

$$i_R(0^-) = -5 \text{ A}$$

which also yields

$$v_R(0^-) = -150 \text{ V}$$

We may now use Kirchhoff's voltage law around the left-hand mesh, finding

$$v_C(0^-) = 150 \text{ V}$$

while KCL enables us to find the inductor current,

$$i_L(0^-) = 5 \text{ A}$$

2.  $t = 0^+$  During the interval from  $t = 0^-$  to  $t = 0^+$ , the left-hand current source becomes active and many of the voltage and current values at  $t = 0^-$  will change abruptly. The corresponding circuit is shown in Fig. 9.28c. However, we should *begin by focusing our attention on those quantities which cannot change, namely, the inductor current and the capacitor voltage*. Both of these must remain constant during the switching interval. Thus,

$$i_L(0^+) = 5 \text{ A} \quad \text{and} \quad v_C(0^+) = 150 \text{ V}$$

Since two currents are now known at the left node, we next obtain

$$i_R(0^+) = -1 \text{ A} \quad \text{and} \quad v_R(0^+) = -30 \text{ V}$$

so that

$$i_C(0^+) = 4 \text{ A} \quad \text{and} \quad v_L(0^+) = 120 \text{ V}$$

and we have our six initial values at  $t = 0^-$  and six more at  $t = 0^+$ .

Among these last six values, only the capacitor voltage and the inductor current are unchanged from the  $t = 0^-$  values.

We could have employed a slightly different method to evaluate these currents and voltages at  $t = 0^-$  and  $t = 0^+$ . Prior to the switching operation, only direct currents and voltages exist in the circuit. The inductor may therefore be replaced by a short circuit, its dc equivalent, while the capacitor is replaced by an open circuit. Redrawn in this manner, the circuit of Fig. 9.28a appears as shown in Fig. 9.29a. Only the current source at the right is active, and its 5 A flow through the resistor and the inductor. We therefore have  $i_R(0^-) = -5$  A and  $v_R(0^-) = -150$  V,  $i_L(0^-) = 5$  A and  $v_L(0^-) = 0$ , and  $i_C(0^-) = 0$  and  $v_C(0^-) = 150$  V, as before.

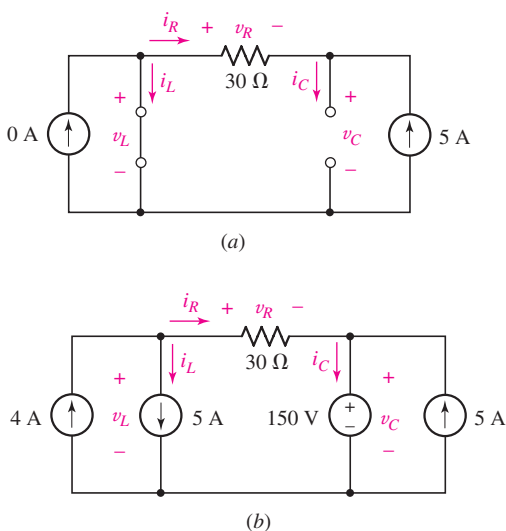

■ FIGURE 9.29 (a) A simple circuit equivalent to the circuit of Fig. 9.28a for  $t = 0^-$ . (b) Equivalent circuit with labeled voltages and currents valid at the instant defined by  $t = 0^+$ .

We now turn to the problem of drawing an equivalent circuit that will assist us in determining the several voltages and currents at  $t = 0^+$ . *Each capacitor voltage and each inductor current must remain constant during the switching interval.* These conditions are ensured by replacing the inductor with a current source and the capacitor with a voltage source. Each source serves to maintain a constant response during the discontinuity. The equivalent circuit of Fig. 9.29b results. It should be noted that the circuit shown in Fig. 9.29b is valid *only for the interval between  $0^-$  and  $0^+$ .*

The voltages and currents at  $t = 0^+$  are obtained by analyzing this dc circuit. The solution is not difficult, but the relatively large number of sources present in the network does produce a somewhat strange sight. However, problems of this type were solved in Chap. 3, and nothing new is involved. Attacking the currents first, we begin at the upper left node and see that  $i_R(0^+) = 4 - 5 = -1$  A. Moving to the upper right node, we find that  $i_C(0^+) = -1 + 5 = 4$  A. And, of course,  $i_L(0^+) = 5$  A.

Next we consider the voltages. Using Ohm's law, we see that  $v_R(0^+) = 30(-1) = -30$  V. For the inductor, KVL gives us  $v_L(0^+) = -30 + 150 = 120$  V. Finally, including  $v_C(0^+) = 150$  V, we have all the values at  $t = 0^+$ .

## PRACTICE

9.9 Let  $i_s = 10u(-t) - 20u(t)$  A in Fig. 9.30. Find (a)  $i_L(0^-)$ ; (b)  $v_C(0^+)$ ; (c)  $v_R(0^+)$ ; (d)  $i_L(\infty)$ ; (e)  $i_L(0.1 \text{ ms})$ .

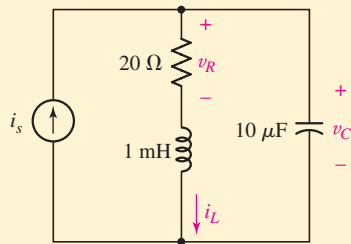

FIGURE 9.30

Ans: 10 A; 200 V; 200 V; -20 A; 2.07 A.

## EXAMPLE 9.10

Complete the determination of the initial conditions in the circuit of Fig. 9.28, repeated in Fig. 9.31, by finding values at  $t = 0^+$  for the first derivatives of the three voltage and three current variables defined on the circuit diagram.

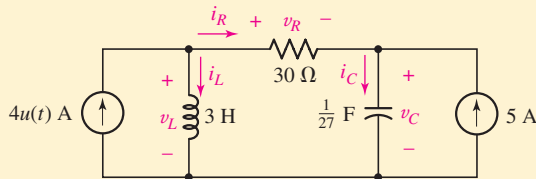

FIGURE 9.31 Circuit of Fig. 9.28, repeated for Example 9.10.

We begin with the two energy storage elements. For the inductor,

$$v_L = L \frac{di_L}{dt}$$

and, specifically,

$$v_L(0^+) = L \left. \frac{di_L}{dt} \right|_{t=0^+}$$

Thus,

$$\left. \frac{di_L}{dt} \right|_{t=0^+} = \frac{v_L(0^+)}{L} = \frac{120}{3} = 40 \text{ A/s}$$

Similarly,

$$\left. \frac{dv_C}{dt} \right|_{t=0^+} = \frac{i_C(0^+)}{C} = \frac{4}{1/27} = 108 \text{ V/s}$$

(Continued on next page)

The other four derivatives may be determined by realizing that KCL and KVL are both satisfied by the derivatives also. For example, at the left-hand node in Fig. 9.31,

$$4 - i_L - i_R = 0 \quad t > 0$$

and thus,

$$0 - \frac{di_L}{dt} - \frac{di_R}{dt} = 0 \quad t > 0$$

and therefore,

$$\left. \frac{di_R}{dt} \right|_{t=0^+} = -40 \text{ A/s}$$

The three remaining initial values of the derivatives are found to be

$$\left. \frac{dv_R}{dt} \right|_{t=0^+} = -1200 \text{ V/s}$$

$$\left. \frac{dv_L}{dt} \right|_{t=0^+} = -1092 \text{ V/s}$$

and

$$\left. \frac{di_C}{dt} \right|_{t=0^+} = -40 \text{ A/s}$$

Before leaving this problem of the determination of the necessary initial values, we should point out that at least one other powerful method of determining them has been omitted: we could have written general nodal or loop equations for the original circuit. Then the substitution of the known zero values of inductor voltage and capacitor current at  $t = 0^-$  would uncover several other response values at  $t = 0^-$  and enable the remainder to be found easily. A similar analysis at  $t = 0^+$  must then be made. This is an important method, and it becomes a necessary one in more complicated circuits which cannot be analyzed by our simpler step-by-step procedures.

Now let us briefly complete the determination of the response  $v_C(t)$  for the original circuit of Fig. 9.31. With both sources dead, the circuit appears as a series *RLC* circuit and  $s_1$  and  $s_2$  are easily found to be  $-1$  and  $-9$ , respectively. The forced response may be found by inspection or, if necessary, by drawing the dc equivalent, which is similar to Fig. 9.29a, with the addition of a 4 A current source. The forced response is 150 V. Thus,

$$v_C(t) = 150 + Ae^{-t} + Be^{-9t}$$

and

$$v_C(0^+) = 150 = 150 + A + B$$

or

$$A + B = 0$$

Then,

$$\frac{dv_C}{dt} = -Ae^{-t} - 9Be^{-9t}$$

and

$$\left. \frac{dv_C}{dt} \right|_{t=0^+} = 108 = -A - 9B$$

Finally,

$$A = 13.5 \quad B = -13.5$$

and

$$v_C(t) = 150 + 13.5(e^{-t} - e^{-9t}) \quad \text{V}$$

## A Quick Summary of the Solution Process

In summary, then, whenever we wish to determine the transient behavior of a simple three-element *RLC* circuit, we must first decide whether we are confronted with a series or a parallel circuit, so that we may use the correct relationship for  $\alpha$ . The two equations are

$$\alpha = \frac{1}{2RC} \quad (\text{parallel } RLC)$$

$$\alpha = \frac{R}{2L} \quad (\text{series } RLC)$$

Our second decision is made after comparing  $\alpha$  with  $\omega_0$ , which is given for either circuit by

$$\omega_0 = \frac{1}{\sqrt{LC}}$$

If  $\alpha > \omega_0$ , the circuit is *overdamped*, and the natural response has the form

$$f_n(t) = A_1 e^{s_1 t} + A_2 e^{s_2 t}$$

where

$$s_{1,2} = -\alpha \pm \sqrt{\alpha^2 - \omega_0^2}$$

If  $\alpha = \omega_0$ , then the circuit is *critically damped* and

$$f_n(t) = e^{-\alpha t}(A_1 t + A_2)$$

And finally, if  $\alpha < \omega_0$ , then we are faced with the *underdamped* response,

$$f_n(t) = e^{-\alpha t}(A_1 \cos \omega_d t + A_2 \sin \omega_d t)$$

where

$$\omega_d = \sqrt{\omega_0^2 - \alpha^2}$$

Our last decision depends on the independent sources. If there are none acting in the circuit after the switching or discontinuity is completed, then the circuit is source-free and the natural response accounts for the complete response. If independent sources are still present, then the circuit is driven and a forced response must be determined. The complete response is then the sum

$$f(t) = f_f(t) + f_n(t)$$

This is applicable to any current or voltage in the circuit. Our final step is to solve for unknown constants given the initial conditions.

# PRACTICAL APPLICATION

## Modeling Automotive Suspension Systems

Earlier, we alluded to the fact that the concepts investigated in this chapter actually extend beyond the analysis of electric circuits. In fact, the general form of the differential equations we have been working with appears in many fields—we need only learn how to “translate” new parameter terminology. For example, consider a simple automotive suspension, as shown in Fig. 9.32. The piston is not attached to the cylinder, but *is* attached to both the spring and the wheel. The moving parts therefore are the spring, the piston, and the wheel.

We will model this physical system by first determining the forces in play. Defining a position function  $p(t)$  which describes where the piston lies within the cylinder, we may write  $F_S$ , the force on the spring, as

$$F_S = Kp(t)$$

where  $K$  is known as the spring constant and has units of lb/ft. The force on the wheel  $F_W$  is equal to the mass of the wheel times its acceleration, or

$$F_W = m \frac{d^2 p(t)}{dt^2}$$

where  $m$  is measured in  $\text{lb} \cdot \text{s}^2/\text{ft}$ . Last but not least is the force of friction  $F_f$  acting on the piston

$$F_f = \mu_f \frac{dp(t)}{dt}$$



■ FIGURE 9.32 Typical automotive suspension system.  
© Transtock Inc./Alamy.

where  $\mu_f$  is the coefficient of friction, with units of  $\text{lb} \cdot \text{s}/\text{ft}$ .

From our basic physics courses we know that all forces acting in our system must sum to zero, so that

$$m \frac{d^2 p(t)}{dt^2} + \mu_f \frac{dp(t)}{dt} + Kp(t) = 0 \quad [34]$$

This equation most likely had the potential to give us nightmares at one point in our academic career, but no longer. We compare Eq. [32] to Eqs. [30] and [31] and immediately see a distinct resemblance, at least in the general form. Choosing Eq. [30], the differential equation describing the inductor current of a series-connected *RLC* circuit, we observe the following correspondences:

Mass	$m$	→	inductance	$L$
Coefficient of friction	$\mu_f$	→	resistance	$R$
Spring constant	$K$	→	inverse of the capacitance	$C^{-1}$
Position variable	$p(t)$	→	current variable	$i(t)$

So, if we are willing to talk about feet instead of amperes,  $\text{lb} \cdot \text{s}^2/\text{ft}$  instead of H,  $\text{ft}/\text{lb}$  instead of F, and  $\text{lb} \cdot \text{s}/\text{ft}$  instead of  $\Omega$ , we can apply our newly found skills at modeling *RLC* circuits to the task of evaluating automotive shock absorbers.

Take a typical car wheel of 70 lb. The mass is found by dividing the weight by the earth’s gravitational acceleration ( $32.17 \text{ ft}/\text{s}^2$ ), resulting in  $m = 2.176 \text{ lb} \cdot \text{s}^2/\text{ft}$ . The curb weight of our car is 1985 lb, and the static displacement of the spring is 4 inches (no passengers). The spring constant is obtained by dividing the weight on each shock absorber by the static displacement, so that we have  $K = (\frac{1}{4})(1985)(3 \text{ ft}^{-1}) = 1489 \text{ lb}/\text{ft}$ . We are also told that the coefficient of friction for our piston-cylinder assembly is  $65 \text{ lb} \cdot \text{s}/\text{ft}$ . Thus, we can simulate our shock absorber by modeling it with a series *RLC* circuit having  $R = 65 \Omega$ ,  $L = 2.176 \text{ H}$ , and  $C = K^{-1} = 671.6 \mu\text{F}$ .

The resonant frequency of our shock absorber is  $\omega_0 = (LC)^{-1/2} = 26.16 \text{ rad}/\text{s}$ , and the damping coefficient is  $\alpha = R/2L = 14.94 \text{ s}^{-1}$ . Since  $\alpha < \omega_0$ , our shock absorber represents an underdamped system; this means that we expect a bounce or two after we run over a pothole. A stiffer shock (larger coefficient of friction, or a larger resistance in our circuit model) is typically desirable when curves are taken at high speeds—at some point this corresponds to an overdamped response. However, if most of our driving is over unpaved roads, a slightly underdamped response is preferable.



## PRACTICE

9.10 Let  $v_s = 10 + 20u(t)$  V in the circuit of Fig. 9.33. Find (a)  $i_L(0)$ ; (b)  $v_C(0)$ ; (c)  $i_{L,f}$ ; (d)  $i_L(0.1$  s).

Ans: 0.2 A; 10 V; 0.6 A; 0.319 A.

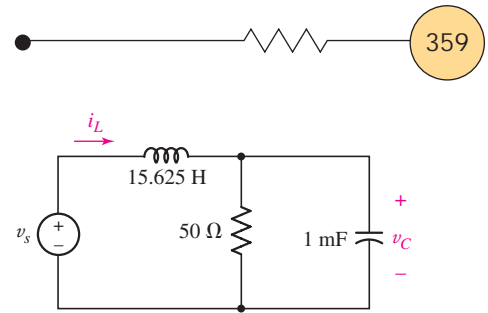

FIGURE 9.33

## 9.7 THE LOSSLESS LC CIRCUIT

When we considered the source-free  $RLC$  circuit, it became apparent that the resistor served to dissipate any initial energy stored in the circuit. At some point it might occur to us to ask what would happen if we could remove the resistor. If the value of the resistance in a parallel  $RLC$  circuit becomes infinite, or zero in the case of a series  $RLC$  circuit, we have a simple  $LC$  loop in which an oscillatory response can be maintained forever. Let us look briefly at an example of such a circuit, and then discuss another means of obtaining an identical response without the need of supplying any inductance.

Consider the source-free circuit of Fig. 9.34, in which the large values  $L = 4$  H and  $C = \frac{1}{36}$  F are used so that the calculations will be simple. We let  $i(0) = -\frac{1}{6}$  A and  $v(0) = 0$ . We find that  $\alpha = 0$  and  $\omega_0^2 = 9$  s $^{-2}$ , so that  $\omega_d = 3$  rad/s. In the absence of exponential damping, the voltage  $v$  is simply

$$v = A \cos 3t + B \sin 3t$$

Since  $v(0) = 0$ , we see that  $A = 0$ . Next,

$$\left. \frac{dv}{dt} \right|_{t=0} = 3B = -\frac{i(0)}{1/36}$$

But  $i(0) = -\frac{1}{6}$  ampere, and therefore  $dv/dt = 6$  V/s at  $t = 0$ . We must have  $B = 2$  V and so

$$v = 2 \sin 3t \quad \text{V}$$

which is an undamped sinusoidal response; in other words, our voltage response does not decay.

Now let us see how we might obtain this voltage without using an  $LC$  circuit. Our intentions are to write the differential equation that  $v$  satisfies and then to develop a configuration of op amps that will yield the solution of the equation. Although we are working with a specific example, the technique is a general one that can be used to solve any linear homogeneous differential equation.

For the  $LC$  circuit of Fig. 9.34, we select  $v$  as our variable and set the sum of the downward inductor and capacitor currents equal to zero:

$$\frac{1}{4} \int_{t_0}^t v dt' - \frac{1}{6} + \frac{1}{36} \frac{dv}{dt} = 0$$

Differentiating once, we have

$$\frac{1}{4}v + \frac{1}{36} \frac{d^2v}{dt^2} = 0$$

or

$$\frac{d^2v}{dt^2} = -9v$$

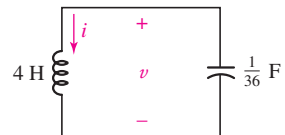
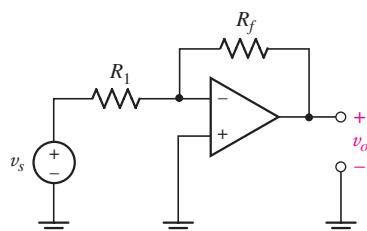

FIGURE 9.34 This circuit is lossless, and it provides the undamped response  $v = 2 \sin 3t$  V, if  $v(0) = 0$  and  $i(0) = -\frac{1}{6}$  A.



■ FIGURE 9.35 The inverting operational amplifier provides a gain  $v_o/v_s = -R_f/R_1$ , assuming an ideal op amp.

In order to solve this equation, we plan to make use of the operational amplifier as an integrator. We assume that the highest-order derivative appearing in the differential equation here,  $d^2v/dt^2$ , is available in our configuration of op amps at an arbitrary point  $A$ . We now make use of the integrator, with  $RC = 1$ , as discussed in Sec. 7.5. The input is  $d^2v/dt^2$ , and the output must be  $-dv/dt$ , where the sign change results from using an inverting op amp configuration for the integrator. The initial value of  $dv/dt$  is 6 V/s, as we showed when we first analyzed the circuit, and thus an initial value of  $-6$  V must be set in the integrator. The negative of the first derivative now forms the input to a second integrator. Its output is therefore  $v(t)$ , and the initial value is  $v(0) = 0$ . Now it only remains to multiply  $v$  by  $-9$  to obtain the second derivative we assumed at point  $A$ . This is amplification by 9 with a sign change, and it is easily accomplished by using the op amp as an inverting amplifier.

Figure 9.35 shows the circuit of an inverting amplifier. For an ideal op amp, both the input current and the input voltage are zero. Thus, the current going “east” through  $R_1$  is  $v_s/R_1$ , while that traveling west through  $R_f$  is  $v_o/R_f$ . Since their sum is zero, we have

$$\frac{v_o}{v_s} = -\frac{R_f}{R_1}$$

Thus, we can design for a gain of  $-9$  by setting  $R_f = 90$  k $\Omega$  and  $R_1 = 10$  k $\Omega$ , for example.

If we let  $R$  be 1 M $\Omega$  and  $C$  be 1  $\mu$ F in each of the integrators, then

$$v_o = -\int_0^t v_s dt' + v_o(0)$$

in each case. The output of the inverting amplifier now forms the assumed input at point  $A$ , leading to the configuration of op amps shown in Fig. 9.36. If the left switch is closed at  $t = 0$  while the two initial-condition switches are opened at the same time, the output of the second integrator will be the undamped sine wave  $v = 2 \sin 3t$  V.

Note that both the  $LC$  circuit of Fig. 9.34 and the op amp circuit of Fig. 9.36 have the same output, but the op amp circuit does not contain a

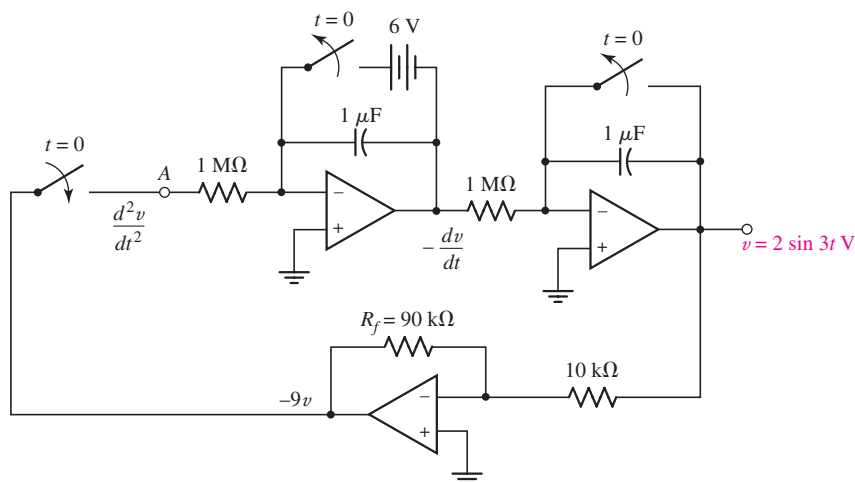

■ FIGURE 9.36 Two integrators and an inverting amplifier are connected to provide the solution of the differential equation  $d^2v/dt^2 = -9v$ .



single inductor. It simply *acts* as though it contained an inductor, providing the appropriate sinusoidal voltage between its output terminal and ground. This can be a considerable practical or economic advantage in circuit design, as inductors are typically bulky, more costly than capacitors, and have more losses associated with them (and therefore are not as well approximated by the “ideal” model).

### PRACTICE

9.11 Give new values for  $R_f$  and the two initial voltages in the circuit of Fig. 9.36 if the output represents the voltage  $v(t)$  in the circuit of Fig. 9.37.

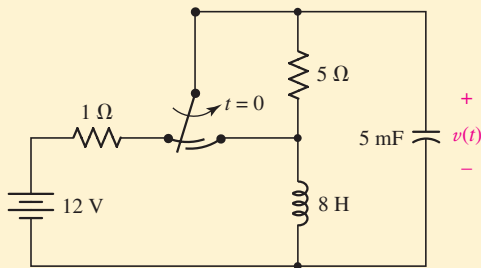

FIGURE 9.37

Ans: 250 k $\Omega$ ; 400 V; 10 V.

## SUMMARY AND REVIEW

The simple  $RL$  and  $RC$  circuits examined in Chap. 8 essentially did one of two things as the result of throwing a switch: *charge* or *discharge*. Which one happened was determined by the initial charge state of the energy storage element. In this chapter, we considered circuits that had two energy storage elements (a capacitor and an inductor), and found that things could get pretty interesting. There are two basic configurations of such  $RLC$  circuits: *parallel* connected and *series* connected. Analysis of such a circuit yields a *second-order* partial differential equation, consistent with the number of distinct energy storage elements (if we construct a circuit using only resistors and capacitors such that the capacitors cannot be combined using series/parallel techniques, we also obtain—eventually—a second-order partial differential equation).

Depending on the value of the resistance connected to our energy storage elements, we found the transient response of an  $RLC$  circuit could be either *overdamped* (decaying exponentially) or *underdamped* (decaying, but oscillatory), with a “special case” of *critically damped* which is difficult to achieve in practice. Oscillations can be useful (for example, in transmitting information over a wireless network) and not so useful (for example, in accidental feedback situations between an amplifier and a microphone at a concert). Although the oscillations are not sustained in the circuits we examined, we have at least seen one way to create them at will,

and design for a specific frequency of operation if so desired. We didn't end up spending a great deal of time with the series connected *RLC* circuit because with the exception of  $\alpha$ , the equations are the same; only a minor adjustment in how we employ initial conditions to find the two unknown constants characterizing the transient response is needed. Along those lines, there were two "tricks," if you will, that we encountered. One is that to employ the second initial condition, we need to take the derivative of our response equation. The second is that whether we're employing KCL or KVL to make use of that initial condition, we're doing so at the instant that  $t = 0$ ; appreciating this fact can simplify equations dramatically by setting  $t = 0$  early.

We wrapped up the chapter by considering the *complete response*, and our approach to this did not differ significantly from what we did in Chap. 8. We closed with a brief section on a topic that might have occurred to us at some point—what happens when we remove the resistive losses completely (by setting parallel resistance to  $\infty$ , or series resistance to 0)? We end up with an *LC* circuit, and we saw that we can approximate such an animal with an op amp circuit.

By now the reader is likely ready to finish reviewing key concepts of the chapter, so we'll stop here and list them, along with corresponding examples in the text.

- Circuits that contain two energy storage devices that cannot be combined using series-parallel combination techniques are described by a second-order differential equation.
- Series and parallel *RLC* circuits fall into one of three categories, depending on the relative values of  $R$ ,  $L$ , and  $C$ :

Overdamped	$\alpha > \omega_0$
Critically damped	$\alpha = \omega_0$
Underdamped	$\alpha < \omega_0$

(Example 9.1)

- For series *RLC* circuits,  $\alpha = R/2L$  and  $\omega_0 = 1/\sqrt{LC}$ . (Example 9.7)
- For parallel *RLC* circuits,  $\alpha = 1/2RC$  and  $\omega_0 = 1/\sqrt{LC}$ . (Example 9.1)
- The typical form of an overdamped response is the sum of two exponential terms, one of which decays more quickly than the other: e.g.,  $A_1e^{-t} + A_2e^{-6t}$ . (Examples 9.2, 9.3, 9.4)
- The typical form of a critically damped response is  $e^{-\alpha t}(A_1t + A_2)$ . (Example 9.5)
- The typical form of an underdamped response is an exponentially damped sinusoid:  $e^{-\alpha t}(B_1 \cos \omega_d t + B_2 \sin \omega_d t)$ . (Examples 9.6, 9.7, 9.8)
- During the transient response of an *RLC* circuit, energy is transferred between energy storage elements to the extent allowed by the resistive component of the circuit, which acts to dissipate the energy initially stored. (See Computer-Aided Analysis section.)
- The complete response is the sum of the forced and natural responses. In this case the total response must be determined before solving for the constants. (Examples 9.9, 9.10)

## READING FURTHER

An excellent discussion of employing PSpice in the modeling of automotive suspension systems can be found in

R.W. Goody, *MicroSim PSpice for Windows*, vol. I, 2nd ed. Englewood Cliffs, N.J.: Prentice-Hall, 1998.

Many detailed descriptions of analogous networks can be found in Chap. 3 of

E. Weber, *Linear Transient Analysis Volume I*. New York: Wiley, 1954. (Out of print, but in many university libraries.)

## EXERCISES

### 9.1 The Source-Free Parallel Circuit

- For a certain source-free parallel  $RLC$  circuit,  $R = 1 \text{ k}\Omega$ ,  $C = 3 \text{ }\mu\text{F}$ , and  $L$  is such that the circuit response is overdamped. (a) Determine the value of  $L$ . (b) Write the equation for the voltage  $v$  across the resistor if it is known that  $v(0^-) = 9 \text{ V}$  and  $dv/dt|_{t=0^+} = 2 \text{ V/s}$ .
- Element values of  $10 \text{ mF}$  and  $2 \text{ nH}$  are employed in the construction of a simple source-free parallel  $RLC$  circuit. (a) Select  $R$  so that the circuit is just barely overdamped. (b) Write the equation for the resistor current if its initial value is  $i_R(0^+) = 13 \text{ pA}$  and  $di_E/dt|_{t=0^+} = 1 \text{ nA/s}$ .
- If a parallel  $RLC$  circuit is constructed from component values  $C = 16 \text{ mF}$  and  $L = 1 \text{ mH}$ , choose  $R$  such that the circuit is (a) just barely overdamped; (b) just barely underdamped; (c) critically damped. (d) Does your answer for part (a) change if the resistor tolerance is 1%? 10%? (e) Increase the exponential damping coefficient for part (c) by 20%. Is the circuit now underdamped, overdamped, or still critically damped? *Explain*.
- Calculate  $\alpha$ ,  $\omega_0$ ,  $s_1$ , and  $s_2$  for a source-free parallel  $RLC$  circuit if (a)  $R = 4 \text{ }\Omega$ ,  $L = 2.22 \text{ H}$ , and  $C = 12.5 \text{ mF}$ ; (b)  $L = 1 \text{ nH}$ ,  $C = 1 \text{ pF}$ , and  $R$  is 1% of the value required to make the circuit underdamped. (c) Calculate the damping ratio for the circuits of parts (a) and (b).
- You go to construct the circuit in Exercise 1, only to find no  $1 \text{ k}\Omega$  resistors. In fact, all you are able to locate in addition to the capacitor and inductor is a 1 meter long piece of 24 AWG soft solid copper wire. Connecting it in parallel to the two components you did find, compute the value of  $\alpha$ ,  $\omega_0$ ,  $s_1$ , and  $s_2$ , and verify that the circuit is still overdamped.
- Consider a source-free parallel  $RLC$  circuit having  $\alpha = 10^8 \text{ s}^{-1}$ ,  $\omega_0 = 10^3 \text{ rad/s}$ , and  $\omega_0 L = 5 \text{ }\Omega$ . (a) Show that the stated units of  $\omega_0 L$  are correct. (b) Compute  $s_1$  and  $s_2$ . (c) Write the general form of the natural response for the capacitor voltage. (d) By appropriate substitution, verify that your answer to part (c) is indeed a solution to Eq. [1] if the inductor and capacitor each initially store  $1 \text{ mJ}$  of energy, respectively.
- A parallel  $RLC$  circuit is constructed with  $R = 500 \text{ }\Omega$ ,  $C = 10 \text{ }\mu\text{F}$ , and  $L$  such that it is critically damped. (a) Determine  $L$ . Is this value large or small for a printed-circuit board mounted component? (b) Add a resistor in parallel to the existing components such that the damping ratio is equal to 10. (c) Does increasing the damping ratio further lead to an overdamped, critically damped, or underdamped circuit? *Explain*.

### 9.2 The Overdamped Parallel $RLC$ Circuit

- The circuit of Fig. 9.2 is modified substantially, with the resistor being replaced with a  $1 \text{ k}\Omega$  resistor, the inductor swapped out for a smaller  $7 \text{ mH}$  version, the capacitor replaced with a  $1 \text{ nF}$  alternative, and now the inductor is initially discharged while the capacitor is storing  $7.2 \text{ mJ}$ . (a) Compute  $\alpha$ ,  $\omega_0$ ,  $s_1$ , and  $s_2$ , and verify that the circuit is still overdamped. (b) Obtain an expression

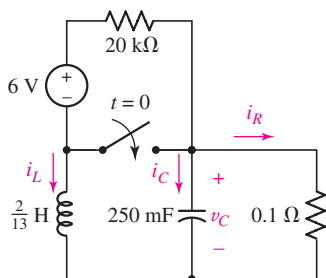

■ FIGURE 9.38

- for the current flowing through the resistor which is valid for  $t > 0$ . (c) Calculate the magnitude of the resistor current at  $t = 10 \mu\text{s}$ .
9. The voltage across a capacitor is found to be given by  $v_C(t) = 10e^{-10t} - 5e^{-4t} \text{ V}$ . (a) Sketch each of the two components over the range of  $0 \leq t \leq 1.5 \text{ s}$ . (b) Graph the capacitor voltage over the same time range.
10. The current flowing through a certain inductor is found to be given by  $i_L(t) = 0.20e^{-2t} - 0.6e^{-3t} \text{ V}$ . (a) Sketch each of the two components over the range of  $0 \leq t \leq 1.5 \text{ s}$ . (b) Graph the inductor current over the same time range. (c) Graph the energy remaining in the inductor over  $0 \leq t \leq 1.5 \text{ s}$ .
11. The current flowing through a  $5 \Omega$  resistor in a source-free parallel RLC circuit is determined to be  $i_R(t) = 2e^{-t} - 3e^{-8t} \text{ V}$ ,  $t > 0$ . Determine (a) the maximum current and the time at which it occurs; (b) the settling time; (c) the time  $t$  corresponding to the resistor absorbing  $2.5 \text{ W}$  of power.
12. For the circuit of Fig. 9.38, obtain an expression for  $v_C(t)$  valid for all  $t > 0$ .
13. Consider the circuit depicted in Fig. 9.38. (a) Obtain an expression for  $i_L(t)$  valid for all  $t > 0$ . (b) Obtain an expression for  $i_R(t)$  valid for all  $t > 0$ . (c) Determine the settling time for both  $i_L$  and  $i_R$ .
14. With regard to the circuit represented in Fig. 9.39, determine (a)  $i_C(0^-)$ ; (b)  $i_L(0^-)$ ; (c)  $i_R(0^-)$ ; (d)  $v_C(0^-)$ ; (e)  $i_C(0^+)$ ; (f)  $i_L(0^+)$ ; (g)  $i_R(0^+)$ ; (h)  $v_C(0^+)$ .

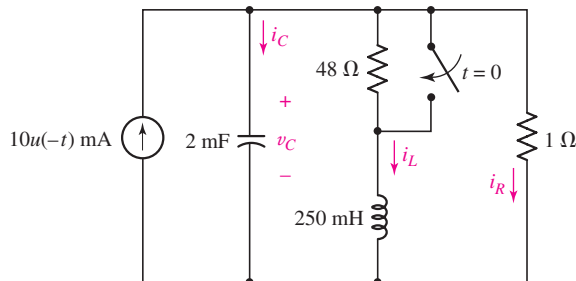

■ FIGURE 9.39

15. (a) Assuming the passive sign convention, obtain an expression for the voltage across the  $1 \Omega$  resistor in the circuit of Fig. 9.39 which is valid for all  $t > 0$ . (b) Determine the settling time of the resistor voltage.
16. With regard to the circuit presented in Fig. 9.40, (a) obtain an expression for  $v(t)$  which is valid for all  $t > 0$ ; (b) calculate the maximum inductor current and identify the time at which it occurs; (c) determine the settling time.

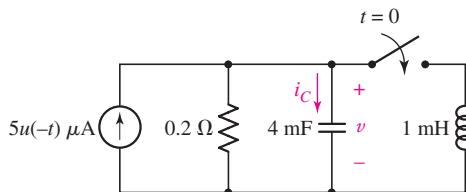

■ FIGURE 9.40

17. Obtain expressions for the current  $i(t)$  and voltage  $v(t)$  as labeled in the circuit of Fig. 9.41 which are valid for all  $t > 0$ .

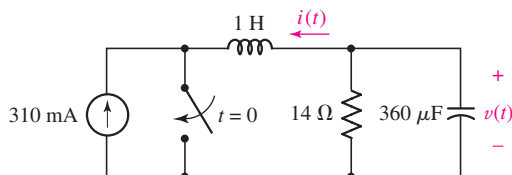

■ FIGURE 9.41



18. Replace the  $14\ \Omega$  resistor in the circuit of Fig. 9.41 with a  $1\ \Omega$  resistor. (a) Obtain an expression for the energy stored in the capacitor as a function of time, valid for  $t > 0$ . (b) Determine the time at which the energy in the capacitor has been reduced to one-half its maximum value. (c) Verify your answer with an appropriate PSpice simulation.



19. Design a complete source-free parallel  $RLC$  circuit which exhibits an overdamped response, has a settling time of 1 s, and has a damping ratio of 15.
20. For the circuit represented by Fig. 9.42, the two resistor values are  $R_1 = 0.752\ \Omega$  and  $R_2 = 1.268\ \Omega$ , respectively. (a) Obtain an expression for the energy stored in the capacitor, valid for all  $t > 0$ ; (b) determine the settling time of the current labeled  $i_A$ .

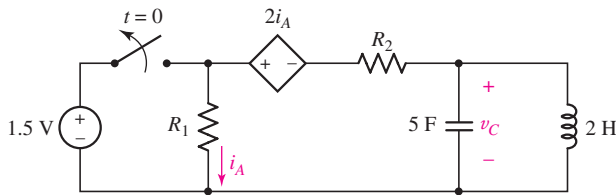

■ FIGURE 9.42

### 9.3 Critical Damping

21. A motor coil having an inductance of 8 H is in parallel with a  $2\ \mu\text{F}$  capacitor and a resistor of unknown value. The response of the parallel combination is determined to be critically damped. (a) Determine the value of the resistor. (b) Compute  $\alpha$ . (c) Write the equation for the current flowing into the resistor if the top node is labeled  $v$ , the bottom node is grounded, and  $v = Ri_r$ . (d) Verify that your equation is a solution to the circuit differential equation,

$$\frac{di_r}{dt} + 2\alpha \frac{di_r}{dt} + \alpha^2 i_r = 0$$

22. The condition for critical damping in an  $RLC$  circuit is that the resonant frequency  $\omega_0$  and the exponential damping factor  $\alpha$  are equal. This leads to the relationship  $L = 4R^2C$ , which implies that  $1\ \text{H} = 1\ \Omega^2 \cdot \text{F}$ . Verify this equivalence by breaking down each of the three units to fundamental SI units (see Chap. 2).
23. A critically damped parallel  $RLC$  circuit is constructed from component values  $40\ \Omega$ ,  $8\ \text{nF}$ , and  $51.2\ \mu\text{H}$ , respectively. (a) Verify that the circuit is indeed critically damped. (b) Explain why, in practice, the circuit once fabricated is unlikely to be truly critically damped. (c) The inductor initially stores 1 mJ of energy while the capacitor is initially discharged. Determine the magnitude of the capacitor voltage at  $t = 500\ \text{ns}$ , the maximum absolute capacitor voltage, and the settling time.



24. Design a complete (i.e., with all necessary switches or step function sources) parallel  $RLC$  circuit which has a critically damped response such that the capacitor voltage at  $t = 1\ \text{s}$  is equal to 9 V and the circuit is source-free for all  $t > 0$ .
25. A critically damped parallel  $RLC$  circuit is constructed from component values  $40\ \Omega$  and  $2\ \text{pF}$ . (a) Determine the value of  $L$ , taking care not to overround. (b) Explain why, in practice, the circuit once fabricated is unlikely to be truly critically damped. (c) The inductor initially stores no energy while the capacitor is initially storing 10 pJ. Determine the power absorbed by the resistor at  $t = 2\ \text{ns}$ , the maximum absolute inductor current  $|i_L|$ , and the settling time.

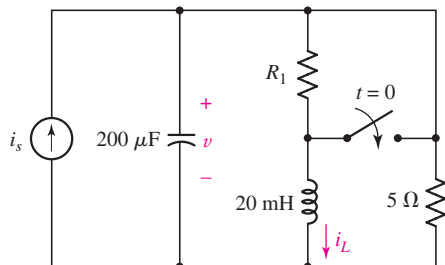

■ FIGURE 9.43

26. For the circuit of Fig. 9.43,  $i_s(t) = 30u(-t)$  mA. (a) Select  $R_1$  so that  $v(0^+) = 6$  V. (b) Compute  $v(2$  ms). (c) Determine the settling time of the capacitor voltage. (d) Is the inductor current settling time the same as your answer to part (c)?
27. The current source in Fig. 9.43 is  $i_s(t) = 10u(1 - t)$   $\mu$ A. (a) Select  $R_1$  such that  $i_L(0^+) = 2$   $\mu$ A. Compute  $i_L$  at  $t = 500$  ms and  $t = 1.002$  ms.
28. The inductor in the circuit of Fig. 9.41 is changed such that the circuit response is now critically damped. (a) Determine the new inductor value. (b) Calculate the energy stored in both the inductor and the capacitor at  $t = 10$  ms.
29. The circuit of Fig. 9.42 is rebuilt such that the quantity controlling the dependent source is now  $100i_A$ , a  $2$   $\mu$ F capacitor is used instead, and  $R_1 = R_2 = 10$   $\Omega$ . (a) Calculate the inductor value required to obtain a critically damped response. (b) Determine the power being absorbed by  $R_2$  at  $t = 300$   $\mu$ s.

### 9.4 The Underdamped Parallel RLC Circuit

30. (a) With respect to the parallel RLC circuit, derive an expression for  $R$  in terms of  $C$  and  $L$  to ensure the response is underdamped. (b) If  $C = 1$  nF and  $L = 10$  mH, select  $R$  such that an underdamped response is (just barely) achieved. (c) If the damping ratio is increased, does the circuit become more or less underdamped? *Explain.* (d) Compute  $\alpha$  and  $\omega_d$  for the value of  $R$  you selected in part (b).
31. The circuit of Fig. 9.1 is constructed using component values  $10$  k $\Omega$ ,  $72$   $\mu$ H, and  $18$  pF. (a) Compute  $\alpha$ ,  $\omega_d$ , and  $\omega_0$ . Is the circuit overdamped, critically damped, or underdamped? (b) Write the form of the natural capacitor voltage response  $v(t)$ . (c) If the capacitor initially stores  $1$  nJ of energy, compute  $v$  at  $t = 300$  ns.
32. The source-free circuit depicted in Fig. 9.1 is constructed using a  $10$  mH inductor, a  $1$  mF capacitor, and a  $1.5$  k $\Omega$  resistor. (a) Calculate  $\alpha$ ,  $\omega_d$ , and  $\omega_0$ . (b) Write the equation which describes the current  $i$  for  $t > 0$ . (c) Determine the maximum value of  $i$ , and the time at which it occurs, if the inductor initially stores no energy and  $v(0^-) = 9$  V.
33. (a) Graph the current  $i$  for the circuit described in Exercise 32 for resistor values  $1.5$  k $\Omega$ ,  $15$  k $\Omega$ , and  $150$  k $\Omega$ . Make three separate graphs and be sure to extend the corresponding time axis to  $6\pi/\omega_d$  in each case. (b) Determine the corresponding settling times.
-  34. Analyze the circuit described in Exercise 32 to find  $v(t)$ ,  $t > 0$ , if  $R$  is equal to (a)  $2$  k $\Omega$ ; (b)  $2$   $\Omega$ . (c) Graph both responses over the range of  $0 \leq t \leq 60$  ms. (d) Verify your answers with appropriate PSpice simulations.
35. For the circuit of Fig. 9.44, determine (a)  $i_C(0^-)$ ; (b)  $i_L(0^-)$ ; (c)  $i_R(0^-)$ ; (d)  $v_C(0^-)$ ; (e)  $i_C(0^+)$ ; (f)  $i_L(0^+)$ ; (g)  $i_R(0^+)$ ; (h)  $v_C(0^+)$ .

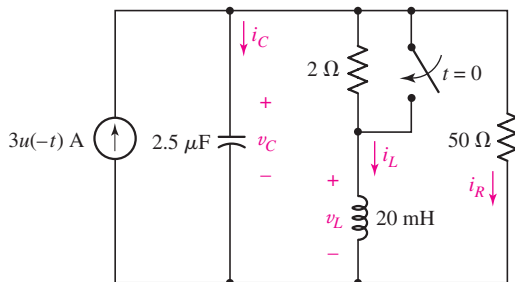

■ FIGURE 9.44

36. Obtain an expression for  $v_L(t)$ ,  $t > 0$ , for the circuit shown in Fig. 9.44. Plot the waveform for at least two periods of oscillation.



37. For the circuit of Fig. 9.45, determine (a) the first time  $t > 0$  when  $v(t) = 0$ ; (b) the settling time.

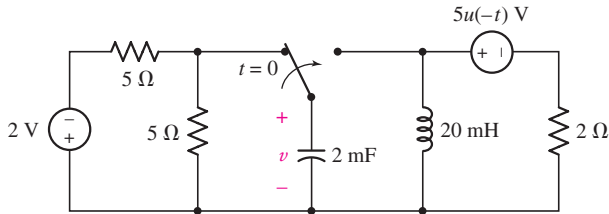

■ FIGURE 9.45

38. (a) Design a parallel  $RLC$  circuit that provides a capacitor voltage which oscillates with a frequency of 100 rad/s, with a maximum value of 10 V occurring at  $t = 0$ , and the second and third maxima both in excess of 6 V. (b) Verify your design with an appropriate PSpice simulation.
39. The circuit depicted in Fig. 9.46 is just barely underdamped. (a) Compute  $\alpha$  and  $\omega_d$ . (b) Obtain an expression for  $i_L(t)$  valid for  $t > 0$ . (c) Determine how much energy is stored in the capacitor, and in the inductor, at  $t = 200$  ms.

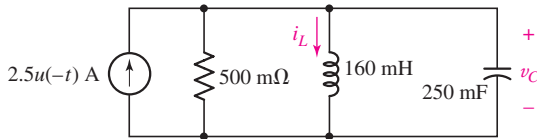

■ FIGURE 9.46

40. When constructing the circuit of Fig. 9.46, you inadvertently install a 500 M $\Omega$  resistor by mistake. (a) Compute  $\alpha$  and  $\omega_d$ . (b) Obtain an expression for  $i_L(t)$  valid for  $t > 0$ . (c) Determine how long it takes for the energy stored in the inductor to reach 10% of its maximum value.

### 9.5 The Source-Free Series $RLC$ Circuit

41. The circuit of Fig. 9.21a is constructed with a 160 mF capacitor and a 250 mH inductor. Determine the value of  $R$  needed to obtain (a) a critically damped response; (b) a “just barely” underdamped response. (c) Compare your answers to parts (a) and (b) if the circuit was a parallel  $RLC$  circuit.
42. Component values of  $R = 2 \Omega$ ,  $C = 1$  mF, and  $L = 2$  mH are used to construct the circuit represented in Fig. 9.21a. If  $v_C(0^-) = 1$  V and no current initially flows through the inductor, calculate  $i(t)$  at  $t = 1$  ms, 2 ms, and 3 ms.
43. The series  $RLC$  circuit described in Exercise 42 is modified slightly by adding a 2  $\Omega$  resistor in parallel to the existing resistor. The initial capacitor voltage remains 1 V, and there is still no current flowing in the inductor prior to  $t = 0$ . (a) Calculate  $v_C(t)$  at 4 ms. (b) Sketch  $v_C(t)$  over the interval  $0 \leq t \leq 10$  s.
44. The simple three-element series  $RLC$  circuit of Exercise 42 is constructed with the same component values, but the initial capacitor voltage  $v_C(0^-) = 2$  V and the initial inductor current  $i(0^-) = 1$  mA. (a) Obtain an expression for  $i(t)$  valid for all  $t > 0$ . (b) Verify your solution with an appropriate simulation.
45. The series  $RLC$  circuit of Fig. 9.22 is constructed using  $R = 1$  k $\Omega$ ,  $C = 2$  mF, and  $L = 1$  mH. The initial capacitor voltage  $v_C$  is  $-4$  V at  $t = 0^-$ . There is no current initially flowing through the inductor. (a) Obtain an expression for  $v_C(t)$  valid for  $t > 0$ . (b) Sketch over  $0 \leq t \leq 6 \mu\text{s}$ .

46. With reference to the circuit depicted in Fig. 9.47, calculate (a)  $\alpha$ ; (b)  $\omega_0$ ; (c)  $i(0^+)$ ; (d)  $di/dt|_{0^+}$ ; (e)  $i(t)$  at  $t = 6$  s.

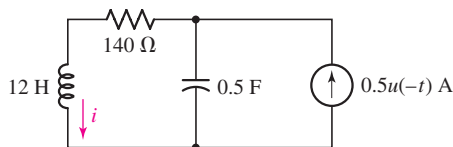

■ FIGURE 9.47

47. Obtain an equation for  $v_C$  as labeled in the circuit of Fig. 9.48 valid for all  $t > 0$ .

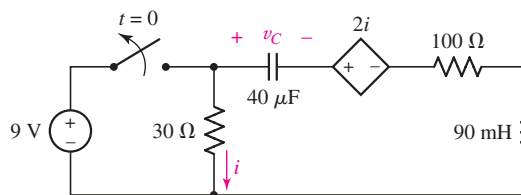

■ FIGURE 9.48



48. With reference to the series RLC circuit of Fig. 9.48, (a) obtain an expression for  $i$ , valid for  $t > 0$ ; (b) calculate  $i(0.8$  ms) and  $i(4$  ms); (c) verify your answers to part (b) with an appropriate PSpice simulation.
49. Obtain an expression for  $i_1$  as labeled in Fig. 9.49 which is valid for all  $t > 0$ .

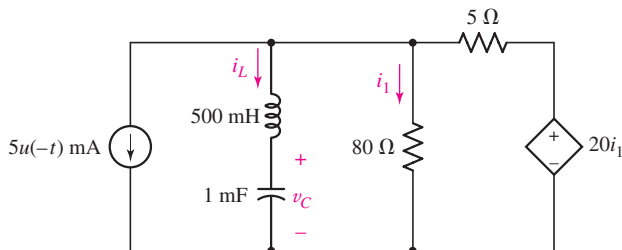

■ FIGURE 9.49

## 9.6 The Complete Response of the RLC Circuit

50. In the series circuit of Fig. 9.50, set  $R = 1 \Omega$ . (a) Compute  $\alpha$  and  $\omega_0$ . (b) If  $i_s = 3u(-t) + 2u(t)$  mA, determine  $v_R(0^-)$ ,  $i_L(0^-)$ ,  $v_C(0^-)$ ,  $v_R(0^+)$ ,  $i_L(0^+)$ ,  $v_C(0^+)$ ,  $i_L(\infty)$ , and  $v_C(\infty)$ .

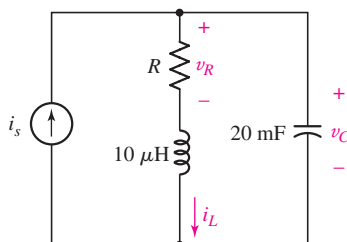

■ FIGURE 9.50

51. Evaluate the derivative of each current and voltage variable labeled in Fig. 9.51 at  $t = 0^+$ .

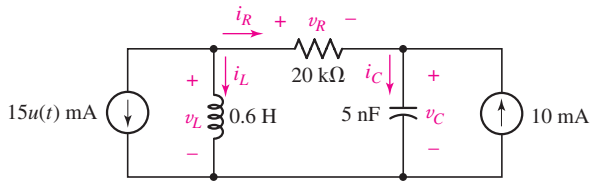

■ FIGURE 9.51

52. Consider the circuit depicted in Fig. 9.52. If  $v_s(t) = -8 + 2u(t)$  V, determine (a)  $v_C(0^+)$ ; (b)  $i_L(0^+)$ ; (c)  $v_C(\infty)$ ; (d)  $v_C(t = 150 \text{ ms})$ .
53. The  $15 \Omega$  resistor in the circuit of Fig. 9.52 is replaced with a  $500 \text{ m}\Omega$  alternative. If the source voltage is given by  $v_s = 1 - 2u(t)$  V, determine (a)  $i_L(0^+)$ ; (b)  $v_C(0^+)$ ; (c)  $i_L(\infty)$ ; (d)  $v_C(4 \text{ ms})$ .
54. In the circuit shown in Fig. 9.53, obtain an expression for  $i_L$  valid for all  $t > 0$  if  $i_1 = 8 - 10u(t)$  mA.
55. The  $10 \Omega$  resistor in the series  $RLC$  circuit of Fig. 9.53 is replaced with a  $1 \text{ k}\Omega$  resistor. The source  $i_1 = 5u(t) - 4 \text{ mA}$ . Obtain an expression for  $i_L$  valid for all  $t > 0$ .
56. For the circuit represented in Fig. 9.54, (a) obtain an expression for  $v_C(t)$  valid for all  $t > 0$ . (b) Determine  $v_C$  at  $t = 10 \text{ ms}$  and  $t = 600 \text{ ms}$ . (c) Verify your answers to part (b) with an appropriate PSpice simulation.

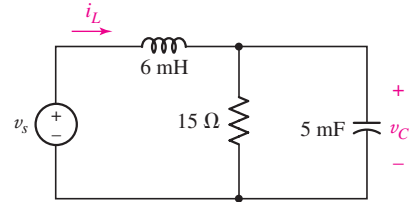

■ FIGURE 9.52

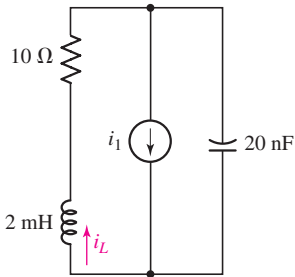

■ FIGURE 9.53

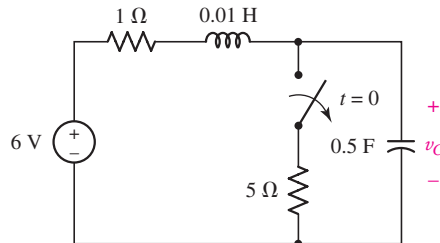

■ FIGURE 9.54

57. Replace the  $1 \Omega$  resistor in Fig. 9.54 with a  $100 \text{ m}\Omega$  resistor, and the  $5 \Omega$  resistor with a  $200 \text{ m}\Omega$  resistor. Assuming the passive sign convention, obtain an expression for the capacitor current which is valid for  $t > 0$ .
58. With regard to the circuit of Fig. 9.55, obtain an expression for  $v_C$  valid for  $t \geq 0$  if  $i_s(t) = 3u(-t) + 5u(t)$  mA.
59. (a) Adjust the value of the  $3 \Omega$  resistor in the circuit represented in Fig. 9.55 to obtain a “just barely” overdamped response. (b) Determine the first instant ( $t > 0$ ) at which an equal (and nonzero) amount of energy is stored in the capacitor and the inductor if  $i_s(t) = 2u(t)$  A. (c) Calculate the corresponding energy. (d) At what subsequent time will the energy stored in the inductor be twice that stored in the capacitor at the same instant?

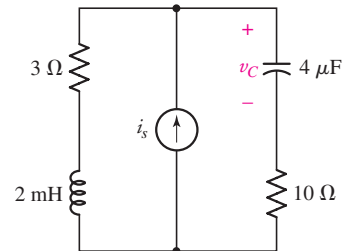

■ FIGURE 9.55

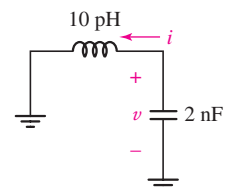

■ FIGURE 9.56

## 9.7 The Lossless LC Circuit



60. Design an op amp circuit to model the voltage response of the  $LC$  circuit shown in Fig. 9.56. Verify your design by simulating both the circuit of Fig. 9.56 and your circuit using an LF 411 op amp, assuming  $v(0) = 0$  and  $i(0) = 1 \text{ mA}$ .



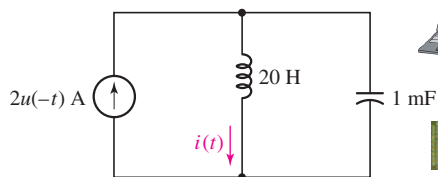

■ FIGURE 9.57



61. Refer to Fig. 9.57, and design an op amp circuit whose output will be  $i(t)$  for  $t > 0$ .



62. Replace the capacitor in the circuit of Fig. 9.56 with a 20 H inductor in parallel with a  $5 \mu\text{F}$  capacitor. Design an op amp circuit whose output will be  $i(t)$  for  $t > 0$ . Verify your design by simulating both the capacitor-inductor circuit and your op amp circuit. Use an LM111 op amp in the PSpice simulation.



63. A source-free  $RC$  circuit is constructed using a  $1 \text{ k}\Omega$  resistor and a  $3.3 \text{ mF}$  capacitor. The initial voltage across the capacitor is  $1.2 \text{ V}$ . (a) Write the differential equation for  $v$ , the voltage across the capacitor, for  $t > 0$ . (b) Design an op amp circuit that provides  $v(t)$  as the output.

64. A source-free  $RL$  circuit contains a  $20 \Omega$  resistor and a  $5 \text{ H}$  inductor. If the initial value of the inductor current is  $2 \text{ A}$ : (a) write the differential equation for  $i$  for  $t > 0$ , and (b) design an op amp integrator to provide  $i(t)$  as the output, using  $R_1 = 1 \text{ M}\Omega$  and  $C_f = 1 \mu\text{F}$ .

### Chapter-Integrating Exercises

65. The capacitor in the circuit of Fig. 9.58 is set to  $1 \text{ F}$ . Determine  $v_C(t)$  at (a)  $t = -1 \text{ s}$ ; (b)  $t = 0^+$ ; (c)  $t = 20 \text{ s}$ .

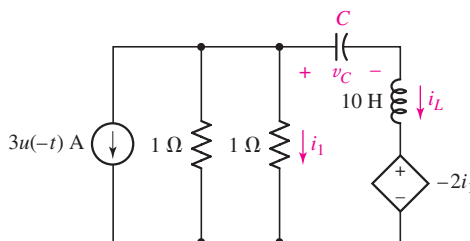

■ FIGURE 9.58

66. (a) What value of  $C$  for the circuit of Fig. 9.59 will result in an overdamped response? (b) Set  $C = 1 \text{ F}$  and obtain an expression for  $i_L(t)$  valid for  $t > 0$ .

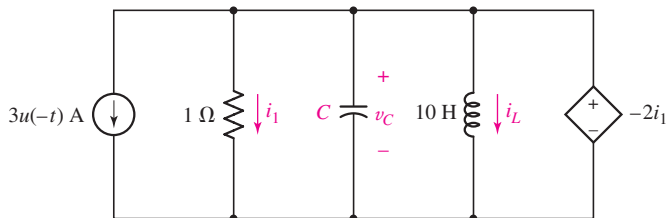

■ FIGURE 9.59

67. Obtain an expression for the current labeled  $i_1$  in the circuit of Fig. 9.58 which is valid for  $t > 0$ , if the current source is replaced with a source  $5u(t + 1) \text{ A}$ .



68. Design a parallel  $RLC$  circuit which produces an exponentially damped sinusoidal pulse with a peak voltage of  $1.5 \text{ V}$  and at least two additional peaks with voltage magnitude greater than  $0.8 \text{ V}$ . Verify your design with an appropriate PSpice simulation.



69. Design a series  $RLC$  circuit which produces an exponentially damped sinusoidal pulse with a peak voltage of  $1.5 \text{ V}$  and at least two additional peaks with voltage magnitude greater than  $0.8 \text{ V}$ . Verify your design with an appropriate PSpice simulation.

# Sinusoidal Steady-State Analysis

## INTRODUCTION

The complete response of a linear electric circuit is composed of two parts, the *natural* response and the *forced* response. The natural response is the short-lived transient response of a circuit to a sudden change in its condition. The forced response is the long-term steady-state response of a circuit to any independent sources present. Up to this point, the only forced response we have considered is that due to dc sources. Another very common forcing function is the sinusoidal waveform. This function describes the voltage available at household electrical sockets as well as the voltage of power lines connected to residential and industrial areas.

In this chapter, we assume that the transient response is of little interest, and the steady-state response of a circuit (a television set, a toaster, or a power distribution network) to a sinusoidal voltage or current is needed. We will analyze such circuits using a powerful technique that transforms integrodifferential equations into algebraic equations. Before we see how that works, it's useful to quickly review a few important attributes of general sinusoids, which will describe pretty much all currents and voltages throughout the chapter.

## 10.1 CHARACTERISTICS OF SINUSOIDS

Consider a sinusoidally varying voltage

$$v(t) = V_m \sin \omega t$$

shown graphically in Figs. 10.1a and b. The *amplitude* of the sine wave is  $V_m$ , and the *argument* is  $\omega t$ . The *radian frequency*, or *angular frequency*, is  $\omega$ . In Fig. 10.1a,  $V_m \sin \omega t$  is plotted as a function of the argument  $\omega t$ , and the periodic nature of the sine wave is evident.

## KEY CONCEPTS

Characteristics of Sinusoidal Functions

Phasor Representation of Sinusoids

Converting Between the Time and Frequency Domains

Impedance and Admittance

Reactance and Susceptance

Parallel and Series Combinations in the Frequency Domain

Determination of Forced Response Using Phasors

Application of Circuit Analysis Techniques in the Frequency Domain



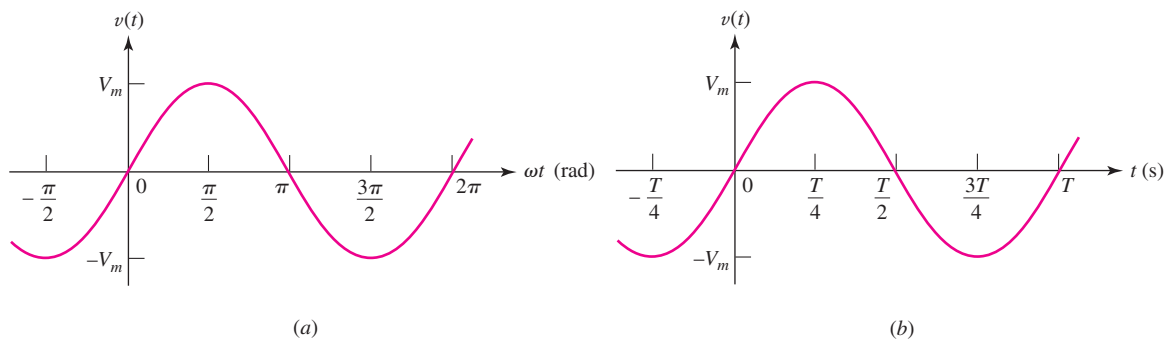

■ FIGURE 10.1 The sinusoidal function  $v(t) = V_m \sin \omega t$  is plotted (a) versus  $\omega t$  and (b) versus  $t$ .

The function repeats itself every  $2\pi$  radians, and its **period** is therefore  $2\pi$  radians. In Fig. 10.1b,  $V_m \sin \omega t$  is plotted as a function of  $t$  and the **period** is now  $T$ . A sine wave having a period  $T$  must execute  $1/T$  periods each second; its **frequency**  $f$  is  $1/T$  hertz, abbreviated Hz. Thus,

$$f = \frac{1}{T}$$

and since

$$\omega T = 2\pi$$

we obtain the common relationship between frequency and radian frequency,

$$\omega = 2\pi f$$

## Lagging and Leading

A more general form of the sinusoid,

$$v(t) = V_m \sin(\omega t + \theta) \quad [1]$$

includes a **phase angle**  $\theta$  in its argument. Equation [1] is plotted in Fig. 10.2 as a function of  $\omega t$ , and the phase angle appears as the number of radians by which the original sine wave (shown in green color in the sketch) is shifted to the left, or earlier in time. Since corresponding points on the sinusoid  $V_m \sin(\omega t + \theta)$  occur  $\theta$  rad, or  $\theta/\omega$  seconds, earlier, we say that  $V_m \sin(\omega t + \theta)$  **leads**  $V_m \sin \omega t$  by  $\theta$  rad. Therefore, it is correct to describe

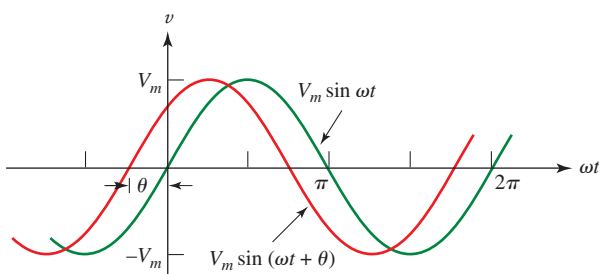

■ FIGURE 10.2 The sine wave  $V_m \sin(\omega t + \theta)$  leads  $V_m \sin \omega t$  by  $\theta$  rad.

$\sin \omega t$  as **lagging**  $\sin(\omega t + \theta)$  by  $\theta$  rad, as **leading**  $\sin(\omega t + \theta)$  by  $-\theta$  rad, or as leading  $\sin(\omega t - \theta)$  by  $\theta$  rad.

In either case, leading or lagging, we say that the sinusoids are *out of phase*. If the phase angles are equal, the sinusoids are said to be *in phase*.

In electrical engineering, the phase angle is commonly given in degrees, rather than radians; to avoid confusion we should be sure to always use the degree symbol. Thus, instead of writing

$$v = 100 \sin\left(2\pi 1000t - \frac{\pi}{6}\right)$$

we customarily use

$$v = 100 \sin(2\pi 1000t - 30^\circ)$$

In evaluating this expression at a specific instant of time, e.g.,  $t = 10^{-4}$  s,  $2\pi 1000t$  becomes  $0.2\pi$  *radian*, and this should be expressed as  $36^\circ$  before  $30^\circ$  is subtracted from it. Don't confuse your apples with your oranges.

*Two sinusoidal waves whose phases are to be compared must:*

1. Both be written as sine waves, or both as cosine waves.
2. Both be written with positive amplitudes.
3. Each have the same frequency.

## Converting Sines to Cosines

The sine and cosine are essentially the same function, but with a  $90^\circ$  phase difference. Thus,  $\sin \omega t = \cos(\omega t - 90^\circ)$ . Multiples of  $360^\circ$  may be added to or subtracted from the argument of any sinusoidal function without changing the value of the function. Hence, we may say that

$$\begin{aligned} v_1 &= V_{m_1} \cos(5t + 10^\circ) \\ &= V_{m_1} \sin(5t + 90^\circ + 10^\circ) \\ &= V_{m_1} \sin(5t + 100^\circ) \end{aligned}$$

*leads*

$$v_2 = V_{m_2} \sin(5t - 30^\circ)$$

by  $130^\circ$ . It is also correct to say that  $v_1$  *lags*  $v_2$  by  $230^\circ$ , since  $v_1$  may be written as

$$v_1 = V_{m_1} \sin(5t - 260^\circ)$$

We assume that  $V_{m_1}$  and  $V_{m_2}$  are both positive quantities. A graphical representation is provided in Fig. 10.3; note that the frequency of both sinusoids (5 rad/s in this case) must be the same, or the comparison is meaningless. Normally, the difference in phase between two sinusoids is expressed by that angle which is less than or equal to  $180^\circ$  in magnitude.

The concept of a leading or lagging relationship between two sinusoids will be used extensively, and the relationship is recognizable both mathematically and graphically.

Recall that to convert radians to degrees, we simply multiply the angle by  $180/\pi$ .



Note that:

$$\begin{aligned} -\sin \omega t &= \sin(\omega t \pm 180^\circ) \\ -\cos \omega t &= \cos(\omega t \pm 180^\circ) \\ \mp \sin \omega t &= \cos(\omega t \pm 90^\circ) \\ \pm \cos \omega t &= \sin(\omega t \pm 90^\circ) \end{aligned}$$

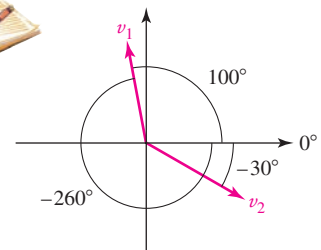

FIGURE 10.3 A graphical representation of the two sinusoids  $v_1$  and  $v_2$ . The magnitude of each sine function is represented by the length of the corresponding arrow, and the phase angle by the orientation with respect to the positive  $x$  axis. In this diagram,  $v_1$  leads  $v_2$  by  $100^\circ + 30^\circ = 130^\circ$ , although it could also be argued that  $v_2$  leads  $v_1$  by  $230^\circ$ . It is customary, however, to express the phase difference by an angle less than or equal to  $180^\circ$  in magnitude.

**PRACTICE**

10.1 Find the angle by which  $i_1$  lags  $v_1$  if  $v_1 = 120 \cos(120\pi t - 40^\circ)$  V and  $i_1$  equals (a)  $2.5 \cos(120\pi t + 20^\circ)$  A; (b)  $1.4 \sin(120\pi t - 70^\circ)$  A; (c)  $-0.8 \cos(120\pi t - 110^\circ)$  A.

10.2 Find  $A$ ,  $B$ ,  $C$ , and  $\phi$  if  $40 \cos(100t - 40^\circ) - 20 \sin(100t + 170^\circ) = A \cos 100t + B \sin 100t = C \cos(100t + \phi)$ .

Ans: 10.1:  $-60^\circ$ ;  $120^\circ$ ;  $-110^\circ$ . 10.2: 27.2; 45.4; 52.9;  $-59.1^\circ$ .

## 10.2 FORCED RESPONSE TO SINUSOIDAL FUNCTIONS

Now that we are familiar with the mathematical characteristics of sinusoids, we are ready to apply a sinusoidal forcing function to a simple circuit and obtain the forced response. We will first write the differential equation that applies to the given circuit. The complete solution of this equation is composed of two parts, the complementary solution (which we call the *natural response*) and the particular integral (or *forced response*). The methods we plan to develop in this chapter assume that we are not interested in the short-lived transient or natural response of our circuit, but only in the long-term or “steady-state” response.

### The Steady-State Response

The term *steady-state response* is used synonymously with *forced response*, and the circuits we are about to analyze are commonly said to be in the “sinusoidal steady state.” Unfortunately, *steady state* carries the connotation of “not changing with time” in the minds of many students. This is true for dc forcing functions, but the sinusoidal steady-state response is definitely changing with time. The steady state simply refers to the condition that is reached after the transient or natural response has died out.

The forced response has the mathematical form of the forcing function, plus all its derivatives and its first integral. With this knowledge, one of the methods by which the forced response may be found is to assume a solution composed of a sum of such functions, where each function has an unknown amplitude to be determined by direct substitution in the differential equation. As we are about to see, this can be a lengthy process, so we will be sufficiently motivated to seek out a simpler alternative.

Consider the series  $RL$  circuit shown in Fig. 10.4. The sinusoidal source voltage  $v_s = V_m \cos \omega t$  has been switched into the circuit at some remote time in the past, and the natural response has died out completely. We seek the forced (or “steady-state”) response, which must satisfy the differential equation

$$L \frac{di}{dt} + Ri = V_m \cos \omega t$$

obtained by applying KVL around the simple loop. At any instant where the derivative is equal to zero, we see that the current must have the form  $i \propto \cos \omega t$ . Similarly, at an instant where the current is equal to zero, the

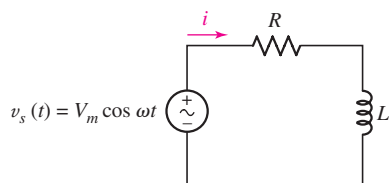

■ FIGURE 10.4 A series  $RL$  circuit for which the forced response is desired.



*derivative* must be proportional to  $\cos \omega t$ , implying a current of the form  $\sin \omega t$ . We might expect, therefore, that the forced response will have the general form

$$i(t) = I_1 \cos \omega t + I_2 \sin \omega t$$

where  $I_1$  and  $I_2$  are real constants whose values depend upon  $V_m, R, L$ , and  $\omega$ . No constant or exponential function can be present. Substituting the assumed form for the solution in the differential equation yields

$$L(-I_1 \omega \sin \omega t + I_2 \omega \cos \omega t) + R(I_1 \cos \omega t + I_2 \sin \omega t) = V_m \cos \omega t$$

If we collect the cosine and sine terms, we obtain

$$(-LI_1 \omega + RI_2) \sin \omega t + (LI_2 \omega + RI_1 - V_m) \cos \omega t = 0$$

This equation must be true for all values of  $t$ , which can be achieved only if the factors multiplying  $\cos \omega t$  and  $\sin \omega t$  are each zero. Thus,

$$-\omega LI_1 + RI_2 = 0 \quad \text{and} \quad \omega LI_2 + RI_1 - V_m = 0$$

and simultaneous solution for  $I_1$  and  $I_2$  leads to

$$I_1 = \frac{RV_m}{R^2 + \omega^2 L^2} \quad I_2 = \frac{\omega LV_m}{R^2 + \omega^2 L^2}$$

Thus, the forced response is obtained:

$$i(t) = \frac{RV_m}{R^2 + \omega^2 L^2} \cos \omega t + \frac{\omega LV_m}{R^2 + \omega^2 L^2} \sin \omega t \quad [2]$$

### A More Compact and User-Friendly Form

Although accurate, this expression is slightly cumbersome; a clearer picture of the response can be obtained by expressing it as a single sinusoid or cosinusoid with a phase angle. We choose to express the response as a cosine function,

$$i(t) = A \cos(\omega t - \theta) \quad [3]$$

At least two methods of obtaining the values of  $A$  and  $\theta$  suggest themselves. We might substitute Eq. [3] directly in the original differential equation, or we could simply equate the two solutions, Eqs. [2] and [3]. Selecting the latter method, and expanding the function  $\cos(\omega t - \theta)$ :

Several useful trigonometric identities are provided on the inside cover of the book.

$$A \cos \theta \cos \omega t + A \sin \theta \sin \omega t = \frac{RV_m}{R^2 + \omega^2 L^2} \cos \omega t + \frac{\omega LV_m}{R^2 + \omega^2 L^2} \sin \omega t$$

All that remains is to collect terms and perform a bit of algebra, an exercise left to the reader. The result is

$$\theta = \tan^{-1} \frac{\omega L}{R}$$

and

$$A = \frac{V_m}{\sqrt{R^2 + \omega^2 L^2}}$$

and so the *alternative form* of the forced response therefore becomes

$$i(t) = \frac{V_m}{\sqrt{R^2 + \omega^2 L^2}} \cos\left(\omega t - \tan^{-1} \frac{\omega L}{R}\right) \quad [4]$$

Once upon a time, the symbol  $E$  (for electromotive force) was used to designate voltages. Then every student learned the phrase “ELI the ICE man” as a reminder that *voltage* leads *current* in an *inductive* circuit, while *current* leads *voltage* in a *capacitive* circuit. Now that we use  $V$  instead, it just isn't the same.



With this form, it is easy to see that the amplitude of the *response* is proportional to the amplitude of the *forcing function*; if not, the linearity concept would have to be discarded. The current is seen to lag the applied voltage by  $\tan^{-1}(\omega L/R)$ , an angle between  $0$  and  $90^\circ$ . When  $\omega = 0$  or  $L = 0$ , the current must be in phase with the voltage; since the former situation is direct current and the latter provides a resistive circuit, the result agrees with our previous experience. If  $R = 0$ , the current lags the voltage by  $90^\circ$ . In an inductor, then, if the passive sign convention is satisfied, the current lags the voltage by exactly  $90^\circ$ . In a similar manner we can show that the current through a capacitor *leads* the voltage across it by  $90^\circ$ .

The phase difference between the current and voltage depends upon the ratio of the quantity  $\omega L$  to  $R$ . We call  $\omega L$  the *inductive reactance* of the inductor; it is measured in ohms, and it is a measure of the opposition that is offered by the inductor to the passage of a sinusoidal current.

### EXAMPLE 10.1

Find the current  $i_L$  in the circuit shown in Fig. 10.5a, if the transients have already died out.

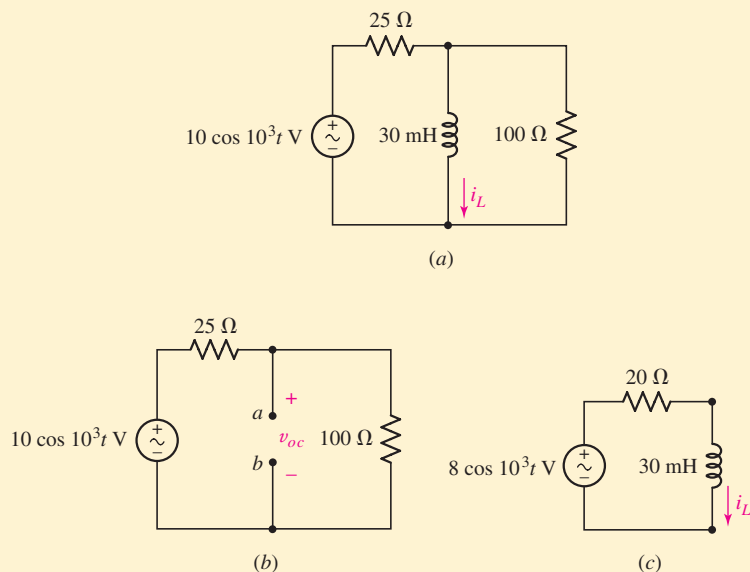

FIGURE 10.5 (a) The circuit for Example 10.1, in which the current  $i_L$  is desired. (b) The Thévenin equivalent is desired at terminals  $a$  and  $b$ . (c) The simplified circuit.

Although this circuit has a sinusoidal source and a single inductor, it contains two resistors and is not a single loop. In order to apply the results of the preceding analysis, we need to seek the Thévenin equivalent as viewed from terminals  $a$  and  $b$  in Fig. 10.5b.

The open-circuit voltage  $v_{oc}$  is

$$v_{oc} = (10 \cos 10^3 t) \frac{100}{100 + 25} = 8 \cos 10^3 t \quad \text{V}$$

Since there are no dependent sources in sight, we find  $R_{th}$  by shorting out the independent source and calculating the resistance of the passive network, so  $R_{th} = (25 \times 100)/(25 + 100) = 20 \Omega$ .

Now we do have a series  $RL$  circuit, with  $L = 30$  mH,  $R_{th} = 20 \Omega$ , and a source voltage of  $8 \cos 10^3 t$  V, as shown in Fig. 10.5c. Thus, applying Eq. [4], which was derived for a general  $RL$  series circuit,

$$i_L = \frac{8}{\sqrt{20^2 + (10^3 \times 30 \times 10^{-3})^2}} \cos\left(10^3 t - \tan^{-1} \frac{30}{20}\right) \\ = 222 \cos(10^3 t - 56.3^\circ) \quad \text{mA}$$

The voltage and current waveforms are plotted in Fig. 10.6.

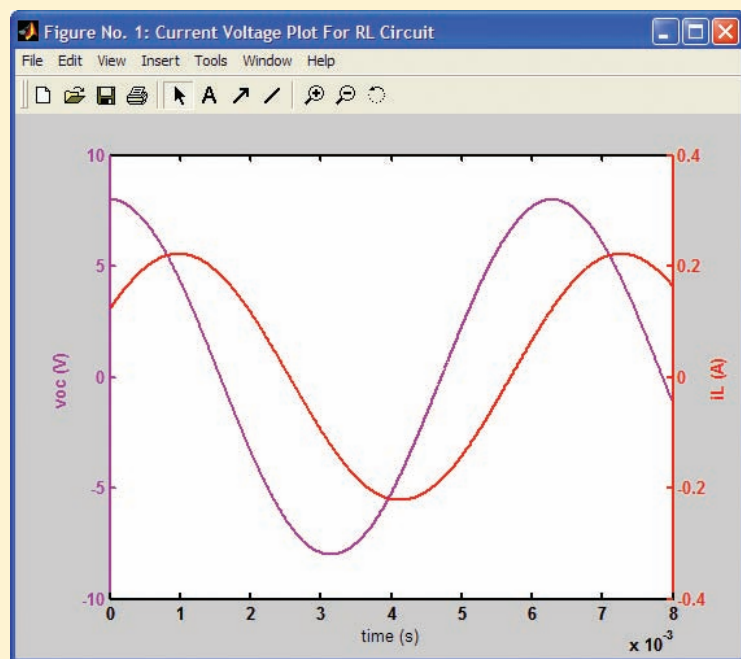

■ FIGURE 10.6 Voltage and current waveforms on a dual axis plot, generated using MATLAB:

```
EDU> t = linspace(0,8e-3,1000);
EDU> v = 8*cos(1000*t);
EDU> i = 0.222*cos(1000*t - 56.3*pi/180);
EDU> plotyy(t,v,i);
EDU> xlabel('time (s)');
```

Note that there is not a  $90^\circ$  phase difference between the current and voltage waveforms of the plot. This is because we are not plotting the inductor voltage, which is left as an exercise for the reader.

## PRACTICE

10.3 Let  $v_s = 40 \cos 8000t$  V in the circuit of Fig. 10.7. Use Thévenin's theorem where it will do the most good, and find the value at  $t = 0$  for (a)  $i_L$ ; (b)  $v_L$ ; (c)  $i_R$ ; (d)  $i_s$ .

Ans: 18.71 mA; 15.97 V; 5.32 mA; 24.0 mA.

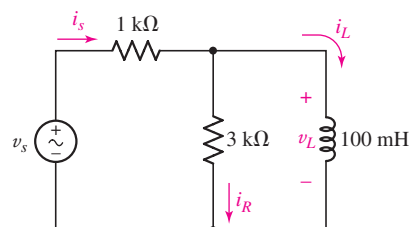

■ FIGURE 10.7

### 10.3 THE COMPLEX FORCING FUNCTION

The method we just employed works—the correct answer is obtained in a straightforward manner. However, it isn't particularly graceful, and after being applied to a few circuits, it remains as clunky and cumbersome as the first time we use it. The real problem isn't the time-varying source—it's the inductor (or capacitor), since a purely resistive circuit is no more difficult to analyze with sinusoidal sources than with dc sources, as only algebraic equations result. It turns out that if the *transient* response is of no interest to us, there is an alternative approach for obtaining the sinusoidal steady-state response of any linear circuit. The distinct advantage of this alternative is that it allows us to relate the current and voltage associated with any element using a simple algebraic expression.

The basic idea is that sinusoids and exponentials are related through complex numbers. Euler's identity, for example, tells us that

$$e^{j\theta} = \cos \theta + j \sin \theta$$

Whereas taking the derivative of a cosine function yields a (negative) sine function, the derivative of an exponential is simply a scaled version of the same exponential. If at this point the reader is thinking, "All this is great, but there are no imaginary numbers in any circuit I ever plan to build!" that may be true. What we're about to see, however, is that adding imaginary sources to our circuits leads to complex sources which (surprisingly) simplify the analysis process. It might seem like a strange idea at first, but a moment's reflection should remind us that superposition requires any *imaginary* sources we might add to cause only *imaginary* responses, and real sources can only lead to real responses. Thus, at any point, we should be able to separate the two by simply taking the real part of any complex voltage or current.

In Fig. 10.8, a sinusoidal source

$$V_m \cos(\omega t + \theta) \quad [5]$$

is connected to a general network, which we will assume to contain only passive elements (i.e., no independent sources) in order to keep things simple. A current response in some other branch of the network is to be determined, and the parameters appearing in Eq. [5] are all real quantities.

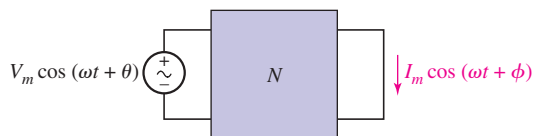

■ FIGURE 10.8 The sinusoidal forcing function  $V_m \cos(\omega t + \theta)$  produces the steady-state sinusoidal response  $I_m \cos(\omega t + \phi)$ .

We have shown that we may represent the response by the general cosine function

$$I_m \cos(\omega t + \phi) \quad [6]$$

A sinusoidal forcing function always produces a sinusoidal forced response of the same frequency in a linear circuit.

Appendix 5 defines the complex number and related terms, reviews complex arithmetic, and develops Euler's identity and the relationship between exponential and polar forms.



Now let us change our time reference by shifting the phase of the forcing function by  $90^\circ$ , or changing the instant that we call  $t = 0$ . Thus, the forcing function

$$V_m \cos(\omega t + \theta - 90^\circ) = V_m \sin(\omega t + \theta) \quad [7]$$

when applied to the same network will produce a corresponding response

$$I_m \cos(\omega t + \phi - 90^\circ) = I_m \sin(\omega t + \phi) \quad [8]$$

We next depart from physical reality by applying an imaginary forcing function, one that cannot be applied in the laboratory but can be applied mathematically.

### Imaginary Sources Lead to . . . Imaginary Responses

We construct an imaginary source very simply; it is only necessary to multiply Eq. [7] by  $j$ , the imaginary operator. We thus apply

$$jV_m \sin(\omega t + \theta) \quad [9]$$

What is the response? If we had doubled the source, then the principle of linearity would require that we double the response; multiplication of the forcing function by a constant  $k$  would result in the multiplication of the response by the same constant  $k$ . The fact that our constant is  $\sqrt{-1}$  does not destroy this relationship. The response to the imaginary source of Eq. [9] is thus

$$jI_m \sin(\omega t + \phi) \quad [10]$$

The imaginary source and response are indicated in Fig. 10.9.

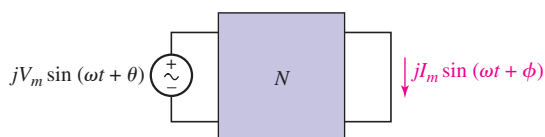

■ FIGURE 10.9 The imaginary sinusoidal forcing function  $jV_m \sin(\omega t + \theta)$  produces the imaginary sinusoidal response  $jI_m \sin(\omega t + \phi)$  in the network of Fig. 10.8.

### Applying a Complex Forcing Function

We have applied a *real source* and obtained a *real* response; we have also applied an *imaginary* source and obtained an *imaginary* response. Since we are dealing with a *linear* circuit, we may use the superposition theorem to find the response to a complex forcing function which is the sum of the real and imaginary forcing functions. Thus, the sum of the forcing functions of Eqs. [5] and [9],

$$V_m \cos(\omega t + \theta) + jV_m \sin(\omega t + \theta) \quad [11]$$

must produce a response that is the sum of Eqs. [6] and [10],

$$I_m \cos(\omega t + \phi) + jI_m \sin(\omega t + \phi) \quad [12]$$

Electrical engineers use “ $j$ ” instead of “ $i$ ” to represent  $\sqrt{-1}$  to avoid confusion with currents.

The complex source and response may be represented more simply by applying Euler's identity, i.e.,  $\cos(\omega t + \theta) + j \sin(\omega t + \theta) = e^{j(\omega t + \theta)}$ . Thus, the source of Eq. [11] may be written as

$$V_m e^{j(\omega t + \theta)} \quad [13]$$

and the response of Eq. [12] is

$$I_m e^{j(\omega t + \phi)} \quad [14]$$

The complex source and response are illustrated in Fig. 10.10.

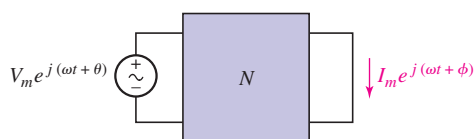

■ FIGURE 10.10 The complex forcing function  $V_m e^{j(\omega t + \theta)}$  produces the complex response  $I_m e^{j(\omega t + \phi)}$  in the network of Fig. 10.8.

Again, linearity assures us that the *real* part of the complex response is produced by the *real* part of the complex forcing function, while the *imaginary* part of the response is caused by the *imaginary* part of the complex forcing function. Our plan is that instead of applying a *real* forcing function to obtain the desired real response, we will substitute a *complex* forcing function whose real part is the given real forcing function; we expect to obtain a complex response whose real part is the desired real response. The advantage of this procedure is that the integrodifferential equations describing the steady-state response of a circuit will now become simple algebraic equations.

## An Algebraic Alternative to Differential Equations

Let's try out this idea on the simple  $RL$  series circuit shown in Fig. 10.11. The real source  $V_m \cos \omega t$  is applied; the real response  $i(t)$  is desired. Since

$$V_m \cos \omega t = \text{Re}\{V_m \cos \omega t + j V_m \sin \omega t\} = \text{Re}\{V_m e^{j\omega t}\}$$

the necessary complex source is

$$V_m e^{j\omega t}$$

We express the complex response that results in terms of an unknown amplitude  $I_m$  and an unknown phase angle  $\phi$ :

$$I_m e^{j(\omega t + \phi)}$$

Writing the differential equation for this particular circuit,

$$Ri + L \frac{di}{dt} = v_s$$

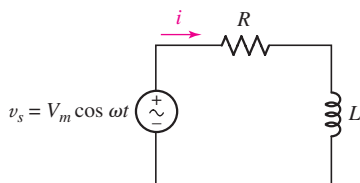

■ FIGURE 10.11 A simple circuit in the sinusoidal steady state is to be analyzed by the application of a complex forcing function.

we insert our complex expressions for  $v_s$  and  $i$ :

$$RI_m e^{j(\omega t + \phi)} + L \frac{d}{dt} (I_m e^{j(\omega t + \phi)}) = V_m e^{j\omega t}$$

take the indicated derivative:

$$RI_m e^{j(\omega t + \phi)} + j\omega LI_m e^{j(\omega t + \phi)} = V_m e^{j\omega t}$$

and obtain an *algebraic* equation. In order to determine the values of  $I_m$  and  $\phi$ , we divide throughout by the common factor  $e^{j\omega t}$ :

$$RI_m e^{j\phi} + j\omega LI_m e^{j\phi} = V_m$$

factor the left side:

$$I_m e^{j\phi} (R + j\omega L) = V_m$$

rearrange:

$$I_m e^{j\phi} = \frac{V_m}{R + j\omega L}$$

and identify  $I_m$  and  $\phi$  by expressing the right side of the equation in exponential or polar form:

$$I_m e^{j\phi} = \frac{V_m}{\sqrt{R^2 + \omega^2 L^2}} e^{j[-\tan^{-1}(\omega L/R)]} \quad [15]$$

Thus,

$$I_m = \frac{V_m}{\sqrt{R^2 + \omega^2 L^2}}$$

and

$$\phi = -\tan^{-1} \frac{\omega L}{R}$$

In polar notation, this may be written as

$$I_m \angle \phi$$

or

$$V_m / \sqrt{R^2 + \omega^2 L^2} \angle -\tan^{-1}(\omega L/R)$$

The complex response is given by Eq. [15]. Since  $I_m$  and  $\phi$  are readily identified, we can write the expression for  $i(t)$  immediately. However, if we feel like using a more rigorous approach, we may obtain the real response  $i(t)$  by reinserting the  $e^{j\omega t}$  factor on both sides of Eq. [15] and taking the real part. Either way, we find that

$$i(t) = I_m \cos(\omega t + \phi) = \frac{V_m}{\sqrt{R^2 + \omega^2 L^2}} \cos\left(\omega t - \tan^{-1} \frac{\omega L}{R}\right)$$

which agrees with the response obtained in Eq. [4] for the same circuit.

## EXAMPLE 10.2

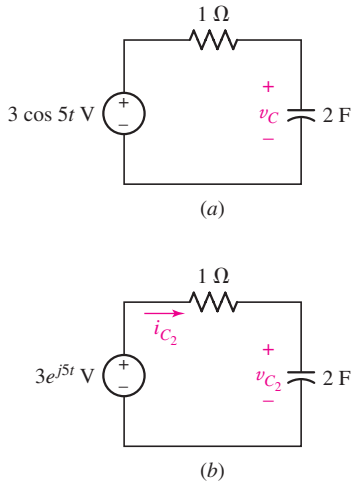

■ FIGURE 10.12 (a) An RC circuit for which the sinusoidal steady-state capacitor voltage is required. (b) Modified circuit, with the real source replaced with a complex source.

For the simple RC circuit of Fig. 10.12a, substitute an appropriate complex source and use it to solve for the steady-state capacitor voltage.

Since the real source is  $3 \cos 5t$ , we “replace” it with a complex source  $3e^{j5t} \text{ V}$ . We’ll call the new capacitor voltage  $v_{C_2}$  and define a capacitor current  $i_{C_2}$  consistent with the passive sign convention (Fig. 10.12b).

The differential equation can be now obtained by simple application of KVL,

$$-3e^{j5t} + 1i_{C_2} + v_{C_2} = 0$$

or

$$-3e^{j5t} + 2 \frac{dv_{C_2}}{dt} + v_{C_2} = 0$$

We anticipate a steady-state response of the same form as our source; in other words,

$$v_{C_2} = V_m e^{j5t}$$

Substituting this into our differential equation and rearranging terms yields

$$j10V_m e^{j5t} + V_m e^{j5t} = 3e^{j5t}$$

Canceling the exponential term, we find that

$$V_m = \frac{3}{1 + j10} = \frac{3}{\sqrt{1 + 10^2}} \angle -\tan^{-1}(10/1) \text{ V}$$

and our steady-state capacitor voltage is given by

$$\text{Re}\{v_{C_2}\} = \text{Re}\{29.85e^{-j84.3^\circ} e^{j5t} \text{ mV}\} = 29.85 \cos(5t - 84.3^\circ) \text{ mV}$$

## PRACTICE

10.4 Evaluate and express the result in rectangular form:

(a)  $[(2/\underline{30^\circ})(5/\underline{-110^\circ})](1 + j2)$ ; (b)  $(5/\underline{-200^\circ}) + 4/\underline{20^\circ}$ . Evaluate and express the result in polar form: (c)  $(2 - j7)/(3 - j)$ ; (d)  $8 - j4 + [(5/\underline{80^\circ})/(2/\underline{20^\circ})]$ .

10.5 If the use of the passive sign convention is specified, find the (a) complex voltage that results when the complex current  $4e^{j800t} \text{ A}$  is applied to the series combination of a 1 mF capacitor and a 2  $\Omega$  resistor; (b) complex current that results when the complex voltage  $100e^{j2000t} \text{ V}$  is applied to the parallel combination of a 10 mH inductor and a 50  $\Omega$  resistor.

Ans: 10.4:  $21.4 - j6.38$ ;  $-0.940 + j3.08$ ;  $2.30/\underline{-55.6^\circ}$ ;  $9.43/\underline{-11.22^\circ}$ .  
 10.5:  $9.43e^{j(800t-32.0^\circ)} \text{ V}$ ;  $5.39e^{j(2000t-68.2^\circ)} \text{ A}$ .

(If you have trouble working this practice problem, turn to Appendix 5.)



## 10.4 THE PHASOR

In the last section, we saw that the addition of an imaginary sinusoidal source led to algebraic equations which describe the sinusoidal steady-state response of a circuit. An intermediate step of our analysis was the “canceling” of the complex exponential term—once its derivative was taken, we apparently had no further use for it until the real form of the response was desired. Even then, it was possible to read the magnitude and phase angle directly from our analysis, and hence skip the step where we overtly take the real part. Another way of looking at this is that every voltage and current in our circuit contain the same factor  $e^{j\omega t}$ , and the frequency, although relevant to our analysis, *does not change* as we move through the circuit. Dragging it around, then, is a bit of a waste of time.

Looking back at Example 10.2, then, we could represent our source as

$$3e^{j0^\circ} \text{ V} \quad (\text{or even just } 3 \text{ V})$$

and our capacitor voltage as  $V_m e^{j\phi}$ , which we ultimately found was  $0.02985e^{-j84.3^\circ}$  V. Knowledge of the source frequency is implicit here; without it, we are unable to reconstruct any voltage or current.

These complex quantities are usually written in polar form rather than exponential form in order to achieve a slight additional saving of time and effort. For example, a source voltage

$$v(t) = V_m \cos \omega t = V_m \cos(\omega t + 0^\circ)$$

we now represent in complex form as

$$V_m \underline{\underline{0^\circ}}$$

and its current response

$$i(t) = I_m \cos(\omega t + \phi)$$

becomes

$$I_m \underline{\underline{\phi}}$$

This abbreviated complex representation is called a **phasor**.<sup>1</sup>

Let us review the steps by which a real sinusoidal voltage or current is transformed into a phasor, and then we will be able to define a phasor more meaningfully and to assign a symbol to represent it.

A real sinusoidal current

$$i(t) = I_m \cos(\omega t + \phi)$$

is expressed as the real part of a complex quantity by invoking Euler’s identity

$$i(t) = \text{Re} \{ I_m e^{j(\omega t + \phi)} \}$$

We then represent the current as a complex quantity by dropping the instruction  $\text{Re}\{\}$ , thus adding an imaginary component to the current without affecting the real component; further simplification is achieved by suppressing the factor  $e^{j\omega t}$ :

$$\mathbf{I} = I_m e^{j\phi}$$

and writing the result in polar form:

$$\mathbf{I} = I_m \underline{\underline{\phi}}$$

$$e^{j0} = \cos 0 + j \sin 0 = 1$$

Remember that none of the steady-state circuits we are considering will respond at a frequency other than that of the excitation source, so that the value of  $\omega$  is always known.

(1) Not to be confused with the *phaser*, an interesting device featured in a popular television series. . . .

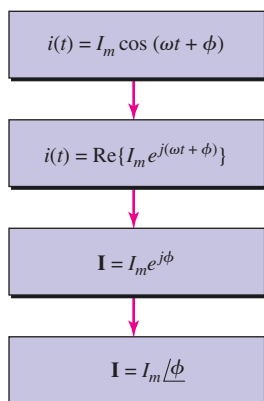

The process by which we change  $i(t)$  into  $I$  is called a *phasor transformation* from the time domain to the frequency domain.

This abbreviated complex representation is the *phasor representation*; phasors are complex quantities and hence are printed in boldface type. Capital letters are used for the phasor representation of an electrical quantity because the phasor is not an instantaneous function of time; it contains only amplitude and phase information. We recognize this difference in viewpoint by referring to  $i(t)$  as a *time-domain representation* and terming the phasor  $I$  a *frequency-domain representation*. It should be noted that the frequency-domain expression of a current or voltage does not explicitly include the frequency. The process of returning to the time domain from the frequency domain is exactly the reverse of the previous sequence. Thus, given the phasor voltage

$$\mathbf{V} = 115/\underline{-45^\circ} \text{ volts}$$

and the knowledge that  $\omega = 500$  rad/s, we can write the time-domain equivalent directly:

$$v(t) = 115 \cos(500t - 45^\circ) \quad \text{volts}$$

If desired as a sine wave,  $v(t)$  could also be written

$$v(t) = 115 \sin(500t + 45^\circ) \quad \text{volts}$$

### PRACTICE

10.6 Let  $\omega = 2000$  rad/s and  $t = 1$  ms. Find the instantaneous value of each of the currents given here in phasor form: (a)  $j 10$  A; (b)  $20 + j 10$  A; (c)  $20 + j(10/\underline{20^\circ})$  A.

Ans:  $-9.09$  A;  $-17.42$  A;  $-15.44$  A.

### EXAMPLE 10.3

**Transform the time-domain voltage  $v(t) = 100 \cos(400t - 30^\circ)$  volts into the frequency domain.**

The time-domain expression is already in the form of a cosine wave with a phase angle. Thus, suppressing  $\omega = 400$  rad/s,

$$\mathbf{V} = 100/\underline{-30^\circ} \text{ volts}$$

Note that we skipped several steps in writing this representation directly. Occasionally, this is a source of confusion for students, as they may forget that the phasor representation is *not* equal to the time-domain voltage  $v(t)$ . Rather, it is a simplified form of a complex function formed by adding an imaginary component to the real function  $v(t)$ .

### PRACTICE

10.7 Transform each of the following functions of time into phasor form: (a)  $-5 \sin(580t - 110^\circ)$ ; (b)  $3 \cos 600t - 5 \sin(600t + 110^\circ)$ ; (c)  $8 \cos(4t - 30^\circ) + 4 \sin(4t - 100^\circ)$ . *Hint*: First convert each into a single cosine function with a positive magnitude.

Ans:  $5/\underline{-20^\circ}$ ;  $2.41/\underline{-134.8^\circ}$ ;  $4.46/\underline{-47.9^\circ}$ .

Several useful trigonometric identities are provided on the inside cover for convenience.

The real power of the phasor-based analysis technique lies in the fact that it is possible to define *algebraic* relationships between the voltage and current for inductors and capacitors, just as we have always been able to do in the case of resistors. Now that we are able to transform into and out of the frequency domain, we can proceed to our simplification of sinusoidal steady-state analysis by establishing the relationship between the phasor voltage and phasor current for each of the three passive elements.

## The Resistor

The resistor provides the simplest case. In the time domain, as indicated by Fig. 10.13a, the defining equation is

$$v(t) = Ri(t)$$

Now let us apply the complex voltage

$$v(t) = V_m e^{j(\omega t + \theta)} = V_m \cos(\omega t + \theta) + jV_m \sin(\omega t + \theta) \quad [16]$$

and assume the complex current response

$$i(t) = I_m e^{j(\omega t + \phi)} = I_m \cos(\omega t + \phi) + jI_m \sin(\omega t + \phi) \quad [17]$$

so that

$$V_m e^{j(\omega t + \theta)} = Ri(t) = RI_m e^{j(\omega t + \phi)}$$

Dividing throughout by  $e^{j\omega t}$ , we find

$$V_m e^{j\theta} = RI_m e^{j\phi}$$

or, in polar form,

$$V_m \angle \theta = RI_m \angle \phi$$

But  $V_m \angle \theta$  and  $I_m \angle \phi$  merely represent the general voltage and current phasors  $\mathbf{V}$  and  $\mathbf{I}$ . Thus,

$$\mathbf{V} = R\mathbf{I} \quad [18]$$

The voltage-current relationship in phasor form for a resistor has the same form as the relationship between the time-domain voltage and current. The defining equation in phasor form is illustrated in Fig. 10.13b. The angles  $\theta$  and  $\phi$  are equal, so that the current and voltage are always in phase.

As an example of the use of both the time-domain and frequency-domain relationships, let us assume that a voltage of  $8 \cos(100t - 50^\circ)$  V is across a  $4 \Omega$  resistor. Working in the time domain, we find that the current must be

$$i(t) = \frac{v(t)}{R} = 2 \cos(100t - 50^\circ) \quad \text{A}$$

The phasor form of the same voltage is  $8 \angle -50^\circ$  V, and therefore

$$\mathbf{I} = \frac{\mathbf{V}}{R} = 2 \angle -50^\circ \quad \text{A}$$

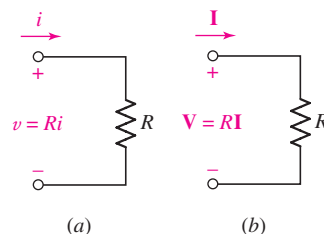

FIGURE 10.13 A resistor and its associated voltage and current in (a) the time domain,  $v = Ri$ ; and (b) the frequency domain,  $\mathbf{V} = R\mathbf{I}$ .

Ohm's law holds true both in the time domain and in the frequency domain. In other words, the voltage across a resistor is always given by the resistance times the current flowing through the element.



If we transform this answer back to the time domain, it is evident that the same expression for the current is obtained. We conclude that there is no saving in time or effort when a *resistive* circuit is analyzed in the frequency domain.

## The Inductor

Let us now turn to the inductor. The time-domain representation is shown in Fig. 10.14a, and the defining equation, a time-domain expression, is

$$v(t) = L \frac{di(t)}{dt} \quad [19]$$

After substituting the complex voltage equation [16] and complex current equation [17] in Eq. [19], we have

$$V_m e^{j(\omega t + \theta)} = L \frac{d}{dt} I_m e^{j(\omega t + \phi)}$$

Taking the indicated derivative:

$$V_m e^{j(\omega t + \theta)} = j\omega L I_m e^{j(\omega t + \phi)}$$

and dividing through by  $e^{j\omega t}$ :

$$V_m e^{j\theta} = j\omega L I_m e^{j\phi}$$

we obtain the desired phasor relationship

$$\mathbf{V} = j\omega L \mathbf{I} \quad [20]$$



The time-domain differential equation [19] has become the algebraic equation [20] in the frequency domain. The phasor relationship is indicated in Fig. 10.14b. Note that the angle of the factor  $j\omega L$  is exactly  $+90^\circ$  and that  $\mathbf{I}$  must therefore lag  $\mathbf{V}$  by  $90^\circ$  in an inductor.

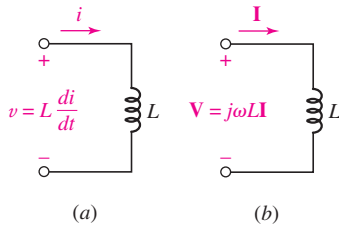

■ FIGURE 10.14 An inductor and its associated voltage and current in (a) the time domain,  $v = L di/dt$ ; and (b) the frequency domain,  $\mathbf{V} = j\omega L \mathbf{I}$ .

### EXAMPLE 10.4

**Apply the voltage  $8\angle-50^\circ$  V at a frequency  $\omega = 100$  rad/s to a 4 H inductor, and determine the phasor current and the time-domain current.**

We make use of the expression we just obtained for the inductor,

$$\mathbf{I} = \frac{\mathbf{V}}{j\omega L} = \frac{8\angle-50^\circ}{j100(4)} = -j0.02\angle-50^\circ = (1\angle-90^\circ)(0.02\angle-50^\circ)$$

or

$$\mathbf{I} = 0.02\angle-140^\circ \text{ A}$$

If we express this current in the time domain, it becomes

$$i(t) = 0.02 \cos(100t - 140^\circ) \text{ A} = 20 \cos(100t - 140^\circ) \text{ mA}$$

## The Capacitor

The final element to consider is the capacitor. The time-domain current-voltage relationship is

$$i(t) = C \frac{dv(t)}{dt}$$

The equivalent expression in the frequency domain is obtained once more by letting  $v(t)$  and  $i(t)$  be the complex quantities of Eqs. [16] and [17], taking the indicated derivative, suppressing  $e^{j\omega t}$ , and recognizing the phasors  $\mathbf{V}$  and  $\mathbf{I}$ . Doing this, we find

$$\mathbf{I} = j\omega C\mathbf{V} \quad [21]$$

Thus,  $\mathbf{I}$  leads  $\mathbf{V}$  by  $90^\circ$  in a capacitor. This, of course, does not mean that a current response is present one-quarter of a period earlier than the voltage that caused it! We are studying steady-state response, and we find that the current maximum is caused by the increasing voltage that occurs  $90^\circ$  earlier than the voltage maximum.

The time-domain and frequency-domain representations are compared in Fig. 10.15a and b. We have now obtained the  $\mathbf{V}$ - $\mathbf{I}$  relationships for the three passive elements. These results are summarized in Table 10.1, where the time-domain  $v$ - $i$  expressions and the frequency-domain  $\mathbf{V}$ - $\mathbf{I}$  relationships are shown in adjacent columns for the three circuit elements. All the phasor equations are algebraic. Each is also linear, and the equations relating to inductance and capacitance bear a great similarity to Ohm's law. In fact, we will indeed use them as we use Ohm's law.

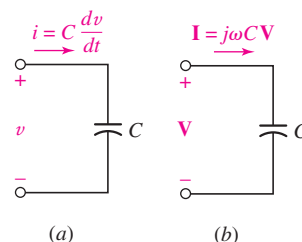

FIGURE 10.15 (a) The time-domain and (b) the frequency-domain relationships between capacitor current and voltage.

TABLE 10.1 Comparison of Time-Domain and Frequency-Domain Voltage-Current Expressions

Time Domain		Frequency Domain	
	$v = Ri$	$\mathbf{V} = R\mathbf{I}$	
	$v = L \frac{di}{dt}$	$\mathbf{V} = j\omega L\mathbf{I}$	
	$v = \frac{1}{C} \int i dt$	$\mathbf{V} = \frac{1}{j\omega C}\mathbf{I}$	

## Kirchhoff's Laws Using Phasors

Kirchhoff's voltage law in the time domain is

$$v_1(t) + v_2(t) + \cdots + v_N(t) = 0$$

We now use Euler's identity to replace each real voltage  $v_i$  by a complex voltage having the same real part, suppress  $e^{j\omega t}$  throughout, and obtain

$$\mathbf{V}_1 + \mathbf{V}_2 + \cdots + \mathbf{V}_N = 0$$

Thus, we see that Kirchhoff's voltage law applies to phasor voltages just as it did in the time domain. Kirchhoff's current law can be shown to hold for phasor currents by a similar argument.

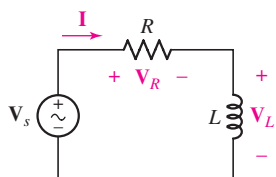

FIGURE 10.16 The series  $RL$  circuit with a phasor voltage applied.

Now let us look briefly at the series  $RL$  circuit that we have considered several times before. The circuit is shown in Fig. 10.16, and a phasor current and several phasor voltages are indicated. We may obtain the desired response, a time-domain current, by first finding the phasor current. From Kirchhoff's voltage law,

$$\mathbf{V}_R + \mathbf{V}_L = \mathbf{V}_s$$

and using the recently obtained  $\mathbf{V}$ - $\mathbf{I}$  relationships for the elements, we have

$$R\mathbf{I} + j\omega L\mathbf{I} = \mathbf{V}_s$$

The phasor current is then found in terms of the source voltage  $\mathbf{V}_s$ :

$$\mathbf{I} = \frac{\mathbf{V}_s}{R + j\omega L}$$

Let us select a source-voltage amplitude of  $V_m$  and phase angle of  $0^\circ$ . Thus,

$$\mathbf{I} = \frac{V_m \angle 0^\circ}{R + j\omega L}$$

The current may be transformed to the time domain by first writing it in polar form:

$$\mathbf{I} = \frac{V_m}{\sqrt{R^2 + \omega^2 L^2}} \angle [-\tan^{-1}(\omega L/R)]$$

and then following the familiar sequence of steps to obtain in a very simple manner the same result we obtained the "hard way" earlier in this chapter.

## EXAMPLE 10.5

For the  $RLC$  circuit of Fig. 10.17, determine  $\mathbf{I}_s$  and  $i_s(t)$  if both sources operate at  $\omega = 2$  rad/s, and  $\mathbf{I}_C = 2/28^\circ$  A.

The fact that we are given  $\mathbf{I}_C$  and asked for  $\mathbf{I}_s$  is all the prompting we need to consider applying KCL. If we label the capacitor voltage  $\mathbf{V}_C$  consistent with the passive sign convention, then

$$\mathbf{V}_C = \frac{1}{j\omega C} \mathbf{I}_C = \frac{-j}{2} \mathbf{I}_C = \frac{-j}{2} (2/28^\circ) = (0.5 \angle -90^\circ) (2/28^\circ) = 1 \angle -62^\circ \text{ V}$$

This voltage also appears across the  $2\ \Omega$  resistor, so that the current  $\mathbf{I}_{R_2}$  flowing downward through that branch is

$$\mathbf{I}_{R_2} = \frac{1}{2} \mathbf{V}_C = \frac{1}{2} \angle -62^\circ \text{ A}$$

KCL then yields  $\mathbf{I}_s = \mathbf{I}_{R_2} + \mathbf{I}_C = 1 \angle -62^\circ + \frac{1}{2} \angle -62^\circ = (3/2) \angle -62^\circ$  A. (We should note the addition of these polar quantities was trivial since the resistor and capacitor currents have the same angle, i.e., are in phase.)

Thus  $\mathbf{I}_s$  and knowledge of  $\omega$  permit us to write  $i_s(t)$  directly:

$$i_s(t) = 1.5 \cos(2t - 62^\circ) \text{ A}$$

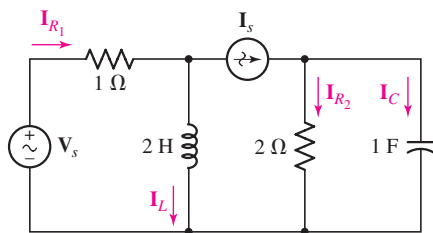

FIGURE 10.17 A three-mesh circuit. Each source operates at the same frequency  $\omega$ .

## PRACTICE

10.8 In the circuit of Fig. 10.17, both sources operate at  $\omega = 1$  rad/s. If  $\mathbf{I}_C = 2/28^\circ$  A and  $\mathbf{I}_L = 3/53^\circ$  A, calculate (a)  $\mathbf{I}_s$ ; (b)  $\mathbf{V}_s$ ; (c)  $i_{R_1}(t)$ .

Ans: (a)  $3 \angle -62^\circ$  A; (b)  $3.71 \angle -4.5^\circ$  V; (c)  $3.22 \cos(t - 4.5^\circ)$  A.

## 10.5 IMPEDANCE AND ADMITTANCE

The current-voltage relationships for the three passive elements in the frequency domain are (assuming that the passive sign convention is satisfied)

$$\mathbf{V} = R\mathbf{I} \quad \mathbf{V} = j\omega L\mathbf{I} \quad \mathbf{V} = \frac{\mathbf{I}}{j\omega C}$$

If these equations are written as phasor voltage/phasor current ratios

$$\frac{\mathbf{V}}{\mathbf{I}} = R \quad \frac{\mathbf{V}}{\mathbf{I}} = j\omega L \quad \frac{\mathbf{V}}{\mathbf{I}} = \frac{1}{j\omega C}$$

we find that these ratios are simple quantities that depend on element values (and frequency also, in the case of inductance and capacitance). We treat these ratios in the same manner that we treat resistances, provided we remember that they are complex quantities.

Let us define the ratio of the phasor voltage to the phasor current as *impedance*, symbolized by the letter  $\mathbf{Z}$ . The impedance is a complex quantity having the dimensions of ohms. Impedance is not a phasor and cannot be transformed to the time domain by multiplying by  $e^{j\omega t}$  and taking the real part. Instead, we think of an inductor as being represented in the time domain by its inductance  $L$  and in the frequency domain by its impedance  $j\omega L$ . A capacitor in the time domain has a capacitance  $C$ ; in the frequency domain, it has an impedance  $1/j\omega C$ . Impedance is a part of the frequency domain and not a concept that is a part of the time domain.



$$\begin{aligned} Z_R &= R \\ Z_L &= j\omega L \\ Z_C &= \frac{1}{j\omega C} \end{aligned}$$

### Series Impedance Combinations

The validity of Kirchhoff's two laws in the frequency domain leads to the fact that impedances may be combined in series and parallel by the same rules we established for resistances. For example, at  $\omega = 10 \times 10^3$  rad/s, a 5 mH inductor in series with a 100  $\mu$ F capacitor may be replaced by the sum of the individual impedances. The impedance of the inductor is

$$\mathbf{Z}_L = j\omega L = j50 \Omega$$

and the impedance of the capacitor is

$$\mathbf{Z}_C = \frac{1}{j\omega C} = \frac{-j}{\omega C} = -j1 \Omega$$

The impedance of the series combination is therefore

$$\mathbf{Z}_{\text{eq}} = \mathbf{Z}_L + \mathbf{Z}_C = j50 - j1 = j49 \Omega$$

The impedance of inductors and capacitors is a function of frequency, and this equivalent impedance is thus applicable only at the single frequency at which it was calculated,  $\omega = 10,000$  rad/s. If we change the frequency to  $\omega = 5000$  rad/s, for example,  $\mathbf{Z}_{\text{eq}} = j23 \Omega$ .

Note that  $\frac{1}{j} = -j$ .



### Parallel Impedance Combinations

The *parallel* combination of the 5 mH inductor and the 100  $\mu$ F capacitor at  $\omega = 10,000$  rad/s is calculated in exactly the same fashion in which we

calculated parallel resistances:

$$\mathbf{Z}_{\text{eq}} = \frac{(j50)(-j1)}{j50 - j1} = \frac{50}{j49} = -j1.020 \Omega$$

At  $\omega = 5000 \text{ rad/s}$ , the parallel equivalent is  $-j2.17 \Omega$ .

## Reactance

Of course, we may choose to express impedance in either *rectangular* ( $\mathbf{Z} = R + jX$ ) or *polar* ( $\mathbf{Z} = |\mathbf{Z}|/\theta$ ) form. In rectangular form, we can see clearly the real part which arises only from real resistances, and an imaginary component, termed the **reactance**, which arises from the energy storage elements. Both resistance and reactance have units of ohms, but reactance will always depend upon frequency. An ideal resistor has zero reactance; an ideal inductor or capacitor is purely reactive (i.e., characterized by zero resistance). Can a series or parallel combination include *both* a capacitor and an inductor, and yet have *zero reactance*? Sure! Consider the series connection of a  $1 \Omega$  resistor, a  $1 \text{ F}$  capacitor, and a  $1 \text{ H}$  inductor driven at  $\omega = 1 \text{ rad/s}$ .  $\mathbf{Z}_{\text{eq}} = 1 - j(1)(1) + j(1)(1) = 1 \Omega$ . At that particular frequency, the equivalent is a simple  $1 \Omega$  resistor. However, even small deviations from  $\omega = 1 \text{ rad/s}$  lead to nonzero reactance.

### EXAMPLE 10.6

Determine the equivalent impedance of the network shown in Fig. 10.18a, given an operating frequency of  $5 \text{ rad/s}$ .

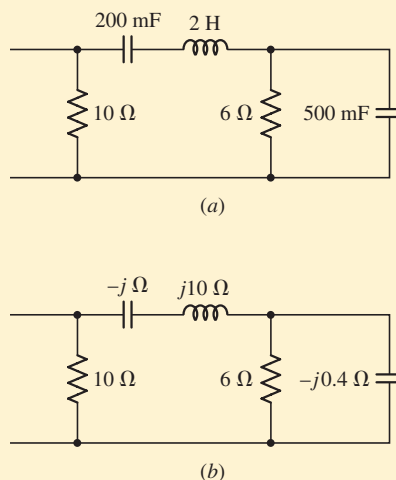

■ FIGURE 10.18 (a) A network that is to be replaced by a single equivalent impedance. (b) The elements are replaced by their impedances at  $\omega = 5 \text{ rad/s}$ .

We begin by converting the resistors, capacitors, and inductor into the corresponding impedances as shown in Fig. 10.18b.



Upon examining the resulting network, we observe that the  $6\ \Omega$  impedance is in parallel with  $-j0.4\ \Omega$ . This combination is equivalent to

$$\frac{(6)(-j0.4)}{6 - j0.4} = 0.02655 - j0.3982\ \Omega$$

which is in series with both the  $-j\ \Omega$  and  $j10\ \Omega$  impedances, so that we have

$$0.0265 - j0.3982 - j + j10 = 0.02655 + j8.602\ \Omega$$

This new impedance is in parallel with  $10\ \Omega$ , so that the equivalent impedance of the network is

$$\begin{aligned} 10 \parallel (0.02655 + j8.602) &= \frac{10(0.02655 + j8.602)}{10 + 0.02655 + j8.602} \\ &= 4.255 + j4.929\ \Omega \end{aligned}$$

Alternatively, we can express the impedance in polar form as  $6.511/49.20^\circ\ \Omega$ .

### PRACTICE

10.9 With reference to the network shown in Fig. 10.19, find the input impedance  $\mathbf{Z}_{in}$  that would be measured between terminals: (a)  $a$  and  $g$ ; (b)  $b$  and  $g$ ; (c)  $a$  and  $b$ .

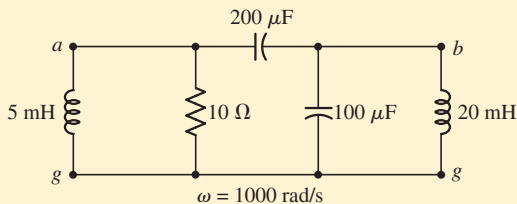

FIGURE 10.19

Ans:  $2.81 + j4.49\ \Omega$ ;  $1.798 - j1.124\ \Omega$ ;  $0.1124 - j3.82\ \Omega$ .

It is important to note that the resistive component of the impedance is not necessarily equal to the resistance of the resistor that is present in the network. For example, a  $10\ \Omega$  resistor and a  $5\ \text{H}$  inductor in series at  $\omega = 4\ \text{rad/s}$  have an equivalent impedance  $\mathbf{Z} = 10 + j20\ \Omega$ , or, in polar form,  $22.4/63.4^\circ\ \Omega$ . In this case, the resistive component of the impedance is equal to the resistance of the series resistor because the network is a simple series network. However, if these same two elements are placed in parallel, the equivalent impedance is  $10(j20)/(10 + j20)\ \Omega$ , or  $8 + j4\ \Omega$ . The resistive component of the impedance is now  $8\ \Omega$ .



## EXAMPLE 10.7

Find the current  $i(t)$  in the circuit shown in Fig. 10.20a.

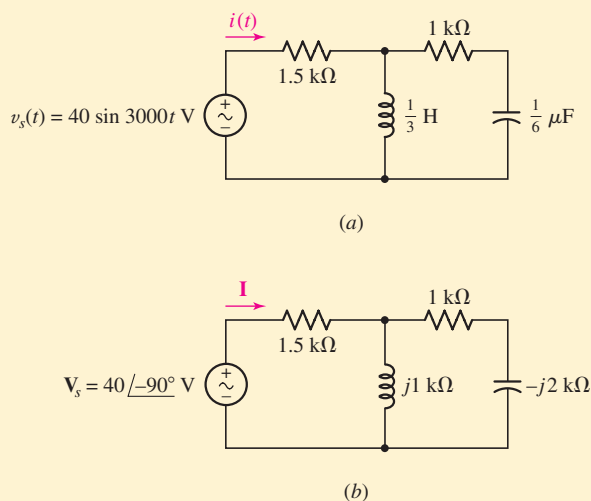

■ FIGURE 10.20 (a) An  $RLC$  circuit for which the sinusoidal forced response  $i(t)$  is desired. (b) The frequency-domain equivalent of the given circuit at  $\omega = 3000$  rad/s.

► **Identify the goal of the problem.**

We need to find the sinusoidal steady-state current flowing through the  $1.5\text{ k}\Omega$  resistor due to the  $3000$  rad/s voltage source.

► **Collect the known information.**

We begin by drawing a frequency-domain circuit. The source is transformed to the frequency-domain representation  $40\angle-90^\circ$  V, the frequency domain response is represented as  $\mathbf{I}$ , and the impedances of the inductor and capacitor, determined at  $\omega = 3000$  rad/s, are  $j\text{ k}\Omega$  and  $-j2\text{ k}\Omega$ , respectively. The corresponding frequency-domain circuit is shown in Fig. 10.20b.

► **Devise a plan.**

We will analyze the circuit of Fig. 10.20b to obtain  $\mathbf{I}$ ; combining impedances and invoking Ohm's law is one possible approach. We will then make use of the fact that we know  $\omega = 3000$  rad/s to convert  $\mathbf{I}$  into a time-domain expression.

► **Construct an appropriate set of equations.**

$$\begin{aligned} \mathbf{Z}_{\text{eq}} &= 1.5 + \frac{(j)(1 - 2j)}{j + 1 - 2j} = 1.5 + \frac{2 + j}{1 - j} \\ &= 1.5 + \frac{2 + j}{1 - j} \frac{1 + j}{1 + j} = 1.5 + \frac{1 + j3}{2} \\ &= 2 + j1.5 = 2.5\angle36.87^\circ \text{ k}\Omega \end{aligned}$$

The phasor current is then simply

$$\mathbf{I} = \frac{\mathbf{V}_s}{\mathbf{Z}_{\text{eq}}}$$

► **Determine if additional information is required.**

Substituting known values, we find that

$$\mathbf{I} = \frac{40/-90^\circ}{2.5/36.87^\circ} \text{ mA}$$

which, along with the knowledge that  $\omega = 3000 \text{ rad/s}$ , is sufficient to solve for  $i(t)$ .

► **Attempt a solution.**

This complex expression is easily simplified to a single complex number in polar form:

$$\mathbf{I} = \frac{40}{2.5} \angle_{-90^\circ - 36.87^\circ} \text{ mA} = 16.00 \angle_{-126.9^\circ} \text{ mA}$$

Upon transforming the current to the time domain, the desired response is obtained:

$$i(t) = 16 \cos(3000t - 126.9^\circ) \text{ mA}$$

► **Verify the solution. Is it reasonable or expected?**

The effective impedance connected to the source has an angle of  $+36.87^\circ$ , indicating that it has a net inductive character, or that the current will lag the voltage. Since the voltage source has a phase angle of  $-90^\circ$  (once converted to a cosine source), we see that our answer is consistent.

## PRACTICE

10.10 In the frequency-domain circuit of Fig. 10.21, find (a)  $\mathbf{I}_1$ ; (b)  $\mathbf{I}_2$ ; (c)  $\mathbf{I}_3$ .

Ans:  $28.3/45^\circ \text{ A}$ ;  $20/90^\circ \text{ A}$ ;  $20/0^\circ \text{ A}$ .

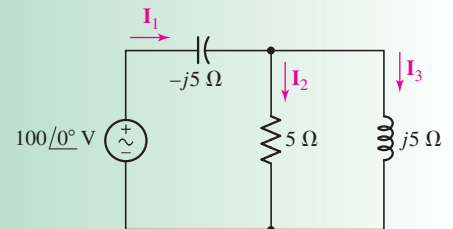

FIGURE 10.21

Before we begin to write great numbers of equations in the time domain or in the frequency domain, it is very important that we shun the construction of equations that are partly in the time domain, partly in the frequency domain, and wholly incorrect. One clue that a faux pas of this type has been committed is the sight of both a complex number and a  $t$  in the same equation, except in the factor  $e^{j\omega t}$ . And, since  $e^{j\omega t}$  plays a much bigger role in derivations than in applications, it is pretty safe to say that students who find they have just created an equation containing  $j$  and  $t$ , or  $\underline{\quad}$  and  $t$ , have created a monster that the world would be better off without.



For example, a few equations back we saw

$$\mathbf{I} = \frac{\mathbf{V}_s}{\mathbf{Z}_{\text{eq}}} = \frac{40\angle-90^\circ}{2.5\angle36.9^\circ} = 16\angle-126.9^\circ \text{ mA}$$

Please do not try anything like the following:

$$i(t) \not\propto \frac{40 \sin 3000t}{2.5\angle36.9^\circ} \quad \text{or} \quad i(t) \not\propto \frac{40 \sin 3000t}{2 + j1.5}$$

## Admittance

Although the concept of impedance is very useful, and familiar in a way based on our experience with resistors, the reciprocal is often just as valuable. We define this quantity as the **admittance**  $\mathbf{Y}$  of a circuit element or passive network, and it is simply the ratio of current to voltage:

The real part of the admittance is the **conductance**  $G$ , and the imaginary part is the **susceptance**  $B$ . All three quantities ( $\mathbf{Y}$ ,  $G$ , and  $B$ ) are measured in siemens.

The real part of the admittance is the **conductance**  $G$ , and the imaginary part of the admittance is the **susceptance**  $B$ . Thus,

$$\mathbf{Y} = G + jB = \frac{1}{\mathbf{Z}} = \frac{1}{R + jX} \quad [22]$$

Equation [22] should be scrutinized carefully; it does *not* state that the real part of the admittance is equal to the reciprocal of the real part of the impedance, or that the imaginary part of the admittance is equal to the reciprocal of the imaginary part of the impedance!

$$Y_R = \frac{1}{R}$$

$$Y_L = \frac{1}{j\omega L}$$

$$Y_C = j\omega C$$

There is a general (unitless) term for both impedance and admittance—**impittance**—which is sometimes used, but not very often.



### PRACTICE

10.11 Determine the admittance (in rectangular form) of (a) an impedance  $\mathbf{Z} = 1000 + j400 \Omega$ ; (b) a network consisting of the parallel combination of an  $800 \Omega$  resistor, a  $1 \text{ mH}$  inductor, and a  $2 \text{ nF}$  capacitor, if  $\omega = 1 \text{ Mrad/s}$ ; (c) a network consisting of the series combination of an  $800 \Omega$  resistor, a  $1 \text{ mH}$  inductor, and a  $2 \text{ nF}$  capacitor, if  $\omega = 1 \text{ Mrad/s}$ .

Ans:  $0.862 - j0.345 \text{ mS}$ ;  $1.25 + j1 \text{ mS}$ ;  $0.899 - j0.562 \text{ mS}$ .

## 10.6 NODAL AND MESH ANALYSIS

We previously achieved a great deal with nodal and mesh analysis techniques, and it's reasonable to ask if a similar procedure might be valid in terms of phasors and impedances for the sinusoidal steady state. We already know that both of Kirchhoff's laws are valid for phasors; also, we have an Ohm-like law for the passive elements  $\mathbf{V} = \mathbf{Z}\mathbf{I}$ . We may therefore analyze circuits by nodal techniques in the sinusoidal steady state. Using similar arguments, we can establish that mesh analysis methods are valid (and often useful) as well.

## EXAMPLE 10.8

Find the time-domain node voltages  $v_1(t)$  and  $v_2(t)$  in the circuit shown in Fig. 10.22.

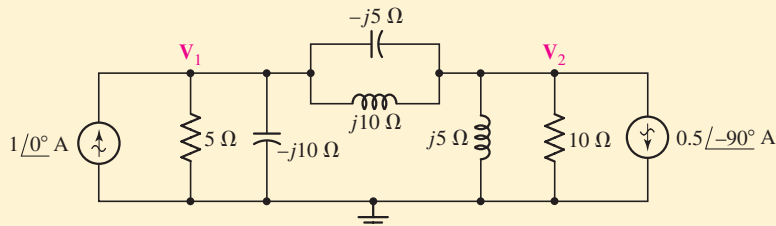

FIGURE 10.22 A frequency-domain circuit for which node voltages  $V_1$  and  $V_2$  are identified.

Two current sources are given as phasors, and phasor node voltages  $V_1$  and  $V_2$  are indicated. At the left node we apply KCL, yielding:

$$\frac{V_1}{5} + \frac{V_1}{-j10} + \frac{V_1 - V_2}{-j5} + \frac{V_1 - V_2}{j10} = 1\angle 0^\circ = 1 + j0$$

At the right node,

$$\frac{V_2 - V_1}{-j5} + \frac{V_2 - V_1}{j10} + \frac{V_2}{j5} + \frac{V_2}{10} = -(0.5\angle -90^\circ) = j0.5$$

Combining terms, we have

$$(0.2 + j0.2)V_1 - j0.1V_2 = 1$$

and

$$-j0.1V_1 + (0.1 - j0.1)V_2 = j0.5$$

These equations are easily solved on most scientific calculators, resulting in  $V_1 = 1 - j2$  V and  $V_2 = -2 + j4$  V.

The time-domain solutions are obtained by expressing  $V_1$  and  $V_2$  in polar form:

$$\begin{aligned} V_1 &= 2.24\angle -63.4^\circ \\ V_2 &= 4.47\angle 116.6^\circ \end{aligned}$$

and passing to the time domain:

$$\begin{aligned} v_1(t) &= 2.24 \cos(\omega t - 63.4^\circ) & \text{V} \\ v_2(t) &= 4.47 \cos(\omega t + 116.6^\circ) & \text{V} \end{aligned}$$

Note that the value of  $\omega$  would have to be known in order to compute the impedance values given on the circuit diagram. Also, *both sources must be operating at the same frequency.*

(Continued on next page)

## PRACTICE

10.12 Use nodal analysis on the circuit of Fig. 10.23 to find  $V_1$  and  $V_2$ .

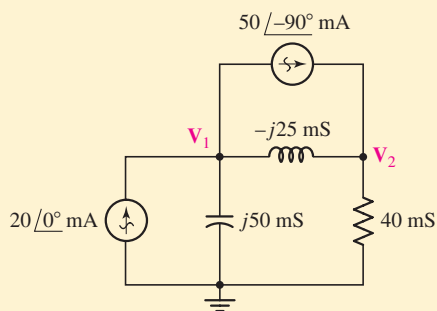

FIGURE 10.23

Ans:  $1.062/23.3^\circ$  V;  $1.593/-50.0^\circ$  V.



Now let us look at an example of mesh analysis, keeping in mind again that all sources must be operating at the same frequency. Otherwise, it is impossible to define a numerical value for any reactance in the circuit. As we see in the next section, the only way out of such a dilemma is to apply superposition.

## EXAMPLE 10.9

Obtain expressions for the time-domain currents  $i_1$  and  $i_2$  in the circuit given as Fig. 10.24a.

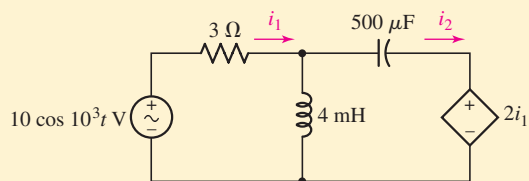

(a)

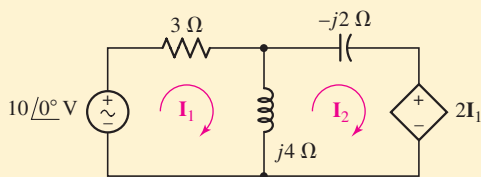

(b)

FIGURE 10.24 (a) A time-domain circuit containing a dependent source. (b) The corresponding frequency-domain circuit.

Noting from the left source that  $\omega = 10^3$  rad/s, we draw the frequency-domain circuit of Fig. 10.24b and assign mesh currents  $\mathbf{I}_1$  and  $\mathbf{I}_2$ . Around mesh 1,

$$3\mathbf{I}_1 + j4(\mathbf{I}_1 - \mathbf{I}_2) = 10\angle 0^\circ$$

or

$$(3 + j4)\mathbf{I}_1 - j4\mathbf{I}_2 = 10$$

while mesh 2 leads to

$$j4(\mathbf{I}_2 - \mathbf{I}_1) - j2\mathbf{I}_2 + 2\mathbf{I}_1 = 0$$

or

$$(2 - j4)\mathbf{I}_1 + j2\mathbf{I}_2 = 0$$

Solving,

$$\mathbf{I}_1 = \frac{14 + j8}{13} = 1.24\angle 29.7^\circ \text{ A}$$

$$\mathbf{I}_2 = \frac{20 + j30}{13} = 2.77\angle 56.3^\circ \text{ A}$$

Hence,

$$i_1(t) = 1.24 \cos(10^3 t + 29.7^\circ) \quad \text{A}$$

$$i_2(t) = 2.77 \cos(10^3 t + 56.3^\circ) \quad \text{A}$$

### PRACTICE

10.13 Use mesh analysis on the circuit of Fig. 10.25 to find  $\mathbf{I}_1$  and  $\mathbf{I}_2$ .

Ans:  $4.87\angle -164.6^\circ$  A;  $7.17\angle -144.9^\circ$  A.

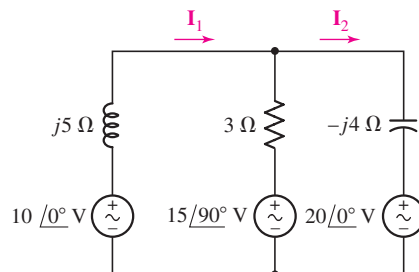

FIGURE 10.25

## 10.7 SUPERPOSITION, SOURCE TRANSFORMATIONS, AND THÉVENIN'S THEOREM

After inductors and capacitors were introduced in Chap. 7, we found that circuits containing these elements were still linear, and that the benefits of linearity were again available. Included among these were the superposition principle, Thévenin's and Norton's theorems, and source transformations. Thus, we know that these methods may be used on the circuits we are now considering; the fact that we happen to be applying sinusoidal sources and are seeking only the forced response is immaterial. The fact that we are analyzing the circuits in terms of phasors is also immaterial; they are still linear circuits. We might also remember that linearity and superposition were invoked when we combined real and imaginary sources to obtain a complex source.

# PRACTICAL APPLICATION

## Cutoff Frequency of a Transistor Amplifier

Transistor-based amplifier circuits are an integral part of many modern electronic instruments. One common application is in mobile telephones (Fig. 10.26), where audio signals are superimposed on high-frequency carrier waves. Unfortunately, transistors have built-in capacitances that lead to limitations in the frequencies at which they can be used, and this fact must be considered when choosing a transistor for a particular application.



■ FIGURE 10.26 Transistor amplifiers are used in many devices, including mobile phones. Linear circuit models are often used to analyze their performance as a function of frequency. © PNC/Getty Images/RF.

Figure 10.27a shows what is commonly referred to as a *high-frequency hybrid- $\pi$  model* for a bipolar junction transistor. In practice, although transistors are *non-linear* devices, we find that this simple *linear* circuit does a reasonably accurate job of modeling the actual device behavior. The two capacitors  $C_\pi$  and  $C_\mu$  are used to represent internal capacitances that characterize the particular transistor being used; additional capacitors as well as resistors can be added to increase the accuracy of the model as needed. Figure 10.27b shows the transistor model inserted into an amplifier circuit known as a common emitter amplifier.

Assuming a sinusoidal steady-state signal represented by its Thévenin equivalent  $V_s$  and  $R_s$ , we are interested in the ratio of the output voltage  $V_{out}$  to the input voltage  $V_{in}$ . The presence of the internal transistor capacitances leads to a reduction in amplification as the frequency of  $V_s$  is increased; this ultimately limits the frequencies at which the circuit will operate properly. Writing a single nodal equation at the output yields

$$-g_m V_\pi = \frac{V_{out} - V_{in}}{1/j\omega C_\mu} + \frac{V_{out}}{R_C \parallel R_L}$$

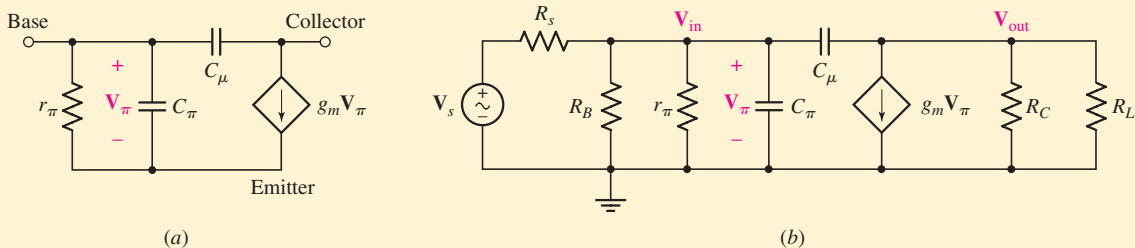

■ FIGURE 10.27 (a) High-frequency hybrid- $\pi$  transistor model. (b) Common-emitter amplifier circuit using the hybrid- $\pi$  transistor model.

One final comment is in order. Up to this point, we have restricted ourselves to considering either single-source circuits or multiple-source circuits in which *every source operates at the exact same frequency*. This is necessary in order to define specific impedance values for inductive and capacitive elements. However, the concept of phasor analysis can be easily extended to circuits with multiple sources operating at different frequencies. In such





Solving for  $V_{out}$  in terms of  $V_{in}$ , and noting that  $V_{\pi} = V_{in}$ , we obtain an expression for the amplifier gain

$$\begin{aligned} \frac{V_{out}}{V_{in}} &= \frac{-g_m(R_C \parallel R_L)(1/j\omega C_{\mu}) + (R_C \parallel R_L)}{(R_C \parallel R_L) + (1/j\omega C_{\mu})} \\ &= \frac{-g_m(R_C \parallel R_L) + j\omega(R_C \parallel R_L)C_{\mu}}{1 + j\omega(R_C \parallel R_L)C_{\mu}} \end{aligned}$$

Given the typical values  $g_m = 30 \text{ mS}$ ,  $R_C = R_L = 2 \text{ k}\Omega$ , and  $C_{\mu} = 5 \text{ pF}$ , we can plot the magnitude of the gain as a function of frequency (recalling that  $\omega = 2\pi f$ ). The semilogarithmic plot is shown in Fig. 10.28a, and the MATLAB script used to generate the figure is given in Fig. 10.28b. It is interesting, but maybe not totally surprising, to see that a characteristic such as the amplifier gain is dependent on frequency. In fact, we might be able to contemplate using such a circuit as a means of filtering out frequencies we aren't interested in. However, at least for relatively low frequencies, we see that the gain is essentially independent of the frequency of our input source.

When characterizing amplifiers, it is common to reference the frequency at which the gain is reduced to  $1/\sqrt{2}$  times its maximum value. From Fig. 10.28a, we see that the maximum gain magnitude is 30, and the gain magnitude is reduced to  $30/\sqrt{2} = 21$  at a frequency of approximately 30 MHz. This frequency is often called the *cutoff* or *corner* frequency of the amplifier. If operation at a higher frequency is required, either the internal capacitances must be reduced (i.e., a different transistor must be used) or the circuit must be redesigned in some way.

We should note at this point that defining the gain relative to  $V_{in}$  does not present a complete picture of the frequency-dependent behavior of the amplifier. This may be apparent if we briefly consider the capacitance  $C_{\pi}$ : as  $\omega \rightarrow \infty$ ,  $Z_{C_{\pi}} \rightarrow 0$ , so  $V_{in} \rightarrow 0$ . This effect does not manifest itself in the simple equation we derived. A more comprehensive approach is to develop an equation for  $V_{out}$  in terms of  $V_s$ , in which case both capacitances will appear in the expression; this requires a little bit more algebra.

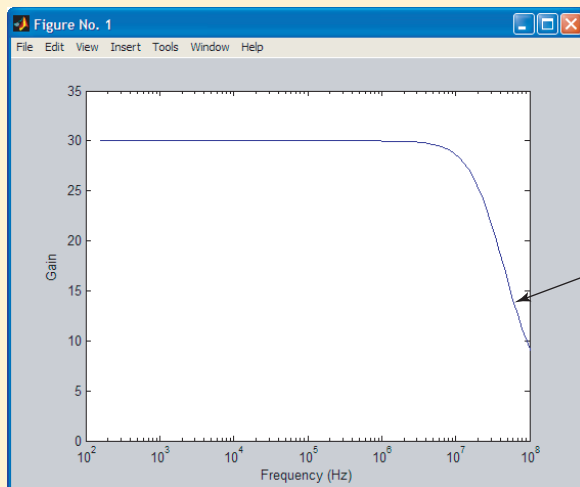

(a)

No longer  
amplifying  
effectively

```
EDU» frequency = logspace(3,9,100);
EDU» numerator = -30e-3*1000 + i*frequency*1000*5e-12;
EDU» denominator = 1 + i*frequency*1000*5e-12;
EDU» for k = 1:100
EDU» gain(k) = abs(numerator(k)/denominator(k));
EDU» end
EDU» semilogx(frequency/2/pi,gain);
EDU» xlabel('Frequency (Hz)');
EDU» ylabel('Gain');
EDU» axis([100 1e8 0 35]);
```

(b)

FIGURE 10.28 (a) Amplifier gain as a function of frequency. (b) MATLAB script used to create plot.

instances, we simply employ superposition to determine the voltages and currents due to each source, and then add the results *in the time domain*. If several sources are operating at the same frequency, superposition will also allow us to consider those sources at the same time, and add the resulting response to the response(s) of any other source(s) operating at a different frequency.



## EXAMPLE 10.10

Use superposition to find  $V_1$  for the circuit of Fig. 10.22, repeated as Fig. 10.29a for convenience.

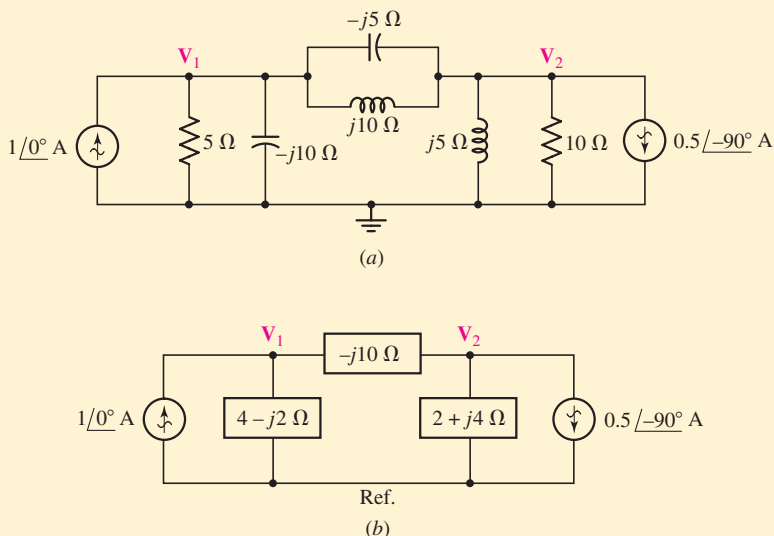

FIGURE 10.29 (a) Circuit of Fig. 10.22 for which  $V_1$  is desired, (b)  $V_1$  may be found by using superposition of the separate phasor responses.

First we redraw the circuit as Fig. 10.29b, where each pair of parallel impedances is replaced by a single equivalent impedance. That is,  $5 \parallel -j10 \Omega$  is  $4 - j2 \Omega$ ;  $j10 \parallel -j5 \Omega$  is  $-j10 \Omega$ ; and  $10 \parallel j5$  is equal to  $2 + j4 \Omega$ . To find  $V_1$ , we first activate only the left source and find the partial response,  $V_{1L}$ . The  $1/0^\circ$  source is in parallel with an impedance of

$$(4 - j2) \parallel (-j10 + 2 + j4)$$

so that

$$\begin{aligned} V_{1L} &= 1/0^\circ \frac{(4 - j2)(-j10 + 2 + j4)}{4 - j2 - j10 + 2 + j4} \\ &= \frac{-4 - j28}{6 - j8} = 2 - j2 \text{ V} \end{aligned}$$

With only the right source active, current division and Ohm's law yield

$$V_{1R} = (-0.5/-90^\circ) \left( \frac{2 + j4}{4 - j2 - j10 + 2 + j4} \right) (4 - j2) = -1 \text{ V}$$

Summing, then,

$$V_1 = V_{1L} + V_{1R} = 2 - j2 - 1 = 1 - j2 \text{ V}$$

which agrees with our previous result from Example 10.8.

As we will see, superposition is also extremely useful when dealing with a circuit in which not all sources operate at the same frequency.

## PRACTICE

10.14 If superposition is used on the circuit of Fig. 10.30, find  $V_1$  with (a) only the  $20\angle 0^\circ$  mA source operating; (b) only the  $50\angle -90^\circ$  mA source operating.

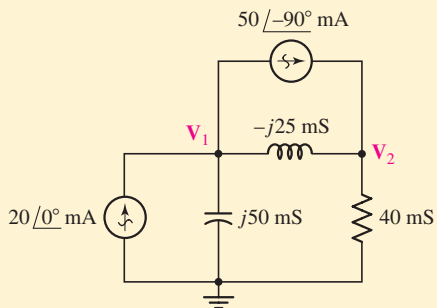

FIGURE 10.30

Ans:  $0.1951 - j0.556$  V;  $0.780 + j0.976$  V.

## EXAMPLE 10.11

Determine the Thévenin equivalent seen by the  $-j10\ \Omega$  impedance of Fig. 10.31a, and use this to compute  $V_1$ .

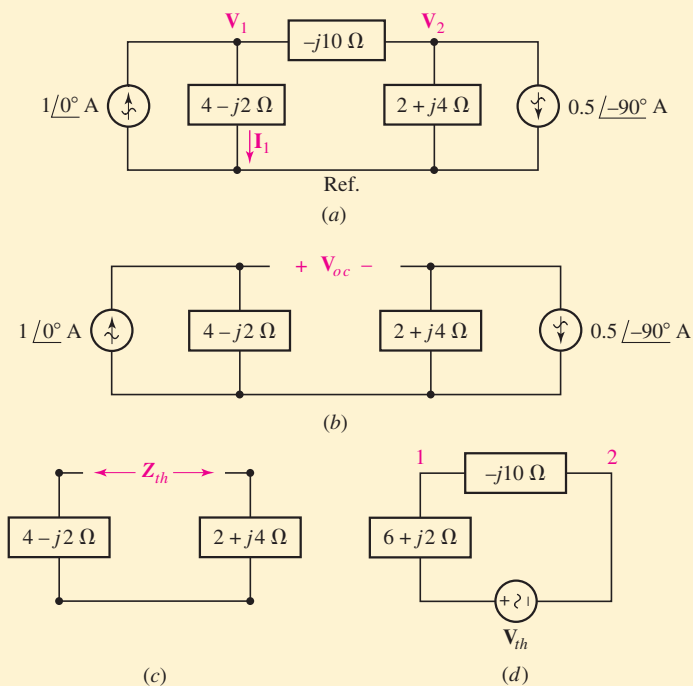

FIGURE 10.31 (a) Circuit of Fig. 10.29b. The Thévenin equivalent seen by the  $-j10\ \Omega$  impedance is desired. (b)  $V_{oc}$  is defined. (c)  $Z_{th}$  is defined. (d) The circuit is redrawn using the Thévenin equivalent.

(Continued on next page)

The open-circuit voltage, defined in Fig. 10.31*b*, is

$$\begin{aligned} \mathbf{V}_{oc} &= (1\angle 0^\circ)(4 - j2) - (-0.5\angle -90^\circ)(2 + j4) \\ &= 4 - j2 + 2 - j1 = 6 - j3 \quad \text{V} \end{aligned}$$

The impedance of the inactive circuit of Fig. 10.31*c* as viewed from the load terminals is simply the sum of the two remaining impedances. Hence,

$$\mathbf{Z}_{th} = 6 + j2 \, \Omega$$

Thus, when we reconnect the circuit as in Fig. 10.31*d*, the current directed from node 1 toward node 2 through the  $-j10 \, \Omega$  load is

$$\mathbf{I}_{12} = \frac{6 - j3}{6 + j2 - j10} = 0.6 + j0.3 \, \text{A}$$

We now know the current flowing through the  $-j10 \, \Omega$  impedance of Fig. 10.31*a*. Note that we are unable to compute  $\mathbf{V}_1$  using the circuit of Fig. 10.31*d* as the reference node no longer exists. Returning to the original circuit, then, and subtracting the  $0.6 + j0.3 \, \text{A}$  current from the left source current, the downward current through the  $(4 - j2) \, \Omega$  branch is found:

$$\mathbf{I}_1 = 1 - 0.6 - j0.3 = 0.4 - j0.3 \quad \text{A}$$

and, thus,

$$\mathbf{V}_1 = (0.4 - j0.3)(4 - j2) = 1 - j2 \quad \text{V}$$

as before.

We might have been clever and used Norton's theorem on the three elements on the right of Fig. 10.31*a*, assuming that our chief interest is in  $\mathbf{V}_1$ . Source transformations can also be used repeatedly to simplify the circuit. Thus, all the shortcuts and tricks that arose in Chaps. 4 and 5 are available for circuit analysis in the frequency domain. The slight additional complexity that is apparent now arises from the necessity of using complex numbers and not from any more involved theoretical considerations.

## PRACTICE

10.15 For the circuit of Fig. 10.32, find the (a) open-circuit voltage  $\mathbf{V}_{ab}$ ; (b) downward current in a short circuit between *a* and *b*; (c) Thévenin equivalent impedance  $\mathbf{Z}_{ab}$  in parallel with the current source.

Ans:  $16.77\angle -33.4^\circ \, \text{V}$ ;  $2.60 + j1.500 \, \text{A}$ ;  $2.5 - j5 \, \Omega$ .

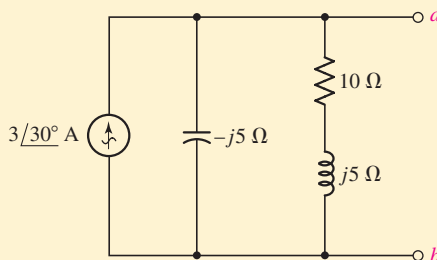

FIGURE 10.32

## EXAMPLE 10.12

Determine the power dissipated by the  $10\ \Omega$  resistor in the circuit of Fig. 10.33a.

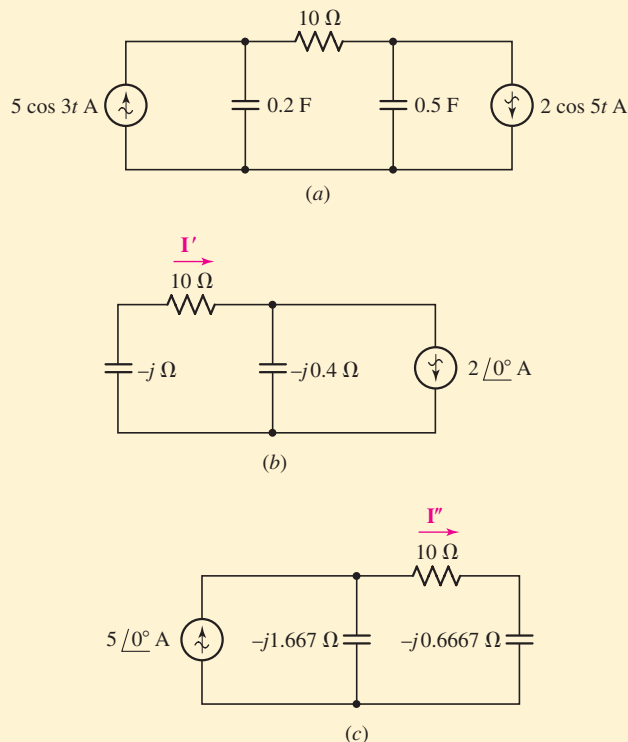

FIGURE 10.33 (a) A simple circuit having sources operating at different frequencies. (b) Circuit with the left source killed. (c) Circuit with the right source killed.

After glancing at the circuit, we might be tempted to write two quick nodal equations, or perhaps perform two sets of source transformations and launch immediately into finding the voltage across the  $10\ \Omega$  resistor.

Unfortunately, this is impossible, since we have *two* sources operating at *different* frequencies. In such a situation, there is no way to compute the impedance of any capacitor or inductor in the circuit—which  $\omega$  would we use?

The only way out of this dilemma is to employ superposition, grouping all sources with the same frequency in the same subcircuit, as shown in Fig. 10.33b and c.

In the subcircuit of Fig. 10.33b, we quickly compute the current  $\mathbf{I}'$  using current division:

$$\begin{aligned}\mathbf{I}' &= 2\angle 0^\circ \left[ \frac{-j0.4}{10 - j - j0.4} \right] \\ &= 79.23\angle -82.03^\circ \text{ mA}\end{aligned}$$

(Continued on next page)

In future studies of signal processing, we will also be introduced to the method of Jean-Baptiste Joseph Fourier, a French mathematician who developed a technique for representing almost any arbitrary function by a combination of sinusoids. When working with linear circuits, once we know the response of a particular circuit to a general sinusoidal forcing function, we can easily predict the response of the circuit to an arbitrary waveform represented by a Fourier series function, simply by using superposition.

so that

$$i' = 79.23 \cos(5t - 82.03^\circ) \quad \text{mA}$$

Likewise, we find that

$$\begin{aligned} \mathbf{I}'' &= 5 \angle 0^\circ \left[ \frac{-j1.667}{10 - j0.6667 - j1.667} \right] \\ &= 811.7 \angle -76.86^\circ \text{ mA} \end{aligned}$$

so that

$$i'' = 811.7 \cos(3t - 76.86^\circ) \quad \text{mA}$$



It should be noted at this point that no matter how tempted we might be to add the two phasor currents  $\mathbf{I}$  and  $\mathbf{I}''$ , in Fig. 10.33*b* and *c*, this *would be incorrect*. Our next step is to add the two time-domain currents, square the result, and multiply by 10 to obtain the power absorbed by the 10  $\Omega$  resistor in Fig. 10.33*a*:

$$\begin{aligned} p_{10} &= (i' + i'')^2 \times 10 \\ &= 10[79.23 \cos(5t - 82.03^\circ) + 811.7 \cos(3t - 76.86^\circ)]^2 \quad \mu\text{W} \end{aligned}$$

### PRACTICE

10.16 Determine the current  $i$  through the 4  $\Omega$  resistor of Fig. 10.34.

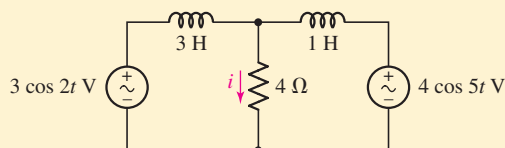

FIGURE 10.34

Ans:  $i = 175.6 \cos(2t - 20.55^\circ) + 547.1 \cos(5t - 43.16^\circ)$  mA.

## COMPUTER-AIDED ANALYSIS

We have several options in PSpice for the analysis of circuits in the sinusoidal steady state. Perhaps the most straightforward approach is to make use of two specially designed sources: VAC and IAC. The magnitude and phase of either source is selected by double-clicking on the part.

Let's simulate the circuit of Fig. 10.20*a*, shown redrawn in Fig. 10.35.

The frequency of the source is not selected through the Property Editor, but rather through the ac sweep analysis dialog box. This is accomplished by choosing **AC Sweep/Noise** for **Analysis** when presented with the Simulation Settings window. We select a **Linear** sweep

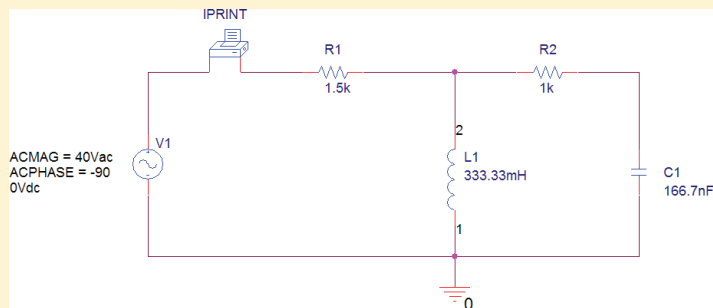

■ FIGURE 10.35 The circuit of Fig. 10.20a, operating at  $\omega = 3000$  rad/s. The current through the  $1.5\text{ k}\Omega$  resistor is desired.

and set **Total Points** to 1. Since we are only interested in the frequency of  $3000$  rad/s ( $477.5$  Hz), we set both **Start Frequency** and **End Frequency** to  $477.5$  as shown in Fig. 10.36.

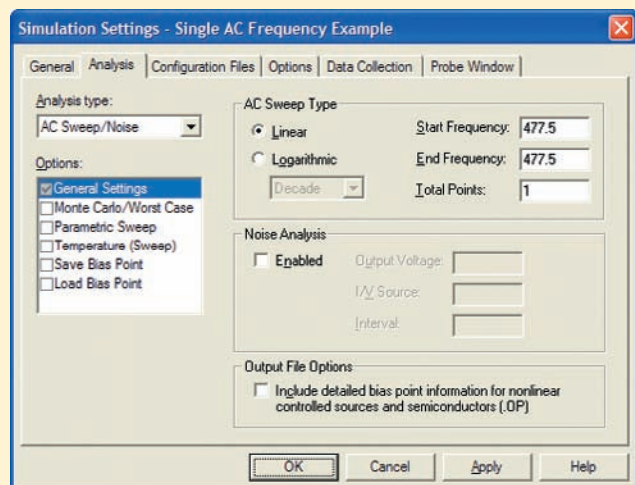

■ FIGURE 10.36 Dialog box for setting source frequency.

Note that an additional “component” appears in the schematic. This component is called **IPRINT**, and allows a variety of current parameters to be printed. In this simulation, we are interested in the **AC**, **MAG**, and **PHASE** attributes. In order for PSpice to print these quantities, double-click on the **IPRINT** symbol in the schematic, and enter *yes* in each of the appropriate fields.

The simulation results are obtained by choosing **View Output File** under **PSpice** in the Capture CIS window.

```
FREQ      IM(V_PRINT1)  IP(V_PRINT1)
4.775E+02  1.600E-02     -1.269E+02
```

Thus, the current magnitude is  $16\text{ mA}$ , and the phase angle is  $-126.9^\circ$ , so that the current through the  $1.5\text{ k}\Omega$  resistor is

$$\begin{aligned} i &= 16 \cos(3000t - 126.9^\circ) \quad \text{mA} \\ &= 16 \sin(3000t - 36.9^\circ) \quad \text{mA} \end{aligned}$$

## 10.8 PHASOR DIAGRAMS

The *phasor diagram* is a name given to a sketch in the complex plane showing the relationships of the phasor voltages and phasor currents throughout a specific circuit. We are already familiar with the use of the complex plane in the graphical identification of complex numbers and in their addition and subtraction. Since phasor voltages and currents are complex numbers, they may also be identified as points in a complex plane. For example, the phasor voltage  $\mathbf{V}_1 = 6 + j8 = 10\angle 53.1^\circ$  V is identified on the complex voltage plane shown in Fig. 10.37. The  $x$  axis is the real voltage axis, and the  $y$  axis is the imaginary voltage axis; the voltage  $\mathbf{V}_1$  is located by an arrow drawn from the origin. Since addition and subtraction are particularly easy to perform and display on a complex plane, phasors may be easily added and subtracted in a phasor diagram. Multiplication and division result in the addition and subtraction of angles and a change of amplitude. Figure 10.38a shows the sum of  $\mathbf{V}_1$  and a second phasor voltage  $\mathbf{V}_2 = 3 - j4 = 5\angle -53.1^\circ$  V, and Fig. 10.38b shows the current  $\mathbf{I}_1$ , which is the product of  $\mathbf{V}_1$  and the admittance  $\mathbf{Y} = 1 + j1$  S.

This last phasor diagram shows both current and voltage phasors on the same complex plane; it is understood that each will have its own amplitude scale, but a common angle scale. For example, a phasor voltage 1 cm long might represent 100 V, while a phasor current 1 cm long could indicate 3 mA. Plotting both phasors on the same diagram enables us to easily determine which waveform is leading and which is lagging.

The phasor diagram also offers an interesting interpretation of the time-domain to frequency-domain transformation, since the diagram may be interpreted from either the time- or the frequency-domain viewpoint. Up to this point, we have been using the frequency-domain interpretation, as we have been showing phasors directly on the phasor diagram. However, let us proceed to a time-domain viewpoint by first showing the phasor voltage  $\mathbf{V} = V_m\angle\alpha$  as sketched in Fig. 10.39a. In order to transform  $\mathbf{V}$  to the time domain, the next necessary step is the multiplication of the phasor by  $e^{j\omega t}$ ; thus we now have the complex voltage  $V_m e^{j\alpha} e^{j\omega t} = V_m\angle(\omega t + \alpha)$ . This voltage may also be interpreted as a phasor, one which possesses a phase angle that increases linearly with time. On a phasor diagram it therefore represents a rotating line segment, the instantaneous position being  $\omega t$  radians ahead (counterclockwise) of  $V_m\angle\alpha$ . Both  $V_m\angle\alpha$  and  $V_m\angle(\omega t + \alpha)$  are shown on the phasor diagram of Fig. 10.39b. The passage to the time

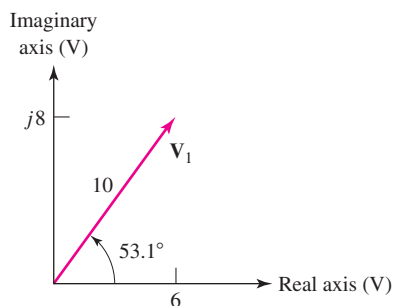

■ FIGURE 10.37 A simple phasor diagram shows the single voltage phasor  $\mathbf{V}_1 = 6 + j8 = 10\angle 53.1^\circ$  V.

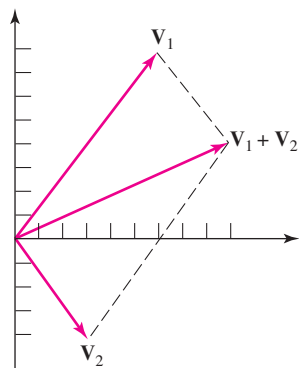

(a)

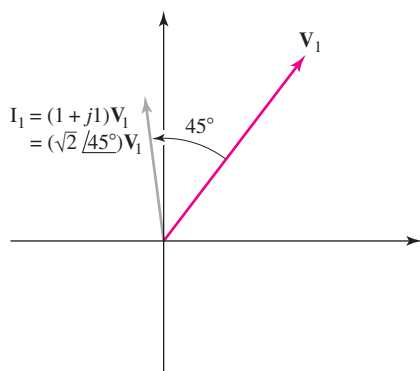

(b)

■ FIGURE 10.38 (a) A phasor diagram showing the sum of  $\mathbf{V}_1 = 6 + j8$  V and  $\mathbf{V}_2 = 3 - j4$  V,  $\mathbf{V}_1 + \mathbf{V}_2 = 9 + j4$  V  $= 9.85\angle 24.0^\circ$  V. (b) The phasor diagram shows  $\mathbf{V}_1$  and  $\mathbf{I}_1$ , where  $\mathbf{I}_1 = \mathbf{Y}\mathbf{V}_1$  and  $\mathbf{Y} = (1 + j1)$  S  $= \sqrt{2}\angle 45^\circ$  S. The current and voltage amplitude scales are different.

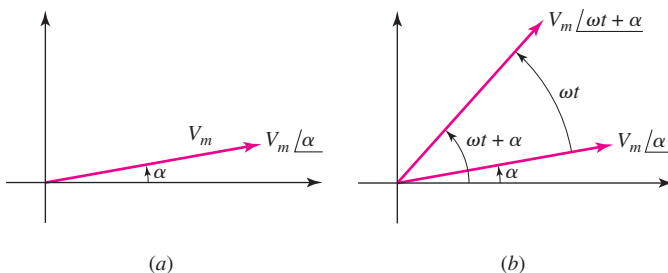

(a)

(b)

■ FIGURE 10.39 (a) The phasor voltage  $V_m\angle\alpha$ . (b) The complex voltage  $V_m\angle(\omega t + \alpha)$  is shown as a phasor at a particular instant of time. This phasor leads  $V_m\angle\alpha$  by  $\omega t$  radians.



domain is now completed by taking the real part of  $V_m/\omega t + \alpha$ . The real part of this complex quantity is the projection of  $V_m/\omega t + \alpha$  on the real axis:  $V_m \cos(\omega t + \alpha)$ .

In summary, then, the frequency-domain phasor appears on the phasor diagram, and the transformation to the time domain is accomplished by allowing the phasor to rotate in a counterclockwise direction at an angular velocity of  $\omega$  rad/s and then visualizing the projection on the real axis. It is helpful to think of the arrow representing the phasor  $\mathbf{V}$  on the phasor diagram as the photographic snapshot, taken at  $\omega t = 0$ , of a rotating arrow whose projection on the real axis is the instantaneous voltage  $v(t)$ .

Let us now construct the phasor diagrams for several simple circuits. The series  $RLC$  circuit shown in Fig. 10.40a has several different voltages associated with it, but only a single current. The phasor diagram is constructed most easily by employing the single current as the reference phasor. Let us arbitrarily select  $\mathbf{I} = I_m/0^\circ$  and place it along the real axis of the phasor diagram, Fig. 10.40b. The resistor, capacitor, and inductor voltages may then be calculated and placed on the diagram, where the  $90^\circ$  phase relationships stand out clearly. The sum of these three voltages is the source voltage, and for this circuit, which is in what we will define in a subsequent chapter as the “resonant condition” since  $\mathbf{Z}_C = -\mathbf{Z}_L$ , the source voltage and resistor voltage are equal. The total voltage across the resistor and inductor or resistor and capacitor is obtained from the diagram by adding the appropriate phasors as shown.

Figure 10.41a is a simple parallel circuit in which it is logical to use the single voltage between the two nodes as a reference phasor. Suppose that  $\mathbf{V} = 1/0^\circ$  V. The resistor current,  $\mathbf{I}_R = 0.2/0^\circ$  A, is in phase with this voltage, and the capacitor current,  $\mathbf{I}_C = j0.1$  A, leads the reference voltage by  $90^\circ$ . After these two currents are added to the phasor diagram, shown as Fig. 10.41b, they may be summed to obtain the source current. The result is  $\mathbf{I}_s = 0.2 + j0.1$  A.

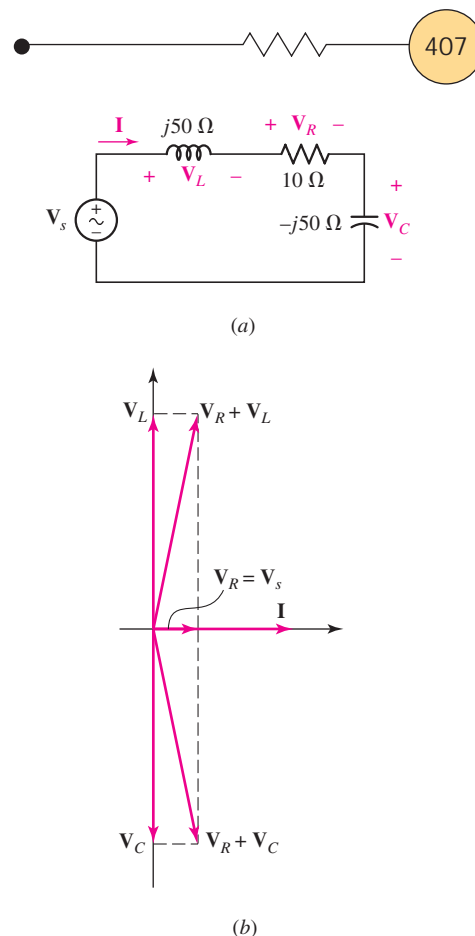

■ FIGURE 10.40 (a) A series  $RLC$  circuit. (b) The phasor diagram for this circuit; the current  $\mathbf{I}$  is used as a convenient reference phasor.

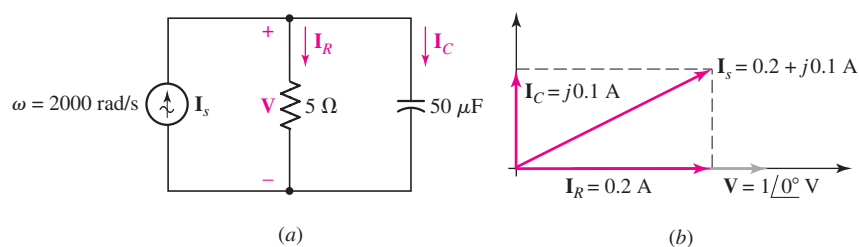

■ FIGURE 10.41 (a) A parallel  $RC$  circuit. (b) The phasor diagram for this circuit; the node voltage  $\mathbf{V}$  is used as a convenient reference phasor.

If the source current is specified initially as the convenient value of  $1/0^\circ$  A and the node voltage is not initially known, it is still convenient to begin construction of the phasor diagram by assuming a node voltage (for example,  $\mathbf{V} = 1/0^\circ$  V once again) and using it as the reference phasor. The diagram is then completed as before, and the source current that flows as a result of the assumed node voltage is again found to be  $0.2 + j0.1$  A. The true source current is  $1/0^\circ$  A, however, and thus the true node voltage is obtained by multiplying the assumed node voltage by  $1/0^\circ/(0.2 + j0.1)$ ;

the true node voltage is therefore  $4 - j2 \text{ V} = \sqrt{20}/-26.6^\circ \text{ V}$ . The assumed voltage leads to a phasor diagram which differs from the true phasor diagram by a change of scale (the assumed diagram is smaller by a factor of  $1/\sqrt{20}$ ) and an angular rotation (the assumed diagram is rotated counterclockwise through  $26.6^\circ$ ).

### EXAMPLE 10.13

**Construct a phasor diagram showing  $I_R$ ,  $I_L$ , and  $I_C$  for the circuit of Fig. 10.42. Combining these currents, determine the angle by which  $I_s$  leads  $I_R$ ,  $I_C$ , and  $I_x$ .**

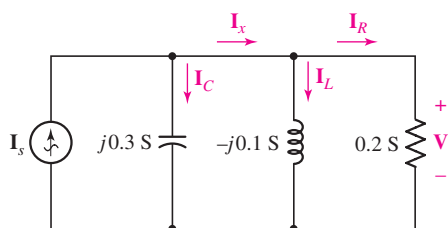

FIGURE 10.42 A simple circuit for which several currents are required.

We begin by choosing a suitable reference phasor. Upon examining the circuit and the variables to be determined, we see that once  $V$  is known,  $I_R$ ,  $I_L$ , and  $I_C$  can be computed by simple application of Ohm's law. Thus, we select  $V = 1/0^\circ \text{ V}$  for simplicity's sake, and subsequently compute

$$I_R = (0.2)1/0^\circ = 0.2/0^\circ \text{ A}$$

$$I_L = (-j0.1)1/0^\circ = 0.1/-90^\circ \text{ A}$$

$$I_C = (j0.3)1/0^\circ = 0.3/90^\circ \text{ A}$$

The corresponding phasor diagram is shown in Fig. 10.43a. We also need to find the phasor currents  $I_s$  and  $I_x$ . Figure 10.43b shows the determination of  $I_x = I_L + I_R = 0.2 - j0.1 = 0.224/-26.6^\circ \text{ A}$ , and Fig. 10.43c shows the determination of  $I_s = I_C + I_x = 0.283/45^\circ \text{ A}$ . From Fig. 10.43c, we ascertain that  $I_s$  leads  $I_R$  by  $45^\circ$ ,  $I_C$  by  $-45^\circ$ , and  $I_x$  by  $45^\circ + 26.6^\circ = 71.6^\circ$ . These angles are only relative, however; the exact numerical values will depend on  $I_s$ , upon which the actual value of  $V$  (assumed here to be  $1/0^\circ \text{ V}$  for convenience) also depends.

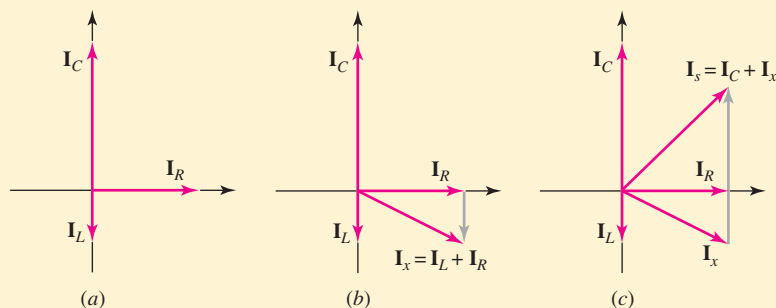

FIGURE 10.43 (a) Phasor diagram constructed using a reference value of  $V = 1/0^\circ$ . (b) Graphical determination of  $I_x = I_L + I_R$ . (c) Graphical determination of  $I_s = I_C + I_x$ .

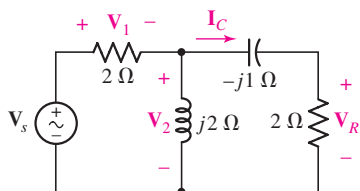

FIGURE 10.44

### PRACTICE

10.17 Select some convenient reference value for  $I_C$  in the circuit of Fig. 10.44; draw a phasor diagram showing  $V_R$ ,  $V_2$ ,  $V_1$ , and  $V_s$ ; and measure the ratio of the lengths of (a)  $V_s$  to  $V_1$ ; (b)  $V_1$  to  $V_2$ ; (c)  $V_s$  to  $V_R$ .

Ans: 1.90; 1.00; 2.12

## SUMMARY AND REVIEW

This chapter dealt with the steady-state response of circuits to sinusoidal excitation. This is a limited analysis of a circuit in some respects, as the transient behavior is completely ignored. In many situations, such an approach is more than adequate, and reducing the amount of information we seek about a circuit speeds up the analysis considerably. The fundamental idea behind what we did was that an *imaginary* source was added to every *real* sinusoidal source; then Euler's identity converted the source to a complex exponential. Since the derivative of an exponential is simply another exponential, what would otherwise be integrodifferential equations arising from mesh or nodal analysis become *algebraic equations*.

A few new terms were introduced: *lagging*, *leading*, *impedance*, *admittance*, and a particularly important one *phasor*. Phasor relationships between current and voltage gave rise to the concept of impedance, where resistors are represented by a real number (resistance, as before), and inductors are represented by  $\mathbf{Z} = j\omega L$  while capacitors are represented by  $-j/\omega C$  ( $\omega$  being the operating frequency of our sources). From that point forward, all the circuit analysis techniques learned in Chaps. 3 to 5 apply.

It might seem odd to have an imaginary number as part of our solution, but we found that recovering the time-domain solution to our analysis is straightforward once the voltage or current is expressed in polar form. The magnitude of our quantity of interest is the magnitude of the cosine function, the phase angle is the phase of the cosine term, and the frequency is obtained from the original circuit (it disappears from view during the analysis, but the circuits we are analyzing do not change it in any way). We concluded the chapter with an introduction to the concept of phasor diagrams. Prior to inexpensive scientific calculators such tools were invaluable in analyzing many sinusoidal circuits. They still find use in analysis of ac power systems, as we see in subsequent chapters.

A concise list of key concepts of the chapter is presented below for the convenience of the reader, along with the corresponding example numbers.

- If two sine waves (or two cosine waves) both have positive magnitudes and the same frequency, it is possible to determine which waveform is leading and which is lagging by comparing their phase angles.
- The forced response of a linear circuit to a sinusoidal voltage or current source can always be written as a single sinusoid having the same frequency as the sinusoidal source. (Example 10.1)
- A phasor has both a magnitude and a phase angle; the frequency is understood to be that of the sinusoidal source driving the circuit. (Example 10.2)
- A phasor transform may be performed on any sinusoidal function, and vice versa:  $\mathbf{V}_m \cos(\omega t + \phi) \leftrightarrow \mathbf{V}_m \angle \phi$ . (Example 10.3)
- When transforming a time-domain circuit into the corresponding frequency-domain circuit, resistors, capacitors, and inductors are replaced by impedances (or, occasionally, by admittances). (Examples 10.4, 10.6)
  - The impedance of a resistor is simply its resistance.

- The impedance of a capacitor is  $1/j\omega C \Omega$ .
  - The impedance of an inductor is  $j\omega L \Omega$ .
- Impedances combine both in series and in parallel combinations in the same manner as resistors. (Example 10.6)
  - All analysis techniques previously used on resistive circuits apply to circuits with capacitors and/or inductors once all elements are replaced by their frequency-domain equivalents. (Examples 10.5, 10.7, 10.8, 10.9, 10.10, 10.11)
  - Phasor analysis can only be performed on single-frequency circuits. Otherwise, superposition must be invoked, and the *time-domain* partial responses added to obtain the complete response. (Example 10.12)
  - The power behind phasor diagrams is evident when a convenient forcing function is used initially, and the final result scaled appropriately. (Example 10.13)

## READING FURTHER

A good reference to phasor-based analysis techniques can be found in:

R. A. DeCarlo and P. M. Lin, *Linear Circuit Analysis*, 2nd ed. New York: Oxford University Press, 2001.

Frequency-dependent transistor models are discussed from a phasor perspective in Chap. 7 of:

W. H. Hayt, Jr., and G. W. Neudeck, *Electronic Circuit Analysis and Design*, 2nd ed. New York: Wiley, 1995.

## EXERCISES

### 10.1 Characteristics of Sinusoids

1. Evaluate the following: (a)  $5 \sin(5t - 9^\circ)$  at  $t = 0, 0.01,$  and  $0.1$  s; (b)  $4 \cos 2t$  and  $4 \sin(2t + 90^\circ)$  at  $t = 0, 1,$  and  $1.5$  s; (c)  $3.2 \cos(6t + 15^\circ)$  and  $3.2 \sin(6t + 105^\circ)$  at  $t = 0, 0.01,$  and  $0.1$  s.
2. (a) Express each of the following as a single *cosine* function:  $5 \sin 300t,$   $1.95 \sin(\pi t - 92^\circ),$   $2.7 \sin(50t + 5^\circ) - 10 \cos 50t.$  (b) Express each of the following as a single *sine* function:  $66 \cos(9t - 10^\circ),$   $4.15 \cos 10t,$   $10 \cos(100t - 9^\circ) + 10 \sin(100t + 19^\circ).$
3. Determine the angle by which  $v_1$  *leads*  $i_1$  if  $v_1 = 10 \cos(10t - 45^\circ)$  and  $i_1$  is equal to (a)  $5 \cos 10t;$  (b)  $5 \cos(10t - 80^\circ);$  (c)  $5 \cos(10t - 40^\circ);$  (d)  $5 \cos(10t + 40^\circ);$  (e)  $5 \sin(10t - 19^\circ).$
4. Determine the angle by which  $v_1$  *lags*  $i_1$  if  $v_1 = 34 \cos(10t + 125^\circ)$  and  $i_1$  is equal to (a)  $5 \cos 10t;$  (b)  $5 \cos(10t - 80^\circ);$  (c)  $5 \cos(10t - 40^\circ);$  (d)  $5 \cos(10t + 40^\circ);$  (e)  $5 \sin(10t - 19^\circ).$
5. Determine which waveform in each of the following pairs is *lagging*: (a)  $\cos 4t,$   $\sin 4t;$  (b)  $\cos(4t - 80^\circ),$   $\cos(4t);$  (c)  $\cos(4t + 80^\circ),$   $\cos 4t;$  (d)  $-\sin 5t,$   $\cos(5t + 2^\circ);$  (e)  $\sin 5t + \cos 5t,$   $\cos(5t - 45^\circ).$
6. Calculate the first three instants in time ( $t > 0$ ) for which the following functions are zero, by first converting to a single sinusoid: (a)  $\cos 3t - 7 \sin 3t;$  (b)  $\cos(10t + 45^\circ);$  (c)  $\cos 5t - \sin 5t;$  (d)  $\cos 2t + \sin 2t - \cos 5t + \sin 5t.$
7. (a) Determine the first two instants in time ( $t > 0$ ) for which each of the functions in Exercise 6 are equal to unity, by first converting to a single sinusoid. (b) Verify your answers by plotting each waveform using an appropriate software package.





8. The concept of Fourier series is a powerful means of analyzing periodic waveforms in terms of sinusoids. For example, the triangle wave in Fig. 10.45 can be represented by the infinite sum

$$v(t) = \frac{8}{\pi^2} \left( \sin \pi t - \frac{1}{3^2} \sin 3\pi t + \frac{1}{5^2} \sin 5\pi t - \frac{1}{7^2} \sin 7\pi t + \dots \right)$$

where in practice perhaps the first several terms provide an accurate enough approximation. (a) Compute the exact value of  $v(t)$  at  $t = 0.25$  s by first obtaining an equation for the corresponding segment of the waveform. (b) Compute the approximate value at  $t = 0.25$  s using the first term of the Fourier series only. (c) Repeat part (b) using the first three terms. (d) Plot  $v(t)$  using the first term only. (e) Plot  $v(t)$  using the first two terms only. (f) Plot  $v(t)$  using the first three terms only.

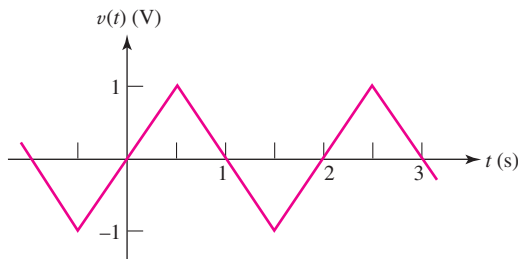

■ FIGURE 10.45

9. Household electrical voltages are typically quoted as either 110 V, 115 V, or 120 V. However, these values do not represent the peak ac voltage. Rather, they represent what is known as the root mean square of the voltage, defined as

$$V_{\text{rms}} = \sqrt{\frac{1}{T} \int_0^T V_m^2 \cos^2(\omega t) dt}$$

where  $T$  = the period of the waveform,  $V_m$  is the peak voltage, and  $\omega$  = the waveform frequency ( $f = 60$  Hz in North America).

- (a) Perform the indicated integration, and show that for a sinusoidal voltage,

$$V_{\text{rms}} = \frac{V_m}{\sqrt{2}}$$

- (b) Compute the peak voltages corresponding to the rms voltages of 110, 115, and 120 V.

## 10.2 Forced Response to Sinusoidal Functions

10. If the source  $v_s$  in Fig. 10.46 is equal to  $4.53 \cos(0.333 \times 10^{-3}t + 30^\circ)$  V, (a) obtain  $i_s$ ,  $i_L$ , and  $i_R$  at  $t = 0$  assuming no transients are present; (b) obtain an expression for  $v_L(t)$  in terms of a single sinusoid, valid for  $t > 0$ , again assuming no transients are present.

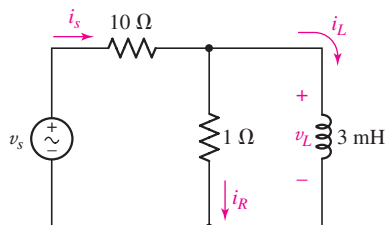

■ FIGURE 10.46

11. Assuming there are no longer any transients present, determine the current labeled  $i_L$  in the circuit of Fig. 10.47. Express your answer as a single sinusoid.

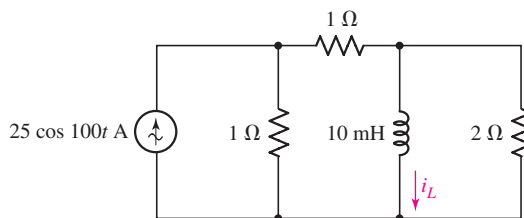

■ FIGURE 10.47

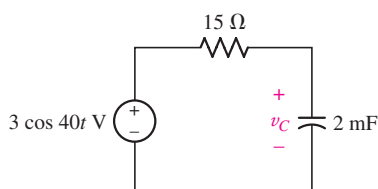

■ FIGURE 10.48

12. Calculate the power dissipated in the  $2\ \Omega$  resistor of Fig. 10.47 assuming there are no transients present. Express your answer in terms of a single sinusoidal function.
13. Obtain an expression for  $v_C$  as labeled in Fig. 10.48, in terms of a single sinusoidal function. You may assume all transients have died out long before  $t = 0$ .
14. Calculate the energy stored in the capacitor of the circuit depicted in Fig. 10.48 at  $t = 10\ \text{ms}$  and  $t = 40\ \text{ms}$ .
15. Obtain an expression for the power dissipated in the  $10\ \Omega$  resistor of Fig. 10.49, assuming no transients present.

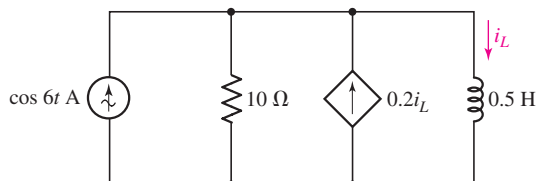

■ FIGURE 10.49

### 10.3 The Complex Forcing Function

16. Express the following complex numbers in rectangular form: (a)  $50/-75^\circ$ ; (b)  $19e^{j30^\circ}$ ;  $2.5/-30^\circ + 0.5/45^\circ$ . Convert the following to polar form: (c)  $(2 + j2)(2 - j2)$ ; (d)  $(2 + j2)(5/22^\circ)$ .
17. Express the following in polar form: (a)  $2 + e^{j35^\circ}$ ; (b)  $(j)(j)(-j)$ ; (c) 1. Express the following in rectangular form: (d)  $2 + e^{j35^\circ}$ ; (e)  $-j9 + 5/55^\circ$ .
18. Evaluate the following, and express your answer in polar form: (a)  $4(8 - j8)$ ; (b)  $4/5^\circ - 2/15^\circ$ ; (c)  $(2 + j9) - 5/0^\circ$ ; (d)  $\frac{-j}{10 + 5j} - 3/40^\circ + 2$ ; (e)  $(10 + j5)(10 - j5)(3/40^\circ) + 2$ .
19. Evaluate the following, and express your answer in rectangular form: (a)  $3(3/30^\circ)$ ; (b)  $2/25^\circ + 5/-10^\circ$ ; (c)  $(12 + j90) - 5/30^\circ$ ; (d)  $\frac{10 + 5j}{8 - j} + 2/60^\circ + 1$ ; (e)  $(10 + 5j)(10 - 5j)(3/40^\circ) + 2$ .
20. Perform the indicated operations, and express the answer in both rectangular and polar forms: (a)  $\frac{2 + j3}{1 + 8/90^\circ} - 4$ ; (b)  $\left(\frac{10/25^\circ}{5/-10^\circ} + \frac{3/15^\circ}{3 - j5}\right) j2$ ; (c)  $\left[\frac{(1 - j)(1 + j) + 1/0^\circ}{-j}\right](3/-90^\circ) + \frac{j}{5/-45^\circ}$ .
21. Insert an appropriate complex source into the circuit represented in Fig. 10.50, and use it to determine steady-state expressions for  $i_C(t)$  and  $v_C(t)$ .

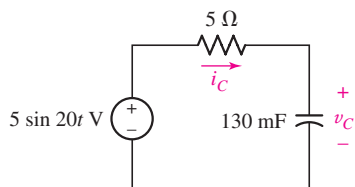

■ FIGURE 10.50

22. For the circuit of Fig. 10.51, if  $i_s = 5 \cos 10t$  A, use a suitable complex source replacement to obtain a steady-state expression for  $i_L(t)$ .
23. In the circuit depicted in Fig. 10.51,  $i_s$  is modified such that the  $2 \Omega$  resistor is replaced by a  $20 \Omega$  resistor. If  $i_L(t) = 62.5 \angle 31.3^\circ$  mA, determine  $i_s$ .
24. Employ a suitable complex source to determine the steady-state current  $i_L$  in the circuit of Fig. 10.52.

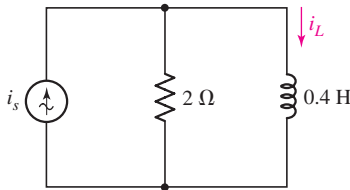

■ FIGURE 10.51

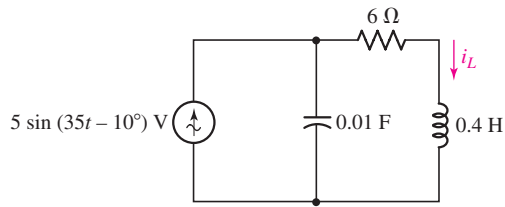

■ FIGURE 10.52

### 10.4 The Phasor

25. Transform each of the following into phasor form: (a)  $75.928 \cos(110.1t)$ ; (b)  $5 \cos(55t - 42^\circ)$ ; (c)  $-\sin(8000t + 14^\circ)$ ; (d)  $3 \cos 10t - 8 \cos(10t + 80^\circ)$ .
26. Transform each of the following into phasor form: (a)  $11 \sin 100t$ ; (b)  $11 \cos 100t$ ; (c)  $11 \cos(100t - 90^\circ)$ ; (d)  $3 \cos 100t - 3 \sin 100t$ .
27. Assuming an operating frequency of 1 kHz, transform the following phasor expressions into a single cosine function in the time domain: (a)  $9 \angle 65^\circ$  V; (b)  $\frac{2 \angle 31^\circ}{4 \angle 25^\circ}$  A; (c)  $22 \angle 14^\circ - 8 \angle 33^\circ$  V.
28. The following complex voltages are written in a combination of rectangular and polar form. Rewrite each, using conventional phasor notation (i.e., a magnitude and angle): (a)  $\frac{2-j}{5 \angle 45^\circ}$  V; (b)  $\frac{6 \angle 20^\circ}{1000} - j$  V; (c)  $(j)(52.5 \angle -90^\circ)$  V.
29. Assuming an operating frequency of 50 Hz, compute the instantaneous voltage at  $t = 10$  ms and  $t = 25$  ms for each of the quantities represented in Exercise 26.
30. Assuming an operating frequency of 50 Hz, compute the instantaneous voltage at  $t = 10$  ms and  $t = 25$  ms for each of the quantities represented in Exercise 27.
31. Assuming the passive sign convention and an operating frequency of 5 rad/s, calculate the phasor voltage which develops across the following when driven by the phasor current  $\mathbf{I} = 2 \angle 0^\circ$  mA: (a) a 1 k $\Omega$  resistor; (b) a 1 mF capacitor; (c) a 1 nH inductor.
32. (a) A series connection is formed between a 1  $\Omega$  resistor, a 1 F capacitor, and a 1 H inductor, in that order. Assuming operation at  $\omega = 1$  rad/s, what are the magnitude and phase angle of the phasor current which yields a voltage of  $1 \angle 30^\circ$  V across the resistor (assume the passive sign convention)? (b) Compute the ratio of the phasor voltage across the resistor to the phasor voltage which appears across the capacitor-inductor combination. (c) The frequency is doubled. Calculate the new ratio of the phasor voltage across the resistor to the phasor voltage across the capacitor-inductor combination.
33. Assuming the passive sign convention and an operating frequency of 314 rad/s, calculate the phasor voltage  $\mathbf{V}$  which appears across each of the following when driven by the phasor current  $\mathbf{I} = 10 \angle 0^\circ$  mA: (a) a 2  $\Omega$  resistor; (b) a 1 F capacitor; (c) a 1 H inductor; (d) a 2  $\Omega$  resistor in series with a 1 F capacitor; (e) a 2  $\Omega$  resistor in series with a 1 H inductor. (f) Calculate the instantaneous value of each voltage determined in parts (a) to (e) at  $t = 0$ .
34. In the circuit of Fig. 10.53, which is shown in the phasor (frequency) domain,  $\mathbf{I}_{10}$  is determined to be  $2 \angle 42^\circ$  mA. If  $\mathbf{V} = 40 \angle 132^\circ$  mV: (a) what is the likely type of element connected to the right of the 10  $\Omega$  resistor and (b) what is its value, assuming the voltage source operates at a frequency of 1000 rad/s?

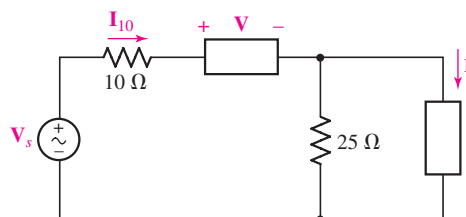

■ FIGURE 10.53

35. The circuit of Fig. 10.53 is shown represented in the phasor (frequency) domain. If  $\mathbf{I}_{10} = 4/35^\circ$  A,  $\mathbf{V} = 10/35^\circ$ , and  $\mathbf{I} = 2/35^\circ$  A, (a) across what type of element does  $\mathbf{V}$  appear, and what is its value? (b) Determine the value of  $\mathbf{V}_s$ .

### 10.5 Impedance and Admittance



36. (a) Obtain an expression for the equivalent impedance  $\mathbf{Z}_{eq}$  of a  $1\ \Omega$  resistor in series with a  $10\ \text{mH}$  inductor as a function of  $\omega$ . (b) Plot the magnitude of  $\mathbf{Z}_{eq}$  as a function of  $\omega$  over the range  $1 < \omega < 100$  krad/s (use a logarithmic scale for the frequency axis). (c) Plot the angle (in degrees) of  $\mathbf{Z}_{eq}$  as a function of  $\omega$  over the range  $1 < \omega < 100$  krad/s (use a logarithmic scale for the frequency axis). [Hint: *semilogx()* in MATLAB is a useful plotting function.]
37. Determine the equivalent impedance of the following, assuming an operating frequency of  $20\ \text{rad/s}$ : (a)  $1\ \text{k}\Omega$  in series with  $1\ \text{mF}$ ; (b)  $1\ \text{k}\Omega$  in parallel with  $1\ \text{mH}$ ; (c)  $1\ \text{k}\Omega$  in parallel with the series combination of  $1\ \text{F}$  and  $1\ \text{H}$ .



38. (a) Obtain an expression for the equivalent impedance  $\mathbf{Z}_{eq}$  of a  $1\ \Omega$  resistor in series with a  $10\ \text{mF}$  capacitor as a function of  $\omega$ . (b) Plot the magnitude of  $\mathbf{Z}_{eq}$  as a function of  $\omega$  over the range  $1 < \omega < 100$  krad/s (use a logarithmic scale for the frequency axis). (c) Plot the angle (in degrees) of  $\mathbf{Z}_{eq}$  as a function of  $\omega$  over the range  $1 < \omega < 100$  krad/s (use a logarithmic scale for the frequency axis). [Hint: *semilogx()* in MATLAB is a useful plotting function.]

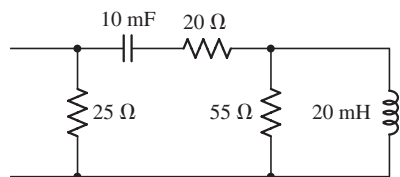

■ FIGURE 10.54

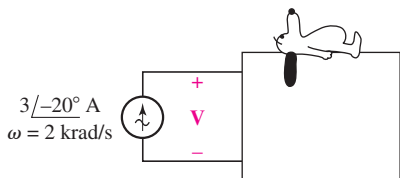

■ FIGURE 10.55

39. Determine the equivalent admittance of the following, assuming an operating frequency of  $1000\ \text{rad/s}$ : (a)  $25\ \Omega$  in series with  $20\ \text{mH}$ ; (b)  $25\ \Omega$  in parallel with  $20\ \text{mH}$ ; (c)  $25\ \Omega$  in parallel with  $20\ \text{mH}$  in parallel with  $20\ \text{mF}$ ; (d)  $1\ \Omega$  in series with  $1\ \text{F}$  in series with  $1\ \text{H}$ ; (e)  $1\ \Omega$  in parallel with  $1\ \text{F}$  in parallel with  $1\ \text{H}$ .
40. Consider the network depicted in Fig. 10.54, and determine the equivalent impedance seen looking into the open terminals if (a)  $\omega = 1\ \text{rad/s}$ ; (b)  $\omega = 10\ \text{rad/s}$ ; (c)  $\omega = 100\ \text{rad/s}$ .
41. Exchange the capacitor and inductor in the network shown in Fig. 10.54, and calculate the equivalent impedance looking into the open terminals if  $\omega = 25\ \text{rad/s}$ .
42. Find  $\mathbf{V}$  in Fig. 10.55 if the box contains (a)  $3\ \Omega$  in series with  $2\ \text{mH}$ ; (b)  $3\ \Omega$  in series with  $125\ \mu\text{F}$ ; (c)  $3\ \Omega$ ,  $2\ \text{mH}$ , and  $125\ \mu\text{F}$  in series; (d)  $3\ \Omega$ ,  $2\ \text{mH}$ , and  $125\ \mu\text{F}$  in series, but  $\omega = 4\ \text{krad/s}$ .
43. Calculate the equivalent impedance seen at the open terminals of the network shown in Fig. 10.56 if  $f$  is equal to (a)  $1\ \text{Hz}$ ; (b)  $1\ \text{kHz}$ ; (c)  $1\ \text{MHz}$ ; (d)  $1\ \text{GHz}$ ; (e)  $1\ \text{THz}$ .

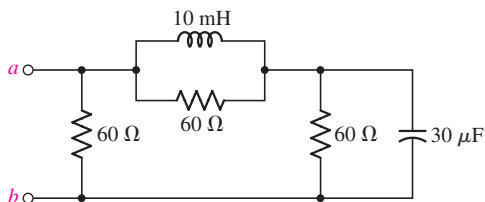

■ FIGURE 10.56



44. Employ phasor-based analysis to obtain an expression for  $i(t)$  in the circuit of Fig. 10.57.

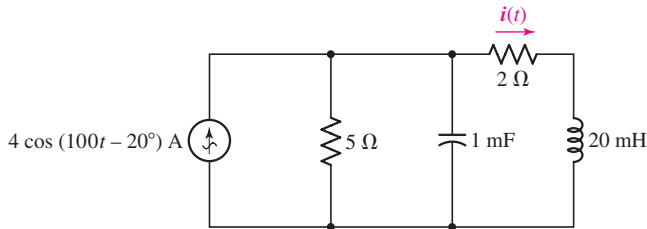

FIGURE 10.57

45. Design a suitable combination of resistors, capacitors, and/or inductors which has an equivalent impedance at  $\omega = 100$  rad/s of (a)  $1 \Omega$  using at least one inductor; (b)  $7/10^\circ \Omega$ ; (c)  $3 - j4 \Omega$ .
46. Design a suitable combination of resistors, capacitors, and/or inductors which has an equivalent admittance at  $\omega = 10$  rad/s of (a)  $1 \text{ S}$  using at least one capacitor; (b)  $12/-18^\circ \text{ S}$ ; (c)  $2 + j \text{ mS}$ .

## 10.6 Nodal and Mesh Analysis

47. For the circuit depicted in Fig. 10.58, (a) redraw with appropriate phasors and impedances labeled; (b) employ nodal analysis to determine the two nodal voltages  $v_1(t)$  and  $v_2(t)$ .

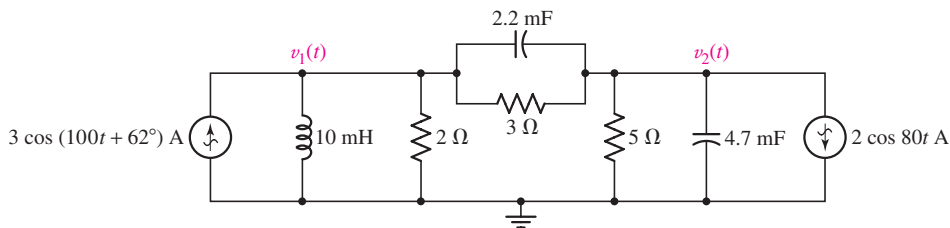

FIGURE 10.58

48. For the circuit illustrated in Fig. 10.59, (a) redraw, labeling appropriate phasor and impedance quantities; (b) determine expressions for the three time-domain mesh currents.

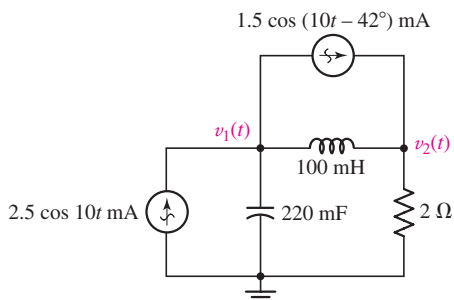

FIGURE 10.59

49. Referring to the circuit of Fig. 10.59, employ phasor-based analysis techniques to determine the two nodal voltages.
50. In the phasor-domain circuit represented by Fig. 10.60, let  $\mathbf{V}_1 = 10/-80^\circ \text{ V}$ ,  $\mathbf{V}_2 = 4/-0^\circ \text{ V}$ , and  $\mathbf{V}_3 = 2/-23^\circ \text{ V}$ . Calculate  $\mathbf{I}_1$  and  $\mathbf{I}_2$ .

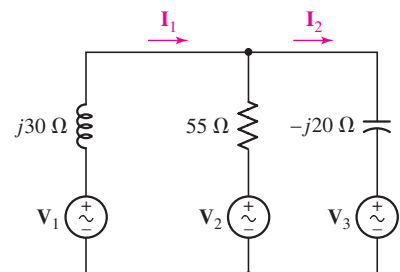
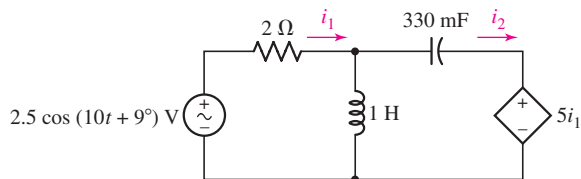

FIGURE 10.60

51. With regard to the two-mesh phasor-domain circuit depicted in Fig. 10.60, calculate the ratio of  $\mathbf{I}_1$  to  $\mathbf{I}_2$  if  $\mathbf{V}_1 = 3/\underline{0^\circ}$  V,  $\mathbf{V}_2 = 5.5/\underline{-130^\circ}$  V, and  $\mathbf{V}_3 = 1.5/\underline{17^\circ}$  V.
52. Employ phasor analysis techniques to obtain expressions for the two mesh currents  $i_1$  and  $i_2$  as shown in Fig. 10.61.



■ FIGURE 10.61

53. Determine  $\mathbf{I}_B$  in the circuit of Fig. 10.62 if  $\mathbf{I}_1 = 5/\underline{-18^\circ}$  A and  $\mathbf{I}_2 = 2/\underline{5^\circ}$  A.

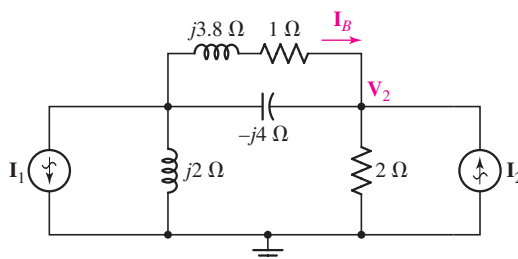

■ FIGURE 10.62

54. Determine  $\mathbf{V}_2$  in the circuit of Fig. 10.62 if  $\mathbf{I}_1 = 15/\underline{0^\circ}$  A and  $\mathbf{I}_2 = 25/\underline{131^\circ}$  A.
55. Employ phasor analysis to obtain an expression for  $v_x$  as labeled in the circuit of Fig. 10.63.

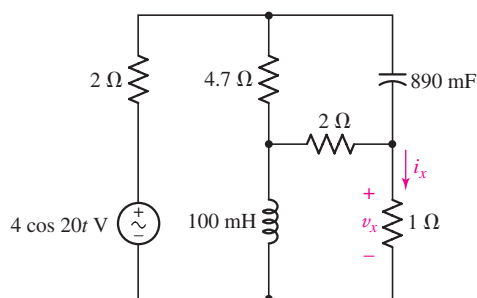

■ FIGURE 10.63

56. Determine the current  $i_x$  in the circuit of Fig. 10.63.
57. Obtain an expression for each of the four (clockwise) mesh currents for the circuit of Fig. 10.64 if  $v_1 = 133 \cos(14t + 77^\circ)$  V and  $v_2 = 55 \cos(14t + 22^\circ)$  V.

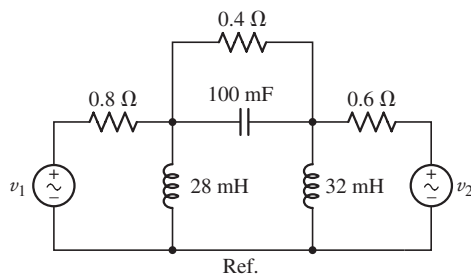

■ FIGURE 10.64

58. Determine the nodal voltages for the circuit of Fig. 10.64, using the bottom node as the reference node, if  $v_1 = 0.009 \cos(500t + 0.5^\circ)$  V and  $v_2 = 0.004 \cos(500t + 1.5^\circ)$  V.
59. The op amp shown in Fig. 10.65 has an infinite input impedance, zero output impedance, and a large but finite (positive, real) gain,  $A = -V_o/V_i$ . (a) Construct a basic differentiator by letting  $Z_f = R_f$ , find  $V_o/V_s$ , and then show that  $V_o/V_s \rightarrow -j\omega C_1 R_f$  as  $A \rightarrow \infty$ . (b) Let  $Z_f$  represent  $C_f$  and  $R_f$  in parallel, find  $V_o/V_s$ , and then show that  $V_o/V_s \rightarrow -j\omega C_1 R_f / (1 + j\omega C_f R_f)$  as  $A \rightarrow \infty$ .
60. Obtain an expression for each of the four mesh currents labeled in the circuit of Fig. 10.66.

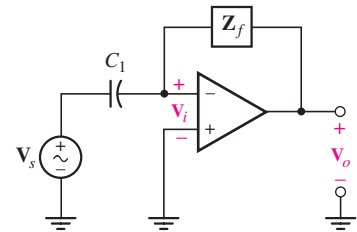

■ FIGURE 10.65

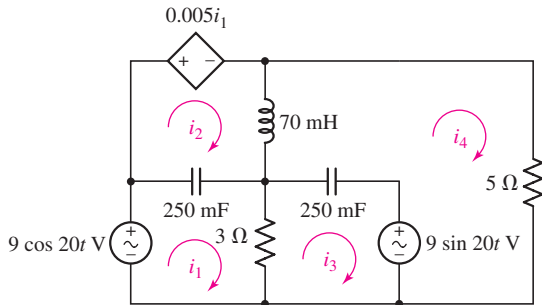

■ FIGURE 10.66

## 10.7 Superposition, Source Transformations, and Thévenin's Theorem

61. Determine the individual contribution each current source makes to the two nodal voltages  $V_1$  and  $V_2$  as represented in Fig. 10.67.

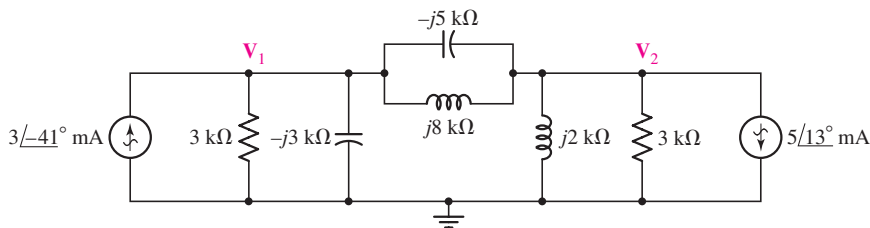

■ FIGURE 10.67

62. Determine  $V_1$  and  $V_2$  in Fig. 10.68 if  $I_1 = 33/∠3^\circ$  mA and  $I_2 = 51/∠-91^\circ$  mA.
63. The phasor domain circuit of Fig. 10.68 was drawn assuming an operating frequency of 2.5 rad/s. Unfortunately, the manufacturing unit installed the wrong sources, each operating at a different frequency. If  $i_1(t) = 4 \cos 40t$  mA and  $i_2(t) = 4 \sin 30t$  mA, calculate  $v_1(t)$  and  $v_2(t)$ .
64. Obtain the Thévenin equivalent seen by the  $(2 - j) \Omega$  impedance of Fig. 10.69, and employ it to determine the current  $I_1$ .

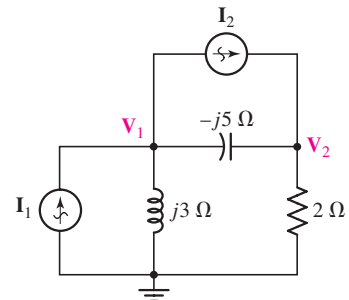

■ FIGURE 10.68

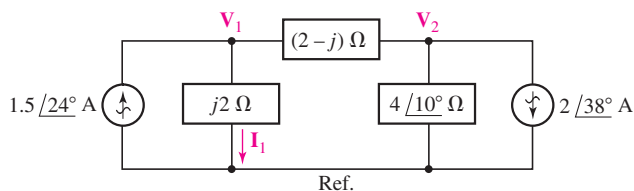

■ FIGURE 10.69

65. The  $(2 - j) \Omega$  impedance in the circuit of Fig. 10.69 is replaced with a  $(1 + j) \Omega$  impedance. Perform a source transformation on each source, simplify the resulting circuit as much as possible, and calculate the current flowing through the  $(1 + j) \Omega$  impedance.
66. With regard to the circuit depicted in Fig. 10.70, (a) calculate the Thévenin equivalent seen looking into the terminals marked  $a$  and  $b$ ; (b) determine the Norton equivalent seen looking into the terminals marked  $a$  and  $b$ ; (c) compute the current flowing from  $a$  to  $b$  if a  $(7 - j2) \Omega$  impedance is connected across them.

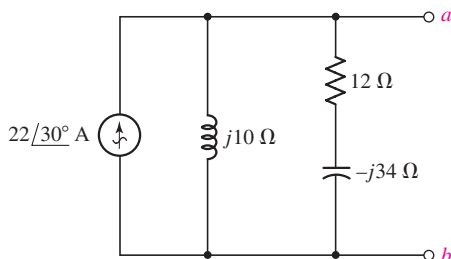

■ FIGURE 10.70

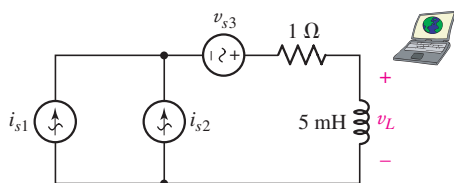

■ FIGURE 10.71

67. In the circuit of Fig. 10.71,  $i_{s1} = 8 \cos(4t - 9^\circ)$  mA,  $i_{s2} = 5 \cos 4t$  and  $v_{s3} = 2 \sin 4t$ . (a) Redraw the circuit in the phasor domain; (b) reduce the circuit to a single current source with the assistance of a source transformation; (c) calculate  $v_L(t)$ . (d) Verify your solution with an appropriate PSpice simulation.
68. Determine the individual contribution of each source in Fig. 10.72 to the voltage  $v_1(t)$ .

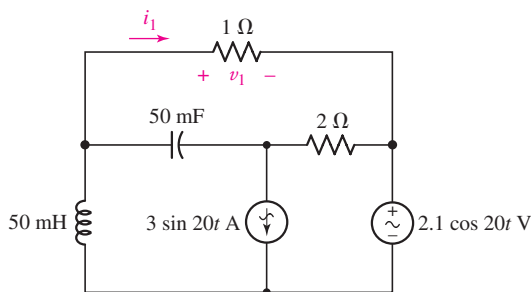

■ FIGURE 10.72

69. Determine the power dissipated by the  $1 \Omega$  resistor in the circuit of Fig. 10.73. Verify your solution with an appropriate PSpice simulation.

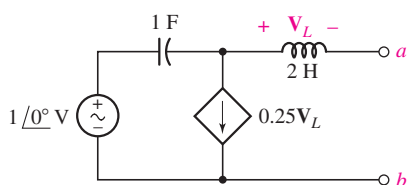

■ FIGURE 10.74

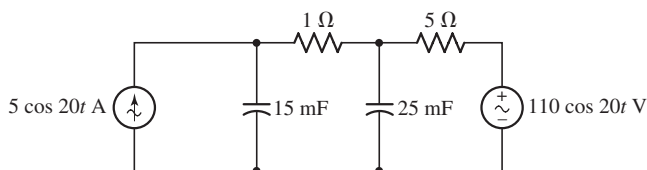

■ FIGURE 10.73

70. Use  $\omega = 1$  rad/s, and find the Norton equivalent of the network shown in Fig. 10.74. Construct the Norton equivalent as a current source  $I_N$  in parallel with a resistance  $R_N$  and either an inductance  $L_N$  or a capacitance  $C_N$ .

### 10.8 Phasor Diagrams

71. The source  $\mathbf{I}_s$  in the circuit of Fig. 10.75 is selected such that  $\mathbf{V} = 5/120^\circ \text{ V}$ .  
 (a) Construct a phasor diagram showing  $\mathbf{I}_R$ ,  $\mathbf{I}_L$ , and  $\mathbf{I}_C$ . (b) Use the diagram to determine the angle by which  $\mathbf{I}_s$  leads  $\mathbf{I}_R$ ,  $\mathbf{I}_C$ , and  $\mathbf{I}_s$ .

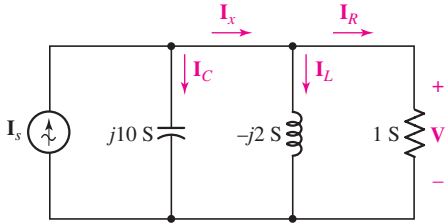

FIGURE 10.75

72. Let  $\mathbf{V}_1 = 100/0^\circ \text{ V}$ ,  $|\mathbf{V}_2| = 140 \text{ V}$ , and  $|\mathbf{V}_1 + \mathbf{V}_2| = 120 \text{ V}$ . Use graphical methods to find two possible values for the angle of  $\mathbf{V}_2$ .
73. (a) Calculate values for  $\mathbf{I}_L$ ,  $\mathbf{I}_R$ ,  $\mathbf{I}_C$ ,  $\mathbf{V}_L$ ,  $\mathbf{V}_R$ , and  $\mathbf{V}_C$  for the circuit shown in Fig. 10.76. (b) Using scales of 50 V to 1 in and 25 A to 1 in, show all seven quantities on a phasor diagram, and indicate that  $\mathbf{I}_L = \mathbf{I}_R + \mathbf{I}_C$  and  $\mathbf{V}_s = \mathbf{V}_L + \mathbf{V}_R$ .

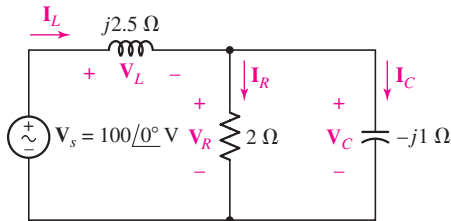

FIGURE 10.76

74. In the circuit of Fig. 10.77, (a) find values for  $\mathbf{I}_1$ ,  $\mathbf{I}_2$ , and  $\mathbf{I}_3$ . (b) Show  $\mathbf{V}_s$ ,  $\mathbf{I}_1$ ,  $\mathbf{I}_2$ , and  $\mathbf{I}_3$  on a phasor diagram (scales of 50 V/in and 2 A/in work fine). (c) Find  $\mathbf{I}_s$  graphically and give its amplitude and phase angle.

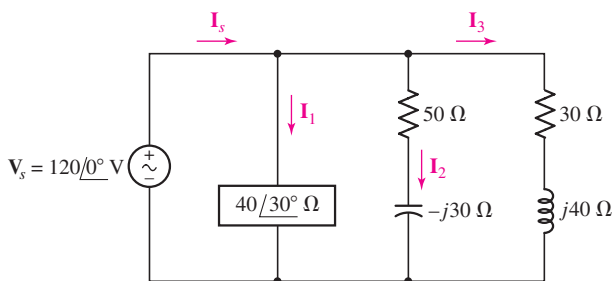

FIGURE 10.77

75. The voltage source  $\mathbf{V}_s$  in Fig. 10.78 is chosen such that  $\mathbf{I}_C = 1/0^\circ \text{ A}$ . (a) Draw a phasor diagram showing  $\mathbf{V}_1$ ,  $\mathbf{V}_2$ ,  $\mathbf{V}_s$ , and  $\mathbf{V}_R$ . (b) Use the diagram to determine the ratio of  $\mathbf{V}_2$  to  $\mathbf{V}_1$ .

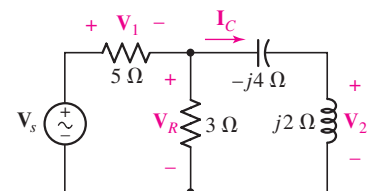
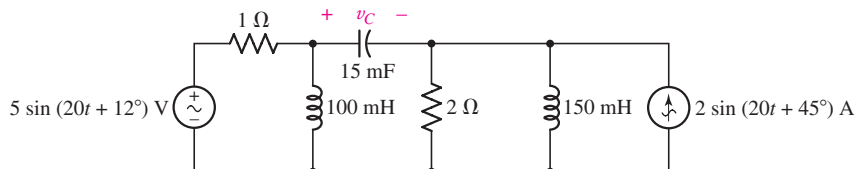

FIGURE 10.78

## Chapter-Integrating Exercises



76. For the circuit shown in Fig. 10.79, (a) draw the phasor representation of the circuit; (b) determine the Thévenin equivalent seen by the capacitor, and use it to calculate  $v_C(t)$ . (c) Determine the current flowing out of the positive reference terminal of the voltage source. (d) Verify your solution with an appropriate PSpice simulation.



■ FIGURE 10.79

77. The circuit of Fig. 10.79 is unfortunately operating differently than specified; the frequency of the current source is only 19 rad/s. Calculate the actual capacitor voltage, and compare it to the expected voltage had the circuit been operating correctly.

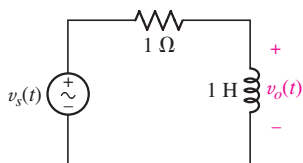

■ FIGURE 10.80



78. For the circuit shown in Fig. 10.80, (a) draw the corresponding phasor representation; (b) obtain an expression for  $V_o/V_s$ ; (c) Plot  $|V_o/V_s|$ , the magnitude of the phasor voltage ratio, as a function of frequency  $\omega$  over the range  $0.01 \leq \omega \leq 100$  rad/s (use a logarithmic  $x$  axis). (d) Does the circuit transfer low frequencies or high frequencies more effectively to the output?



79. (a) Replace the inductor in the circuit of Fig. 10.80 with a 1 F capacitor and repeat Exercise 10.78. (b) If we design the “corner frequency” of the circuit as the frequency at which the output is reduced to  $1/\sqrt{2}$  times its maximum value, redesign the circuit to achieve a corner frequency of 2 kHz.



80. Design a purely passive network (containing only resistors, capacitors, and inductors) which has an impedance of  $(22 - j7)/5 \angle 8^\circ \Omega$  at a frequency of  $f = 100$  MHz.

# AC Circuit Power Analysis

## INTRODUCTION

Often an integral part of circuit analysis is the determination of either power delivered or power absorbed (or both). In the context of ac power, we find that the rather simple approach we have taken previously does not provide a convenient picture of how a particular system is operating, so we introduce several different power-related quantities in this chapter.

We begin by considering *instantaneous* power, the product of the time-domain voltage and time-domain current associated with the element or network of interest. The instantaneous power is sometimes quite useful in its own right, because its maximum value might have to be limited to avoid exceeding the safe operating range of a physical device. For example, transistor and vacuum-tube power amplifiers both produce a distorted output, and speakers give a distorted sound, when the peak power exceeds a certain limiting value. However, we are mainly interested in instantaneous power for the simple reason that it provides us with the means to calculate a more important quantity, the *average* power. In a similar way, the progress of a cross-country road trip is best described by the average velocity; our interest in the instantaneous velocity is limited to the avoidance of maximum velocities that will endanger our safety or arouse the highway patrol.

In practical problems we will deal with values of average power which range from the small fraction of a picowatt available in a telemetry signal from outer space, to the few watts of audio power supplied to the speakers in a good stereo system, to the several hundred watts required to run the morning coffeepot, or to the 10 billion watts generated at the Grand Coulee Dam. Still, we will

## KEY CONCEPTS

Calculating Instantaneous Power

Average Power Supplied by a Sinusoidal Source

Root-Mean-Square (RMS) Values

Reactive Power

The Relationship Between Complex, Average, and Reactive Power

Power Factor of a Load



see that even the concept of average power has its limitations, especially when dealing with the energy exchange between reactive loads and power sources. This is easily handled by introducing the concepts of reactive power, complex power, and the power factor—all very common terms in the power industry.

## 11.1 INSTANTANEOUS POWER

The *instantaneous power* delivered to any device is given by the product of the instantaneous voltage across the device and the instantaneous current through it (the passive sign convention is assumed). Thus,<sup>1</sup>

$$p(t) = v(t)i(t) \quad [1]$$

If the device in question is a resistor of resistance  $R$ , then the power may be expressed solely in terms of either the current or the voltage:

$$p(t) = v(t)i(t) = i^2(t)R = \frac{v^2(t)}{R} \quad [2]$$

If the voltage and current are associated with a device that is entirely inductive, then

$$p(t) = v(t)i(t) = Li(t) \frac{di(t)}{dt} = \frac{1}{L}v(t) \int_{-\infty}^t v(t') dt' \quad [3]$$

where we will arbitrarily assume that the voltage is zero at  $t = -\infty$ . In the case of a capacitor,

$$p(t) = v(t)i(t) = Cv(t) \frac{dv(t)}{dt} = \frac{1}{C}i(t) \int_{-\infty}^t i(t') dt' \quad [4]$$

where a similar assumption about the current is made.

For example, consider the series  $RL$  circuit as shown in Fig. 11.1, excited by a step-voltage source. The familiar current response is

$$i(t) = \frac{V_0}{R}(1 - e^{-Rt/L})u(t)$$

and thus the total power delivered by the source or absorbed by the passive network is

$$p(t) = v(t)i(t) = \frac{V_0^2}{R}(1 - e^{-Rt/L})u(t)$$

since the square of the unit-step function is simply the unit-step function itself.

The power delivered to the resistor is

$$p_R(t) = i^2(t)R = \frac{V_0^2}{R}(1 - e^{-Rt/L})^2u(t)$$

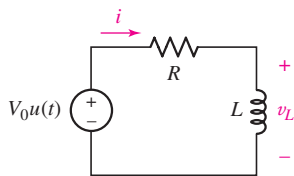

■ FIGURE 11.1 The instantaneous power that is delivered to  $R$  is  $p_R(t) = i^2(t)R = (V_0^2/R)(1 - e^{-Rt/L})^2u(t)$ .

(1) Earlier, we agreed that lowercase variables in italics were understood to be functions of time, and we have carried on in this spirit up to now. However, in order to emphasize the fact that these quantities must be evaluated at a specific instant in time, we will explicitly denote the time dependence throughout this chapter.



In order to determine the power absorbed by the inductor, we first obtain the inductor voltage:

$$\begin{aligned} v_L(t) &= L \frac{di(t)}{dt} \\ &= V_0 e^{-Rt/L} u(t) + \frac{LV_0}{R} (1 - e^{-Rt/L}) \frac{du(t)}{dt} \\ &= V_0 e^{-Rt/L} u(t) \end{aligned}$$

since  $du(t)/dt$  is zero for  $t > 0$  and  $(1 - e^{-Rt/L})$  is zero at  $t = 0$ . The power absorbed by the inductor is therefore

$$p_L(t) = v_L(t)i(t) = \frac{V_0^2}{R} e^{-Rt/L} (1 - e^{-Rt/L}) u(t)$$

Only a few algebraic manipulations are required to show that

$$p(t) = p_R(t) + p_L(t)$$

which serves to check the accuracy of our work; the results are sketched in Fig. 11.2.

## Power Due to Sinusoidal Excitation

Let us change the voltage source in the circuit of Fig. 11.1 to the sinusoidal source  $V_m \cos \omega t$ . The familiar time-domain steady-state response is

$$i(t) = I_m \cos(\omega t + \phi)$$

where

$$I_m = \frac{V_m}{\sqrt{R^2 + \omega^2 L^2}} \quad \text{and} \quad \phi = -\tan^{-1} \frac{\omega L}{R}$$

The instantaneous power delivered to the entire circuit in the sinusoidal steady state is, therefore,

$$p(t) = v(t)i(t) = V_m I_m \cos(\omega t + \phi) \cos \omega t$$

which we will find convenient to rewrite in a form obtained by using the trigonometric identity for the product of two cosine functions. Thus,

$$\begin{aligned} p(t) &= \frac{V_m I_m}{2} [\cos(2\omega t + \phi) + \cos \phi] \\ &= \frac{V_m I_m}{2} \cos \phi + \frac{V_m I_m}{2} \cos(2\omega t + \phi) \end{aligned}$$

The last equation possesses several characteristics that are true in general for circuits in the sinusoidal steady state. One term, the first, is not a function of time; and a second term is included which has a cyclic variation at *twice* the applied frequency. Since this term is a cosine wave, and since sine waves and cosine waves have average values which are zero (when averaged over an integral number of periods), this example suggests that the *average* power is  $\frac{1}{2} V_m I_m \cos \phi$ ; as we will see shortly, this is indeed the case.

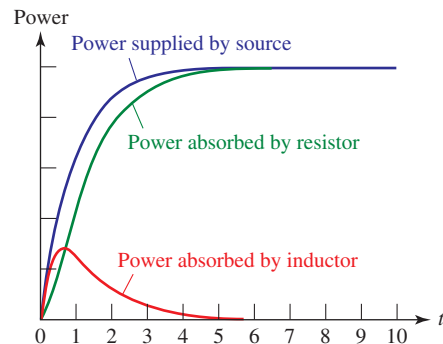

FIGURE 11.2 Sketch of  $p(t)$ ,  $p_R(t)$ , and  $p_L(t)$ . As the transient dies out, the circuit returns to steady-state operation. Since the only source remaining in the circuit is dc, the inductor eventually acts as a short circuit absorbing zero power.

## EXAMPLE 11.1

A voltage source,  $40 + 60u(t)$  V, a  $5 \mu\text{F}$  capacitor, and a  $200 \Omega$  resistor form a series circuit. Find the power being absorbed by the capacitor and by the resistor at  $t = 1.2$  ms.

At  $t = 0^-$ , no current is flowing and so 40 V appears across the capacitor. At  $t = 0^+$ , the voltage across the capacitor-resistor series combination jumps to 100 V. Since  $v_C$  cannot change in zero time, the resistor voltage at  $t = 0^+$  is 60 V.

The current flowing through all three elements at  $t = 0^+$  is therefore  $60/200 = 300$  mA and for  $t > 0$  is given by

$$i(t) = 300e^{-t/\tau} \quad \text{mA}$$

where  $\tau = RC = 1$  ms. Thus, the current flowing at  $t = 1.2$  ms is 90.36 mA, and the power being absorbed by the resistor *at that instant* is simply

$$i^2(t)R = 1.633 \text{ W}$$

The instantaneous power absorbed by the capacitor is  $i(t)v_C(t)$ . Recognizing that the total voltage across both elements for  $t > 0$  will always be 100 V, and that the resistor voltage is given by  $60e^{-t/\tau}$ ,

$$v_C(t) = 100 - 60e^{-t/\tau}$$

and we find that  $v_C(1.2 \text{ ms}) = 100 - 60e^{-1.2} = 81.93$  V. Thus, the power being absorbed by the capacitor at  $t = 1.2$  ms is  $(90.36 \text{ mA})(81.93 \text{ V}) = 7.403$  W.

## PRACTICE

11.1 A current source of  $12 \cos 2000t$  A, a  $200 \Omega$  resistor, and a  $0.2$  H inductor are in parallel. Assume steady-state conditions exist. At  $t = 1$  ms, find the power being absorbed by the (a) resistor; (b) inductor; (c) sinusoidal source.

Ans: 13.98 kW;  $-5.63$  kW;  $-8.35$  kW.

## 11.2 AVERAGE POWER

When we speak of an average value for the instantaneous power, the time interval over which the averaging process takes place must be clearly defined. Let us first select a general interval of time from  $t_1$  to  $t_2$ . We may then obtain the average value by integrating  $p(t)$  from  $t_1$  to  $t_2$  and dividing the result by the time interval  $t_2 - t_1$ . Thus,

$$P = \frac{1}{t_2 - t_1} \int_{t_1}^{t_2} p(t) dt \quad [5]$$

The average value is denoted by the capital letter  $P$ , since it is not a function of time, and it usually appears without any specific subscripts that identify it as an average value. Although  $P$  is not a function of time, it *is* a function

of  $t_1$  and  $t_2$ , the two instants of time which define the interval of integration. This dependence of  $P$  on a specific time interval may be expressed in a simpler manner if  $p(t)$  is a periodic function. We consider this important case first.

## Average Power for Periodic Waveforms

Let us assume that our forcing function and the circuit responses are all periodic; a steady-state condition has been reached, although not necessarily the sinusoidal steady state. We may define a *periodic* function  $f(t)$  mathematically by requiring that

$$f(t) = f(t + T) \quad [6]$$

where  $T$  is the period. We now show that the average value of the instantaneous power as expressed by Eq. [5] may be computed over an interval of one period having an arbitrary beginning.

A general periodic waveform is shown in Fig. 11.3 and identified as  $p(t)$ . We first compute the average power by integrating from  $t_1$  to a time  $t_2$  which is one period later,  $t_2 = t_1 + T$ :

$$P_1 = \frac{1}{T} \int_{t_1}^{t_1+T} p(t) dt$$

and then by integrating from some other time  $t_x$  to  $t_x + T$ :

$$P_x = \frac{1}{T} \int_{t_x}^{t_x+T} p(t) dt$$

The equality of  $P_1$  and  $P_x$  should be evident from the graphical interpretation of the integrals; the periodic nature of the curve requires the two areas to be equal. Thus, the **average power** may be computed by integrating the instantaneous power over any interval that is one period in length and then dividing by the period:

$$P = \frac{1}{T} \int_{t_x}^{t_x+T} p(t) dt \quad [7]$$

It is important to note that we may also integrate over any integral number of periods, provided that we divide by the same integral number of periods. Thus,

$$P = \frac{1}{nT} \int_{t_x}^{t_x+nT} p(t) dt \quad n = 1, 2, 3, \dots \quad [8]$$

If we carry this concept to the extreme by integrating over all time, another useful result is obtained. We first provide ourselves with symmetrical limits on the integral

$$P = \frac{1}{nT} \int_{-nT/2}^{nT/2} p(t) dt$$

and then take the limit as  $n$  becomes infinite,

$$P = \lim_{n \rightarrow \infty} \frac{1}{nT} \int_{-nT/2}^{nT/2} p(t) dt$$

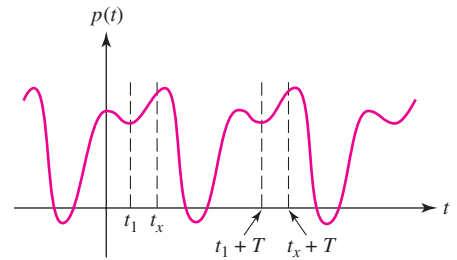
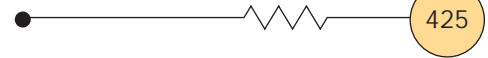

FIGURE 11.3 The average value  $P$  of a periodic function  $p(t)$  is the same over any period  $T$ .

As long as  $p(t)$  is a mathematically well-behaved function, as all *physical* forcing functions and responses are, it is apparent that if a large integer  $n$  is replaced by a slightly larger number which is not an integer, then the value of the integral and of  $P$  is changed by a negligible amount; moreover, the error decreases as  $n$  increases. Without justifying this step rigorously, we therefore replace the discrete variable  $nT$  with the continuous variable  $\tau$ :

$$P = \lim_{\tau \rightarrow \infty} \frac{1}{\tau} \int_{-\tau/2}^{\tau/2} p(t) dt \quad [9]$$

We will find it convenient on several occasions to integrate periodic functions over this “infinite period.”

### Average Power in the Sinusoidal Steady State

Now let us obtain the general result for the sinusoidal steady state. We assume the general sinusoidal voltage

$$v(t) = V_m \cos(\omega t + \theta)$$

and current

$$i(t) = I_m \cos(\omega t + \phi)$$

associated with the device in question. The instantaneous power is

$$p(t) = V_m I_m \cos(\omega t + \theta) \cos(\omega t + \phi)$$

Again expressing the product of two cosine functions as one-half the sum of the cosine of the difference angle and the cosine of the sum angle,

$$p(t) = \frac{1}{2} V_m I_m \cos(\theta - \phi) + \frac{1}{2} V_m I_m \cos(2\omega t + \theta + \phi) \quad [10]$$

we may save ourselves some integration by an inspection of the result. The first term is a constant, independent of  $t$ . The remaining term is a cosine function;  $p(t)$  is therefore periodic, and its period is  $\frac{1}{2}T$ . Note that the period  $T$  is associated with the given current and voltage, and not with the power; the power function has a period  $\frac{1}{2}T$ . However, we may integrate over an interval of  $T$  to determine the average value if we wish; it is necessary only that we also divide by  $T$ . Our familiarity with cosine and sine waves, however, shows that the average value of either over a period is zero. There is thus no need to integrate Eq. [10] formally; by inspection, the average value of the second term is zero over a period  $T$  (or  $\frac{1}{2}T$ ), and the average value of the first term, a constant, must be that constant itself. Thus,

$$P = \frac{1}{2} V_m I_m \cos(\theta - \phi) \quad [11]$$

This important result, introduced in the previous section for a specific circuit, is therefore quite general for the sinusoidal steady state. The average power is one-half the product of the crest amplitude of the voltage, the crest amplitude of the current, and the cosine of the phase-angle difference between the current and the voltage; the sense of the difference is immaterial.

Two special cases are worth isolating for consideration: the average power delivered to an ideal resistor and that to an ideal reactor (any combination of only capacitors and inductors).

Recall that  $T = \frac{1}{f} = \frac{2\pi}{\omega}$ .

## EXAMPLE 11.2

Given the time-domain voltage  $v = 4 \cos(\pi t/6)$  V, find both the average power and an expression for the instantaneous power that result when the corresponding phasor voltage  $\mathbf{V} = 4/\underline{0^\circ}$  V is applied across an impedance  $\mathbf{Z} = 2/\underline{60^\circ}$   $\Omega$ .

The phasor current is  $\mathbf{V}/\mathbf{Z} = 2/\underline{-60^\circ}$  A, and so the average power is

$$P = \frac{1}{2}(4)(2) \cos 60^\circ = 2 \text{ W}$$

We can write the time-domain voltage,

$$v(t) = 4 \cos \frac{\pi t}{6} \quad \text{V}$$

and the time-domain current,

$$i(t) = 2 \cos \left( \frac{\pi t}{6} - 60^\circ \right) \quad \text{A}$$

The instantaneous power, therefore, is given by their product:

$$\begin{aligned} p(t) &= 8 \cos \frac{\pi t}{6} \cos \left( \frac{\pi t}{6} - 60^\circ \right) \\ &= 2 + 4 \cos \left( \frac{\pi t}{3} - 60^\circ \right) \quad \text{W} \end{aligned}$$

All three quantities are sketched on the same time axis in Fig. 11.4. Both the 2 W average value of the power and its period of 6 s, one-half the period of either the current or the voltage, are evident. The zero value of the instantaneous power at each instant when either the voltage or current is zero is also apparent.

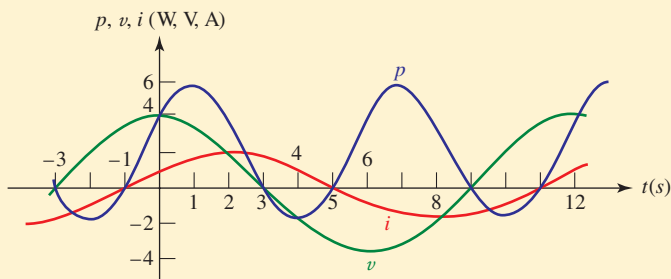

■ FIGURE 11.4 Curves of  $v(t)$ ,  $i(t)$ , and  $p(t)$  are plotted as functions of time for a simple circuit in which the phasor voltage  $\mathbf{V} = 4/\underline{0^\circ}$  V is applied to the impedance  $\mathbf{Z} = 2/\underline{60^\circ}$   $\Omega$  at  $\omega = \pi/6$  rad/s.

## PRACTICE

11.2 Given the phasor voltage  $\mathbf{V} = 115\sqrt{2}/\underline{45^\circ}$  V across an impedance  $\mathbf{Z} = 16.26/\underline{19.3^\circ}$   $\Omega$ , obtain an expression for the instantaneous power, and compute the average power if  $\omega = 50$  rad/s.

Ans:  $767.5 + 813.2 \cos(100t + 70.7^\circ)$  W; 767.5 W.

## Average Power Absorbed by an Ideal Resistor

The phase-angle difference between the current through and the voltage across a pure resistor is zero. Thus,

$$P_R = \frac{1}{2} V_m I_m \cos 0 = \frac{1}{2} V_m I_m$$

or

$$P_R = \frac{1}{2} I_m^2 R \quad [12]$$

or

$$P_R = \frac{V_m^2}{2R} \quad [13]$$

Keep in mind that we are computing the *average* power delivered to a resistor by a sinusoidal source; take care not to confuse this quantity with the *instantaneous* power, which has a similar form.



The last two formulas, enabling us to determine the average power delivered to a pure resistance from a knowledge of either the sinusoidal current or voltage, are simple and important. Unfortunately, *they are often misused*. The most common error is made in trying to apply them in cases where the voltage included in Eq. [13] is *not the voltage across the resistor*. If care is taken to use the current through the resistor in Eq. [12] and the voltage across the resistor in Eq. [13], satisfactory operation is guaranteed. Also, do not forget the factor of  $\frac{1}{2}$ !

## Average Power Absorbed by Purely Reactive Elements

The average power delivered to any device which is purely reactive (i.e., contains no resistors) must be zero. This is a direct result of the  $90^\circ$  phase difference which must exist between current and voltage; hence,  $\cos(\theta - \phi) = \cos \pm 90^\circ = 0$  and

$$P_X = 0$$



The *average* power delivered to any network composed entirely of ideal inductors and capacitors is zero; the *instantaneous* power is zero only at specific instants. Thus, power flows into the network for a part of the cycle and out of the network during another portion of the cycle, with *no* power lost.

### EXAMPLE 11.3

**Find the average power being delivered to an impedance  $Z_L = 8 - j11 \Omega$  by a current  $\mathbf{I} = 5/20^\circ \text{ A}$ .**

We may find the solution quite rapidly by using Eq. [12]. Only the  $8 \Omega$  resistance enters the average-power calculation, since the  $j11 \Omega$  component will not absorb any *average* power. Thus,

$$P = \frac{1}{2}(5^2)8 = 100 \text{ W}$$

### PRACTICE

11.3 Calculate the average power delivered to the impedance  $6/25^\circ \Omega$  by the current  $\mathbf{I} = 2 + j5 \text{ A}$ .

Ans: 78.85 W.

## EXAMPLE 11.4

Find the average power absorbed by each of the three passive elements in Fig. 11.5, as well as the average power supplied by each source.

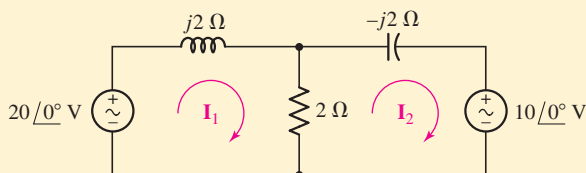

FIGURE 11.5 The average power delivered to each reactive element is zero in the sinusoidal steady state.

Without even analyzing the circuit, we already know that the average power absorbed by the two reactive elements is zero.

The values of  $\mathbf{I}_1$  and  $\mathbf{I}_2$  are found by any of several methods, such as mesh analysis, nodal analysis, or superposition. They are

$$\mathbf{I}_1 = 5 - j10 = 11.18\angle-63.43^\circ \text{ A}$$

$$\mathbf{I}_2 = 5 - j5 = 7.071\angle-45^\circ \text{ A}$$

The downward current through the  $2\ \Omega$  resistor is

$$\mathbf{I}_1 - \mathbf{I}_2 = -j5 = 5\angle-90^\circ \text{ A}$$

so that  $I_m = 5$  A, and the average power absorbed by the resistor is found most easily by Eq. [12]:

$$P_R = \frac{1}{2} I_m^2 R = \frac{1}{2} (5^2) 2 = 25 \text{ W}$$

This result may be checked by using Eq. [11] or Eq. [13]. We next turn to the left source. The voltage  $20\angle 0^\circ$  V and associated current  $\mathbf{I}_1 = 11.18\angle-63.43^\circ$  A satisfy the *active* sign convention, and thus the power *delivered* by this source is

$$P_{\text{left}} = \frac{1}{2} (20)(11.18) \cos[0^\circ - (-63.43^\circ)] = 50 \text{ W}$$

In a similar manner, we find the power *absorbed* by the right source using the *passive* sign convention,

$$P_{\text{right}} = \frac{1}{2} (10)(7.071) \cos(0^\circ + 45^\circ) = 25 \text{ W}$$

Since  $50 = 25 + 25$ , the power relations check.

## PRACTICE

11.4 For the circuit of Fig. 11.6, compute the average power delivered to each of the passive elements. Verify your answer by computing the power delivered by the two sources.

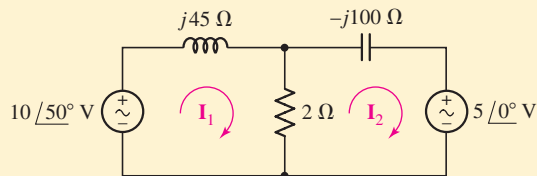

FIGURE 11.6

Ans: 0, 37.6 mW, 0, 42.0 mW, -4.4 mW.

The notation  $Z^*$  denotes the *complex conjugate* of the complex number  $Z$ . It is formed by replacing all “ $j$ ”s with “ $-j$ ”s. See Appendix 5 for more details.

## Maximum Power Transfer

We previously considered the maximum power transfer theorem as it applied to resistive loads and resistive source impedances. For a Thévenin source  $\mathbf{V}_{th}$  and impedance  $\mathbf{Z}_{th} = R_{th} + jX_{th}$  connected to a load  $\mathbf{Z}_L = R_L + jX_L$ , it may be shown that the average power delivered to the load is a maximum when  $R_L = R_{th}$  and  $X_L = -X_{th}$ , that is, when  $\mathbf{Z}_L = \mathbf{Z}_{th}^*$ . This result is often dignified by calling it the *maximum power transfer theorem for the sinusoidal steady state*:

An independent voltage source in *series* with an impedance  $\mathbf{Z}_{th}$  or an independent current source in *parallel* with an impedance  $\mathbf{Z}_{th}$  delivers a **maximum average power** to that load impedance  $\mathbf{Z}_L$  which is the conjugate of  $\mathbf{Z}_{th}$ , or  $\mathbf{Z}_L = \mathbf{Z}_{th}^*$ .

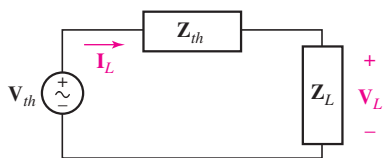

■ FIGURE 11.7 A simple loop circuit used to illustrate the derivation of the maximum power transfer theorem as it applies to circuits operating in the sinusoidal steady state.

The details of the proof are left to the reader, but the basic approach can be understood by considering the simple loop circuit of Fig. 11.7. The Thévenin equivalent impedance  $\mathbf{Z}_{th}$  may be written as the sum of two components,  $R_{th} + jX_{th}$ , and in a similar fashion the load impedance  $\mathbf{Z}_L$  may be written as  $R_L + jX_L$ . The current flowing through the loop is

$$\begin{aligned} \mathbf{I}_L &= \frac{\mathbf{V}_{th}}{\mathbf{Z}_{th} + \mathbf{Z}_L} \\ &= \frac{\mathbf{V}_{th}}{R_{th} + jX_{th} + R_L + jX_L} = \frac{\mathbf{V}_{th}}{R_{th} + R_L + j(X_{th} + X_L)} \end{aligned}$$

and

$$\begin{aligned} \mathbf{V}_L &= \mathbf{V}_{th} \frac{\mathbf{Z}_L}{\mathbf{Z}_{th} + \mathbf{Z}_L} \\ &= \mathbf{V}_{th} \frac{R_L + jX_L}{R_{th} + jX_{th} + R_L + jX_L} = \mathbf{V}_{th} \frac{R_L + jX_L}{R_{th} + R_L + j(X_{th} + X_L)} \end{aligned}$$

The magnitude of  $\mathbf{I}_L$  is

$$\frac{|\mathbf{V}_{th}|}{\sqrt{(R_{th} + R_L)^2 + (X_{th} + X_L)^2}}$$

and the phase angle is

$$\angle \mathbf{V}_{th} - \tan^{-1} \left( \frac{X_{th} + X_L}{R_{th} + R_L} \right)$$

Similarly, the magnitude of  $\mathbf{V}_L$  is

$$\frac{|\mathbf{V}_{th}| \sqrt{R_L^2 + X_L^2}}{\sqrt{(R_{th} + R_L)^2 + (X_{th} + X_L)^2}}$$

and its phase angle is

$$\angle \mathbf{V}_{th} + \tan^{-1} \left( \frac{X_L}{R_L} \right) - \tan^{-1} \left( \frac{X_{th} + X_L}{R_{th} + R_L} \right)$$



Referring to Eq. [11], then, we find an expression for the average power  $P$  delivered to the load impedance  $\mathbf{Z}_L$ :

$$P = \frac{\frac{1}{2} |\mathbf{V}_{th}|^2 \sqrt{R_L^2 + X_L^2}}{(R_{th} + R_L)^2 + (X_{th} + X_L)^2} \cos\left(\tan^{-1}\left(\frac{X_L}{R_L}\right)\right) \quad [14]$$

In order to prove that maximum average power is indeed delivered to the load when  $\mathbf{Z}_L = \mathbf{Z}_{th}^*$ , we must perform two separate steps. First, the derivative of Eq. [14] with respect to  $R_L$  must be set to zero. Second, the derivative of Eq. [14] with respect to  $X_L$  must be set to zero. The remaining details are left as an exercise for the avid reader.

### EXAMPLE 11.5

**A particular circuit is composed of the series combination of a sinusoidal voltage source  $3 \cos(100t - 3^\circ)$  V, a  $500 \Omega$  resistor, a  $30$  mH inductor, and an unknown impedance. If we are assured that the voltage source is delivering maximum average power to the unknown impedance, what is its value?**

The phasor representation of the circuit is sketched in Fig. 11.8. The circuit is easily seen as an unknown impedance  $\mathbf{Z}_\ell$  in series with a Thévenin equivalent consisting of the  $3/\underline{-3^\circ}$  V source and a Thévenin impedance  $500 + j3 \Omega$ .

Since the circuit of Fig. 11.8 is already in the form required to employ the maximum average power transfer theorem, we know that maximum average power will be transferred to an impedance equal to the complex conjugate of  $\mathbf{Z}_{th}$ , or

$$\mathbf{Z}_\ell = \mathbf{Z}_{th}^* = 500 - j3 \Omega$$

This impedance can be constructed in several ways, the simplest being a  $500 \Omega$  resistor in series with a capacitor having impedance  $-j3 \Omega$ . Since the operating frequency of the circuit is  $100$  rad/s, this corresponds to a capacitance of  $3.333$  mF.

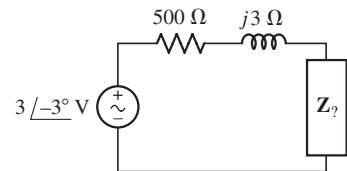

■ FIGURE 11.8 The phasor representation of a simple series circuit composed of a sinusoidal voltage source, a resistor, an inductor, and an unknown impedance.

### PRACTICE

11.5 If the  $30$  mH inductor of Example 11.5 is replaced with a  $10 \mu\text{F}$  capacitor, what is the value of the inductive component of the unknown impedance  $\mathbf{Z}_\ell$  if it is known that  $\mathbf{Z}_\ell$  is absorbing maximum power?

Ans:  $10 \text{ H}$ .

## Average Power for Nonperiodic Functions

We should pay some attention to *nonperiodic* functions. One practical example of a nonperiodic power function for which an average power value is desired is the power output of a radio telescope directed toward a “radio star.” Another is the sum of a number of periodic functions, each function having a different period, such that no greater common period can be found for the combination. For example, the current

$$i(t) = \sin t + \sin \pi t \quad [15]$$

is nonperiodic because the ratio of the periods of the two sine waves is an irrational number. At  $t = 0$ , both terms are zero and increasing. But the first term is zero and increasing only when  $t = 2\pi n$ , where  $n$  is an integer, and thus periodicity demands that  $\pi t$  or  $\pi(2\pi n)$  must equal  $2\pi m$ , where  $m$  is also an integer. No solution (integral values for both  $m$  and  $n$ ) for this equation is possible. It may be illuminating to compare the nonperiodic expression in Eq. [15] with the *periodic* function

$$i(t) = \sin t + \sin 3.14t \quad [16]$$

where 3.14 is an exact decimal expression and is *not* to be interpreted as 3.141592. . . . With a little effort,<sup>2</sup> it can be shown that the period of this current wave is  $100\pi$  seconds.

The average value of the power delivered to a  $1 \Omega$  resistor by either a periodic current such as Eq. [16] or a nonperiodic current such as Eq. [15] may be found by integrating over an infinite interval. Much of the actual integration can be avoided because of our thorough knowledge of the average values of simple functions. We therefore obtain the average power delivered by the current in Eq. [15] by applying Eq. [9]:

$$P = \lim_{\tau \rightarrow \infty} \frac{1}{\tau} \int_{-\tau/2}^{\tau/2} (\sin^2 t + \sin^2 \pi t + 2 \sin t \sin \pi t) dt$$

We now consider  $P$  as the sum of three average values. The average value of  $\sin^2 t$  over an infinite interval is found by replacing  $\sin^2 t$  with  $(\frac{1}{2} - \frac{1}{2} \cos 2t)$ ; the average is simply  $\frac{1}{2}$ . Similarly, the average value of  $\sin^2 \pi t$  is also  $\frac{1}{2}$ . And the last term can be expressed as the sum of two cosine functions, each of which must certainly have an average value of zero. Thus,

$$P = \frac{1}{2} + \frac{1}{2} = 1 \text{ W}$$

An identical result is obtained for the periodic current of Eq. [16]. Applying this same method to a current function which is the sum of several sinusoids of *different periods* and arbitrary amplitudes,

$$i(t) = I_{m1} \cos \omega_1 t + I_{m2} \cos \omega_2 t + \cdots + I_{mN} \cos \omega_N t \quad [17]$$

we find the average power delivered to a resistance  $R$ ,

$$P = \frac{1}{2} (I_{m1}^2 + I_{m2}^2 + \cdots + I_{mN}^2) R \quad [18]$$

The result is unchanged if an arbitrary phase angle is assigned to each component of the current. This important result is surprisingly simple when we think of the steps required for its derivation: squaring the current function, integrating, and taking the limit. The result is also just plain

## EXAMPLE 11.6

**Find the average power delivered to a  $4 \Omega$  resistor by the current  $i_1 = 2 \cos 10t - 3 \cos 20t$  A.**

Since the two cosine terms are at *different* frequencies, the two average-power values may be calculated separately and added. Thus, this current delivers  $\frac{1}{2}(2^2)4 + \frac{1}{2}(3^2)4 = 8 + 18 = 26$  W to a  $4 \Omega$  resistor.

(2)  $T_1 = 2\pi$  and  $T_2 = 2\pi/3.14$ . Therefore, we seek integral values of  $m$  and  $n$  such that  $2\pi n = 2\pi m/3.14$ , or  $3.14n = m$ , or  $\frac{314}{100}n = m$  or  $157n = 50m$ . Thus, the smallest integral values for  $n$  and  $m$  are  $n = 50$  and  $m = 157$ . The period is therefore  $T = 2\pi n = 100\pi$ , or  $T = 2\pi(157/3.14) = 100\pi$  s.

## EXAMPLE 11.7

Find the average power delivered to a  $4\ \Omega$  resistor by the current  $i_2 = 2 \cos 10t - 3 \cos 10t$  A.

Here, the two components of the current are at the *same* frequency, and they must therefore be combined into a single sinusoid at that frequency. Thus,  $i_2 = 2 \cos 10t - 3 \cos 10t = -\cos 10t$  delivers only  $\frac{1}{2}(1^2)4 = 2$  W of average power to a  $4\ \Omega$  resistor.

## PRACTICE

11.6 A voltage source  $v_s$  is connected across a  $4\ \Omega$  resistor. Find the average power absorbed by the resistor if  $v_s$  equals (a)  $8 \sin 200t$  V; (b)  $8 \sin 200t - 6 \cos(200t - 45^\circ)$  V; (c)  $8 \sin 200t - 4 \sin 100t$  V; (d)  $8 \sin 200t - 6 \cos(200t - 45^\circ) - 5 \sin 100t + 4$  V.

Ans: 8.00 W; 4.01 W; 10.00 W; 11.14 W.

surprising, because it shows that, *in this special case of a current such as Eq. [17], where each term has a unique frequency, superposition is applicable to power.* Superposition is *not* applicable for a current which is the sum of two direct currents, nor is it applicable for a current which is the sum of two sinusoids of the same frequency.



### 11.3 EFFECTIVE VALUES OF CURRENT AND VOLTAGE

In North America, most power outlets deliver a sinusoidal voltage having a frequency of 60 Hz and a “voltage” of 115 V (elsewhere, 50 Hz and 240 V are typically encountered). But what is meant by “115 volts”? This is certainly not the instantaneous value of the voltage, for the voltage is not a constant. The value of 115 V is also not the amplitude which we have been symbolizing as  $V_m$ ; if we displayed the voltage waveform on a calibrated oscilloscope, we would find that the amplitude of this voltage at one of our ac outlets is  $115\sqrt{2}$ , or 162.6, volts. We also cannot fit the concept of an average value to the 115 V, because the average value of the sine wave is zero. We might come a little closer by trying the magnitude of the average over a positive or negative half cycle; by using a rectifier-type voltmeter at the outlet, we should measure 103.5 V. As it turns out, however, 115 V is the *effective value* of this sinusoidal voltage; it is a measure of the effectiveness of a voltage source in delivering power to a resistive load.

#### Effective Value of a Periodic Waveform

Let us arbitrarily define effective value in terms of a current waveform, although a voltage could equally well be selected. The *effective value* of any periodic current is equal to the value of the direct current which, flowing through an  $R$  ohm resistor, delivers the same average power to the resistor as does the periodic current.

In other words, we allow the given periodic current to flow through the resistor, determine the instantaneous power  $i^2R$ , and then find the average value of  $i^2R$  over a period; this is the average power. We then cause a direct

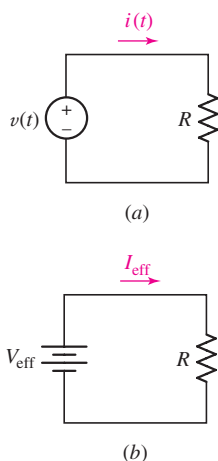

■ FIGURE 11.9 If the resistor receives the same average power in parts *a* and *b*, then the effective value of  $i(t)$  is equal to  $I_{\text{eff}}$ , and the effective value of  $v(t)$  is equal to  $V_{\text{eff}}$ .



current to flow through this same resistor and adjust the value of the direct current until the same value of average power is obtained. The resulting magnitude of the direct current is equal to the effective value of the given periodic current. These ideas are illustrated in Fig. 11.9.

The general mathematical expression for the effective value of  $i(t)$  is now easily obtained. The average power delivered to the resistor by the periodic current  $i(t)$  is

$$P = \frac{1}{T} \int_0^T i^2 R dt = \frac{R}{T} \int_0^T i^2 dt$$

where the period of  $i(t)$  is  $T$ . The power delivered by the direct current is

$$P = I_{\text{eff}}^2 R$$

Equating the power expressions and solving for  $I_{\text{eff}}$ , we get

$$I_{\text{eff}} = \sqrt{\frac{1}{T} \int_0^T i^2 dt} \quad [19]$$

The result is independent of the resistance  $R$ , as it must be to provide us with a worthwhile concept. A similar expression is obtained for the effective value of a periodic voltage by replacing  $i$  and  $I_{\text{eff}}$  by  $v$  and  $V_{\text{eff}}$ , respectively.

Notice that the effective value is obtained by first squaring the time function, then taking the average value of the squared function over a period, and finally taking the square root of the average of the squared function. In short, the operation involved in finding an effective value is the (square) root of the mean of the square; for this reason, the effective value is often called the **root-mean-square** value, or simply the **rms** value.

## Effective (RMS) Value of a Sinusoidal Waveform

The most important special case is that of the sinusoidal waveform. Let us select the sinusoidal current

$$i(t) = I_m \cos(\omega t + \phi)$$

which has a period

$$T = \frac{2\pi}{\omega}$$

and substitute in Eq. [19] to obtain the effective value

$$\begin{aligned} I_{\text{eff}} &= \sqrt{\frac{1}{T} \int_0^T I_m^2 \cos^2(\omega t + \phi) dt} \\ &= I_m \sqrt{\frac{\omega}{2\pi} \int_0^{2\pi/\omega} \left[ \frac{1}{2} + \frac{1}{2} \cos(2\omega t + 2\phi) \right] dt} \\ &= I_m \sqrt{\frac{\omega}{4\pi} [t]_0^{2\pi/\omega}} \\ &= \frac{I_m}{\sqrt{2}} \end{aligned}$$



Thus the effective value of a sinusoidal current is a real quantity which is independent of the phase angle and numerically equal to  $1/\sqrt{2} = 0.707$  times the amplitude of the current. A current  $\sqrt{2} \cos(\omega t + \phi)$  A, therefore, has an effective value of 1 A and will deliver the **same** average power to any resistor as will a **direct** current of 1 A.

It should be noted carefully that the  $\sqrt{2}$  factor that we obtained as the ratio of the amplitude of the periodic current to the effective value is applicable only when the periodic function is *sinusoidal*. For a sawtooth waveform, for example, the effective value is equal to the maximum value divided by  $\sqrt{3}$ . The factor by which the maximum value must be divided to obtain the effective value depends on the mathematical form of the given periodic function; it may be either rational or irrational, depending on the nature of the function.

### Use of RMS Values to Compute Average Power

The use of the effective value also simplifies slightly the expression for the average power delivered by a sinusoidal current or voltage by avoiding use of the factor  $\frac{1}{2}$ . For example, the average power delivered to an  $R$  ohm resistor by a sinusoidal current is

$$P = \frac{1}{2} I_m^2 R$$

Since  $I_{\text{eff}} = I_m/\sqrt{2}$ , the average power may be written as

$$P = I_{\text{eff}}^2 R \quad [20]$$

The other power expressions may also be written in terms of effective values:

$$P = V_{\text{eff}} I_{\text{eff}} \cos(\theta - \phi) \quad [21]$$

$$P = \frac{V_{\text{eff}}^2}{R} \quad [22]$$

Although we have succeeded in eliminating the factor  $\frac{1}{2}$  from our average-power relationships, we must now take care to determine whether a sinusoidal quantity is expressed in terms of its amplitude or its effective value. In practice, the effective value is usually used in the fields of power transmission or distribution and of rotating machinery; in the areas of electronics and communications, the amplitude is more often used. We will assume that the amplitude is specified unless the term “rms” is explicitly used, or we are otherwise instructed.

In the sinusoidal steady state, phasor voltages and currents may be given either as effective values or as amplitudes; the two expressions differ only by a factor of  $\sqrt{2}$ . The voltage  $50/30^\circ$  V is expressed in terms of an amplitude; as an rms voltage, we should describe the same voltage as  $35.4/30^\circ$  V rms.

### Effective Value with Multiple-Frequency Circuits

In order to determine the effective value of a periodic or nonperiodic waveform which is composed of the sum of a number of sinusoids of different frequencies, we may use the appropriate average-power relationship of Eq. [18], developed in Sec. 11.2, rewritten in terms of the effective values of the several components:

$$P = (I_{1\text{eff}}^2 + I_{2\text{eff}}^2 + \cdots + I_{N\text{eff}}^2) R \quad [23]$$

The fact that the effective value is defined in terms of an equivalent dc quantity provides us with average-power formulas for resistive circuits which are identical with those used in dc analysis.



From this we see that the effective value of a current which is composed of any number of sinusoidal currents of *different* frequencies can be expressed as

$$I_{\text{eff}} = \sqrt{I_{1\text{eff}}^2 + I_{2\text{eff}}^2 + \cdots + I_{N\text{eff}}^2} \quad [24]$$

These results indicate that if a sinusoidal current of 5 A rms at 60 Hz flows through a  $2 \Omega$  resistor, an average power of  $5^2(2) = 50$  W is absorbed by the resistor; if a second current—perhaps 3 A rms at 120 Hz, for example—is also present, the absorbed power is  $3^2(2) + 50 = 68$  W. Using Eq. [24] instead, we find that the effective value of the sum of the 60 and 120 Hz currents is 5.831 A. Thus,  $P = 5.831^2(2) = 68$  W as before. However, if the second current is also at 60 Hz, the effective value of the sum of the two 60 Hz currents may have any value between 2 and 8 A. Thus, the absorbed power may have *any* value between 8 W and 128 W, depending on the relative phase of the two current components.

### PRACTICE

11.7 Calculate the effective value of each of the periodic voltages:

(a)  $6 \cos 25t$ ; (b)  $6 \cos 25t + 4 \sin(25t + 30^\circ)$ ; (c)  $6 \cos 25t + 5 \cos^2(25t)$ ; (d)  $6 \cos 25t + 5 \sin 30t + 4$  V.

Ans: 4.24 V; 6.16 V; 5.23 V; 6.82 V.

Note that the effective value of a dc quantity  $K$  is simply  $K$ , not  $\frac{K}{\sqrt{2}}$ .

## COMPUTER-AIDED ANALYSIS

Several useful techniques are available through PSpice for calculation of power quantities. In particular, the built-in functions of Probe allow us to both plot the instantaneous power and compute the average power. For example, consider the simple voltage divider circuit of Fig. 11.10, which is being driven by a 60 Hz sine wave with an

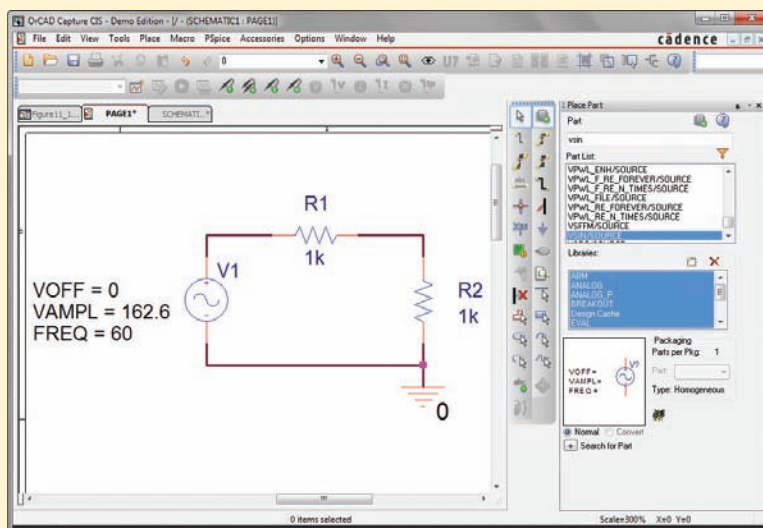
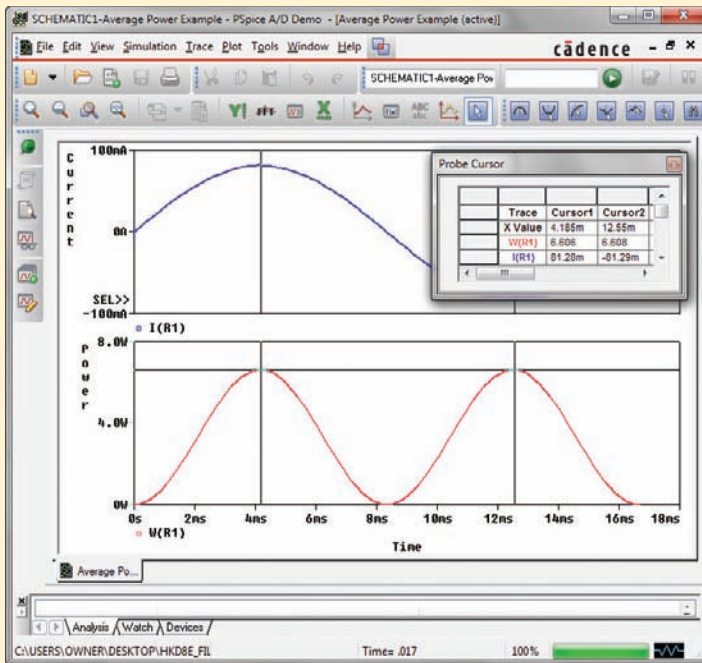

FIGURE 11.10 A simple voltage divider circuit driven by a 115 V rms source operating at 60 Hz.

amplitude of  $115\sqrt{2}$  V. We begin by performing a transient simulation over one period of the voltage waveform,  $\frac{1}{60}$  s.

The current along with the instantaneous power dissipated in resistor R1 is plotted in Fig. 11.11 by employing the **Add Plot to Window** option under **Plot**. The instantaneous power is periodic, with a nonzero average value and a peak of 6.61 W.



■ FIGURE 11.11 Current and instantaneous power associated with resistor R1 of Fig. 11.10.

The easiest means of using Probe to obtain the average power, which we expect to be  $\frac{1}{2} \left( 162.6 \frac{1000}{1000+1000} \right) (81.3 \times 10^{-3}) = 3.305$  W, is to make use of the built-in “running average” function. Once the **Add Traces** dialog box appears (**Trace**,  $\approx$  **Add Trace . . .**), type

$$\text{AVG}(I(R1) * I(R1) * 1000)$$

in the **Trace Expression** window.

As can be seen in Fig. 11.12, the average value of the power over either one or two periods is 3.305 W, in agreement with the hand calculation. Note that since PSpice only calculates at specific times, the circuit was not simulated at precisely 8.333 ms and hence **Cursor 1** indicates a slightly higher average power.

Probe also allows us to compute the average over a specific interval using the built-in function **avgx**. For example, to use this function to compute the average power over a single period, which in this case is  $1/120 = 8.33$  ms, we would enter

$$\text{AVGX}(I(R1) * I(R1) * 1000, 8.33 \text{ m})$$

Either approach will result in a value of 3.305 W at the endpoint of the plot.

(Continued on next page)

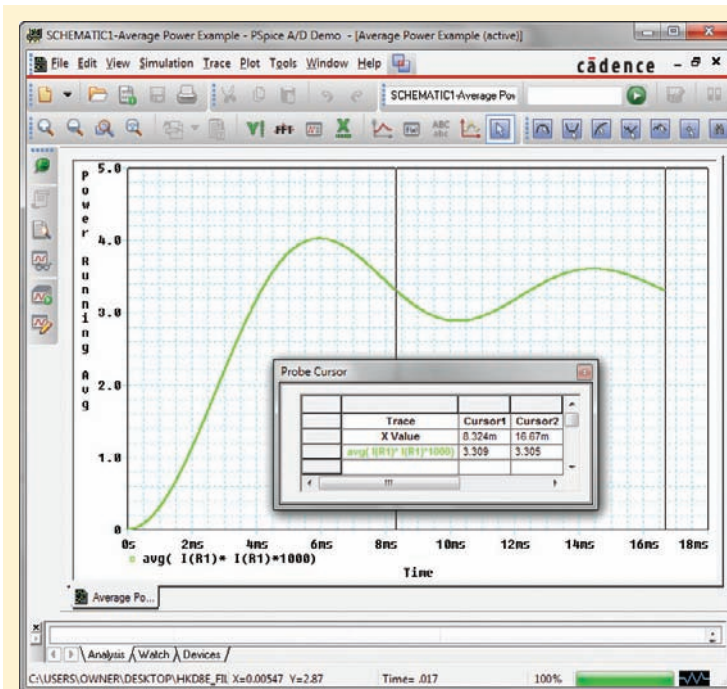

FIGURE 11.12 Calculated running average of the power dissipated by resistor R1.

## 11.4 APPARENT POWER AND POWER FACTOR

Historically, the introduction of the concepts of apparent power and power factor can be traced to the electric power industry, where large amounts of electric energy must be transferred from one point to another; the efficiency with which this transfer is effected is related directly to the cost of the electric energy, which is eventually paid by the consumer. Customers who provide loads which result in a relatively poor transmission efficiency must pay a greater price for each *kilowatthour* (kWh) of electric energy they actually receive and use. In a similar way, customers who require a costlier investment in transmission and distribution equipment by the power company will also pay more for each kilowatthour unless the company is benevolent and enjoys losing money.

Let us first define *apparent power* and *power factor* and then show briefly how these terms are related to practical economic situations. We assume that the sinusoidal voltage

$$v = V_m \cos(\omega t + \theta)$$

is applied to a network and the resultant sinusoidal current is

$$i = I_m \cos(\omega t + \phi)$$

The phase angle by which the voltage leads the current is therefore  $(\theta - \phi)$ . The average power delivered to the network, assuming a passive sign



convention at its input terminals, may be expressed either in terms of the maximum values:

$$P = \frac{1}{2} V_m I_m \cos(\theta - \phi)$$

or in terms of the effective values:

$$P = V_{\text{eff}} I_{\text{eff}} \cos(\theta - \phi)$$

If our applied voltage and current responses had been dc quantities, the average power delivered to the network would have been given simply by the product of the voltage and the current. Applying this dc technique to the sinusoidal problem, we should obtain a value for the absorbed power which is “apparently” given by the familiar product  $V_{\text{eff}} I_{\text{eff}}$ . However, this product of the *effective* values of the voltage and current is not the average power; we define it as the **apparent power**. Dimensionally, apparent power must be measured in the same units as real power, since  $\cos(\theta - \phi)$  is dimensionless; but in order to avoid confusion, the term **volt-amperes**, or VA, is applied to the apparent power. Since  $\cos(\theta - \phi)$  cannot have a magnitude greater than unity, the magnitude of the real power can never be greater than the magnitude of the apparent power.

The ratio of the real or average power to the apparent power is called the **power factor**, symbolized by PF. Hence,

$$\text{PF} = \frac{\text{average power}}{\text{apparent power}} = \frac{P}{V_{\text{eff}} I_{\text{eff}}}$$

In the sinusoidal case, the power factor is simply  $\cos(\theta - \phi)$ , where  $(\theta - \phi)$  is the angle by which the voltage leads the current. This relationship is the reason why the angle  $(\theta - \phi)$  is often referred to as the **PF angle**.

For a purely resistive load, the voltage and current are in phase,  $(\theta - \phi)$  is zero, and the PF is unity. In other words, the apparent power and the average power are equal. Unity PF, however, may also be achieved for loads that contain both inductance and capacitance if the element values and the operating frequency are carefully selected to provide an input impedance having a zero phase angle. A purely reactive load, that is, one containing no resistance, will cause a phase difference between the voltage and current of either plus or minus  $90^\circ$ , and the PF is therefore zero.

Between these two extreme cases there are the general networks for which the PF can range from zero to unity. A PF of 0.5, for example, indicates a load having an input impedance with a phase angle of either  $60^\circ$  or  $-60^\circ$ ; the former describes an inductive load, since the voltage leads the current by  $60^\circ$ , while the latter refers to a capacitive load. The ambiguity in the exact nature of the load is resolved by referring to a leading PF or a lagging PF, the terms *leading* or *lagging* referring to the *phase of the current with respect to the voltage*. Thus, an inductive load will have a lagging PF and a capacitive load a leading PF.

Apparent power is not a concept which is limited to sinusoidal forcing functions and responses. It may be determined for any current and voltage waveshapes by simply taking the product of the effective values of the current and voltage.



## EXAMPLE 11.8

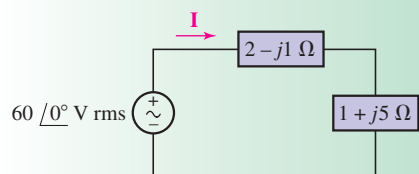

FIGURE 11.13 A circuit in which we seek the average power delivered to each element, the apparent power supplied by the source, and the power factor of the combined load.

Calculate values for the average power delivered to each of the two loads shown in Fig. 11.13, the apparent power supplied by the source, and the power factor of the combined loads.

► **Identify the goal of the problem.**

The average power refers to the power drawn by the resistive components of the load elements; the apparent power is the product of the effective voltage and the effective current of the load combination.

► **Collect the known information.**

The effective voltage is 60 V rms, which appears across a combined load of  $2 - j + 1 + j5 = 3 + j4 \Omega$ .

► **Devise a plan.**

Simple phasor analysis will provide the current. Knowing voltage and current will enable us to calculate average power and apparent power; these two quantities can be used to obtain the power factor.

► **Construct an appropriate set of equations.**

The average power  $P$  supplied to a load is given by

$$P = I_{\text{eff}}^2 R$$

where  $R$  is the real part of the load impedance. The apparent power supplied by the source is  $V_{\text{eff}} I_{\text{eff}}$ , where  $V_{\text{eff}} = 60$  V rms.

The power factor is calculated as the ratio of these two quantities:

$$\text{PF} = \frac{\text{average power}}{\text{apparent power}} = \frac{P}{V_{\text{eff}} I_{\text{eff}}}$$

► **Determine if additional information is required.**

We require  $I_{\text{eff}}$ :

$$\mathbf{I} = \frac{60/0^\circ}{3 + j4} = 12/\underline{-53.13^\circ} \text{ A rms}$$

so  $I_{\text{eff}} = 12$  A rms, and  $\text{ang } \mathbf{I} = -53.13^\circ$ .

► **Attempt a solution.**

The average power delivered to the top load is given by

$$P_{\text{upper}} = I_{\text{eff}}^2 R_{\text{top}} = (12)^2(2) = 288 \text{ W}$$

and the average power delivered to the right load is given by

$$P_{\text{lower}} = I_{\text{eff}}^2 R_{\text{right}} = (12)^2(1) = 144 \text{ W}$$

The source itself supplies an apparent power of  $V_{\text{eff}} I_{\text{eff}} = (60)(12) = 720$  VA.

Finally, the power factor of the combined loads is found by considering the voltage and current associated with the combined loads. This

power factor is, of course, identical to the power factor for the source. Thus

$$\text{PF} = \frac{P}{V_{\text{eff}} I_{\text{eff}}} = \frac{432}{60(12)} = 0.6 \text{ lagging}$$

since the combined load is *inductive*.

► **Verify the solution. Is it reasonable or expected?**

The total average power delivered to the source is  $288 + 144 = 432$  W. The average power supplied by the source is

$$P = V_{\text{eff}} I_{\text{eff}} \cos(\text{ang } \mathbf{V} - \text{ang } \mathbf{I}) = (60)(12) \cos(0 + 53.13^\circ) = 432 \text{ W}$$

so we see the power balance is correct.

We might also write the combined load impedance as  $5/\underline{53.1^\circ} \Omega$ , identify  $53.1^\circ$  as the PF angle, and thus have a PF of  $\cos 53.1^\circ = 0.6$  lagging.

### PRACTICE

11.8 For the circuit of Fig. 11.14, determine the power factor of the combined loads if  $Z_L = 10 \Omega$ .

Ans: 0.9966 leading.

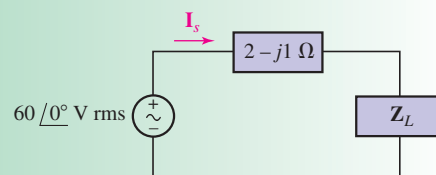

■ FIGURE 11.14

## 11.5 COMPLEX POWER

As we saw in Chap. 10, “complex” numbers do not actually “complicate” analysis. By allowing us to carry two pieces of information together through a series of calculations via the “real” and “imaginary” components, they often greatly simplify what might otherwise be tedious calculations. This is particularly true with power, since we have resistive as well as inductive and capacitive elements in a general load. In this section, we define **complex power** to allow us to calculate the various contributions to the total power in a clean, efficient fashion. The magnitude of the complex power is simply the apparent power. The real part is the average power and—as we are about to see—the imaginary part is a new quantity, termed the **reactive power**, which describes the rate of energy transfer into and out of reactive load components (e.g., inductors and capacitors).

We define complex power with reference to a general sinusoidal voltage  $\mathbf{V}_{\text{eff}} = V_{\text{eff}}/\underline{\theta}$  across a pair of terminals and a general sinusoidal current  $\mathbf{I}_{\text{eff}} = I_{\text{eff}}/\underline{\phi}$  flowing into one of the terminals in such a way as to satisfy the passive sign convention. The average power  $P$  absorbed by the two-terminal network is thus

$$P = V_{\text{eff}} I_{\text{eff}} \cos(\theta - \phi)$$

Complex nomenclature is next introduced by making use of Euler’s formula in the same way as we did in introducing phasors. We express  $P$  as

$$P = V_{\text{eff}} I_{\text{eff}} \text{Re}\{e^{j(\theta - \phi)}\}$$

or

$$P = \operatorname{Re}\{V_{\text{eff}}e^{j\theta}I_{\text{eff}}e^{-j\phi}\}$$

The phasor voltage may now be recognized as the first two factors within the brackets in the preceding equation, but the second two factors do not quite correspond to the phasor current, because the angle includes a minus sign, which is not present in the expression for the phasor current. That is, the phasor current is

$$\mathbf{I}_{\text{eff}} = I_{\text{eff}}e^{j\phi}$$

and we therefore must make use of conjugate notation:

$$\mathbf{I}_{\text{eff}}^* = I_{\text{eff}}e^{-j\phi}$$

Hence

$$P = \operatorname{Re}\{\mathbf{V}_{\text{eff}}\mathbf{I}_{\text{eff}}^*\}$$

and we may now let power become complex by defining the **complex power**  $\mathbf{S}$  as

$$\mathbf{S} = \mathbf{V}_{\text{eff}}\mathbf{I}_{\text{eff}}^* \quad [25]$$

If we first inspect the polar or exponential form of the complex power,

$$\mathbf{S} = V_{\text{eff}}I_{\text{eff}}e^{j(\theta-\phi)}$$

we see that the magnitude of  $\mathbf{S}$ ,  $V_{\text{eff}}I_{\text{eff}}$ , is the apparent power. The angle of  $\mathbf{S}$ ,  $(\theta - \phi)$ , is the PF angle (i.e., the angle by which the voltage leads the current).

In rectangular form, we have

$$\mathbf{S} = P + jQ \quad [26]$$

where  $P$  is the average power, as before. The imaginary part of the complex power is symbolized as  $Q$  and is termed the *reactive power*. The dimensions of  $Q$  are the same as those of the real power  $P$ , the complex power  $\mathbf{S}$ , and the apparent power  $|\mathbf{S}|$ . In order to avoid confusion with these other quantities, the unit of  $Q$  is defined as the **volt-ampere-reactive** (abbreviated VAR). From Eqs. [25] and [26], it is seen that

$$Q = V_{\text{eff}}I_{\text{eff}}\sin(\theta - \phi) \quad [27]$$

The physical interpretation of reactive power is the time rate of energy flow back and forth between the source (i.e., the utility company) and the reactive components of the load (i.e., inductances and capacitances). These components alternately charge and discharge, which leads to current flow from and to the source, respectively.

The relevant quantities are summarized in Table 11.1 for convenience.

## The Power Triangle

A commonly employed graphical representation of complex power is known as the **power triangle**, and is illustrated in Fig. 11.15. The diagram shows that only two of the three power quantities are required, as the third may be obtained by trigonometric relationships. If the power triangle lies in the first quadrant ( $\theta - \phi > 0$ ); the power factor is *lagging* (corresponding to an inductive load); and if the power triangle lies in the fourth quadrant ( $\theta - \phi < 0$ ), the power factor is *leading* (corresponding to a capacitive

The sign of the reactive power characterizes the nature of a passive load at which  $V_{\text{eff}}$  and  $I_{\text{eff}}$  are specified. If the load is inductive, then  $(\theta - \phi)$  is an angle between 0 and  $90^\circ$ , the sine of this angle is positive, and the reactive power is *positive*. A capacitive load results in a *negative* reactive power.

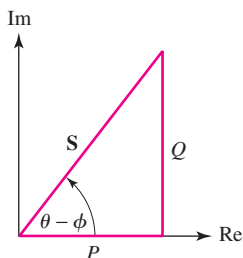

■ FIGURE 11.15 The power triangle representation of complex power.

TABLE 11.1 Summary of Quantities Related to Complex Power

Quantity	Symbol	Formula	Units
Average power	$P$	$V_{\text{eff}} I_{\text{eff}} \cos(\theta - \phi)$	watt (W)
Reactive power	$Q$	$V_{\text{eff}} I_{\text{eff}} \sin(\theta - \phi)$	volt-ampere-reactive (VAR)
Complex power	$S$	$P + jQ$ $V_{\text{eff}} I_{\text{eff}} / \theta - \phi$	volt-ampere (VA)
Apparent power	$ S $	$V_{\text{eff}} I_{\text{eff}}^*$ $V_{\text{eff}} I_{\text{eff}}$	volt-ampere (VA)

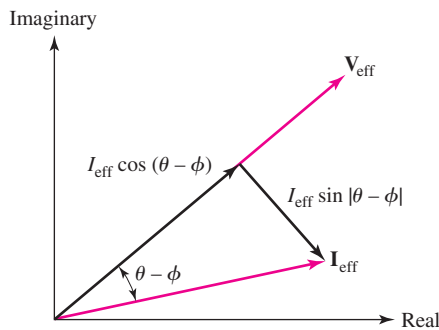

■ FIGURE 11.16 The current phasor  $I_{\text{eff}}$  is resolved into two components, one in phase with the voltage phasor  $V_{\text{eff}}$  and the other  $90^\circ$  out of phase with the voltage phasor. This latter component is called a *quadrature component*.

load). A great deal of qualitative information concerning our load is therefore available at a glance.

Another interpretation of reactive power may be seen by constructing a phasor diagram containing  $V_{\text{eff}}$  and  $I_{\text{eff}}$  as shown in Fig. 11.16. If the phasor current is resolved into two components, one in phase with the voltage, having a magnitude  $I_{\text{eff}} \cos(\theta - \phi)$ , and one  $90^\circ$  out of phase with the voltage, with magnitude equal to  $I_{\text{eff}} \sin|\theta - \phi|$ , then it is clear that the real power is given by the product of the magnitude of the voltage phasor and the component of the phasor current which is in phase with the voltage. Moreover, the product of the magnitude of the voltage phasor and the component of the phasor current which is  $90^\circ$  out of phase with the voltage is the reactive power  $Q$ . It is common to speak of the component of a phasor which is  $90^\circ$  out of phase with some other phasor as a *quadrature component*. Thus  $Q$  is simply  $V_{\text{eff}}$  times the quadrature component of  $I_{\text{eff}}$ .  $Q$  is also known as the *quadrature power*.

## Power Measurement

Strictly speaking, a wattmeter measures average real power  $P$  drawn by a load, and a varmeter reads the average reactive power  $Q$  drawn by a load. However, it is common to find both features in the same meter, which is often also capable of measuring apparent power and power factor (Fig. 11.17).



■ FIGURE 11.17 A clamp-on digital powermeter manufactured by Amprobe, capable of measuring ac currents up to 400 A and voltages up to 600 V. Copyright AMPROBE.

# PRACTICAL APPLICATION

## Power Factor Correction

When electric power is being supplied to large industrial consumers by a power company, the company will frequently include a PF clause in its rate schedules. Under this clause, an additional charge is made to the consumer whenever the PF drops below a certain specified value, usually about 0.85 lagging. Very little industrial power is consumed at leading PFs, because of the nature of typical industrial loads. There are several reasons that force the power company to make this additional charge for low PFs. In the first place, it is evident that larger current-carrying capacity must be built into its generators in order to provide the larger currents that go with lower-PF operation at constant power and constant voltage. Another reason is found in the increased losses in its transmission and distribution system.

In an effort to recoup losses and encourage its customers to operate at high PF, a certain utility charges a penalty of \$0.22/kVAR for each kVAR above a benchmark value computed as 0.62 times the average power demand:

$$\begin{aligned} S &= P + jQ = P + j0.62P = P(1 + j0.62) \\ &= P(1.177/31.8^\circ) \end{aligned}$$

This benchmark targets a PF of 0.85 lagging, as  $\cos 31.8^\circ = 0.85$  and  $Q$  is positive; this is represented graphically in Fig. 11.18. Customers with a PF smaller than the benchmark value are subject to financial penalties.

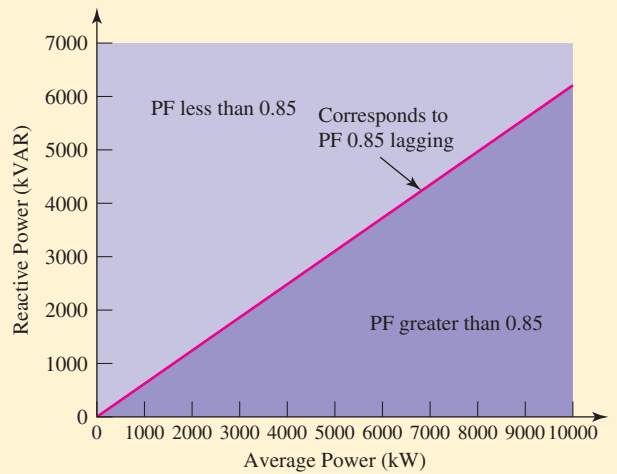

■ FIGURE 11.18 Plot showing acceptable ratio of reactive power to average power for power factor benchmark of 0.85 lagging.

The reactive power requirement is commonly adjusted through the installation of compensation capacitors placed in parallel with the load (typically at the substation outside the customer's facility). The value of the required capacitance can be shown to be

$$C = \frac{P(\tan \theta_{\text{old}} - \tan \theta_{\text{new}})}{\omega V_{\text{rms}}^2} \quad [28]$$

where  $\omega$  is the frequency,  $\theta_{\text{old}}$  is the present PF angle,

It is easy to show that the complex power delivered to several interconnected loads is the sum of the complex powers delivered to each of the individual loads, no matter how the loads are interconnected. For example, consider the two loads shown connected in parallel in Fig. 11.20. If rms values are assumed, the complex power drawn by the combined load is

$$S = \mathbf{VI}^* = \mathbf{V}(\mathbf{I}_1 + \mathbf{I}_2)^* = \mathbf{V}(\mathbf{I}_1^* + \mathbf{I}_2^*)$$

and thus

$$S = \mathbf{VI}_1^* + \mathbf{VI}_2^*$$

as stated.

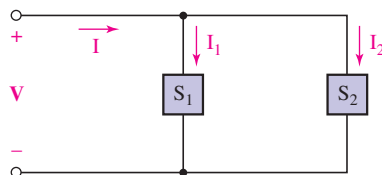

■ FIGURE 11.20 A circuit used to show that the complex power drawn by two parallel loads is the sum of the complex powers drawn by the individual loads.

and  $\theta_{\text{new}}$  is the target PF angle. For convenience, however, compensation capacitor banks are manufactured in specific increments rated in units of kVAR capacity. An example of such an installation is shown in Fig. 11.19.

Now let us consider a specific example. A particular industrial machine plant has a monthly peak demand of 5000 kW and a monthly reactive requirement of 6000 kVAR. Using the rate schedule above, what is the annual cost to this utility customer associated with PF penalties? If compensation is available through the



■ FIGURE 11.19 A compensation capacitor installation. (Courtesy of Nokian Capacitors Ltd.)

utility company at a cost of \$2390 per 1000 kVAR increment and \$3130 per 2000 kVAR increment, what is the most cost-effective solution for the customer?

The PF of the installation is the angle of the complex power  $S$ , which in this case is  $5000 + j6000$  kVA. Thus, the angle is  $\tan^{-1}(6000/5000) = 50.19^\circ$  and the PF is 0.64 lagging. The benchmark reactive power value, computed as 0.62 times the peak demand, is  $0.62(5000) = 3100$  kVAR. So, the plant is drawing  $6000 - 3100 = 2900$  kVAR more reactive power than the utility company is willing to allow without penalty. This represents an annual assessment of  $12(2900)(0.22) = \$7656$  in addition to regular electricity costs.

If the customer chooses to have a single 1000 kVAR increment installed (at a cost of \$2390), the excess reactive power draw is reduced to  $2900 - 1000 = 1900$  kVAR, so that the annual penalty is now  $12(1900)(0.22) = \$5016$ . The total cost this year is then  $\$5016 + \$2390 = \$7406$ , for a savings of \$250. If the customer chooses to have a single 2000 kVAR increment installed (at a cost of \$3130), the excess reactive power draw is reduced to  $2900 - 2000 = 900$  kVAR, so that the annual penalty is now  $12(900)(0.22) = \$2376$ . The total cost this year is then  $\$2376 + \$3130 = \$5506$ , for a first-year savings of \$2150. If, however, the customer goes overboard and installs 3000 kVAR of compensation capacitors so that no penalty is assessed, it will actually cost \$14 more in the first year than if only 2000 kVAR were installed.

## EXAMPLE 11.9

**An industrial consumer is operating a 50 kW (67.1 hp) induction motor at a lagging PF of 0.8. The source voltage is 230 V rms. In order to obtain lower electrical rates, the customer wishes to raise the PF to 0.95 lagging. Specify a suitable solution.**

Although the PF might be raised by increasing the real power and maintaining the reactive power constant, this would not result in a lower bill and is not a cure that interests the consumer. A purely reactive load must be added to the system, and it is clear that it must be added in parallel, since the supply voltage to the induction motor must not change. The circuit of Fig. 11.21 is thus applicable if we interpret  $S_1$  as the induction motor's complex power and  $S_2$  as the complex power drawn by the corrective device.

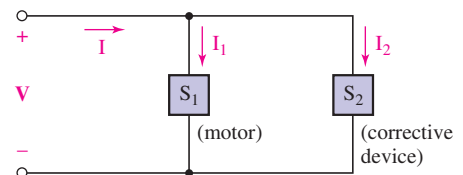

■ FIGURE 11.21

(Continued on next page)

The complex power supplied to the induction motor must have a real part of 50 kW and an angle of  $\cos^{-1}(0.8)$ , or  $36.9^\circ$ . Hence,

$$\mathbf{S}_1 = \frac{50/\angle 36.9^\circ}{0.8} = 50 + j37.5 \text{ kVA}$$

In order to achieve a PF of 0.95, the total complex power must become

$$\mathbf{S} = \mathbf{S}_1 + \mathbf{S}_2 = \frac{50}{0.95} \angle \cos^{-1}(0.95) = 50 + j16.43 \text{ kVA}$$

Thus, the complex power drawn by the corrective load is

$$\mathbf{S}_2 = -j21.07 \text{ kVA}$$

The necessary load impedance  $\mathbf{Z}_2$  may be found in several simple steps. We select a phase angle of  $0^\circ$  for the voltage source, and therefore the current drawn by  $\mathbf{Z}_2$  is

$$\mathbf{I}_2^* = \frac{\mathbf{S}_2}{\mathbf{V}} = \frac{-j21,070}{230} = -j91.6 \text{ A}$$

or

$$\mathbf{I}_2 = j91.6 \text{ A}$$

Therefore,

$$\mathbf{Z}_2 = \frac{\mathbf{V}}{\mathbf{I}_2} = \frac{230}{j91.6} = -j2.51 \Omega$$

If the operating frequency is 60 Hz, this load can be provided by a  $1056 \mu\text{F}$  capacitor connected in parallel with the motor. However, its initial cost, maintenance, and depreciation must be covered by the reduction in the electric bill.

## PRACTICE

11.9 For the circuit shown in Fig. 11.22, find the complex power absorbed by the (a)  $1 \Omega$  resistor; (b)  $-j10 \Omega$  capacitor; (c)  $5 + j10 \Omega$  impedance; (d) source.

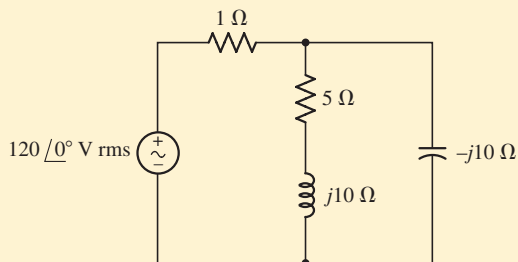

FIGURE 11.22

Ans:  $26.6 + j0 \text{ VA}$ ;  $0 - j1331 \text{ VA}$ ;  $532 + j1065 \text{ VA}$ ;  $-559 + j266 \text{ VA}$ .



**PRACTICE**

11.10 A 440 V rms source supplies power to a load  $Z_L = 10 + j2 \Omega$  through a transmission line having a total resistance of  $1.5 \Omega$ . Find (a) the average and apparent power supplied to the load; (b) the average and apparent power lost in the transmission line; (c) the average and apparent power supplied by the source; (d) the power factor at which the source operates.

Ans: 14.21 kW, 14.49 kVA; 2.131 kW, 2.131 kVA; 16.34 kW, 16.59 kVA; 0.985 lag.

**SUMMARY AND REVIEW**

In this chapter, we introduced a fair number of new power-related terms (summarized in Table 11.2), which might have come as a bit of a surprise after *watts* did so well for us up to this point. The new terminology is largely relevant to ac power systems, where voltages and currents are generally assumed to be sinusoidal (the prevalence of switched-mode power supplies in many computer systems can alter this situation, a topic of more advanced power engineering texts). After clarifying what is meant by instantaneous power, we discussed the concept of average power  $P$ . This quantity is not a function of time, but is a strong function of the phase difference between sinusoidal voltage and current waveforms. Purely reactive elements such as ideal inductors and capacitors absorb *zero average power*. Since such elements do increase the magnitude of the current flowing between the source and load, however, two new terms find common usage: *apparent power* and *power factor*. The average power and apparent power are identical when voltage and current are in phase (i.e., associated with a purely resistive load). The power factor gives us a numerical gauge of how reactive a

**TABLE 11.2** A Summary of AC Power Terms

Term	Symbol	Unit	Description
Instantaneous power	$p(t)$	W	$p(t) = v(t)i(t)$ . It is the value of the power at a specific instant in time. It is <i>not</i> the product of the voltage and current phasors!
Average power	$P$	W	In the sinusoidal steady state, $P = \frac{1}{2} V_m I_m \cos(\theta - \phi)$ , where $\theta$ is the angle of the voltage and $\phi$ is the angle of the current. Reactances do not contribute to $P$ .
Effective or rms value	$V_{\text{rms}}$ or $I_{\text{rms}}$	V or A	Defined, e.g., as $I_{\text{eff}} = \sqrt{\frac{1}{T} \int_0^T i^2 dt}$ ; if $i(t)$ is sinusoidal, then $I_{\text{eff}} = I_m / \sqrt{2}$ .
Apparent power	$ \mathbf{S} $	VA	$ \mathbf{S}  = V_{\text{eff}} I_{\text{eff}}$ , and is the maximum value the average power can be; $P =  \mathbf{S} $ only for purely resistive loads.
Power factor	PF	None	Ratio of the average power to the apparent power. The PF is unity for a purely resistive load, and zero for a purely reactive load.
Reactive power	$Q$	VAR	A means of measuring the energy flow rate to and from reactive loads.
Complex power	$\mathbf{S}$	VA	A convenient complex quantity that contains both the average power $P$ and the reactive power $Q$ : $\mathbf{S} = P + jQ$ .

particular load is: a unity power factor (PF) corresponds to a purely resistive load (if inductors *are* present, they are being “canceled” by an appropriate capacitance); a zero PF indicates a purely reactive load, and the sign of the angle indicates whether the load is capacitive or inductive. Putting all of these concepts together allowed us to create a more compact representation known as *complex power*,  $\mathbf{S}$ . The magnitude of  $\mathbf{S}$  is the apparent power,  $P$  is the real part of  $\mathbf{S}$ , and  $Q$ , the *reactive power* (zero for resistive loads), is the imaginary part of  $\mathbf{S}$ .

Along the way, we paused to introduce the notion of effective values of current and voltage, often referred to as *rms values*. Care must be taken from this point forward to establish whether a particular voltage or current value is being quoted as a magnitude or its corresponding rms value, as an  $\sim 40\%$  error can be introduced. Interestingly, we also discovered an extension of the maximum power theorem encountered in Chap. 5, namely, that maximum average power is delivered to a load whose impedance  $Z_L$  is the *complex conjugate* of the Thévenin equivalent impedance of the network to which it is connected.

For convenience, key points of the chapter are summarized below, along with corresponding example numbers.

- The instantaneous power absorbed by an element is given by the expression  $p(t) = v(t)i(t)$ . (Examples 11.1, 11.2)
- The average power delivered to an impedance by a sinusoidal source is  $\frac{1}{2}V_m I_m \cos(\theta - \phi)$ , where  $\theta$  = the voltage phase angle and  $\phi$  = the phase angle of the current. (Example 11.2)
- Only the *resistive* component of a load draws nonzero average power. The average power delivered to the *reactive* component of a load is zero. (Examples 11.3, 11.4)
- Maximum average power transfer occurs when the condition  $Z_L = Z_{th}^*$  is satisfied. (Example 11.5)
- When multiple sources are present, each operating at a different frequency, the individual contributions to average power may be summed. This is not true for sources operating at the same frequency. (Examples 11.6, 11.7)
- The effective or rms value of a sinusoidal waveform is obtained by dividing its amplitude by  $\sqrt{2}$ .
- The power factor (PF) of a load is the ratio of its average dissipated power to the apparent power. (Example 11.8)
- A purely resistive load will have a unity power factor. A purely reactive load will have a zero power factor. (Example 11.8)
- Complex power is defined as  $\mathbf{S} = P + jQ$ , or  $\mathbf{S} = \mathbf{V}_{\text{eff}} \mathbf{I}_{\text{eff}}^*$ . It is measured in units of volt-amperes (VA). (Example 11.9)
- Reactive power  $Q$  is the imaginary component of the complex power, and is a measure of the energy flow rate into or out of the reactive components of a load. Its unit is the volt-ampere-reactive (VAR). (Example 11.9)
- Capacitors are commonly used to improve the PF of industrial loads to minimize the reactive power required from the utility company. (Example 11.9)

## READING FURTHER

A good overview of ac power concepts can be found in Chap. 2 of:

B. M. Weedy, *Electric Power Systems*, 3rd ed. Chichester, England: Wiley, 1984.

Contemporary issues pertaining to ac power systems can be found in:

*International Journal of Electrical Power & Energy Systems*.  
Guildford, England: IPC Science and Technology Press, 1979–.  
ISSN: 0142-0615.

## EXERCISES

### 11.1 Instantaneous Power

- Determine the instantaneous power delivered to the  $1\ \Omega$  resistor of Fig. 11.23 at  $t = 0$ ,  $t = 1$  s, and  $t = 2$  s if  $v_s$  is equal to (a)  $9$  V; (b)  $9 \sin 2t$  V; (c)  $9 \sin(2t + 13^\circ)$  V; (d)  $9e^{-t}$  V.
- Determine the power absorbed at  $t = 1.5$  ms by each of the three elements of the circuit shown in Fig. 11.24 if  $v_s$  is equal to (a)  $30u(-t)$  V; (b)  $10 + 20u(t)$  V.
- Calculate the power absorbed at  $t = 0^-$ ,  $t = 0^+$ , and  $t = 200$  ms by each of the elements in the circuit of Fig. 11.25 if  $v_s$  is equal to (a)  $-10u(-t)$  V; (b)  $20 + 5u(t)$  V.

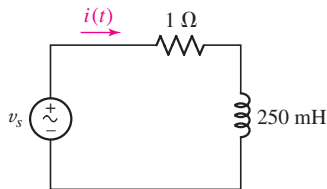

■ FIGURE 11.25

- Three elements are connected in parallel: a  $1\ \text{k}\ \Omega$  resistor, a  $15\ \text{mH}$  inductor, and a  $100 \cos(2 \times 10^5 t)$  mA sinusoidal source. All transients have long since died out, so the circuit is operating in steady state. Determine the power being absorbed by each element at  $t = 10\ \mu\text{s}$ .
- Let  $i_s = 4u(-t)$  A in the circuit of Fig. 11.26. (a) Show that, for all  $t > 0$ , the instantaneous power absorbed by the resistor is equal in magnitude but opposite in sign to the instantaneous power absorbed by the capacitor. (b) Determine the power absorbed by the resistor at  $t = 60$  ms.
- The current source in the circuit of Fig. 11.26 is given by  $i_s = 8 - 7u(t)$  A. Compute the power absorbed by all three elements at  $t = 0^-$ ,  $t = 0^+$ , and  $t = 75$  ms.
- Assuming no transients are present, calculate the power absorbed by each element shown in the circuit of Fig. 11.27 at  $t = 0$ ,  $10$ , and  $20$  ms.

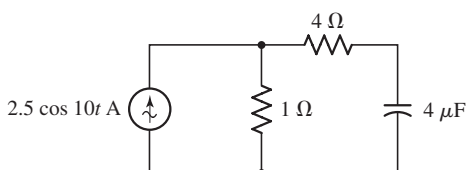

■ FIGURE 11.27

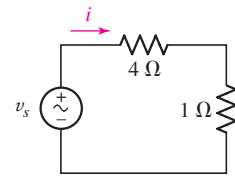

■ FIGURE 11.23

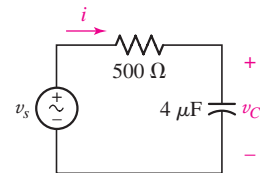

■ FIGURE 11.24

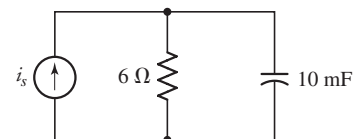

■ FIGURE 11.26

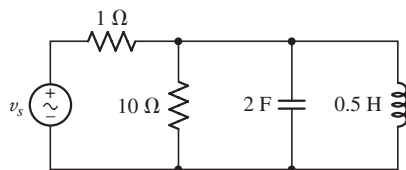

■ FIGURE 11.28

8. Calculate in Fig. 11.28 the power absorbed by the inductor at  $t = 0$  and  $t = 1$  s if  $v_s = 10u(t)$  V.
9. A 100 mF capacitor is storing 100 mJ of energy up until the point when a conductor of resistance  $1.2 \Omega$  falls across its terminals. What is the instantaneous power dissipated in the conductor at  $t = 120$  ms? If the specific heat capacity<sup>3</sup> of the conductor is  $0.9 \text{ kJ/kg} \cdot \text{K}$  and its mass is 1 g, estimate the increase in temperature of the conductor in the first second of the capacitor discharge, assuming both elements are initially at  $23^\circ\text{C}$ .
10. If we take a typical cloud-to-ground lightning *stroke* to represent a current of 30 kA over an interval of  $150 \mu\text{s}$ , calculate (a) the instantaneous power delivered to a copper rod having resistance  $1.2 \text{ m}\Omega$  during the stroke; (b) the total energy delivered to the rod.

## 11.2 Average Power



11. The phasor current  $\mathbf{I} = 9/15^\circ$  mA (corresponding to a sinusoid operating at 45 rad/s) is applied to the series combination of a  $18 \text{ k}\Omega$  resistor and a  $1 \mu\text{F}$  capacitor. Obtain an expression for (a) the instantaneous power and (b) the average power absorbed by the combined load.
12. A phasor voltage  $\mathbf{V} = 100/45^\circ$  V (the sinusoid operates at 155 rad/s) is applied to the parallel combination of a  $1 \Omega$  resistor and a 1 mH inductor. (a) Obtain an expression for the average power absorbed by each passive element. (b) Graph the instantaneous power supplied to the parallel combination, along with the instantaneous power absorbed by each element separately. (Use a single graph.)
13. Calculate the average power delivered by the current  $4 - j2$  A to (a)  $\mathbf{Z} = 9 \Omega$ ; (b)  $\mathbf{Z} = -j1000 \Omega$ ; (c)  $\mathbf{Z} = 1 - j2 + j3 \Omega$ ; (d)  $\mathbf{Z} = 6/32^\circ \Omega$ ; (e)  $\mathbf{Z} = \frac{1.5/-19^\circ}{2 + j} \text{ k}\Omega$ .
14. With regard to the two-mesh circuit depicted in Fig. 11.29, determine the average power absorbed by each passive element, and the average power supplied by each source, and verify that the total supplied average power = the total absorbed average power.

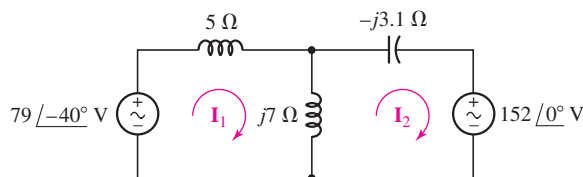

■ FIGURE 11.29



15. (a) Calculate the average power absorbed by each passive element in the circuit of Fig. 11.30, and verify that it equals the average power supplied by the source. (b) Check your solution with an appropriate PSpice simulation.

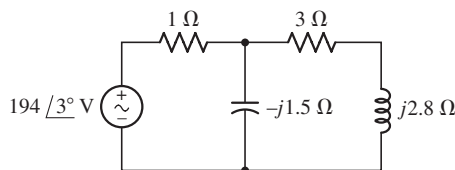

■ FIGURE 11.30

(3) Assume the specific heat capacity  $c$  is given by  $c = Q/m \cdot \Delta T$ , where  $Q$  = the energy delivered to the conductor,  $m$  is its mass, and  $\Delta T$  is the increase in temperature.

16. (a) What load impedance  $Z_L$  will draw the maximum average power from the source shown in Fig. 11.31? (b) Calculate the maximum average power supplied to the load.
17. The inductance of Fig. 11.31 is replaced by the impedance  $9 - j8 \text{ k}\Omega$ . Repeat Exercise 16.
18. Determine the average power supplied by the dependent source in the circuit of Fig. 11.32.

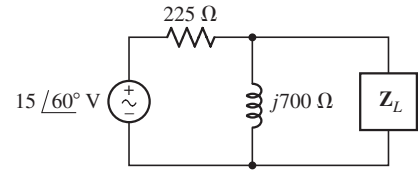

■ FIGURE 11.31

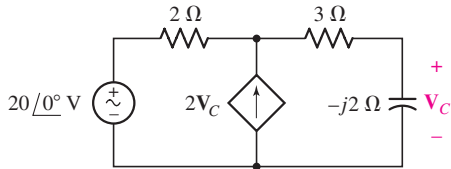

■ FIGURE 11.32

19. (a) Calculate the average power supplied to each passive element in the circuit of Fig. 11.33. (b) Determine the power supplied by each source. (c) Replace the  $8 \Omega$  resistive load with an impedance capable of drawing maximum average power from the remainder of the circuit. (d) Verify your solution with a PSpice simulation.

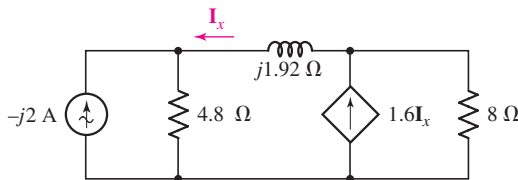

■ FIGURE 11.33

20. (a) Compute the average value of each waveform shown in Fig. 11.34. (b) Square each waveform, and determine the average value of each new periodic waveform.

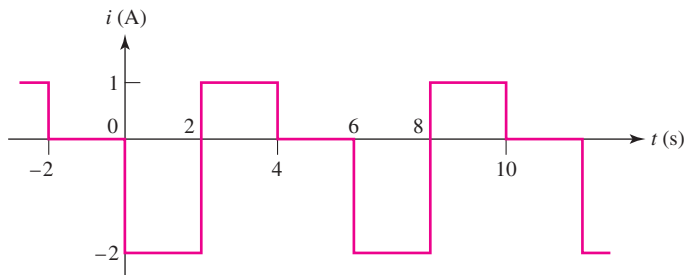

(a)

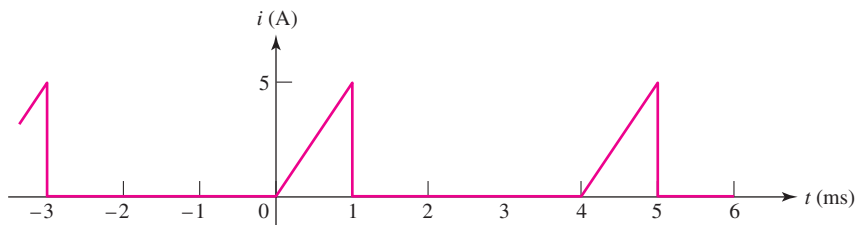

(b)

■ FIGURE 11.34

21. Calculate the average power delivered to a  $2.2\ \Omega$  load by the voltage  $v_s$  equal to (a)  $5\ \text{V}$ ; (b)  $4 \cos 80t - 8 \sin 80t\ \text{V}$ ; (c)  $10 \cos 100t + 12.5 \cos(100t + 19^\circ)\ \text{V}$ .

### 11.3 Effective Values of Current and Voltage

22. Calculate the effective value of the following waveforms: (a)  $7 \sin 30t\ \text{V}$ ; (b)  $100 \cos 80t\ \text{mA}$ ; (c)  $120\sqrt{2} \cos(5000t - 45^\circ)\ \text{V}$ ; (d)  $\frac{100}{\sqrt{2}} \sin(2t + 72^\circ)\ \text{A}$ .
23. Determine the effective value of the following waveforms: (a)  $62.5 \cos 100t\ \text{mV}$ ; (b)  $1.95 \cos 2t\ \text{A}$ ; (c)  $208\sqrt{2} \cos(100\pi t + 29^\circ)\ \text{V}$ ; (d)  $\frac{400}{\sqrt{2}} \sin(2000t - 14^\circ)\ \text{A}$ .
24. Compute the effective value of (a)  $i(t) = 3 \sin 4t\ \text{A}$ ; (b)  $v(t) = 4 \sin 20t \cos 10t$ ; (c)  $i(t) = 2 - \sin 10t\ \text{mA}$ ; (d) the waveform plotted in Fig. 11.35.

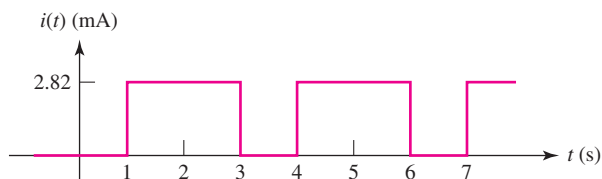

■ FIGURE 11.35

25. For each waveform plotted in Fig. 11.34, determine its frequency, period, and rms value.
26. Determine both the average and rms value of each waveform depicted in Fig. 11.36.

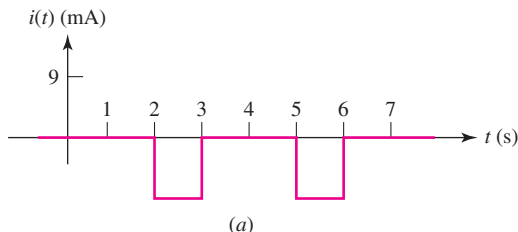

(a)

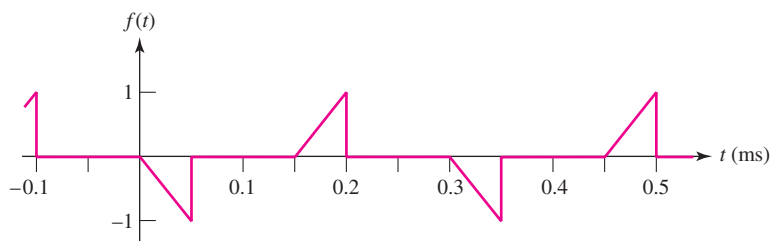

(b)

■ FIGURE 11.36

27. The series combination of a  $1\ \text{k}\Omega$  resistor and a  $2\ \text{H}$  inductor must not dissipate more than  $250\ \text{mW}$  of power at any instant. Assuming a sinusoidal current with  $\omega = 500\ \text{rad/s}$ , what is the largest rms current that can be tolerated?
28. For each of the following waveforms, determine its period, frequency and effective value: (a)  $5\ \text{V}$ ; (b)  $2 \sin 80t - 7 \cos 20t + 5\ \text{V}$ ; (c)  $5 \cos 50t + 3 \sin 50t\ \text{V}$ ; (d)  $8 \cos^2 90t\ \text{mA}$ . (e) Verify your answers with an appropriate simulation.
29. With regard to the circuit of Fig. 11.37, determine whether a purely real value of  $R$  can result in equal rms voltages across the  $14\ \text{mH}$  inductor and the resistor  $R$ . If so, calculate  $R$  and the rms voltage across it; if not, explain why not.



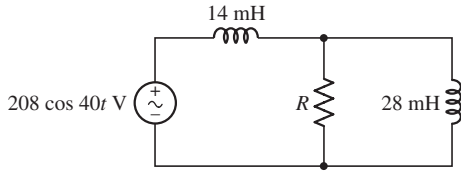

■ FIGURE 11.37

30. (a) Calculate both the average and rms values of the waveform plotted in Fig. 11.38. (b) Verify your solutions with appropriate PSpice simulations (*Hint*: you may want to employ two pulse waveforms added together).

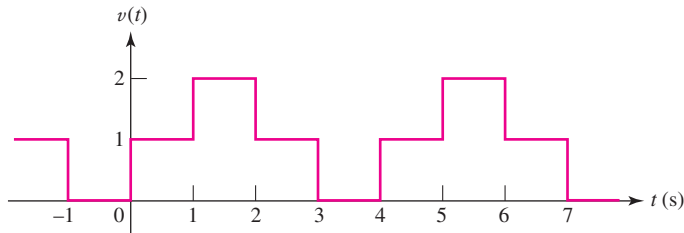

■ FIGURE 11.38

### 11.4 Apparent Power and Power Factor

31. For the circuit of Fig. 11.39, compute the average power delivered to each load, the apparent power supplied by the source, and the power factor of the combined loads if (a)  $\mathbf{Z}_1 = 14/32^\circ \Omega$  and  $\mathbf{Z}_2 = 22 \Omega$ ; (b)  $\mathbf{Z}_1 = 2/0^\circ \Omega$  and  $\mathbf{Z}_2 = 6 - j \Omega$ ; (c)  $\mathbf{Z}_1 = 100/70^\circ \Omega$  and  $\mathbf{Z}_2 = 75/90^\circ \Omega$ .
32. Calculate the power factor of the combined loads of the circuit depicted in Fig. 11.39 if (a) both loads are purely resistive; (b) both loads are purely inductive and  $\omega = 100 \text{ rad/s}$ ; (c) both loads are purely capacitive and  $\omega = 200 \text{ rad/s}$ ; (d)  $\mathbf{Z}_1 = 2\mathbf{Z}_2 = 5 - j8 \Omega$ .
33. A given load is connected to an ac power system. If it is known that the load is characterized by resistive losses and either capacitors, inductors, or neither (but not both), which type of reactive element is part of the load if the power factor is measured to be (a) unity; (b) 0.85 lagging; (c) 0.221 leading; (d)  $\cos(-90^\circ)$ ?
34. An unknown load is connected to a standard European household outlet (240 V rms, 50 Hz). Determine the phase angle difference between the voltage and current, and whether the voltage leads or lags the current, if (a)  $\mathbf{V} = 240/243^\circ \text{ V rms}$  and  $\mathbf{I} = 3/9^\circ \text{ A rms}$ ; (b) the power factor of the load is 0.55 lagging; (c) the power factor of the load is 0.685 leading; (d) the capacitive load draws 100 W average power and 500 volt-amperes apparent power.
35. (a) Design a load which draws an average power of 25 W at a leading PF of 0.88 from a standard North American household outlet (120 V rms, 60 Hz). (b) Design a capacitor-free load which draws an average power of 150 W and an apparent power of 25 W from a household outlet in eastern Japan (110 V rms, 50 Hz).
36. Assuming an operating frequency of 40 rad/s for the circuit shown in Fig. 11.40, and a load impedance of  $50/-100^\circ \Omega$ , calculate (a) the instantaneous power separately delivered to the load and to the 1 k $\Omega$  shunt resistance at  $t = 20 \text{ ms}$ ; (b) the average power delivered to both passive elements; (c) the apparent power delivered to the load; (d) the power factor at which the source is operating.
37. Calculate the power factor at which the source in Fig. 11.40 is operating if the load is (a) purely resistive; (b)  $1000 + j900 \Omega$ ; (c)  $500/-5^\circ \Omega$ .

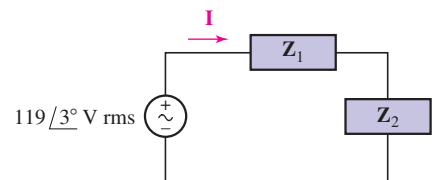

■ FIGURE 11.39

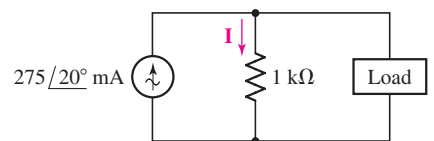

■ FIGURE 11.40

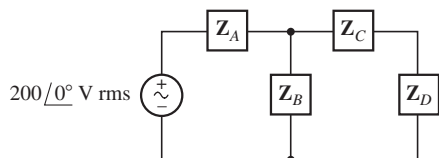

■ FIGURE 11.41

38. Determine the load impedance for the circuit depicted in Fig. 11.40 if the source is operating at a PF of (a) 0.95 leading; (b) unity; (c) 0.45 lagging.
39. For the circuit of Fig. 11.41, find the apparent power delivered to each load, and the power factor at which the source operates, if (a)  $\mathbf{Z}_A = 5 - j2 \Omega$ ,  $\mathbf{Z}_B = 3 \Omega$ ,  $\mathbf{Z}_C = 8 + j4 \Omega$ , and  $\mathbf{Z}_D = 15 \angle -30^\circ \Omega$ ; (b)  $\mathbf{Z}_A = 2 \angle -15^\circ \Omega$ ,  $\mathbf{Z}_B = 1 \Omega$ ,  $\mathbf{Z}_C = 2 + j \Omega$ , and  $\mathbf{Z}_D = 4 \angle 45^\circ \Omega$ .

### 11.5 Complex Power

40. Compute the complex power  $\mathbf{S}$  (in polar form) drawn by a certain load if it is known that (a) it draws 100 W average power at a lagging PF of 0.75; (b) it draws a current  $\mathbf{I} = 9 + j5$  A rms when connected to the voltage  $120 \angle 32^\circ$  V rms; (c) it draws 1000 W average power and 10 VAR reactive power at a leading PF; (d) it draws an apparent power of 450 W at a lagging PF of 0.65.
41. Calculate the apparent power, power factor, and reactive power associated with a load if it draws complex power  $\mathbf{S}$  equal to (a)  $1 + j0.5$  kVA; (b) 400 VA; (c)  $150 \angle -21^\circ$  VA; (d)  $75 \angle 25^\circ$  VA.
42. For each power triangle depicted in Fig. 11.42, determine  $\mathbf{S}$  (in polar form) and the PF.

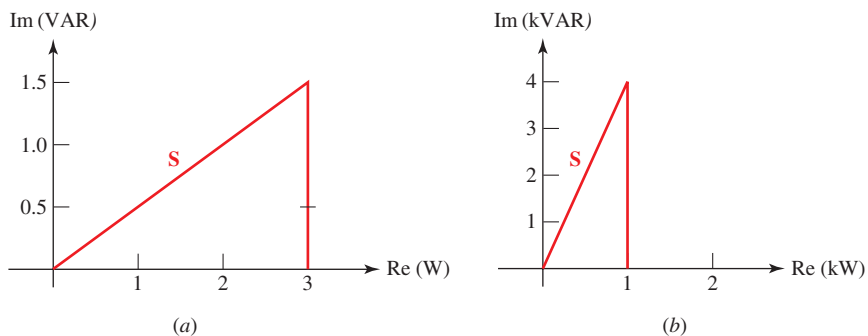

■ FIGURE 11.42

43. Referring to the network represented in Fig. 11.21, if the motor draws complex power  $150 \angle 24^\circ$  VA, (a) determine the PF at which the source is operating; (b) determine the impedance of the corrective device required to change the PF of the source to 0.98 lagging. (c) Is it physically possible to obtain a leading PF for the source? *Explain.*
44. Determine the complex power absorbed by each passive component in the circuit of Fig. 11.43, and the power factor at which the source is operating.

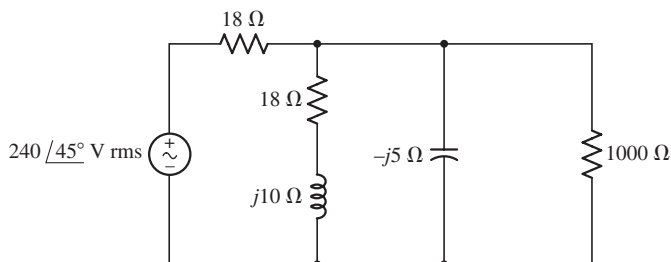

■ FIGURE 11.43



45. What value of capacitance must be added in parallel to the  $10\ \Omega$  resistor of Fig. 11.44 to increase the PF of the source to 0.95 at 50 Hz?

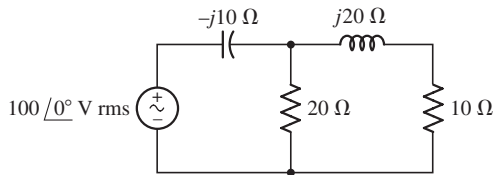

FIGURE 11.44

46. The kiln operation of a local lumberyard has a monthly average power demand of 175 kW, but associated with that is an average monthly reactive power draw of 205 kVAR. If the lumberyard's utility company charges \$0.15 per kVAR for each kVAR above the benchmark value (0.7 times the peak average power demand), (a) estimate the annual cost to the lumberyard from PF penalties; (b) calculate the money saved in the first and second years, respectively, if 100 kVAR compensation capacitors are available for purchase at \$75 each (installed).
47. Calculate the complex power delivered to each passive component of the circuit shown in Fig. 11.45, and determine the power factor of the source.

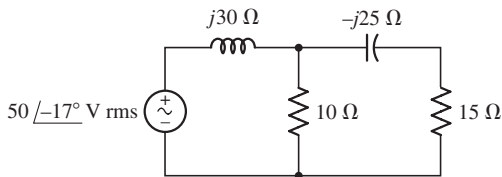

FIGURE 11.45

48. Replace the  $10\ \Omega$  resistor in the circuit of Fig. 11.45 with a 200 mH inductor, assume an operating frequency of 10 rad/s, and calculate (a) the PF of the source; (b) the apparent power supplied by the source; (c) the reactive power delivered by the source.
49. Instead of including a capacitor as indicated in Fig. 11.45, the circuit is erroneously constructed using two identical inductors, each having an impedance of  $j30\ \Omega$  at the operating frequency of 50 Hz. (a) Compute the complex power delivered to each passive component. (b) Verify your solution by calculating the complex power supplied by the source. (c) At what power factor is the source operating?
50. Making use of the general strategy employed in Example 11.9, derive Eq. [28], which enables the corrective value of capacitance to be calculated for a general operating frequency.

### Chapter-Integrating Exercises

51. A load is drawing 10 A rms when connected to a 1200 V rms supply running at 50 Hz. If the source is operating at a lagging PF of 0.9, calculate (a) the peak voltage magnitude; (b) the instantaneous power absorbed by the load at  $t = 1\ \text{ms}$ ; (c) the apparent power supplied by the source; (d) the reactive power supplied to the load; (e) the load impedance; and (f) the complex power supplied by the source (in polar form).
52. For the circuit of Fig. 11.46, assume the source operates at a frequency of 100 rad/s. (a) Determine the PF at which the source is operating. (b) Calculate the apparent power absorbed by each of the three passive elements. (c) Compute the average power supplied by the source. (d) Determine the

Thévenin equivalent seen looking into the terminals marked  $a$  and  $b$ , and calculate the average power delivered to a  $100\ \Omega$  resistor connected between the same terminals.

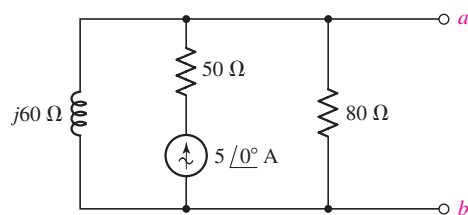

■ FIGURE 11.46

53. Remove the  $50\ \Omega$  resistor in Fig. 11.46, assume an operating frequency of  $50\ \text{Hz}$ , and (a) determine the power factor at which the load is operating; (b) compute the average power delivered by the source; (c) compute the instantaneous power absorbed by the inductance at  $t = 2\ \text{ms}$ ; (d) determine the capacitance that must be connected between the terminals marked  $a$  and  $b$  to increase the PF of the source to  $0.95$ .
54. A source  $45 \sin 32t\ \text{V}$  is connected in series with a  $5\ \Omega$  resistor and a  $20\ \text{mH}$  inductor. Calculate (a) the reactive power delivered by the source; (b) the apparent power absorbed by each of the three elements; (c) the complex power  $\mathbf{S}$  absorbed by each element; (d) the power factor at which the source is operating.
55. For the circuit of Fig. 11.37, (a) derive an expression for the complex power delivered by the source in terms of the unknown resistance  $R$ ; (b) compute the necessary capacitance that must be added in parallel to the  $28\ \text{mH}$  inductor to achieve a unity PF.

# Polyphase Circuits

## INTRODUCTION

The vast majority of power is supplied to consumers in the form of sinusoidal voltages and currents, typically referred to as alternating current or simply *ac*. Although there are exceptions, for example, some types of train motors, most equipment is designed to run on either 50 or 60 Hz. Most 60 Hz systems are now standardized to run on 120 V, whereas 50 Hz systems typically correspond to 240 V (both voltages being quoted in rms units). The actual voltage delivered to an appliance can vary somewhat from these values, and distribution systems employ significantly higher voltages to minimize the current and hence cable size. Originally Thomas Edison advocated a purely dc power distribution network, purportedly due to his preference for the simple algebra required to analyze such circuits. Nikola Tesla and George Westinghouse, two other pioneers in the field of electricity, proposed ac distribution systems as the achievable losses were significantly lower. Ultimately they were more persuasive, despite some rather theatrical demonstrations on the part of Edison.

The transient response of ac power systems is of interest when determining the peak power demand, since most equipment requires more current to start up than it does to run continuously. Often, however, it is the steady-state operation that is of primary interest, so our experience with phasor-based analysis will prove to be handy. In this chapter we introduce a new type of voltage source, the three-phase source, which can be connected in either a three- or four-wire Y configuration or a three-wire  $\Delta$  configuration. Loads can also be either Y- or  $\Delta$ -connected, depending on the application.

## KEY CONCEPTS

- Single-Phase Power Systems
- Three-Phase Power Systems
- Three-Phase Sources
- Line Versus Phase Voltage
- Line Versus Phase Current
- Y-Connected Networks
- $\Delta$ -Connected Networks
- Balanced Loads
- Per-Phase Analysis
- Power Measurement in Three-Phase Systems



## 12.1 POLYPHASE SYSTEMS

So far, whenever we used the term “sinusoidal source” we pictured a single sinusoidal voltage or current having a particular amplitude, frequency, and phase. In this chapter, we introduce the concept of *polyphase* sources, focusing on three-phase systems in particular. There are distinct advantages in using rotating machinery to generate three-phase power rather than single-phase power, and there are economical advantages in favor of the transmission of power in a three-phase system. Although most of the electrical equipment we have encountered so far is single-phase, three-phase equipment is not uncommon, especially in manufacturing environments. In particular, motors used in large refrigeration systems and in machining facilities are often wired for three-phase power. For the remaining applications, once we have become familiar with the basics of polyphase systems, we will find that it is simple to obtain single-phase power by just connecting to a single “leg” of a polyphase system.

Let us look briefly at the most common polyphase system, a balanced three-phase system. The source has three terminals (not counting a *neutral* or *ground* connection), and voltmeter measurements will show that sinusoidal voltages of equal amplitude are present between any two terminals. However, these voltages are not in phase; each of the three voltages is  $120^\circ$  out of phase with each of the other two, the sign of the phase angle depending on the sense of the voltages. One possible set of voltages is shown in Fig. 12.1. A *balanced load* draws power equally from all three phases. *At no instant does the instantaneous power drawn by the total load reach zero; in fact, the total instantaneous power is constant.* This is an advantage in rotating machinery, for it keeps the torque on the rotor much more constant than it would be if a single-phase source were used. As a result, there is less vibration.

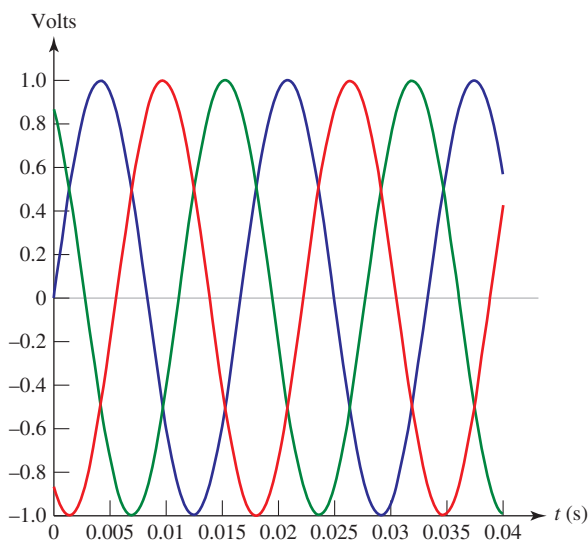

■ FIGURE 12.1 An example set of three voltages, each of which is  $120^\circ$  out of phase with the other two. As can be seen, only one of the voltages is zero at any particular instant.

The use of a higher number of phases, such as 6- and 12-phase systems, is limited almost entirely to the supply of power to large *rectifiers*. Rectifiers convert alternating current to direct current by only allowing current to flow to the load in one direction, so that the sign of the voltage across the load remains the same. The rectifier output is a direct current plus a smaller pulsating component, or ripple, which decreases as the number of phases increases.

Almost without exception, polyphase systems in practice contain sources which may be closely approximated by ideal voltage sources or by ideal voltage sources in series with small internal impedances. Three-phase current sources are extremely rare.

## Double-Subscript Notation

It is convenient to describe polyphase voltages and currents using *double-subscript notation*. With this notation, a voltage or current, such as  $V_{ab}$  or  $I_{aA}$ , has more meaning than if it were indicated simply as  $V_3$  or  $I_x$ . By definition, the voltage of point  $a$  with respect to point  $b$  is  $V_{ab}$ . Thus, the plus sign is located at  $a$ , as indicated in Fig. 12.2a. We therefore consider the double subscripts to be *equivalent* to a plus-minus sign pair; the use of both would be redundant. With reference to Fig. 12.2b, for example, we see that  $V_{ad} = V_{ab} + V_{cd}$ . The advantage of the double-subscript notation lies in the fact that Kirchhoff's voltage law requires the voltage between two points to be the same, regardless of the path chosen between the points; thus  $V_{ad} = V_{ab} + V_{bd} = V_{ac} + V_{cd} = V_{ab} + V_{bc} + V_{cd}$ , and so forth. The benefit of this is that KVL may be satisfied without reference to the circuit diagram; correct equations may be written even though a point, or subscript letter, is included which is not marked on the diagram. For example, we might have written  $V_{ad} = V_{ax} + V_{xd}$ , where  $x$  identifies the location of any interesting point of our choice.

One possible representation of a three-phase system of voltages<sup>1</sup> is shown in Fig. 12.3. Let us assume that the voltages  $V_{an}$ ,  $V_{bn}$ , and  $V_{cn}$  are known:

$$\begin{aligned} V_{an} &= 100\angle 0^\circ \text{ V} \\ V_{bn} &= 100\angle -120^\circ \text{ V} \\ V_{cn} &= 100\angle -240^\circ \text{ V} \end{aligned}$$

The voltage  $V_{ab}$  may be found, with an eye on the subscripts, as

$$\begin{aligned} V_{ab} &= V_{an} + V_{nb} = V_{an} - V_{bn} \\ &= 100\angle 0^\circ - 100\angle -120^\circ \text{ V} \\ &= 100 - (-50 - j86.6) \text{ V} \\ &= 173.2\angle 30^\circ \text{ V} \end{aligned}$$

The three given voltages and the construction of the phasor  $V_{ab}$  are shown on the phasor diagram of Fig. 12.4.

A double-subscript notation may also be applied to currents. We define the current  $I_{ab}$  as the current flowing from  $a$  to  $b$  by the most direct path. In

(1) In keeping with power industry convention, rms values for currents and voltages will be used implicitly throughout this chapter.

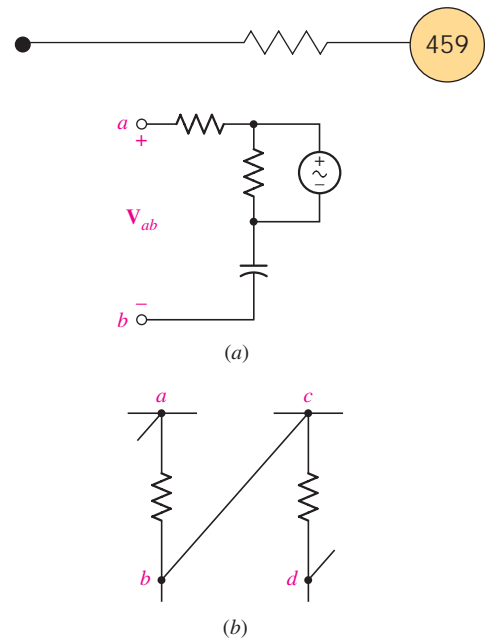

FIGURE 12.2 (a) The definition of the voltage  $V_{ab}$ . (b)  $V_{ad} = V_{ab} + V_{bc} + V_{cd} = V_{ab} + V_{cd}$ .

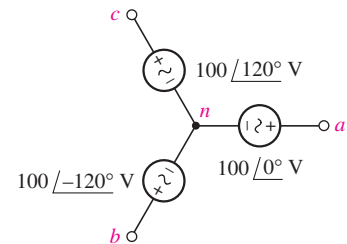

FIGURE 12.3 A network used as a numerical example of double-subscript voltage notation.

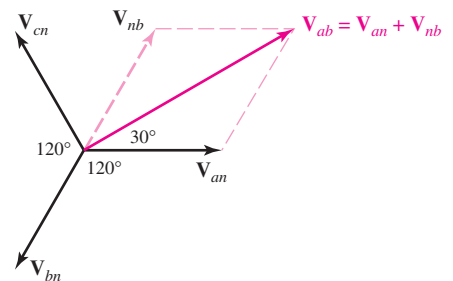

FIGURE 12.4 This phasor diagram illustrates the graphical use of the double-subscript voltage convention to obtain  $V_{ab}$  for the network of Fig. 12.3.

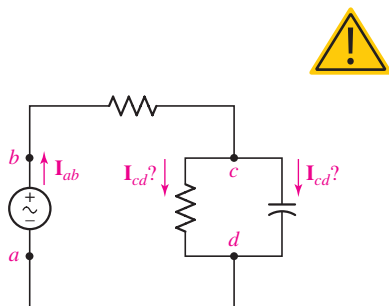

FIGURE 12.5 An illustration of the use and misuse of the double-subscript convention for current notation.

every complete circuit we consider, there must of course be at least two possible paths between the points  $a$  and  $b$ , and we agree that we will not use double-subscript notation unless it is obvious that one path is much shorter, or much more direct. Usually this path is through a single element. Thus, the current  $\mathbf{I}_{ab}$  is correctly indicated in Fig. 12.5. In fact, we do not even need the direction arrow when talking about this current; the subscripts *tell* us the direction. However, the identification of a current as  $\mathbf{I}_{cd}$  for the circuit of Fig. 12.5 would cause confusion.

## PRACTICE

12.1 Let  $\mathbf{V}_{ab} = 100/0^\circ$  V,  $\mathbf{V}_{bd} = 40/80^\circ$  V, and  $\mathbf{V}_{ca} = 70/200^\circ$  V. Find (a)  $\mathbf{V}_{ad}$ ; (b)  $\mathbf{V}_{bc}$ ; (c)  $\mathbf{V}_{cd}$ .

12.2 Refer to the circuit of Fig. 12.6 and let  $\mathbf{I}_{fj} = 3$  A,  $\mathbf{I}_{de} = 2$  A, and  $\mathbf{I}_{hd} = -6$  A. Find (a)  $\mathbf{I}_{cd}$ ; (b)  $\mathbf{I}_{ef}$ ; (c)  $\mathbf{I}_{ij}$ .

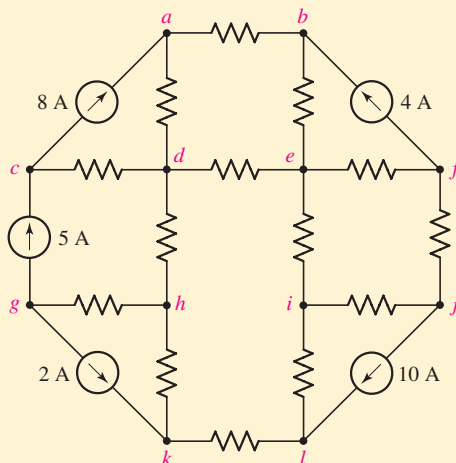

FIGURE 12.6

Ans: 12.1:  $114.0/20.2^\circ$  V;  $41.8/145.0^\circ$  V;  $44.0/20.6^\circ$  V. 12.2:  $-3$  A;  $7$  A;  $7$  A.

## 12.2 SINGLE-PHASE THREE-WIRE SYSTEMS

Before studying polyphase systems in detail, it can be helpful first to look at a simple single-phase three-wire system. A *single-phase three-wire source* is defined as a source having three output terminals, such as  $a$ ,  $n$ , and  $b$  in Fig. 12.7a, at which the phasor voltages  $\mathbf{V}_{an}$  and  $\mathbf{V}_{nb}$  are equal. The source may therefore be represented by the combination of two identical voltage sources; in Fig. 12.7b,  $\mathbf{V}_{an} = \mathbf{V}_{nb} = \mathbf{V}_1$ . It is apparent that  $\mathbf{V}_{ab} = 2\mathbf{V}_{an} = 2\mathbf{V}_{nb}$ , and we therefore have a source to which loads operating at either of two voltages may be connected. The normal North American household system is single-phase three-wire, permitting the operation of both 110 V and 220 V appliances. The higher-voltage appliances are normally those drawing larger amounts of power; operation at higher voltage results in a smaller current draw for the same power. Smaller-diameter wire may consequently be used safely in the appliance, the household distribution

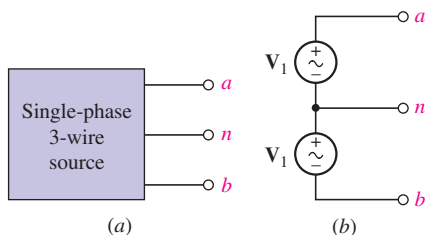

FIGURE 12.7 (a) A single-phase three-wire source. (b) The representation of a single-phase three-wire source by two identical voltage sources.

system, and the distribution system of the utility company, as larger-diameter wire must be used with higher currents to reduce the heat produced due to the resistance of the wire.

The name *single-phase* arises because the voltages  $\mathbf{V}_{an}$  and  $\mathbf{V}_{nb}$ , being equal, must have the same phase angle. From another viewpoint, however, the voltages between the outer wires and the central wire, which is usually referred to as the *neutral*, are exactly  $180^\circ$  out of phase. That is,  $\mathbf{V}_{an} = -\mathbf{V}_{bn}$ , and  $\mathbf{V}_{an} + \mathbf{V}_{bn} = 0$ . Later, we will see that balanced polyphase systems are characterized by a set of voltages of equal *amplitude* whose (phasor) sum is zero. From this viewpoint, then, the single-phase three-wire system is really a balanced two-phase system. *Two-phase*, however, is a term that is traditionally reserved for a relatively unimportant unbalanced system utilizing two voltage sources  $90^\circ$  out of phase.

Let us now consider a single-phase three-wire system that contains identical loads  $\mathbf{Z}_p$  between each outer wire and the neutral (Fig. 12.8). We first assume that the wires connecting the source to the load are perfect conductors. Since

$$\mathbf{V}_{an} = \mathbf{V}_{nb}$$

then,

$$\mathbf{I}_{aA} = \frac{\mathbf{V}_{an}}{\mathbf{Z}_p} = \mathbf{I}_{Bb} = \frac{\mathbf{V}_{nb}}{\mathbf{Z}_p}$$

and therefore

$$\mathbf{I}_{nN} = \mathbf{I}_{Bb} + \mathbf{I}_{Aa} = \mathbf{I}_{Bb} - \mathbf{I}_{aA} = 0$$

Thus there is no current in the neutral wire, and it could be removed without changing any current or voltage in the system. This result is achieved through the equality of the two loads and of the two sources.

## Effect of Finite Wire Impedance

We next consider the effect of a finite impedance in each of the wires. If lines  $aA$  and  $bB$  each have the same impedance, this impedance may be added to  $\mathbf{Z}_p$ , resulting in two equal loads once more, and zero neutral current. Now let us allow the neutral wire to possess some impedance  $\mathbf{Z}_n$ . Without carrying out any detailed analysis, superposition should show us that the symmetry of the circuit will still cause zero neutral current. Moreover, the addition of any impedance connected directly from one of the outer lines to the other outer line also yields a symmetrical circuit and zero neutral current. Thus, zero neutral current is a consequence of a balanced, or symmetrical, load; nonzero impedance in the neutral wire does not destroy the symmetry.

The most general single-phase three-wire system will contain unequal loads between each outside line and the neutral and another load directly between the two outer lines; the impedances of the two outer lines may be expected to be approximately equal, but the neutral impedance is often slightly larger. Let us consider an example of such a system, with particular interest in the current that may flow now through the neutral wire, as well as the overall efficiency with which our system is transmitting power to the unbalanced load.

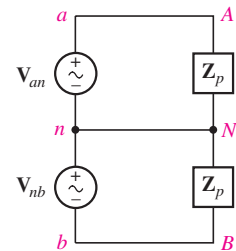

FIGURE 12.8 A simple single-phase three-wire system. The two loads are identical, and the neutral current is zero.



## EXAMPLE 12.1

Analyze the system shown in Fig. 12.9 and determine the power delivered to each of the three loads as well as the power lost in the neutral wire and each of the two lines.

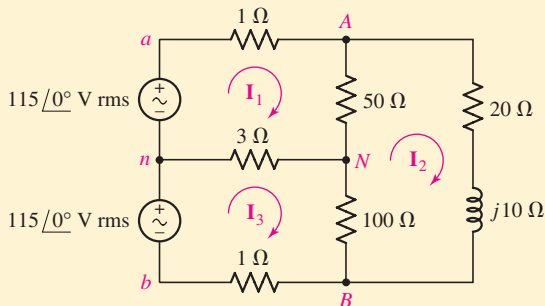

FIGURE 12.9 A typical single-phase three-wire system.

► **Identify the goal of the problem.**

The three loads in the circuit are the  $50\ \Omega$  resistor, the  $100\ \Omega$  resistor, and a  $20 + j10\ \Omega$  impedance. Each of the two lines has a resistance of  $1\ \Omega$ , and the neutral wire has a resistance of  $3\ \Omega$ . We need the current through each of these in order to determine power.

► **Collect the known information.**

We have a single-phase three-wire system; the circuit diagram of Fig. 12.9 is completely labeled. The computed currents will be in rms units.

► **Devise a plan.**

The circuit is conducive to mesh analysis, having three clearly defined meshes. The result of the analysis will be a set of mesh currents, which can then be used to compute absorbed power.

► **Construct an appropriate set of equations.**

The three mesh equations are:

$$\begin{aligned} -115\angle 0^\circ + \mathbf{I}_1 + 50(\mathbf{I}_1 - \mathbf{I}_2) + 3(\mathbf{I}_1 - \mathbf{I}_3) &= 0 \\ (20 + j10)\mathbf{I}_2 + 100(\mathbf{I}_2 - \mathbf{I}_3) + 50(\mathbf{I}_2 - \mathbf{I}_1) &= 0 \\ -115\angle 0^\circ + 3(\mathbf{I}_3 - \mathbf{I}_1) + 100(\mathbf{I}_3 - \mathbf{I}_2) + \mathbf{I}_3 &= 0 \end{aligned}$$

which can be rearranged to obtain the following three equations

$$\begin{aligned} 54\mathbf{I}_1 \quad \quad \quad -50\mathbf{I}_2 \quad \quad -3\mathbf{I}_3 &= 115\angle 0^\circ \\ -50\mathbf{I}_1 \quad + (170 + j10)\mathbf{I}_2 \quad -100\mathbf{I}_3 &= 0 \\ -3\mathbf{I}_1 \quad \quad \quad -100\mathbf{I}_2 \quad + 104\mathbf{I}_3 &= 115\angle 0^\circ \end{aligned}$$

► **Determine if additional information is required.**

We have a set of three equations in three unknowns, so it is possible to attempt a solution at this point.



► **Attempt a solution.**

Solving for the phasor currents  $\mathbf{I}_1$ ,  $\mathbf{I}_2$ , and  $\mathbf{I}_3$  using a scientific calculator, we find

$$\mathbf{I}_1 = 11.24 / \underline{-19.83^\circ} \text{ A}$$

$$\mathbf{I}_2 = 9.389 / \underline{-24.47^\circ} \text{ A}$$

$$\mathbf{I}_3 = 10.37 / \underline{-21.80^\circ} \text{ A}$$

The currents in the outer lines are thus

$$\mathbf{I}_{aA} = \mathbf{I}_1 = 11.24 / \underline{-19.83^\circ} \text{ A}$$

and

$$\mathbf{I}_{bB} = -\mathbf{I}_3 = 10.37 / \underline{158.20^\circ} \text{ A}$$

and the smaller neutral current is

$$\mathbf{I}_{nN} = \mathbf{I}_3 - \mathbf{I}_1 = 0.9459 / \underline{-177.7^\circ} \text{ A}$$

The average power drawn by each load may thus be determined:

$$P_{50} = |\mathbf{I}_1 - \mathbf{I}_2|^2 (50) = 206 \text{ W}$$

$$P_{100} = |\mathbf{I}_3 - \mathbf{I}_2|^2 (100) = 117 \text{ W}$$

$$P_{20+j10} = |\mathbf{I}_2|^2 (20) = 1763 \text{ W}$$

The total load power is 2086 W. The loss in each of the wires is next found:

$$P_{aA} = |\mathbf{I}_1|^2 (1) = 126 \text{ W}$$

$$P_{bB} = |\mathbf{I}_3|^2 (1) = 108 \text{ W}$$

$$P_{nN} = |\mathbf{I}_{nN}|^2 (3) = 3 \text{ W}$$

giving a total line loss of 237 W. The wires are evidently quite long; otherwise, the relatively high power loss in the two outer lines would cause a dangerous temperature rise.

► **Verify the solution. Is it reasonable or expected?**

The total absorbed power is  $206 + 117 + 1763 + 237$ , or 2323 W, which may be checked by finding the power delivered by each voltage source:

$$P_{an} = 115(11.24) \cos 19.83^\circ = 1216 \text{ W}$$

$$P_{bn} = 115(10.37) \cos 21.80^\circ = 1107 \text{ W}$$

or a total of 2323 W. The **transmission efficiency** for the system is

$$\eta = \frac{\text{total power delivered to load}}{\text{total power generated}} = \frac{2086}{2086 + 237} = 89.8\%$$

This value would be unbelievable for a steam engine or an internal combustion engine, but it is too low for a well-designed distribution system. Larger-diameter wires should be used if the source and the load cannot be placed closer to each other.

Note that we do not need to include a factor of  $\frac{1}{2}$  since we are working with rms current values.

Imagine the heat produced by two 100 W light bulbs! These outer wires must dissipate the same amount of power. In order to keep their temperature down, a large surface area is required.

(Continued on next page)

A phasor diagram showing the two source voltages, the currents in the outer lines, and the current in the neutral is constructed in Fig. 12.10. The fact that  $\mathbf{I}_{aA} + \mathbf{I}_{bB} + \mathbf{I}_{nN} = 0$  is indicated on the diagram.

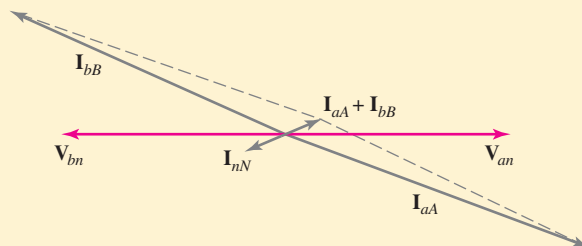

■ FIGURE 12.10 The source voltages and three of the currents in the circuit of Fig. 12.9 are shown on a phasor diagram. Note that  $\mathbf{I}_{aA} + \mathbf{I}_{bB} + \mathbf{I}_{nN} = 0$ .

### PRACTICE

12.3 Modify Fig. 12.9 by adding a  $1.5\ \Omega$  resistance to each of the two outer lines, and a  $2.5\ \Omega$  resistance to the neutral wire. Find the average power delivered to each of the three loads.

Ans: 153.1 W; 95.8 W; 1374 W.

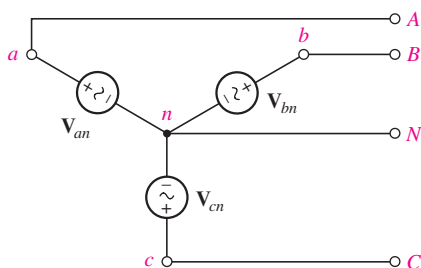

■ FIGURE 12.11 A Y-connected three-phase four-wire source.

## 12.3 THREE-PHASE Y-Y CONNECTION

Three-phase sources have three terminals, called the *line* terminals, and they may or may not have a fourth terminal, the *neutral* connection. We will begin by discussing a three-phase source that does have a neutral connection. It may be represented by three ideal voltage sources connected in a Y, as shown in Fig. 12.11; terminals  $a$ ,  $b$ ,  $c$ , and  $n$  are available. We will consider only balanced three-phase sources, which may be defined as having

$$|\mathbf{V}_{an}| = |\mathbf{V}_{bn}| = |\mathbf{V}_{cn}|$$

and

$$\mathbf{V}_{an} + \mathbf{V}_{bn} + \mathbf{V}_{cn} = 0$$

These three voltages, each existing between one line and the neutral, are called **phase voltages**. If we arbitrarily choose  $\mathbf{V}_{an}$  as the reference, or define

$$\mathbf{V}_{an} = V_p \angle 0^\circ$$

where we will consistently use  $V_p$  to represent the rms *amplitude* of any of the phase voltages, then the definition of the three-phase source indicates that either

$$\mathbf{V}_{bn} = V_p \angle -120^\circ \quad \text{and} \quad \mathbf{V}_{cn} = V_p \angle -240^\circ$$

or

$$\mathbf{V}_{bn} = V_p \angle 120^\circ \quad \text{and} \quad \mathbf{V}_{cn} = V_p \angle 240^\circ$$

The former is called **positive phase sequence**, or **abc phase sequence**, and is shown in Fig. 12.12a; the latter is termed **negative phase sequence**, or **cba phase sequence**, and is indicated by the phasor diagram of Fig. 12.12b.

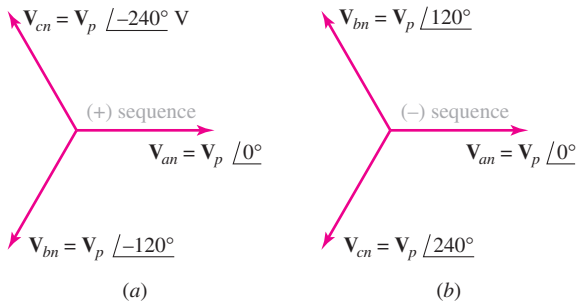

■ FIGURE 12.12 (a) Positive, or *abc*, phase sequence. (b) Negative, or *cba*, phase sequence.

The actual phase sequence of a physical three-phase source depends on the arbitrary choice of the three terminals to be lettered *a*, *b*, and *c*. They may always be chosen to provide positive phase sequence, and we will assume that this has been done in most of the systems we consider.

## Line-to-Line Voltages

Let us next find the line-to-line voltages (often simply called the *line voltages*) which are present when the phase voltages are those of Fig. 12.12a. It is easiest to do this with the help of a phasor diagram, since the angles are all multiples of  $30^\circ$ . The necessary construction is shown in Fig. 12.13; the results are

$$\mathbf{V}_{ab} = \sqrt{3}V_p / 30^\circ \quad [1]$$

$$\mathbf{V}_{bc} = \sqrt{3}V_p / -90^\circ \quad [2]$$

$$\mathbf{V}_{ca} = \sqrt{3}V_p / -210^\circ \quad [3]$$

Kirchhoff's voltage law requires the sum of these three voltages to be zero; the reader is encouraged to verify this as an exercise.

If the rms amplitude of any of the line voltages is denoted by  $V_L$ , then one of the important characteristics of the Y-connected three-phase source may be expressed as

$$V_L = \sqrt{3}V_p$$

Note that with positive phase sequence,  $\mathbf{V}_{an}$  leads  $\mathbf{V}_{bn}$  and  $\mathbf{V}_{bn}$  leads  $\mathbf{V}_{cn}$ , in each case by  $120^\circ$ , and also that  $\mathbf{V}_{ab}$  leads  $\mathbf{V}_{bc}$  and  $\mathbf{V}_{bc}$  leads  $\mathbf{V}_{ca}$ , again by  $120^\circ$ . The statement is true for negative phase sequence if “lags” is substituted for “leads.”

Now let us connect a balanced Y-connected three-phase load to our source, using three lines and a neutral, as drawn in Fig. 12.14. The load is

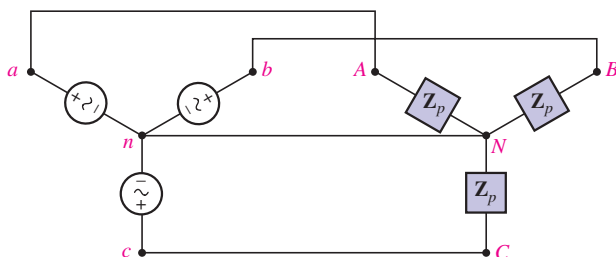

■ FIGURE 12.14 A balanced three-phase system, connected Y-Y and including a neutral.

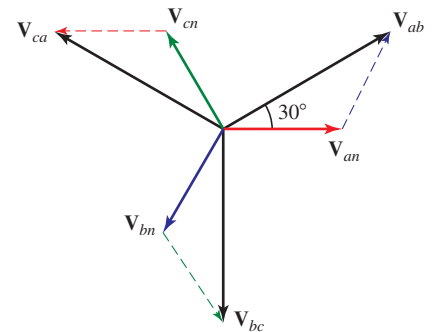
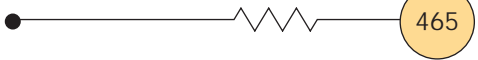

■ FIGURE 12.13 A phasor diagram which is used to determine the line voltages from the given phase voltages. Or, algebraically,  $\mathbf{V}_{ab} = \mathbf{V}_{an} - \mathbf{V}_{bn} = V_p / 0^\circ - V_p / -120^\circ = V_p - V_p \cos(-120^\circ) - jV_p \sin(-120^\circ) = V_p(1 + \frac{1}{2} + j\sqrt{3}/2) = \sqrt{3}V_p / 30^\circ$ .

represented by an impedance  $Z_p$  between each line and the neutral. The three line currents are found very easily, since we really have three single-phase circuits that possess one common lead:<sup>2</sup>

$$\begin{aligned} \mathbf{I}_{aA} &= \frac{\mathbf{V}_{an}}{\mathbf{Z}_p} \\ \mathbf{I}_{bB} &= \frac{\mathbf{V}_{bn}}{\mathbf{Z}_p} = \frac{\mathbf{V}_{an} \angle -120^\circ}{\mathbf{Z}_p} = \mathbf{I}_{aA} \angle -120^\circ \\ \mathbf{I}_{cC} &= \mathbf{I}_{aA} \angle -240^\circ \end{aligned}$$

and therefore

$$\mathbf{I}_{Nn} = \mathbf{I}_{aA} + \mathbf{I}_{bB} + \mathbf{I}_{cC} = 0$$

Thus, the neutral carries no current if the source and load are both balanced and if the four wires have zero impedance. How will this change if an impedance  $Z_L$  is inserted in series with each of the three lines and an impedance  $Z_n$  is inserted in the neutral? The line impedances may be combined with the three load impedances; this effective load is still balanced, and a perfectly conducting neutral wire could be removed. Thus, if no change is produced in the system with a short circuit or an open circuit between  $n$  and  $N$ , any impedance may be inserted in the neutral and the neutral current will remain zero.

It follows that, if we have balanced sources, balanced loads, and balanced line impedances, a neutral wire of any impedance may be replaced by any other impedance, including a short circuit or an open circuit; the replacement will not affect the system's voltages or currents. It is often helpful to *visualize* a short circuit between the two neutral points, whether a neutral wire is actually present or not; the problem is then reduced to three single-phase problems, all identical except for the consistent difference in phase angle. We say that we thus work the problem on a “per-phase” basis.



## EXAMPLE 12.2

For the circuit of Fig. 12.15, find both the phase and line currents, and the phase and line voltages throughout the circuit; then calculate the total power dissipated in the load.

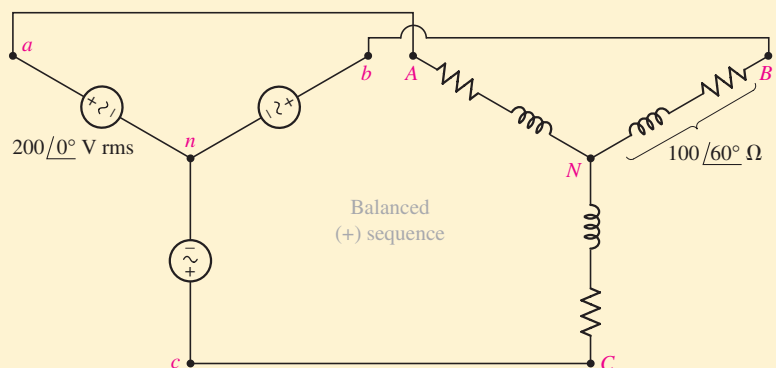

FIGURE 12.15 A balanced three-phase three-wire Y-Y connected system.

(2) This can be seen to be true by applying superposition and looking at each phase one at a time.

Since one of the source phase voltages is given and we are told to use the positive phase sequence, the three phase voltages are:

$$\mathbf{V}_{an} = 200\angle 0^\circ \text{ V} \quad \mathbf{V}_{bn} = 200\angle -120^\circ \text{ V} \quad \mathbf{V}_{cn} = 200\angle -240^\circ \text{ V}$$

The line voltage is  $200\sqrt{3} = 346 \text{ V}$ ; the phase angle of each line voltage can be determined by constructing a phasor diagram, as we did in Fig. 12.13 (as a matter of fact, the phasor diagram of Fig. 12.13 is applicable), subtracting the phase voltages using a scientific calculator, or by invoking Eqs. [1] to [3]. We find that  $\mathbf{V}_{ab}$  is  $346\angle 30^\circ \text{ V}$ ,  $\mathbf{V}_{bc} = 346\angle -90^\circ \text{ V}$ , and  $\mathbf{V}_{ca} = 346\angle -210^\circ \text{ V}$ .

The line current for phase A is

$$\mathbf{I}_{aA} = \frac{\mathbf{V}_{an}}{\mathbf{Z}_p} = \frac{200\angle 0^\circ}{100\angle 60^\circ} = 2\angle -60^\circ \text{ A}$$

Since we know this is a balanced three-phase system, we may write the remaining line currents based on  $\mathbf{I}_{aA}$ :

$$\mathbf{I}_{bB} = 2\angle (-60^\circ - 120^\circ) = 2\angle -180^\circ \text{ A}$$

$$\mathbf{I}_{cC} = 2\angle (-60^\circ - 240^\circ) = 2\angle -300^\circ \text{ A}$$

Finally, the average power absorbed by phase A is  $\text{Re}\{\mathbf{V}_{an}\mathbf{I}_{aA}^*\}$ , or

$$P_{AN} = 200(2) \cos(0^\circ + 60^\circ) = 200 \text{ W}$$

Thus, the total average power drawn by the three-phase load is 600 W.

The phasor diagram for this circuit is shown in Fig. 12.16. Once we knew any of the line voltage magnitudes and any of the line current magnitudes, the angles for all three voltages and all three currents could have been obtained by simply reading the diagram.

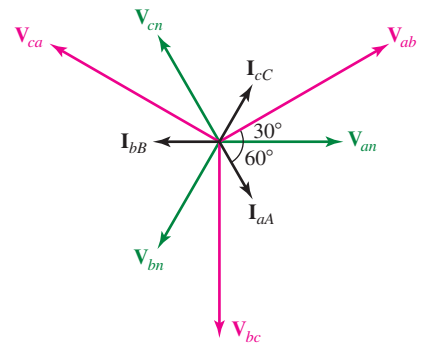

FIGURE 12.16 The phasor diagram that applies to the circuit of Fig. 12.15.

## PRACTICE

12.4 A balanced three-phase three-wire system has a Y-connected load. Each phase contains three loads in parallel:  $-j100 \Omega$ ,  $100 \Omega$ , and  $50 + j50 \Omega$ . Assume positive phase sequence with  $\mathbf{V}_{ab} = 400\angle 0^\circ \text{ V}$ . Find (a)  $\mathbf{V}_{an}$ ; (b)  $\mathbf{I}_{aA}$ ; (c) the total power drawn by the load.

Ans:  $231\angle -30^\circ \text{ V}$ ;  $4.62\angle -30^\circ \text{ A}$ ; 3200 W.

Before working another example, this would be a good opportunity to quickly explore a statement made in Sec. 12.1, i.e., that even though phase voltages and currents have zero value at specific instants in time (every  $1/120 \text{ s}$  in North America), the instantaneous power delivered to the *total* load is never zero. Consider phase A of Example 12.2 once more, with the phase voltage and current written in the time domain:

$$v_{AN} = 200\sqrt{2} \cos(120\pi t + 0^\circ) \text{ V}$$

and

$$i_{AN} = 2\sqrt{2} \cos(120\pi t - 60^\circ) \text{ A}$$

The factor of  $\sqrt{2}$  is required to convert from rms units.

Thus, the instantaneous power absorbed by phase A is

$$\begin{aligned} p_A(t) &= v_{AN}i_{AN} = 800 \cos(120\pi t) \cos(120\pi t - 60^\circ) \\ &= 400[\cos(-60^\circ) + \cos(240\pi t - 60^\circ)] \\ &= 200 + 400 \cos(240\pi t - 60^\circ) \text{ W} \end{aligned}$$

in a similar fashion,

$$p_B(t) = 200 + 400 \cos(240\pi t - 300^\circ) \text{ W}$$

and

$$p_C(t) = 200 + 400 \cos(240\pi t - 180^\circ) \text{ W}$$

The instantaneous power absorbed by the *total* load is therefore

$$p(t) = p_A(t) + p_B(t) + p_C(t) = 600 \text{ W}$$

independent of time, and the same value as the average power computed in Example 12.2.

### EXAMPLE 12.3

**A balanced three-phase system with a line voltage of 300 V is supplying a balanced Y-connected load with 1200 W at a leading PF of 0.8. Find the line current and the per-phase load impedance.**

The phase voltage is  $300/\sqrt{3}$  V and the per-phase power is  $1200/3 = 400$  W. Thus the line current may be found from the power relationship

$$400 = \frac{300}{\sqrt{3}}(I_L)(0.8)$$

and the line current is therefore 2.89 A. The phase impedance magnitude is given by

$$|Z_p| = \frac{V_p}{I_L} = \frac{300/\sqrt{3}}{2.89} = 60 \Omega$$

Since the PF is 0.8 leading, the impedance phase angle is  $-36.9^\circ$ ; thus  $Z_p = 60/\underline{-36.9^\circ} \Omega$ .

### PRACTICE

12.5 A balanced three-phase three-wire system has a line voltage of 500 V. Two balanced Y-connected loads are present. One is a capacitive load with  $7 - j2 \Omega$  per phase, and the other is an inductive load with  $4 + j2 \Omega$  per phase. Find (a) the phase voltage; (b) the line current; (c) the total power drawn by the load; (d) the power factor at which the source is operating.

Ans: 289 V; 97.5 A; 83.0 kW; 0.983 lagging.

## EXAMPLE 12.4

A balanced 600 W lighting load is added (in parallel) to the system of Example 12.3. Determine the new line current.

We first sketch a suitable per-phase circuit, as shown in Fig. 12.17. The 600 W load is assumed to be a balanced load evenly distributed among the three phases, resulting in an additional 200 W consumed by each phase.

The amplitude of the lighting current (labeled  $\mathbf{I}_1$ ) is determined by

$$200 = \frac{300}{\sqrt{3}} |\mathbf{I}_1| \cos 0^\circ$$

so that

$$|\mathbf{I}_1| = 1.155 \text{ A}$$

In a similar way, the amplitude of the capacitive load current (labeled  $\mathbf{I}_2$ ) is found to be unchanged from its previous value, since the voltage across it has remained the same:

$$|\mathbf{I}_2| = 2.89 \text{ A}$$

If we assume that the phase with which we are working has a phase voltage with an angle of  $0^\circ$ , then since  $\cos^{-1}(0.8) = 36.9^\circ$ ,

$$\mathbf{I}_1 = 1.155 \angle 0^\circ \text{ A} \quad \mathbf{I}_2 = 2.89 \angle +36.9^\circ \text{ A}$$

and the line current is

$$\mathbf{I}_L = \mathbf{I}_1 + \mathbf{I}_2 = 3.87 \angle +26.6^\circ \text{ A}$$

We can check our results by computing the power generated by this phase of the source

$$P_p = \frac{300}{\sqrt{3}} 3.87 \cos(+26.6^\circ) = 600 \text{ W}$$

which agrees with the fact that the individual phase is known to be supplying 200 W to the new lighting load, as well as 400 W to the original load.

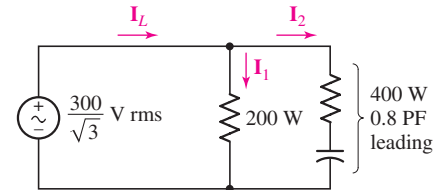

FIGURE 12.17 The per-phase circuit that is used to analyze a *balanced* three-phase example.

## PRACTICE

12.6 Three balanced Y-connected loads are installed on a balanced three-phase four-wire system. Load 1 draws a total power of 6 kW at unity PF, load 2 pulls 10 kVA at PF = 0.96 lagging, and load 3 demands 7 kW at 0.85 lagging. If the phase voltage at the loads is 135 V, if each line has a resistance of  $0.1 \Omega$ , and if the neutral has a resistance of  $1 \Omega$ , find (a) the total power drawn by the loads; (b) the combined PF of the loads; (c) the total power lost in the four lines; (d) the phase voltage at the source; (e) the power factor at which the source is operating.

Ans: 22.6 kW; 0.954 lag; 1027 W; 140.6 V; 0.957 lagging.



If an *unbalanced* Y-connected load is present in an otherwise balanced three-phase system, the circuit may still be analyzed on a per-phase basis *if* the neutral wire is present and *if* it has zero impedance. If either of these conditions is not met, other methods must be used, such as mesh or nodal analysis. However, engineers who spend most of their time with unbalanced three-phase systems will find the use of *symmetrical components* a great time saver.

We leave this topic for more advanced texts.

## 12.4 THE DELTA ( $\Delta$ ) CONNECTION

An alternative to the Y-connected load is the  $\Delta$ -connected configuration, as shown in Fig. 12.18. This type of configuration is very common, and does not possess a neutral connection.

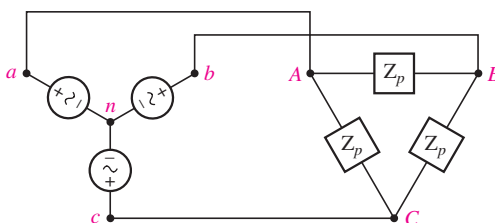

■ FIGURE 12.18 A balanced  $\Delta$ -connected load is present on a three-wire three-phase system. The source happens to be Y-connected.

Let us consider a balanced  $\Delta$ -connected load which consists of an impedance  $Z_p$  inserted between each pair of lines. With reference to Fig. 12.18, let us assume known line voltages

$$V_L = |\mathbf{V}_{ab}| = |\mathbf{V}_{bc}| = |\mathbf{V}_{ca}|$$

or known phase voltages

$$V_p = |\mathbf{V}_{an}| = |\mathbf{V}_{bn}| = |\mathbf{V}_{cn}|$$

where

$$V_L = \sqrt{3}V_p \quad \text{and} \quad \mathbf{V}_{ab} = \sqrt{3}V_p/30^\circ$$

as we found previously. Because the voltage across each branch of the  $\Delta$  is known, the *phase currents* are easily found:

$$\mathbf{I}_{AB} = \frac{\mathbf{V}_{ab}}{\mathbf{Z}_p} \quad \mathbf{I}_{BC} = \frac{\mathbf{V}_{bc}}{\mathbf{Z}_p} \quad \mathbf{I}_{CA} = \frac{\mathbf{V}_{ca}}{\mathbf{Z}_p}$$

and their differences provide us with the line currents, such as

$$\mathbf{I}_{aA} = \mathbf{I}_{AB} - \mathbf{I}_{CA}$$

Since we are working with a balanced system, the three phase currents are of equal amplitude:

$$I_p = |\mathbf{I}_{AB}| = |\mathbf{I}_{BC}| = |\mathbf{I}_{CA}|$$

The line currents are also equal in amplitude; the symmetry is apparent from the phasor diagram of Fig. 12.19. We thus have

$$I_L = |\mathbf{I}_{aA}| = |\mathbf{I}_{bB}| = |\mathbf{I}_{cC}|$$

and

$$I_L = \sqrt{3}I_p$$



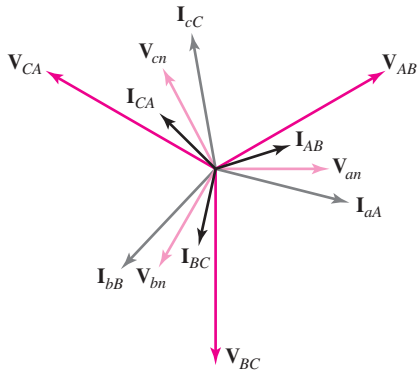

■ FIGURE 12.19 A phasor diagram that could apply to the circuit of Fig. 12.18 if  $Z_p$  were an inductive impedance.

Let us disregard the source for the moment and consider only the balanced load. If the load is  $\Delta$ -connected, then the phase voltage and the line voltage are indistinguishable, but the line current is larger than the phase current by a factor of  $\sqrt{3}$ ; with a Y-connected load, however, the phase current and the line current refer to the same current, and the line voltage is greater than the phase voltage by a factor of  $\sqrt{3}$ .



### EXAMPLE 12.5

**Determine the amplitude of the line current in a three-phase system with a line voltage of 300 V that supplies 1200 W to a  $\Delta$ -connected load at a lagging PF of 0.8; then find the phase impedance.**

Let us again consider a single phase. It draws 400 W, 0.8 lagging PF, at a 300 V line voltage. Thus,

$$400 = 300(I_p)(0.8)$$

and

$$I_p = 1.667 \text{ A}$$

and the relationship between phase currents and line currents yields

$$I_L = \sqrt{3}(1.667) = 2.89 \text{ A}$$

Next, the phase angle of the load is  $\cos^{-1}(0.8) = 36.9^\circ$ , and therefore the impedance in each phase must be

$$Z_p = \frac{300}{1.667} / 36.9^\circ = 180 / 36.9^\circ \Omega$$

Again, keep in mind that we are assuming all voltages and currents are quoted as rms values.

### PRACTICE

12.7 Each phase of a balanced three-phase  $\Delta$ -connected load consists of a 200 mH inductor in series with the parallel combination of a  $5 \mu\text{F}$  capacitor and a  $200 \Omega$  resistance. Assume zero line resistance and a phase voltage of 200 V at  $\omega = 400 \text{ rad/s}$ . Find (a) the phase current; (b) the line current; (c) the total power absorbed by the load.

Ans: 1.158 A; 2.01 A; 693 W.

## EXAMPLE 12.6

**Determine the amplitude of the line current in a three-phase system with a 300 V line voltage that supplies 1200 W to a Y-connected load at a lagging PF of 0.8. (This is the same circuit as in Example 12.5, but with a Y-connected load instead.)**

On a per-phase basis, we now have a phase voltage of  $300/\sqrt{3}$  V, a power of 400 W, and a lagging PF of 0.8. Thus,

$$400 = \frac{300}{\sqrt{3}}(I_p)(0.8)$$

and

$$I_p = 2.89 \quad (\text{and so } I_L = 2.89 \text{ A})$$

The phase angle of the load is again  $36.9^\circ$ , and thus the impedance in each phase of the Y is

$$Z_p = \frac{300/\sqrt{3}}{2.89} / 36.9^\circ = 60/36.9^\circ \Omega$$

The  $\sqrt{3}$  factor not only relates phase and line quantities but also appears in a useful expression for the total power drawn by any balanced three-phase load. If we assume a Y-connected load with a power-factor angle  $\theta$ , the power taken by any phase is

$$P_p = V_p I_p \cos \theta = V_p I_L \cos \theta = \frac{V_L}{\sqrt{3}} I_L \cos \theta$$

and the total power is

$$P = 3P_p = \sqrt{3} V_L I_L \cos \theta$$

In a similar way, the power delivered to each phase of a  $\Delta$ -connected load is

$$P_p = V_p I_p \cos \theta = V_L I_p \cos \theta = V_L \frac{I_L}{\sqrt{3}} \cos \theta$$

giving a total power

$$P = 3P_p = \sqrt{3} V_L I_L \cos \theta \quad [4]$$



Thus Eq. [4] enables us to calculate the total power delivered to a balanced load from a knowledge of the magnitude of the line voltage, of the line current, and of the phase angle of the load impedance (or admittance), regardless of whether the load is Y-connected or  $\Delta$ -connected. The line current in

## PRACTICE

12.8 A balanced three-phase three-wire system is terminated with two  $\Delta$ -connected loads in parallel. Load 1 draws 40 kVA at a lagging PF of 0.8, while load 2 absorbs 24 kW at a leading PF of 0.9. Assume no line resistance, and let  $V_{ab} = 440/30^\circ$  V. Find (a) the total power drawn by the loads; (b) the phase current  $I_{AB1}$  for the lagging load; (c)  $I_{AB2}$ ; (d)  $I_{aA}$ .

Ans: 56.0 kW;  $30.3/-6.87^\circ$  A;  $20.2/55.8^\circ$  A;  $75.3/-12.46^\circ$  A.

Examples 12.5 and 12.6 can now be obtained in two simple steps:

$$1200 = \sqrt{3}(300)(I_L)(0.8)$$

Therefore,

$$I_L = \frac{5}{\sqrt{3}} = 2.89 \text{ A}$$

A brief comparison of phase and line voltages as well as phase and line currents is presented in Table 12.1 for both Y- and  $\Delta$ -connected loads powered by a Y-connected three-phase source.

TABLE 12.1 Comparison of Y- and  $\Delta$ -Connected Three-Phase Loads.  $V_p$  Is the Voltage Magnitude of Each Y-Connected *Source* Phase

Load	Phase Voltage	Line Voltage	Phase Current	Line Current	Power per Phase
Y	$V_{AN} = V_p \angle 0^\circ$ $V_{BN} = V_p \angle -120^\circ$ $V_{CN} = V_p \angle -240^\circ$	$V_{AB} = V_{ab}$ $= (\sqrt{3}/30^\circ)V_{AN}$ $= \sqrt{3}V_p \angle 30^\circ$ $V_{BC} = V_{bc}$ $= (\sqrt{3}/30^\circ)V_{BN}$ $= \sqrt{3}V_p \angle -90^\circ$ $V_{CA} = V_{ca}$ $= (\sqrt{3}/30^\circ)V_{CN}$ $= \sqrt{3}V_p \angle -210^\circ$	$I_{aA} = I_{AN} = \frac{V_{AN}}{Z_p}$ $I_{bB} = I_{BN} = \frac{V_{BN}}{Z_p}$ $I_{cC} = I_{CN} = \frac{V_{CN}}{Z_p}$	$I_{aA} = I_{AN} = \frac{V_{AN}}{Z_p}$ $I_{bB} = I_{BN} = \frac{V_{BN}}{Z_p}$ $I_{cC} = I_{CN} = \frac{V_{CN}}{Z_p}$	$\sqrt{3}V_L I_L \cos \theta$ where $\cos \theta =$ power factor of the load
$\Delta$	$V_{AB} = V_{ab}$ $= \sqrt{3}V_p \angle 30^\circ$ $V_{BC} = V_{bc}$ $= \sqrt{3}V_p \angle -90^\circ$ $V_{CA} = V_{ca}$ $= \sqrt{3}V_p \angle -210^\circ$	$V_{AB} = V_{ab}$ $= \sqrt{3}V_p \angle 30^\circ$ $V_{BC} = V_{bc}$ $= \sqrt{3}V_p \angle -90^\circ$ $V_{CA} = V_{ca}$ $= \sqrt{3}V_p \angle -210^\circ$	$I_{AB} = \frac{V_{AB}}{Z_p}$ $I_{BC} = \frac{V_{BC}}{Z_p}$ $I_{CA} = \frac{V_{CA}}{Z_p}$	$I_{aA} = (\sqrt{3} \angle -30^\circ) \frac{V_{AB}}{Z_p}$ $I_{bB} = (\sqrt{3} \angle -30^\circ) \frac{V_{BC}}{Z_p}$ $I_{cC} = (\sqrt{3} \angle -30^\circ) \frac{V_{CA}}{Z_p}$	$\sqrt{3}V_L I_L \cos \theta$ where $\cos \theta =$ power factor of the load

## $\Delta$ -Connected Sources

The source may also be connected in a  $\Delta$  configuration. This is not typical, however, for a slight unbalance in the source phases can lead to large currents circulating in the  $\Delta$  loop. For example, let us call the three single-phase sources  $V_{ab}$ ,  $V_{bc}$ , and  $V_{cd}$ . Before closing the  $\Delta$  by connecting  $d$  to  $a$ , let us determine the unbalance by measuring the sum  $V_{ab} + V_{bc} + V_{ca}$ . Suppose that the amplitude of the result is only 1 percent of the line voltage. The circulating current is thus approximately  $\frac{1}{3}$  percent of the line voltage divided by the internal impedance of any source. How large is this impedance apt to be? It must depend on the current that the source is expected to deliver with a negligible drop in terminal voltage. If we assume that this maximum current causes a 1 percent drop in the terminal voltage, then *the circulating current is one-third of the maximum current!* This reduces the useful current capacity of the source and also increases the losses in the system.

# PRACTICAL APPLICATION

## Power-Generating Systems

Today, electrical power is generated by a rather wide variety of techniques. For example, direct conversion of solar energy into electricity using photovoltaic (solar cell) technology results in the production of dc power. Despite representing a very environmentally friendly technology, however, photovoltaic-based installations are presently more expensive than other means of producing electricity, and require the use of inverters to convert the dc power into ac. Other technologies such as wind turbine, geothermal, hydrodynamic, nuclear, and fossil fuel-based generators are often more economical by comparison. In these systems, a shaft is rotated through the action of a **prime mover**, such as wind on a propeller, or water or steam on turbine blades (Fig. 12.20).

Once a prime mover has been harnessed to generate rotational movement of a shaft, there are several means of converting this mechanical energy into electrical energy. One example is a **synchronous generator** (Fig. 12.21). These machines are composed of two main sections: a stationary part, called the **stator**, and a rotating part, termed the **rotor**. DC current is supplied to coils of wire wound about the rotor to generate a magnetic field, which is rotated through the action of the prime mover. A set of three-phase voltages is then induced at a second set of windings around the stator. Synchronous

generators get their name from the fact that the frequency of the ac voltage produced is synchronized with the mechanical rotation of the rotor.

The actual demand on a stand-alone generator can vary greatly as various loads are added or removed, such as when air conditioning units kick on, lighting is turned on or off, etc. The voltage output of a generator should ideally be independent of the load, but this is not the case in practice. The voltage  $\mathbf{E}_A$  induced in any given stator phase, often referred to as the **internal generated voltage**, has a magnitude given by

$$E_A = K\phi\omega$$

where  $K$  is a constant dependent on the way the machine is constructed,  $\phi$  is the magnetic flux produced by the field windings on the rotor (and hence is independent of the load), and  $\omega$  is the speed of rotation, which depends only on the prime mover and not the load attached to the generator. Thus, *changing the load does not affect the magnitude of  $\mathbf{E}_A$* . The internal generated voltage can be related to the phase voltage  $\mathbf{V}_\phi$  and the phase current  $\mathbf{I}_A$  by

$$\mathbf{E}_A = \mathbf{V}_\phi + jX_S\mathbf{I}_A$$

where  $X_S$  is the **synchronous reactance** of the generator.



■ FIGURE 12.20 Wind-energy harvesting installation at Altamont Pass, California, which consists of over 7000 individual windmills. (© Digital Vision/PunchStock)



■ FIGURE 12.21 The 24-pole rotor of a synchronous generator as it is being lowered into position.  
(Photo courtesy Dr. Wade Enright, Te Kura Pukaha Vira O Te Whare Wananga O Waitaha, Aotearoa.)

If the load is increased, then a larger current  $I_A$  will be drawn from the generator. If the power factor is not changed (i.e., the angle between  $V_\phi$  and  $I_A$  remains constant),  $V_\phi$  will be reduced since  $E_A$  cannot change.

For example, consider the phasor diagram of Fig. 12.22a, which depicts the voltage-current output of a single phase of a generator connected to a load with a lagging power factor of  $\cos \theta$ . The internal generated voltage  $E_A$  is also shown. If an additional load is added without changing the power factor, as represented in Fig. 12.22b, the supplied current  $I_A$  increases to  $I'_A$ . However, the magnitude of the internal generated voltage, formed by the sum of the phasors  $jX_S I'_A$  and  $V'_\phi$ , must remain unchanged. Thus,  $E'_A = E_A$ , and so the voltage output ( $V'_\phi$ ) of the generator will be slightly reduced, as depicted in Fig. 12.22b.

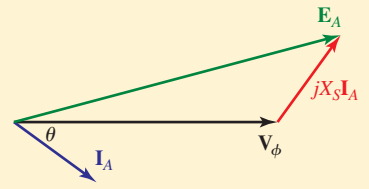

(a)

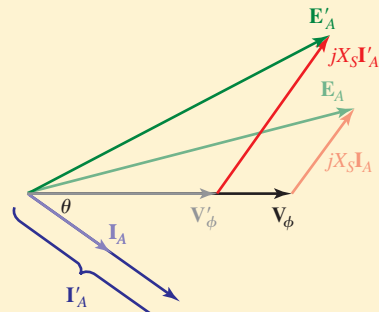

(b)

■ FIGURE 12.22 Phasor diagrams describing the effect of loading on a stand-alone synchronous generator. (a) Generator connected to a load having a lagging power factor of  $\cos \theta$ . (b) An additional load is added without changing the power factor. The magnitude of the internal generated voltage  $E_A$  remains the same while the output current increases. Consequently, the output voltage  $V_\phi$  is reduced.

The **voltage regulation** of a generator is defined as

$$\% \text{ regulation} = \frac{V_{\text{no load}} - V_{\text{full load}}}{V_{\text{full load}}} \times 100$$

Ideally, the regulation should be as close to zero as possible, but this can only be accomplished if the dc current used to control the flux  $\phi$  around the field winding is varied in order to compensate for changing load conditions; this can quickly become rather cumbersome. Thus, when designing a power generation facility several smaller generators connected in parallel are usually preferable to one large generator capable of handling the peak load. Each generator can be operated at or near full load, so that the voltage output is essentially constant; individual generators can be added or removed from the system depending on the demand.

We should also note that balanced three-phase sources may be transformed from Y to  $\Delta$ , or vice versa, without affecting the load currents or voltages. The necessary relationships between the line and phase voltages are shown in Fig. 12.13 for the case where  $V_{an}$  has a reference phase angle of  $0^\circ$ . This transformation enables us to use whichever source connection we prefer, and all the load relationships will be correct. Of course, we cannot specify any currents or voltages within the source until we know how it is actually connected. Balanced three-phase loads may be transformed between Y- and  $\Delta$ -connected configurations using the relation

$$Z_Y = \frac{Z_\Delta}{3}$$



which is probably worth remembering.

## 12.5 POWER MEASUREMENT IN THREE-PHASE SYSTEMS

### Use of the Wattmeter

In large electrical systems, not only are voltage and current important to know, but power is quoted so often that measuring it directly proves highly valuable. This is typically performed using a device known as a *wattmeter*, which must have the ability to establish both the voltage and the current associated with either the source, the load, or both. Modern devices are very similar to the digital multimeter, providing a numerical display of the quantity being measured. These devices frequently make use of the fact that current gives rise to a magnetic field, which can be measured without breaking the circuit. However, in the field we still encounter analog versions of the multimeter, and they continue to have some advantages over digital versions, such as the ability to function without a separate power source (e.g., battery), and secondary information that comes from watching a needle move as opposed to numbers seemingly jumping around randomly on a display. Thus, in this section, we focus on power measurement using a traditional analog meter, as switching to a digital device is straightforward if one is available. Before embarking on a discussion of the specialized techniques used to measure power in three-phase systems, it is to our advantage to briefly consider how a *wattmeter* is used in a single-phase circuit.

Power measurement is most often accomplished at frequencies below a few hundred hertz through the use of a wattmeter that contains two separate coils. One of these coils is made of heavy wire, having a very low resistance, and is called the *current coil*; the second coil is composed of a much greater number of turns of fine wire, with relatively high resistance, and is termed the *potential coil*, or *voltage coil*. Additional resistance may also be inserted internally or externally in series with the potential coil. The torque applied to the moving system and the pointer is proportional to the instantaneous product of the currents flowing in the two coils. The mechanical inertia of the moving system, however, causes a deflection that is proportional to the *average* value of this torque.

The wattmeter is used by connecting it into a network in such a way that the current flowing in the current coil is the current flowing into the network

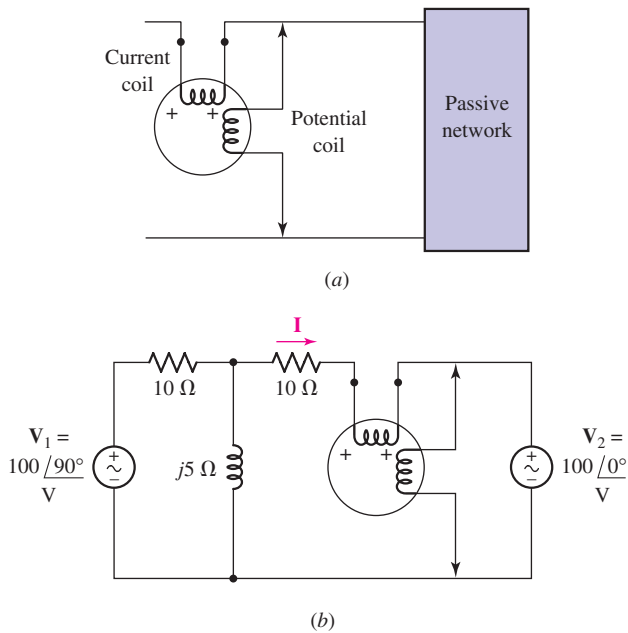

■ FIGURE 12.23 (a) A wattmeter connection that will ensure an upscale reading for the power absorbed by the passive network. (b) An example in which the wattmeter is installed to give an upscale indication of the power absorbed by the right source.

and the voltage across the potential coil is the voltage across the two terminals of the network. The current in the potential coil is thus the input voltage divided by the resistance of the potential coil.

It is apparent that the wattmeter has four available terminals, and correct connections must be made to these terminals in order to obtain an upscale reading on the meter. To be specific, let us assume that we are measuring the power absorbed by a passive network. The current coil is inserted in series with one of the two conductors connected to the load, and the potential coil is installed between the two conductors, usually on the “load side” of the current coil. The potential coil terminals are often indicated by arrows, as shown in Fig. 12.23a. Each coil has two terminals, and the proper relationship between the sense of the current and voltage must be observed. One end of each coil is usually marked (+), and an upscale reading is obtained if a positive current is flowing into the (+) end of the current coil while the (+) terminal of the potential coil is positive with respect to the unmarked end. The wattmeter shown in the network of Fig. 12.23a therefore gives an upscale deflection when the network to the right is absorbing power. A reversal of either coil, but not both, will cause the meter to try to deflect downscale; a reversal of both coils will never affect the reading.

As an example of the use of such a wattmeter in measuring average power, let us consider the circuit shown in Fig. 12.23b. The connection of the wattmeter is such that an upscale reading corresponds to a positive absorbed power for the network to the right of the meter, that is, the right source. The power absorbed by this source is given by

$$P = |\mathbf{V}_2| |\mathbf{I}| \cos(\text{ang } \mathbf{V}_2 - \text{ang } \mathbf{I})$$

Using superposition or mesh analysis, we find the current is

$$\mathbf{I} = 11.18/153.4^\circ \text{ A}$$

and thus the absorbed power is

$$P = (100)(11.18) \cos(0^\circ - 153.4^\circ) = -1000 \text{ W}$$

The pointer therefore rests against the downscale stop. In practice, the potential coil can be reversed more quickly than the current coil, and this reversal provides an upscale reading of 1000 W.

### PRACTICE

12.9 Determine the wattmeter reading in Fig. 12.24, state whether or not the potential coil had to be reversed in order to obtain an upscale reading, and identify the device or devices absorbing or generating this power. The (+) terminal of the wattmeter is connected to (a)  $x$ ; (b)  $y$ ; (c)  $z$ .

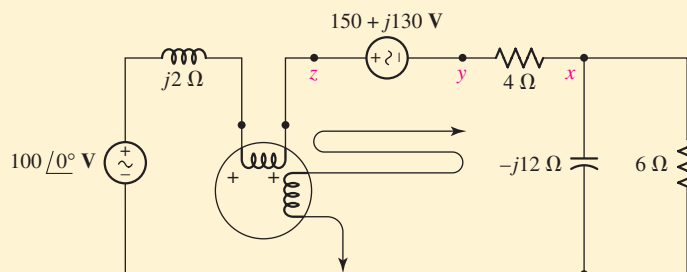

FIGURE 12.24

Ans: 1200 W, as is,  $P_{6\Omega}$  (absorbed); 2200 W, as is,  $P_{4\Omega} + P_{6\Omega}$  (absorbed); 500 W, reversed, absorbed by 100 V.

## The Wattmeter in a Three-Phase System

At first glance, measurement of the power drawn by a three-phase load seems to be a simple problem. We need place only one wattmeter in each of the three phases and add the results. For example, the proper connections for a Y-connected load are shown in Fig. 12.25a. Each wattmeter has its current coil inserted in one phase of the load and its potential coil connected between the line side of that load and the neutral. In a similar way, three wattmeters may be connected as shown in Fig. 12.25b to measure the total power taken by a  $\Delta$ -connected load. The methods are theoretically correct, but they may be useless in practice because the neutral of the Y is not always accessible and the phases of the  $\Delta$  are not available. A three-phase rotating machine, for example, has only three accessible terminals, those which we have been calling  $A$ ,  $B$ , and  $C$ .

Clearly, we have a need for a method of measuring the total power drawn by a three-phase load having only three accessible terminals; measurements may be made on the “line” side of these terminals, but not on the “load” side. Such a method is available, and is capable of measuring the power taken by an *unbalanced* load from an *unbalanced* source. Let us



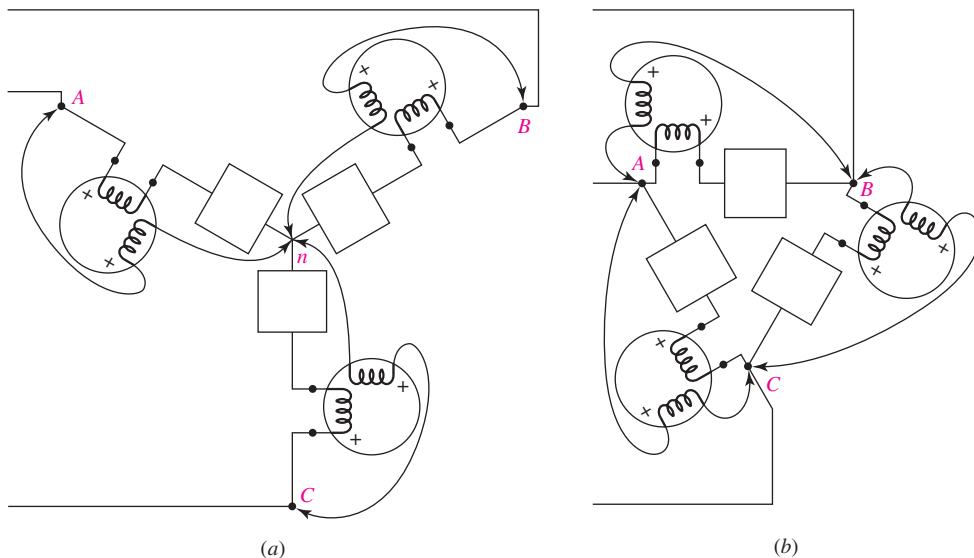

■ FIGURE 12.25 Three wattmeters are connected in such a way that each reads the power taken by one phase of a three-phase load, and the sum of the readings is the total power. (a) A Y-connected load. (b) A  $\Delta$ -connected load. Neither the loads nor the source need be balanced.

connect three wattmeters in such a way that each has its current coil in one line and its voltage coil between that line and some common point  $x$ , as shown in Fig. 12.26. Although a system with a Y-connected load is illustrated, the arguments we present are equally valid for a  $\Delta$ -connected load. The point  $x$  may be some unspecified point in the three-phase system, or it may be merely a point in space at which the three potential coils have a common node. The average power indicated by wattmeter  $A$  must be

$$P_A = \frac{1}{T} \int_0^T v_{Ax} i_{aA} dt$$

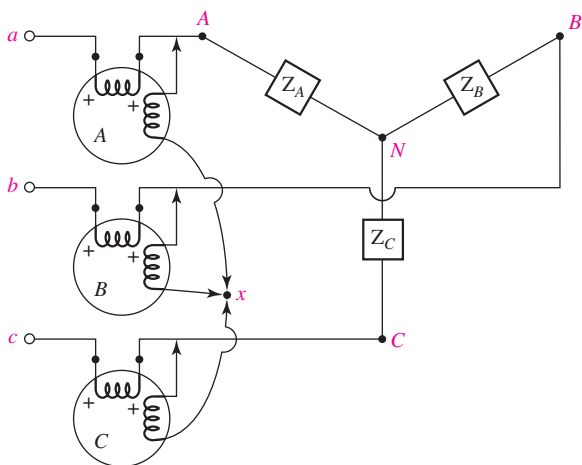

■ FIGURE 12.26 A method of connecting three wattmeters to measure the total power taken by a three-phase load. Only the three terminals of the load are accessible.

where  $T$  is the period of all the source voltages. The readings of the other two wattmeters are given by similar expressions, and the total average power drawn by the load is therefore

$$P = P_A + P_B + P_C = \frac{1}{T} \int_0^T (v_{Ax}i_{aA} + v_{Bx}i_{bB} + v_{Cx}i_{cC}) dt$$

Each of the three voltages in the preceding expression may be written in terms of a phase voltage and the voltage between point  $x$  and the neutral,

$$v_{Ax} = v_{AN} + v_{Nx}$$

$$v_{Bx} = v_{BN} + v_{Nx}$$

$$v_{Cx} = v_{CN} + v_{Nx}$$

and, therefore,

$$P = \frac{1}{T} \int_0^T (v_{AN}i_{aA} + v_{BN}i_{bB} + v_{CN}i_{cC}) dt + \frac{1}{T} \int_0^T v_{Nx}(i_{aA} + i_{bB} + i_{cC}) dt$$

However, the entire three-phase load may be considered to be a supernode, and Kirchhoff's current law requires

$$i_{aA} + i_{bB} + i_{cC} = 0$$

Thus

$$P = \frac{1}{T} \int_0^T (v_{AN}i_{aA} + v_{BN}i_{bB} + v_{CN}i_{cC}) dt$$

Reference to the circuit diagram shows that this sum is indeed the sum of the average powers taken by each phase of the load, and the sum of the readings of the three wattmeters therefore represents the total average power drawn by the entire load!

Let us illustrate this procedure with a numerical example before we discover that one of these three wattmeters is really superfluous. We will assume a balanced source,

$$\mathbf{V}_{ab} = 100/\underline{0^\circ} \text{ V}$$

$$\mathbf{V}_{bc} = 100/\underline{-120^\circ} \text{ V}$$

$$\mathbf{V}_{ca} = 100/\underline{-240^\circ} \text{ V}$$

or

$$\mathbf{V}_{an} = \frac{100}{\sqrt{3}}/\underline{-30^\circ} \text{ V}$$

$$\mathbf{V}_{bn} = \frac{100}{\sqrt{3}}/\underline{-150^\circ} \text{ V}$$

$$\mathbf{V}_{cn} = \frac{100}{\sqrt{3}}/\underline{-270^\circ} \text{ V}$$

and an unbalanced load,

$$\mathbf{Z}_A = -j10 \Omega$$

$$\mathbf{Z}_B = j10 \Omega$$

$$\mathbf{Z}_C = 10 \Omega$$

Let us assume ideal wattmeters, connected as illustrated in Fig. 12.26, with point  $x$  located on the neutral of the source  $n$ . The three line currents may be obtained by mesh analysis,

$$\mathbf{I}_{aA} = 19.32/15^\circ \text{ A}$$

$$\mathbf{I}_{bB} = 19.32/165^\circ \text{ A}$$

$$\mathbf{I}_{cC} = 10/-90^\circ \text{ A}$$

The voltage between the neutrals is

$$\mathbf{V}_{nN} = \mathbf{V}_{nb} + \mathbf{V}_{BN} = \mathbf{V}_{nb} + \mathbf{I}_{bB}(j10) = 157.7/-90^\circ$$

The average power indicated by each wattmeter may be calculated,

$$P_A = V_p I_{aA} \cos(\text{ang } \mathbf{V}_{an} - \text{ang } \mathbf{I}_{aA})$$

$$= \frac{100}{\sqrt{3}} 19.32 \cos(-30^\circ - 15^\circ) = 788.7 \text{ W}$$

$$P_B = \frac{100}{\sqrt{3}} 19.32 \cos(-150^\circ - 165^\circ) = 788.7 \text{ W}$$

$$P_C = \frac{100}{\sqrt{3}} 10 \cos(-270^\circ + 90^\circ) = -577.4 \text{ W}$$

or a total power of 1 kW. Since an rms current of 10 A flows through the *resistive* load, the total power drawn by the load is

$$P = 10^2(10) = 1 \text{ kW}$$

and the two methods agree.

## The Two-Wattmeter Method

We have proved that point  $x$ , the common connection of the three potential coils, may be located any place we wish without affecting the algebraic sum of the three wattmeter readings. Let us now consider the effect of placing point  $x$ , this common connection of the three wattmeters, directly on one of the lines. If, for example, one end of each potential coil is returned to  $B$ , then there is no voltage across the potential coil of wattmeter  $B$  and *this meter must read zero*. It may therefore be removed, and the algebraic sum of the remaining two wattmeter readings is still the total power drawn by the load. When the location of  $x$  is selected in this way, we describe the method of power measurement as the *two-wattmeter* method. The sum of the readings indicates the total power, regardless of (1) load unbalance, (2) source unbalance, (3) differences in the two wattmeters, and (4) the waveform of the periodic source. The only assumption we have made is that wattmeter corrections are sufficiently small that we can ignore them. In Fig. 12.26, for example, the current coil of each meter has passing through it the line current drawn by the load plus the current taken by the potential coil. Since the latter current is usually quite small, its effect may be estimated from a knowledge of the resistance of the potential coil and voltage across it. These two quantities enable a close estimate to be made of the power dissipated in the potential coil.

In the numerical example described previously, let us now assume that two wattmeters are used, one with current coil in line  $A$  and potential coil between lines  $A$  and  $B$ , the other with current coil in line  $C$  and potential coil

Note that the reading of one of the wattmeters is negative. Our previous discussion on the basic use of a wattmeter indicates that an upscale reading on that meter can only be obtained after either the potential coil or the current coil is reversed.

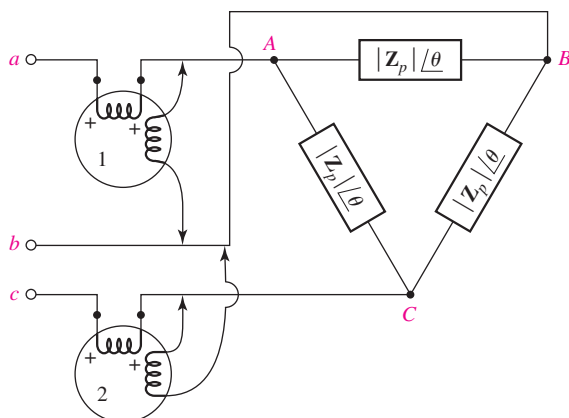

■ FIGURE 12.27 Two wattmeters connected to read the total power drawn by a balanced three-phase load.

between  $C$  and  $B$ . The first meter reads

$$\begin{aligned} P_1 &= V_{AB} I_{aA} \cos(\text{ang } V_{AB} - \text{ang } I_{aA}) \\ &= 100(19.32) \cos(0^\circ - 15^\circ) \\ &= 1866 \text{ W} \end{aligned}$$

and the second

$$\begin{aligned} P_2 &= V_{CB} I_{cC} \cos(\text{ang } V_{CB} - \text{ang } I_{cC}) \\ &= 100(10) \cos(60^\circ + 90^\circ) \\ &= -866 \text{ W} \end{aligned}$$

and, therefore,

$$P = P_1 + P_2 = 1866 - 866 = 1000 \text{ W}$$

as we expect from recent experience with the circuit.

In the case of a balanced load, the two-wattmeter method enables the PF angle to be determined, as well as the total power drawn by the load. Let us assume a load impedance with a phase angle  $\theta$ ; either a Y or  $\Delta$  connection may be used and we will assume the  $\Delta$  connection shown in Fig. 12.27. The construction of a standard phasor diagram, such as that of Fig. 12.19, enables us to determine the proper phase angle between the several line voltages and line currents. We therefore determine the readings

$$\begin{aligned} P_1 &= |\mathbf{V}_{AB}| |\mathbf{I}_{aA}| \cos(\text{ang } \mathbf{V}_{AB} - \text{ang } \mathbf{I}_{aA}) \\ &= V_L I_L \cos(30^\circ + \theta) \end{aligned}$$

and

$$\begin{aligned} P_2 &= |\mathbf{V}_{CB}| |\mathbf{I}_{cC}| \cos(\text{ang } \mathbf{V}_{CB} - \text{ang } \mathbf{I}_{cC}) \\ &= V_L I_L \cos(30^\circ - \theta) \end{aligned}$$

The ratio of the two readings is

$$\frac{P_1}{P_2} = \frac{\cos(30^\circ + \theta)}{\cos(30^\circ - \theta)} \quad [5]$$

If we expand the cosine terms, this equation is easily solved for  $\tan \theta$ ,

$$\tan \theta = \sqrt{3} \frac{P_2 - P_1}{P_2 + P_1} \quad [6]$$



Thus, equal wattmeter readings indicate a unity PF load; equal and opposite readings indicate a purely reactive load; a reading of  $P_2$  which is (algebraically) greater than  $P_1$  indicates an inductive impedance; and a reading of  $P_2$  which is less than  $P_1$  signifies a capacitive load. How can we tell which wattmeter reads  $P_1$  and which reads  $P_2$ ? It is true that  $P_1$  is in line A, and  $P_2$  is in line C, and our positive phase-sequence system forces  $V_{an}$  to lag  $V_{cn}$ . This is enough information to differentiate between two wattmeters, but it is confusing to apply in practice. Even if we were unable to distinguish between the two, we know the magnitude of the phase angle, but not its sign. This is often sufficient information; if the load is an induction motor, the angle must be positive and we do not need to make any tests to determine which reading is which. If no previous knowledge of the load is assumed, then there are several methods of resolving the ambiguity. Perhaps the simplest method is that which involves adding a high-impedance reactive load, say, a three-phase capacitor, across the unknown load. The load must become more capacitive. Thus, if the magnitude of  $\tan \theta$  (or the magnitude of  $\theta$ ) decreases, then the load was inductive, whereas an increase in the magnitude of  $\tan \theta$  signifies an original capacitive impedance.

## EXAMPLE 12.7

**The balanced load in Fig. 12.28 is fed by a balanced three-phase system having  $\mathbf{V}_{ab} = 230/0^\circ$  V rms and positive phase sequence. Find the reading of each wattmeter and the total power drawn by the load.**

The potential coil of wattmeter #1 is connected to measure the voltage  $\mathbf{V}_{ac}$ , and its current coil is measuring the phase current  $\mathbf{I}_{aA}$ . Since we know to use the positive phase sequence, the line voltages are

$$\mathbf{V}_{ab} = 230/0^\circ \text{ V}$$

$$\mathbf{V}_{bc} = 230/-120^\circ \text{ V}$$

$$\mathbf{V}_{ca} = 230/120^\circ \text{ V}$$

Note that  $\mathbf{V}_{ac} = -\mathbf{V}_{ca} = 230/-60^\circ$  V.

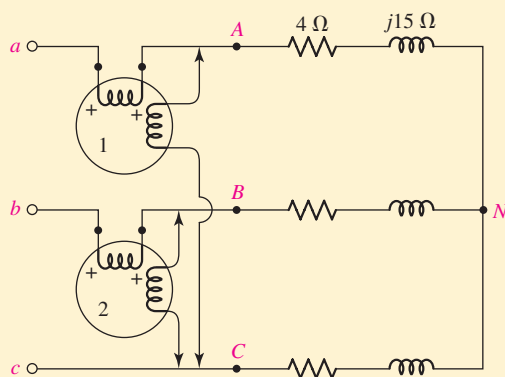

■ FIGURE 12.28 A balanced three-phase system connected to a balanced three-phase load, the power of which is being measured using the two-wattmeter technique.

(Continued on next page)

The phase current  $\mathbf{I}_{aA}$  is given by the phase voltage  $\mathbf{V}_{an}$  divided by the phase impedance  $4 + j15 \Omega$ ,

$$\begin{aligned}\mathbf{I}_{aA} &= \frac{\mathbf{V}_{an}}{4 + j15} = \frac{(230/\sqrt{3})\angle -30^\circ}{4 + j15} \text{ A} \\ &= 8.554\angle -105.1^\circ \text{ A}\end{aligned}$$

We may now compute the power measured by wattmeter #1 as

$$\begin{aligned}P_1 &= |\mathbf{V}_{ac}| |\mathbf{I}_{aA}| \cos(\text{ang } \mathbf{V}_{ac} - \text{ang } \mathbf{I}_{aA}) \\ &= (230)(8.554) \cos(-60^\circ + 105.1^\circ) \text{ W} \\ &= 1389 \text{ W}\end{aligned}$$

In a similar fashion, we determine that

$$\begin{aligned}P_2 &= |\mathbf{V}_{bc}| |\mathbf{I}_{bB}| \cos(\text{ang } \mathbf{V}_{bc} - \text{ang } \mathbf{I}_{bB}) \\ &= (230)(8.554) \cos(-120^\circ - 134.9^\circ) \text{ W} \\ &= -512.5 \text{ W}\end{aligned}$$

Thus, the total average power absorbed by the load is

$$P = P_1 + P_2 = 876.5 \text{ W}$$

Since this measurement would result in the meter pegged at downscale, one of the coils would need to be reversed in order to take the reading.

### PRACTICE

12.10 For the circuit of Fig. 12.26, let the loads be  $\mathbf{Z}_A = 25\angle 60^\circ \Omega$ ,  $\mathbf{Z}_B = 50\angle -60^\circ \Omega$ ,  $\mathbf{Z}_C = 50\angle 60^\circ \Omega$ ,  $\mathbf{V}_{AB} = 600\angle 0^\circ$  V rms with (+) phase sequence, and locate point  $x$  at  $C$ . Find (a)  $P_A$ ; (b)  $P_B$ ; (c)  $P_C$ .

Ans: 0; 7200 W; 0.

## SUMMARY AND REVIEW

Polyphase circuits are not encountered directly by everyone, but are part of almost every large building installation. In this chapter we studied how three voltages, each  $120^\circ$  out of phase with the others, can be supplied by a single generator (and hence have the same frequency) and connected to a three-component load. For the sake of convenience we introduced the double-subscript notation, which is commonly employed. A three-phase system will have at least three terminals; a neutral wire connection is not mandatory but is common at least for the source. If a  $\Delta$ -connected load is employed, then there is no neutral connection to it. When a neutral wire is present, we can define *phase voltages*  $\mathbf{V}_{an}$ ,  $\mathbf{V}_{bn}$ , and  $\mathbf{V}_{cn}$  between each phase ( $a$ ,  $b$ , or  $c$ ) and neutral. Kirchhoff's voltage law requires that these three phase voltages sum to zero, regardless of whether positive or negative phase sequence relates their angles. *Line voltages* (i.e., between phases) can be related directly to the phase voltages; for a  $\Delta$ -connected load they are equal. In a similar fashion, *line currents* and *phase currents* can be directly related to one another; in a Y-connected load, they are equal. At first glance such systems can appear to be somewhat complicated, but symmetry often allows us to perform the analysis on a per-phase basis, simplifying our calculations considerably.

A concise list of key concepts of the chapter is presented below for the convenience of the reader, along with the corresponding example numbers.

- The majority of electricity production is in the form of three-phase power.
- Most residential electricity in North America is in the form of single-phase alternating current at a frequency of 60 Hz and an rms voltage of 115 V. Elsewhere, 50 Hz at 240 V rms is most common.
- Double-subscript notation is commonly employed in power systems for both voltages and currents. (Example 12.1)
- Three-phase sources can be either Y- or  $\Delta$ -connected. Both types of sources have three terminals, one for each phase; Y-connected sources have a neutral connection as well. (Example 12.2)
- In a balanced three-phase system, each phase voltage has the same magnitude, but is  $120^\circ$  out of phase with the other two. (Example 12.2)
- Loads in a three-phase system may be either Y- or  $\Delta$ -connected.
- In a balanced Y-connected source with positive (“abc”) phase sequence, the line voltages are

$$\begin{aligned} \mathbf{V}_{ab} &= \sqrt{3}V_p \underline{/30^\circ} & \mathbf{V}_{bc} &= \sqrt{3}V_p \underline{/ -90^\circ} \\ \mathbf{V}_{ca} &= \sqrt{3}V_p \underline{/ -210^\circ} \end{aligned}$$

where the phase voltages are

$$\mathbf{V}_{an} = V_p \underline{/0^\circ} \quad \mathbf{V}_{bn} = V_p \underline{/ -120^\circ} \quad \mathbf{V}_{cn} = V_p \underline{/ -240^\circ}$$

(Example 12.2)

- In a system with a Y-connected load, the line currents are equal to the phase currents. (Examples 12.3, 12.4, 12.6)
- In a  $\Delta$ -connected load, the line voltages are equal to the phase voltages. (Example 12.5)
- In a balanced system with positive phase sequence and a balanced  $\Delta$ -connected load, the line currents are

$$\mathbf{I}_a = \mathbf{I}_{AB} \sqrt{3} \underline{/ -30^\circ} \quad \mathbf{I}_b = \mathbf{I}_{BC} \sqrt{3} \underline{/ -150^\circ} \quad \mathbf{I}_c = \mathbf{I}_{CA} \sqrt{3} \underline{/ +90^\circ}$$

where the phase currents are

$$\mathbf{I}_{AB} = \frac{\mathbf{V}_{AB}}{\mathbf{Z}_\Delta} = \frac{\mathbf{V}_{ab}}{\mathbf{Z}_\Delta} \quad \mathbf{I}_{BC} = \frac{\mathbf{V}_{BC}}{\mathbf{Z}_\Delta} = \frac{\mathbf{V}_{bc}}{\mathbf{Z}_\Delta} \quad \mathbf{I}_{CA} = \frac{\mathbf{V}_{CA}}{\mathbf{Z}_\Delta} = \frac{\mathbf{V}_{ca}}{\mathbf{Z}_\Delta}$$

(Example 12.5)

- Most power calculations are performed on a per-phase basis, assuming a balanced system; otherwise, nodal/mesh analysis is always a valid approach. (Examples 12.3, 12.4, 12.5)
- The power in a three-phase system (balanced or unbalanced) can be measured with only two wattmeters. (Example 12.7)
- The instantaneous power in any balanced three-phase system is constant.

## READING FURTHER

A good overview of ac power concepts can be found in Chap. 2 of:

B. M. Weedy, *Electric Power Systems*, 3rd ed. Chichester, England: Wiley, 1984.

A comprehensive book on generation of electrical power from wind is:

T. Burton, D. Sharpe, N. Jenkins, and E. Bossanyi, *Wind Energy Handbook*. Chichester, England: Wiley, 2001.

## EXERCISES

### 12.1 Polyphase Systems

1. An unknown three terminal device has leads named  $b$ ,  $c$ , and  $e$ . When installed in one particular circuit, measurements indicated that  $V_{ec} = -9$  V and  $V_{eb} = -0.65$  V. (a) Calculate  $V_{cb}$ . (b) Determine the power dissipated in the  $b$ - $e$  junction if the current  $I_b$  flowing into the terminal marked  $b$  is equal to  $1$   $\mu$ A.
2. A common type of transistor is known as the MESFET, which is an acronym for **m**etal-**s**emiconductor **f**ield **e**ffect **t**ransistor. It has three terminals, named the gate ( $g$ ), the source ( $s$ ), and the drain ( $d$ ). As an example, consider one particular MESFET operating in a circuit such that  $V_{sg} = 0.2$  V and  $V_{ds} = 3$  V. (a) Calculate  $V_{gs}$  and  $V_{dg}$ . (b) If a gate current  $I_g = 100$  pA is found to be flowing into the gate terminal, compute the power lost at the gate-source junction.
3. For a certain Y-connected three-phase source,  $\mathbf{V}_{an} = 400/\underline{33^\circ}$  V,  $\mathbf{V}_{bn} = 400/\underline{153^\circ}$  V, and  $\mathbf{V}_{cn} = 160/\underline{208^\circ}$  V. Determine (a)  $\mathbf{V}_{cn}$ ; (b)  $\mathbf{V}_{an} - \mathbf{V}_{bn}$ ; (c)  $\mathbf{V}_{ax}$ ; (d)  $\mathbf{V}_{bx}$ .
4. Describe what is meant by a “polyphase” source, state one possible advantage of such sources that might outweigh their additional complexity over single-phase sources of power, and explain the difference between “balanced” and “unbalanced” sources.
5. Several of the voltages associated with a certain circuit are given by  $\mathbf{V}_{12} = 9/\underline{30^\circ}$  V,  $\mathbf{V}_{32} = 3/\underline{130^\circ}$  V, and  $\mathbf{V}_{14} = 2/\underline{10^\circ}$  V. Determine  $\mathbf{V}_{21}$ ,  $\mathbf{V}_{13}$ ,  $\mathbf{V}_{34}$ , and  $\mathbf{V}_{24}$ .
6. The nodal voltages which describe a particular circuit can be expressed as  $\mathbf{V}_{14} = 9 - j$  V,  $\mathbf{V}_{24} = 3 + j3$  V, and  $\mathbf{V}_{34} = 8$  V. Calculate  $\mathbf{V}_{12}$ ,  $\mathbf{V}_{32}$ , and  $\mathbf{V}_{13}$ . Express your answers in phasor form.
7. In the circuit of Fig. 12.29, the resistor markings unfortunately have been omitted, but several of the currents are known. Specifically,  $I_{ad} = 1$  A. (a) Compute  $I_{ab}$ ,  $I_{cd}$ ,  $I_{de}$ ,  $I_{fe}$ , and  $I_{be}$ . (b) If  $V_{ba} = 125$  V, determine the value of the resistor linking nodes  $a$  and  $b$ .

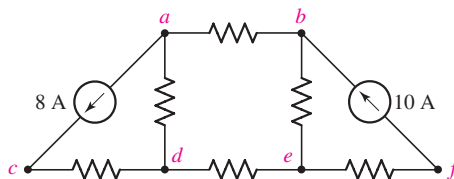

■ FIGURE 12.29

8. For the circuit shown in Fig. 12.30, (a) determine  $I_{gh}$ ,  $I_{cd}$ , and  $I_{dh}$ . (b) Calculate  $I_{ed}$ ,  $I_{ei}$ , and  $I_{jf}$ . (c) If all resistors in the circuit each have a value of  $1$   $\Omega$ , determine the three clockwise-flowing mesh currents.



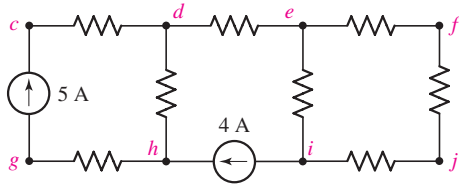

■ FIGURE 12.30

9. Additional resistors are added in parallel to the resistors between terminals  $d$  and  $e$ , and terminals  $f$  and  $j$ , respectively, of the circuit in Fig. 12.30. (a) Which voltages may still be described using double-subscript notation? (b) Which line currents may still be described by double-subscript notation?

## 12.2 Single-Phase Three-Wire Systems

10. Most consumer electronics are powered by 110 V outlets, but several types of appliances (such as clothes dryers) are powered from 220 V outlets. Lower voltages are generally safer. What, then, motivates manufacturers of some pieces of equipment to design them to run on 220 V?
11. The single-phase three-wire system of Fig. 12.31 has three separate load impedances. If the source is balanced and  $V_{an} = 110 + j0$  V rms, (a) express  $V_{an}$  and  $V_{bn}$  in phasor notation. (b) Determine the phasor voltage which appears across the impedance  $Z_3$ . (c) Determine the average power delivered by the two sources if  $Z_1 = 50 + j0 \Omega$ ,  $Z_2 = 100 + j45 \Omega$ , and  $Z_3 = 100 - j90 \Omega$ . (d) Represent load  $Z_3$  by a series connection of two elements, and state their respective values if the sources operate at 60 Hz.
12. For the system represented in Fig. 12.32, the ohmic losses in the neutral wire are so small they can be neglected and it can be adequately modeled as a short circuit. (a) Calculate the power lost in the two lines as a result of their nonzero resistance. (b) Compute the average power delivered to the load. (c) Determine the power factor of the total load.

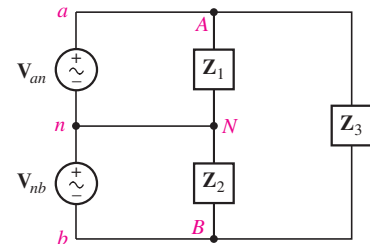

■ FIGURE 12.31

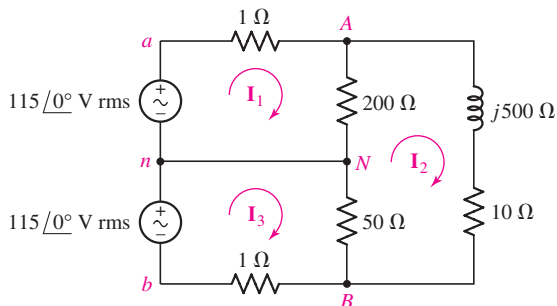

■ FIGURE 12.32

13. Referring to the balanced load represented in Fig. 12.33, if it is connected to a three-wire balanced source operating at 50 Hz such that  $V_{AN} = 115$  V, (a) determine the power factor of the load if the capacitor is omitted; (b) determine the value of capacitance  $C$  that will achieve a unity power factor for the total load.
14. In the three-wire system of Fig. 12.32, (a) replace the 50  $\Omega$  resistor with a 200  $\Omega$  resistor, and calculate the current flowing through the neutral wire. (b) Determine a new value for the 50  $\Omega$  resistor such that the neutral wire current magnitude is 25% that of line current  $I_{aA}$ .

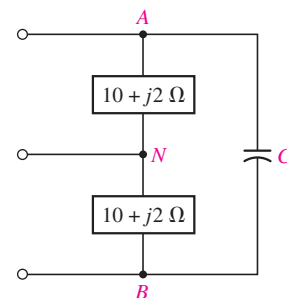

■ FIGURE 12.33

### 12.3 Three-Phase Y-Y Connection

15. (a) Show that if  $\mathbf{V}_{an} = 400/\underline{33^\circ}$  V,  $\mathbf{V}_{bn} = 400/\underline{-87^\circ}$  V, and  $\mathbf{V}_{cn} = 400/\underline{-207^\circ}$  V, that  $\mathbf{V}_{an} + \mathbf{V}_{bn} + \mathbf{V}_{cn} = 0$ . (b) Do the voltages in part (a) represent positive or negative phase sequence? Explain.
16. Consider a simple positive phase sequence, three-phase, three-wire system operated at 50 Hz and with a balance load. Each phase voltage of 240 V is connected across a load composed of a series-connected  $50\ \Omega$  and 500 mH combination. Calculate (a) each line current; (b) the power factor of the load; (c) the total power supplied by the three-phase source.
17. Assume the system shown in Fig. 12.34 is balanced,  $R_w = 0$ ,  $\mathbf{V}_{an} = 208/\underline{0^\circ}$  V, and a positive phase sequence applies. Calculate all phase and line currents, and all phase and line voltages, if  $\mathbf{Z}_p$  is equal to (a)  $1\ \text{k}\Omega$ ; (b)  $100 + j48\ \Omega$ ; (c)  $100 - j48\ \Omega$ .

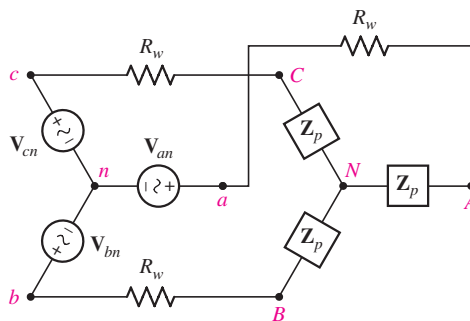

FIGURE 12.34



18. Repeat Exercise 17 with  $R_w = 10\ \Omega$ , and verify your answers with appropriate PSpice simulations if the operating frequency is 60 Hz.
19. Each impedance  $\mathbf{Z}_p$  in the balanced three-phase system of Fig. 12.34 is constructed using the parallel combination of a 1 mF capacitance, a 100 mH inductance, and a  $10\ \Omega$  resistance. The sources have positive phase sequence and operate at 50 Hz. If  $\mathbf{V}_{ab} = 208/\underline{0^\circ}$  V, and  $R_w = 0$ , calculate (a) all phase voltages; (b) all line voltages; (c) all three line currents; (d) the total power drawn by the load.
20. With the assumption that the three-phase system pictured in Fig. 12.34 is balanced with a line voltage of 100 V, calculate the line current and per-phase load impedance if  $R_w = 0$  and the load draws (a) 1 kW at a PF of 0.85 lagging; (b) 300 W per phase at a PF of 0.92 leading.
21. The balanced three-phase system of Fig. 12.34 is characterized by a positive phase sequence and a line voltage of 300 V. And  $\mathbf{Z}_p$  is given by the parallel combination of a  $5 - j3\ \Omega$  capacitive load and a  $9 + j2\ \Omega$  inductive load. If  $R_w = 0$ , calculate (a) the power factor of the source; (b) the total power supplied by the source. (c) Repeat parts (a) and (b) if  $R_w = 1\ \Omega$ .
22. A balanced Y-connected load of  $100 + j50\ \Omega$  is connected to a balanced three-phase source. If the line current is 42 A and the source supplies 12 kW, determine (a) the line voltage; (b) the phase voltage.
23. A three-phase system is constructed from a balanced Y-connected source operating at 50 Hz and having a line voltage of 210 V, and each phase of the balanced load draws 130 W at a leading power factor of 0.75. (a) Calculate the line current and the total power supplied to the load. (b) If a purely resistive load of  $1\ \Omega$  is connected in parallel with each existing load, calculate the new line current and total power supplied to the load. (c) Verify your answers using appropriate PSpice simulations.



24. Returning to the balanced three-phase system described in Exercise 21, determine the complex power delivered to the load for both  $R_w = 0$  and  $R_w = 1 \Omega$ .
25. Each load in the circuit of Fig. 12.34 is composed of a 1.5 H inductor in parallel with a  $100 \mu\text{F}$  capacitor and a  $1 \text{ k}\Omega$  resistor. The resistance is labeled  $R_w = 0 \Omega$ . Using positive phase sequence with  $V_{ab} = 115/0^\circ \text{ V}$  at  $f = 60 \text{ Hz}$ , determine the rms line current and the total power delivered to the load. Verify your answers with an appropriate PSpice simulation.



## 12.4 The Delta ( $\Delta$ ) Connection

26. A particular balanced three-phase system is supplying a  $\Delta$ -connected load with 10 kW at a leading power factor of 0.7. If the phase voltage is 208 V and the source operates at 50 V, (a) compute the line current; (b) determine the phase impedance; (c) calculate the new power factor and new total power delivered to the load if a 2.5 H inductor is connected in parallel with each phase of the load.
27. If each of the three phases in a balanced  $\Delta$ -connected load is composed of a 10 mF capacitor in parallel with a series-connected  $470 \Omega$  resistor and 4 mH inductor combination, assume a phase voltage of 400 V at 50 Hz. (a) Calculate the phase current; (b) the line current; (c) the line voltage; (d) the power factor at which the source operates; (e) the total power delivered to the load.
28. A three-phase load is to be powered by a three-wire three-phase Y-connected source having phase voltage of 400 V and operating at 50 Hz. Each phase of the load consists of a parallel combination of a  $500 \Omega$  resistor, 10 mH inductor, and 1 mF capacitor. (a) Compute the line current, line voltage, phase current, and power factor of the load if the load is also Y-connected. (b) Rewire the load so that it is  $\Delta$ -connected and find the same quantities requested in part (a).
29. For the two situations described in Exercise 28, compute the total power delivered to each of the two loads.
30. Two  $\Delta$ -connected loads are connected in parallel and powered by a balanced Y-connected system. The smaller of the two loads draws 10 kVA at a lagging PF of 0.75, and the larger draws 25 kVA at a leading PF of 0.80. The line voltage is 400 V. Calculate (a) the power factor at which the source is operating; (b) the total power drawn by the two loads; (c) the phase current of each load.
31. For the balanced three-phase system shown in Fig. 12.35, it is determined that 100 W is lost in each wire. If the phase voltage of the source is 400 V, and the load draws 12 kW at a lagging PF of 0.83, determine the wire resistance  $R_w$ .

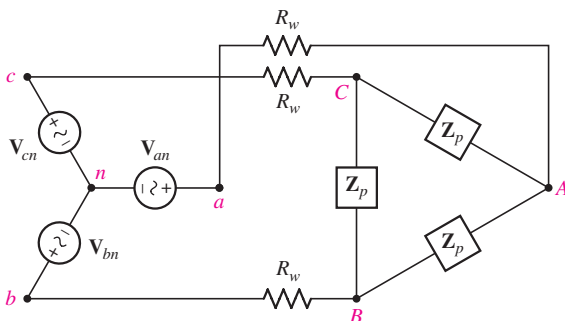

■ FIGURE 12.35

32. The balanced  $\Delta$ -connected load in Fig. 12.35 is demanding 10 kVA at a lagging PF of 0.91. If line losses are negligible, calculate  $I_{bB}$  and  $V_{an}$  if  $V_{ca} = 160/30^\circ \text{ V}$  and the source voltages are described using positive phase sequence.



33. Repeat Exercise 32 if  $R_w = 1 \Omega$ . Verify your solution using an appropriate PSpice simulation.
34. Compute  $\mathbf{I}_{aA}$ ,  $\mathbf{I}_{AB}$ , and  $\mathbf{V}_{an}$  if the  $\Delta$ -connected load of Fig. 12.35 draws a total complex power of  $1800 + j700 \text{ W}$ ,  $R_w = 1.2 \Omega$ , and the source generates a complex power of  $1850 + j700 \text{ W}$ .
35. A balanced three-phase system having line voltage of  $240 \text{ V rms}$  contains a  $\Delta$ -connected load of  $12 + j \text{ k}\Omega$  per phase and also a Y-connected load of  $5 + j3 \text{ k}\Omega$  per phase. Find the line current, the power taken by the combined load, and the power factor of the load.

### 12.5 Power Measurement in Three-Phase Systems

36. Determine the wattmeter reading (stating whether or not the leads had to be reversed to obtain it) in the circuit of Fig. 12.36 if terminals  $A$  and  $B$ , respectively, are connected to (a)  $x$  and  $y$ ; (b)  $x$  and  $z$ ; (c)  $y$  and  $z$ .

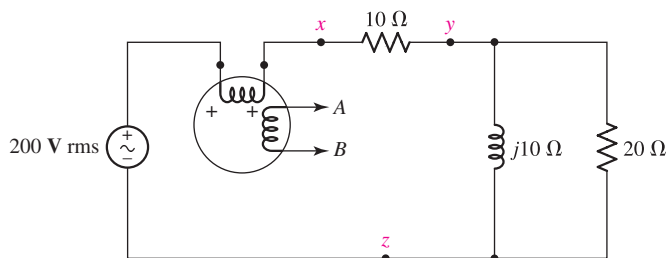

■ FIGURE 12.36



37. A wattmeter is connected into the circuit of Fig. 12.37 so that  $\mathbf{I}_1$  enters the (+) terminal of the current coil, while  $\mathbf{V}_2$  is the voltage across the potential coil. Find the wattmeter reading, and verify your solution with an appropriate PSpice simulation.

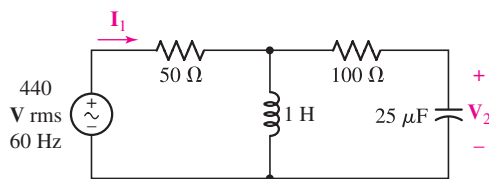

■ FIGURE 12.37

38. Find the reading of the wattmeter connected in the circuit of Fig. 12.38.

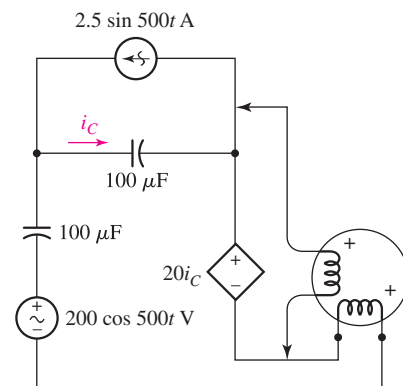

■ FIGURE 12.38



39. (a) Find both wattmeter readings in Fig. 12.39 if  $\mathbf{V}_A = 100/\underline{0^\circ}$  V rms,  $\mathbf{V}_B = 50/\underline{90^\circ}$  V rms,  $\mathbf{Z}_A = 10 - j10 \Omega$ ,  $\mathbf{Z}_B = 8 + j6 \Omega$ , and  $\mathbf{Z}_C = 30 + j10 \Omega$ . (b) Is the sum of these readings equal to the total power taken by the three loads? Verify your answer with an appropriate PSpice simulation.

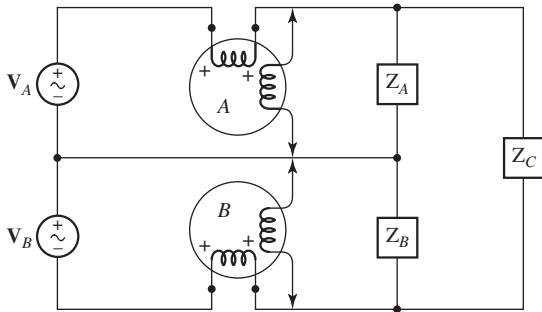

■ FIGURE 12.39

40. Circuit values for Fig. 12.40 are  $\mathbf{V}_{ab} = 200/\underline{0^\circ}$ ,  $\mathbf{V}_{bc} = 200/\underline{120^\circ}$ ,  $\mathbf{V}_{ca} = 200/\underline{240^\circ}$  V rms,  $\mathbf{Z}_4 = \mathbf{Z}_5 = \mathbf{Z}_6 = 25/\underline{30^\circ} \Omega$ ,  $\mathbf{Z}_1 = \mathbf{Z}_2 = \mathbf{Z}_3 = 50/\underline{-60^\circ} \Omega$ . Find the reading for each wattmeter.

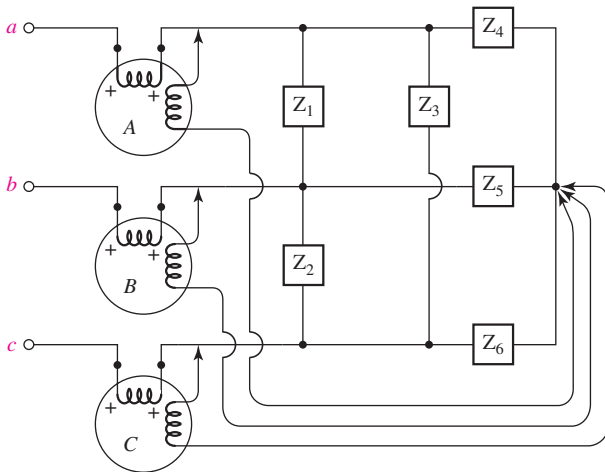

■ FIGURE 12.40

### Chapter-Integrating Exercises

41. Explain under what circumstances a  $\Delta$ -connected load might be preferred over a Y-connected load which draws the same average and complex powers.
42. A certain 208 V, 60 Hz, three-phase source is connected in a Y configuration and exhibits positive phase sequence. Each phase of the balanced load consists of a coil best modeled as a  $0.2 \Omega$  resistance in series with a 580 mH inductance. (a) Determine the line voltages and the phase currents if the load is  $\Delta$ -connected. (b) Repeat part (a) if the load is Y-connected instead.

43. (a) Is the load represented in Fig. 12.41 considered a three-phase load? *Explain.*  
 (b) If  $\mathbf{Z}_{AN} = 1 - j7 \Omega$ ,  $\mathbf{Z}_{BN} = 3/\underline{22^\circ} \Omega$  and  $\mathbf{Z}_{AB} = 2 + j \Omega$ , calculate all phase (and line) currents and voltages assuming a phase to neutral voltage of 120 VAC (the two phases are  $180^\circ$  out of phase). (c) Under what circumstances does current flow in the neutral wire?

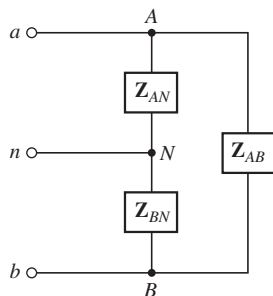

■ FIGURE 12.41

44. The computer equipment in a small manufacturing plant all runs on standard 120 VAC, but only 208 VAC three-phase power is available. Explain how the computer equipment can be connected to the existing power wiring.

# Magnetically Coupled Circuits

## INTRODUCTION

Whenever current flows through a conductor, whether as ac or dc, a magnetic field is generated about that conductor. In the context of circuits, we often refer to the *magnetic flux* through a loop of wire. This is the average normal component of the magnetic field density emanating from the loop multiplied by the surface area of the loop. When a time-varying magnetic field generated by one loop penetrates a second loop, a voltage is induced between the ends of the second wire. In order to distinguish this phenomenon from the “inductance” we defined earlier, more properly termed “self-inductance,” we will define a new term, *mutual inductance*.

There is no such device as a “mutual inductor,” but the principle forms the basis for an extremely important device—the *transformer*. A transformer consists of two coils of wire separated by a small distance, and is commonly used to convert ac voltages to higher or lower values depending on the application. Every electrical appliance that requires dc current to operate but plugs into an ac wall outlet makes use of a transformer to adjust voltage levels prior to *rectification*, a function typically performed by diodes and described in every introductory electronics text.

## 13.1 MUTUAL INDUCTANCE

When we defined inductance in Chap. 7, we did so by specifying the relationship between the terminal voltage and current,

$$v(t) = L \frac{di(t)}{dt}$$

## KEY CONCEPTS

Mutual Inductance

Self-Inductance

The Dot Convention

Reflected Impedance

T and  $\Pi$  Equivalent Networks

The Ideal Transformer

Turns Ratio of an Ideal Transformer

Impedance Matching

Voltage Level Adjustment

PSpice Analysis of Circuits with Transformers



where the passive sign convention is assumed. The physical basis for such a current-voltage characteristic rests upon two things:

1. The production of a **magnetic flux** by a current, the flux being proportional to the current in linear inductors.
2. The production of a voltage by the time-varying magnetic field, the voltage being proportional to the time rate of change of the magnetic field or the magnetic flux.

### Coefficient of Mutual Inductance

Mutual inductance results from a slight extension of this same argument. A current flowing in one coil establishes a magnetic flux about that coil and also about a second coil nearby. The time-varying flux surrounding the second coil produces a voltage across the terminals of the second coil; this voltage is proportional to the time rate of change of the current flowing through the first coil. Figure 13.1a shows a simple model of two coils  $L_1$  and  $L_2$ , sufficiently close together that the flux produced by a current  $i_1(t)$  flowing through  $L_1$  establishes an open-circuit voltage  $v_2(t)$  across the terminals of  $L_2$ . Without considering the proper algebraic sign for the relationship at this point, we define the *coefficient of mutual inductance*, or simply **mutual inductance**,  $M_{21}$ , as

$$v_2(t) = M_{21} \frac{di_1(t)}{dt} \quad [1]$$

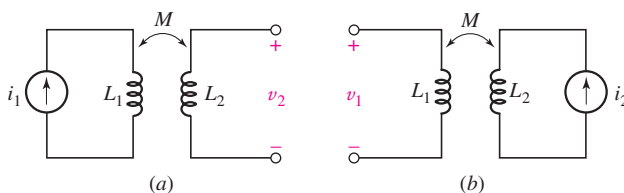

■ FIGURE 13.1 (a) A current  $i_1$  through  $L_1$  produces an open-circuit voltage  $v_2$  across  $L_2$ . (b) A current  $i_2$  through  $L_2$  produces an open-circuit voltage  $v_1$  across  $L_1$ .

The order of the subscripts on  $M_{21}$  indicates that a voltage response is produced at  $L_2$  by a current source at  $L_1$ . If the system is reversed, as indicated in Fig. 13.1b, then we have

$$v_1(t) = M_{12} \frac{di_2(t)}{dt} \quad [2]$$

Two coefficients of mutual inductance are not necessary, however; we will use energy relationships a little later to prove that  $M_{12}$  and  $M_{21}$  are equal. Thus,  $M_{12} = M_{21} = M$ . The existence of mutual coupling between two coils is indicated by a double-headed arrow, as shown in Fig. 13.1a and b.

Mutual inductance is measured in henrys and, like resistance, inductance, and capacitance, is a positive quantity.<sup>1</sup> The voltage  $M di/dt$ , however, may appear as either a positive or a negative quantity depending on whether the current is increasing or decreasing at a particular instant in time.

(1) Mutual inductance is not universally assumed to be positive. It is particularly convenient to allow it to “carry its own sign” when three or more coils are involved and each coil interacts with each other coil. We will restrict our attention to the more important simple case of two coils.



## Dot Convention

The inductor is a two-terminal element, and we are able to use the passive sign convention in order to select the correct sign for the voltage  $L di/dt$  or  $j\omega LI$ . If the current enters the terminal at which the positive voltage reference is located, then the positive sign is used. Mutual inductance, however, cannot be treated in exactly the same way because four terminals are involved. The choice of a correct sign is established by use of one of several possibilities that include the “*dot convention*,” or by an examination of the particular way in which each coil is wound. We will use the dot convention and merely look briefly at the physical construction of the coils; the use of other special symbols is not necessary when only two coils are coupled.

The dot convention makes use of a large dot placed at one end of each of the two coils which are mutually coupled. We determine the sign of the mutual voltage as follows:

A current entering the *dotted* terminal of one coil produces an open-circuit voltage with a *positive* voltage reference at the *dotted* terminal of the second coil.

Thus, in Fig. 13.2a,  $i_1$  enters the dotted terminal of  $L_1$ ,  $v_2$  is sensed positively at the dotted terminal of  $L_2$ , and  $v_2 = M di_1/dt$ . We have found previously that it is often not possible to select voltages or currents throughout a circuit so that the passive sign convention is everywhere satisfied; the same situation arises with mutual coupling. For example, it may be more convenient to represent  $v_2$  by a positive voltage reference at the undotted terminal, as shown in Fig. 13.2b; then  $v_2 = -M di_1/dt$ . Currents that enter the dotted terminal are also not always available, as indicated by Fig. 13.2c and d. We note then that:

A current entering the *undotted* terminal of one coil provides a voltage that is *positively* sensed at the *undotted* terminal of the second coil.

Note that the preceding discussion does not include any contribution to the voltage from self-induction, which would occur if  $i_2$  were nonzero. We will consider this important situation in detail, but a quick example first is appropriate.

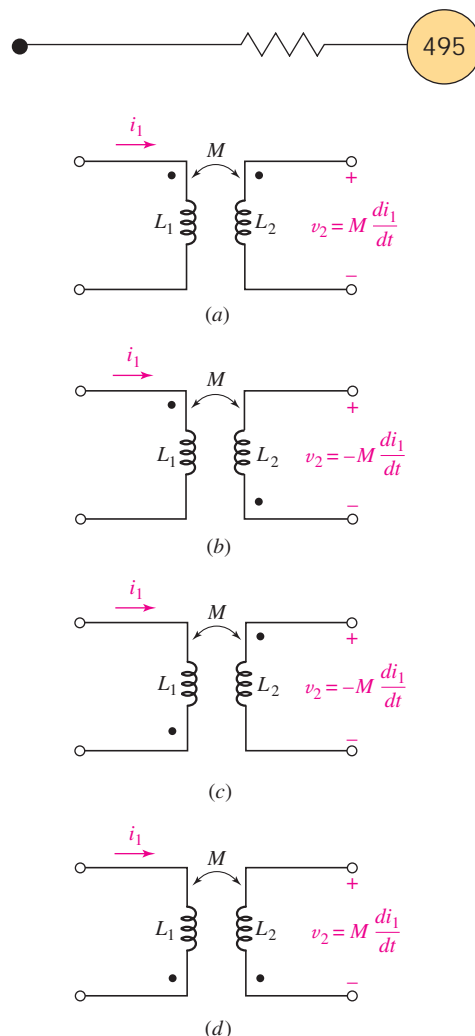

■ FIGURE 13.2 Current entering the dotted terminal of one coil produces a voltage that is sensed positively at the dotted terminal of the second coil. Current entering the undotted terminal of one coil produces a voltage that is sensed positively at the undotted terminal of the second coil.

## EXAMPLE 13.1

For the circuit shown in Fig. 13.3, (a) determine  $v_1$  if  $i_2 = 5 \sin 45t$  A and  $i_1 = 0$ ; (b) determine  $v_2$  if  $i_1 = -8e^{-t}$  A and  $i_2 = 0$ .

(a) Since the current  $i_2$  is entering the *undotted* terminal of the right coil, the positive reference for the voltage induced across the left coil is the undotted terminal. Thus, we have an open-circuit voltage

$$v_1 = -(2)(45)(5 \cos 45t) = -450 \cos 45t \quad \text{V}$$

appearing across the terminals of the left coil as a result of the time-varying magnetic flux generated by  $i_2$  flowing into the right coil.

(Continued on next page)

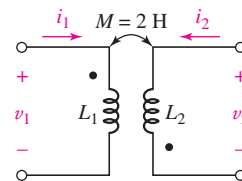

■ FIGURE 13.3 The dot convention provides a relationship between the terminal at which a current enters one coil, and the positive voltage reference for the other coil.

Since no current flows through the coil on the left, there is no contribution to  $v_1$  from self-induction.

(b) We now have a current entering a *dotted* terminal, but  $v_2$  has its positive reference at the *undotted* terminal. Thus,

$$v_2 = -(2)(-1)(-8e^{-t}) = -16e^{-t} \quad \text{V}$$

### PRACTICE

13.1 Assuming  $M = 10$  H, coil  $L_2$  is open-circuited, and  $i_1 = -2e^{-5t}$  A, find the voltage  $v_2$  for (a) Fig. 13.2a; (b) Fig. 13.2b.

Ans:  $100e^{-5t}$  V;  $-100e^{-5t}$  V.

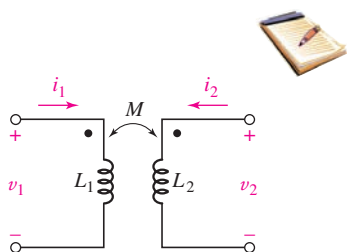

FIGURE 13.4 Since the pairs  $v_1, i_1$  and  $v_2, i_2$  each satisfy the passive sign convention, the voltages of self-induction are both positive; since  $i_1$  and  $i_2$  each enter dotted terminals, and since  $v_1$  and  $v_2$  are both positively sensed at the dotted terminals, the voltages of mutual induction are also both positive.

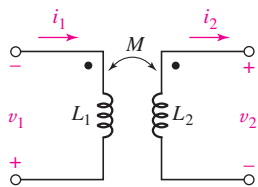

FIGURE 13.5 Since the pairs  $v_1, i_1$  and  $v_2, i_2$  are not sensed according to the passive sign convention, the voltages of self-induction are both negative; since  $i_1$  enters the dotted terminal and  $v_2$  is positively sensed at the dotted terminal, the mutual term of  $v_2$  is positive; and since  $i_2$  enters the undotted terminal and  $v_1$  is positively sensed at the undotted terminal, the mutual term of  $v_1$  is also positive.

## Combined Mutual and Self-Induction Voltage

So far, we have considered only a mutual voltage present across an *open-circuited* coil. In general, a nonzero current will be flowing in each of the two coils, and a mutual voltage will be produced in each coil because of the current flowing in the other coil. *This mutual voltage is present independently of and in addition to any voltage of self-induction.* In other words, the voltage across the terminals of  $L_1$  will be composed of two terms,  $L_1 di_1/dt$  and  $M di_2/dt$ , each carrying a sign depending on the current directions, the assumed voltage sense, and the placement of the two dots. In the portion of a circuit drawn in Fig. 13.4, currents  $i_1$  and  $i_2$  are shown, each entering a dotted terminal. The voltage across  $L_1$  is thus composed of two parts,

$$v_1 = L_1 \frac{di_1}{dt} + M \frac{di_2}{dt}$$

as is the voltage across  $L_2$ ,

$$v_2 = L_2 \frac{di_2}{dt} + M \frac{di_1}{dt}$$

In Fig. 13.5 the currents and voltages are not selected with the object of obtaining all positive terms for  $v_1$  and  $v_2$ . By inspecting only the reference symbols for  $i_1$  and  $v_1$ , it is apparent that the passive sign convention is not satisfied and the sign of  $L_1 di_1/dt$  must therefore be negative. An identical conclusion is reached for the term  $L_2 di_2/dt$ . The mutual term of  $v_2$  is signed by inspecting the direction of  $i_1$  and  $v_2$ ; since  $i_1$  enters the dotted terminal and  $v_2$  is sensed positive at the dotted terminal, the sign of  $M di_1/dt$  must be positive. Finally,  $i_2$  enters the undotted terminal of  $L_2$ , and  $v_1$  is sensed positive at the undotted terminal of  $L_1$ ; hence, the mutual portion of  $v_1$ ,  $M di_2/dt$ , must also be positive. Thus, we have

$$v_1 = -L_1 \frac{di_1}{dt} + M \frac{di_2}{dt} \quad v_2 = -L_2 \frac{di_2}{dt} + M \frac{di_1}{dt}$$

The same considerations lead to identical choices of signs for excitation by a sinusoidal source operating at frequency  $\omega$

$$\mathbf{V}_1 = -j\omega L_1 \mathbf{I}_1 + j\omega M \mathbf{I}_2 \quad \mathbf{V}_2 = -j\omega L_2 \mathbf{I}_2 + j\omega M \mathbf{I}_1$$

## Physical Basis of the Dot Convention

We can gain a more complete understanding of the dot symbolism by looking at the physical basis for the convention; the meaning of the dots is now interpreted in terms of *magnetic flux*. Two coils are shown wound on a cylindrical form in Fig. 13.6, and the direction of each winding is evident. Let us assume that the current  $i_1$  is positive and increasing with time. The magnetic flux that  $i_1$  produces within the form has a direction which may be found by the right-hand rule: when the right hand is wrapped around the coil with the fingers pointing in the direction of current flow, the thumb indicates the direction of the flux within the coil. Thus  $i_1$  produces a flux which is directed downward; since  $i_1$  is increasing with time, the flux, which is proportional to  $i_1$ , is also increasing with time. Turning now to the second coil, let us also think of  $i_2$  as positive and increasing; the application of the right-hand rule shows that  $i_2$  also produces a magnetic flux which is directed downward and is increasing. In other words, the assumed currents  $i_1$  and  $i_2$  produce *additive* fluxes.

The voltage across the terminals of any coil results from the time rate of change of the flux within that coil. The voltage across the terminals of the first coil is therefore greater with  $i_2$  flowing than it would be if  $i_2$  were zero;  $i_2$  induces a voltage in the first coil which has the same sense as the self-induced voltage in that coil. The sign of the self-induced voltage is known from the passive sign convention, and the sign of the mutual voltage is thus obtained.

The dot convention enables us to suppress the physical construction of the coils by placing a dot at one terminal of each coil such that currents entering dot-marked terminals produce additive fluxes. It is apparent that there are always two possible locations for the dots, because both dots may always be moved to the other ends of the coils and additive fluxes will still result.

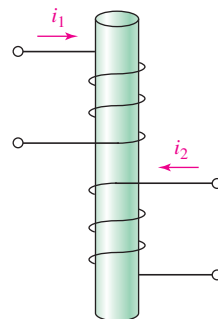

■ FIGURE 13.6 The physical construction of two mutually coupled coils. From a consideration of the direction of magnetic flux produced by each coil, it is shown that dots may be placed either on the upper terminal of each coil or on the lower terminal of each coil.

## EXAMPLE 13.2

For the circuit shown in Fig. 13.7a, find the ratio of the output voltage across the  $400\ \Omega$  resistor to the source voltage, expressed using phasor notation.

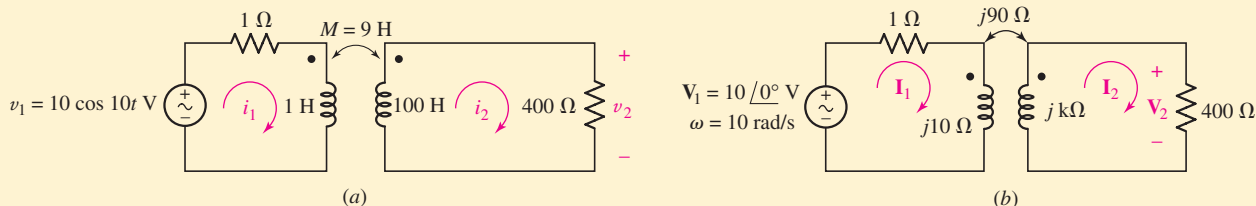

■ FIGURE 13.7 (a) A circuit containing mutual inductance in which the voltage ratio  $V_2/V_1$  is desired. (b) Self- and mutual inductances are replaced by the corresponding impedances.

### ► Identify the goal of the problem.

We need a numerical value for  $V_2$ . We will then divide by  $10/0^\circ$  V.

### ► Collect the known information.

We begin by replacing the 1 H and 100 H inductances by their corresponding impedances,  $j10\ \Omega$  and  $j\text{ k}\Omega$ , respectively (Fig. 13.7b). We also replace the 9 H mutual inductance by  $j\omega M = j90\ \Omega$ .

(Continued on next page)

► **Devise a plan.**

Mesh analysis is likely to be a good approach, as we have a circuit with two clearly defined meshes. Once we find  $\mathbf{I}_2$ ,  $\mathbf{V}_2$  is simply  $400\mathbf{I}_2$ .

► **Construct an appropriate set of equations.**

In the left mesh, the sign of the mutual term is determined by applying the dot convention. Since  $\mathbf{I}_2$  enters the undotted terminal of  $L_2$ , the mutual voltage across  $L_1$  must have the positive reference at the undotted terminal. Thus,

$$(1 + j10)\mathbf{I}_1 - j90\mathbf{I}_2 = 10\angle 0^\circ$$

Since  $\mathbf{I}_1$  enters the dot-marked terminal, the mutual term in the right mesh has its (+) reference at the dotted terminal of the 100 H inductor. Therefore, we may write

$$(400 + j1000)\mathbf{I}_2 - j90\mathbf{I}_1 = 0$$

► **Determine if additional information is required.**

We have two equations in two unknowns,  $\mathbf{I}_1$  and  $\mathbf{I}_2$ . Once we solve for the two currents, the output voltage  $\mathbf{V}_2$  may be obtained by multiplying  $\mathbf{I}_2$  by  $400\ \Omega$ .

► **Attempt a solution.**

Upon solving these two equations with a scientific calculator, we find that

$$\mathbf{I}_2 = 0.172\angle -16.70^\circ\ \text{A}$$

Thus,

$$\begin{aligned} \frac{\mathbf{V}_2}{\mathbf{V}_1} &= \frac{400(0.172\angle -16.70^\circ)}{10\angle 0^\circ} \\ &= 6.880\angle -16.70^\circ \end{aligned}$$

► **Verify the solution. Is it reasonable or expected?**

We note that the output voltage  $\mathbf{V}_2$  is actually larger in magnitude than the input voltage  $\mathbf{V}_1$ . Should we always expect this result? The answer is no. As we will see in later sections, the transformer can be constructed to achieve *either* a reduction *or* an increase in the voltage. We can perform a quick estimate, however, and at least find an upper and lower bound for our answer. If the  $400\ \Omega$  resistor is replaced with a short circuit,  $\mathbf{V}_2 = 0$ . If instead we replace the  $400\ \Omega$  resistor with an open circuit,  $\mathbf{I}_2 = 0$  and hence

$$\mathbf{V}_1 = (1 + j\omega L_1)\mathbf{I}_1$$

and

$$\mathbf{V}_2 = j\omega M\mathbf{I}_1$$

Solving, we find that the maximum value we could expect for  $\mathbf{V}_2/\mathbf{V}_1$  is  $8.955\angle 5.711^\circ$ . Thus, our answer at least appears reasonable.

The output voltage of the circuit in Fig. 13.7a is greater in magnitude than the input voltage, so that a voltage gain is possible with this type of circuit. It is also interesting to consider this voltage ratio as a function of  $\omega$ .

To find  $\mathbf{I}_2(j\omega)$  for this particular circuit, we write the mesh equations in terms of an unspecified angular frequency  $\omega$ :

$$(1 + j\omega)\mathbf{I}_1 \qquad -j\omega 9\mathbf{I}_2 = 10\angle 0^\circ$$

and

$$-j\omega 9\mathbf{I}_1 + (400 + j\omega 100)\mathbf{I}_2 = 0$$

Solving by substitution, we find that

$$\mathbf{I}_2 = \frac{j90\omega}{400 + j500\omega - 19\omega^2}$$

Thus, we obtain the ratio of output voltage to input voltage as a function of frequency  $\omega$

$$\begin{aligned} \frac{\mathbf{V}_2}{\mathbf{V}_1} &= \frac{400\mathbf{I}_2}{10} \\ &= \frac{j\omega 3600}{400 + j500\omega - 19\omega^2} \end{aligned}$$

The magnitude of this ratio, sometimes referred to as the *circuit transfer function*, is plotted in Fig. 13.8 and has a peak magnitude of approximately

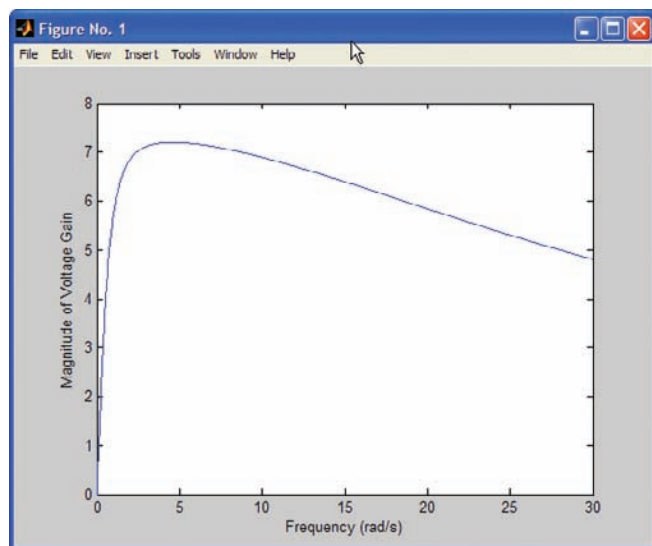

■ FIGURE 13.8 The voltage gain  $|\mathbf{V}_2/\mathbf{V}_1|$  of the circuit shown in Fig. 13.7a is plotted as a function of  $\omega$  using the following MATLAB script:

```
>> w = linspace(0,30,1000);
>> num = j*w*3600;
>> for indx = 1:1000
den = 400 + j*500*w(indx) - 19*w(indx)*w(indx);
gain(indx) = num(indx)/den;
end
>> plot(w, abs(gain));
>> xlabel('Frequency (rad/s)');
>> ylabel('Magnitude of Voltage Gain');
```

7 near a frequency of 4.6 rad/s. However, for very small or very large frequencies, the magnitude of the transfer function is less than unity.

The circuit is still passive, except for the voltage source, and the *voltage gain* must not be mistakenly interpreted as a *power gain*. At  $\omega = 10$  rad/s, the voltage gain is 6.88, but the ideal voltage source, having a terminal voltage of 10 V, delivers a total power of 8.07 W, of which only 5.94 W reaches the 400  $\Omega$  resistor. The ratio of the output power to the source power, which we may define as the *power gain*, is thus 0.736.

### PRACTICE

13.2 For the circuit of Fig. 13.9, write appropriate mesh equations for the left mesh and the right mesh if  $v_s = 20e^{-1000t}$  V.

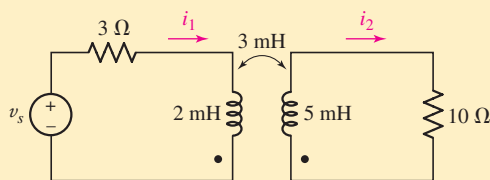
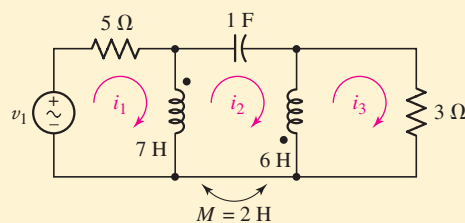

FIGURE 13.9

Ans:  $20e^{-1000t} = 3i_1 + 0.002 di_1/dt - 0.003 di_2/dt$ ;  $10i_2 + 0.005 di_2/dt - 0.003 di_1/dt = 0$ .

### EXAMPLE 13.3

Write a complete set of phasor mesh equations for the circuit of Fig. 13.10a.



(a)

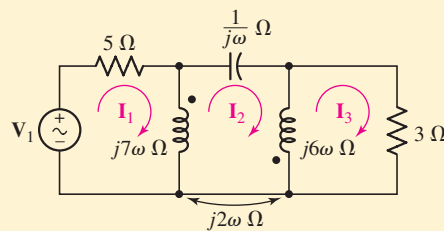

(b)

FIGURE 13.10 (a) A three-mesh circuit with mutual coupling. (b) The 1 F capacitance as well as the self- and mutual inductances are replaced by their corresponding impedances.

Once again, our first step is to replace both the mutual inductance and the two self-inductances with their corresponding impedances as shown in Fig. 13.10*b*. Applying Kirchhoff's voltage law to the first mesh, a positive sign for the mutual term is ensured by selecting  $(\mathbf{I}_3 - \mathbf{I}_2)$  as the current through the second coil. Thus,

$$5\mathbf{I}_1 + 7j\omega(\mathbf{I}_1 - \mathbf{I}_2) + 2j\omega(\mathbf{I}_3 - \mathbf{I}_2) = \mathbf{V}_1$$

or

$$(5 + 7j\omega)\mathbf{I}_1 - 9j\omega\mathbf{I}_2 + 2j\omega\mathbf{I}_3 = \mathbf{V}_1 \quad [3]$$

The second mesh requires two self-inductance terms and two mutual inductance terms. Paying close attention to dots, we obtain

$$7j\omega(\mathbf{I}_2 - \mathbf{I}_1) + 2j\omega(\mathbf{I}_2 - \mathbf{I}_3) + \frac{1}{j\omega}\mathbf{I}_2 + 6j\omega(\mathbf{I}_2 - \mathbf{I}_3) + 2j\omega(\mathbf{I}_2 - \mathbf{I}_1) = 0$$

or

$$-9j\omega\mathbf{I}_1 + \left(17j\omega + \frac{1}{j\omega}\right)\mathbf{I}_2 - 8j\omega\mathbf{I}_3 = 0 \quad [4]$$

Finally, for the third mesh,

$$6j\omega(\mathbf{I}_3 - \mathbf{I}_2) + 2j\omega(\mathbf{I}_1 - \mathbf{I}_2) + 3\mathbf{I}_3 = 0$$

or

$$2j\omega\mathbf{I}_1 - 8j\omega\mathbf{I}_2 + (3 + 6j\omega)\mathbf{I}_3 = 0 \quad [5]$$

Equations [3] to [5] may be solved by any of the conventional methods.

## PRACTICE

13.3 For the circuit of Fig. 13.11, write an appropriate mesh equation in terms of the phasor currents  $\mathbf{I}_1$  and  $\mathbf{I}_2$  for the (a) left mesh; (b) right mesh.

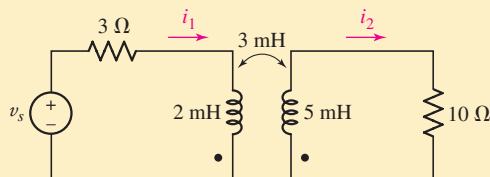
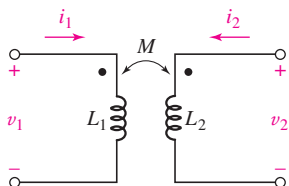

FIGURE 13.11

Ans:  $\mathbf{V}_s = (3 + j10)\mathbf{I}_1 - j15\mathbf{I}_2$ ;  $0 = -j15\mathbf{I}_1 + (10 + j25)\mathbf{I}_2$ .

## 13.2 ENERGY CONSIDERATIONS

Let us now consider the energy stored in a pair of mutually coupled inductors. The results will be useful in several different ways. We will first justify our assumption that  $M_{12} = M_{21}$ , and we may then determine the maximum possible value of the mutual inductance between two given inductors.



■ FIGURE 13.12 A pair of coupled coils with a mutual inductance of  $M_{12} = M_{21} = M$ .

### Equality of $M_{12}$ and $M_{21}$

The pair of coupled coils shown in Fig. 13.12 has currents, voltages, and polarity dots indicated. In order to show that  $M_{12} = M_{21}$  we begin by letting all currents and voltages be zero, thus establishing zero initial energy storage in the network. We then open-circuit the right-hand terminal pair and increase  $i_1$  from zero to some constant (dc) value  $I_1$  at time  $t = t_1$ . The power entering the network from the left at any instant is

$$v_1 i_1 = L_1 \frac{di_1}{dt} i_1$$

and the power entering from the right is

$$v_2 i_2 = 0$$

since  $i_2 = 0$ .

The energy stored within the network when  $i_1 = I_1$  is thus

$$\int_0^{t_1} v_1 i_1 dt = \int_0^{I_1} L_1 i_1 di_1 = \frac{1}{2} L_1 I_1^2$$

We now hold  $i_1$  constant ( $i_1 = I_1$ ), and we let  $i_2$  change from zero at  $t = t_1$  to some constant value  $I_2$  at  $t = t_2$ . The energy delivered from the right-hand source is thus

$$\int_{t_1}^{t_2} v_2 i_2 dt = \int_0^{I_2} L_2 i_2 di_2 = \frac{1}{2} L_2 I_2^2$$

However, even though the value of  $i_1$  remains constant, the left-hand source also delivers energy to the network during this time interval:

$$\int_{t_1}^{t_2} v_1 i_1 dt = \int_{t_1}^{t_2} M_{12} \frac{di_2}{dt} i_1 dt = M_{12} I_1 \int_0^{I_2} di_2 = M_{12} I_1 I_2$$

The total energy stored in the network when both  $i_1$  and  $i_2$  have reached constant values is

$$W_{\text{total}} = \frac{1}{2} L_1 I_1^2 + \frac{1}{2} L_2 I_2^2 + M_{12} I_1 I_2$$

Now, we may establish the same final currents in this network by allowing the currents to reach their final values in the reverse order, that is, first increasing  $i_2$  from zero to  $I_2$  and then holding  $i_2$  constant while  $i_1$  increases from zero to  $I_1$ . If the total energy stored is calculated for this experiment, the result is found to be

$$W_{\text{total}} = \frac{1}{2} L_1 I_1^2 + \frac{1}{2} L_2 I_2^2 + M_{21} I_1 I_2$$

The only difference is the interchange of the mutual inductances  $M_{21}$  and  $M_{12}$ . The initial and final conditions in the network are the same, however, and so the two values of the stored energy must be identical. Thus,

$$M_{12} = M_{21} = M$$

and

$$W = \frac{1}{2} L_1 I_1^2 + \frac{1}{2} L_2 I_2^2 + M I_1 I_2 \quad [6]$$



If one current enters a dot-marked terminal while the other leaves a dot-marked terminal, the sign of the mutual energy term is reversed:

$$W = \frac{1}{2}L_1I_1^2 + \frac{1}{2}L_2I_2^2 - MI_1I_2 \quad [7]$$

Although Eqs. [6] and [7] were derived by treating the final values of the two currents as constants, these “constants” can have any value, and the energy expressions correctly represent the energy stored when the *instantaneous* values of  $i_1$  and  $i_2$  are  $I_1$  and  $I_2$ , respectively. In other words, lower-case symbols might just as well be used:

$$w(t) = \frac{1}{2}L_1 [i_1(t)]^2 + \frac{1}{2}L_2 [i_2(t)]^2 \pm M [i_1(t)] [i_2(t)] \quad [8]$$

The only assumption upon which Eq. [8] is based is the logical establishment of a zero-energy reference level when both currents are zero.

### Establishing an Upper Limit for $M$

Equation [8] may now be used to establish an upper limit for the value of  $M$ . Since  $w(t)$  represents the energy stored within a *passive* network, it cannot be negative for any values of  $i_1$ ,  $i_2$ ,  $L_1$ ,  $L_2$ , or  $M$ . Let us assume first that  $i_1$  and  $i_2$  are either both positive or both negative; their product is therefore positive. From Eq. [8], the only case in which the energy could possibly be negative is

$$w = \frac{1}{2}L_1i_1^2 + \frac{1}{2}L_2i_2^2 - Mi_1i_2$$

which we may write, by completing the square, as

$$w = \frac{1}{2}(\sqrt{L_1}i_1 - \sqrt{L_2}i_2)^2 + \sqrt{L_1L_2}i_1i_2 - Mi_1i_2$$

Since in reality the energy cannot be negative, the right-hand side of this equation cannot be negative. The first term, however, may be as small as zero, so we have the restriction that the sum of the last two terms cannot be negative. Hence,

$$\sqrt{L_1L_2} \geq M$$

or

$$M \leq \sqrt{L_1L_2} \quad [9]$$

There is, therefore, an upper limit to the possible magnitude of the mutual inductance; it can be no larger than the geometric mean of the inductances of the two coils between which the mutual inductance exists. Although we have derived this inequality on the assumption that  $i_1$  and  $i_2$  carried the same algebraic sign, a similar development is possible if the signs are opposite; it is necessary only to select the positive sign in Eq. [8].

We might also have demonstrated the truth of inequality [9] from a physical consideration of the magnetic coupling; if we think of  $i_2$  as being zero and the current  $i_1$  as establishing the magnetic flux linking both  $L_1$  and  $L_2$ , it is apparent that the flux within  $L_2$  cannot be greater than the flux within  $L_1$ , which represents the total flux. Qualitatively, then, there is an upper limit to the magnitude of the mutual inductance possible between two given inductors.

## The Coupling Coefficient

The degree to which  $M$  approaches its maximum value is described by the *coupling coefficient*, defined as

$$k = \frac{M}{\sqrt{L_1 L_2}} \quad [10]$$

Since  $M \leq \sqrt{L_1 L_2}$ ,

$$0 \leq k \leq 1$$



The larger values of the coefficient of coupling are obtained with coils which are physically closer, which are wound or oriented to provide a larger common magnetic flux, or which are provided with a common path through a material which serves to concentrate and localize the magnetic flux (a high-permeability material). Coils having a coefficient of coupling close to unity are said to be *tightly coupled*.

### EXAMPLE 13.4

In Fig. 13.13, let  $L_1 = 0.4$  H,  $L_2 = 2.5$  H,  $k = 0.6$ , and  $i_1 = 4i_2 = 20 \cos(500t - 20^\circ)$  mA. Determine both  $v_1(0)$  and the total energy stored in the system at  $t = 0$ .

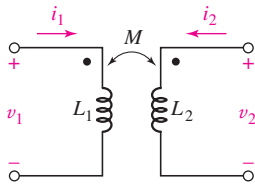

FIGURE 13.13 Two coils with a coupling coefficient of 0.6,  $L_1 = 0.4$  H and  $L_2 = 2.5$  H.

In order to determine the value of  $v_1$ , we need to include the contributions from both the self-inductance of coil 1 and the mutual inductance. Thus, paying attention to the dot convention,

$$v_1(t) = L_1 \frac{di_1}{dt} + M \frac{di_2}{dt}$$

To evaluate this quantity, we require a value for  $M$ . This is obtained from Eq. [10],

$$M = k\sqrt{L_1 L_2} = 0.6\sqrt{(0.4)(2.5)} = 0.6$$
 H

Thus,  $v_1(0) = 0.4[-10 \sin(-20^\circ)] + 0.6[-2.5 \sin(-20^\circ)] = 1.881$  V.

The total energy is found by summing the energy stored in each inductor, which has three separate components since the two coils are known to be magnetically coupled. Since both currents enter a “dotted” terminal,

$$w(t) = \frac{1}{2}L_1[i_1(t)]^2 + \frac{1}{2}L_2[i_2(t)]^2 + M[i_1(t)][i_2(t)]$$

Since  $i_1(0) = 20 \cos(-20^\circ) = 18.79$  mA and  $i_2(0) = 0.25i_1(0) = 4.698$  mA, we find that the total energy stored in the two coils at  $t = 0$  is  $151.2$   $\mu$ J.

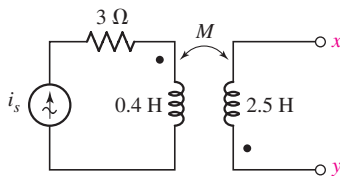

FIGURE 13.14

### PRACTICE

13.4 Let  $i_s = 2 \cos 10t$  A in the circuit of Fig. 13.14, and find the total energy stored in the passive network at  $t = 0$  if  $k = 0.6$  and terminals  $x$  and  $y$  are (a) left open-circuited; (b) short-circuited.

Ans: 0.8 J; 0.512 J.

### 13.3 THE LINEAR TRANSFORMER

We are now ready to apply our knowledge of magnetic coupling to the description of two specific practical devices, each of which may be represented by a model containing mutual inductance. Both of the devices are transformers, a term which we define as a network containing two or more coils which are deliberately coupled magnetically (Fig. 13.15). In this section we consider the linear transformer, which happens to be an excellent model for devices used at radio frequencies, or higher frequencies. In Sec. 13.4 we will consider the ideal transformer, which is an idealized unity-coupled model of a physical transformer that has a core made of some magnetic material, usually an iron alloy.



■ FIGURE 13.15 A selection of small transformers for use in electronic applications; the AA battery is shown for scale only.

In Fig. 13.16 a transformer is shown with two mesh currents identified. The first mesh, usually containing the source, is called the *primary*, while the second mesh, usually containing the load, is known as the *secondary*. The inductors labeled  $L_1$  and  $L_2$  are also referred to as the primary and secondary, respectively, of the transformer. We will assume that the transformer is *linear*. This implies that no magnetic material (which may cause a *nonlinear* flux-versus-current relationship) is employed. Without such material, however, it is difficult to achieve a coupling coefficient greater than a few tenths. The two resistors serve to account for the resistance of the wire of which the primary and secondary coils are wound, and any other losses.

#### Reflected Impedance

Consider the input impedance offered at the terminals of the primary circuit. The two mesh equations are

$$\mathbf{V}_s = (R_1 + j\omega L_1)\mathbf{I}_1 - j\omega M\mathbf{I}_2 \quad [11]$$

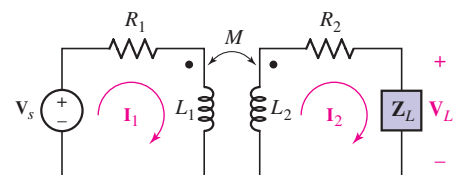

■ FIGURE 13.16 A linear transformer containing a source in the primary circuit and a load in the secondary circuit. Resistance is also included in both the primary and the secondary.

and

$$0 = -j\omega M \mathbf{I}_1 + (R_2 + j\omega L_2 + \mathbf{Z}_L) \mathbf{I}_2 \quad [12]$$

We may simplify by defining

$$\mathbf{Z}_{11} = R_1 + j\omega L_1 \quad \text{and} \quad \mathbf{Z}_{22} = R_2 + j\omega L_2 + \mathbf{Z}_L$$

so that

$$\mathbf{V}_s = \mathbf{Z}_{11} \mathbf{I}_1 - j\omega M \mathbf{I}_2 \quad [13]$$

$$0 = -j\omega M \mathbf{I}_1 + \mathbf{Z}_{22} \mathbf{I}_2 \quad [14]$$

Solving the second equation for  $\mathbf{I}_2$  and inserting the result in the first equation enable us to find the input impedance,

$$\mathbf{Z}_{\text{in}} = \frac{\mathbf{V}_s}{\mathbf{I}_1} = \mathbf{Z}_{11} - \frac{(j\omega)^2 M^2}{\mathbf{Z}_{22}} \quad [15]$$

$\mathbf{Z}_{\text{in}}$  is the impedance seen looking into the primary coil of the transformer.

Before manipulating this expression any further, we can draw several exciting conclusions. In the first place, this result is independent of the location of the dots on either winding, for if either dot is moved to the other end of the coil, the result is a change in sign of each term involving  $M$  in Eqs. [11] to [14]. This same effect could be obtained by replacing  $M$  by  $(-M)$ , and such a change cannot affect the input impedance, as Eq. [15] demonstrates. We also may note in Eq. [15] that the input impedance is simply  $\mathbf{Z}_{11}$  if the coupling is reduced to zero. As the coupling is increased from zero, the input impedance differs from  $\mathbf{Z}_{11}$  by an amount  $\omega^2 M^2 / \mathbf{Z}_{22}$ , termed the **reflected impedance**. The nature of this change is more evident if we expand this expression

$$\mathbf{Z}_{\text{in}} = \mathbf{Z}_{11} + \frac{\omega^2 M^2}{R_{22} + jX_{22}}$$

and rationalize the reflected impedance,

$$\mathbf{Z}_{\text{in}} = \mathbf{Z}_{11} + \frac{\omega^2 M^2 R_{22}}{R_{22}^2 + X_{22}^2} + \frac{-j\omega^2 M^2 X_{22}}{R_{22}^2 + X_{22}^2}$$

Since  $\omega^2 M^2 R_{22} / (R_{22}^2 + X_{22}^2)$  must be positive, it is evident that the presence of the secondary increases the losses in the primary circuit. In other words, the presence of the secondary might be accounted for in the primary circuit by increasing the value of  $R_1$ . Moreover, the reactance which the secondary reflects into the primary circuit has a sign which is opposite to that of  $X_{22}$ , the net reactance around the secondary loop. This reactance  $X_{22}$  is the sum of  $\omega L_2$  and  $X_L$ ; it is necessarily positive for inductive loads and either positive or negative for capacitive loads, depending on the magnitude of the load reactance.

### PRACTICE

13.5 Element values for a certain linear transformer are  $R_1 = 3 \Omega$ ,  $R_2 = 6 \Omega$ ,  $L_1 = 2 \text{ mH}$ ,  $L_2 = 10 \text{ mH}$ , and  $M = 4 \text{ mH}$ . If  $\omega = 5000 \text{ rad/s}$ , find  $\mathbf{Z}_{\text{in}}$  for  $\mathbf{Z}_L$  equal to (a)  $10 \Omega$ ; (b)  $j20 \Omega$ ; (c)  $10 + j20 \Omega$ ; (d)  $-j20 \Omega$ .

Ans:  $5.32 + j2.74 \Omega$ ;  $3.49 + j4.33 \Omega$ ;  $4.24 + j4.57 \Omega$ ;  $5.56 - j2.82 \Omega$ .

## T and $\Pi$ Equivalent Networks

It is often convenient to replace a transformer with an equivalent network in the form of a T or  $\Pi$ . If we separate the primary and secondary resistances from the transformer, only the pair of mutually coupled inductors remains, as shown in Fig. 13.17. Note that the two lower terminals of the transformer are connected together to form a three-terminal network. We do this because both of our equivalent networks are also three-terminal networks. The differential equations describing this circuit are, once again,

$$v_1 = L_1 \frac{di_1}{dt} + M \frac{di_2}{dt} \quad [16]$$

and

$$v_2 = M \frac{di_1}{dt} + L_2 \frac{di_2}{dt} \quad [17]$$

The form of these two equations is familiar and may be easily interpreted in terms of mesh analysis. Let us select a clockwise  $i_1$  and a counterclockwise  $i_2$  so that  $i_1$  and  $i_2$  are exactly identifiable with the currents in Fig. 13.17. The terms  $M di_2/dt$  in Eq. [16] and  $M di_1/dt$  in Eq. [17] indicate that the two meshes must then have a common *self*-inductance  $M$ . Since the total inductance around the left-hand mesh is  $L_1$ , a self-inductance of  $L_1 - M$  must be inserted in the first mesh, but not in the second mesh. Similarly, a self-inductance of  $L_2 - M$  is required in the second mesh, but not in the first mesh. The resultant equivalent network is shown in Fig. 13.18. The equivalence is guaranteed by the identical pairs of equations relating  $v_1$ ,  $i_1$ ,  $v_2$ , and  $i_2$  for the two networks.

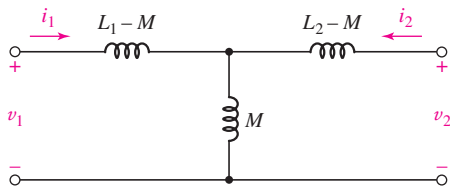

■ FIGURE 13.18 The T equivalent of the transformer shown in Fig. 13.17.

If either of the dots on the windings of the given transformer is placed on the opposite end of its coil, the sign of the mutual terms in Eqs. [16] and [17] will be negative. This is analogous to replacing  $M$  with  $-M$ , and such a replacement in the network of Fig. 13.18 leads to the correct equivalent for this case. (The three self-inductance values would then be  $L_1 + M$ ,  $-M$ , and  $L_2 + M$ .)

The inductances in the T equivalent are all self-inductances; no mutual inductance is present. It is possible that negative values of inductance may be obtained for the equivalent circuit, but this is immaterial if our only desire is a mathematical analysis. There are times when procedures for synthesizing networks to provide a desired transfer function lead to circuits containing a T network having a negative inductance; this network may then be realized by use of an appropriate linear transformer.

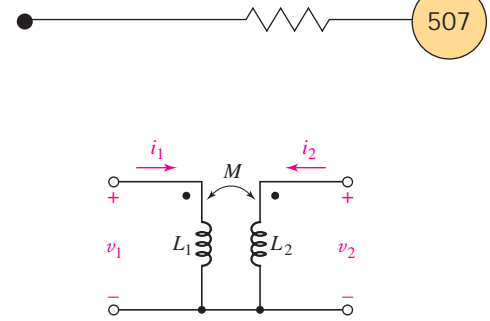

■ FIGURE 13.17 A given transformer which is to be replaced by an equivalent  $\Pi$  or T network.

## EXAMPLE 13.5

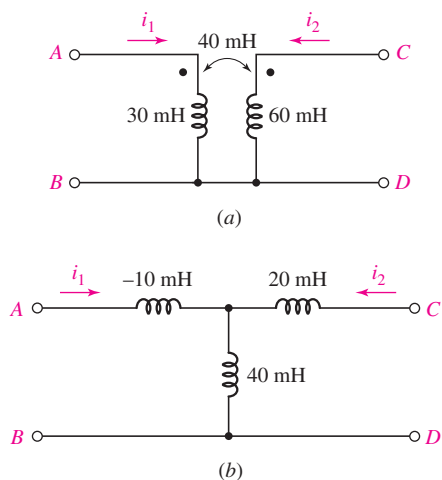

FIGURE 13.19 (a) A linear transformer used as an example. (b) The T-equivalent network of the transformer.

**Find the T equivalent of the linear transformer shown in Fig. 13.19a.**

We identify  $L_1 = 30$  mH,  $L_2 = 60$  mH, and  $M = 40$  mH, and note that the dots are both at the upper terminals, as they are in the basic circuit of Fig. 13.17.

Hence,  $L_1 - M = -10$  mH is in the upper left arm,  $L_2 - M = 20$  mH is at the upper right, and the center stem contains  $M = 40$  mH. The complete equivalent T is shown in Fig. 13.19b.

To demonstrate the equivalence, let us leave terminals C and D open-circuited and apply  $v_{AB} = 10 \cos 100t$  V to the input in Fig. 13.19a. Thus,

$$i_1 = \frac{1}{30 \times 10^{-3}} \int 10 \cos(100t) dt = 3.33 \sin 100t \quad \text{A}$$

and

$$\begin{aligned} v_{CD} &= M \frac{di_1}{dt} = 40 \times 10^{-3} \times 3.33 \times 100 \cos 100t \\ &= 13.33 \cos 100t \quad \text{V} \end{aligned}$$

Applying the same voltage in the T equivalent, we find that

$$i_1 = \frac{1}{(-10 + 40) \times 10^{-3}} \int 10 \cos(100t) dt = 3.33 \sin 100t \quad \text{A}$$

once again. Also, the voltage at C and D is equal to the voltage across the 40 mH inductor. Thus,

$$v_{CD} = 40 \times 10^{-3} \times 3.33 \times 100 \cos 100t = 13.33 \cos 100t \quad \text{V}$$

and the two networks yield equal results.

## PRACTICE

13.6 (a) If the two networks shown in Fig. 13.20 are equivalent, specify values for  $L_x$ ,  $L_y$ , and  $L_z$ . (b) Repeat if the dot on the secondary in Fig. 13.20b is located at the bottom of the coil.

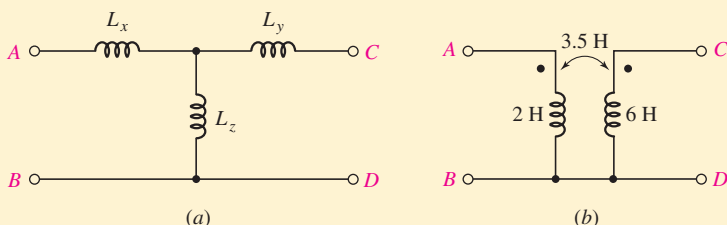

FIGURE 13.20

Ans:  $-1.5, 2.5, 3.5$  H;  $5.5, 9.5, -3.5$  H.

The equivalent  $\Pi$  network is not obtained as easily. It is more complicated, and it is not used as much. We develop it by solving Eq. [17] for  $di_2/dt$  and

substituting the result in Eq. [16]:

$$v_1 = L_1 \frac{di_1}{dt} + \frac{M}{L_2} v_2 - \frac{M^2}{L_2} \frac{di_1}{dt}$$

or

$$\frac{di_1}{dt} = \frac{L_2}{L_1 L_2 - M^2} v_1 - \frac{M}{L_1 L_2 - M^2} v_2$$

If we now integrate from 0 to  $t$ , we obtain

$$i_1 - i_1(0)u(t) = \frac{L_2}{L_1 L_2 - M^2} \int_0^t v_1 dt' - \frac{M}{L_1 L_2 - M^2} \int_0^t v_2 dt' \quad [18]$$

In a similar fashion, we also have

$$i_2 - i_2(0)u(t) = \frac{-M}{L_1 L_2 - M^2} \int_0^t v_1 dt' + \frac{L_1}{L_1 L_2 - M^2} \int_0^t v_2 dt' \quad [19]$$

Equations [18] and [19] may be interpreted as a pair of nodal equations; a step-current source must be installed at each node in order to provide the proper initial conditions. The factors multiplying each integral have the general form of inverses of certain equivalent inductances. Thus, the second coefficient in Eq. [18],  $M/(L_1 L_2 - M^2)$ , is  $1/L_B$ , or the reciprocal of the inductance extending between nodes 1 and 2, as shown on the equivalent  $\Pi$  network, Fig. 13.21. So

$$L_B = \frac{L_1 L_2 - M^2}{M}$$

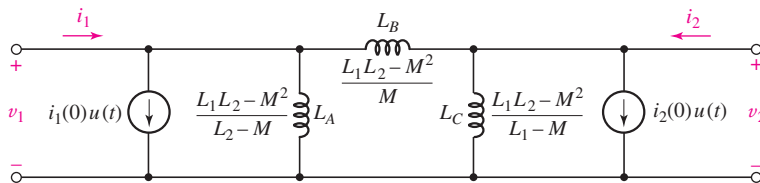

■ FIGURE 13.21 The  $\Pi$  network which is equivalent to the transformer shown in Fig. 13.17.

The first coefficient in Eq. [18],  $L_2/(L_1 L_2 - M^2)$ , is  $1/L_A + 1/L_B$ . Thus,

$$\frac{1}{L_A} = \frac{L_2}{L_1 L_2 - M^2} - \frac{M}{L_1 L_2 - M^2}$$

or

$$L_A = \frac{L_1 L_2 - M^2}{L_2 - M}$$

Finally,

$$L_C = \frac{L_1 L_2 - M^2}{L_1 - M}$$

No magnetic coupling is present among the inductors in the equivalent  $\Pi$ , and the initial currents in the three *self-inductances* are zero.

We may compensate for a reversal of either dot in the given transformer by merely changing the sign of  $M$  in the equivalent network. Also, just as we found in the equivalent T, negative self-inductances may appear in the equivalent  $\Pi$  network.

## EXAMPLE 13.6

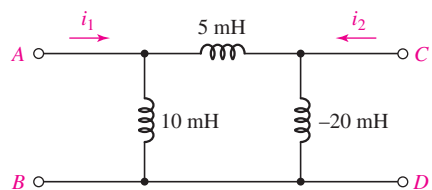

FIGURE 13.22 The  $\Pi$  equivalent of the linear transformer shown in Fig. 13.19a. It is assumed that  $i_1(0) = 0$  and  $i_2(0) = 0$ .

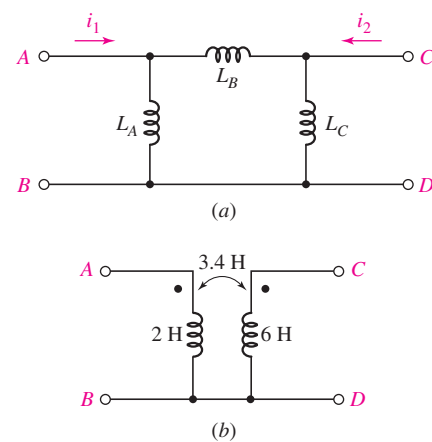

FIGURE 13.23

Find the equivalent  $\Pi$  network of the transformer in Fig. 13.19a, assuming zero initial currents.

Since the term  $L_1L_2 - M^2$  is common to  $L_A$ ,  $L_B$ , and  $L_C$ , we begin by evaluating this quantity, obtaining

$$30 \times 10^{-3} \times 60 \times 10^{-3} - (40 \times 10^{-3})^2 = 2 \times 10^{-4} \text{ H}^2$$

Thus,

$$L_A = \frac{L_1L_2 - M^2}{L_2 - M} = \frac{2 \times 10^{-4}}{20 \times 10^{-3}} = 10 \text{ mH}$$

$$L_C = \frac{L_1L_2 - M^2}{L_1 - M} = -20 \text{ mH}$$

and

$$L_B = \frac{L_1L_2 - M^2}{M} = 5 \text{ mH}$$

The equivalent  $\Pi$  network is shown in Fig. 13.22.

If we again check our result by letting  $v_{AB} = 10 \cos 100t$  V with terminals  $C$ - $D$  open-circuited, the output voltage is quickly obtained by voltage division:

$$v_{CD} = \frac{-20 \times 10^{-3}}{5 \times 10^{-3} - 20 \times 10^{-3}} 10 \cos 100t = 13.33 \cos 100t \text{ V}$$

as before. Thus, the network in Fig. 13.22 is electrically equivalent to the networks in Fig. 13.19a and b.

## PRACTICE

13.7 If the networks in Fig. 13.23 are equivalent, specify values (in mH) for  $L_A$ ,  $L_B$ , and  $L_C$ .

Ans:  $L_A = 169.2$  mH,  $L_B = 129.4$  mH,  $L_C = -314.3$  mH.

## COMPUTER-AIDED ANALYSIS

The ability to simulate circuits that contain magnetically coupled inductances is a useful skill, especially with circuit dimensions continuing to decrease. As various loops and partial loops of conductors are brought closer in new designs, various circuits and subcircuits that are intended to be isolated from one another inadvertently become coupled through stray magnetic fields, and interact with one another. PSpice allows us to incorporate this effect through the component **K\_Linear**, which links a pair of inductors in the schematic by a coupling coefficient  $k$  in the range of  $0 \leq k \leq 1$ .

For example, consider the circuit of Fig. 13.19a, which consists of two coils whose coupling is described by a mutual inductance of  $M = 40$  mH, corresponding to a coupling coefficient of  $k = 0.9428$ . The basic circuit schematic is shown in Fig. 13.24a. Note that when first



placed horizontally in the schematic, the dotted terminal is on the left, and this is the pin about which the symbol is rotated. Also note that the **K\_Linear** component is not “wired” into the schematic anywhere; its location is arbitrary. The two coupled inductors, **L1** and **L2**, are specified along with the coupling coefficient through the Property Editor (Fig 13.24b).

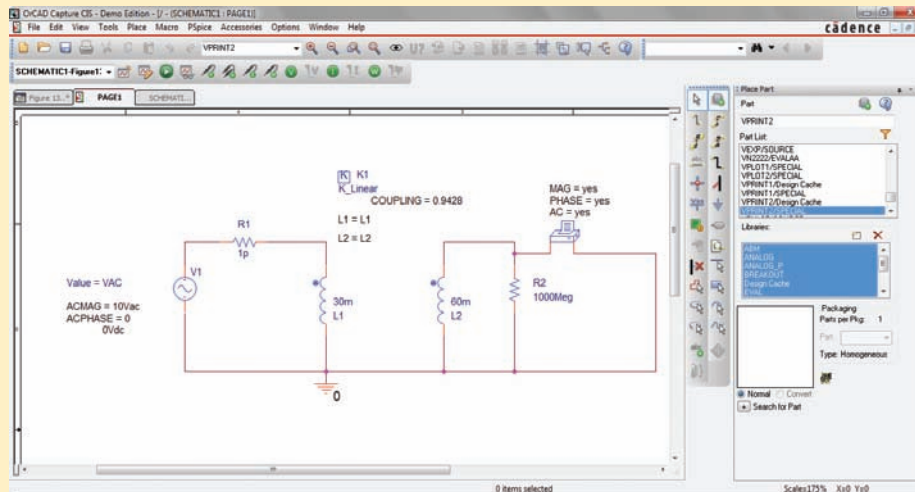

(a)

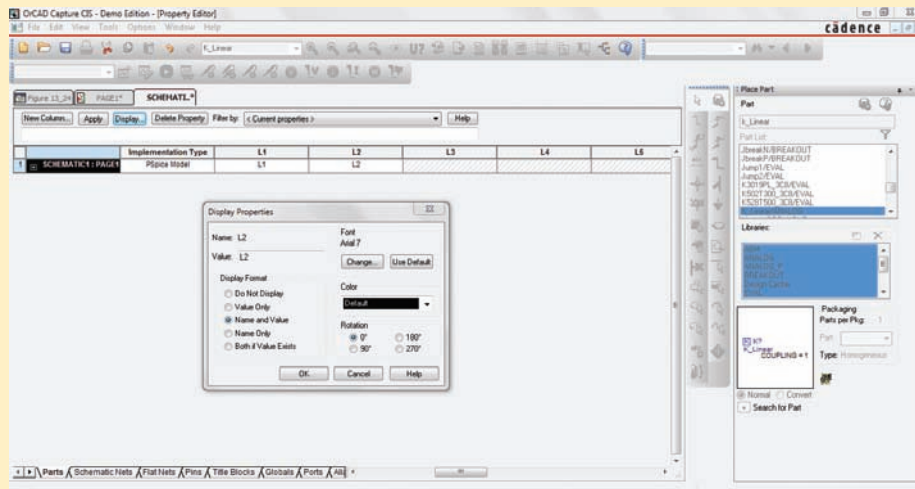

(b)

■ FIGURE 13.24 (a) The circuit of Fig. 13.19a, modified to meet simulation requirements. (b) Property Editor dialog box showing how various inductors to be linked are named.

The circuit is connected to a 100 rad/s (15.92 Hz) sinusoidal voltage source, a fact which is incorporated by performing a single-frequency ac sweep. It is also necessary to add two resistors to the schematic in order for PSpice to perform the simulation without generating an error message. First, a small series resistance has been inserted between the voltage source and L1; a value of 1 pΩ was selected to minimize its effects. Second, a 1000 MΩ resistor (essentially infinite) was connected to L2. The output of the simulation is a voltage magnitude of 13.33 V

and a phase angle of  $-3.819 \times 10^{-8}$  degrees (essentially zero), in agreement with the values calculated by hand in Example 13.5.

PSpice also provides two different transformer models, a linear transformer, **XFRM\_LINEAR**, and an ideal transformer **XFRM\_NONLINEAR**, a circuit element which is the subject of the following section. The linear transformer requires that values be specified for the coupling coefficient and both coil inductances. The ideal transformer also requires a coupling coefficient, but, as we shall see, an *ideal* transformer has infinite or nearly infinite inductance values. Thus, the remaining parameters required for the part **XFRM\_NONLINEAR** are the number of turns of wire that form each coil.

### 13.4 THE IDEAL TRANSFORMER

An *ideal transformer* is a useful approximation of a very tightly coupled transformer in which the coupling coefficient is essentially unity and both the primary and secondary inductive reactances are extremely large in comparison with the terminating impedances. These characteristics are closely approached by most well-designed iron-core transformers over a reasonable range of frequencies for a reasonable range of terminal impedances. The approximate analysis of a circuit containing an iron-core transformer may be achieved very simply by replacing that transformer with an ideal transformer; the ideal transformer may be thought of as a first-order model of an iron-core transformer.

#### Turns Ratio of an Ideal Transformer

One new concept arises with the ideal transformer: the *turns ratio*  $a$ . The self-inductance of a coil is proportional to the square of the number of turns of wire forming the coil. This relationship is valid only if all the flux established by the current flowing in the coil links all the turns. In order to develop this result quantitatively it is necessary to utilize magnetic field concepts, a subject that is not included in our discussion of circuit analysis. However, a qualitative argument may suffice. If a current  $i$  flows through a coil of  $N$  turns, then  $N$  times the magnetic flux of a single-turn coil will be produced. If we think of the  $N$  turns as being coincident, then all the flux certainly links all the turns. As the current and flux change with time, a voltage is then induced *in each turn* which is  $N$  times larger than that caused by a single-turn coil. Thus, the voltage induced *in the  $N$ -turn coil* must be  $N^2$  times the single-turn voltage. From this, the proportionality between inductance and the square of the numbers of turns arises. It follows that

$$\frac{L_2}{L_1} = \frac{N_2^2}{N_1^2} = a^2 \quad [20]$$

or

$$a = \frac{N_2}{N_1} \quad [21]$$

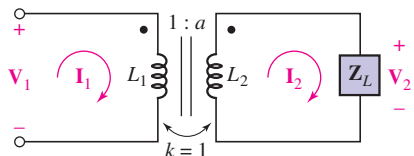

■ FIGURE 13.25 An ideal transformer is connected to a general load impedance.

Figure 13.25 shows an ideal transformer to which a secondary load is connected. The ideal nature of the transformer is established by several

conventions: the use of the vertical lines between the two coils to indicate the iron laminations present in many iron-core transformers, the unity value of the coupling coefficient, and the presence of the symbol  $1:a$ , suggesting a turns ratio of  $N_1$  to  $N_2$ .

Let us analyze this transformer in the sinusoidal steady state. The two mesh equations are

$$\mathbf{V}_1 = j\omega L_1 \mathbf{I}_1 - j\omega M \mathbf{I}_2 \quad [22]$$

and

$$0 = -j\omega M \mathbf{I}_1 + (\mathbf{Z}_L + j\omega L_2) \mathbf{I}_2 \quad [23]$$

First, consider the input impedance of an ideal transformer. By solving Eq. [23] for  $\mathbf{I}_2$  and substituting in Eq. [22], we obtain

$$\mathbf{V}_1 = \mathbf{I}_1 j\omega L_1 + \mathbf{I}_1 \frac{\omega^2 M^2}{\mathbf{Z}_L + j\omega L_2}$$

and

$$\mathbf{Z}_{\text{in}} = \frac{\mathbf{V}_1}{\mathbf{I}_1} = j\omega L_1 + \frac{\omega^2 M^2}{\mathbf{Z}_L + j\omega L_2}$$

Since  $k = 1$ ,  $M^2 = L_1 L_2$  so

$$\mathbf{Z}_{\text{in}} = j\omega L_1 + \frac{\omega^2 L_1 L_2}{\mathbf{Z}_L + j\omega L_2}$$

Besides a unity coupling coefficient, another characteristic of an ideal transformer is an extremely large impedance for both the primary and secondary coils, regardless of the operating frequency. This suggests that the ideal case would be for both  $L_1$  and  $L_2$  to tend to infinity. Their ratio, however, must remain finite, as specified by the turns ratio. Thus,

$$L_2 = a^2 L_1$$

leads to

$$\mathbf{Z}_{\text{in}} = j\omega L_1 + \frac{\omega^2 a^2 L_1^2}{\mathbf{Z}_L + j\omega a^2 L_1}$$

Now if we let  $L_1$  become infinite, both of the terms on the right-hand side of the preceding equation become infinite, and the result is indeterminate. Thus, it is necessary to first combine these two terms:

$$\mathbf{Z}_{\text{in}} = \frac{j\omega L_1 \mathbf{Z}_L - \omega^2 a^2 L_1^2 + \omega^2 a^2 L_1^2}{\mathbf{Z}_L + j\omega a^2 L_1} \quad [24]$$

or

$$\mathbf{Z}_{\text{in}} = \frac{j\omega L_1 \mathbf{Z}_L}{\mathbf{Z}_L + j\omega a^2 L_1} = \frac{\mathbf{Z}_L}{\mathbf{Z}_L / j\omega L_1 + a^2} \quad [25]$$

Now as  $L_1 \rightarrow \infty$ , we see that  $\mathbf{Z}_{\text{in}}$  becomes

$$\mathbf{Z}_{\text{in}} = \frac{\mathbf{Z}_L}{a^2} \quad [26]$$

for finite  $\mathbf{Z}_L$ .

This result has some interesting implications, and at least one of them appears to contradict one of the characteristics of the linear transformer. The input impedance of an ideal transformer is proportional to the load



impedance, the proportionality constant being the reciprocal of the square of the turns ratio. In other words, if the *load* impedance is a capacitive impedance, then the *input* impedance is a capacitive impedance. In the linear transformer, however, the reflected impedance suffered a sign change in its reactive part; a capacitive load led to an inductive contribution to the input impedance. The explanation of this occurrence is achieved by first realizing that  $\mathbf{Z}_L/a^2$  is *not* the reflected impedance, although it is often loosely called by that name. The true reflected impedance is infinite in the ideal transformer; otherwise it could not “cancel” the infinite impedance of the primary inductance. This cancellation occurs in the numerator of Eq. [24]. The impedance  $\mathbf{Z}_L/a^2$  represents a small term which is the amount by which an exact cancellation does not occur. The true reflected impedance in the ideal transformer does change sign in its reactive part; as the primary and secondary inductances become infinite, however, the effect of the infinite primary-coil reactance and the infinite, but negative, reflected reactance of the secondary coil is one of cancellation.

The first important characteristic of the ideal transformer is therefore its ability to change the magnitude of an impedance, or to change impedance level. An ideal transformer having 100 primary turns and 10,000 secondary turns has a turns ratio of 10,000/100, or 100. Any impedance placed across the secondary then appears at the primary terminals reduced in magnitude by a factor of  $100^2$ , or 10,000. A 20,000  $\Omega$  resistor looks like 2  $\Omega$ , a 200 mH inductor looks like 20  $\mu\text{H}$ , and a 100 pF capacitor looks like 1  $\mu\text{F}$ . If the primary and secondary windings are interchanged, then  $a = 0.01$  and the load impedance is apparently increased in magnitude. In practice, this exact change in magnitude does not always occur, for we must remember that as we took the last step in our derivation and allowed  $L_1$  to become infinite in Eq. [25], it was necessary to neglect  $\mathbf{Z}_L$  in comparison with  $j\omega L_2$ . Since  $L_2$  can never be infinite, it is evident that the ideal transformer model will become invalid if the load impedances are very large.

## Use of Transformers for Impedance Matching

A practical example of the use of an iron-core transformer as a device for changing impedance level is in the coupling of an amplifier to a speaker system. In order to achieve maximum power transfer, we know that the resistance of the load should be equal to the internal resistance of the source; the speaker usually has an impedance magnitude (often assumed to be a resistance) of only a few ohms, while an amplifier may possess an internal resistance of several thousand ohms. Thus, an ideal transformer is required in which  $N_2 < N_1$ . For example, if the amplifier internal impedance is 4000  $\Omega$  and the speaker impedance is 8  $\Omega$ , then we desire that

$$\mathbf{Z}_g = 4000 = \frac{\mathbf{Z}_L}{a^2} = \frac{8}{a^2}$$

or

$$a = \frac{1}{22.4}$$

and thus

$$\frac{N_1}{N_2} = 22.4$$



## Use of Transformers for Current Adjustment

There is a simple relationship between the primary and secondary currents  $\mathbf{I}_1$  and  $\mathbf{I}_2$  in an ideal transformer. From Eq. [23],

$$\frac{\mathbf{I}_2}{\mathbf{I}_1} = \frac{j\omega M}{\mathbf{Z}_L + j\omega L_2}$$

Once again we allow  $L_2$  to become infinite, and it follows that

$$\frac{\mathbf{I}_2}{\mathbf{I}_1} = \frac{j\omega M}{j\omega L_2} = \sqrt{\frac{L_1}{L_2}}$$

or

$$\boxed{\frac{\mathbf{I}_2}{\mathbf{I}_1} = \frac{1}{a}} \quad [27]$$

Thus, the ratio of the primary and secondary currents is the turns ratio. If we have  $N_2 > N_1$ , then  $a > 1$ , and it is apparent that the larger current flows in the winding with the smaller number of turns. In other words,

$$N_1 \mathbf{I}_1 = N_2 \mathbf{I}_2$$

It should also be noted that the current ratio is the *negative* of the turns ratio if either current is reversed or if either dot location is changed.



In our example in which an ideal transformer was used to change the impedance level to efficiently match a speaker to an amplifier, an rms current of 50 mA at 1000 Hz in the primary causes an rms current of 1.12 A at 1000 Hz in the secondary. The power delivered to the speaker is  $(1.12)^2(8)$ , or 10 W, and the power delivered to the transformer by the power amplifier is  $(0.05)^2(4000)$ , or 10 W. The result is comforting, since the ideal transformer contains neither an active device which can generate power nor any resistor which can absorb power.

## Use of Transformers for Voltage Level Adjustment

Since the power delivered to the ideal transformer is identical with that delivered to the load, whereas the primary and secondary currents are related by the turns ratio, it should seem reasonable that the primary and secondary voltages must also be related to the turns ratio. If we define the secondary voltage, or load voltage, as

$$\mathbf{V}_2 = \mathbf{I}_2 \mathbf{Z}_L$$

and the primary voltage as the voltage across  $L_1$ , then

$$\mathbf{V}_1 = \mathbf{I}_1 \mathbf{Z}_{in} = \mathbf{I}_1 \frac{\mathbf{Z}_L}{a^2}$$

The ratio of the two voltages then becomes

$$\frac{\mathbf{V}_2}{\mathbf{V}_1} = a^2 \frac{\mathbf{I}_2}{\mathbf{I}_1}$$



or

$$\frac{V_2}{V_1} = a = \frac{N_2}{N_1} \quad [28]$$



(a)



(b)

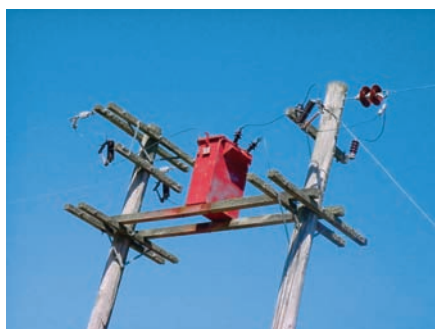

(c)

■ FIGURE 13.26 (a) A step-up transformer used to increase the generator output voltage for transmission. (b) Substation transformer used to reduce the voltage from the 220 kV transmission level to several tens of kilovolts for local distribution. (c) Step-down transformer used to reduce the distribution voltage level to 240 V for power consumption.

(Photos courtesy of Dr. Wade Enright, Te Kura Pukaha Vira O Te Whare Wananga O Waitaha, Aotearoa.)

The ratio of the secondary to the primary voltage is equal to the turns ratio. We should take care to note that this equation is opposite that of Eq. [27], and this is a common source of error for students. This ratio may also be negative if either voltage is reversed or either dot location is changed.

Simply by choosing the turns ratio, therefore, we now have the ability to change any ac voltage to any other ac voltage. If  $a > 1$ , the secondary voltage will be greater than the primary voltage, and we have what is commonly referred to as a **step-up transformer**. If  $a < 1$ , the secondary voltage will be less than the primary voltage, and we have a **step-down transformer**. Utility companies typically generate power at a voltage in the range of 12 to 25 kV. Although this is a rather large voltage, transmission losses over long distances can be reduced by increasing the level to several hundred thousand volts using a step-up transformer (Fig. 13.26a). This voltage is then reduced to several tens of kilovolts at substations for local power distribution using step-down transformers (Fig. 13.26b). Additional step-down transformers are located outside buildings to reduce the voltage from the transmission voltage to the 110 or 220 V level required to operate machinery (Fig. 13.26c).

Combining the voltage and current ratios, Eqs. [27] and [28],

$$V_2 I_2 = V_1 I_1$$

and we see that the primary and secondary complex voltamperes are equal. The magnitude of this product is usually specified as a maximum allowable value on power transformers. If the load has a phase angle  $\theta$ , or

$$Z_L = |Z_L| \angle \theta$$

then  $V_2$  leads  $I_2$  by an angle  $\theta$ . Moreover, the input impedance is  $Z_L/a^2$ , and thus  $V_1$  also leads  $I_1$  by the same angle  $\theta$ . If we let the voltage and current represent rms values, then  $|V_2| |I_2| \cos \theta$  must equal  $|V_1| |I_1| \cos \theta$ , and all the power delivered to the primary terminals reaches the load; none is absorbed by or delivered to the ideal transformer.

The characteristics of the ideal transformer that we have obtained have all been determined by phasor analysis. They are certainly true in the sinusoidal steady state, but we have no reason to believe that they are correct for the *complete* response. Actually, they are applicable in general, and the demonstration that this statement is true is much simpler than the phasor-based analysis we have just completed. Our analysis, however, has served to point out the specific approximations that must be made on a more exact model of an actual transformer in order to obtain an ideal transformer. For example, we have seen that the reactance of the secondary winding must be much greater in magnitude than the impedance of any load that is connected to the secondary. Some feeling for those operating conditions under which a transformer ceases to behave as an ideal transformer is thus achieved.

## EXAMPLE 13.7

For the circuit given in Fig. 13.27, determine the average power dissipated in the 10 k $\Omega$  resistor.

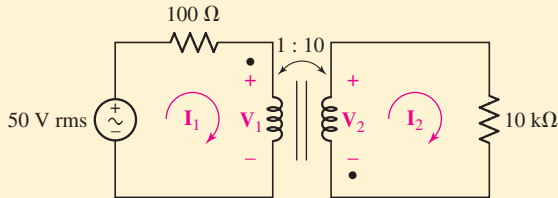

FIGURE 13.27 A simple ideal transformer circuit.

The average power dissipated by the 10 k $\Omega$  resistor is simply

$$P = 10,000|I_2|^2$$

The 50 V rms source “sees” a transformer input impedance of  $Z_L/a^2$  or 100  $\Omega$ . Thus, we obtain

$$I_1 = \frac{50}{100 + 100} = 250 \text{ mA rms}$$

From Eq. [27],  $I_2 = (1/a)I_1 = 25 \text{ mA rms}$ , so we find that the 10 k $\Omega$  resistor dissipates 6.25 W.

The phase angles can be ignored in this example as they do not impact the calculation of average power dissipated by a purely resistive load.

## PRACTICE

13.8 Repeat Example 13.7 using voltages to compute the dissipated power.

Ans: 6.25 W.

## Voltage Relationship in the Time Domain

Let us now determine how the time-domain quantities  $v_1$  and  $v_2$  are related in the ideal transformer. Returning to the circuit shown in Fig. 13.17 and the two equations, [16] and [17], describing it, we may solve the second equation for  $di_2/dt$  and substitute in the first equation:

$$v_1 = L_1 \frac{di_1}{dt} + \frac{M}{L_2} v_2 - \frac{M^2}{L_2} \frac{di_1}{dt}$$

However, for unity coupling,  $M^2 = L_1 L_2$ , and so

$$v_1 = \frac{M}{L_2} v_2 = \sqrt{\frac{L_1}{L_2}} v_2 = \frac{1}{a} v_2$$

The relationship between primary and secondary voltage therefore does apply to the complete time-domain response.

## PRACTICAL APPLICATION

### Superconducting Transformers

For the most part, we have neglected the various types of losses that may be present in a particular transformer. When dealing with large power transformers, however, close attention must be paid to such nonidealities, despite overall efficiencies of typically 97 percent or more. Although such a high efficiency may seem nearly ideal, it can represent a great deal of wasted energy when the transformer is handling several thousand amperes. So-called  $i^2R$  (pronounced “eye-squared-R”) losses represent power dissipated as heat, which can increase the temperature of the transformer coils. Wire resistance increases with temperature, so heating only leads to greater losses. High temperatures can also lead to degradation of the wire insulation, resulting in shorter transformer life. As a result, many modern power transformers employ a liquid oil bath to remove excess heat from the transformer coils. Such an approach has its drawbacks, however, including environmental impact and fire danger from leaking oil as a result of corrosion over time (Fig. 13.28).

One possible means of improving the performance of such transformers is to make use of superconducting wire to replace the resistive coils of a standard transformer design. Superconductors are materials that are resistive at high temperature, but suddenly show no resistance to the flow of current below a critical temperature. Most elements are superconducting only near



■ FIGURE 13.28 Fire that broke out in 2004 at the 340,000 V American Electric Power Substation near Mishawaka, Indiana. (© AP/Wide World Photos)

An expression relating primary and secondary current in the time domain is most quickly obtained by dividing Eq. [16] throughout by  $L_1$ ,

$$\frac{v_1}{L_1} = \frac{di_1}{dt} + \frac{M}{L_1} \frac{di_2}{dt} = \frac{di_1}{dt} + a \frac{di_2}{dt}$$

and then invoking one of the hypotheses underlying the ideal transformer:  $L_1$  must be infinite. If we assume that  $v_1$  is not infinite, then

$$\frac{di_1}{dt} = -a \frac{di_2}{dt}$$

Integrating,

$$i_1 = -ai_2 + A$$

where  $A$  is a constant of integration that does not vary with time. Thus, if we neglect any direct currents in the two windings and fix our attention only on



absolute zero, requiring expensive liquid helium-based cryogenic cooling. With the discovery in the 1980s of ceramic superconductors having critical temperatures of 90 K ( $-183^{\circ}\text{C}$ ) and higher, it became possible to replace helium-based equipment with significantly cheaper liquid nitrogen systems.

Figure 13.29 shows a prototype partial-core superconducting transformer being developed at the University of Canterbury. This design employs environmentally benign liquid nitrogen in place of an oil bath, and is also significantly smaller than a comparably rated conventional transformer. The result is a measurable improvement in overall transformer efficiency, which translates into operational cost savings for the owner.

Still, all designs have disadvantages that must be weighed against their potential advantages, and superconducting transformers are no exception. The most significant obstacle at present is the relatively high cost of fabricating superconducting wire several kilometers in length compared to copper wire. Part of this is due to the challenge of fabricating long wires from ceramic materials, but part of it is also due to the silver tubing used to surround the superconductor to provide a low-resistance current path in the event of a cooling system failure (although less expensive than silver, copper reacts with the ceramic and is therefore not a viable alternative). The net result is that although a superconducting transformer is likely to save a utility money over a long period of time—many transformers see over 30 years of service—

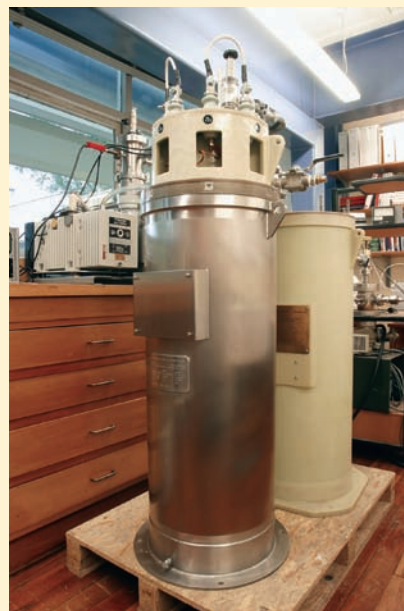

■ FIGURE 13.29 Prototype 15 kVA partial core superconducting power transformer.  
(Photo courtesy of Department of Electrical and Computer Engineering, University of Canterbury.)

the initial cost is much higher than for a traditional resistive transformer. At present, many companies (including utilities) are driven by short-term cost considerations and are not always eager to make large capital investments with only long-term cost benefits.

the time-varying portion of the response, then

$$i_1 = -ai_2$$

The minus sign arises from the placement of the dots and selection of the current directions in Fig. 13.17.

The same current and voltage relationships are therefore obtained in the time domain as were obtained previously in the frequency domain, provided that dc components are ignored. The time-domain results are more general, but they have been obtained by a less informative process.

## Equivalent Circuits

The characteristics of the ideal transformer which we have established may be utilized to simplify circuits in which ideal transformers appear. Let us assume, for purposes of illustration, that everything to the left of the primary

terminals has been replaced by its Thévenin equivalent, as has the network to the right of the secondary terminals. We thus consider the circuit shown in Fig. 13.30. Excitation at any frequency  $\omega$  is assumed.

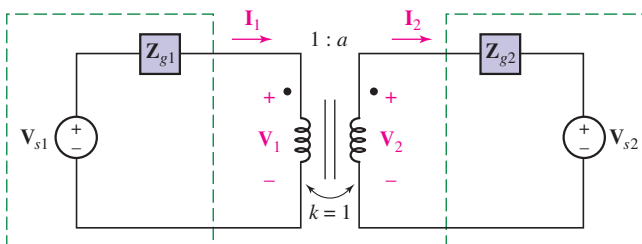

■ FIGURE 13.30 The networks connected to the primary and secondary terminals of an ideal transformer are represented by their Thévenin equivalents.

Thévenin's or Norton's theorem may be used to achieve an equivalent circuit that does not contain a transformer. For example, let us determine the Thévenin equivalent of the network to the left of the secondary terminals. Open-circuiting the secondary,  $\mathbf{I}_2 = 0$  and therefore  $\mathbf{I}_1 = 0$  (remember that  $L_1$  is infinite). No voltage appears across  $\mathbf{Z}_{g1}$ , and thus  $\mathbf{V}_1 = \mathbf{V}_{s1}$  and  $\mathbf{V}_{2oc} = a\mathbf{V}_{s1}$ . The Thévenin impedance is obtained by setting  $\mathbf{V}_{s1}$  to zero and utilizing the square of the turns ratio, being careful to use the reciprocal turns ratio, since we are looking in at the secondary terminals. Thus,  $\mathbf{Z}_{th2} = \mathbf{Z}_{g1}a^2$ .

As a check on our equivalent, let us also determine the short-circuit secondary current  $\mathbf{I}_{2sc}$ . With the secondary short-circuited, the primary generator faces an impedance of  $\mathbf{Z}_{g1}$ , and, thus,  $\mathbf{I}_1 = \mathbf{V}_{s1}/\mathbf{Z}_{g1}$ . Therefore,  $\mathbf{I}_{2sc} = \mathbf{V}_{s1}/a\mathbf{Z}_{g1}$ . The ratio of the open-circuit voltage to the short-circuit current is  $a^2\mathbf{Z}_{g1}$ , as it should be. The Thévenin equivalent of the transformer and primary circuit is shown in the circuit of Fig. 13.31.

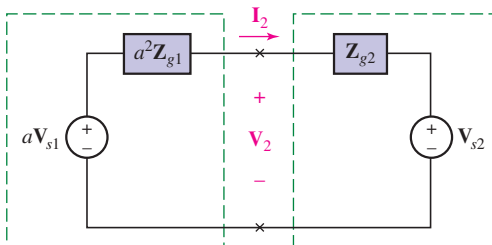

■ FIGURE 13.31 The Thévenin equivalent of the network to the left of the secondary terminals in Fig. 13.30 is used to simplify that circuit.

Each primary voltage may therefore be multiplied by the turns ratio, each primary current divided by the turns ratio, and each primary impedance multiplied by the square of the turns ratio; and then these modified voltages, currents, and impedances replace the given voltages, currents, and impedances plus the transformer. If either dot is interchanged, the equivalent may be obtained by using the negative of the turns ratio.



Note that this equivalence, as illustrated by Fig. 13.31, is possible only if the network connected to the two primary terminals, and that connected to the two secondary terminals, can be replaced by their Thévenin equivalents. That is, each must be a two-terminal network. For example, if we cut the two primary leads at the transformer, the circuit must be divided into two separate networks; there can be no element or network bridging across the transformer between primary and secondary.

A similar analysis of the transformer and the secondary network shows that everything to the right of the primary terminals may be replaced by an identical network without the transformer, each voltage being divided by  $a$ , each current being multiplied by  $a$ , and each impedance being divided by  $a^2$ . A reversal of either winding requires the use of a turns ratio of  $-a$ .

## EXAMPLE 13.8

For the circuit given in Fig. 13.32, determine the equivalent circuit in which the transformer and the secondary circuit are replaced, and also that in which the transformer and the primary circuit are replaced.

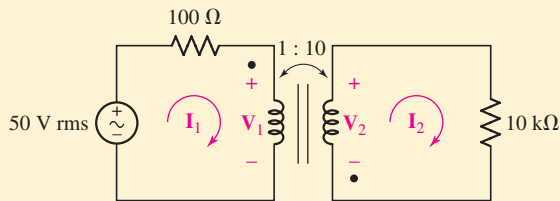

FIGURE 13.32 A simple circuit in which a resistive load is matched to the source impedance by means of an ideal transformer.

This is the same circuit we analyzed in Example 13.7. As before, the input impedance is  $10,000/(10)^2$ , or  $100\ \Omega$  and so  $|\mathbf{I}_1| = 250\ \text{mA rms}$ . We can also compute the voltage across the primary coil

$$|\mathbf{V}_1| = |50 - 100\mathbf{I}_1| = 25\ \text{V rms}$$

and thus find that the source delivers  $(25 \times 10^{-3})(50) = 12.5\ \text{W}$ , of which  $(25 \times 10^{-3})^2(100) = 6.25\ \text{W}$  is dissipated in the internal resistance of the source and  $12.5 - 6.25 = 6.25\ \text{W}$  is delivered to the load. This is the condition for maximum power transfer to the load.

If the secondary circuit and the ideal transformer are removed by the use of the Thévenin equivalent, the  $50\ \text{V}$  source and  $100\ \Omega$  resistor simply see a  $100\ \Omega$  impedance, and the simplified circuit of Fig. 13.33a is obtained. The primary current and voltage are now immediately evident.

If, instead, the network to the left of the secondary terminals is replaced by its Thévenin equivalent, we find (keeping in mind the location of the dots)  $\mathbf{V}_{th} = -10(50) = -500\ \text{V rms}$ , and  $\mathbf{Z}_{th} = (-10)^2(100) = 10\ \text{k}\Omega$ ; the resulting circuit is shown in Fig. 13.33b.

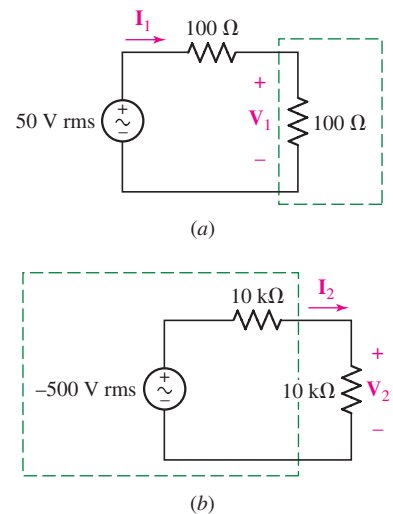

FIGURE 13.33 The circuit of Fig. 13.32 is simplified by replacing (a) the transformer and secondary circuit by the Thévenin equivalent or (b) the transformer and primary circuit by the Thévenin equivalent.

## PRACTICE

13.9 Let  $N_1 = 1000$  turns and  $N_2 = 5000$  turns in the ideal transformer shown in Fig. 13.34. If  $Z_L = 500 - j400 \Omega$ , find the average power delivered to  $Z_L$  for (a)  $I_2 = 1.4/20^\circ$  A rms; (b)  $V_2 = 900/40^\circ$  V rms; (c)  $V_1 = 80/100^\circ$  V rms; (d)  $I_1 = 6/45^\circ$  A rms; (e)  $V_s = 200/0^\circ$  V rms.

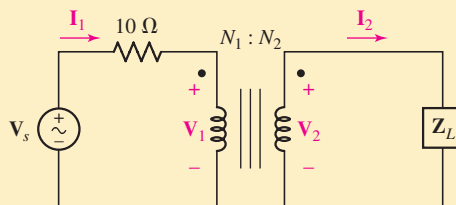

FIGURE 13.34

Ans: 980 W; 988 W; 195.1 W; 720 W; 692 W.

## SUMMARY AND REVIEW

Transformers play a critical role in the power industry, allowing voltages to be stepped up for transmission, and stepped down to the level required for individual pieces of equipment. In this chapter, we studied transformers in the broader context of magnetically coupled circuits, where the magnetic flux associated with current can link two or more elements in a circuit (or even neighboring circuits). This is most easily understood by extending the concept of inductance studied in Chap. 7 to introduce the idea of mutual inductance (also having units of henrys). We saw that the coefficient  $M$  of mutual inductance is limited to less than the geometric mean of the two inductances being coupled (i.e.,  $M \leq \sqrt{L_1 L_2}$ ), and made use of the dot convention to determine the polarity of the voltage induced across one inductance as a result of current flowing through the other. When the two inductances are not particularly close,  $M$  might be rather small. However, in the case of a well-designed transformer, it might approach its maximum value. To describe such situations, we introduced the concept of the coupling coefficient  $k$ . When dealing with a linear transformer, analysis may be assisted by representing the element with an equivalent T (or, less commonly,  $\Pi$ ) network, but a great deal of circuit analysis is performed assuming an ideal transformer. In such instances we no longer concern ourselves with  $M$  or  $k$ , but rather the turns ratio  $a$ . We saw that the voltages across the primary and secondary coils, as well as their individual currents, are related by this parameter. This approximation is very useful for both analysis and design. We concluded the chapter with a brief discussion of how Thévenin's theorem can be applied to circuits with ideal transformers.

We could continue, as the study of inductively coupled circuits is an interesting and important topic, but at this point it might be appropriate to list some of the key concepts we have already discussed, along with corresponding example numbers.

- Mutual inductance describes the voltage induced at the ends of a coil due to the magnetic field generated by a second coil. (Example 13.1)

- The dot convention allows a sign to be assigned to the mutual inductance term. (Example 13.1)
- According to the dot convention, a current entering the *dotted* terminal of one coil produces an open-circuit voltage with a positive voltage reference at the *dotted* terminal of the second coil. (Examples 13.1, 13.2, 13.3)
- The total energy stored in a pair of coupled coils has three separate terms: the energy stored in each self-inductance ( $\frac{1}{2}Li^2$ ), and the energy stored in the mutual inductance ( $Mi_1i_2$ ). (Example 13.4)
- The coupling coefficient is given by  $k = M/\sqrt{L_1L_2}$ , and is restricted to values between 0 and 1. (Example 13.4)
- A linear transformer consists of two coupled coils: the primary winding and the secondary winding. (Examples 13.5, 13.6)
- An ideal transformer is a useful approximation for practical iron-core transformers. The coupling coefficient is taken to be unity, and the inductance values are assumed to be infinite. (Examples 13.7, 13.8)
- The turns ratio  $a = N_2/N_1$  of an ideal transformer relates the primary and secondary coil voltages:  $\mathbf{V}_2 = a\mathbf{V}_1$ . (Example 13.8)
- The turns ratio  $a$  also relates the currents in the primary and secondary coils:  $\mathbf{I}_1 = a\mathbf{I}_2$ . (Examples 13.7, 13.8)

## READING FURTHER

Almost everything you ever wanted to know about transformers can be found in:

M. Heathcote, *J&P Transformer Book*, 12th ed. Oxford: Reed Educational and Professional Publishing Ltd., 1998.

Another comprehensive transformer title is:

W. T. McLyman, *Transformer and Inductor Design Handbook*, 3rd ed. New York: Marcel Dekker, 2004.

A good transformer book with a strong economic focus is:

B. K. Kennedy, *Energy Efficient Transformers*. New York: McGraw-Hill, 1998.

## EXERCISES

### 13.1 Mutual Inductance

1. Consider the two inductances depicted in Fig. 13.35. Set  $L_1 = 10$  mH,  $L_2 = 5$  mH, and  $M = 1$  mH. Determine the steady-state expression for (a)  $v_1$  if  $i_1 = 0$  and  $i_2 = 5 \cos 8t$  A; (b)  $v_2$  if  $i_1 = 3 \sin 100t$  A and  $i_2 = 0$ ; (c)  $v_2$  if  $i_1 = 5 \cos (8t - 40^\circ)$  A and  $i_2 = 4 \sin 8t$  A.

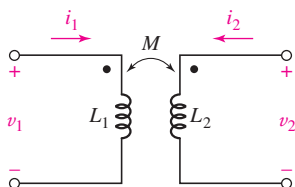

■ FIGURE 13.35

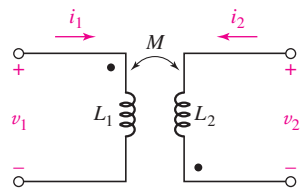

■ FIGURE 13.36

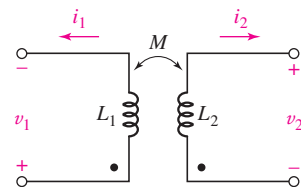

■ FIGURE 13.38

- With respect to Fig. 13.36, assume  $L_1 = 400$  mH,  $L_2 = 230$  mH, and  $M = 10$  mH. Determine the steady-state expression for (a)  $v_1$  if  $i_1 = 0$  and  $i_2 = 2 \cos 40t$  A; (b)  $v_2$  if  $i_1 = 5 \cos(40t + 15^\circ)$  A and  $i_2 = 0$ . (c) Repeat parts (a) and (b) if  $M$  is increased to 300 mH.
- In Fig. 13.37, set  $L_1 = 1$   $\mu$ H,  $L_2 = 2$   $\mu$ H, and  $M = 150$  nH. Obtain a steady-state expression for (a)  $v_1$  if  $i_2 = -\cos 70t$  mA and  $i_1 = 0$ ; (b)  $v_2$  if  $i_1 = 55 \cos(5t - 30^\circ)$  A; (c)  $v_2$  if  $i_1 = 6 \sin 5t$  A and  $i_2 = 3 \sin 5t$ .

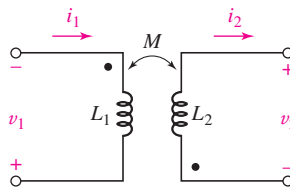

■ FIGURE 13.37

- For the configuration of Fig. 13.38,  $L_1 = 0.5L_2 = 1$  mH and  $M = 0.85\sqrt{L_1L_2}$ . Calculate  $v_2(t)$  if (a)  $i_2 = 0$  and  $i_1 = 5e^{-t}$  mA; (b)  $i_2 = 0$  and  $i_1 = 5 \cos 10t$  mA; (c)  $i_2 = 5 \cos 70t$  mA and  $i_1 = 0.5i_2$ .
- The physical construction of three pairs of coupled coils is shown in Fig. 13.39. Show the two different possible locations for the two dots on each pair of coils.

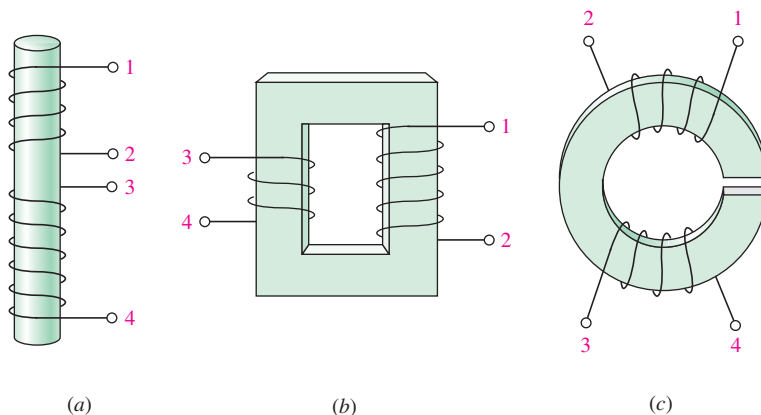

■ FIGURE 13.39

- In the circuit of Fig. 13.40,  $i_1 = 5 \sin(100t - 80^\circ)$  mA,  $L_1 = 1$  H, and  $L_2 = 2$  H. If  $v_2 = 250 \sin(100t - 80^\circ)$  mV, calculate  $M$ .

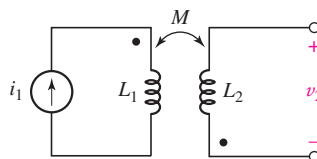

■ FIGURE 13.40

- In the circuit represented in Fig. 13.40, determine  $i_1$  if  $v_2(t) = 4 \cos 5t$  V,  $L_1 = 1$  mH,  $L_2 = 4$  mH, and  $M = 1.5$  mH.
- Calculate  $v_1$  and  $v_2$  if  $i_1 = 5 \sin 40t$  mA and  $i_2 = 5 \cos 40t$  mA,  $L_1 = 1$  mH,  $L_2 = 3$  mH, and  $M = 0.5$  mH, for the coupled inductances shown in (a) Fig. 13.37; (b) Fig. 13.38.

9. Calculate  $v_1$  and  $v_2$  if  $i_1 = 3 \cos(2000t + 13^\circ)$  mA and  $i_2 = 5 \sin 400t$  mA,  $L_1 = 1$  mH,  $L_2 = 3$  mH, and  $M = 200$  nH, for the coupled inductances shown in (a) Fig. 13.35; (b) Fig. 13.36.
10. For the circuit of Fig. 13.41, calculate  $I_1$ ,  $I_2$ ,  $V_2/V_1$ , and  $I_2/I_1$ .

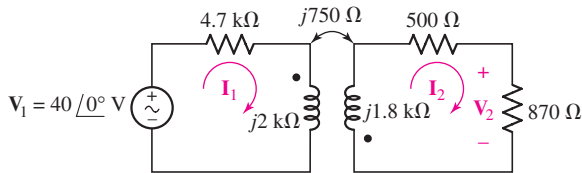

■ FIGURE 13.41



11. For the circuit of Fig. 13.42, plot the magnitude of  $V_2/V_1$  as a function of frequency  $\omega$ , over the range  $0 \leq \omega \leq 2$  rad/s.

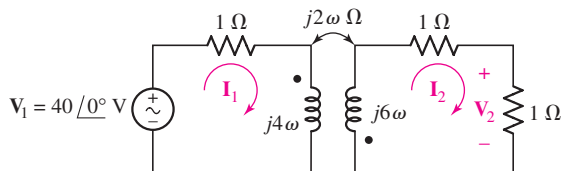

■ FIGURE 13.42

12. For the circuit of Fig. 13.43, (a) draw the phasor representation; (b) write a complete set of mesh equations; (c) calculate  $i_2(t)$  if  $v_1(t) = 8 \sin 720t$  V.

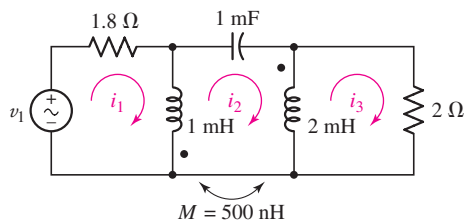

■ FIGURE 13.43

13. In the circuit of Fig. 13.43,  $M$  is reduced by an order of magnitude. Calculate  $i_3$  if  $v_1 = 10 \cos(800t - 20^\circ)$  V.
14. In the circuit shown in Fig. 13.44, find the average power absorbed by (a) the source; (b) each of the two resistors; (c) each of the two inductances; (d) the mutual inductance.

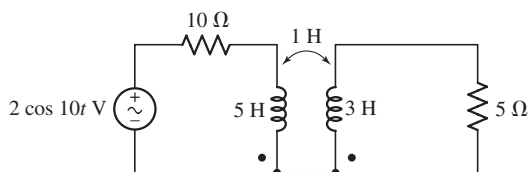

■ FIGURE 13.44

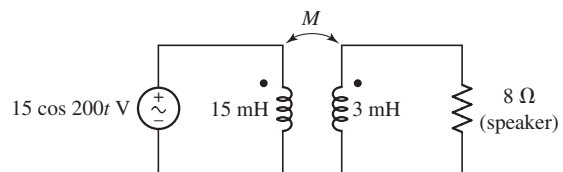

■ FIGURE 13.45

15. The circuit of Fig. 13.45 is designed to drive a simple  $8 \Omega$  speaker. What value of  $M$  results in 1 W of average power being delivered to the speaker?

16. Consider the circuit of Fig. 13.46. The two sources are  $i_{s1} = 2 \cos t$  mA and  $i_{s2} = 1.5 \sin t$  mA. If  $M_1 = 2$  H,  $M_2 = 0$  H, and  $M_3 = 10$  H, calculate  $v_{AG}(t)$ .

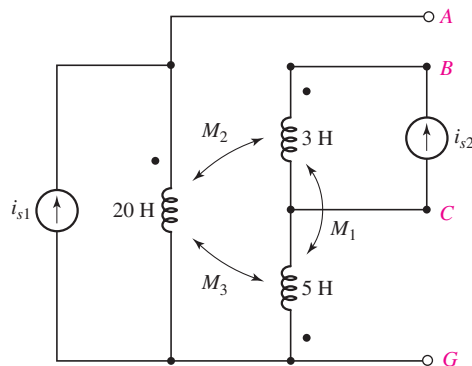

■ FIGURE 13.46

17. For the circuit of Fig. 13.46,  $M_1 = 1$  H,  $M_2 = 1.5$  H, and  $M_3 = 2$  H. If  $i_{s1} = 8 \cos 2t$  A and  $i_{s2} = 7 \sin 2t$  A, calculate (a)  $V_{AB}$ ; (b)  $V_{AG}$ ; (c)  $V_{CG}$ .
18. For the circuit of Fig. 13.47, find the currents  $i_1(t)$ ,  $i_2(t)$ , and  $i_3(t)$  if  $f = 60$  Hz.

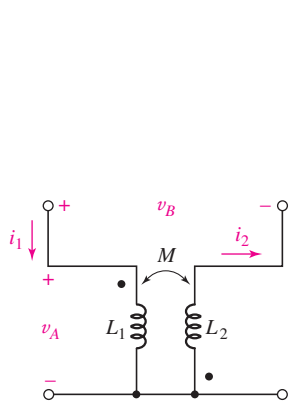

(a)

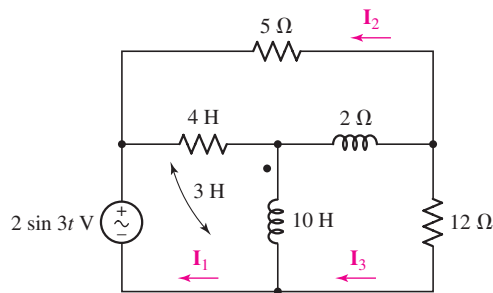

■ FIGURE 13.47

19. Determine an expression for  $i_C(t)$  valid for  $t > 0$  in the circuit of Fig. 13.48, if  $v_s(t) = 10t^2 u(t)/(t^2 + 0.01)$  V.

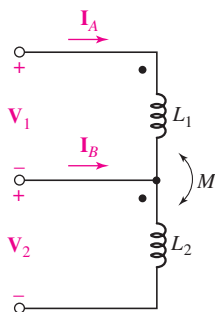

(b)

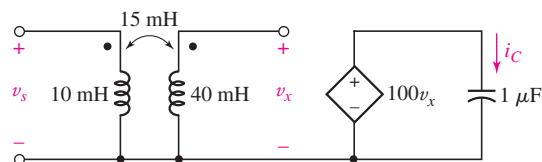

■ FIGURE 13.48

20. For the coupled inductor network of Fig. 13.49a, set  $L_1 = 20$  mH,  $L_2 = 30$  mH,  $M = 10$  mH, and obtain equations for  $v_A$  and  $v_B$  if (a)  $i_1 = 0$  and  $i_2 = 5 \sin 10t$ ; (b)  $i_1 = 5 \cos 20t$  and  $i_2 = 2 \cos (20t - 100^\circ)$  mA. (c) Express  $V_1$  and  $V_2$  as functions of  $I_A$  and  $I_B$  for the network shown in Fig. 13.49b.

■ FIGURE 13.49



21. Note that there is no mutual coupling between the 5 H and 6 H inductors in the circuit of Fig. 13.50. (a) Write a set of equations in terms of  $\mathbf{I}_1(j\omega)$ ,  $\mathbf{I}_2(j\omega)$ , and  $\mathbf{I}_3(j\omega)$ . (b) Find  $\mathbf{I}_3(j\omega)$  if  $\omega = 2$  rad/s.

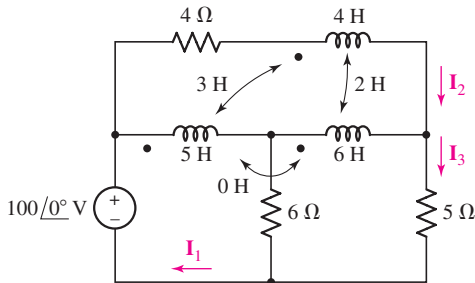

■ FIGURE 13.50

22. Find  $\mathbf{V}_1(j\omega)$  and  $\mathbf{V}_2(j\omega)$  in terms of  $\mathbf{I}_1(j\omega)$  and  $\mathbf{I}_2(j\omega)$  for each circuit of Fig. 13.51.

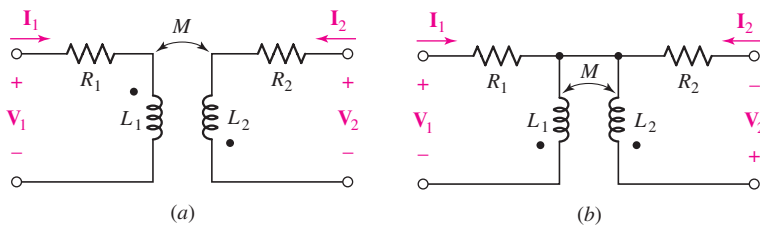

■ FIGURE 13.51

23. (a) Find  $\mathbf{Z}_{in}(j\omega)$  for the network of Fig. 13.52. (b) Plot  $\mathbf{Z}_{in}$  over the frequency range of  $0 \leq \omega \leq 1000$  rad/s. (c) Find  $\mathbf{Z}_{in}(j\omega)$  for  $\omega = 50$  rad/s.

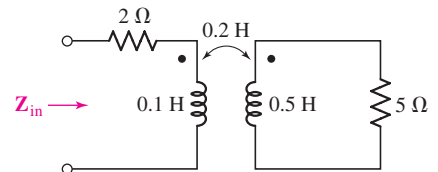

■ FIGURE 13.52

### 13.2 Energy Considerations

24. For the coupled coils of Fig. 13.53,  $L_1 = L_2 = 10$  H, and  $M$  is equal to its maximum possible value. (a) Compute the coupling coefficient  $k$ . (b) Calculate the energy stored in the magnetic field linking the two coils at  $t = 200$  ms if  $i_1 = 10 \cos 4t$  mA and  $i_2 = 2 \cos 4t$  mA.
25. With regard to the coupled inductors shown in Fig. 13.53,  $L_1 = 10$  mH,  $L_2 = 5$  mH, and  $k = 0.75$ . (a) Compute  $M$ . (b) If  $i_1 = 100 \sin 40t$  mA, and  $i_2 = 0$ , compute the energy stored in each coil and in the magnetic field coupling the two inductors at  $t = 2$  ms. (c) Repeat part (b) if  $i_2$  is set to  $75 \cos 40t$  mA.
26. For the circuit of Fig. 13.54,  $L_1 = 2$  mH,  $L_2 = 8$  mH, and  $v_1 = \cos 8t$  V. (a) Obtain an equation for  $v_2(t)$ . (b) Plot  $\mathbf{V}_2$  as a function of  $k$ . (c) Plot the phase angle (in degrees) of  $\mathbf{V}_2$  as a function of  $k$ .

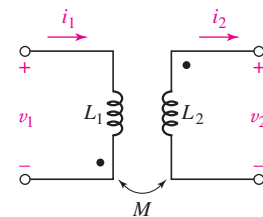

■ FIGURE 13.53

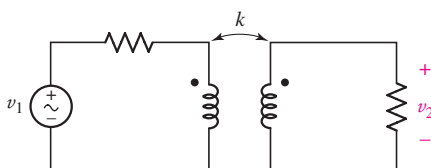

■ FIGURE 13.54

27. Connect a load  $Z_L = 5/33^\circ \Omega$  to the right-hand terminals of Fig. 13.53. Derive an expression for the input impedance at  $f = 100$  Hz, seen looking into the left-hand terminals, if  $L_1 = 1.5$  mH,  $L_2 = 3$  mH, and  $k = 0.55$ .
28. Consider the circuit represented in Fig. 13.55. The coupling coefficient  $k = 0.75$ . If  $i_s = 5 \cos 200t$  mA, calculate the total energy stored at  $t = 0$  and  $t = 5$  ms if (a)  $a$ - $b$  is open-circuited (as shown); (b)  $a$ - $b$  is short-circuited.

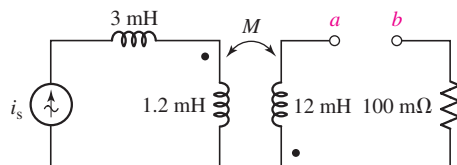

■ FIGURE 13.55

29. Compute  $v_1$ ,  $v_2$ , and the average power delivered to each resistor in the circuit of Fig. 13.56.

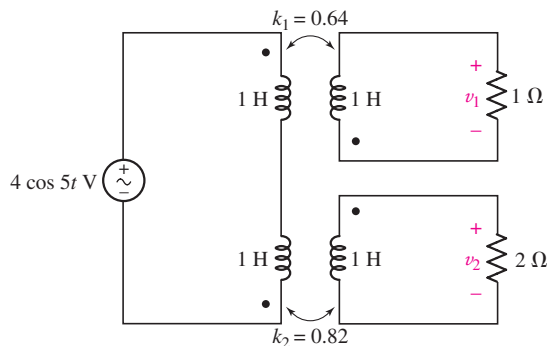

■ FIGURE 13.56

### 13.3 The Linear Transformer

30. Assume the following values for the circuit depicted schematically in Fig. 13.16:  $R_1 = 10 \Omega$ ,  $R_2 = 1 \Omega$ ,  $L_1 = 2 \mu\text{H}$ ,  $L_2 = 1 \mu\text{H}$ , and  $M = 500$  nH. Calculate the input impedance for  $\omega = 10$  rad/s if  $Z_L$  is equal to (a)  $1 \Omega$ ; (b)  $j \Omega$ ; (c)  $-j \Omega$ ; (d)  $5/33^\circ \Omega$ .
31. Determine the T equivalent of the linear transformer represented in Fig. 13.57 (draw and label an appropriate diagram).

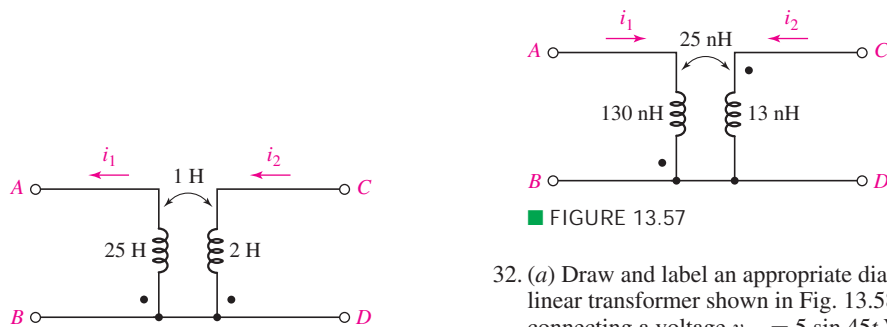

■ FIGURE 13.57

■ FIGURE 13.58

32. (a) Draw and label an appropriate diagram of a T equivalent network for the linear transformer shown in Fig. 13.58. (b) Verify the two are equivalent by connecting a voltage  $v_{AB} = 5 \sin 45t$  V and calculating the open-circuit voltage  $v_{CD}$ .

33. Represent the T network shown in Fig. 13.59 as an equivalent linear transformer if (a)  $L_x = 1$  H,  $L_y = 2$  H, and  $L_z = 4$  H; (b)  $L_x = 10$  mH,  $L_y = 50$  mH, and  $L_z = 22$  mH.

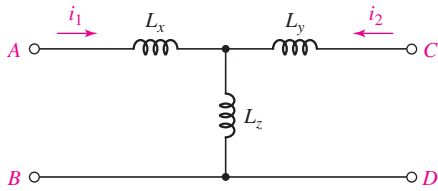

■ FIGURE 13.59

34. Assuming zero initial currents, obtain an equivalent  $\Pi$  network of the transformer depicted in Fig. 13.57.
35. (a) Draw and label a suitable equivalent  $\Pi$  network of the linear transformer shown in Fig. 13.58, assuming zero initial currents. (b) Verify their equivalence with an appropriate simulation.
36. Represent the  $\Pi$  network of Fig. 13.60 as an equivalent linear transformer with zero initial currents if (a)  $L_A = 1$  H,  $L_B = 2$  H, and  $L_C = 4$  H; (b)  $L_A = 10$  mH,  $L_B = 50$  mH, and  $L_C = 22$  mH.

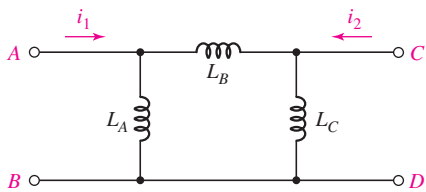

■ FIGURE 13.60

37. For the circuit of Fig. 13.61, determine an expression for (a)  $I_L/V_s$ ; (b)  $V_1/V_s$ .

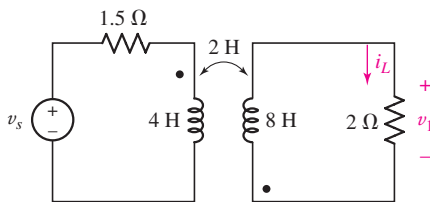

■ FIGURE 13.61

38. (a) For the circuit of Fig. 13.62, if  $v_s = 8 \cos 1000t$  V, calculate  $v_o$ . (b) Verify your solution with an appropriate PSpice simulation.

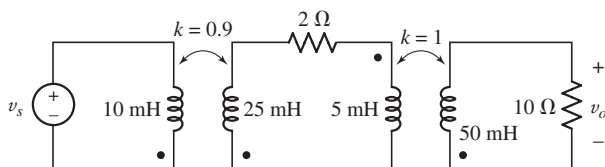

■ FIGURE 13.62

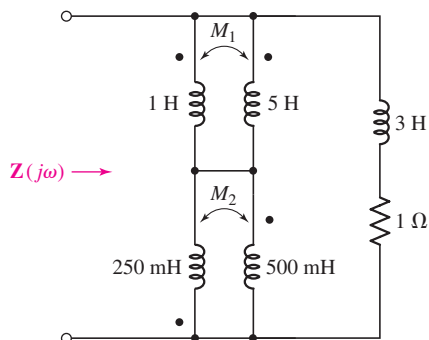

■ FIGURE 13.63

39. With respect to the network shown in Fig. 13.63, derive an expression for  $\mathbf{Z}(j\omega)$  if  $M_1$  and  $M_2$  are set to their respective maximum values.

### 13.4 The Ideal Transformer

40. Calculate  $\mathbf{I}_2$  and  $\mathbf{V}_2$  for the ideal transformer circuit of Fig. 13.64 if (a)  $\mathbf{V}_1 = 4\angle 32^\circ$  V and  $\mathbf{Z}_L = 1 - j\ \Omega$ ; (b)  $\mathbf{V}_1 = 4\angle 32^\circ$  V and  $\mathbf{Z}_L = 0$ ; (c)  $\mathbf{V}_1 = 2\angle 118^\circ$  V and  $\mathbf{Z}_L = 1.5\angle 10^\circ\ \Omega$ .

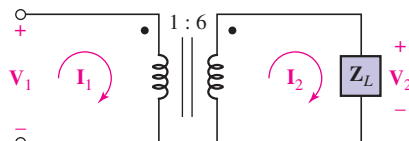

■ FIGURE 13.64

41. With respect to the ideal transformer circuit depicted in Fig. 13.64, calculate  $\mathbf{I}_2$  and  $\mathbf{V}_2$  if (a)  $\mathbf{I}_1 = 244\angle 0^\circ$  mA and  $\mathbf{Z}_L = 5 - j2\ \Omega$ ; (b)  $\mathbf{I}_1 = 100\angle 10^\circ$  mA and  $\mathbf{Z}_L = j2\ \Omega$ .
42. Calculate the average power delivered to the 400 mΩ and 21 Ω resistors, respectively, in the circuit of Fig. 13.65.

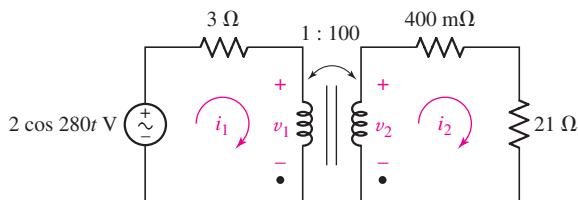

■ FIGURE 13.65

43. With regard to the ideal transformer circuit represented in Fig. 13.65, determine an equivalent circuit in which (a) the transformer and primary circuit are replaced, so that  $\mathbf{V}_2$  and  $\mathbf{I}_2$  are unchanged; (b) the transformer and secondary circuit are replaced, so that  $\mathbf{V}_1$  and  $\mathbf{I}_1$  are unchanged.
44. Calculate the average power delivered to each resistor shown in Fig. 13.66.

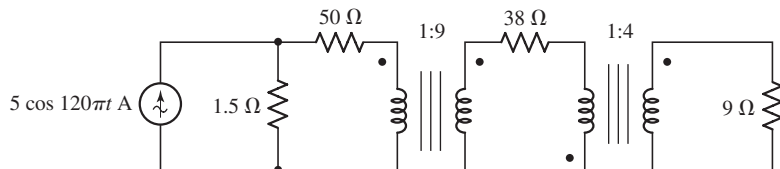

■ FIGURE 13.66

45. With respect to the circuit depicted in Fig. 13.67, calculate (a) the voltages  $v_1$  and  $v_2$ ; (b) the average power delivered to each resistor.

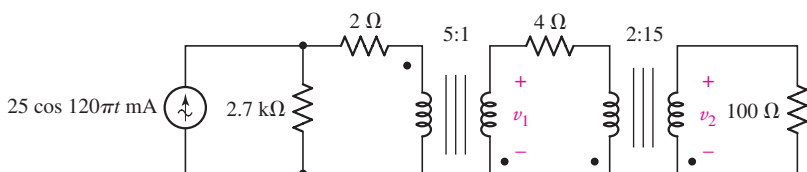

■ FIGURE 13.67

46. Calculate  $I_x$  and  $V_2$  as labeled in Fig. 13.68.

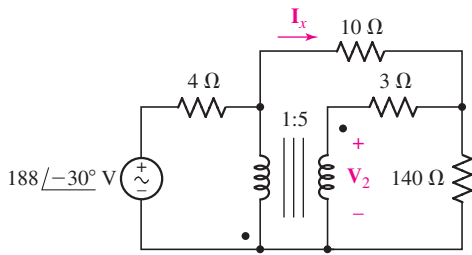

FIGURE 13.68

47. The ideal transformer of the circuit in Fig. 13.68 is removed, flipped across its vertical axis, and reconnected such that the same terminals remain connected to the negative terminal of the source. (a) Calculate  $I_x$  and  $V_2$ . (b) Repeat part (a) if both dots are placed at the bottom terminals of the transformer.

48. For the circuit of Fig. 13.69,  $v_s = 117 \sin 500t$  V. Calculate  $v_2$  if the terminals marked  $a$  and  $b$  are (a) left open-circuited; (b) short-circuited; (c) bridged by a  $2 \Omega$  resistor.

49. The turns ratio of the ideal transformer in Fig. 13.69 is changed from 30:1 to 1:3. Take  $v_s = 720 \cos 120\pi t$  V, and calculate  $v_2$  if terminals  $a$  and  $b$  are (a) short-circuited; (b) bridged by a  $10 \Omega$  resistor; (c) bridged by a  $1 \text{ M}\Omega$  resistor.

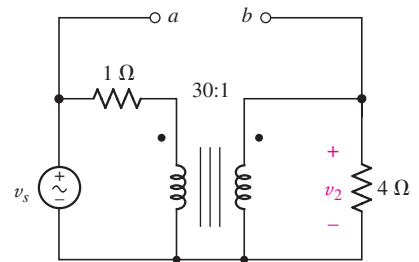

FIGURE 13.69

DP 50. For the circuit of Fig. 13.70,  $R_1 = 1 \Omega$ ,  $R_2 = 4 \Omega$ , and  $R_L = 1 \Omega$ . Select  $a$  and  $b$  to achieve a peak voltage of  $200$  V magnitude across  $R_L$ .

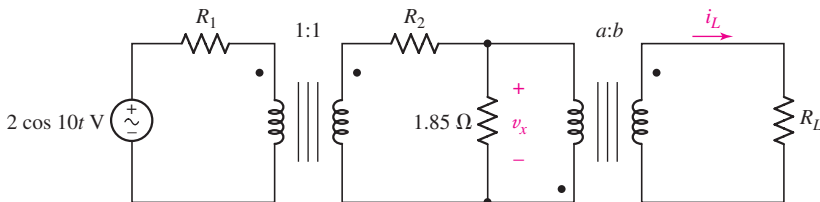

FIGURE 13.70

51. Calculate  $v_x$  for the circuit of Fig. 13.70 if  $a = 0.01b = 1$ ,  $R_1 = 300 \Omega$ ,  $R_2 = 14 \Omega$ , and  $R_L = 1 \text{ k}\Omega$ .

52. (a) Referring to the ideal transformer circuit in Fig. 13.70, determine the load current  $i_L$  if  $b = 0.25a = 1$ ,  $R_1 = 2.2 \Omega$ ,  $R_2 = 3.1 \Omega$ , and  $R_L = 200 \Omega$ . (b) Verify your solution with an appropriate PSpice simulation.

53. Determine the Thévenin equivalent of the network in Fig. 13.71 as seen looking into terminals  $a$  and  $b$ .

54. Calculate  $V_2$  and the average power delivered to the  $8 \Omega$  resistor of Fig. 13.72 if  $V_s = 10\angle 15^\circ$  V, and the control parameter  $c$  is equal to (a) 0; (b) 1 mS.

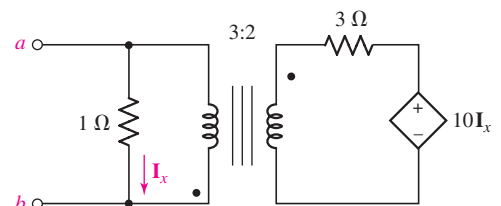

FIGURE 13.71

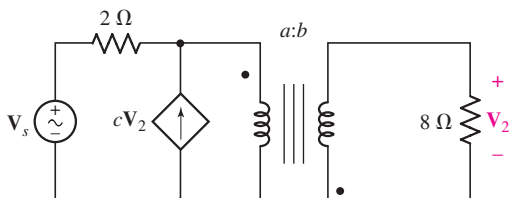

FIGURE 13.72



55. (a) For the circuit of Fig. 13.72, take  $c = -2.5 \text{ mS}$  and select values of  $a$  and  $b$  such that  $100 \text{ W}$  average power is delivered to the  $8 \Omega$  load when  $\mathbf{V}_s = 5/\underline{-35^\circ} \text{ V}$ .  
 (b) Verify your solution with an appropriate PSpice simulation.



### Chapter-Integrating Exercises



56. A transformer whose nameplate reads  $2300/230 \text{ V}, 25 \text{ kVA}$  operates with primary and secondary voltages of  $2300 \text{ V}$  and  $230 \text{ V}$  rms, respectively, and can supply  $25 \text{ kVA}$  from its secondary winding. If this transformer is supplied with  $2300 \text{ V}$  rms and is connected to secondary loads requiring  $8 \text{ kW}$  at unity PF and  $15 \text{ kVA}$  at  $0.8 \text{ PF}$  lagging, (a) what is the primary current? (b) How many kilowatts can the transformer still supply to a load operating at  $0.95 \text{ PF}$  lagging? (c) Verify your answers with PSpice.



57. A friend brings a vintage stereo system back from a recent trip to Warnemünde, unaware that it was designed to operate on twice the supply voltage ( $240 \text{ VAC}$ ) available at American household outlets. Design a circuit to allow your friend to listen to the stereo in the United States, assuming the operating frequency ( $50 \text{ Hz}$  in Germany,  $60 \text{ Hz}$  in the United States) difference can be neglected.
58. The friend referred to in Exercise 57 attempts to justify the erroneous assumption made regarding the stereo by pointing out that the wall outlet in the W.C. (bathroom) had a socket for his U.S. electric razor, clearly marked  $120 \text{ VAC}$ . He failed to notice that the small sign below the outlet clearly stated “Razors only.” With the knowledge that all power lines running into the room operated at  $240 \text{ VAC}$ , draw the likely circuit built into the bathroom wall outlet, and explain why it is limited to “razors only.”
59. Obtain an expression for  $\mathbf{V}_2/\mathbf{V}_s$  in the circuit of Fig. 13.73 if (a)  $L_1 = 100 \text{ mH}$ ,  $L_2 = 500 \text{ mH}$ , and  $M$  is its maximum possible value; (b)  $L_1 = 5L_2 = 1.4 \text{ H}$  and  $k = 87\%$  of its maximum possible value; (c) the two coils can be treated as an ideal transformer, the left-hand coil having  $500$  turns and the right-hand coil having  $10,000$  turns.

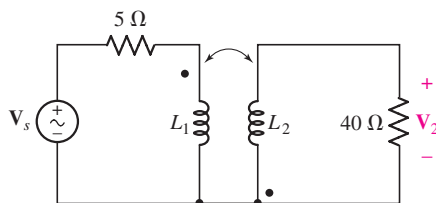

■ FIGURE 13.73

60. You notice your neighbor has installed a large coil of wire in close proximity to the power line coming into your house (underground cables are not available in your neighborhood). (a) What is the likely intention of your neighbor? (b) Is the plan likely to succeed? *Explain.* (c) When confronted, your neighbor simply shrugs and claims there’s no way it can cost you anything, anyway, since nothing of his is touching anything on your property. True or not? *Explain.*

# Complex Frequency and the Laplace Transform

## INTRODUCTION

When faced with time-varying sources, or a circuit with switches installed, we have several choices with respect to the analysis approach. Chapters 7 through 9 detail direct differential equation–based analysis, which is particularly useful when examining turn-on or turn-off transients. In contrast, Chaps. 10 to 13 describe analysis situations where sinusoidal excitation is assumed, and transients are of little or no interest. Unfortunately, not all sources are sinusoidal, and there are times when both transient and steady-state responses are required. In such instances, the Laplace transform proves to be a highly valuable tool.

Many textbooks simply launch straight into the Laplace transform integral, but this approach conveys no intuitive understanding. For this reason, we have chosen to first introduce what may strike the reader at first as a somewhat odd concept—the notion of a “complex” frequency. Simply a mathematical convenience, complex frequency allows us to manipulate both periodic and nonperiodic time-varying quantities in parallel, greatly simplifying the analysis. After getting a feel for the basic technique, we develop it as a specific circuit analysis tool in Chap. 15.

## 14.1 COMPLEX FREQUENCY

We introduce the notion of *complex frequency* by considering a (purely real) exponentially damped sinusoidal function, such as the voltage

$$v(t) = V_m e^{\sigma t} \cos(\omega t + \theta) \quad [1]$$

## KEY CONCEPTS

Complex Frequency

Laplace Transform

Inverse Transform

Use of Transform Tables

Method of Residuals

Using MATLAB to  
Manipulate Polynomials

Using MATLAB to Determine  
Residues of Rational  
Fractions

Initial-Value Theorem

Final-Value Theorem



where  $\sigma$  (sigma) is a real quantity and is usually negative. Although we often refer to this function as being “damped,” it is conceivable that we might occasionally encounter a situation where  $\sigma > 0$  and hence the sinusoidal amplitude is increasing. (In Chap. 9, our study of the natural response of the *RLC* circuit also indicates that  $\sigma$  is the negative of the exponential damping coefficient.)

Note that we may construct a constant voltage from Eq. [1] by letting  $\sigma = \omega = 0$ :

$$v(t) = V_m \cos \theta = V_0 \quad [2]$$

If we set only  $\sigma$  equal to zero, then we obtain a general sinusoidal voltage

$$v(t) = V_m \cos(\omega t + \theta) \quad [3]$$

and if  $\omega = 0$ , we have the exponential voltage

$$v(t) = V_m \cos \theta e^{\sigma t} = V_0 e^{\sigma t} \quad [4]$$

Thus, the damped sinusoid of Eq. [1] includes as special cases the dc Eq. [2], sinusoidal Eq. [3], and exponential Eq. [4] functions.

Some additional insight into the significance of  $\sigma$  can be obtained by comparing the exponential function of Eq. [4] with the complex representation of a sinusoidal function with a zero-degree phase angle,

$$v(t) = V_0 e^{j\omega t} \quad [5]$$

It is apparent that the two functions, Eqs. [4] and [5], have much in common. The only difference is that the exponent in Eq. [4] is real and the one in Eq. [5] is imaginary. The similarity between the two functions is emphasized by describing  $\sigma$  as a “frequency.” This choice of terminology will be discussed in detail in the following sections, but for now we need merely note that  $\sigma$  is specifically termed the *real part* of the complex frequency. It should not be called the “real frequency,” however, for this is a term that is more suitable for  $f$  (or, loosely, for  $\omega$ ). We will also refer to  $\sigma$  as the *neper frequency*, the name arising from the dimensionless unit of the exponent of  $e$ . Thus, given  $e^{7t}$ , the dimensions of  $7t$  are *nepers* (Np), and 7 is the neper frequency in nepers per second.

## The General Form

The forced response of a network to a general forcing function of the form of Eq. [1] can be found very simply by using a method almost identical with that used in phasor-based analysis. Once we are able to find the forced response to this damped sinusoid, we will also have found the forced response to a dc voltage, an exponential voltage, and a sinusoidal voltage. First we consider  $\sigma$  and  $\omega$  as the real and imaginary parts of a complex frequency.

We suggest that any function that may be written in the form

$$f(t) = \mathbf{K} e^{st} \quad [6]$$

where  $\mathbf{K}$  and  $s$  are complex constants (independent of time) is characterized by the complex frequency  $s$ . The complex frequency  $s$  is therefore simply

The neper itself was named after the Scottish philosopher and mathematician John Napier (1550–1617) and his napierian logarithm system; the spelling of his name is historically uncertain (see, for example, H. A. Wheeler, *IRE Transactions on Circuit Theory* 2, 1955, p. 219).



the factor that multiplies  $t$  in this complex exponential representation. Until we are able to determine the complex frequency of a given function by inspection, it is necessary to write the function in the form of Eq. [6].

## The DC Case

We apply this definition first to the more familiar forcing functions. For example, a constant voltage

$$v(t) = V_0$$

may be written in the form

$$v(t) = V_0 e^{(0)t}$$

Therefore, we conclude that the complex frequency of a dc voltage or current is zero (i.e.,  $s = 0$ ).

## The Exponential Case

The next simple case is the exponential function

$$v(t) = V_0 e^{\sigma t}$$

which is already in the required form. The complex frequency of this voltage is therefore  $\sigma$  (i.e.,  $s = \sigma + j0$ ).

## The Sinusoidal Case

Now let us consider a sinusoidal voltage, one that may provide a slight surprise. Given

$$v(t) = V_m \cos(\omega t + \theta)$$

we desire to find an equivalent expression in terms of the complex exponential. From our past experience, we therefore use the formula we derived from Euler's identity,

$$\cos(\omega t + \theta) = \frac{1}{2} [e^{j(\omega t + \theta)} + e^{-j(\omega t + \theta)}]$$

and obtain

$$\begin{aligned} v(t) &= \frac{1}{2} V_m [e^{j(\omega t + \theta)} + e^{-j(\omega t + \theta)}] \\ &= \left(\frac{1}{2} V_m e^{j\theta}\right) e^{j\omega t} + \left(\frac{1}{2} V_m e^{-j\theta}\right) e^{-j\omega t} \end{aligned}$$

or

$$v(t) = \mathbf{K}_1 e^{s_1 t} + \mathbf{K}_2 e^{s_2 t}$$

We have the *sum* of two complex exponentials, and *two* complex frequencies are therefore present, one for each term. The complex frequency of the first term is  $s = s_1 = j\omega$ , and that of the second term is  $s = s_2 = -j\omega$ . These two values of  $s$  are **conjugates**, or  $s_2 = s_1^*$  and the two values of  $\mathbf{K}$  are also conjugates:  $\mathbf{K}_1 = \frac{1}{2} V_m e^{j\theta}$  and  $\mathbf{K}_2 = \mathbf{K}_1^* = \frac{1}{2} V_m e^{-j\theta}$ . The entire first term and the entire second term are therefore conjugates, which we might have expected inasmuch as their sum must be a real quantity,  $v(t)$ .

The complex conjugate of any number can be obtained by simply replacing all occurrences of "j" with "-j." The concept arises from our arbitrary choice of  $j = +\sqrt{-1}$ . However, the negative root is just as valid, which leads us to the definition of a complex conjugate.

## The Exponentially Damped Sinusoidal Case

Finally, let us determine the complex frequency or frequencies associated with the exponentially damped sinusoidal function, Eq. [1]. We again use Euler's formula to obtain a complex exponential representation:

$$\begin{aligned} v(t) &= V_m e^{\sigma t} \cos(\omega t + \theta) \\ &= \frac{1}{2} V_m e^{\sigma t} [e^{j(\omega t + \theta)} + e^{-j(\omega t + \theta)}] \end{aligned}$$

and thus

$$v(t) = \frac{1}{2} V_m e^{j\theta} e^{j(\sigma + j\omega)t} + \frac{1}{2} V_m e^{-j\theta} e^{j(\sigma - j\omega)t}$$

We find that a conjugate complex pair of frequencies,  $s_1 = \sigma + j\omega$  and  $s_2 = s_1^* = \sigma - j\omega$ , is also required to describe the exponentially damped sinusoid. In general, neither  $\sigma$  nor  $\omega$  is zero, and the exponentially varying sinusoidal waveform is the general case; the constant, sinusoidal, and exponential waveforms are special cases.

## The Relationship of $s$ to Reality

A positive real value of  $s$ , e.g.,  $s = 5 + j0$ , identifies an exponentially increasing function  $\mathbf{K}e^{+5t}$ , where  $\mathbf{K}$  must be real if the function is to be a physical one. A negative real value for  $s$ , such as  $s = -5 + j0$ , refers to an exponentially decreasing function  $\mathbf{K}e^{-5t}$ .

A purely imaginary value of  $s$ , such as  $j10$ , can never be associated with a purely real quantity. The functional form is  $\mathbf{K}e^{j10t}$ , which can also be written as  $\mathbf{K}(\cos 10t + j \sin 10t)$ ; it obviously possesses both a real and an imaginary part, each of which is sinusoidal. In order to construct a real function, it is necessary to consider conjugate values of  $s$ , such as  $s_{1,2} = \pm j10$ , with which must be associated conjugate values of  $\mathbf{K}$ . Loosely speaking, however, we may identify either of the complex frequencies  $s_1 = +j10$  or  $s_2 = -j10$  with a sinusoidal voltage at the radian frequency of 10 rad/s; the presence of the conjugate complex frequency is understood. The amplitude and phase angle of the sinusoidal voltage will depend on the choice of  $\mathbf{K}$  for each of the two frequencies. Thus, selecting  $s_1 = j10$  and  $\mathbf{K}_1 = 6 - j8$ , where

$$v(t) = \mathbf{K}_1 e^{s_1 t} + \mathbf{K}_2 e^{s_2 t} \quad s_2 = s_1^* \quad \text{and} \quad \mathbf{K}_2 = \mathbf{K}_1^*$$

we obtain the real sinusoid  $20 \cos(10t - 53.1^\circ)$ .

In a similar manner, a general value for  $s$ , such as  $3 - j5$ , can be associated with a real quantity only if it is accompanied by its conjugate,  $3 + j5$ . Speaking loosely again, we may think of either of these two conjugate frequencies as describing an exponentially increasing sinusoidal function,  $e^{3t} \cos 5t$ ; the specific amplitude and phase angle will again depend on the values of the conjugate complex  $\mathbf{K}$ 's.

By now we should have achieved some appreciation of the physical nature of the complex frequency  $s$ ; in general, it describes an exponentially varying sinusoid. The real part of  $s$  is associated with the exponential variation; if it is negative, the function decays as  $t$  increases; if it is positive, the function increases; and if it is zero, the sinusoidal amplitude is constant. The larger the *magnitude* of the real part of  $s$ , the greater is the rate of exponential increase or decrease. The imaginary part of  $s$  describes the sinusoidal variation; it is specifically the radian frequency. A large magnitude for the imaginary part of  $s$  indicates a more rapidly changing function of time.

Note that  $|6 - j8| = 10$ ,  
so that  $V_m = 2|\mathbf{K}| = 20$ .  
Also,  $\text{ang}(6 - j8) = -53.13^\circ$ .



Large magnitudes for the real part of  $s$ , the imaginary part of  $s$ , or the magnitude of  $s$  indicate a rapidly varying function.

It is customary to use the letter  $\sigma$  to designate the real part of  $s$ , and  $\omega$  (*not*  $j\omega$ ) to designate the imaginary part:

$$s = \sigma + j\omega \quad [7]$$

The radian frequency is sometimes referred to as the “real frequency,” but this terminology can be very confusing when we find that we must then say that “the real frequency is the imaginary part of the complex frequency”! When we need to be specific, we will call  $s$  the complex frequency,  $\sigma$  the neper frequency,  $\omega$  the radian frequency, and  $f = \omega/2\pi$  the cyclic frequency; when no confusion seems likely, it is permissible to use “frequency” to refer to any of these four quantities. The *neper frequency* is measured in nepers per second, *radian frequency* is measured in radians per second, and *complex frequency*  $s$  is measured in units which are variously termed complex nepers per second or complex radians per second.



### PRACTICE

14.1 Identify all the complex frequencies present in these real functions: (a)  $(2e^{-100t} + e^{-200t}) \sin 2000t$ ; (b)  $(2 - e^{-10t}) \cos(4t + \phi)$ ; (c)  $e^{-10t} \cos 10t \sin 40t$ .

14.2 Use real constants  $A$ ,  $B$ ,  $C$ ,  $\phi$ , and so forth, to construct the general form of the real function of time for a current having components at these frequencies: (a)  $0$ ,  $10$ ,  $-10 \text{ s}^{-1}$ ; (b)  $-5$ ,  $j8$ ,  $-5 - j8 \text{ s}^{-1}$ ; (c)  $-20$ ,  $20$ ,  $-20 + j20$ ,  $20 - j20 \text{ s}^{-1}$ .

Ans: 14.1:  $-100 + j2000$ ,  $-100 - j2000$ ,  $-200 + j2000$ ,  $-200 - j2000 \text{ s}^{-1}$ ;  $j4$ ,  $-j4$ ,  $-10 + j4$ ,  $-10 - j4 \text{ s}^{-1}$ ;  $-10 + j30$ ,  $-10 - j30$ ,  $-10 + j50$ ,  $-10 - j50 \text{ s}^{-1}$ ; 14.2:  $A + Be^{10t} + Ce^{-10t}$ ;  $Ae^{-5t} + B \cos(8t + \phi_1) + Ce^{-5t} \times \cos(8t + \phi_2)$ ;  $Ae^{-20t} + Be^{20t} + Ce^{-20t} \cos(20t + \phi_1) + De^{20t} \cos(20t + \phi_2)$ .

## 14.2 THE DAMPED SINUSOIDAL FORCING FUNCTION

It is time to put this concept of complex frequency to work.

The general exponentially varying sinusoid, which we may represent with the voltage function

$$v(t) = V_m e^{\sigma t} \cos(\omega t + \theta) \quad [8]$$

can be expressed in terms of the complex frequency  $s$  by making use of Euler's identity as before:

$$v(t) = \text{Re}\{V_m e^{\sigma t} e^{j(\omega t + \theta)}\} \quad [9]$$

or

$$v(t) = \text{Re}\{V_m e^{\sigma t} e^{j(-\omega t - \theta)}\} \quad [10]$$

Either representation is suitable, and the two expressions should remind us that a *pair* of conjugate complex frequencies is associated with a sinusoid or an exponentially damped sinusoid. Equation [9] is more directly related to the given damped sinusoid, and we will concern ourselves principally with it.

Collecting factors, we now substitute  $\mathbf{s} = \sigma + j\omega$  into

$$v(t) = \operatorname{Re}\{V_m e^{j\theta} e^{(\sigma + j\omega)t}\}$$

and obtain

$$v(t) = \operatorname{Re}\{V_m e^{j\theta} e^{st}\} \quad [11]$$

Before we apply a forcing function of this form to any circuit, we note the resemblance of this last representation of the damped sinusoid to the corresponding representation of the *undamped* sinusoid in Chap. 10,

$$\operatorname{Re}\{V_m e^{j\theta} e^{j\omega t}\}$$

The only difference is that we now have  $\mathbf{s}$  where we previously had  $j\omega$ . Instead of restricting ourselves to sinusoidal forcing functions and their radian frequencies, we have now extended our notation to include the damped sinusoidal forcing function at a complex frequency. It should be no surprise at all to see later in this section that we will develop a *frequency-domain* description of the exponentially damped sinusoid in exactly the same way that we did for the sinusoid; we will simply omit the  $\operatorname{Re}\{\}$  notation and suppress  $e^{st}$ .

We are now ready to apply the exponentially damped sinusoid, as given by Eq. [8], [9], [10], or [11], to an electrical network, where the forced response—perhaps a current in some branch of the network—is desired. Since the forced response has the form of the forcing function, its integral, and its derivatives, the response may be assumed to be

$$i(t) = I_m e^{\sigma t} \cos(\omega t + \phi)$$

or

$$i(t) = \operatorname{Re}\{I_m e^{j\phi} e^{st}\}$$

where the complex frequency of both the source and the response must be identical.



If we now recall that the *real* part of a complex forcing function produces the *real* part of the response while the *imaginary* part of the complex forcing function causes the *imaginary* part of the response, then we are again led to the application of a *complex* forcing function to our network. We will obtain a complex response whose real part is the desired real response. Actually, we will work with the  $\operatorname{Re}\{\}$  notation omitted, but we should realize that it may be reinserted at any time and that it *must* be reinserted whenever we desire the time-domain response. Thus, given the real forcing function

$$v(t) = \operatorname{Re}\{V_m e^{j\theta} e^{st}\}$$

we apply the complex forcing function  $V_m e^{j\theta} e^{st}$ ; the resultant forced response  $I_m e^{j\phi} e^{st}$  is complex, and it must have as its real part the desired time-domain forced response

$$i(t) = \operatorname{Re}\{I_m e^{j\phi} e^{st}\}$$

The solution of our circuit analysis problem consists of the determination of the unknown response amplitude  $I_m$  and phase angle  $\phi$ .

Before we actually carry out the details of an analysis problem and see how the procedure resembles what we used in sinusoidal analysis, it is worthwhile to outline the steps of the basic method.

1. We first characterize the circuit with a set of loop or nodal integrodifferential equations.
2. The given forcing functions, in complex form, and the assumed forced responses, also in complex form, are substituted in the equations and the indicated integrations and differentiations are performed.
3. Each term in every equation will then contain the same factor  $e^{st}$ . We divide throughout by this factor, or “suppress  $e^{st}$ ,” understanding that it must be reinserted if a time-domain description of any response function is desired.

With the  $\text{Re}\{\}$  notation and the  $e^{st}$  factor gone, we have converted all the voltages and currents from the *time domain* to the *frequency domain*. The integrodifferential equations become algebraic equations, and their solution is obtained just as easily as in the sinusoidal steady state. Let us illustrate the basic method by a numerical example.

## EXAMPLE 14.1

Apply the forcing function  $v(t) = 60e^{-2t} \cos(4t + 10^\circ)$  V to the series RLC circuit shown in Fig. 14.1, and specify the forced response by finding values for  $I_m$  and  $\phi$  in the time-domain expression  $i(t) = I_m e^{-2t} \cos(4t + \phi)$ .

We first express the forcing function in  $\text{Re}\{\}$  notation:

$$\begin{aligned} v(t) &= 60e^{-2t} \cos(4t + 10^\circ) = \text{Re}\{60e^{-2t} e^{j(4t+10^\circ)}\} \\ &= \text{Re}\{60e^{j10^\circ} e^{(-2+j4)t}\} \end{aligned}$$

or

$$v(t) = \text{Re}\{\mathbf{V}e^{st}\}$$

where

$$\mathbf{V} = 60/10^\circ \quad \text{and} \quad s = -2 + j4$$

After dropping  $\text{Re}\{\}$ , we are left with the complex forcing function

$$60/10^\circ e^{st}$$

Similarly, we represent the unknown response by the complex quantity  $\mathbf{I}e^{st}$ , where  $\mathbf{I} = I_m \angle \phi$ .

Our next step must be the integrodifferential equation for the circuit. From Kirchhoff's voltage law, we obtain

$$v(t) = Ri + L \frac{di}{dt} + \frac{1}{C} \int i dt = 2i + 3 \frac{di}{dt} + 10 \int i dt$$

(Continued on next page)

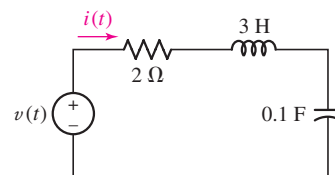

FIGURE 14.1 A series RLC circuit to which a damped sinusoidal forcing function is applied. A frequency-domain solution for  $i(t)$  is desired.

If the notation here seems unfamiliar, the reader may wish to pause and read Appendix 5, particularly section 4, which deals with the polar form of complex number representation.

and we substitute the given complex forcing function and the assumed complex forced response in this equation:

$$60/10^\circ e^{st} = 2\mathbf{I}e^{st} + 3s\mathbf{I}e^{st} + \frac{10}{s}\mathbf{I}e^{st}$$

The common factor  $e^{st}$  is next suppressed:

$$60/10^\circ = 2\mathbf{I} + 3s\mathbf{I} + \frac{10}{s}\mathbf{I}$$

and thus

$$\mathbf{I} = \frac{60/10^\circ}{2 + 3s + 10/s}$$

We now let  $s = -2 + j4$  and solve for the complex current  $\mathbf{I}$ :

$$\mathbf{I} = \frac{60/10^\circ}{2 + 3(-2 + j4) + 10/(-2 + j4)}$$

After manipulating the complex numbers, we find

$$\mathbf{I} = 5.37/-106.6^\circ$$

Thus,  $I_m$  is 5.37 A,  $\phi$  is  $-106.6^\circ$ , and the forced response can be written directly (recalling that  $s = -2 + j4$ ) as

$$i(t) = 5.37e^{-2t} \cos(4t - 106.6^\circ) \text{ A}$$

We have thus solved the problem by reducing a *calculus*-based expression to an *algebraic* expression. This is only a small indication of the power of the technique we are about to study.

### PRACTICE

14.3 Give the phasor current that is equivalent to the time-domain current: (a)  $24 \sin(90t + 60^\circ)$  A; (b)  $24e^{-10t} \cos(90t + 60^\circ)$  A; (c)  $24e^{-10t} \cos 60^\circ \times \cos 90t$  A. If  $\mathbf{V} = 12/35^\circ$  V, find  $v(t)$  for  $s$  equal to (d) 0; (e)  $-20 \text{ s}^{-1}$ ; (f)  $-20 + j5 \text{ s}^{-1}$ .

Ans:  $24/-30^\circ$  A;  $24/60^\circ$  A;  $12/0^\circ$  A; 9.83 V;  $9.83e^{-20t}$  V;  $12e^{-20t} \cos(5t + 35^\circ)$  V.

## 14.3 DEFINITION OF THE LAPLACE TRANSFORM

Our constant goal has been one of analysis: given some forcing function at one point in a linear circuit, determine the response at some other point. For the first several chapters, we played only with dc forcing functions and responses of the form  $V_0e^0$ . However, after the introduction of inductance and capacitance, the sudden dc excitation of simple  $RL$  and  $RC$  circuits produced responses varying exponentially with time:  $V_0e^{\sigma t}$ . When we considered the  $RLC$  circuit, the responses took on the form of the exponentially varying sinusoid,  $V_0e^{\sigma t} \cos(\omega t + \theta)$ . All this work was accomplished in the time domain, and the dc forcing function was the only one we considered.

As we advanced to the use of the sinusoidal forcing function, the tedium and complexity of solving the integrodifferential equations caused us to

begin casting about for an easier way to work problems. The phasor transform was the result, and we might remember that we were led to it through consideration of a complex forcing function of the form  $V_0 e^{j\theta} e^{j\omega t}$ . As soon as we concluded that we did not need the factor containing  $t$ , we were left with the phasor  $V_0 e^{j\theta}$ ; we had arrived at the *frequency domain*.

Now a little flexing of our cerebral cortex has caused us to apply a forcing function of the form  $V_0 e^{j\theta} e^{(\sigma + j\omega)t}$ , leading to the invention of the complex frequency  $s$ , and thereby relegating all our previous functional forms to special cases: dc ( $s = 0$ ), exponential ( $s = \sigma$ ), sinusoidal ( $s = j\omega$ ), and exponential sinusoid ( $s = \sigma + j\omega$ ). By analogy to our previous experience with phasors, we saw that in these cases we may omit the factor containing  $t$ , and once again obtain a solution by working in the frequency domain.

## The Two-Sided Laplace Transform

We know that sinusoidal forcing functions lead to sinusoidal responses, and also that exponential forcing functions lead to exponential responses. However, as practicing engineers we will encounter many waveforms that are neither sinusoidal nor exponential, such as square waves, sawtooth waveforms, and pulses beginning at arbitrary instants of time. When such forcing functions are applied to a linear circuit, we will see that the response is neither similar to the form of the excitation waveform nor exponential. As a result, we are not able to eliminate the terms containing  $t$  to form a frequency-domain response. This is rather unfortunate, as working in the frequency domain has proved to be rather useful.

There is a solution, however, which makes use of a technique that allows us to expand any function into a *sum* of exponential waveforms, each with its own complex frequency. Since we are considering linear circuits, we know that the total response of our circuit can be obtained by simply adding the individual response to each exponential waveform. And, in dealing with each exponential waveform, we may once again neglect any terms containing  $t$ , and work instead in the *frequency domain*. It unfortunately takes an infinite number of exponential terms to accurately represent a general time function, so that taking a brute-force approach and applying superposition to the exponential series might be somewhat insane. Instead, we will sum these terms by performing an integration, leading to a frequency-domain function.

We formalize this approach using what is known as a **Laplace transform**, defined for a general function  $f(t)$  as

$$\mathbf{F}(s) = \int_{-\infty}^{\infty} e^{-st} f(t) dt \quad [12]$$

The mathematical derivation of this integral operation requires an understanding of Fourier series and the Fourier transform, which are discussed in Chap. 18. The fundamental concept behind the Laplace transform, however, can be understood based on our discussion of complex frequency and our prior experience with phasors and converting back and forth between the time domain and the frequency domain. In fact, that is precisely what the Laplace transform does: it converts the general time-domain function  $f(t)$  into a corresponding frequency-domain representation,  $\mathbf{F}(s)$ .

## The Two-Sided Inverse Laplace Transform

Equation [12] defines the *two-sided*, or *bilateral*, Laplace transform of  $f(t)$ . The term *two-sided* or *bilateral* is used to emphasize the fact that both positive and negative values of  $t$  are included in the range of integration. The inverse operation, often referred to as the *inverse Laplace transform*, is also defined as an integral expression<sup>1</sup>

$$f(t) = \frac{1}{2\pi j} \int_{\sigma_0 - j\infty}^{\sigma_0 + j\infty} e^{st} \mathbf{F}(s) ds \quad [13]$$

where the real constant  $\sigma_0$  is included in the limits to ensure convergence of this improper integral; the two equations [12] and [13] constitute the two-sided Laplace transform pair. The good news is that Eq. [13] need never be invoked in the study of circuit analysis: there is a quick and easy alternative to look forward to learning.

## The One-Sided Laplace Transform

In many of our circuit analysis problems, the forcing and response functions do not exist forever in time, but rather they are initiated at some specific instant that we usually select as  $t = 0$ . Thus, for time functions that do not exist for  $t < 0$ , or for those time functions whose behavior for  $t < 0$  is of no interest, the time-domain description can be thought of as  $v(t)u(t)$ . The defining integral for the Laplace transform is taken with the lower limit at  $t = 0^-$  in order to include the effect of any discontinuity at  $t = 0$ , such as an impulse or a higher-order singularity. The corresponding Laplace transform is then

$$\mathbf{F}(s) = \int_{-\infty}^{\infty} e^{-st} f(t)u(t) dt = \int_{0^-}^{\infty} e^{-st} f(t) dt$$

This defines the *one-sided* Laplace transform of  $f(t)$ , or simply the *Laplace transform* of  $f(t)$ , one-sided being understood. The inverse transform expression remains unchanged, but when evaluated, it is understood to be valid only for  $t > 0$ . Here then is the definition of the Laplace transform pair that we will use from now on:

$$\mathbf{F}(s) = \int_{0^-}^{\infty} e^{-st} f(t) dt \quad [14]$$

$$f(t) = \frac{1}{2\pi j} \int_{\sigma_0 - j\infty}^{\sigma_0 + j\infty} e^{st} \mathbf{F}(s) ds \quad [15]$$

$$f(t) \Leftrightarrow \mathbf{F}(s)$$

The script  $\mathcal{L}$  may also be used to indicate the direct or inverse Laplace transform operation:

$$\mathbf{F}(s) = \mathcal{L}\{f(t)\} \quad \text{and} \quad f(t) = \mathcal{L}^{-1}\{\mathbf{F}(s)\}$$

(1) If we ignore the distracting factor of  $1/2\pi j$  and view the integral as a summation over all frequencies such that  $f(t) \propto \sum[\mathbf{F}(s) ds]e^{st}$ , this reinforces the notion that  $f(t)$  is indeed a sum of complex frequency terms having a magnitude proportional to  $\mathbf{F}(s)$ .



## EXAMPLE 14.2

Compute the Laplace transform of the function  $f(t) = 2u(t - 3)$ .

In order to find the one-sided Laplace transform of  $f(t) = 2u(t - 3)$ , we must evaluate the integral

$$\begin{aligned} \mathbf{F}(s) &= \int_{0^-}^{\infty} e^{-st} f(t) dt \\ &= \int_{0^-}^{\infty} e^{-st} 2u(t - 3) dt \\ &= 2 \int_3^{\infty} e^{-st} dt \end{aligned}$$

Simplifying, we find

$$\mathbf{F}(s) = \frac{-2}{s} e^{-st} \Big|_3^{\infty} = \frac{-2}{s} (0 - e^{-3s}) = \frac{2}{s} e^{-3s}$$

## PRACTICE

14.4 Let  $f(t) = -6e^{-2t}[u(t + 3) - u(t - 2)]$ . Find the (a) two-sided  $\mathbf{F}(s)$ ; (b) one-sided  $\mathbf{F}(s)$ .

Ans:  $\frac{6}{2+s}[e^{-4-2s} - e^{6+3s}]$ ;  $\frac{6}{2+s}[e^{-4-2s} - 1]$ .

## 14.4 LAPLACE TRANSFORMS OF SIMPLE TIME FUNCTIONS

In this section we will begin to build up a catalog of Laplace transforms for those time functions most frequently encountered in circuit analysis; we will assume for now that the function of interest is a voltage, although such a choice is strictly arbitrary. We will create this catalog, at least initially, by utilizing the definition,

$$\mathbf{V}(s) = \int_{0^-}^{\infty} e^{-st} v(t) dt = \mathcal{L}\{v(t)\}$$

which, along with the expression for the inverse transform,

$$v(t) = \frac{1}{2\pi j} \int_{\sigma_0 - j\infty}^{\sigma_0 + j\infty} e^{st} \mathbf{V}(s) ds = \mathcal{L}^{-1}\{\mathbf{V}(s)\}$$

establishes a one-to-one correspondence between  $v(t)$  and  $\mathbf{V}(s)$ . That is, for every  $v(t)$  for which  $\mathbf{V}(s)$  exists, there is a unique  $\mathbf{V}(s)$ . At this point, we may be looking with some trepidation at the rather ominous form given for the inverse transform. Fear not! As we will see shortly, *an introductory study of Laplace transform theory does not require actual evaluation of this integral*. By going from the time domain to the frequency domain and taking advantage of the uniqueness just mentioned, we will be able to generate a catalog of transform pairs that will already contain the corresponding time function for nearly every transform that we wish to invert.

Before we continue, however, we should pause to consider whether there is any chance that the transform may not even exist for some  $v(t)$  that concerns us. A set of conditions sufficient to ensure the absolute convergence of the Laplace integral for  $\text{Re}\{s\} > \sigma_0$  is



1. The function  $v(t)$  is integrable in every finite interval  $t_1 < t < t_2$ , where  $0 \leq t_1 < t_2 < \infty$ .
2.  $\lim_{t \rightarrow \infty} e^{-\sigma_0 t} |v(t)|$  exists for some value of  $\sigma_0$ .

Time functions that do not satisfy these conditions are seldom encountered by the circuit analyst.<sup>2</sup>

## The Unit-Step Function $u(t)$

Now let us look at some specific transforms. We first examine the Laplace transform of the unit-step function  $u(t)$ . From the defining equation, we may write

$$\begin{aligned} \mathcal{L}\{u(t)\} &= \int_{0^-}^{\infty} e^{-st} u(t) dt = \int_0^{\infty} e^{-st} dt \\ &= -\frac{1}{s} e^{-st} \Big|_0^{\infty} = \frac{1}{s} \end{aligned}$$

for  $\text{Re}\{s\} > 0$ , to satisfy condition 2. Thus,

$$u(t) \Leftrightarrow \frac{1}{s} \quad [16]$$

and our first Laplace transform pair has been established with great ease.

## The Unit-Impulse Function $\delta(t - t_0)$

A singularity function whose transform is of considerable interest is the unit-impulse function  $\delta(t - t_0)$ . This function, plotted in Fig. 14.2, seems rather strange at first but is enormously useful in practice. The unit-impulse function is defined to have an area of unity, so that

$$\begin{aligned} \delta(t - t_0) &= 0 \quad t \neq t_0 \\ \int_{t_0 - \varepsilon}^{t_0 + \varepsilon} \delta(t - t_0) dt &= 1 \end{aligned}$$

where  $\varepsilon$  is a small constant. Thus, this “function” (a naming that makes many purist mathematicians cringe) has a nonzero value only at the point  $t_0$ . For  $t_0 > 0^-$ , we therefore find the Laplace transform to be

$$\begin{aligned} \mathcal{L}\{\delta(t - t_0)\} &= \int_{0^-}^{\infty} e^{-st} \delta(t - t_0) dt = e^{-st_0} \\ \delta(t - t_0) &\Leftrightarrow e^{-st_0} \end{aligned} \quad [17]$$

(2) Examples of such functions are  $e^{t^2}$  and  $e^{e^t}$ , but not  $t^n$  or  $n^t$ . For a somewhat more detailed discussion of the Laplace transform and its applications, refer to Clare D. McGillem and George R. Cooper, *Continuous and Discrete Signal and System Analysis*, 3d ed. Oxford University Press, North Carolina: 1991, Chap. 5.

The double arrow notation is commonly used to indicate Laplace transform pairs.

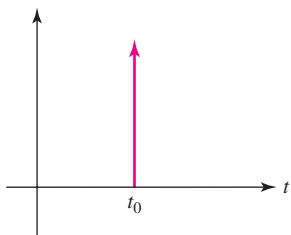

■ FIGURE 14.2 The unit-impulse function  $\delta(t - t_0)$ . This function is often used to approximate a signal pulse whose duration is very short compared to circuit time constants.

In particular, note that we obtain

$$\delta(t) \Leftrightarrow 1 \quad [18]$$

for  $t_0 = 0$ .

An interesting feature of the unit-impulse function is known as the **sifting property**. Consider the integral of the impulse function multiplied by an arbitrary function  $f(t)$ :

$$\int_{-\infty}^{\infty} f(t)\delta(t - t_0) dt$$

Since the function  $\delta(t - t_0)$  is zero everywhere except at  $t = t_0$ , the value of this integral is simply  $f(t_0)$ . The property turns out to be *very* useful in simplifying integral expressions containing the unit-impulse function.

### The Exponential Function $e^{-\alpha t}$

Recalling our past interest in the exponential function, we examine its transform,

$$\begin{aligned} \mathcal{L}\{e^{-\alpha t}u(t)\} &= \int_{0^-}^{\infty} e^{-\alpha t}e^{-st} dt \\ &= -\frac{1}{s + \alpha}e^{-(s+\alpha)t} \Big|_0^{\infty} = \frac{1}{s + \alpha} \end{aligned}$$

and therefore,

$$e^{-\alpha t}u(t) \Leftrightarrow \frac{1}{s + \alpha} \quad [19]$$

It is understood that  $\text{Re}\{s\} > -\alpha$ .

### The Ramp Function $tu(t)$

As a final example, for the moment, let us consider the ramp function  $tu(t)$ . We obtain

$$\begin{aligned} \mathcal{L}\{tu(t)\} &= \int_{0^-}^{\infty} te^{-st} dt = \frac{1}{s^2} \\ tu(t) &\Leftrightarrow \frac{1}{s^2} \end{aligned} \quad [20]$$

either by a straightforward integration by parts or from a table of integrals.

So what of the function  $te^{-\alpha t}u(t)$ ? We leave it to the reader to show that

$$te^{-\alpha t}u(t) \Leftrightarrow \frac{1}{(s + \alpha)^2} \quad [21]$$

There are, of course, quite a few additional time functions worth considering, but it may be best if we pause for the moment to consider the reverse of the process—the inverse Laplace transform—before returning to add to our list.

## PRACTICE

14.5 Determine  $\mathbf{V}(s)$  if  $v(t)$  equals (a)  $4\delta(t) - 3u(t)$ ;  
(b)  $4\delta(t - 2) - 3tu(t)$ ; (c)  $[u(t)][u(t - 2)]$ .

14.6 Determine  $v(t)$  if  $\mathbf{V}(s)$  equals (a)  $10$ ; (b)  $10/s$ ; (c)  $10/s^2$ ;  
(d)  $10/[s(s + 10)]$ ; (e)  $10s/(s + 10)$ .

Ans: 14.5:  $(4s - 3)/s$ ;  $4e^{-2s} - (3/s^2)$ ;  $e^{-2s}/s$ . 14.6:  $10\delta(t)$ ;  $10u(t)$ ;  $10tu(t)$ ;  
 $u(t) - e^{-10t}u(t)$ ;  $10\delta(t) - 100e^{-10t}u(t)$ .

## 14.5 INVERSE TRANSFORM TECHNIQUES

## The Linearity Theorem

Although we mentioned that Eq. [13] can be applied to convert an  $s$ -domain expression into a time-domain expression, we also alluded to the fact that this is more work than required—if we're willing to exploit the uniqueness of any Laplace transform pair. In order to fully capitalize on this fact, we must first introduce one of several helpful and well-known Laplace transform theorems—the **linearity theorem**. This theorem states that the Laplace transform of the sum of two or more time functions is equal to the sum of the transforms of the individual time functions. For two time functions we have

$$\begin{aligned}\mathcal{L}\{f_1(t) + f_2(t)\} &= \int_{0^-}^{\infty} e^{-st} [f_1(t) + f_2(t)] dt \\ &= \int_{0^-}^{\infty} e^{-st} f_1(t) dt + \int_{0^-}^{\infty} e^{-st} f_2(t) dt \\ &= \mathbf{F}_1(s) + \mathbf{F}_2(s)\end{aligned}$$

This is known as the “additive property” of the Laplace transform.

As an example of the use of this theorem, suppose that we have a Laplace transform  $\mathbf{V}(s)$  and want to know the corresponding time function  $v(t)$ . It will often be possible to decompose  $\mathbf{V}(s)$  into the sum of two or more functions, e.g.,  $\mathbf{V}_1(s)$  and  $\mathbf{V}_2(s)$ , whose inverse transforms,  $v_1(t)$  and  $v_2(t)$ , are already tabulated. It then becomes a simple matter to apply the linearity theorem and write

$$\begin{aligned}v(t) &= \mathcal{L}^{-1}\{\mathbf{V}(s)\} = \mathcal{L}^{-1}\{\mathbf{V}_1(s) + \mathbf{V}_2(s)\} \\ &= \mathcal{L}^{-1}\{\mathbf{V}_1(s)\} + \mathcal{L}^{-1}\{\mathbf{V}_2(s)\} = v_1(t) + v_2(t)\end{aligned}$$

Another important consequence of the linearity theorem is evident by studying the definition of the Laplace transform. Since we are working with an integral, *the Laplace transform of a constant times a function is equal to the constant times the Laplace transform of the function*. In other words,

$$\mathcal{L}\{kv(t)\} = k\mathcal{L}\{v(t)\}$$

or

$$kv(t) \Leftrightarrow k\mathbf{V}(s) \quad [22]$$

This is known as the “homogeneity property” of the Laplace transform.

where  $k$  is a constant of proportionality. This result is extremely handy in many situations that arise from circuit analysis, as we will see.

## EXAMPLE 14.3

Given the function  $G(s) = (7/s) - 31/(s + 17)$ , obtain  $g(t)$ .

This  $s$ -domain function is composed of the sum of two terms,  $7/s$  and  $-31/(s + 17)$ . Through the linearity theorem we know that  $g(t)$  will be composed of two terms as well, each the inverse Laplace transform of one of the two  $s$ -domain terms:

$$g(t) = \mathcal{L}^{-1} \left\{ \frac{7}{s} \right\} - \mathcal{L}^{-1} \left\{ \frac{31}{s + 17} \right\}$$

Let's begin with the first term. The homogeneity property of the Laplace transform allows us to write that

$$\mathcal{L}^{-1} \left\{ \frac{7}{s} \right\} = 7\mathcal{L}^{-1} \left\{ \frac{1}{s} \right\} = 7u(t)$$

Thus, we have made use of the known transform pair  $u(t) \Leftrightarrow 1/s$  and the homogeneity property to find this first component of  $g(t)$ . In a similar fashion, we find that  $\mathcal{L}^{-1} \left\{ \frac{31}{s + 17} \right\} = 31e^{-17t}u(t)$ . Putting these two terms together,

$$g(t) = [7 - 31e^{-17t}]u(t)$$

## PRACTICE

14.7 Given  $\mathbf{H}(s) = \frac{2}{s} - \frac{4}{s^2} + \frac{3.5}{(s + 10)(s + 10)}$ , obtain  $h(t)$ .

Ans:  $h(t) = [2 - 4t + 3.5te^{-10t}]u(t)$ .

## Inverse Transform Techniques for Rational Functions

In analyzing circuits with multiple energy storage elements, we will often encounter  $s$ -domain expressions that are ratios of  $s$ -polynomials. We thus expect to routinely encounter expressions of the form

$$\mathbf{V}(s) = \frac{\mathbf{N}(s)}{\mathbf{D}(s)}$$

where  $\mathbf{N}(s)$  and  $\mathbf{D}(s)$  are polynomials in  $s$ . The values of  $s$  which lead to  $\mathbf{N}(s) = 0$  are referred to as **zeros** of  $\mathbf{V}(s)$ , and those values of  $s$  which lead to  $\mathbf{D}(s) = 0$  are referred to as **poles** of  $\mathbf{V}(s)$ .

Rather than rolling up our sleeves and invoking Eq. [13] each time we need to find an inverse transform, it is often possible to decompose these expressions using the method of residues into simpler terms whose inverse transforms are already known. The criterion for this is that  $\mathbf{V}(s)$  must be a **rational function** for which the degree of the numerator  $\mathbf{N}(s)$  must be less than that of the denominator  $\mathbf{D}(s)$ . If it is not, we must first perform a simple division step, as shown in the following example. The result will include an impulse function (assuming the degree of the numerator is the same as that of the denominator) and a rational function. The inverse transform of the first is simple; the straightforward method of residues applies to the rational function if its inverse transform is not already known.



In practice, it is seldom necessary to ever invoke Eq. [13] for functions encountered in circuit analysis, provided that we are clever in using the various techniques presented in this chapter.

## EXAMPLE 14.4

Calculate the inverse transform of  $F(s) = 2\frac{s+2}{s}$ .

Since the degree of the numerator is equal to the degree of the denominator,  $F(s)$  is *not* a rational function. Thus, we begin by performing long division:

$$F(s) = s \overline{)2s + 4}$$

$$\underline{2s}$$

$$4$$

so that  $F(s) = 2 + (4/s)$ . By the linearity theorem,

$$\mathcal{L}^{-1}\{F(s)\} = \mathcal{L}^{-1}\{2\} + \mathcal{L}^{-1}\left\{\frac{4}{s}\right\} = 2\delta(t) + 4u(t)$$

(It should be noted that this particular function can be simplified without the process of long division; such a route was chosen to provide an example of the basic process.)

## PRACTICE

14.8 Given the function  $Q(s) = \frac{3s^2 - 4}{s^2}$ , find  $q(t)$ .

Ans:  $q(t) = 3\delta(t) - 4tu(t)$ .



In employing the method of residues, essentially performing a partial fraction expansion of  $V(s)$ , we focus our attention on the roots of the denominator. Thus, it is first necessary to factor the  $s$ -polynomial that comprises  $D(s)$  into a product of binomial terms. The roots of  $D(s)$  may be any combination of distinct or repeated roots, and may be real or complex. It is worth noting, however, that complex roots always occur as conjugate pairs, provided that the coefficients of  $D(s)$  are real.

## Distinct Poles and the Method of Residues

As a specific example, let us determine the inverse Laplace transform of

$$V(s) = \frac{1}{(s + \alpha)(s + \beta)}$$

The denominator has been factored into two distinct roots,  $-\alpha$  and  $-\beta$ . Although it is possible to substitute this expression in the defining equation for the inverse transform, it is much easier to utilize the linearity theorem. Using partial-fraction expansion, we can split the given transform into the sum of two simpler transforms,

$$V(s) = \frac{A}{s + \alpha} + \frac{B}{s + \beta}$$

where  $A$  and  $B$  may be found by any of several methods. Perhaps the quickest solution is obtained by recognizing that

$$A = \lim_{s \rightarrow -\alpha} \left[ (s + \alpha)V(s) - \frac{(s + \alpha)}{(s + \beta)}B \right]$$

$$= \lim_{s \rightarrow -\alpha} \left[ \frac{1}{s + \beta} - 0 \right] = \frac{1}{\beta - \alpha}$$

In this equation, we use the single-fraction (i.e., nonexpanded) version of  $V(s)$ .

Recognizing that the second term is always zero, in practice we would simply write

$$A = (s + \alpha)\mathbf{V}(s)|_{s=-\alpha}$$

Similarly,

$$B = (s + \beta)\mathbf{V}(s)|_{s=-\beta} = \frac{1}{\alpha - \beta}$$

and therefore,

$$\mathbf{V}(s) = \frac{1/(\beta - \alpha)}{s + \alpha} + \frac{1/(\alpha - \beta)}{s + \beta}$$

We have already evaluated inverse transforms of this form, and so

$$\begin{aligned} v(t) &= \frac{1}{\beta - \alpha}e^{-\alpha t}u(t) + \frac{1}{\alpha - \beta}e^{-\beta t}u(t) \\ &= \frac{1}{\beta - \alpha}(e^{-\alpha t} - e^{-\beta t})u(t) \end{aligned}$$

If we wished, we could now include this as a new entry in our catalog of Laplace pairs,

$$\frac{1}{\beta - \alpha}(e^{-\alpha t} - e^{-\beta t})u(t) \Leftrightarrow \frac{1}{(s + \alpha)(s + \beta)}$$

This approach is easily extended to functions whose denominators are higher-order  $s$ -polynomials, although the operations can become somewhat tedious. It should also be noted that we did not specify that the constants  $A$  and  $B$  must be real. However, in situations where  $\alpha$  and  $\beta$  are complex, we will find that  $\alpha$  and  $\beta$  are also complex conjugates (this is not required mathematically, but is required for physical circuits). In such instances, we will also find that  $A = B^*$ ; in other words, the coefficients will be complex conjugates as well.



## EXAMPLE 14.5

**Determine the inverse transform of**

$$\mathbf{P}(s) = \frac{7s + 5}{s^2 + s}$$

We see that  $\mathbf{P}(s)$  is a rational function (the degree of the numerator is *one*, whereas the degree of the denominator is *two*), so we begin by factoring the denominator and write:

$$\mathbf{P}(s) = \frac{7s + 5}{s(s + 1)} = \frac{a}{s} + \frac{b}{s + 1}$$

where our next step is to determine values for  $a$  and  $b$ . Applying the method of residues,

$$a = \left. \frac{7s + 5}{s + 1} \right|_{s=0} = 5 \quad \text{and} \quad b = \left. \frac{7s + 5}{s} \right|_{s=-1} = 2$$

(Continued on next page)

We may now write  $\mathbf{P}(s)$  as

$$\mathbf{P}(s) = \frac{5}{s} + \frac{2}{s+1}$$

the inverse transform of which is simply  $p(t) = [5 + 2e^{-t}]u(t)$ .

### PRACTICE

14.9 Given the function  $\mathbf{Q}(s) = \frac{11s + 30}{s^2 + 3s}$ , find  $q(t)$ .

Ans:  $q(t) = [10 + e^{-3t}]u(t)$ .

## Repeated Poles

A closely related situation is that of repeated poles. Consider the function

$$\mathbf{V}(s) = \frac{\mathbf{N}(s)}{(s-p)^n}$$

which we want to expand into

$$\mathbf{V}(s) = \frac{a_n}{(s-p)^n} + \frac{a_{n-1}}{(s-p)^{n-1}} + \cdots + \frac{a_1}{(s-p)}$$

To determine each constant, we first multiply the nonexpanded version of  $\mathbf{V}(s)$  by  $(s-p)^n$ . The constant  $a_n$  is found by evaluating the resulting expression at  $s = p$ . The remaining constants are found by differentiating the expression  $(s-p)^n \mathbf{V}(s)$  the appropriate number of times prior to evaluating at  $s = p$ , and dividing by a factorial term. The differentiation procedure removes the constants previously found, and evaluating at  $s = p$  removes the remaining constants.

For example,  $a_{n-2}$  is found by evaluating

$$\frac{1}{2!} \frac{d^2}{ds^2} [(s-p)^n \mathbf{V}(s)]_{s=p}$$

and the term  $a_{n-k}$  is found by evaluating

$$\frac{1}{k!} \frac{d^k}{ds^k} [(s-p)^n \mathbf{V}(s)]_{s=p}$$

To illustrate the basic procedure, let's find the inverse Laplace transform of a function having a combination of both situations: one pole at  $s = 0$  and two poles at  $s = -6$ .

### EXAMPLE 14.6

Compute the inverse transform of the function

$$\mathbf{V}(s) = \frac{2}{s^3 + 12s^2 + 36s}$$

We note that the denominator can be easily factored, leading to

$$\mathbf{V}(s) = \frac{2}{s(s+6)(s+6)} = \frac{2}{s(s+6)^2}$$



As promised, we see that there are indeed three poles, one at  $s = 0$ , and two at  $s = -6$ . Next, we expand the function into

$$\mathbf{V}(s) = \frac{a_1}{(s+6)^2} + \frac{a_2}{(s+6)} + \frac{a_3}{s}$$

and apply our new procedure to obtain the unknown constants  $a_1$  and  $a_2$ ; we will find  $a_3$  using the previous procedure. Thus,

$$a_1 = \left[ (s+6)^2 \frac{2}{s(s+6)^2} \right]_{s=-6} = \frac{2}{s} \Big|_{s=-6} = -\frac{1}{3}$$

and

$$a_2 = \frac{d}{ds} \left[ (s+6)^2 \frac{2}{s(s+6)^2} \right]_{s=-6} = \frac{d}{ds} \left( \frac{2}{s} \right) \Big|_{s=-6} = -\frac{2}{s^2} \Big|_{s=-6} = -\frac{1}{18}$$

The remaining constant  $a_3$  is found using the procedure for distinct poles

$$a_3 = s \frac{2}{s(s+6)^2} \Big|_{s=0} = \frac{2}{6^2} = \frac{1}{18}$$

Thus, we may now write  $\mathbf{V}(s)$  as

$$\mathbf{V}(s) = \frac{-\frac{1}{3}}{(s+6)^2} + \frac{-\frac{1}{18}}{(s+6)} + \frac{\frac{1}{18}}{s}$$

Using the linearity theorem, the inverse transform of  $\mathbf{V}(s)$  can now be found by simply determining the inverse transform of each term.

We see that the first term on the right is of the form

$$\frac{K}{(s+\alpha)^2}$$

and making use of Eq. [21], we find that its inverse transform is  $-\frac{1}{3}te^{-6t}u(t)$ . In a similar fashion, we find that the inverse transform of the second term is  $-\frac{1}{18}e^{-6t}u(t)$ , and that of the third term is  $\frac{1}{18}u(t)$ .

Thus,

$$v(t) = -\frac{1}{3}te^{-6t}u(t) - \frac{1}{18}e^{-6t}u(t) + \frac{1}{18}u(t)$$

or, more compactly,

$$v(t) = \frac{1}{18}[1 - (1+6t)e^{-6t}]u(t)$$

## PRACTICE

14.10 Determine  $g(t)$  if  $\mathbf{G}(s) = \frac{3}{s^3 + 5s^2 + 8s + 4}$ .

Ans:  $g(t) = 3[e^{-t} - te^{-2t} - e^{-2t}]u(t)$ .

## COMPUTER-AIDED ANALYSIS

MATLAB, a very powerful numerical analysis package, can be used to assist in the solution of equations arising from the analysis of circuits with time-varying excitation in several different ways. The most straightforward technique makes use of ordinary differential equation

(ODE) solver routines `ode23()` and `ode45()`. These two routines are based on numerical methods of solving differential equations, with `ode45()` having greater accuracy. The solution is determined only at discrete points, however, and therefore is not known for all values of time. For many applications this is adequate, provided a sufficient density of points is used.

The Laplace transform technique provides us with the means of obtaining an exact expression for the solution of differential equations, and as such has many advantages over the use of numerical ODE solution techniques. Another significant advantage to the Laplace transform technique will become apparent in subsequent chapters when we study the significance of the form of s-domain expressions, particularly once we factor the denominator polynomials.

As we have already seen, lookup tables can be handy when working with Laplace transforms, although the method of residues can become somewhat tedious for functions with higher-order polynomials in their denominators. In these instances MATLAB can also be of assistance, as it contains several useful functions for the manipulation of polynomial expressions.

In MATLAB, the polynomial

$$p(x) = a_n x^n + a_{n-1} x^{n-1} + \cdots + a_1 x + a_0$$

is stored as the vector  $[a_n \ a_{n-1} \ \dots \ a_1 \ a_0]$ . Thus, to define the polynomials  $\mathbf{N}(s) = 2$  and  $\mathbf{D}(s) = s^3 + 12s^2 + 36s$  we write

```
EDU» N = [2];
EDU» D = [1 12 36 0];
```

The roots of either polynomial can be obtained by invoking the function `roots(p)`, where  $\mathbf{p}$  is a vector containing the coefficients of the polynomial. For example,

```
EDU» q = [1 8 16];
EDU» roots(q)
```

yields

```
ans =
    -4
    -4
```

MATLAB also enables us to determine the residues of the rational function  $\mathbf{N}(s)/\mathbf{D}(s)$  using the function `residue()`. For example,

```
EDU» [r p y] = residue(N, D);
```

returns three vectors  $\mathbf{r}$ ,  $\mathbf{p}$ , and  $\mathbf{y}$ , such that

$$\frac{\mathbf{N}(s)}{\mathbf{D}(s)} = \frac{r_1}{x - p_1} + \frac{r_2}{x - p_2} + \cdots + \frac{r_n}{x - p_n} + \mathbf{y}(s)$$

in the case of no multiple poles; in the case of  $n$  multiple poles,

$$\frac{\mathbf{N}(s)}{\mathbf{D}(s)} = \frac{r_1}{(x - p)} + \frac{r_2}{(x - p)^2} + \cdots + \frac{r_n}{(x - p)^n} + \mathbf{y}(s)$$

Note that as long as the order of the numerator polynomial is less than the order of the denominator polynomial, the vector  $\mathbf{y}(s)$  will always be empty.

Executing the command without the semicolon results in the output

```
r =
-0.0556
-0.3333
 0.0556

p =
-6
-6
 0

y =
[]
```

which agrees with the answer found in Example 14.6.

## 14.6 BASIC THEOREMS FOR THE LAPLACE TRANSFORM

We are now able to consider two theorems that might be considered collectively the *raison d'être* for Laplace transforms in circuit analysis—the time differentiation and integration theorems. These will help us transform the derivatives and integrals appearing in the time-domain circuit equations.

### Time Differentiation Theorem

Let us look at time differentiation first by considering a time function  $v(t)$  whose Laplace transform  $\mathbf{V}(s)$  is known to exist. We want the transform of the first derivative of  $v(t)$ ,

$$\mathcal{L}\left\{\frac{dv}{dt}\right\} = \int_{0^-}^{\infty} e^{-st} \frac{dv}{dt} dt$$

This can be integrated by parts:

$$U = e^{-st} \quad dV = \frac{dv}{dt} dt$$

with the result

$$\mathcal{L}\left\{\frac{dv}{dt}\right\} = v(t)e^{-st}\Big|_{0^-}^{\infty} + s \int_{0^-}^{\infty} e^{-st} v(t) dt$$

The first term on the right must approach zero as  $t$  increases without limit; otherwise  $\mathbf{V}(s)$  would not exist. Hence,

$$\mathcal{L}\left\{\frac{dv}{dt}\right\} = 0 - v(0^-) + s\mathbf{V}(s)$$

and

$$\frac{dv}{dt} \Leftrightarrow s\mathbf{V}(s) - v(0^-) \quad [23]$$

Similar relationships may be developed for higher-order derivatives:

$$\frac{d^2v}{dt^2} \Leftrightarrow s^2\mathbf{V}(s) - sv(0^-) - v'(0^-) \quad [24]$$

$$\frac{d^3v}{dt^3} \Leftrightarrow s^3\mathbf{V}(s) - s^2v(0^-) - sv'(0^-) - v''(0^-) \quad [25]$$

where  $v'(0^-)$  is the value of the first derivative of  $v(t)$  evaluated at  $t = 0^-$ ,  $v''(0^-)$  is the initial value of the second derivative of  $v(t)$ , and so forth. When all initial conditions are zero, we see that differentiating once with respect to  $t$  in the time domain corresponds to multiplication by  $s$  in the frequency domain; differentiating twice in the time domain corresponds to multiplication by  $s^2$  in the frequency domain, and so on. Thus, *differentiation in the time domain is equivalent to multiplication in the frequency domain*. This is a substantial simplification! We also notice that, when the initial conditions are not zero, their presence is still accounted for.



### EXAMPLE 14.7

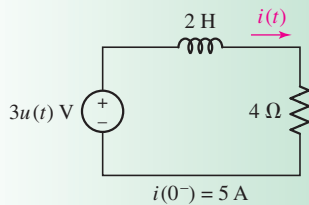

■ FIGURE 14.3 A circuit that is analyzed by transforming the differential equation  $2 \, di/dt + 4i = 3u(t)$  into  $2[s\mathbf{I}(s) - i(0^-)] + 4\mathbf{I}(s) = 3/s$ .

Given the series  $RL$  circuit shown in Fig. 14.3, calculate the current through the  $4 \, \Omega$  resistor.

► **Identify the goal of the problem.**

We need to find an expression for the current labeled  $i(t)$ .

► **Collect the known information.**

The network is driven by a step voltage, and we are given an initial value of the current (at  $t = 0^-$ ) of 5 A.

► **Devise a plan.**

Applying KVL to the circuit will result in a differential equation with  $i(t)$  as the unknown. Taking the Laplace transform of both sides of this equation will convert it to the  $s$ -domain. Solving the resulting algebraic equation for  $\mathbf{I}(s)$ , the inverse Laplace transform will yield  $i(t)$ .

► **Construct an appropriate set of equations.**

Using KVL to write the single-loop equation in the time domain,

$$2 \frac{di}{dt} + 4i = 3u(t)$$

Now, we take the Laplace transform of each term, so that

$$2[s\mathbf{I}(s) - i(0^-)] + 4\mathbf{I}(s) = \frac{3}{s}$$

► **Determine if additional information is required.**

We have an equation that may be solved for the frequency-domain representation  $\mathbf{I}(s)$  of our goal,  $i(t)$ .

► **Attempt a solution.**

We next solve for  $\mathbf{I}(s)$ , substituting  $i(0^-) = 5$ :

$$(2s + 4)\mathbf{I}(s) = \frac{3}{s} + 10$$

and

$$\mathbf{I}(s) = \frac{1.5}{s(s+2)} + \frac{5}{s+2}$$

Applying the method of residues to the first term,

$$\left. \frac{1.5}{s+2} \right|_{s=0} = 0.75 \quad \text{and} \quad \left. \frac{1.5}{s} \right|_{s=-2} = -0.75$$

so that

$$\mathbf{I}(s) = \frac{0.75}{s} + \frac{4.25}{s+2}$$

We then use our known transform pairs to invert:

$$\begin{aligned} i(t) &= 0.75u(t) + 4.25e^{-2t}u(t) \\ &= (0.75 + 4.25e^{-2t})u(t) \text{ A} \end{aligned}$$

► **Verify the solution. Is it reasonable or expected?**

Based on our previous experience with this type of circuit, we expected a dc forced response plus an exponentially decaying natural response. At  $t = 0$ , we obtain  $i(0) = 5$  A, as required, and as  $t \rightarrow \infty$ ,  $i(t) \rightarrow \frac{3}{4}$  A as we would expect.

Our solution for  $i(t)$  is therefore complete. Both the forced response  $0.75u(t)$  and the natural response  $4.25e^{-2t}u(t)$  are present, and the initial condition was automatically incorporated into the solution. The method illustrates a very painless way of obtaining the complete solution of many differential equations.

### PRACTICE

14.11 Use Laplace transform methods to find  $i(t)$  in the circuit of Fig. 14.4.

Ans:  $(0.25 + 4.75e^{-20t})u(t)$  A.

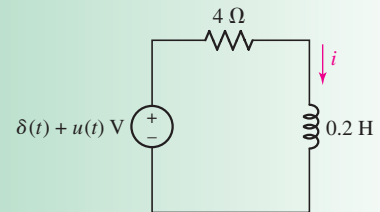

■ FIGURE 14.4

## Time-Integration Theorem

The same kind of simplification can be accomplished when we meet the operation of integration with respect to time in our circuit equations. Let us determine the Laplace transform of the time function described by  $\int_{0^-}^t v(x) dx$ ,

$$\mathcal{L} \left\{ \int_{0^-}^t v(x) dx \right\} = \int_{0^-}^{\infty} e^{-st} \left[ \int_{0^-}^t v(x) dx \right] dt$$

Integrating by parts, we let

$$\begin{aligned} u &= \int_{0^-}^t v(x) dx & dv &= e^{-st} dt \\ du &= v(t) dt & v &= -\frac{1}{s} e^{-st} \end{aligned}$$

Then

$$\begin{aligned}\mathcal{L}\left\{\int_{0^-}^t v(x) dx\right\} &= \left\{\left[\int_{0^-}^t v(x) dx\right]\left[-\frac{1}{s}e^{-st}\right]\right\}_{t=0^-}^{t=\infty} - \int_{0^-}^{\infty} -\frac{1}{s}e^{-st}v(t) dt \\ &= \left[-\frac{1}{s}e^{-st}\int_{0^-}^t v(x) dx\right]_{0^-}^{\infty} + \frac{1}{s}\mathbf{V}(s)\end{aligned}$$

But, since  $e^{-st} \rightarrow 0$  as  $t \rightarrow \infty$ , the first term on the right vanishes at the upper limit, and when  $t \rightarrow 0^-$ , the integral in this term likewise vanishes. This leaves only the  $\mathbf{V}(s)/s$  term, so that

$$\int_{0^-}^t v(x) dx \Leftrightarrow \frac{\mathbf{V}(s)}{s} \quad [26]$$



and thus *integration in the time domain corresponds to division by  $s$  in the frequency domain*. Once more, a relatively complicated calculus operation in the time domain simplifies to an algebraic operation in the frequency domain.

### EXAMPLE 14.8

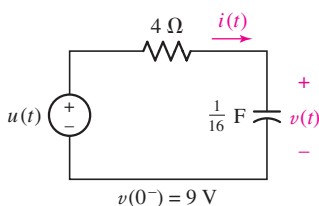

■ FIGURE 14.5 A circuit illustrating the use of the Laplace transform pair  $\int_{0^-}^t i(t') dt' \Leftrightarrow \frac{1}{s}\mathbf{I}(s)$ .

Determine  $i(t)$  for  $t > 0$  in the series  $RC$  circuit shown in Fig. 14.5.

We first write the single-loop equation,

$$u(t) = 4i(t) + 16 \int_{-\infty}^t i(t') dt'$$

In order to apply the time-integration theorem, we must arrange for the lower limit of integration to be  $0^-$ . Thus, we set

$$\begin{aligned}16 \int_{-\infty}^t i(t') dt' &= 16 \int_{-\infty}^{0^-} i(t') dt' + 16 \int_{0^-}^t i(t') dt' \\ &= v(0^-) + 16 \int_{0^-}^t i(t') dt'\end{aligned}$$

Therefore,

$$u(t) = 4i(t) + v(0^-) + 16 \int_{0^-}^t i(t') dt'$$

We next take the Laplace transform of both sides of this equation. Since we are utilizing the one-sided transform,  $\mathcal{L}\{v(0^-)\}$  is simply  $\mathcal{L}\{v(0^-)u(t)\}$ , and thus

$$\frac{1}{s} = 4\mathbf{I}(s) + \frac{9}{s} + \frac{16}{s}\mathbf{I}(s)$$

Solving for  $\mathbf{I}(s)$ ,

$$\mathbf{I}(s) = -\frac{2}{s+4}$$

the desired result is immediately obtained,

$$i(t) = -2e^{-4t}u(t) \text{ A}$$

## EXAMPLE 14.9

Find  $v(t)$  for the same circuit, repeated as Fig. 14.6 for convenience.

This time we write a single nodal equation,

$$\frac{v(t) - u(t)}{4} + \frac{1}{16} \frac{dv}{dt} = 0$$

Taking the Laplace transform, we obtain

$$\frac{V(s)}{4} - \frac{1}{4s} + \frac{1}{16}sV(s) - \frac{v(0^-)}{16} = 0$$

or

$$V(s) \left( 1 + \frac{s}{4} \right) = \frac{1}{s} + \frac{9}{4}$$

Thus,

$$\begin{aligned} V(s) &= \frac{4}{s(s+4)} + \frac{9}{s+4} \\ &= \frac{1}{s} - \frac{1}{s+4} + \frac{9}{s+4} \\ &= \frac{1}{s} + \frac{8}{s+4} \end{aligned}$$

and taking the inverse transform,

$$v(t) = (1 + 8e^{-4t})u(t) \text{ V}$$

To check this result, we note that  $(\frac{1}{16})dv/dt$  should yield the previous expression for  $i(t)$ . For  $t > 0$ ,

$$\frac{1}{16} \frac{dv}{dt} = \frac{1}{16} (-32)e^{-4t} = -2e^{-4t}$$

which is in agreement with what was found in Example 14.8.

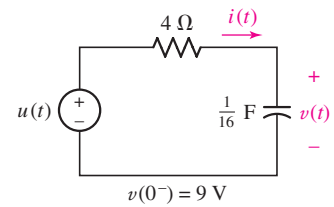

FIGURE 14.6 The circuit of Fig. 14.5 repeated, in which the voltage  $v(t)$  is required.

## PRACTICE

14.12 Find  $v(t)$  at  $t = 800$  ms for the circuit of Fig. 14.7.

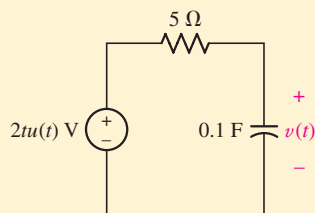

FIGURE 14.7

Ans: 802 mV.

## Laplace Transforms of Sinusoids

To illustrate the use of both the linearity theorem and the time-differentiation theorem, not to mention the addition of a most important pair to our forthcoming Laplace transform table, let us establish the Laplace transform of  $\sin \omega t u(t)$ . We could use the defining integral expression with integration by parts, but this is needlessly difficult. Instead, we use the relationship

$$\sin \omega t = \frac{1}{2j}(e^{j\omega t} - e^{-j\omega t})$$

The transform of the sum of these two terms is just the sum of the transforms, and each term is an exponential function for which we already have the transform. We may immediately write

$$\begin{aligned}\mathcal{L}\{\sin \omega t u(t)\} &= \frac{1}{2j} \left( \frac{1}{s - j\omega} - \frac{1}{s + j\omega} \right) = \frac{\omega}{s^2 + \omega^2} \\ \sin \omega t u(t) &\Leftrightarrow \frac{\omega}{s^2 + \omega^2}\end{aligned}\quad [27]$$

We next use the time-differentiation theorem to determine the transform of  $\cos \omega t u(t)$ , which is proportional to the derivative of  $\sin \omega t$ . That is,

$$\begin{aligned}\mathcal{L}\{\cos \omega t u(t)\} &= \mathcal{L}\left\{\frac{1}{\omega} \frac{d}{dt}[\sin \omega t u(t)]\right\} = \frac{1}{\omega} s \frac{\omega}{s^2 + \omega^2} \\ \cos \omega t u(t) &\Leftrightarrow \frac{s}{s^2 + \omega^2}\end{aligned}\quad [28]$$

Note that we have made use of the fact that  $\sin \omega t|_{t=0} = 0$ .

## The Time-Shift Theorem

As we have seen in some of our earlier transient problems, not all forcing functions begin at  $t = 0$ . What happens to the transform of a time function if that function is simply shifted in time by some known amount? In particular, if the transform of  $f(t)u(t)$  is the known function  $\mathbf{F}(s)$ , then what is the transform of  $f(t - a)u(t - a)$ , the original time function delayed by  $a$  seconds (and not existing for  $t < a$ )? Working directly from the definition of the Laplace transform, we get

$$\begin{aligned}\mathcal{L}\{f(t - a)u(t - a)\} &= \int_{0^-}^{\infty} e^{-st} f(t - a)u(t - a) dt \\ &= \int_{a^-}^{\infty} e^{-st} f(t - a) dt\end{aligned}$$

for  $t \geq a^-$ . Choosing a new variable of integration,  $\tau = t - a$ , we obtain

$$\mathcal{L}\{f(t - a)u(t - a)\} = \int_{0^-}^{\infty} e^{-s(\tau+a)} f(\tau) d\tau = e^{-as} \mathbf{F}(s)$$

Therefore,

$$f(t - a)u(t - a) \Leftrightarrow e^{-as} \mathbf{F}(s) \quad (a \geq 0) \quad [29]$$

This result is known as the *time-shift theorem*, and it simply states that if a time function is delayed by a time  $a$  in the time domain, the result in the frequency domain is a multiplication by  $e^{-as}$ .



## EXAMPLE 14.10

Determine the transform of the rectangular pulse  $v(t) = u(t - 2) - u(t - 5)$ .

This pulse, shown plotted in Fig. 14.8, has unit value for the time interval  $2 < t < 5$ , and zero value elsewhere. We know that the transform of  $u(t)$  is just  $1/s$ , and since  $u(t - 2)$  is simply  $u(t)$  delayed by 2 s, the transform of this delayed function is  $e^{-2s}/s$ . Similarly, the transform of  $u(t - 5)$  is  $e^{-5s}/s$ . It follows, then, that the desired transform is

$$V(s) = \frac{e^{-2s}}{s} - \frac{e^{-5s}}{s} = \frac{e^{-2s} - e^{-5s}}{s}$$

It was not necessary to revert to the definition of the Laplace transform in order to determine  $V(s)$ .

## PRACTICE

14.13 Obtain the Laplace transform of the time function shown in Fig. 14.9.

Ans:  $(5/s)(2e^{-2s} - e^{-4s} - e^{-5s})$ .

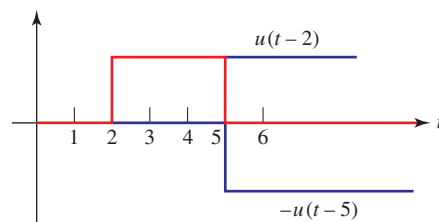

FIGURE 14.8 Plot of  $u(t - 2) - u(t - 5)$ .

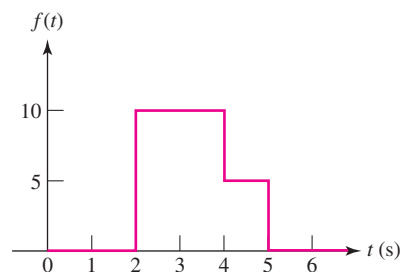

FIGURE 14.9

At this point we have obtained a number of entries for the catalog of Laplace transform pairs that we agreed to construct earlier. Included are the transforms of the *impulse function*, the *step function*, the *exponential function*, the *ramp function*, the *sine* and *cosine functions*, and the sum of two exponentials. In addition, we have noted the consequences in the  $s$  domain of the time-domain operations of addition, multiplication by a constant, differentiation, and integration. These results are collected in Tables 14.1 and 14.2; several others which are derived in Appendix 7 are also included.

TABLE 14.1 Laplace Transform Pairs

$f(t) = \mathcal{L}^{-1}\{\mathbf{F}(s)\}$	$\mathbf{F}(s) = \mathcal{L}\{f(t)\}$	$f(t) = \mathcal{L}^{-1}\{\mathbf{F}(s)\}$	$\mathbf{F}(s) = \mathcal{L}\{f(t)\}$
$\delta(t)$	1	$\frac{1}{\beta - \alpha}(e^{-\alpha t} - e^{-\beta t})u(t)$	$\frac{1}{(s + \alpha)(s + \beta)}$
$u(t)$	$\frac{1}{s}$	$\sin \omega t u(t)$	$\frac{\omega}{s^2 + \omega^2}$
$tu(t)$	$\frac{1}{s^2}$	$\cos \omega t u(t)$	$\frac{s}{s^2 + \omega^2}$
$\frac{t^{n-1}}{(n-1)!}u(t), n = 1, 2, \dots$	$\frac{1}{s^n}$	$\sin(\omega t + \theta)u(t)$	$\frac{s \sin \theta + \omega \cos \theta}{s^2 + \omega^2}$
$e^{-\alpha t}u(t)$	$\frac{1}{s + \alpha}$	$\cos(\omega t + \theta)u(t)$	$\frac{s \cos \theta - \omega \sin \theta}{s^2 + \omega^2}$
$te^{-\alpha t}u(t)$	$\frac{1}{(s + \alpha)^2}$	$e^{-\alpha t} \sin \omega t u(t)$	$\frac{\omega}{(s + \alpha)^2 + \omega^2}$
$\frac{t^{n-1}}{(n-1)!}e^{-\alpha t}u(t), n = 1, 2, \dots$	$\frac{1}{(s + \alpha)^n}$	$e^{-\alpha t} \cos \omega t u(t)$	$\frac{s + \alpha}{(s + \alpha)^2 + \omega^2}$

# PRACTICAL APPLICATION

## Stability of a System

Many years ago (or so it seems), one of the authors was driving along a country road and attempting to make use of the electronic speed control (“cruise control”) feature of the automobile. After turning the system on and manually setting the vehicular speed at precisely the posted speed limit,<sup>3</sup> the “set” button was depressed and the accelerator pedal released; at this point the system was expected to maintain the set speed by regulating the fuel flow as needed.



© Donovan Reese/Getty Images

Unfortunately, something else happened instead. The vehicle speed immediately dropped by about 10 percent, to which the cruise control electronics responded by increasing the fuel flow. The two events were not well matched, so that a few moments later the vehicle speed overshot the set point—resulting in a sudden (and significant) drop in fuel flow—which led to a reduction in the vehicle speed. The cycle continued to the consternation of the driver, who eventually gave up and turned off the system.

Clearly the system response was not optimized—in fact, as built the system was *unstable*. System stability is a major engineering concern across a wide variety of problems (cruise controls, temperature regulators, and tracking systems, to name but a few), and the techniques developed in this chapter are invaluable in allowing the stability of a particular system to be examined.

One of the powerful aspects of working in the *s*-domain as made possible by the Laplace transform is that instead of describing the response of a particular system through an integrodifferential equation, we can obtain a system transfer function represented by the ratio of two *s*-polynomials. The issue of stability is then easily

addressed by studying the denominator of the transfer function: *no pole should have a positive real component*.

There are quite a few techniques that can be applied to the problem of determining the stability of a particular system. One simple technique is known as the **Routh test**. Consider the *s*-domain system function (a concept developed further in Chap. 15)

$$H(s) = \frac{N(s)}{D(s)}$$

The *s*-polynomial represented by *D*(*s*) can be written as  $a_n s^n + a_{n-1} s^{n-1} + \dots + a_1 s + a_0$ . Without factoring the polynomial, not much about the poles can be determined at a glance. If all the coefficients  $a_n \dots a_0$  are positive and nonzero, the Routh procedure has us arrange them in the following pattern:

$$\begin{array}{cccc} a_n & a_{n-2} & a_{n-4} & \dots \\ a_{n-1} & a_{n-3} & a_{n-5} & \dots \end{array}$$

We next create a third row by cross-multiplying the two rows:

$$\frac{a_{n-1}a_{n-2} - a_n a_{n-3}}{a_{n-1}} \quad \frac{a_{n-1}a_{n-4} - a_n a_{n-5}}{a_{n-1}}$$

and a fourth row by cross-multiplying the second and third rows. This process continues until we have  $n + 1$  rows of numerical values. All that remains is to scan down the leftmost column for changes in sign. The number of sign changes indicates the number of poles with a positive real component; any sign changes indicate an unstable system.

For example, let’s assume the automobile cruise control system behind the author’s vexation has a system transfer function with denominator

$$D(s) = 7s^4 + 4s^3 + s^2 + 13s + 2$$

All of the coefficients of this fourth-order *s*-polynomial are positive and nonzero, so we construct the corresponding Routh table:

$$\begin{array}{ccc} 7 & 1 & 2 \\ 4 & 13 & 0 \\ -21.75 & 2 & \\ 13.37 & & \\ 2 & & \end{array}$$

from which we see two sign changes in the leftmost column. Thus, the system is in fact unstable (which explains its failure to perform) as two of its poles have positive real components.

(3) Since no cameras were present, nobody can prove otherwise.

TABLE 14.2 Laplace Transform Operations

Operation	$f(t)$	$\mathbf{F}(s)$
Addition	$f_1(t) \pm f_2(t)$	$\mathbf{F}_1(s) \pm \mathbf{F}_2(s)$
Scalar multiplication	$kf(t)$	$k\mathbf{F}(s)$
Time differentiation	$\frac{df}{dt}$	$s\mathbf{F}(s) - f(0^-)$
	$\frac{d^2f}{dt^2}$	$s^2\mathbf{F}(s) - sf(0^-) - f'(0^-)$
	$\frac{d^3f}{dt^3}$	$s^3\mathbf{F}(s) - s^2f(0^-) - sf'(0^-) - f''(0^-)$
Time integration	$\int_{0^-}^t f(t) dt$	$\frac{1}{s}\mathbf{F}(s)$
	$\int_{-\infty}^t f(t) dt$	$\frac{1}{s}\mathbf{F}(s) + \frac{1}{s} \int_{-\infty}^{0^-} f(t) dt$
Convolution	$f_1(t) * f_2(t)$	$\mathbf{F}_1(s)\mathbf{F}_2(s)$
Time shift	$f(t-a)u(t-a), a \geq 0$	$e^{-as}\mathbf{F}(s)$
Frequency shift	$f(t)e^{-at}$	$\mathbf{F}(s+a)$
Frequency differentiation	$tf(t)$	$-\frac{d\mathbf{F}(s)}{ds}$
Frequency integration	$\frac{f(t)}{t}$	$\int_s^\infty \mathbf{F}(s) ds$
Scaling	$f(at), a \geq 0$	$\frac{1}{a}\mathbf{F}\left(\frac{s}{a}\right)$
Initial value	$f(0^+)$	$\lim_{s \rightarrow \infty} s\mathbf{F}(s)$
Final value	$f(\infty)$	$\lim_{s \rightarrow 0} s\mathbf{F}(s)$ , all poles of $s\mathbf{F}(s)$ in LHP
Time periodicity	$f(t) = f(t+nT)$ ,	$\frac{1}{1-e^{-Ts}}\mathbf{F}_1(s)$ ,
	$n = 1, 2, \dots$	where $\mathbf{F}_1(s) = \int_{0^-}^T f(t)e^{-st} dt$

## 14.7 THE INITIAL-VALUE AND FINAL-VALUE THEOREMS

The last two fundamental theorems that we will discuss are known as the initial-value and final-value theorems. They will enable us to evaluate  $f(0^+)$  and  $f(\infty)$  by examining the limiting values of  $s\mathbf{F}(s)$ . Such an ability can be invaluable; if only the initial and final values are needed for a particular function of interest, there is no need to take the time to perform an inverse transform operation.

### The Initial-Value Theorem

To derive the initial-value theorem, we consider the Laplace transform of the derivative once again,

$$\mathcal{L}\left\{\frac{df}{dt}\right\} = s\mathbf{F}(s) - f(0^-) = \int_{0^-}^{\infty} e^{-st} \frac{df}{dt} dt$$

We now let  $s$  approach infinity. By breaking the integral into two parts,

$$\lim_{s \rightarrow \infty} [s\mathbf{F}(s) - f(0^-)] = \lim_{s \rightarrow \infty} \left( \int_{0^-}^{0^+} e^0 \frac{df}{dt} dt + \int_{0^+}^{\infty} e^{-st} \frac{df}{dt} dt \right)$$

we see that the second integral must approach zero in the limit, since the integrand itself approaches zero. Also,  $f(0^-)$  is not a function of  $s$ , and it may be removed from the left limit:

$$\begin{aligned} -f(0^-) + \lim_{s \rightarrow \infty} [s\mathbf{F}(s)] &= \lim_{s \rightarrow \infty} \int_{0^-}^{0^+} df = \lim_{s \rightarrow \infty} [f(0^+) - f(0^-)] \\ &= f(0^+) - f(0^-) \end{aligned}$$

and finally,

$$f(0^+) = \lim_{s \rightarrow \infty} [s\mathbf{F}(s)]$$

or

$$\lim_{t \rightarrow 0^+} f(t) = \lim_{s \rightarrow \infty} [s\mathbf{F}(s)] \quad [30]$$

This is the mathematical statement of the **initial-value theorem**. It states that the initial value of the time function  $f(t)$  can be obtained from its Laplace transform  $\mathbf{F}(s)$  by first multiplying the transform by  $s$  and then letting  $s$  approach infinity. Note that the initial value of  $f(t)$  we obtain is the limit from the right.



The initial-value theorem, along with the final-value theorem that we will consider in a moment, is useful in checking the results of a transformation or an inverse transformation. For example, when we first calculated the transform of  $\cos(\omega_0 t)u(t)$ , we obtained  $s/(s^2 + \omega_0^2)$ . After noting that  $f(0^+) = 1$ , we can make a partial check on the validity of this result by applying the initial-value theorem:

$$\lim_{s \rightarrow \infty} \left( s \frac{s}{s^2 + \omega_0^2} \right) = 1$$

and the check is accomplished.

## The Final-Value Theorem

The **final-value theorem** is not quite as useful as the initial-value theorem, for it can be used only with a certain class of transforms. In order to determine whether a transform fits into this class, the denominator of  $\mathbf{F}(s)$  must be evaluated to find all values of  $s$  for which it is zero, i.e., the **poles** of  $\mathbf{F}(s)$ . Only those transforms  $\mathbf{F}(s)$  whose poles lie entirely within the left half of the  $s$  plane (i.e.,  $\sigma < 0$ ), except for a simple pole at  $s = 0$ , are suitable for use with the final-value theorem. We again consider the Laplace transform of  $df/dt$ ,



$$\int_{0^-}^{\infty} e^{-st} \frac{df}{dt} dt = s\mathbf{F}(s) - f(0^-)$$

this time in the limit as  $s$  approaches zero,

$$\lim_{s \rightarrow 0} \int_{0^-}^{\infty} e^{-st} \frac{df}{dt} dt = \lim_{s \rightarrow 0} [s\mathbf{F}(s) - f(0^-)] = \int_{0^-}^{\infty} \frac{df}{dt} dt$$

We assume that both  $f(t)$  and its first derivative are transformable. Now, the last term of this equation is readily expressed as a limit,

$$\begin{aligned}\int_{0^-}^{\infty} \frac{df}{dt} dt &= \lim_{t \rightarrow \infty} \int_{0^-}^t \frac{df}{dt} dt \\ &= \lim_{t \rightarrow \infty} [f(t) - f(0^-)]\end{aligned}$$

By recognizing that  $f(0^-)$  is a constant, a comparison of the last two equations shows us that

$$\lim_{t \rightarrow \infty} f(t) = \lim_{s \rightarrow 0} [s\mathbf{F}(s)] \quad [31]$$

which is the **final-value theorem**. In applying this theorem, it is necessary to know that  $f(\infty)$ , the limit of  $f(t)$  as  $t$  becomes infinite, exists or—what amounts to the same thing—that the poles of  $\mathbf{F}(s)$  all lie *within* the left half of the  $s$  plane except for (possibly) a simple pole at the origin. The product  $s\mathbf{F}(s)$  thus has all of its poles lying within the left half plane.

### EXAMPLE 14.11

Use the final-value theorem to determine  $f(\infty)$  for the function  $(1 - e^{-at})u(t)$ , where  $a > 0$ .

Without even using the final-value theorem, we see immediately that  $f(\infty) = 1$ . The transform of  $f(t)$  is

$$\begin{aligned}\mathbf{F}(s) &= \frac{1}{s} - \frac{1}{s+a} \\ &= \frac{a}{s(s+a)}\end{aligned}$$

The poles of  $\mathbf{F}(s)$  are  $s = 0$  and  $s = -a$ . Thus, the nonzero pole of  $\mathbf{F}(s)$  lies in the left-hand  $s$ -plane, as we were assured that  $a > 0$ ; we find that we may indeed apply the final-value theorem to this function. Multiplying by  $s$  and letting  $s$  approach zero, we obtain

$$\lim_{s \rightarrow 0} [s\mathbf{F}(s)] = \lim_{s \rightarrow 0} \frac{a}{s+a} = 1$$

which agrees with  $f(\infty)$ .

If  $f(t)$  is a sinusoid, however, so that  $\mathbf{F}(s)$  has poles on the  $j\omega$  axis, then a blind use of the final-value theorem might lead us to conclude that the final value is zero. We know, however, that the final value of either  $\sin \omega_0 t$  or  $\cos \omega_0 t$  is indeterminate. So, beware of  $j\omega$ -axis poles!



### PRACTICE

14.14 Without finding  $f(t)$  first, determine  $f(0^+)$  and  $f(\infty)$  for each of the following transforms: (a)  $4e^{-2s}(s+50)/s$ ; (b)  $(s^2+6)/(s^2+7)$ ; (c)  $(5s^2+10)/[2s(s^2+3s+5)]$ .

Ans: 0, 200;  $\infty$ , indeterminate (poles lie on the  $j\omega$  axis); 2.5, 1.

## SUMMARY AND REVIEW

The primary topic of this chapter was the Laplace transform, a mathematical tool for converting well-behaved time-domain functions into frequency-domain expressions. Before introducing the transform, we first considered the notion of a complex frequency, which we referred to as  $s$ . This convenient term has both a real ( $\sigma$ ) and imaginary ( $\omega$ ) component, so can be written as  $s = \sigma + j\omega$ . In reality, this is shorthand for an exponentially damped sinusoid, and we noted that several common functions are actually special cases of this function. Limited circuit analysis can be performed with this generalized function, but its real purpose was to simply acquaint the reader with the idea of a so-called complex frequency.

One of the most surprising things is that day-to-day circuit analysis does not require direct implementation of either the Laplace transform integral or its corresponding inverse integral! Instead, look-up tables are routinely employed, and the  $s$ -polynomials which result from analyzing circuits in the  $s$  domain are factored into smaller, easily recognizable terms. This works because each Laplace transform pair is unique. There are several theorems associated with Laplace transforms which do see daily usage, however. These include the linearity theorem, the time-differentiation theorem, and the time-integration theorem. The time-shift as well as initial-value and final-value theorems are also commonly employed.

The Laplace technique is not restricted to circuit analysis, or even electrical engineering for that matter. Any system which is described by integrodifferential equations can make use of the concepts studied in this chapter. At this stage, however, it is probably best to review the key concepts already discussed, highlighting appropriate examples.

- The concept of complex frequency allows us to consider the exponentially damped and oscillatory components of a function simultaneously. (Example 14.1)
- The complex frequency  $s = \sigma + j\omega$  is the general case; dc ( $s = 0$ ), exponential ( $\omega = 0$ ), and sinusoidal ( $\sigma = 0$ ) functions are special cases.
- Analyzing circuits in the  $s$  domain results in the conversion of time-domain *integrodifferential* equations into frequency-domain algebraic equations. (Example 14.1)
- In circuit analysis problems, we convert time-domain functions into the frequency domain using the one-sided Laplace transform:  

$$\mathbf{F}(s) = \int_0^{\infty} e^{-st} f(t) dt.$$
 (Example 14.2)
- The inverse Laplace transform converts frequency-domain expressions into the time domain. However, it is seldom needed due to the existence of tables listing Laplace transform pairs. (Example 14.3)
- The unit-impulse function is a common approximation to pulses with very narrow widths compared to circuit time constants. It is nonzero only at a single point, and has unity area.
- $\mathcal{L}\{f_1(t) + f_2(t)\} = \mathcal{L}\{f_1(t)\} + \mathcal{L}\{f_2(t)\}$  (additive property)
- $\mathcal{L}\{kf(t)\} = k\mathcal{L}\{f(t)\}$ ,  $k = \text{constant}$  (homogeneity property)

- Inverse transforms are typically found using a combination of partial-fraction expansion techniques and various operations (Table 14.2) to simplify s-domain quantities into expressions that can be found in transform tables (such as Table 14.1). (Examples 14.4, 14.5, 14.6, 14.10)
- The differentiation and integration theorems allow us to convert integrodifferential equations in the time domain into simple algebraic equations in the frequency domain. (Examples 14.7, 14.8, 14.9)
- The initial-value and final-value theorems are useful when only the specific values  $f(t = 0^+)$  or  $f(t \rightarrow \infty)$  are desired. (Example 14.11)

## READING FURTHER

An easily readable development of the Laplace transform and some of its key properties can be found in Chap. 4 of:

A. Pinkus and S. Zafrany, *Fourier Series and Integral Transforms*. Cambridge, United Kingdom: Cambridge University Press, 1997.

A much more detailed treatment of integral transforms and their application to science and engineering problems can be found in:

B. Davies, *Integral Transforms and Their Applications*, 3rd ed. New York: Springer-Verlag, 2002.

Stability and the Routh test are discussed in Chap. 5 of:

K. Ogata, *Modern Control Engineering*, 4th ed. Englewood Cliffs, N.J.: Prentice-Hall, 2002.

## EXERCISES

### 14.1 Complex Frequency

1. Determine the conjugate of each of the following: (a)  $8 - j$ ; (b)  $8e^{-9t}$ ; (c) 22.5; (d)  $4e^{j9}$ ; (e)  $j2e^{-j11}$ .
2. Compute the complex conjugate of each of the following expressions: (a)  $-1$ ; (b)  $\frac{-j}{5\angle 20^\circ}$ ; (c)  $5e^{-j5} + 2e^{j3}$ ; (d)  $(2 + j)(8\angle 30^\circ)e^{j2t}$ .
3. Several real voltages are written down on a piece of paper, but coffee spills across half of each one. Complete the voltage expression if the legible part is (a)  $5e^{-j50t}$ ; (b)  $(2 + j)e^{j9t}$ ; (c)  $(1 - j)e^{j78t}$ ; (d)  $-je^{-5t}$ . Assume the units of each voltage are volts (V).
4. State the complex frequency or frequencies associated with each function: (a)  $f(t) = \sin 100t$ ; (b)  $f(t) = 10$ ; (c)  $g(t) = 5e^{-7t} \cos 80t$ ; (d)  $f(t) = 5e^{8t}$ ; (e)  $g(t) = (4e^{-2t} - e^{-t}) \cos(4t - 95^\circ)$ .
5. For each of the following functions, determine both the complex frequency  $s$  as well as  $s^*$ : (a)  $7e^{-9t} \sin(100t + 9^\circ)$ ; (b)  $\cos 9t$ ; (c)  $2 \sin 45t$ ; (d)  $e^{7t} \cos 7t$ .
6. Use real constants  $A$ ,  $B$ ,  $\phi$ , etc. to construct the general form of a real time function characterized by the following frequency components: (a)  $10 - j3 \text{ s}^{-1}$ ; (b)  $0.25 \text{ s}^{-1}$ ; (c)  $0, 1, -j, 1 + j$  (all  $\text{s}^{-1}$ ).
7. The following voltage sources  $Ae^{Bt} \cos(Ct + \theta)$  are connected (one at a time) to a  $280 \Omega$  resistor. Calculate the resulting current at  $t = 0, 0.1$ , and  $0.5 \text{ s}$ , assuming the passive sign convention: (a)  $A = 1 \text{ V}$ ,  $B = 0.2 \text{ Hz}$ ,  $C = 0$ ,  $\theta = 45^\circ$ ; (b)  $A = 285 \text{ mV}$ ,  $B = -1 \text{ Hz}$ ,  $C = 2 \text{ rad/s}$ ,  $\theta = -45^\circ$ .
8. Your neighbor's cell phone interferes with your laptop speaker system whenever the phone is connecting to the local network. Connecting an oscilloscope to the output jack of your computer, you observe a voltage waveform that can

be described by a complex frequency  $s = -1 + j200\pi \text{ s}^{-1}$ . (a) What can you deduce about your neighbor's movements? (b) The imaginary part of the complex frequency starts to decrease suddenly. Alter your deduction as appropriate.

9. Compute the real part of each of the following complex functions: (a)  $\mathbf{v}(t) = 9e^{-j4t} \text{ V}$ ; (b)  $\mathbf{v}(t) = 12 - j9 \text{ V}$ ; (c)  $5 \cos 100t - j43 \sin 100t \text{ V}$ ; (d)  $(2 + j)e^{j3t} \text{ V}$ .
10. Your new assistant has measured the signal coming from a piece of test equipment, writing  $v(t) = \mathbf{V}_x e^{(-2+j60)t}$ , where  $\mathbf{V}_x = 8 - j100 \text{ V}$ . (a) There is a missing term. What is it, and how can you tell it's missing? (b) What is the complex frequency of the signal? (c) What is the significance of the fact that  $\text{Im}\{\mathbf{V}_x\} > \text{Re}\{\mathbf{V}_x\}$ ? (d) What is the significance of the fact that  $|\text{Re}\{\mathbf{s}\}| < |\text{Im}\{\mathbf{s}\}|$ ?

## 14.2 The Damped Sinusoidal Forcing Function

11. State the time-domain voltage  $v(t)$  which corresponds to the voltage  $\mathbf{V} = 19/\underline{84^\circ} \text{ V}$  if  $\mathbf{s}$  is equal to (a)  $5 \text{ s}^{-1}$ ; (b)  $0$ ; (c)  $-4 + j \text{ s}^{-1}$ .
12. For the circuit of Fig. 14.10, the voltage source is chosen such that it can be represented by the complex frequency domain function  $\mathbf{V}e^{st}$ , with  $\mathbf{V} = 2.5/\underline{-20^\circ} \text{ V}$  and  $\mathbf{s} = -1 + j100 \text{ s}^{-1}$ . Calculate (a)  $\mathbf{s}^*$ ; (b)  $v(t)$ , the time-domain representation of the voltage source; (c) the current  $i(t)$ .
13. With regard to the circuit depicted in Fig. 14.10, determine the time-domain voltage  $v(t)$  which corresponds to a frequency-domain current  $\mathbf{i}(t) = 5/\underline{30^\circ} \text{ A}$  for a complex frequency of (a)  $\mathbf{s} = -2 + j2 \text{ s}^{-1}$ ; (b)  $\mathbf{s} = -3 + j \text{ s}^{-1}$ .
14. For the circuit depicted in Fig. 14.11, take  $\mathbf{s} = -200 + j150 \text{ s}^{-1}$ . Determine the ratio of the frequency-domain voltages  $\mathbf{V}_2$  and  $\mathbf{V}_1$ , which correspond to  $v_2(t)$  and  $v_1(t)$ , respectively.
15. If the complex frequency describing the circuit of Fig. 14.11 is  $\mathbf{s} = -150 + j100 \text{ s}^{-1}$ , determine the time-domain voltage which corresponds to a frequency-domain voltage  $\mathbf{V}_2 = 5/\underline{-25^\circ} \text{ V}$ .
16. Calculate the time-domain voltage  $v$  in the circuit of Fig. 14.12 if the frequency-domain representation of the current source is  $2.3/\underline{5^\circ} \text{ A}$  at a complex frequency of  $\mathbf{s} = -1 + j2 \text{ s}^{-1}$ .
17. The circuit of Fig. 14.12 is operated for an extended period of time without interruption. The frequency-domain voltage which develops across the three elements can be represented as  $1.8/\underline{75^\circ} \text{ V}$  at a complex frequency of  $\mathbf{s} = -2 + j1.5 \text{ s}^{-1}$ . Determine the time-domain current  $i_s$ .
18. The circuit of Fig. 14.13 is driven by  $v_s(t) = 10 \cos 5t \text{ V}$ . (a) Determine the complex frequency of the source. (b) Determine the frequency-domain representation of the source: (c) Compute the frequency-domain representation of  $i_x$ . (d) Obtain the time-domain expression for  $i_x$ .
19. The frequency-domain current  $\mathbf{I}_x$  which flows through the  $2.2 \Omega$  resistor of Fig. 14.13 can be represented as  $2/\underline{10^\circ} \text{ A}$  at a complex frequency of  $\mathbf{s} = -1 + j0.5 \text{ s}^{-1}$ . Determine the time-domain voltage  $v_s$ .
20. Let  $i_{s1} = 20e^{-3t} \cos 4t \text{ A}$  and  $i_{s2} = 30e^{-3t} \sin 4t \text{ A}$  in the circuit of Fig. 14.14. (a) Work in the frequency domain to find  $\mathbf{V}_x$ . (b) Find  $v_x(t)$ .

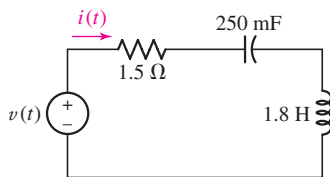

■ FIGURE 14.10

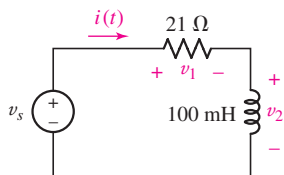

■ FIGURE 14.11

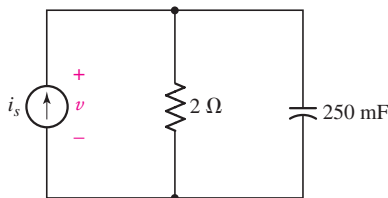

■ FIGURE 14.12

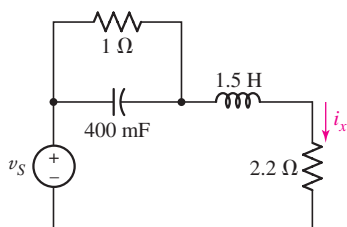

■ FIGURE 14.13

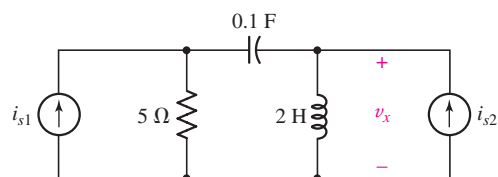

■ FIGURE 14.14





### 14.3 Definition of the Laplace Transform

21. Calculate, with the assistance of Eq. [14] (and showing intermediate steps), the Laplace transform of the following: (a)  $2.1u(t)$ ; (b)  $2u(t - 1)$ ; (c)  $5u(t - 2) - 2u(t)$ ; (d)  $3u(t - b)$ , where  $b > 0$ .
22. Employ the one-sided Laplace transform integral (with intermediate steps explicitly included) to compute the  $s$ -domain expressions which correspond to the following: (a)  $5u(t - 6)$ ; (b)  $2e^{-t}u(t)$ ; (c)  $2e^{-t}u(t - 1)$ ; (d)  $e^{-2t} \sin 5tu(t)$ .
23. With the assistance of Eq. [14] and showing appropriate intermediate steps, compute the one-sided Laplace transform of the following: (a)  $(t - 1)u(t - 1)$ ; (b)  $t2u(t)$ ; (c)  $\sin 2tu(t)$ ; (d)  $\cos 100t u(t)$ .
24. The Laplace transform of  $tf(t)$ , assuming  $\mathcal{L}\{f(t)\} = \mathbf{F}(s)$ , is given by  $-\frac{d}{ds} \mathbf{F}(s)$ . Test this by comparing the predicted result to what is found by directly employing Eq. [14] for (a)  $tu(t)$ ; (b)  $t^2u(t)$ ; (c)  $t^3u(t)$ ; (d)  $te^{-t}u(t)$ .

### 14.4 Laplace Transforms of Simple Time Functions

25. For the following functions, specify the range of  $\sigma_0$  for which the one-sided Laplace transform exists: (a)  $t + 4$ ; (b)  $(t + 1)(t - 2)$ ; (c)  $e^{-t/2}u(t)$ ; (d)  $\sin 10t u(t + 1)$ .
26. Show, with the assistance of Eq. [14], that  $\mathcal{L}\{f(t) + g(t) + h(t)\} = \mathcal{L}\{f(t)\} + \mathcal{L}\{g(t)\} + \mathcal{L}\{h(t)\}$ .
27. Determine  $\mathbf{F}(s)$  if  $f(t)$  is equal to (a)  $3u(t - 2)$ ; (b)  $3e^{-2t}u(t) + 5u(t)$ ; (c)  $\delta(t) + u(t) - tu(t)$ ; (d)  $5\delta(t)$ .
28. Obtain an expression for  $\mathbf{G}(s)$  if  $g(t)$  is given by (a)  $[5u(t)]^2 - u(t)$ ; (b)  $2u(t) - 2u(t - 2)$ ; (c)  $tu(2t)$ ; (d)  $2e^{-t}u(t) + 3u(t)$ .
29. Without recourse to Eq. [15], obtain an expression for  $f(t)$  if  $\mathbf{F}(s)$  is given by (a)  $\frac{1}{s}$ ; (b)  $1.55 - \frac{2}{s}$ ; (c)  $\frac{1}{s + 1.5}$ ; (d)  $\frac{5}{s^2} + \frac{5}{s} + 5$ . (Provide some brief explanation of how you arrived at your solution.)
30. Obtain an expression for  $g(t)$  without employing the inverse Laplace transform integral, if  $\mathbf{G}(s)$  is known to be (a)  $\frac{1.5}{(s + 9)^2}$ ; (b)  $\frac{2}{s} - 0$ ; (c)  $\pi$ ; (d)  $\frac{a}{(s + 1)^2} - a$ ,  $a > 0$ . (Provide some brief explanation of your solution process for each.)
31. Evaluate the following: (a)  $\delta(t)$  at  $t = 1$ ; (b)  $5\delta(t + 1) + u(t + 1)$  at  $t = 0$ ; (c)  $\int_{-1}^2 \delta(t) dt$ ; (d)  $3 - \int_{-1}^2 2\delta(t) dt$ .
32. Evaluate the following: (a)  $[\delta(2t)]^2$  at  $t = 1$ ; (b)  $2\delta(t - 1) + u(-t + 1)$  at  $t = 0$ ; (c)  $\frac{1}{3} \int_{-0.001}^{0.003} \delta(t) dt$ ; (d)  $\left[ \frac{1}{2} \int_0^2 \delta(t - 1) dt \right]^2$ .
33. Evaluate the following expressions at  $t = 0$ :  
 (a)  $\int_{-\infty}^{+\infty} 2\delta(t - 1) dt$ ; (b)  $\frac{\int_{-\infty}^{+\infty} \delta(t + 1) dt}{u(t + 1)}$ ; (c)  $\frac{\sqrt{3 \int_{-\infty}^{+\infty} \delta(t - 2) dt}}{[u(1 - t)]^3} - \sqrt{u(t + 2)}$ ;  
 (d)  $\left[ \frac{\int_{-\infty}^{+\infty} \delta(t - 1) dt}{\int_{-\infty}^{+\infty} \delta(t + 1) dt} \right]^2$ .
34. Evaluate the following:  
 (a)  $\int_{-\infty}^{+\infty} e^{-100} \delta\left(t - \frac{1}{5}\right) dt$ ; (b)  $\int_{-\infty}^{+\infty} 4t\delta(t - 2) dt$ ; (c)  $\int_{-\infty}^{+\infty} 4t^2\delta(t - 1.5) dt$ ;  
 (d)  $\frac{\int_{-\infty}^{+\infty} (4 - t)\delta(t - 1) dt}{\int_{-\infty}^{+\infty} (4 - t)\delta(t + 1) dt}$ .

### 14.5 Inverse Transform Techniques

35. Determine the inverse transform of  $F(s)$  equal to (a)  $5 + \frac{5}{s^2} - \frac{5}{(s+1)}$ ;  
 (b)  $\frac{1}{s} + \frac{5}{(0.1s+4)} - 3$ ; (c)  $-\frac{1}{2s} + \frac{1}{(0.5s)^2} + \frac{4}{(s+5)(s+5)} + 2$ ;  
 (d)  $\frac{4}{(s+5)(s+5)} + \frac{2}{s+1} + \frac{1}{s+3}$ .
36. Obtain an expression for  $g(t)$  if  $G(s)$  is given by (a)  $\frac{3(s+1)}{(s+1)^2} + \frac{2s}{s^2} - \frac{1}{(s+2)^2}$ ;  
 (b)  $-\frac{10}{(s+3)^3}$ ; (c)  $19 - \frac{8}{(s+3)^2} + \frac{18}{s^2+6s+9}$ .
37. Reconstruct the time-domain function if its transform is (a)  $\frac{s}{s(s+2)}$ ; (b) 1;  
 (c)  $3\frac{s+2}{(s^2+2s+4)}$ ; (d)  $4\frac{s}{2s+3}$ .
38. Determine the inverse transform of  $V(s)$  equal to (a)  $\frac{s^2+2}{s} + 1$ ;  
 (b)  $\frac{s+8}{s} + \frac{2}{s^2}$ ; (c)  $\frac{s+1}{s(s+2)} + \frac{2s^2-1}{s^2}$ ; (d)  $\frac{s^2+4s+4}{s}$ .
39. Obtain the time-domain expression which corresponds to each of the following  $s$ -domain functions: (a)  $2\frac{3s+\frac{1}{2}}{s^2+3s}$ ; (b)  $7 - \frac{s+\frac{1}{s}}{s^2+3s+1}$ ;  
 (c)  $\frac{2}{s^2} + \frac{1}{s} + \frac{s+2}{(\frac{s}{2})^2+4s+6}$ ; (d)  $\frac{2}{(s+1)(s+1)}$ ; (e)  $\frac{14}{(s+1)^2(s+4)(s+5)}$ .
-  40. Find the inverse Laplace transform of the following: (a)  $\frac{1}{s^2+9s+20}$ ;  
 (b)  $\frac{4}{s^3+18s^2+17s} + \frac{1}{s}$ ; (c)  $(0.25)\frac{1}{(\frac{s}{2})^2+1.75s+2.5}$ ;  
 (d)  $\frac{3}{s(s+1)(s+4)(s+5)(s+2)}$ . (e) Verify your answers with MATLAB.
-  41. Determine the inverse Laplace transform of each of the following  $s$ -domain expressions:  
 (a)  $\frac{1}{(s+2)^2(s+1)}$ ; (b)  $\frac{s}{(s^2+4s+4)(s+2)}$ ; (c)  $\frac{8}{s^3+8s^2+21s+18}$ ;  
 (d) Verify your answers with MATLAB.
42. Given the following expressions in the  $s$ -domain, determine the corresponding time-domain functions: (a)  $\frac{1}{3s} - \frac{1}{2s+1} + \frac{3}{s^3+8s^2+16s} - 1$ ;  
 (b)  $\frac{1}{3s+5} + \frac{3}{s^3/8+0.25s^2}$ ; (c)  $\frac{2s}{(s+a)^2}$ .
43. Compute  $\mathcal{L}^{-1}\{G(s)\}$  if  $G(s)$  is given by (a)  $\frac{3s}{(s/2+2)^2(s+2)}$ ;  
 (b)  $3 - 3\frac{s}{(2s^2+24s+70)(s+5)}$ ; (c)  $2 - \frac{1}{s+100} + \frac{s}{s^2+100}$ ; (d)  $\mathcal{L}\{tu(2t)\}$ .
-  44. Obtain the time-domain expression which corresponds to the following  $s$ -domain functions: (a)  $\frac{s}{(s+2)^3}$ ; (b)  $\frac{4}{(s+1)^4(s+1)^2}$ ;  
 (c)  $\frac{1}{s^2(s+4)^2(s+6)^3} - \frac{2s^2}{s} + 9$ . (d) Verify your solutions with MATLAB.

### 14.6 Basic Theorems for the Laplace Transform

45. Take the Laplace transform of the following equations:  
 (a)  $5 di/dt - 7 d^2i/dt^2 + 9i = 4$ ; (b)  $m \frac{d^2p}{dt^2} + \mu_f \frac{dp}{dt} + kp(t) = 0$ ,  
 the equation that describes the “force-free” response of a simple shock

absorber system; (c)  $\frac{d\Delta n_p}{dt} = -\frac{\Delta n_p}{\tau} + G_L$ , with  $\tau = \text{constant}$ , which describes the recombination rate of excess electrons ( $\Delta n_p$ ) in  $p$ -type silicon under optical illumination ( $G_L$  is a constant proportional to the light intensity).

46. With regard to the circuit depicted in Fig. 14.15, the initial voltage across the capacitor is  $v(0^-) = 1.5$  V and the current source is  $i_s = 700u(t)$  mA.  
 (a) Write the differential equation which arises from KCL, in terms of the nodal voltage  $v(t)$ . (b) Take the Laplace transform of the differential equation. (c) Determine the frequency-domain representation of the nodal voltage. (d) Solve for the time-domain voltage  $v(t)$ .

47. For the circuit of Fig. 14.15, if  $\mathbf{I}_s = \frac{2}{s+1}$  mA, (a) write the time-domain nodal equation in terms of  $v(t)$ ; (b) solve for  $\mathbf{V}(s)$ ; (c) determine the time-domain voltage  $v(t)$ .

48. The voltage source in the circuit of Fig. 14.4 is replaced with one whose  $s$ -domain equivalent is  $\frac{2}{s} - \frac{1}{s+1}$  V. The initial condition is unchanged.  
 (a) Write the  $s$ -domain KVL equation in terms of  $\mathbf{I}(s)$ . (b) Solve for  $i(t)$ .

49. For the circuit of Fig. 14.16,  $v_s(t) = 2u(t)$  V and the capacitor initially stores zero energy. (a) Write the time-domain loop equation in terms of the current  $i(t)$ . (b) Obtain the  $s$ -domain representation of this integral equation. (c) Solve for  $i(t)$ .

50. The  $s$ -domain representation of the voltage source in Fig. 14.16 is

$\mathbf{V}_s(s) = \frac{2}{s+1}$  V. The initial voltage across the capacitor, defined using the passive sign convention in terms of the current  $i$ , is 4.5 V. (a) Write the time-domain integral equation that arises from application of KVL. (b) By first solving for  $\mathbf{I}(s)$ , determine the time-domain current  $i(t)$ .

51. If the current source of Fig. 14.17 is given by  $450u(t)$  mA, and  $i_x(0) = 150$  mA, work initially in the  $s$ -domain to obtain an expression for  $v(t)$  valid for  $t > 0$ .
52. Obtain, through purely legitimate means, an  $s$ -domain expression which corresponds to the time-domain waveform plotted in Fig. 14.18.

53. Apply the Routh test to the following system functions, and state whether the system is *stable* or *unstable*:

$$(a) \mathbf{H}(s) = \frac{s-500}{s^3+13s^2+47s+35}; (b) \mathbf{H}(s) = \frac{s-500}{s^3+13s^2+s+35}.$$

54. Apply the Routh test to the following system functions, and state whether the system is *stable* or *unstable*; then factor each denominator to identify the poles of  $\mathbf{H}(s)$  and verify the accuracy of the Routh test for these functions:

$$(a) \mathbf{H}(s) = \frac{4s}{s^2+3s+8}; (b) \mathbf{H}(s) = \frac{s-9}{s^2+2s+1}.$$

## 14.7 The Initial-Value and Final-Value Theorems

55. Employ the initial-value theorem to determine the initial value of each of the following time-domain functions: (a)  $2u(t)$ ; (b)  $2e^{-t}u(t)$ ; (c)  $u(t-6)$ ; (d)  $\cos 5t u(t)$ .

56. Employ the initial-value theorem to determine the initial value of each of the following time-domain functions: (a)  $u(t-3)$ ; (b)  $2e^{-(t-2)}u(t-2)$ ;

$$(c) \frac{u(t-2) + [u(t)]^2}{2}; (d) \sin 5t e^{-2t}u(t).$$

57. Make use of the final-value theorem (if appropriate) to ascertain  $f(\infty)$  for

$$(a) \frac{1}{s+2} - \frac{2}{s}; (b) \frac{2s}{(s+2)(s+1)}; (c) \frac{1}{(s+2)(s+4)} + \frac{2}{s};$$

$$(d) \frac{1}{(s^2+s-6)(s+9)}.$$

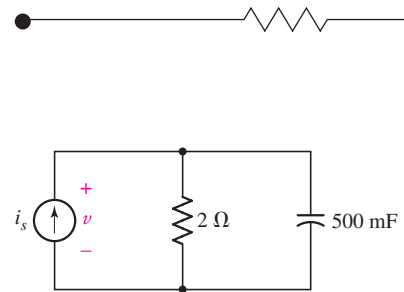

FIGURE 14.15

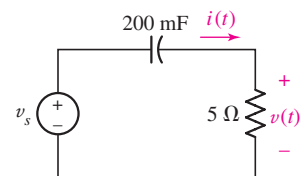

FIGURE 14.16

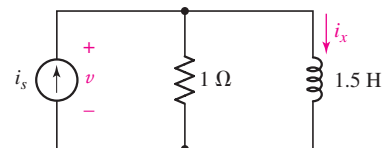

FIGURE 14.17

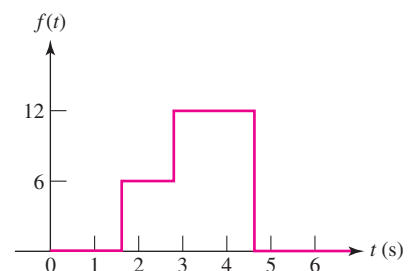
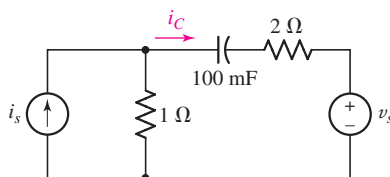

FIGURE 14.18

58. Without recourse to  $f(t)$ , determine  $f(0^+)$  and  $f(\infty)$  (or show they do not exist) for each of the following  $s$ -domain expressions: (a)  $\frac{1}{s+18}$ ; (b)  $10\left(\frac{1}{s^2} + \frac{3}{s}\right)$ ; (c)  $\frac{s^2-4}{s^3+8s^2+4s}$ ; (d)  $\frac{s^2+2}{s^3+3s^2+5s}$ .
59. Apply the initial- or final-value theorems as appropriate to determine  $f(0^+)$  and  $f(\infty)$  for the following functions: (a)  $\frac{s+2}{s^2+8s+4}$ ; (b)  $\frac{1}{s^2(s+4)^2(s+6)^3} - \frac{2s^2}{s} + 9$ ; (c)  $\frac{4s^2+1}{(s+1)^2(s+2)^2}$ .
60. Determine which of the following functions are appropriate for the final-value theorem: (a)  $\frac{1}{(s-1)}$ ; (b)  $\frac{10}{s^2-4s+4}$ ; (c)  $\frac{13}{s^3-5s^2+8s-6}$ ; (d)  $\frac{3}{2s^3-10s^2+16s-12}$ .

### Chapter-Integrating Exercises

61. The voltage  $v(t) = 8e^{-2t}u(t)$  V is applied to an unlabeled two-terminal device. Your assistant misunderstands you and only records the  $s$ -domain current which results. Determine what type of element it is and its value if  $\mathbf{I}(s)$  is equal to (a)  $\frac{1}{s+2}$  A; (b)  $\frac{4}{s(s+2)}$  A.
62. (a) Create an  $s$ -domain function  $\mathbf{F}(s)$  which corresponds to an initial value  $f(0^-) = 16$  yet has an indeterminate final value. (b) Obtain an expression for  $f(t)$ . (c) If this waveform represents the voltage across a 2 F capacitor, determine the current flowing through the device (assume the passive sign convention).
63. For the circuit of Fig. 14.19, let  $i_s(t) = 5u(t)$  A and  $v_s(t) = e^{-4t}u(t+1)$  V. Working initially in the  $s$ -domain, obtain an expression for  $i_C(t)$  valid for  $t > 0$ .



■ FIGURE 14.19

64. Referring to the circuit depicted in Fig. 14.19 and working in the  $s$ -domain to develop an expression for  $\mathbf{I}_C(s)$ , determine  $i_C(t)$  for  $t > 0$  if  $i_s(t) = 2u(t+2)$  A and  $v_s(t)$  is equal to (a)  $2u(t)$  V; (b)  $te^{-t}u(t)$  V.
65. For the circuit of Fig. 14.20,  $\mathbf{I}(s) = 5\frac{s+1}{(s+1)^2+10^4}$  A. (a) Determine the initial value of the inductor current. (b) Determine the final value of the inductor voltage, assuming it is defined consistent with the passive sign convention.

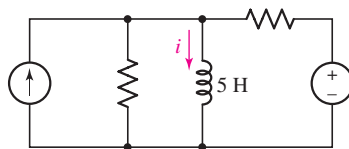

■ FIGURE 14.20

# Circuit Analysis in the s-Domain

## INTRODUCTION

Having been introduced to the concept of complex frequency and to the Laplace transform technique, we now are ready to see the details of how circuit analysis in the s-domain actually works. As the reader might suspect, particularly if Chap. 10 has already been studied, in fact several shortcuts are routinely applied. The first of these is to create a new way of viewing capacitors and inductors, so that s-domain nodal and mesh equations can be written directly. As part of this method, we will learn how to take care to account for initial conditions. Another “shortcut” is the concept of a circuit transfer function. This general function can be exploited to predict the response of a circuit to various inputs, its stability, and even its frequency-selective response.

## 15.1 Z(s) AND Y(s)

The key concept that makes phasors so useful in the analysis of sinusoidal steady-state circuits is the transformation of resistors, capacitors, and inductors into *impedances*. Circuit analysis then proceeds using the basic techniques of nodal or mesh analysis, superposition, source transformation, as well as Thévenin or Norton equivalents. This concept can be extended to the s-domain, since the sinusoidal steady state is included in s-domain analysis as a special case (where  $\sigma = 0$ ).

### Resistors in the Frequency Domain

Let's begin with the simplest situation: a resistor connected to a voltage source  $v(t)$ . Ohm's law specifies that

$$v(t) = Ri(t)$$

Taking the Laplace transform of both sides,

$$\mathbf{V}(s) = \mathbf{R}\mathbf{I}(s)$$

## KEY CONCEPTS

Extending the Concept of Impedance to the s-Domain

Modeling Initial Conditions with Ideal Sources

Applying Nodal, Mesh, Superposition, and Source Transformation in the s-Domain

Thévenin and Norton's Theorems Applied to s-Domain Circuits

Manipulating s-Domain Algebraic Expressions with MATLAB

Identifying Poles and Zeros in Circuit Transfer Functions

Impulse Response of a Circuit

Use of Convolution to Determine System Response

Response as a Function of  $\sigma$  and  $\omega$

Using Pole-Zero Plots to Predict the Natural Response of Circuits

Synthesizing Specific Voltage Transfer Functions Using Op Amps



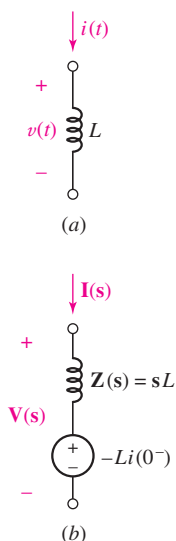

■ FIGURE 15.1 (a) Inductor in the time domain. (b) The complete model for an inductor in the frequency domain, consisting of an impedance  $sL$  and a voltage source  $-Li(0^-)$  that incorporates the effects of nonzero initial conditions on the element.

Thus, the ratio of the frequency-domain representation of the voltage to the frequency-domain representation of the current is simply the resistance,  $R$ . Since we are working in the frequency domain, we refer to this quantity as an *impedance* for the sake of clarity, but still assign it the unit ohms ( $\Omega$ ):

$$\mathbf{Z}(s) \equiv \frac{\mathbf{V}(s)}{\mathbf{I}(s)} = R \quad [1]$$

Just as we found in working with phasors in the sinusoidal steady state, the impedance of a resistor does not depend on frequency. The *admittance*  $\mathbf{Y}(s)$  of a resistor, defined as the ratio of  $\mathbf{I}(s)$  to  $\mathbf{V}(s)$ , is simply  $1/R$ ; the unit of admittance is the siemen (S).

## Inductors in the Frequency Domain

Next, we consider an inductor connected to some time-varying voltage source  $v(t)$ , as shown in Fig. 15.1a. Since

$$v(t) = L \frac{di}{dt}$$

taking the Laplace transform of both sides of this equation yields

$$\mathbf{V}(s) = L[s\mathbf{I}(s) - i(0^-)] \quad [2]$$

We now have two terms:  $sL\mathbf{I}(s)$  and  $Li(0^-)$ . In situations where we have zero initial energy stored in the inductor (i.e.,  $i(0^-) = 0$ ), then

$$\mathbf{V}(s) = sL\mathbf{I}(s)$$

so that

$$\mathbf{Z}(s) \equiv \frac{\mathbf{V}(s)}{\mathbf{I}(s)} = sL \quad [3]$$

Equation [3] may be further simplified if we are only interested in the sinusoidal steady-state response. It is permissible to neglect the initial conditions in such instances as they only affect the nature of the transient response. Thus, we substitute  $s = j\omega$  and find

$$\mathbf{Z}(j\omega) = j\omega L$$

as was obtained previously in Chap. 10.

## Modeling Inductors in the $s$ -Domain

Although we refer to the quantity in Eq. [3] as the impedance of an inductor, we must remember that it was obtained by assuming zero initial current. In the more general situation where energy is stored in the element at  $t = 0^-$ , this quantity is not sufficient to represent the inductor in the frequency domain. Fortunately, it is possible to include the initial condition by modeling an inductor as an impedance in combination with either a voltage or current source. To do this, we begin by rearranging Eq. [2] as

$$\mathbf{V}(s) = sL\mathbf{I}(s) - Li(0^-) \quad [4]$$

The second term on the right will be a constant: the inductance  $L$  in henrys multiplied by the initial current  $i(0^-)$  in amperes. The result is a constant

voltage term that is subtracted from the frequency-dependent term  $sLI(s)$ . A small leap of intuition at this point leads us to the realization that we can model a single inductor  $L$  as a two-component frequency-domain element, as shown in Fig. 15.1b.

The frequency-domain inductor model shown in Fig. 15.1b consists of an impedance  $sL$  and a voltage source  $Li(0^-)$ . The voltage across the impedance  $sL$  is given by Ohm's law as  $sLI(s)$ . Since the two-element combination in Fig. 15.1b is linear, every circuit analysis technique previously explored can be brought to bear in the  $s$ -domain as well. For example, it is possible to perform a source transformation on the model in order to obtain an impedance  $sL$  in parallel with a current source  $[-Li(0^-)]/sL = -i(0^-)/s$ . This can be verified by taking Eq. [4] and solving for  $\mathbf{I}(s)$ :

$$\begin{aligned}\mathbf{I}(s) &= \frac{\mathbf{V}(s) + Li(0^-)}{sL} \\ &= \frac{\mathbf{V}(s)}{sL} + \frac{i(0^-)}{s}\end{aligned}\quad [5]$$

We are once again left with two terms. The first term on the right is simply an admittance  $1/sL$  times the voltage  $\mathbf{V}(s)$ . The second term on the right is a current, although it has units of ampere · seconds. Thus, we can model this equation with two separate components: an admittance  $1/sL$  in parallel with a current source  $i(0^-)/s$ ; the resulting model is shown in Fig. 15.2. The choice of whether to use the model of Fig. 15.1b or that shown in Fig. 15.2 is usually made depending on which one will result in simpler equations. Note that although Fig. 15.2 shows the inductor symbol labeled with an admittance  $\mathbf{Y}(s) = 1/sL$ , it can also be viewed as an impedance  $\mathbf{Z}(s) = sL$ ; again, the choice of which to use is generally based on personal preference.

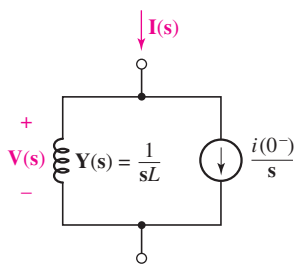

■ FIGURE 15.2 An alternative frequency-domain model for the inductor, consisting of an admittance  $1/sL$  and a current source  $i(0^-)/s$ .

A brief comment on units is in order. When we take the Laplace transform of a current  $i(t)$ , we are integrating over time. Thus, the units of  $\mathbf{I}(s)$  are technically ampere · seconds; in a similar fashion, the units of  $\mathbf{V}(s)$  are volt · seconds. However, it is the convention to drop the seconds and assign  $\mathbf{I}(s)$  the units of amperes, and to measure  $\mathbf{V}(s)$  in volts. This convention does not present any problems until we scrutinize an equation such as Eq. [5], and see a term like  $i(0^-)/s$  seemingly in conflict with the units of  $\mathbf{I}(s)$  on the left-hand side. Although we will continue to measure these phasor quantities in “amperes” and “volts,” when checking the units of an equation to verify algebra, we must remember the seconds!



## EXAMPLE 15.1

Calculate the voltage  $v(t)$  shown in Fig. 15.3a, given an initial current  $i(0^-) = 1$  A.

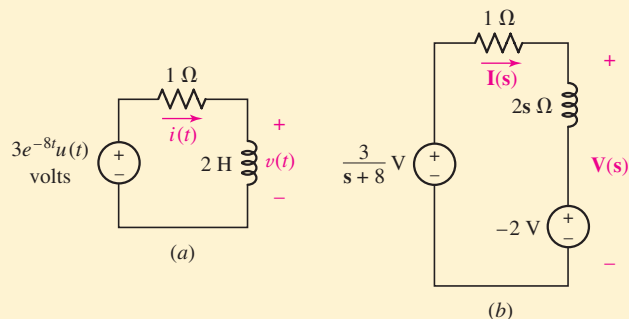

FIGURE 15.3 (a) A simple resistor-inductor circuit for which the voltage  $v(t)$  is desired. (b) The equivalent frequency-domain circuit, including the initial current in the inductor through the use of a series voltage source  $-Li(0^-)$ .

We begin by first converting the circuit in Fig. 15.3a to its frequency-domain equivalent, shown in Fig. 15.3b; the inductor has been replaced with a two-component model: an impedance  $sL = 2s\ \Omega$ , and an independent voltage source  $-Li(0^-) = -2$  V.

We seek the quantity labeled  $\mathbf{V}(s)$ , as its inverse transform will result in  $v(t)$ . Note that  $\mathbf{V}(s)$  appears across the *entire* inductor model, and not just the impedance component.

Taking a straightforward route, we write

$$\mathbf{I}(s) = \frac{\frac{3}{s+8} + 2}{1 + 2s} = \frac{s + 9.5}{(s + 8)(s + 0.5)}$$

and

$$\mathbf{V}(s) = 2s\mathbf{I}(s) - 2$$

so that

$$\mathbf{V}(s) = \frac{2s(s + 9.5)}{(s + 8)(s + 0.5)} - 2$$

Before attempting to take the inverse Laplace transform of this expression, it is well worth a little time and effort to simplify it first. Thus,

$$\mathbf{V}(s) = \frac{2s - 8}{(s + 8)(s + 0.5)}$$

Employing the technique of partial-fraction expansion (on paper or with the assistance of MATLAB), we find that

$$\mathbf{V}(s) = \frac{3.2}{s + 8} - \frac{1.2}{s + 0.5}$$





Referring to Table 14.1, then, the inverse transform is found to be

$$v(t) = [3.2e^{-8t} - 1.2e^{-0.5t}]u(t) \quad \text{volts}$$

### PRACTICE

15.1 Determine the current  $i(t)$  in the circuit of Fig. 15.4.

Ans:  $\frac{1}{3}[1 - 13e^{-4t}]u(t)$  A.

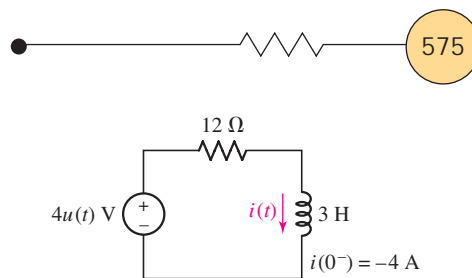

FIGURE 15.4

## Modeling Capacitors in the s-Domain

The same concepts apply to capacitors in the s-domain as well. Following the passive sign convention as illustrated in Fig. 15.5a, the governing equation for capacitors is

$$i = C \frac{dv}{dt}$$

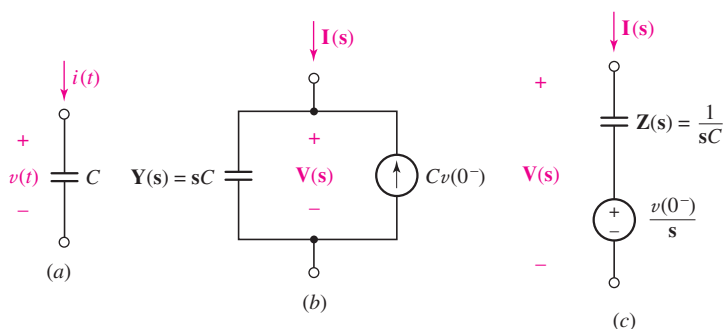

FIGURE 15.5 (a) Capacitor in the time domain, with  $v(t)$  and  $i(t)$  labeled. (b) Frequency-domain model of a capacitor with initial voltage  $v(0^-)$ . (c) An equivalent model obtained by performing a source transformation.

Taking the Laplace transform of both sides results in

$$\mathbf{I}(s) = C[s\mathbf{V}(s) - v(0^-)]$$

or

$$\mathbf{I}(s) = sC\mathbf{V}(s) - Cv(0^-) \quad [6]$$

which can be modeled as an admittance  $sC$  in parallel with a current source  $Cv(0^-)$  as shown in Fig. 15.5b. Performing a source transformation on this circuit (taking care to follow the passive sign convention) results in an equivalent model for the capacitor consisting of an impedance  $1/sC$  in series with a voltage source  $v(0^-)/s$ , as shown in Fig. 15.5c.

In working with these s-domain equivalents, we should be careful not to be confused with the independent sources being used to include initial conditions. The initial condition for an inductor is given as  $i(0^-)$ ; this term may appear as part of either a voltage source or a current source, depending on which model is chosen. The initial condition for a capacitor is given as  $v(0^-)$ ; this term may thus appear as part of either a voltage source or a





current source. A very common mistake for students working with s-domain analysis for the first time is to always use  $v(0^-)$  for the voltage source component of the model, even when dealing with an inductor.

## EXAMPLE 15.2

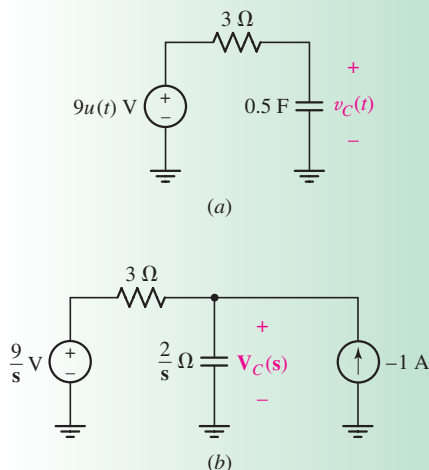

FIGURE 15.6 (a) A circuit for which the current  $v_C(t)$  is required. (b) Frequency-domain equivalent circuit, employing the current-source-based model to account for the initial condition of the capacitor.

Determine  $v_C(t)$  in the circuit of Fig. 15.6a, given an initial voltage  $v_C(0^-) = -2\text{ V}$ .

### ► Identify the goal of the problem.

An expression for the capacitor voltage,  $v_C(t)$ .

### ► Collect the known information.

The problem specifies an initial capacitor voltage of  $-2\text{ V}$ .

### ► Devise a plan.

Our first step is to draw the equivalent s-domain circuit; in doing so, we must choose between the two possible capacitor models. With no clear benefit in choosing one over the other, we select the current-source-based model, as in Fig. 15.6b.

### ► Construct an appropriate set of equations.

We proceed with the analysis by writing a single nodal equation:

$$-1 = \frac{V_C}{2/s} + \frac{V_C - 9/s}{3}$$

### ► Determine if additional information is required.

We have one equation in one unknown, the frequency-domain representation of the desired capacitor voltage.

### ► Attempt a solution.

Solving for  $V_C$ , we find that

$$V_C = \frac{18/s - 6}{3s + 2} = -2 \frac{s - 3}{s(s + 2/3)}$$

Partial fraction expansion yields

$$V_C = \frac{9}{s} - \frac{11}{s + 2/3}$$

We obtain  $v_C(t)$  by taking the inverse Laplace transform of this expression, resulting in

$$v_C(t) = 9u(t) - 11e^{-2t/3}u(t) \quad \text{V}$$

or, more compactly,

$$v_C(t) = [9 - 11e^{-2t/3}]u(t) \quad \text{V}$$

### ► Verify the solution. Is it reasonable or expected?

A quick check for  $t = 0$  yields  $v_C(t) = -2\text{ V}$ , as it should based on our knowledge of the initial condition. Also, as  $t \rightarrow \infty$ ,  $v_C(t) \rightarrow 9\text{ V}$ , as we would expect from Fig. 15.6a once the transient has died out.

**PRACTICE**

15.2 Repeat Example 15.2 using the voltage-source-based capacitor model.

Ans:  $[9 - 11e^{-2t/3}]u(t)$  V.

The results of this section are summarized in Table 15.1. Note that in each case, we have assumed the passive sign convention.

**TABLE 15.1** Summary of Element Representations in the Time and Frequency Domains

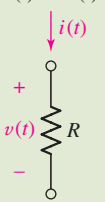
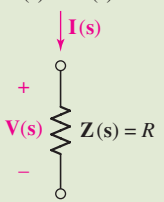
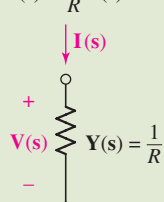
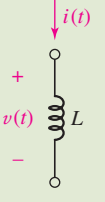
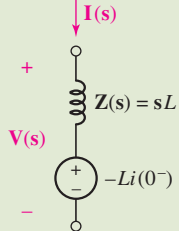
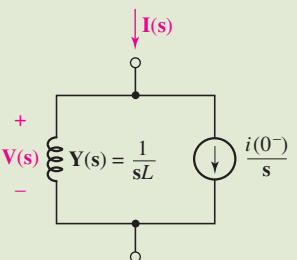
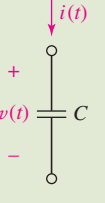
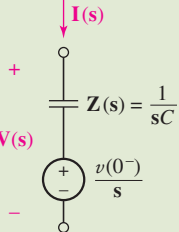
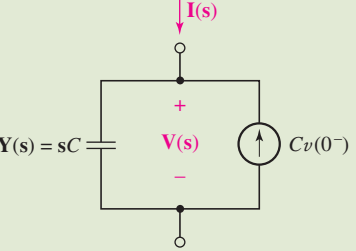
Time Domain	Frequency Domain
<p><b>Resistor</b></p> $v(t) = Ri(t)$ 	$\mathbf{V}(s) = R\mathbf{I}(s)$  $\mathbf{I}(s) = \frac{1}{R}\mathbf{V}(s)$ 
<p><b>Inductor</b></p> $v(t) = L \frac{di}{dt}$ 	$\mathbf{V}(s) = sL\mathbf{I}(s) - Li(0^-)$  $\mathbf{I}(s) = \frac{\mathbf{V}(s)}{sL} + \frac{i(0^-)}{s}$ 
<p><b>Capacitor</b></p> $i(t) = C \frac{dv}{dt}$ 	$\mathbf{V}(s) = \frac{\mathbf{I}(s)}{sC} + \frac{v(0^-)}{s}$  $\mathbf{I}(s) = sC\mathbf{V}(s) - Cv(0^-)$ 

## 15.2 NODAL AND MESH ANALYSIS IN THE $s$ -DOMAIN

In Chap. 10, we learned how to transform time-domain circuits driven by sinusoidal sources into their frequency-domain equivalents. The benefits of this transformation were immediately evident, as we were no longer required to solve integrodifferential equations. Nodal and mesh analysis of such circuits (restricted to determining only the steady-state response) resulted in algebraic expressions in terms of  $j\omega$ ,  $\omega$  being the frequency of the sources.

We have now seen that the concept of impedance can be extended to the more general case of complex frequency ( $s = \sigma + j\omega$ ). Once we transform circuits from the time domain into the frequency domain, performing nodal or mesh analysis will once again result in purely algebraic expressions, this time in terms of the complex frequency  $s$ . Solution of the resulting equations requires the use of variable substitution, Cramer's rule, or software capable of symbolic algebra manipulation (e.g., MATLAB). In this section, we present two examples of reasonable complexity so that we may examine these issues in greater detail. First, however, we consider how MATLAB can be used to assist us in such endeavors.

### COMPUTER-AIDED ANALYSIS

In Chap. 14, we saw that MATLAB can be used to determine the residues of rational functions in the  $s$ -domain, making the inverse Laplace transform process significantly easier. However, the software package is actually much more powerful, having numerous built-in routines for manipulation of algebraic expressions. In fact, as we will see in this example, MATLAB is even capable of performing inverse Laplace transforms directly from the rational functions we obtain through circuit analysis.

Let's begin by seeing how MATLAB can be used to work with algebraic expressions. These expressions are stored as character strings, with the apostrophe symbol (') used in the defining expression. For example, we previously represented the polynomial  $\mathbf{p}(s) = s^3 - 12s + 6$  as a vector:

```
EDU> p = [1 0 -12 6];
```

However, we can also represent it symbolically:

```
EDU> p = 's^3 - 12*s + 6';
```

These two representations are not equal in MATLAB; they are two distinct concepts. When we wish to manipulate an algebraic expression *symbolically*, the second representation is necessary. This ability is especially useful in working with simultaneous equations.

Consider the set of equations

$$\begin{aligned}(3s + 10)\mathbf{I}_1 - 10\mathbf{I}_2 &= \frac{4}{s + 2} \\ -10\mathbf{I}_1 + (4s + 10)\mathbf{I}_2 &= -\frac{2}{s + 1}\end{aligned}$$

Using MATLAB's symbolic notation, we define two string variables:

```
EDU» eqn1 = '(3*s+10)*I1 - 10*I2 = 4/(s+2)';
```

```
EDU» eqn2 = '-10*I1 + (4*s+10)*I2 = -2/(s+1)';
```

Note that the entire equation has been included in each string; our goal is to solve the two equations for the variables I1 and I2. MATLAB provides a special routine, *solve()*, that can manipulate the equations for us. It is invoked by listing the separate equations (defined as strings), followed by a list of the unknowns (also defined as strings):

```
EDU» solution = solve(eqn1, eqn2, 'I1', 'I2');
```

The answer is stored in the variable *solution*, although in a somewhat unexpected form. MATLAB returns the answer in what is termed a structure, a construct that will be familiar to C programmers. At this stage, however, all we need to know is how to extract our answer. If we type

```
EDU» I1 = solution.I1
```

we obtain the response

```
I1 =
2*(4*s+9)/(s+1)/(6*s^2+47*s+70)
```

indicating that an s-polynomial expression has been assigned to the variable I1; a similar operation is used for the variable I2.

We can now proceed directly to determining the inverse Laplace transform using the function *ilaplace()*:

```
EDU» i1 = ilaplace(I1)
```

```
i1 =
10/29*exp(-t)-172/667*exp(-35/6*t)-2/23*exp(-2*t)
```

In this manner, we can quickly obtain the solution to simultaneous equations resulting from nodal or mesh analysis, and also obtain the inverse Laplace transforms. The command *ezplot(i1)* allows us to see what the solution looks like, if we're so inclined. It should be noted that complicated expressions sometimes may confuse MATLAB; in such situations, *ilaplace()* may not return a useful answer.

It is worth mentioning a few related functions, as they can also be used to quickly check answers obtained by hand. The function *numden()* converts a rational function into two separate variables: one containing the numerator, and the other containing the denominator. For example,

```
EDU» [N,D] = numden(I1)
```

returns two algebraic expressions stored in N and D, respectively:

```
N =
8*s+18
D =
(s+1)*(6*s^2+47*s+70)
```

(Continued on next page)

In order to apply our previous experience with the function *residue()*, we need to convert each symbolic (string) expression into a vector containing the coefficients of the polynomial. This is achieved using the command *sym2poly()*:

```
EDU» n = sym2poly(N);
```

and

```
EDU» d = sym2poly(D)
d =
6 53 117 70
```

after which we can determine the residues:

```
EDU» [r p y] = residue(n,d)
r =      p =      y =
-0.2579 -5.8333 [ ]
-0.0870 -2.0000
0.3448 -1.0000
```

which is in agreement with what we obtained using *ilaplace()*.

With these new MATLAB skills, (or a deep-seated desire to try an alternative approach such as Cramer's rule or direct substitution), we are ready to proceed to analyze a few circuits.

### EXAMPLE 15.3

Determine the two mesh currents  $i_1$  and  $i_2$  in the circuit of Fig. 15.7a. There is no energy initially stored in the circuit.

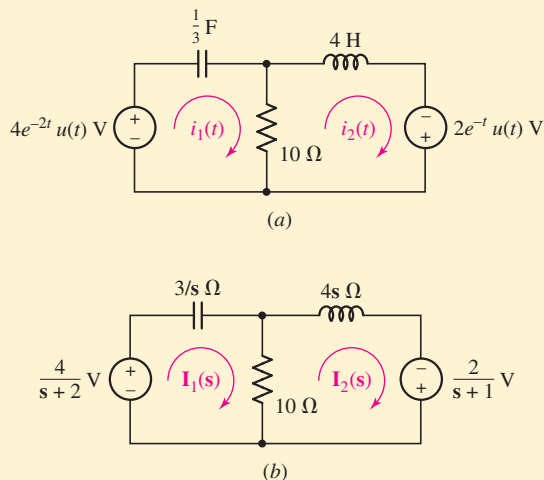

■ FIGURE 15.7 (a) A two-mesh circuit for which the individual mesh currents are desired. (b) The frequency-domain equivalent circuit.

As always, our first step is to draw the appropriate frequency-domain equivalent circuit. Since we have zero energy stored in the circuit at

$t = 0^-$ , we replace the  $\frac{1}{3}$  F capacitor with a  $3/s$   $\Omega$  impedance, and the 4 H inductor with a  $4s$   $\Omega$  impedance, as shown in Fig. 15.7b.

Next, we write two mesh equations just as we have before:

$$-\frac{4}{s+2} + \frac{3}{s}\mathbf{I}_1 + 10\mathbf{I}_1 - 10\mathbf{I}_2 = 0$$

or

$$\left(\frac{3}{s} + 10\right)\mathbf{I}_1 - 10\mathbf{I}_2 = \frac{4}{s+2} \quad (\text{mesh 1})$$

and

$$-\frac{2}{s+1} + 10\mathbf{I}_2 - 10\mathbf{I}_1 + 4s\mathbf{I}_2 = 0$$

or

$$-10\mathbf{I}_1 + (4s + 10)\mathbf{I}_2 = \frac{2}{s+1} \quad (\text{mesh 2})$$

Solving for  $\mathbf{I}_1$  and  $\mathbf{I}_2$ , we find that

$$\mathbf{I}_1 = \frac{2s(4s^2 + 19s + 20)}{20s^4 + 66s^3 + 73s^2 + 57s + 30} \quad \text{A}$$

and

$$\mathbf{I}_2 = \frac{30s^2 + 43s + 6}{(s+2)(20s^3 + 26s^2 + 21s + 15)} \quad \text{A}$$

All that remains is for us to take the inverse Laplace transform of each function, after which we find that

$$i_1(t) = -96.39e^{-2t} - 344.8e^{-t} + 841.2e^{-0.15t} \cos 0.8529t + 197.7e^{-0.15t} \sin 0.8529t \quad \text{mA}$$

and

$$i_2(t) = -481.9e^{-2t} - 241.4e^{-t} + 723.3e^{-0.15t} \cos 0.8529t + 472.8e^{-0.15t} \sin 0.8529t \quad \text{mA}$$

We were (indirectly) told that no current flows through the inductor at  $t = 0^-$ . Therefore,  $i_2(0^-) = 0$ , and consequently  $i_2(0^+)$  must be zero as well. Does this result hold true for our answer?

## PRACTICE

15.3 Find the mesh currents  $i_1$  and  $i_2$  in the circuit of Fig. 15.8. You may assume no energy is stored in the circuit at  $t = 0^-$ .

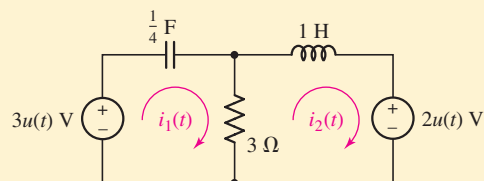
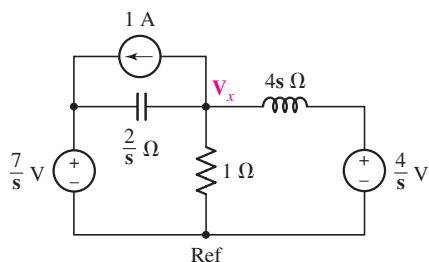

FIGURE 15.8

Ans:  $i_1 = e^{-2t/3} \cos\left(\frac{4}{3}\sqrt{2}t\right) + \left(\frac{\sqrt{2}}{8}\right)e^{-2t/3} \sin\left(\frac{4}{3}\sqrt{2}t\right)$  A;  
 $i_2 = -\frac{2}{3} + \frac{2}{3}e^{-2t/3} \cos\left(\frac{4}{3}\sqrt{2}t\right) + \left(\frac{13\sqrt{2}}{24}\right)e^{-2t/3} \sin\left(\frac{4}{3}\sqrt{2}t\right)$  A.

## EXAMPLE 15.4

Calculate the voltage  $v_x$  in the circuit of Fig. 15.9 using nodal analysis techniques.



■ FIGURE 15.10 The s-domain equivalent circuit of Fig. 15.9.

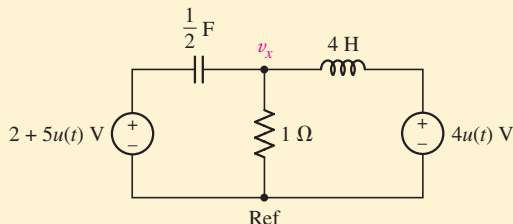

■ FIGURE 15.9 A simple four-node circuit containing two energy storage elements.

The first step is to draw the corresponding s-domain circuit. We see that the  $\frac{1}{2}$  F capacitor has an initial voltage of 2 V across it at  $t = 0^-$ , requiring that we employ one of the two models of Fig. 15.5. Since we are to use nodal analysis, perhaps the model of Fig. 15.5b is the better route. The resulting circuit is shown in Fig. 15.10.

With two of the three nodal voltages specified, we have only one nodal equation to write:

$$-1 = \frac{V_x - 7/s}{2/s} + V_x + \frac{V_x - 4/s}{4s}$$

so that

$$V_x = \frac{10s^2 + 4}{s(2s^2 + 4s + 1)} = \frac{5s^2 + 2}{s\left(s + 1 + \frac{\sqrt{2}}{2}\right)\left(s + 1 - \frac{\sqrt{2}}{2}\right)}$$

The nodal voltage  $v_x$  is found by taking the inverse Laplace transform, and we find that

$$v_x = [4 + 6.864e^{-1.707t} - 5.864e^{-0.2929t}]u(t)$$

or

$$v_x = \left[4 - e^{-t} \left(9\sqrt{2} \sinh \frac{\sqrt{2}}{2}t - \cosh \frac{\sqrt{2}}{2}t\right)\right]u(t)$$

*Is our answer correct?* One way to check is to evaluate the capacitor voltage at  $t = 0$ , since we know it to be 2 V. Thus,

$$V_C = \frac{7}{s} - V_x = \frac{4s^2 + 28s + 3}{s(2s^2 + 4s + 1)}$$

Multiplying  $V_C$  by  $s$  and taking the limit as  $s \rightarrow \infty$ , we find that

$$v_c(0^+) = \lim_{s \rightarrow \infty} \left[ \frac{4s^2 + 28s + 3}{2s^2 + 4s + 1} \right] = 2 \text{ V}$$

as expected.



## PRACTICE

15.4 Employ nodal analysis to calculate  $v_x(t)$  for the circuit of Fig. 15.11.

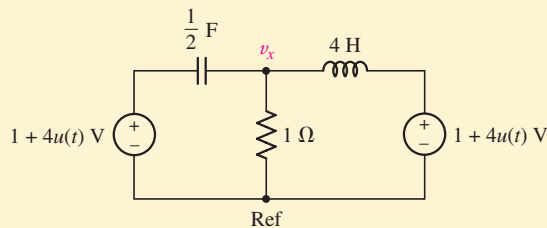

FIGURE 15.11 For Practice Problem 15.4.

Ans:  $[5 + 5.657(e^{-1.707t} - e^{-0.2929t})]u(t)$ .

## EXAMPLE 15.5

Use nodal analysis to determine the voltages  $v_1$ ,  $v_2$ , and  $v_3$  in the circuit of Fig. 15.12a. No energy is stored in the circuit at  $t = 0^-$ .

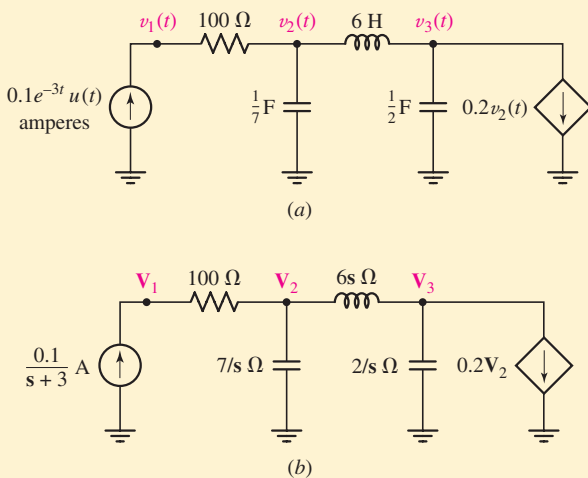

FIGURE 15.12 (a) A four-node circuit containing two capacitors and one inductor, none of which are storing energy at  $t = 0^-$ . (b) The frequency-domain equivalent circuit.

This circuit consists of three separate energy storage elements, none of which is storing any energy at  $t = 0^-$ . Thus, each may be replaced by their corresponding impedance as shown in Fig. 15.12b. We also note the presence of a dependent current source controlled by the nodal voltage  $v_2(t)$ .

Beginning at node 1, we write the following equation:

$$\frac{0.1}{s+3} = \frac{V_1 - V_2}{100}$$

(Continued on next page)

or

$$\frac{10}{s+3} = \mathbf{V}_1 - \mathbf{V}_2 \quad (\text{node 1})$$

and at node 2,

$$0 = \frac{\mathbf{V}_2 - \mathbf{V}_1}{100} + \frac{\mathbf{V}_2}{7/s} + \frac{\mathbf{V}_2 - \mathbf{V}_3}{6s}$$

or

$$-42s\mathbf{V}_1 + (600s^2 + 42s + 700)\mathbf{V}_2 - 700\mathbf{V}_3 = 0 \quad (\text{node 2})$$

and finally, at node 3,

$$-0.2\mathbf{V}_2 = \frac{\mathbf{V}_3 - \mathbf{V}_2}{6s} + \frac{\mathbf{V}_3}{2/s}$$

or

$$(1.2s - 1)\mathbf{V}_2 + (3s^2 + 1)\mathbf{V}_3 = 0$$

Solving this set of equations for the nodal voltages, we obtain

$$\mathbf{V}_1 = 3 \frac{100s^3 + 7s^2 + 150s + 49}{(s+3)(30s^3 + 45s + 14)}$$

$$\mathbf{V}_2 = 7 \frac{3s^2 + 1}{(s+3)(30s^3 + 45s + 14)}$$

$$\mathbf{V}_3 = -1.4 \frac{6s - 5}{(s+3)(30s^3 + 45s + 14)}$$

The only remaining step is to take the inverse Laplace transform of each voltage, so that, for  $t > 0$ ,

$$v_1(t) = 9.789e^{-3t} + 0.06173e^{-0.2941t} + 0.1488e^{0.1471t} \cos(1.251t) \\ + 0.05172e^{0.1471t} \sin(1.251t) \text{ V}$$

$$v_2(t) = -0.2105e^{-3t} + 0.06173e^{-0.2941t} + 0.1488e^{0.1471t} \cos(1.251t) \\ + 0.05172e^{0.1471t} \sin(1.251t) \text{ V}$$

$$v_3(t) = -0.03459e^{-3t} + 0.06631e^{-0.2941t} - 0.03172e^{0.1471t} \cos(1.251t) \\ - 0.06362e^{0.1471t} \sin(1.251t) \text{ V}$$

Note that the response grows exponentially as a result of the action of the dependent current source. In essence, the circuit is “running away,” indicating that at some point a component will melt, explode, or fail in some related fashion. Although analyzing such circuits can evidently entail a great deal of work, the advantages to s-domain techniques are clear once we contemplate performing the analysis in the time domain!

### PRACTICE

15.5 Use nodal analysis to determine the voltages  $v_1$ ,  $v_2$ , and  $v_3$  in the circuit of Fig. 15.13. Assume there is zero energy stored in the inductors at  $t = 0^-$ .

Ans:  $v_1(t) = -30\delta(t) - 14u(t)$  V;  $v_2(t) = -14u(t)$  V;  $v_3(t) = 24\delta(t) - 14u(t)$  V.

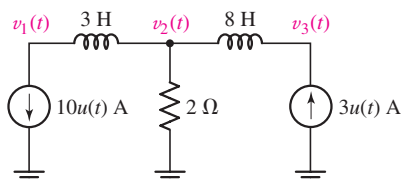

FIGURE 15.13

### 15.3 ADDITIONAL CIRCUIT ANALYSIS TECHNIQUES

Depending on the specific goal in analyzing a particular circuit, we often find that we can simplify our task by carefully choosing our analysis technique. For example, it is seldom desirable to apply superposition to a circuit containing 215 independent sources, as such an approach requires analysis of 215 separate circuits! By treating passive elements such as capacitors and inductors as impedances, however, we are free to employ any of the circuit analysis techniques studied in Chaps. 3, 4, and 5 to circuits that have been transformed to their  $s$ -domain equivalents.

Thus, superposition, source transformations, Thévenin's theorem, and Norton's theorem all apply in the  $s$ -domain.

#### EXAMPLE 15.6

**Simplify the circuit of Fig. 15.14a using source transformations, and determine an expression for the voltage  $v(t)$ .**

With no initial currents or voltages specified, and a  $u(t)$  multiplying the voltage source, we conclude that there is no energy initially stored in the circuit. Thus, we draw the frequency-domain circuit as shown in Fig. 15.14b.

Our strategy will be to perform several source transformations in succession in order to combine the two  $2/s \Omega$  impedances and the  $10 \Omega$  resistor; we must leave the  $9s \Omega$  impedance alone as the desired quantity  $V(s)$  appears across its terminals. We may now transform the voltage source and the leftmost  $2/s \Omega$  impedance into a current source

$$\mathbf{I}(s) = \left( \frac{2s}{s^2 + 9} \right) \left( \frac{s}{2} \right) = \frac{s^2}{s^2 + 9} \quad \text{A}$$

in parallel with a  $2/s \Omega$  impedance.

As depicted in Fig. 15.15a, after this transformation, we have  $\mathbf{Z}_1 \equiv (2/s) \parallel 10 = 20/(10s + 2) \Omega$  facing the current source. Performing another source transformation, we obtain a voltage source  $\mathbf{V}_2(s)$  such that

$$\mathbf{V}_2(s) = \left( \frac{s^2}{s^2 + 9} \right) \left( \frac{20}{10s + 2} \right)$$

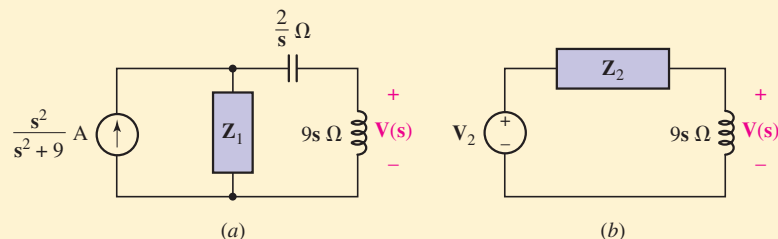

FIGURE 15.15 (a) Circuit after first source transformation. (b) Final circuit to be analyzed for  $V(s)$ .

This voltage source is in series with  $\mathbf{Z}_1$  and also with the remaining  $2/s$  impedance; combining  $\mathbf{Z}_1$  and  $2/s$  into a new impedance  $\mathbf{Z}_2$  yields

$$\mathbf{Z}_2 = \frac{20}{10s + 2} + \frac{2}{s} = \frac{40s + 4}{s(10s + 2)} \quad \Omega$$

(Continued on next page)

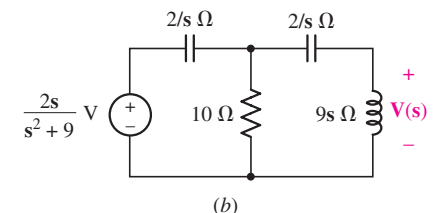
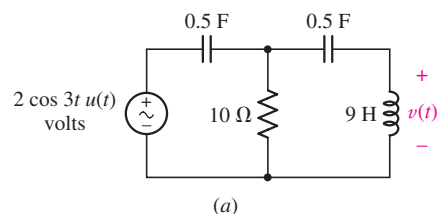

FIGURE 15.14 (a) Circuit to be simplified using source transformations. (b) Frequency-domain representation.

The resulting circuit is shown in Fig. 15.15b. At this stage, we are now ready to obtain an expression for the voltage  $V(s)$  using simple voltage division:

$$\begin{aligned} V(s) &= \left( \frac{s^2}{s^2 + 9} \right) \left( \frac{20}{10s + 2} \right) \frac{9s}{9s + \left[ \frac{40s + 4}{s(10s + 2)} \right]} \\ &= \frac{180s^4}{(s^2 + 9)(90s^3 + 18s^2 + 40s + 4)} \end{aligned}$$

Both terms in the denominator possess complex roots. Employing MATLAB to expand the denominator and then determine the residues,

```
EDU> d1 = 's^2 + 9';
EDU> d2 = '90*s^3 + 18*s^2 + 40*s + 4';
EDU> d = symmul(d1,d2);
EDU> denominator = expand(d);
EDU> den = sym2poly(denominator);
EDU> num = [180 0 0 0 0];
EDU> [r p y] = residue(num,den);
```

we find

$$\begin{aligned} V(s) &= \frac{1.047 + j0.0716}{s - j3} + \frac{1.047 - j0.0716}{s + j3} - \frac{0.0471 + j0.0191}{s + 0.04885 - j0.6573} \\ &\quad - \frac{0.0471 - j0.0191}{s + 0.04885 + j0.6573} + \frac{5.590 \times 10^{-5}}{s + 0.1023} \end{aligned}$$

Taking the inverse transform of each term, writing  $1.047 + j0.0716$  as  $1.049e^{j3.912^\circ}$  and  $0.0471 + j0.0191$  as  $0.05083e^{j157.9^\circ}$  results in

$$\begin{aligned} v(t) &= 1.049e^{j3.912^\circ} e^{j3t} u(t) + 1.049e^{-j3.912^\circ} e^{-j3t} u(t) \\ &\quad + 0.05083e^{-j157.9^\circ} e^{-0.04885t} e^{-j0.6573t} u(t) \\ &\quad + 0.05083e^{+j157.9^\circ} e^{-0.04885t} e^{+j0.6573t} u(t) \\ &\quad + 5.590 \times 10^{-5} e^{-0.1023t} u(t) \end{aligned}$$

Converting the complex exponentials to sinusoids then allows us to write a slightly simplified expression for our voltage

$$\begin{aligned} v(t) &= [5.590 \times 10^{-5} e^{-0.1023t} + 2.098 \cos(3t + 3.912^\circ) \\ &\quad + 0.1017e^{-0.04885t} \cos(0.6573t + 157.9^\circ)] u(t) \quad V \end{aligned}$$

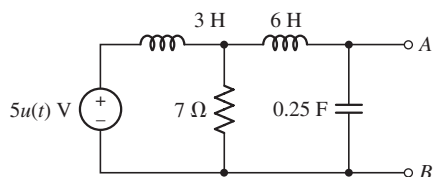

■ FIGURE 15.16

## PRACTICE

15.6 Using the method of source transformation, reduce the circuit of Fig. 15.16 to a single s-domain current source in parallel with a single impedance.

$$\text{Ans: } \mathbf{I}_s = \frac{35}{s^2(18s + 63)} \text{ A, } \mathbf{Z}_s = \frac{72s^2 + 252s}{18s^3 + 63s^2 + 12s + 28} \Omega.$$

## EXAMPLE 15.7

Find the frequency-domain Thévenin equivalent of the highlighted network shown in Fig. 15.17a.

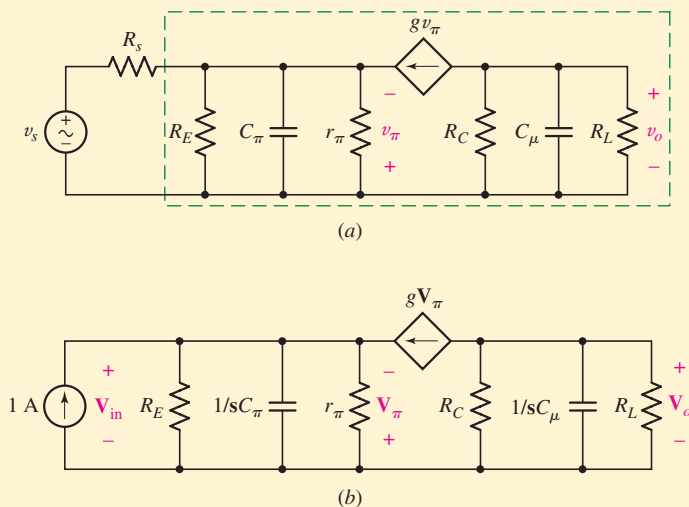

FIGURE 15.17 (a) An equivalent circuit for the “common base” transistor amplifier. (b) The frequency-domain equivalent circuit with a 1 A test source substituted for the input source represented by  $v_s$  and  $R_s$ .

We are being asked to determine the Thévenin equivalent of the circuit connected to the input device; this quantity is often referred to as the **input impedance** of the amplifier circuit. After converting the circuit to its frequency-domain equivalent, we replace the input device ( $v_s$  and  $R_s$ ) with a 1 A “test” source, as shown in Fig. 15.17b. The input impedance  $Z_{in}$  is then

$$Z_{in} = \frac{V_{in}}{1}$$

or simply  $V_{in}$ . We must find an expression for this quantity in terms of the 1 A source, resistors and capacitors, and/or the dependent source parameter  $g$ .

Writing a single nodal equation at the input, then, we find that

$$1 + gV_{\pi} = \frac{V_{in}}{Z_{eq}}$$

where

$$Z_{eq} \equiv R_E \left\| \frac{1}{sC_{\pi}} \right\| r_{\pi} = \frac{R_E r_{\pi}}{r_{\pi} + R_E + sR_E r_{\pi} C_{\pi}}$$

Since  $V_{\pi} = -V_{in}$ , we find that

$$Z_{in} = V_{in} = \frac{R_E r_{\pi}}{r_{\pi} + R_E + sR_E r_{\pi} C_{\pi} + gR_E r_{\pi}} \quad \Omega$$

This particular circuit is known as the “hybrid  $\pi$ ” model for a special type of single-transistor circuit known as the common base amplifier. The two capacitors,  $C_{\pi}$  and  $C_{\mu}$ , represent capacitances internal to the transistor, and are typically on the order of a few pF. The resistor  $R_L$  in the circuit represents the Thévenin equivalent resistance of the output device, which could be a speaker or even a semiconductor laser. The voltage source  $v_s$  and the resistor  $R_s$  together represent the Thévenin equivalent of the input device, which may be a microphone, a light-sensitive resistor, or possibly a radio antenna.

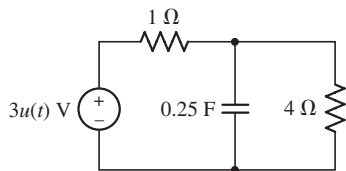

FIGURE 15.18

### PRACTICE

15.7 Working in the  $s$ -domain, find the Norton equivalent connected to the  $1\ \Omega$  resistor in the circuit of Fig. 15.18.

Ans:  $\mathbf{I}_{sc} = 3(s + 1)/4s\ \text{A}$ ;  $\mathbf{Z}_{th} = 4/(s + 1)\ \Omega$ .

## 15.4 POLES, ZEROS, AND TRANSFER FUNCTIONS

In this section, we revisit terminology first introduced in Chap. 14, namely, *poles*, *zeros*, and *transfer functions*.

Consider the simple circuit in Fig. 15.19a. The  $s$ -domain equivalent is given in Fig. 15.19b, and nodal analysis yields

$$0 = \frac{\mathbf{V}_{out}}{1/sC} + \frac{\mathbf{V}_{out} - \mathbf{V}_{in}}{R}$$

Rearranging and solving for  $\mathbf{V}_{out}$ , we find

$$\mathbf{V}_{out} = \frac{\mathbf{V}_{in}}{1 + sRC}$$

or

$$\mathbf{H}(s) \equiv \frac{\mathbf{V}_{out}}{\mathbf{V}_{in}} = \frac{1}{1 + sRC} \quad [7]$$

where  $\mathbf{H}(s)$  is the *transfer function* of the circuit, defined as the ratio of the output to the input. We could just as easily specify a particular current as either the input or output quantity, leading to a different transfer function for the same circuit. Circuit schematics are typically read from left to right, so designers often place the input of a circuit on the left of the schematic and the output terminals on the right, at least to the extent where it is possible.

The concept of a transfer function is very important, both in terms of circuit analysis as well as in other areas of engineering. There are two reasons for this. First, once we know the transfer function of a particular circuit, we can easily find the output that results from *any* input. All we need to do is multiply  $\mathbf{H}(s)$  by the input quantity, and take the inverse transform of the resulting expression. Second, the form of the transfer function contains a great deal of information about the behavior we might expect from a particular circuit (or system).

As alluded to in the Practical Application of Chap. 14, in order to evaluate the stability of a system it is necessary to determine the poles and zeros of the transfer function  $\mathbf{H}(s)$ ; we will explore this issue in detail shortly. Writing Eq. [7] as

$$\mathbf{H}(s) = \frac{1/RC}{s + 1/RC} \quad [8]$$

we see that the magnitude of this function approaches zero as  $s \rightarrow \infty$ . Thus, we say that  $\mathbf{H}(s)$  has a *zero* at  $s = \infty$ . The function approaches infinity at

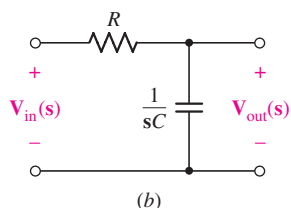
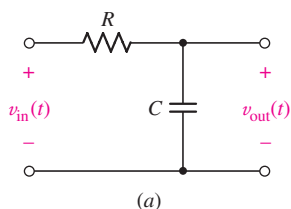

FIGURE 15.19 (a) A simple resistor-capacitor circuit, with an input voltage and output voltage specified. (b) The  $s$ -domain equivalent circuit.

When computing magnitude, it is customary to consider  $+\infty$  and  $-\infty$  as being the same frequency. The phase angle of the response at very large positive and negative values of  $\omega$  need not be the same, however.

$s = -1/RC$ ; we therefore say that  $\mathbf{H}(s)$  has a *pole* at  $s = -1/RC$ . These frequencies are termed *critical frequencies*, and their early identification simplifies the construction of the response curves we will develop in Sec. 15.7.

## 15.5 CONVOLUTION

The  $s$ -domain techniques we have developed up to this point are very useful in determining the current and voltage response of a particular circuit. However, in practice we are often faced with circuits to which arbitrary sources can be connected, and require an efficient means of determining the new output each time. This is easily accomplished if we can characterize the basic circuit by a transfer function called the *system function*.

The analysis can proceed in either the time domain or the frequency domain, although it is generally more useful to work in the frequency domain. In such situations, we have a simple four-step process:

1. Determine the circuit system function (if not already known);
2. Obtain the Laplace transform of the forcing function to be applied;
3. Multiply this transform and the system function; and finally
4. Perform an inverse transform operation on the product to find the output.

By these means some relatively complicated integral expressions will be reduced to simple functions of  $s$ , and the mathematical operations of integration and differentiation will be replaced by the simpler operations of algebraic multiplication and division.

### The Impulse Response

Consider a linear electrical network  $N$ , without initial stored energy, to which a forcing function  $x(t)$  is applied. At some point in this circuit, a response function  $y(t)$  is present. We show this in block diagram form in Fig. 15.20a along with sketches of generic time functions. The forcing function is shown to exist only in the interval  $a < t < b$ . Thus,  $y(t)$  exists only for  $t > a$ .

The question that we now wish to answer is this: “*If we know the form of  $x(t)$ , how is  $y(t)$  described?*” To answer this question, we need to know something about  $N$ , such as its response when the forcing function is a unit impulse  $\delta(t)$ . That is, we are assuming that we know  $h(t)$ , the response function resulting when a unit impulse is supplied as the forcing function at  $t = 0$ , as shown in Fig. 15.20b. The function  $h(t)$  is commonly called the *unit-impulse response function*, or the *impulse response*.

Based on our knowledge of Laplace transforms, we can view this from a slightly different perspective. Transforming  $x(t)$  into  $\mathbf{X}(s)$  and  $y(t)$  into  $\mathbf{Y}(s)$ , we define the system transfer function  $\mathbf{H}(s)$  as

$$\mathbf{H}(s) \equiv \frac{\mathbf{Y}(s)}{\mathbf{X}(s)}$$

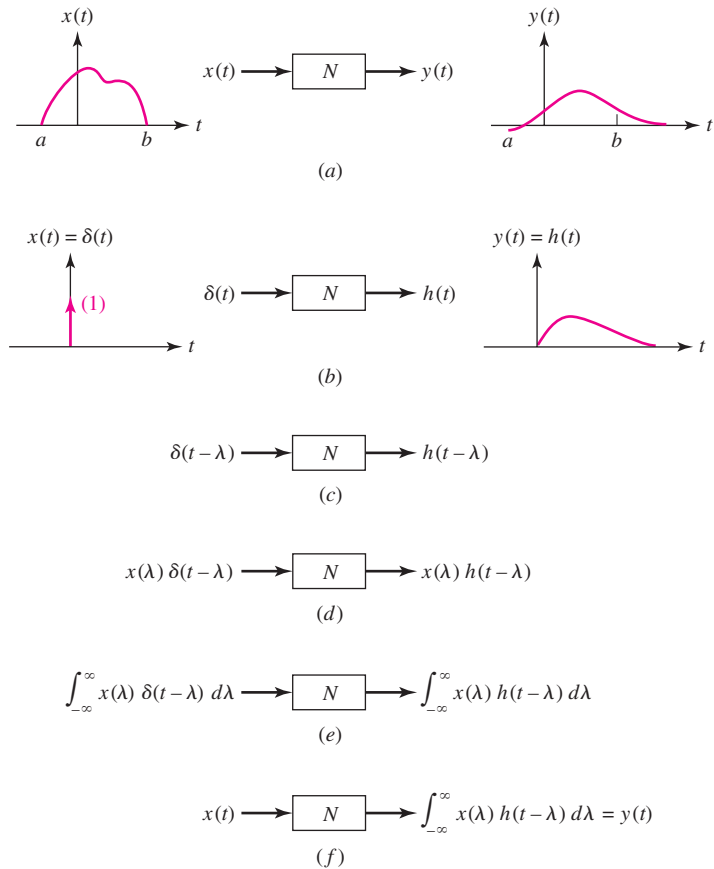

■ FIGURE 15.20 A conceptual development of the convolution integral.

If  $x(t) = \delta(t)$ , then according to Table 14.1,  $\mathbf{X}(s) = 1$ . Thus,  $\mathbf{H}(s) = \mathbf{Y}(s)$  and so *in this instance*  $h(t) = y(t)$ .

Instead of applying the unit impulse at time  $t = 0$ , let us now suppose that it is applied at time  $t = \lambda$  (lambda). We see that the only change in the output is a time delay. Thus, the output becomes  $h(t - \lambda)$  when the input is  $\delta(t - \lambda)$ , as shown in Fig. 15.20c. Next, suppose that the input impulse has some strength other than unity. Specifically, let the strength of the impulse be numerically equal to the value of  $x(t)$  when  $t = \lambda$ . This value  $x(\lambda)$  is a constant; we know that the multiplication of a single forcing function in a *linear* circuit by a constant simply causes the response to change proportionately. Thus, if the input is changed to  $x(\lambda)\delta(t - \lambda)$ , then the response becomes  $x(\lambda)h(t - \lambda)$ , as shown in Fig. 15.20d.

Now let us sum this latest input over all possible values of  $\lambda$  and use the result as a forcing function for  $N$ . Linearity decrees that the output must be equal to the sum of the responses resulting from the use of all possible values of  $\lambda$ . Loosely speaking, the integral of the input produces the integral of the output, as shown in Fig. 15.20e. But what is the input now? Given the sifting property<sup>1</sup> of the unit impulse, we see that the input is simply  $x(t)$ , the original input. Thus, Fig. 15.20e may be represented as in Fig. 15.20f.

(1) The sifting property of the impulse function, described in Section 14.5, states that  $\int_{-\infty}^{\infty} f(t)\delta(t - t_0) dt = f(t_0)$ .



## The Convolution Integral

If the input to our system  $N$  is the forcing function  $x(t)$ , we know the output must be the function  $y(t)$  as depicted in Fig. 15.20a. Thus, from Fig. 15.20f we conclude that

$$y(t) = \int_{-\infty}^{\infty} x(\lambda)h(t - \lambda) d\lambda \quad [9]$$

where  $h(t)$  is the impulse response of  $N$ . This important relationship is known far and wide as the **convolution integral**. In words, this last equation states that *the output is equal to the input convolved with the impulse response*. It is often abbreviated by means of

$$y(t) = x(t) * h(t)$$

where the asterisk is read “convolved with.”

Equation [9] sometimes appears in a slightly different but equivalent form. If we let  $z = t - \lambda$ , then  $d\lambda = -dz$ , and the expression for  $y(t)$  becomes

$$y(t) = \int_{\infty}^{-\infty} -x(t - z)h(z) dz = \int_{-\infty}^{\infty} x(t - z)h(z) dz$$

and since the symbol that we use for the variable of integration is unimportant, we can modify Eq. [9] to write

$$\begin{aligned} y(t) = x(t) * h(t) &= \int_{-\infty}^{\infty} x(z)h(t - z) dz \\ &= \int_{-\infty}^{\infty} x(t - z)h(z) dz \end{aligned} \quad [10]$$

## Convolution and Realizable Systems

The result that we have in Eq. [10] is very general; it applies to any linear system. However, we are usually interested in **physically realizable systems**, those that *do* exist or *could* exist, and such systems have a property that modifies the convolution integral slightly. That is, *the response of the system cannot begin before the forcing function is applied*. In particular,  $h(t)$  is the response of the system resulting from the application of a unit impulse at  $t = 0$ . Therefore,  $h(t)$  cannot exist for  $t < 0$ . It follows that, in the second integral of Eq. [10], the integrand is zero when  $z < 0$ ; in the first integral, the integrand is zero when  $(t - z)$  is negative, or when  $z > t$ . Therefore, for *realizable* systems the limits of integration change in the convolution integrals:

$$\begin{aligned} y(t) = x(t) * h(t) &= \int_{-\infty}^t x(z)h(t - z) dz \\ &= \int_0^{\infty} x(t - z)h(z) dz \end{aligned} \quad [11]$$

Be careful not to confuse this new notation with multiplication!

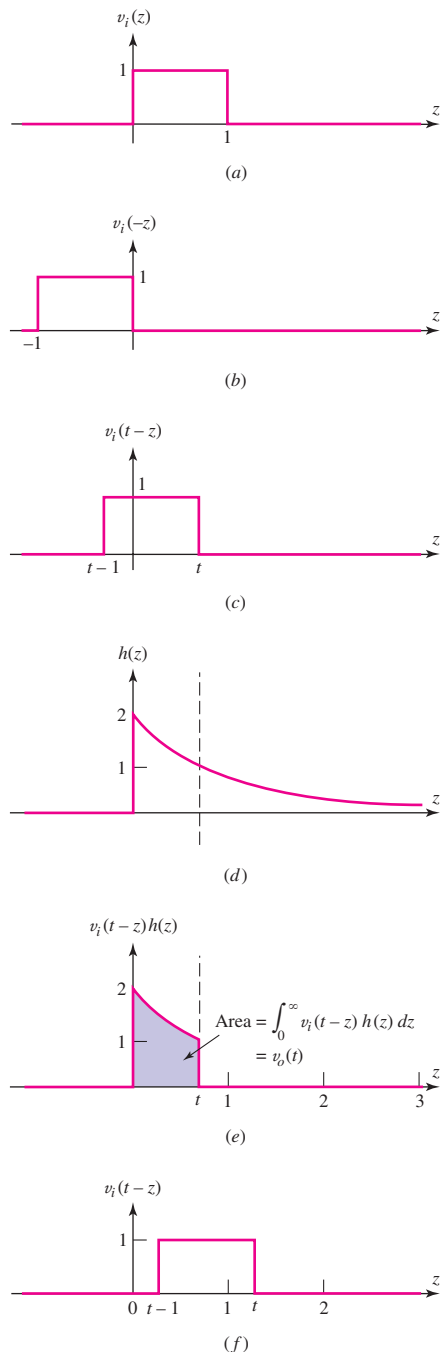

■ FIGURE 15.21 Graphical concepts in evaluating a convolution integral.

Equations [10] and [11] are both valid, but the latter is more specific when we are speaking of *realizable* linear systems, and well worth memorizing.

## Graphical Method of Convolution

Before discussing the significance of the impulse response of a circuit any further, let us consider a numerical example that will give us some insight into just how the convolution integral can be evaluated. Although the expression itself is simple enough, the evaluation is sometimes troublesome, especially with regard to the values used as the limits of integration.

Suppose that the input is a rectangular voltage pulse that starts at  $t = 0$ , has a duration of 1 second, and is 1 V in amplitude:

$$x(t) = v_i(t) = u(t) - u(t - 1)$$

Suppose also that this voltage pulse is applied to a circuit whose impulse response is known to be an exponential function of the form:

$$h(t) = 2e^{-t}u(t)$$

We wish to evaluate the output voltage  $v_o(t)$ , and we can write the answer immediately in integral form,

$$\begin{aligned} y(t) = v_o(t) &= v_i(t) * h(t) = \int_0^{\infty} v_i(t - z)h(z) dz \\ &= \int_0^{\infty} [u(t - z) - u(t - z - 1)][2e^{-z}u(z)] dz \end{aligned}$$

Obtaining this expression for  $v_o(t)$  is simple enough, but the presence of the many unit-step functions tends to make its evaluation confusing and possibly even a little obnoxious. Careful attention must be paid to the determination of those portions of the range of integration in which the integrand is zero.

Let us use some graphical assistance to help us understand what the convolution integral says. We begin by drawing several  $z$  axes lined up one above the other, as shown in Fig. 15.21. We know what  $v_i(t)$  looks like, and so we know what  $v_i(z)$  looks like also; this is plotted as Fig. 15.21a. The function  $v_i(-z)$  is simply  $v_i(z)$  run backward with respect to  $z$ , or rotated about the ordinate axis; it is shown in Fig. 15.21b. Next we wish to represent  $v_i(t - z)$ , which is  $v_i(-z)$  after it is shifted to the right by an amount  $z = t$  as shown in Fig. 15.21c. On the next  $z$  axis, in Fig. 15.21d, our impulse response  $h(z) = 2e^{-z}u(z)$  is plotted.

The next step is to multiply the two functions  $v_i(t - z)$  and  $h(z)$ ; the result for an arbitrary value of  $t < 1$  is shown in Fig. 15.21e. We are after a value for the output  $v_o(t)$ , which is given by the *area* under the product curve (shown shaded in the figure).

First consider  $t < 0$ . There is no overlap between  $v_i(t - z)$  and  $h(z)$ , so  $v_o = 0$ . As we increase  $t$ , we slide the pulse shown in Fig. 15.21c to the right, leading to an overlap with  $h(z)$  once  $t > 0$ . The area under the corresponding curve of Fig. 15.21e continues to increase as we increase the value of  $t$  until we reach  $t = 1$ . As  $t$  increases above this value, a gap opens up between  $z = 0$  and the leading edge of the pulse, as shown in Fig. 15.21f. As a result, the overlap with  $h(z)$  decreases.

In other words, for values of  $t$  that lie between zero and unity, we must integrate from  $z = 0$  to  $z = t$ ; for values of  $t$  that exceed unity, the range of integration is  $t - 1 < z < t$ . Thus, we may write

$$v_o(t) = \begin{cases} 0 & t < 0 \\ \int_0^t 2e^{-z} dz = 2(1 - e^{-t}) & 0 \leq t \leq 1 \\ \int_{t-1}^t 2e^{-z} dz = 2(e - 1)e^{-t} & t > 1 \end{cases}$$

This function is shown plotted versus the time variable  $t$  in Fig. 15.22, and our solution is completed.

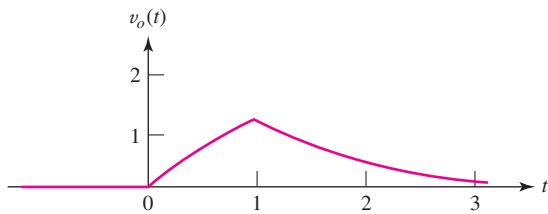

■ FIGURE 15.22 The output function  $v_o$  obtained by graphical convolution.

## EXAMPLE 15.8

**Apply a unit-step function,  $x(t) = u(t)$ , as the input to a system whose impulse response is  $h(t) = u(t) - 2u(t - 1) + u(t - 2)$ , and determine the corresponding output  $y(t) = x(t) * h(t)$ .**

Our first step is to plot both  $x(t)$  and  $h(t)$ , as shown in Fig. 15.23.

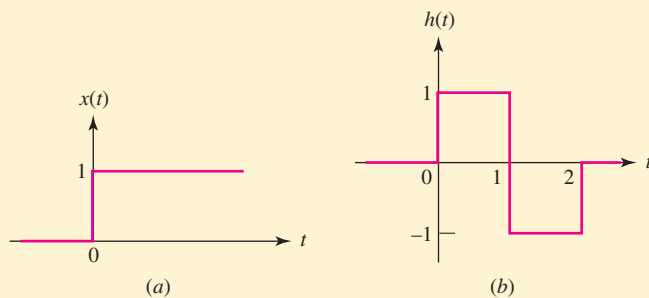

■ FIGURE 15.23 Sketches of (a) the input signal  $x(t) = u(t)$  and (b) the unit-impulse response  $h(t) = u(t) - 2u(t - 1) + u(t - 2)$ , for a linear system.

We arbitrarily choose to evaluate the first integral of Eq. [11],

$$y(t) = \int_{-\infty}^t x(z)h(t - z) dz$$

and prepare a sequence of sketches to help select the correct limits of integration. Figure 15.24 shows these functions in order: the input  $x(z)$  as a function of  $z$ ; the impulse response  $h(z)$ ; the curve of  $h(-z)$ ,

*(Continued on next page)*

which is just  $h(z)$  rotated about the vertical axis; and  $h(t - z)$ , obtained by sliding  $h(-z)$  to the right  $t$  units. For this sketch, we have selected  $t$  in the range  $0 < t < 1$ .

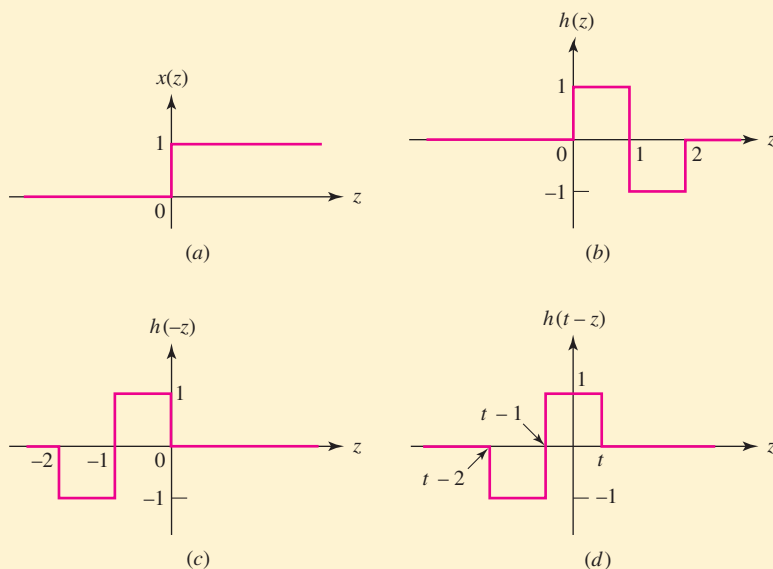

■ FIGURE 15.24 (a) The input signal and (b) the impulse response are plotted as functions of  $z$ . (c)  $h(-z)$  is obtained by flipping  $h(z)$  about the vertical axis, and (d)  $h(t - z)$  results when  $h(-z)$  is slid  $t$  units to the right.

It is now possible to visualize the product of the first graph,  $x(z)$ , and the last,  $h(t - z)$ , for the various ranges of  $t$ . When  $t$  is less than zero, there is no overlap, and

$$y(t) = 0 \quad t < 0$$

For the case sketched in Fig. 15.24d,  $h(t - z)$  has a nonzero overlap with  $x(z)$  from  $z = 0$  to  $z = t$ , and each is unity in value. Thus,

$$y(t) = \int_0^t (1 \times 1) dz = t \quad 0 < t < 1$$

When  $t$  lies between 1 and 2,  $h(t - z)$  has slid far enough to the right to bring under the step function that part of the negative square wave extending from  $z = 0$  to  $z = t - 1$ . We then have

$$y(t) = \int_0^{t-1} [1 \times (-1)] dz + \int_{t-1}^t (1 \times 1) dz = -z \Big|_{z=0}^{z=t-1} + z \Big|_{z=t-1}^{z=t}$$

Therefore,

$$y(t) = -(t - 1) + t - (t - 1) = 2 - t \quad 1 < t < 2$$

Finally, when  $t$  is greater than 2,  $h(t - z)$  has slid far enough to the right that it lies entirely to the right of  $z = 0$ . The intersection with the unit step is complete, and

$$y(t) = \int_{t-2}^{t-1} [1 \times (-1)] dz + \int_{t-1}^t (1 \times 1) dz = -z \Big|_{z=t-2}^{z=t-1} + z \Big|_{z=t-1}^{z=t}$$

or

$$y(t) = -(t - 1) + (t - 2) + t - (t - 1) = 0 \quad t > 2$$

These four segments of  $y(t)$  are collected as a continuous curve in Fig. 15.25.

### PRACTICE

15.8 Repeat Example 15.8 using the *second* integral of Eq. [11].

15.9 The impulse response of a network is given by  $h(t) = 5u(t - 1)$ . If an input signal  $x(t) = 2[u(t) - u(t - 3)]$  is applied, determine the output  $y(t)$  at  $t$  equal to (a)  $-0.5$ ; (b)  $0.5$ ; (c)  $2.5$ ; (d)  $3.5$ .

Ans: 15.9: 0, 0, 15, 25.

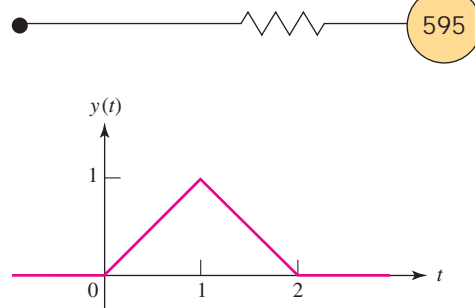

FIGURE 15.25 The result of convolving  $x(t)$  and  $h(t)$  as shown in Fig. 15.23.

## Convolution and the Laplace Transform

Convolution has applications in a wide variety of disciplines beyond linear circuit analysis, including image processing, communications, and semiconductor transport theory. It is often helpful therefore to have a graphical intuition of the basic process, even if the integral expressions of Eqs. [10] and [11] are not always the best solution route. One powerful alternative approach makes use of properties of the Laplace transform—hence our introduction to convolution in this chapter.

Let  $F_1(s)$  and  $F_2(s)$  be the Laplace transforms of  $f_1(t)$  and  $f_2(t)$ , respectively, and consider the Laplace transform of  $f_1(t) * f_2(t)$ ,

$$\mathcal{L}\{f_1(t) * f_2(t)\} = \mathcal{L}\left\{\int_{-\infty}^{\infty} f_1(\lambda) f_2(t - \lambda) d\lambda\right\}$$

One of these time functions will typically be the forcing function that is applied at the input terminals of a linear circuit, and the other will be the unit-impulse response of the circuit.

Since we are now dealing with time functions that do not exist prior to  $t = 0^-$  (the definition of the Laplace transform forces us to assume this), the lower limit of integration can be changed to  $0^-$ . Then, using the definition of the Laplace transform, we get

$$\mathcal{L}\{f_1(t) * f_2(t)\} = \int_{0^-}^{\infty} e^{-st} \left[ \int_{0^-}^{\infty} f_1(\lambda) f_2(t - \lambda) d\lambda \right] dt$$

Since  $e^{-st}$  does not depend upon  $\lambda$ , we can move this factor inside the inner integral. If we do this and also reverse the order of integration, the result is

$$\mathcal{L}\{f_1(t) * f_2(t)\} = \int_{0^-}^{\infty} \left[ \int_{0^-}^{\infty} e^{-st} f_1(\lambda) f_2(t - \lambda) dt \right] d\lambda$$

Continuing with the same type of trickery, we note that  $f_1(\lambda)$  does not depend upon  $t$ , and so it can be moved outside the inner integral:

$$\mathcal{L}\{f_1(t) * f_2(t)\} = \int_{0^-}^{\infty} f_1(\lambda) \left[ \int_{0^-}^{\infty} e^{-st} f_2(t - \lambda) dt \right] d\lambda$$

We then make the substitution  $x = t - \lambda$  in the bracketed integral (where we may treat  $\lambda$  as a constant):

$$\begin{aligned}\mathcal{L}\{f_1(t) * f_2(t)\} &= \int_{0^-}^{\infty} f_1(\lambda) \left[ \int_{-\lambda}^{\infty} e^{-s(x+\lambda)} f_2(x) dx \right] d\lambda \\ &= \int_{0^-}^{\infty} f_1(\lambda) e^{-s\lambda} \left[ \int_{-\lambda}^{\infty} e^{-sx} f_2(x) dx \right] d\lambda \\ &= \int_{0^-}^{\infty} f_1(\lambda) e^{-s\lambda} [\mathbf{F}_2(\mathbf{s})] d\lambda \\ &= \mathbf{F}_2(\mathbf{s}) \int_{0^-}^{\infty} f_1(\lambda) e^{-s\lambda} d\lambda\end{aligned}$$

Since the remaining integral is simply  $\mathbf{F}_1(\mathbf{s})$ , we find that

$$\mathcal{L}\{f_1(t) * f_2(t)\} = \mathbf{F}_1(\mathbf{s}) \cdot \mathbf{F}_2(\mathbf{s}) \quad [12]$$

Stated slightly differently, we may conclude that the inverse transform of the product of two transforms is the convolution of the individual inverse transforms, a result that is sometimes useful in obtaining inverse transforms.

### EXAMPLE 15.9

**Find  $v(t)$  by applying convolution techniques, given that  $\mathbf{V}(\mathbf{s}) = 1/[(\mathbf{s} + \alpha)(\mathbf{s} + \beta)]$ .**

We obtained the inverse transform of this particular function in Sec. 14.5 using a partial-fraction expansion. We now identify  $\mathbf{V}(\mathbf{s})$  as the product of two transforms,

$$\mathbf{V}_1(\mathbf{s}) = \frac{1}{\mathbf{s} + \alpha}$$

and

$$\mathbf{V}_2(\mathbf{s}) = \frac{1}{\mathbf{s} + \beta}$$

where

$$v_1(t) = e^{-\alpha t} u(t)$$

and

$$v_2(t) = e^{-\beta t} u(t)$$

The desired  $v(t)$  can be expressed as

$$\begin{aligned}v(t) &= \mathcal{L}^{-1}\{\mathbf{V}_1(\mathbf{s})\mathbf{V}_2(\mathbf{s})\} = v_1(t) * v_2(t) = \int_{0^-}^{\infty} v_1(\lambda) v_2(t - \lambda) d\lambda \\ &= \int_{0^-}^{\infty} e^{-\alpha\lambda} u(\lambda) e^{-\beta(t-\lambda)} u(t - \lambda) d\lambda = \int_{0^-}^t e^{-\alpha\lambda} e^{-\beta t} e^{\beta\lambda} d\lambda \\ &= e^{-\beta t} \int_{0^-}^t e^{(\beta-\alpha)\lambda} d\lambda = e^{-\beta t} \frac{e^{(\beta-\alpha)t} - 1}{\beta - \alpha} u(t)\end{aligned}$$

or, more compactly,

$$v(t) = \frac{1}{\beta - \alpha} (e^{-\alpha t} - e^{-\beta t})u(t)$$

which is the same result that we obtained before using partial-fraction expansion. Note that it is necessary to insert the unit step  $u(t)$  in the result because all (one-sided) Laplace transforms are valid only for nonnegative time.

### PRACTICE

15.10 Repeat Example 15.8, performing the convolution in the s-domain.

Was the result easier to obtain by this method? Not unless one is in love with convolution integrals! The partial-fraction-expansion method is usually simpler, assuming that the expansion itself is not too cumbersome. However, the operation of convolution is easier to perform in the s-domain, since it only requires multiplication.

### Further Comments on Transfer Functions

As we have noted several times before, the output  $v_o(t)$  at some point in a linear circuit can be obtained by convolving the input  $v_i(t)$  with the unit-impulse response  $h(t)$ . However, we must remember that the impulse response results from the application of a unit impulse at  $t = 0$  with all initial conditions zero. Under these conditions, the Laplace transform of  $v_o(t)$  is

$$\mathcal{L}\{v_o(t)\} = \mathbf{V}_o(\mathbf{s}) = \mathcal{L}\{v_i(t) * h(t)\} = \mathbf{V}_i(\mathbf{s})[\mathcal{L}\{h(t)\}]$$

Thus, the ratio  $\mathbf{V}_o(\mathbf{s})/\mathbf{V}_i(\mathbf{s})$  is equal to the transform of the impulse response, which we shall denote by  $\mathbf{H}(\mathbf{s})$ ,

$$\mathcal{L}\{h(t)\} = \mathbf{H}(\mathbf{s}) = \frac{\mathbf{V}_o(\mathbf{s})}{\mathbf{V}_i(\mathbf{s})} \quad [13]$$

From Eq. [13] we see that the impulse response and the transfer function make up a Laplace transform pair,

$$h(t) \Leftrightarrow \mathbf{H}(\mathbf{s})$$

This is an important fact that we shall explore further in Sec. 15.7, after becoming familiar with the concept of pole-zero plots and the complex-frequency plane. At this point, however, we are already able to exploit this new concept of convolution for circuit analysis.



### EXAMPLE 15.10

Determine the impulse response of the circuit in Fig. 15.26a, and use this to compute the forced response  $v_o(t)$  if the input  $v_{in}(t) = 6e^{-t}u(t)$  V.

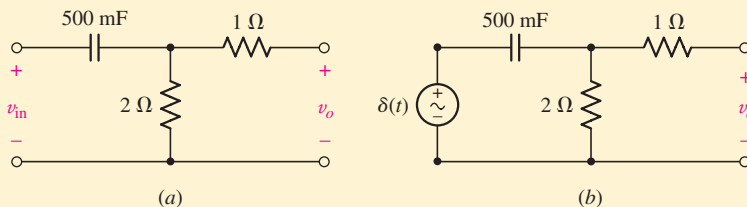
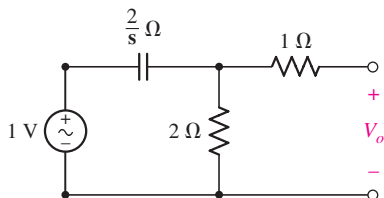

FIGURE 15.26 (a) A simple circuit to which an exponential input is applied at  $t = 0$ .  
(b) Circuit used to determine  $h(t)$ .

(Continued on next page)



■ FIGURE 15.27 Circuit used to find  $\mathbf{H}(s)$ .

We first connect an impulse voltage pulse  $\delta(t)$  V to the circuit as shown in Fig. 15.26b. Although we may work in either the time domain with  $h(t)$  or the s-domain with  $\mathbf{H}(s)$ , we choose the latter, so we next consider the s-domain representation of Fig. 15.26b as depicted in Fig. 15.27.

The impulse response  $\mathbf{H}(s)$  is given by

$$\mathbf{H}(s) = \frac{\mathbf{V}_o}{1}$$

so our immediate goal is to find  $\mathbf{V}_o$ —a task easily performed by simple voltage division:

$$\mathbf{V}_o \Big|_{v_{in}=\delta(t)} = \frac{2}{2/s + 2} = \frac{s}{s + 1} = \mathbf{H}(s)$$

We may now find  $v_o(t)$  when  $v_{in} = 6e^{-t}u(t)$  using convolution, as

$$v_{in} = \mathcal{L}^{-1}\{\mathbf{V}_{in}(s) \cdot \mathbf{H}(s)\}$$

Since  $\mathbf{V}_{in}(s) = 6/(s + 1)$ ,

$$\mathbf{V}_o = \frac{6s}{(s + 1)^2} = \frac{6}{s + 1} - \frac{6}{(s + 1)^2}$$

Taking the inverse Laplace transform, we find that

$$v_o(t) = 6e^{-t}(1 - t)u(t) \quad \text{V}$$

## PRACTICE

15.11 Referring to the circuit of Fig. 15.26a, use convolution to obtain  $v_o(t)$  if  $v_{in} = tu(t)$  V.

Ans:  $v_o(t) = (1 - e^{-t})u(t)$  V.

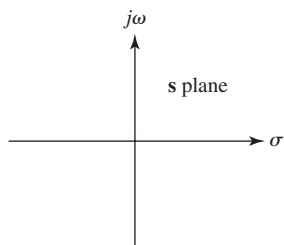

■ FIGURE 15.28 The complex-frequency plane, also referred to as the s plane.

## 15.6 THE COMPLEX-FREQUENCY PLANE

As evident in the last several examples, circuits with even a comparatively small number of elements can lead to rather unwieldy s-domain expressions. In such instances, a graphical representation of a particular circuit response or transfer function can provide useful insights. In this section, we introduce one such technique, based on the idea of the complex-frequency plane (Fig. 15.28). Complex frequency has two components ( $\sigma$  and  $\omega$ ), so we are naturally drawn to representing our functions using a three-dimensional model.

Since  $\omega$  represents an oscillating function, there is no physical distinction between a positive and negative frequency. In the case of  $\sigma$ , however, which can be identified with an exponential term, positive values are increasing in magnitude, whereas negative values are decaying. The origin of the s plane corresponds to dc (no time variation). A pictorial summary of these ideas is presented in Fig. 15.29.



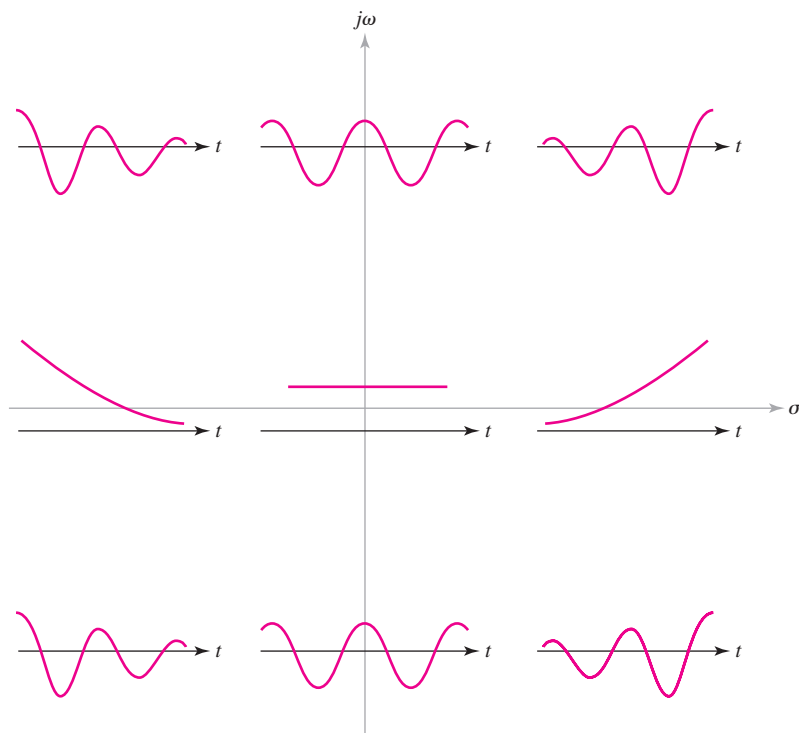

■ FIGURE 15.29 An illustration of the physical meaning of positive and negative values for  $\sigma$  and  $\omega$ , as would be represented on the complex-frequency plane. When  $\omega = 0$ , a function will have no oscillatory component; when  $\sigma = 0$ , the function is purely sinusoidal except when  $\omega$  is also zero.

To construct an appropriate three-dimensional representation of some function  $\mathbf{F}(s)$ , we first note that we have its magnitude in mind, although the phase will have a strong complex-frequency dependence as well and may be graphed in a similar fashion. Thus, we will begin by substituting  $\sigma + j\omega$  for  $s$  in our function  $\mathbf{F}(s)$ , then proceed to determine an expression for  $|\mathbf{F}(s)|$ . We next draw an axis perpendicular to the  $s$  plane, and use this to plot  $|\mathbf{F}(s)|$  for each value of  $\sigma$  and  $\omega$ . The basic process is illustrated in the following example.

### EXAMPLE 15.11

**Sketch the admittance of the series combination of a 1 H inductor and a 3  $\Omega$  resistor as a function of both  $j\omega$  and  $\sigma$ .**

The admittance of these two series elements is given by

$$\mathbf{Y}(s) = \frac{1}{s + 3}$$

Substituting  $s = \sigma + j\omega$ , we find the magnitude of the function is

$$|\mathbf{Y}(s)| = \frac{1}{\sqrt{(\sigma + 3)^2 + \omega^2}}$$

(Continued on next page)

When  $s = -3 + j0$ , the response magnitude is infinite; when  $s$  is infinite, the magnitude of  $\mathbf{Y}(s)$  is zero. Thus our model must have infinite height over the point  $(-3 + j0)$ , and it must have zero height at all points infinitely far away from the origin. A cutaway view of such a model is shown in Fig. 15.30a.

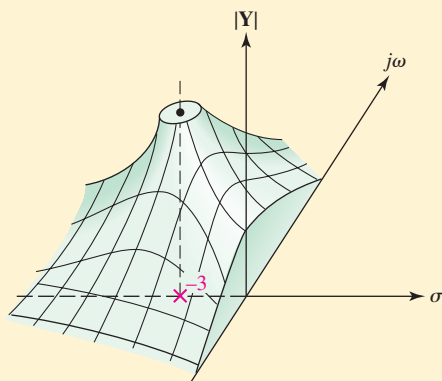

(a)

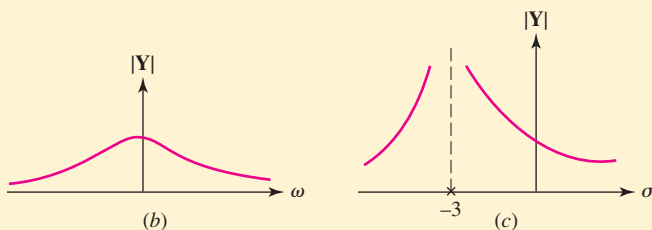

(b)

(c)

■ FIGURE 15.30 (a) A cutaway view of a clay model whose top surface represents  $|\mathbf{Y}(s)|$  for the series combination of a 1 H inductor and a 3  $\Omega$  resistor. (b)  $|\mathbf{Y}(s)|$  as a function of  $\omega$ . (c)  $|\mathbf{Y}(s)|$  as a function of  $\sigma$ .

Once the model is constructed, it is simple to visualize the variation of  $|\mathbf{Y}|$  as a function of  $\omega$  (with  $\sigma = 0$ ) by cutting the model with a perpendicular plane containing the  $j\omega$  axis. The model shown in Fig. 15.30a happens to be cut along this plane, and the desired plot of  $|\mathbf{Y}|$  versus  $\omega$  can be seen; the curve is also drawn in Fig. 15.30b. In a similar manner, a vertical plane containing the  $\sigma$  axis enables us to obtain  $|\mathbf{Y}|$  versus  $\sigma$  (with  $\omega = 0$ ), as shown in Fig. 15.30c.

## PRACTICE

15.12 Sketch the magnitude of the impedance  $\mathbf{Z}(s) = 2 + 5s$  as a function of  $\sigma$  and  $j\omega$ .

Ans: See Fig. 15.31.

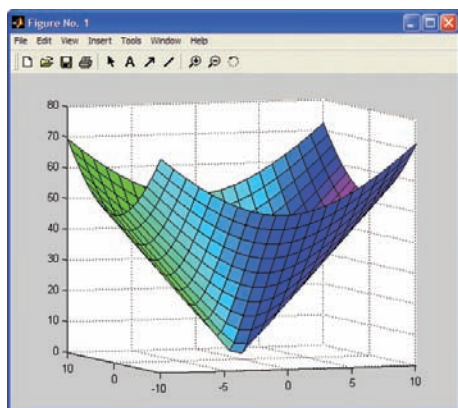

■ FIGURE 15.31 Solution for Practice Problem 15.12, generated with the following code:

```
EDU> sigma = linspace(-10,10,21);
EDU> omega = linspace(-10,10,21);
EDU> [X, Y] = meshgrid(sigma,omega);
EDU> Z = abs(2 + 5*X + j*5*Y);
EDU> colormap(hsv);
EDU> s = [-5 3 8];
EDU> surf1(X,Y,Z,s);
EDU> view(-20,5)
```

## Pole-Zero Constellations

This approach works well for relatively simple functions, but a more practical method is needed in general. Let us visualize the  $s$  plane once again as

the floor and then imagine a large elastic sheet laid on it. We now fix our attention on all the poles and zeros of the response. At each zero, the response is zero, the height of the sheet must be zero, and we therefore tack the sheet to the floor. At the value of  $s$  corresponding to each pole, we may prop up the sheet with a thin vertical rod. Zeros and poles at infinity must be treated by using a large-radius clamping ring or a high circular fence, respectively. If we have used an infinitely large, weightless, perfectly elastic sheet, tacked down with vanishingly small tacks, and propped up with infinitely long, zero-diameter rods, then the elastic sheet assumes a height that is exactly proportional to the magnitude of the response.

These comments may be illustrated by considering the configuration of the poles and zeros, sometimes called a *pole-zero constellation*, that locates all the critical frequencies of a frequency-domain quantity, for example, an impedance  $\mathbf{Z}(s)$ . A pole-zero constellation for an example impedance is shown in Fig. 15.32; in such a diagram, poles are denoted by crosses and zeros by circles. If we visualize an elastic-sheet model, tacked down at  $s = -2 + j0$  and propped up at  $s = -1 + j5$  and at  $s = -1 - j5$ , we should see a terrain whose distinguishing features are two mountains and one conical crater or depression. The portion of the model for the upper LHP is shown in Fig. 15.32*b*.

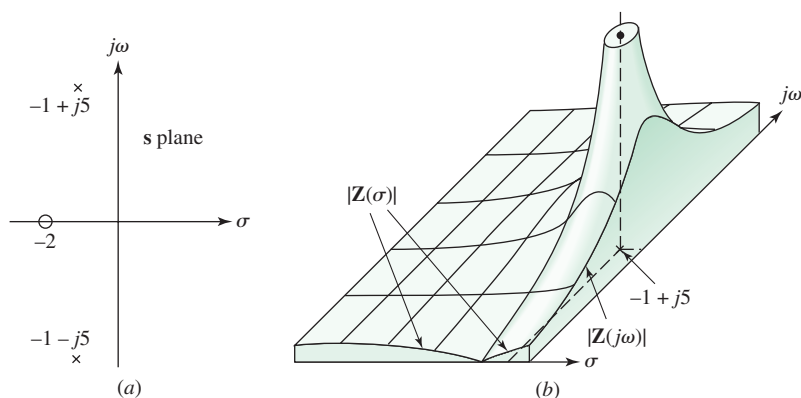

■ FIGURE 15.32 (a) The pole-zero constellation of some impedance  $\mathbf{Z}(s)$ . (b) A portion of the elastic-sheet model of the magnitude of  $\mathbf{Z}(s)$ .

Let us now build up the expression for  $\mathbf{Z}(s)$  that leads to this pole-zero configuration. The zero requires a factor of  $(s + 2)$  in the numerator, and the two poles require the factors  $(s + 1 - j5)$  and  $(s + 1 + j5)$  in the denominator. Except for a multiplying constant  $k$ , we now know the form of  $\mathbf{Z}(s)$ :

$$\mathbf{Z}(s) = k \frac{s + 2}{(s + 1 - j5)(s + 1 + j5)}$$

or

$$\mathbf{Z}(s) = k \frac{s + 2}{s^2 + 2s + 26} \quad [14]$$

In order to determine  $k$ , we require a value for  $\mathbf{Z}(s)$  at some  $s$  other than a critical frequency. For this function, let us suppose we are told  $\mathbf{Z}(0) = 1$ .

By direct substitution in Eq. [14], we find that  $k$  is 13, and therefore

$$\mathbf{Z}(s) = 13 \frac{s + 2}{s^2 + 2s + 26} \quad [15]$$

The plots  $|\mathbf{Z}(\sigma)|$  versus  $\sigma$  and  $|\mathbf{Z}(j\omega)|$  versus  $\omega$  may be obtained exactly from Eq. [15], but the general form of the function is apparent from the pole-zero configuration and the elastic-sheet analogy. Portions of these two curves appear at the sides of the model shown in Fig. 15.32*b*.

### PRACTICE

15.13 The parallel combination of 0.25 mH and 5  $\Omega$  is in series with the parallel combination of 40  $\mu$ F and 5  $\Omega$ . (a) Find  $\mathbf{Z}_{in}(s)$ , the input impedance of the series combination. (b) Specify all the zeros of  $\mathbf{Z}_{in}(s)$ . (c) Specify all the poles of  $\mathbf{Z}_{in}(s)$ . (d) Draw the pole-zero configuration.

Ans:  $5(s^2 + 10,000s + 10^8)/(s^2 + 25,000s + 10^8) \Omega$ ;  $-5 \pm j8.66$  krad/s;  $-5, -20$  krad/s.

## 15.7 NATURAL RESPONSE AND THE $s$ PLANE

At the beginning of this chapter, we explored how working in the frequency domain through the Laplace transform allows us to consider a broad range of time-varying circuits, discarding integrodifferential equations and working algebraically instead. This approach is very powerful, but it does suffer from not being a very visual process. In contrast, there is a *tremendous* amount of information contained in the pole-zero plot of a forced response. In this section, we consider how such plots can be used to obtain the *complete* response of a circuit—natural plus forced—provided the initial conditions are known. The advantage of such an approach is a more *intuitive* linkage between the location of the critical frequencies, easily visualized through the pole-zero plot, and the desired response.

Let us introduce the method by considering the simplest example, a series  $RL$  circuit as shown in Fig. 15.33. A general voltage source  $v_s(t)$  causes the current  $i(t)$  to flow after closure of the switch at  $t = 0$ . The complete response  $i(t)$  for  $t > 0$  is composed of a natural response and a forced response:

$$i(t) = i_n(t) + i_f(t)$$

We may find the forced response by working in the frequency domain, assuming, of course, that  $v_s(t)$  has a functional form that we can transform to the frequency domain; if  $v_s(t) = 1/(1 + t^2)$ , for example, we must proceed as best we can from the basic differential equation for the circuit. For the circuit of Fig. 15.33, we have

$$\mathbf{I}_f(s) = \frac{\mathbf{V}_s}{R + sL}$$

or

$$\mathbf{I}_f(s) = \frac{1}{L} \frac{\mathbf{V}_s}{s + R/L} \quad [16]$$

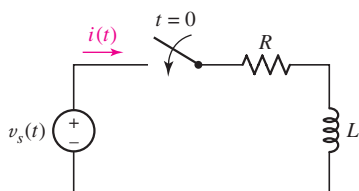

■ FIGURE 15.33 An example that illustrates the determination of the complete response through a knowledge of the critical frequencies of the impedance faced by the source.

Next we consider the natural response. From previous experience, we know that the form will be a decaying exponential with the time constant  $L/R$ , but let's pretend that we are finding it for the first time. The *form* of the natural (source-free) response is, by definition, independent of the forcing function; the forcing function contributes only to the *magnitude* of the natural response. To find the proper form, we turn off all independent sources; here,  $v_s(t)$  is replaced by a short circuit. Next, we try to obtain the natural response as a limiting case of the forced response. Returning to the frequency-domain expression of Eq. [16], we obediently set  $\mathbf{V}_s = 0$ . On the surface, it appears that  $\mathbf{I}(s)$  must also be zero, but this is not necessarily true if we are operating at a complex frequency that is a simple pole of  $\mathbf{I}(s)$ . That is, the denominator and the numerator may *both* be zero so that  $\mathbf{I}(s)$  need not be zero.

Let us inspect this new idea from a slightly different vantage point. We fix our attention on the ratio of the desired forced response to the forcing function. We designate this ratio  $\mathbf{H}(s)$  and define it to be the circuit transfer function. Then,

$$\frac{\mathbf{I}_f(s)}{\mathbf{V}_s} = \mathbf{H}(s) = \frac{1}{L(s + R/L)}$$

In this example, the transfer function is the input admittance faced by  $\mathbf{V}_s$ . We seek the natural (source-free) response by setting  $\mathbf{V}_s = 0$ . However,  $\mathbf{I}_f(s) = \mathbf{V}_s \mathbf{H}(s)$ , and if  $\mathbf{V}_s = 0$ , a nonzero value for the current can be obtained only by operating at a pole of  $\mathbf{H}(s)$ . The poles of the transfer function therefore assume a special significance.

In this particular example, we see that the pole of the transfer function occurs at  $s = -R/L + j0$ , as shown in Fig. 15.34. If we choose to operate at this particular complex frequency, the only *finite* current that could result must be a constant in the  $s$ -domain (i.e., frequency-independent). We thus obtain the natural response

$$\mathbf{I}(s = -\frac{R}{L} + j0) = A$$

where  $A$  is an unknown constant. We next desire to transform this natural response to the time domain. Our knee-jerk reaction might be to attempt to apply inverse Laplace transform techniques in this situation. However, we have already specified a value of  $s$ , so that such an approach is not valid. Instead, we look to the real part of our general function  $e^{st}$ , such that

$$i_n(t) = \text{Re}\{Ae^{st}\} = \text{Re}\{Ae^{-Rt/L}\}$$

In this case we find

$$i_n(t) = Ae^{-Rt/L}$$

so that the total response is then

$$i(t) = Ae^{-Rt/L} + i_f(t)$$

What does it mean to "operate" at a complex frequency? How could we possibly accomplish such a thing in a real laboratory? In this instance, it is important to remember how we invented complex frequency to begin with: it is a means of describing a sinusoidal function of frequency  $\omega$  multiplied by an exponential function  $e^{\sigma t}$ . Such types of signals are very easy to generate with real (i.e., nonimaginary) laboratory equipment. Thus, we need only set the value for  $\sigma$  and the value for  $\omega$  in order to "operate" at  $s = \sigma + j\omega$ .

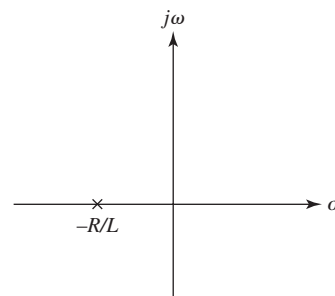

■ FIGURE 15.34 Pole-zero constellation of the transfer function  $\mathbf{H}(s)$  showing the single pole at  $s = -R/L$ .

and  $A$  may be determined once the initial conditions are specified for this circuit. The forced response  $i_f(t)$  is obtained by finding the inverse Laplace transform of  $\mathbf{I}_f(s)$ .

### A More General Perspective

Figure 15.35 shows single sources connected to networks containing no independent sources. The desired response, which might be some current  $\mathbf{I}_1(s)$  or some voltage  $\mathbf{V}_2(s)$ , may be expressed by a transfer function that displays all the critical frequencies. To be specific, we select the response  $\mathbf{V}_2(s)$  in Fig. 15.35a:

$$\frac{\mathbf{V}_2(s)}{\mathbf{V}_s} = \mathbf{H}(s) = k \frac{(s - s_1)(s - s_3) \cdots}{(s - s_2)(s - s_4) \cdots} \quad [17]$$

The poles of  $\mathbf{H}(s)$  occur at  $s = s_2, s_4, \dots$ , and so a finite voltage  $\mathbf{V}_2(s)$  at each of these frequencies must be a possible functional form for the natural response. Thus, we think of a zero-volt source (which is just a short-circuit) applied to the input terminals; the natural response that occurs when the input terminals are short-circuited must therefore have the form

$$v_{2n}(t) = \mathbf{A}_2 e^{s_2 t} + \mathbf{A}_4 e^{s_4 t} + \cdots$$

where each  $\mathbf{A}$  must be evaluated in terms of the initial conditions (including the initial value of any voltage source applied at the input terminals).

To find the form of the natural response  $i_{1n}(t)$  in Fig. 15.35a, we should determine the poles of the transfer function,  $\mathbf{H}(s) = \mathbf{I}_1(s)/\mathbf{V}_s$ . The transfer functions applying to the situations depicted in Fig. 15.35b would be  $\mathbf{I}_1(s)/\mathbf{I}_s$  and  $\mathbf{V}_2(s)/\mathbf{I}_s$ , and their poles then determine the natural responses  $i_{1n}(t)$  and  $v_{2n}(t)$ , respectively.

If the natural response is desired for a network that does not contain any independent sources, then a source  $\mathbf{V}_s$  or  $\mathbf{I}_s$  may be inserted at any convenient point, restricted only by the condition that the original network is obtained when the source is set to zero. The corresponding transfer function is then determined and its poles specify the natural frequencies. Note that the same frequencies must be obtained for any of the many source locations possible. If the network already contains a source, that source may be set equal to zero and another source inserted at a more convenient point.

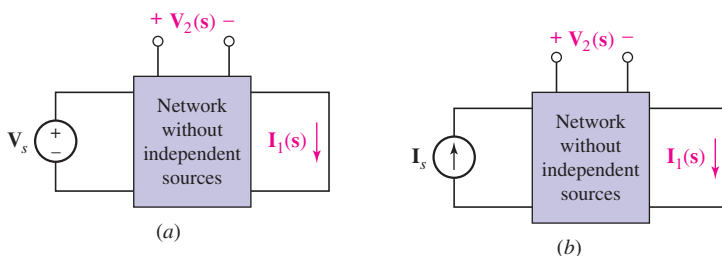

■ FIGURE 15.35 The poles of the response,  $\mathbf{I}_1(s)$  or  $\mathbf{V}_2(s)$ , produced by (a) a voltage source  $\mathbf{V}_s$  or (b) a current source  $\mathbf{I}_s$ . The poles determine the form of the natural response,  $i_{1n}(t)$  or  $v_{2n}(t)$ , that occurs when  $\mathbf{V}_s$  is replaced by a short circuit or  $\mathbf{I}_s$  by an open circuit and some initial energy is available.

## A Special Case

Before we illustrate this method with an example, completeness requires us to acknowledge a special case that might arise. This occurs when the network in Fig. 15.35a or b contains two or more parts that are isolated from each other. For example, we might have the parallel combination of three networks:  $R_1$  in series with  $C$ ,  $R_2$  in series with  $L$ , and a short circuit. Clearly, a voltage source in series with  $R_1$  and  $C$  cannot produce any current in  $R_2$  and  $L$ ; that transfer function would be zero. To find the form of the natural response of the inductor voltage, for example, the voltage source must be installed in the  $R_2L$  network. A case of this type can often be recognized by an inspection of the network before a source is installed; but if it is not, then a transfer function equal to zero will be obtained. When  $\mathbf{H}(s) = 0$ , we obtain no information about the frequencies characterizing the natural response, and a more suitable location for the source must be used.



### EXAMPLE 15.12

For the source-free circuit of Fig. 15.36, determine expressions for  $i_1$  and  $i_2$  for  $t > 0$ , given the initial conditions  $i_1(0) = i_2(0) = 11$  A.

Let us install a voltage source  $\mathbf{V}_s$  between points  $x$  and  $y$  and find the transfer function  $\mathbf{H}(s) = \mathbf{I}_1(s)/\mathbf{V}_s$ , which also happens to be the input admittance seen by the voltage source. We have

$$\mathbf{I}_1(s) = \frac{\mathbf{V}_s}{2s + 1 + 6s/(3s + 2)} = \frac{(3s + 2)\mathbf{V}_s}{6s^2 + 13s + 2}$$

or

$$\mathbf{H}(s) = \frac{\mathbf{I}_1(s)}{\mathbf{V}_s} = \frac{\frac{1}{2}(s + \frac{2}{3})}{(s + 2)(s + \frac{1}{6})}$$

From recent experience, we know at a glance that  $i_1$  must be of the form

$$i_1(t) = Ae^{-2t} + Be^{-t/6}$$

The solution is completed by using the given initial conditions to establish the values of  $A$  and  $B$ . Since  $i_1(0)$  is given as 11 amperes,

$$11 = A + B$$

The necessary additional equation is obtained by writing the KVL equation around the perimeter of our circuit:

$$1i_1 + 2 \frac{di_1}{dt} + 2i_2 = 0$$

and solving for the derivative:

$$\left. \frac{di_1}{dt} \right|_{t=0} = -\frac{1}{2}[2i_2(0) + 1i_1(0)] = -\frac{22 + 11}{2} = -2A - \frac{1}{6}B$$

(Continued on next page)

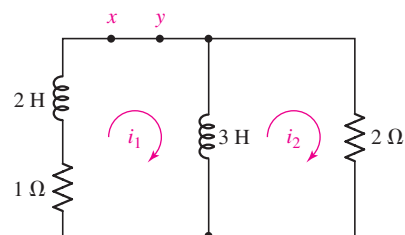

FIGURE 15.36 A circuit for which the natural responses  $i_1$  and  $i_2$  are desired.

Thus,  $A = 8$  and  $B = 3$ , and so the desired solution is

$$i_1(t) = 8e^{-2t} + 3e^{-t/6} \quad \text{amperes}$$

The natural frequencies constituting  $i_2$  are the same as those of  $i_1$ , and a similar procedure used to evaluate the arbitrary constants leads to

$$i_2(t) = 12e^{-2t} - e^{-t/6} \quad \text{amperes}$$

### PRACTICE

15.16 If a current source  $i_1(t) = u(t)$  A is present at  $a$ - $b$  in Fig. 15.37 with the arrow entering  $a$ , find  $\mathbf{H}(s) = \mathbf{V}_{cd}/\mathbf{I}_1$ , and specify the natural frequencies present in  $v_{cd}(t)$ .

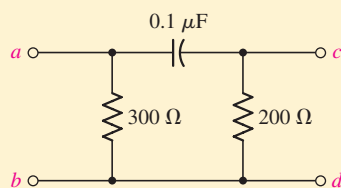

FIGURE 15.37

Ans:  $120s/(s + 20,000) \Omega, -20,000 \text{ s}^{-1}$ .

The process that we must pursue to evaluate the amplitude coefficients of the natural response is a detailed one, except in those cases where the initial values of the desired response and its derivatives are obvious. However, we should not lose sight of the ease and rapidity with which the *form* of the natural response can be obtained.

## 15.8 A TECHNIQUE FOR SYNTHESIZING THE VOLTAGE RATIO $\mathbf{H}(s) = \mathbf{V}_{\text{out}}/\mathbf{V}_{\text{in}}$

Much of the discussion in this chapter has been related to the poles and zeros of a transfer function. We have located them on the complex-frequency plane, we have used them to express transfer functions as ratios of factors or polynomials in  $s$ , we have calculated forced responses from them, and in Sec. 15.7 we have used their poles to establish the form of the natural response.

Now let us see how we might determine a network that can provide a desired transfer function. We consider only a small part of the general problem, working with a transfer function of the form  $\mathbf{H}(s) = \mathbf{V}_{\text{out}}(s)/\mathbf{V}_{\text{in}}(s)$ , as indicated in Fig. 15.41. For simplicity, we restrict  $\mathbf{H}(s)$  to critical frequencies on the negative  $\sigma$  axis (including the origin). Thus, we will consider transfer functions such as

$$\mathbf{H}_1(s) = \frac{10(s + 2)}{s + 5}$$



# PRACTICAL APPLICATION

## Design of Oscillator Circuits

At several points throughout this book, we have investigated the behavior of various circuits responding to sinusoidal excitation. The creation of sinusoidal waveforms, however, is an interesting topic in itself. Generation of large sinusoidal voltages and currents is straightforward using magnets and rotating coils of wire, for example, but such an approach is not easily scaled down for creation of small signals. Instead, low-current applications typically make use of what is known as an *oscillator*, which exploits the concept of *positive feedback* using an appropriate amplifier circuit. Oscillator circuits are an integral component of many consumer products, such as the global positioning satellite (GPS) receiver of Fig. 15.38.



■ FIGURE 15.38 Many consumer electronic products, such as this GPS receiver, rely on oscillator circuits to provide a reference frequency.  
© Nick Koudis/Photodisc/Getty Images/RF.

One straightforward but useful oscillator circuit is known as the *Wien-bridge oscillator*, shown in Fig. 15.39.

The circuit resembles a noninverting op amp circuit, with a resistor  $R_1$  connected between the inverting input pin and ground, and a resistor  $R_f$  connected between the output and the inverting input pin. The resistor  $R_f$  supplies what is referred to as a *negative feedback path*, since it connects the output of the amplifier to the inverting input. Any increase  $\Delta V_o$  in the output then leads to a reduction of the input, which in turn leads to a smaller output; this process increases the stability of the output voltage  $V_o$ . The *gain* of the op amp, defined as the ratio of  $V_o$  to  $V_i$ , is determined by the relative sizes of  $R_1$  and  $R_f$ .

The *positive* feedback loop consists of two separate resistor-capacitor combinations, defined as  $Z_s =$

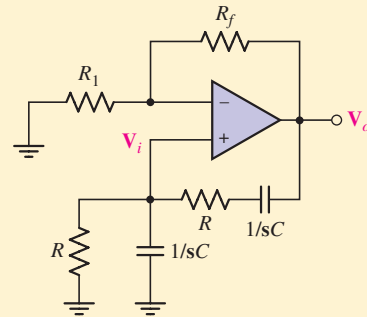

■ FIGURE 15.39 A Wien-bridge oscillator circuit.

$R + 1/sC$  and  $Z_p = R \parallel (1/sC)$ . The values we choose for  $R$  and  $C$  allow us to design an oscillator having a specific frequency (*the internal capacitances of the op amp itself will limit the maximum frequency that can be obtained*). In order to determine the relationship between  $R$ ,  $C$ , and the oscillation frequency, we seek an expression for the amplifier gain,  $V_o/V_i$ .

Recalling the two ideal op amp rules as discussed in Chap. 6 and examining the circuit in Fig. 15.39 closely, we recognize that  $Z_p$  and  $Z_s$  form a voltage divider such that

$$V_i = V_o \frac{Z_p}{Z_p + Z_s} \quad [18]$$

Simplifying the expressions for  $Z_p = R \parallel (1/sC) = R/(1 + sRC)$ , and  $Z_s = R + 1/sC = (1 + sRC)/sC$ , we find that

$$\begin{aligned} \frac{V_i}{V_o} &= \frac{\frac{R}{1 + sRC}}{\frac{1 + sRC}{sC} + \frac{R}{1 + sRC}} \\ &= \frac{sRC}{1 + 3sRC + s^2R^2C^2} \end{aligned} \quad [19]$$

Since we are interested in the sinusoidal steady-state operation of the amplifier, we replace  $s$  with  $j\omega$ , so that

$$\begin{aligned} \frac{V_i}{V_o} &= \frac{j\omega RC}{1 + 3j\omega RC + (j\omega)^2 R^2 C^2} \\ &= \frac{j\omega RC}{1 - \omega^2 R^2 C^2 + 3j\omega RC} \end{aligned} \quad [20]$$

This expression for the gain is real only when  $\omega = 1/RC$ . Thus, we can design an amplifier to operate at a particular frequency  $f = \omega/2\pi = 1/2\pi RC$  by selecting values for  $R$  and  $C$ .

(Continued on next page)

As an example, let's design a Wien-bridge oscillator to generate a sinusoidal signal at a frequency of 20 Hz, the commonly accepted lower frequency of the audio range. We require a frequency  $\omega = 2\pi f = (6.28)(20) = 125.6$  rad/s. Once we specify a value for  $R$ , the necessary value for  $C$  is known (and vice versa). Assuming that we happen to have a  $1 \mu\text{F}$  capacitor handy, we thus compute a required resistance of  $R = 7962 \Omega$ . Since this is not a standard resistor value, we will likely have to use several resistors in series and/or parallel combinations to obtain the necessary value. Referring to Fig. 15.39 in preparation for simulating the circuit using PSpice, however, we notice that no values for  $R_f$  or  $R_1$  have been specified.

Although Eq. [18] correctly specifies the relationship between  $V_o$  and  $V_i$ , we may also write another equation relating these quantities:

$$0 = \frac{V_i}{R_1} + \frac{V_i - V_o}{R_f}$$

which can be rearranged to obtain

$$\frac{V_o}{V_i} = 1 + \frac{R_f}{R_1} \quad [21]$$

Setting  $\omega = 1/RC$  in Eq. [20] results in

$$\frac{V_i}{V_o} = \frac{1}{3}$$

Therefore, we need to select values of  $R_1$  and  $R_f$  such that  $R_f/R_1 = 2$ . Unfortunately, if we proceed to perform

a transient PSpice analysis on the circuit selecting  $R_f = 2 \text{ k}\Omega$  and  $R_1 = 1 \text{ k}\Omega$ , for example, we will likely be disappointed in the outcome. In order to ensure that the circuit is indeed unstable (*a necessary condition for oscillations to begin*), it is necessary to have  $R_f/R_1$  slightly greater than 2. The simulated output of our final design ( $R = 7962 \Omega$ ,  $C = 1 \mu\text{F}$ ,  $R_f = 2.01 \text{ k}\Omega$ , and  $R_1 = 1 \text{ k}\Omega$ ) is shown in Fig. 15.40. Note that the magnitude of the oscillations is increasing in the plot; in practice, nonlinear circuit elements are required to stabilize the voltage magnitude of the oscillator circuit.

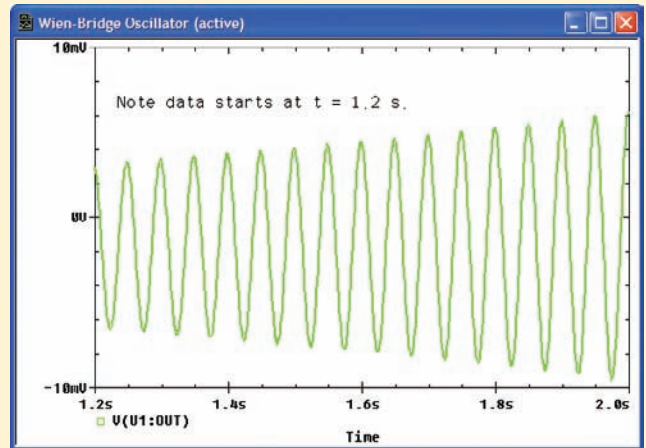

■ FIGURE 15.40 Simulated output of the Wien-bridge oscillator designed for operation at 20 Hz.

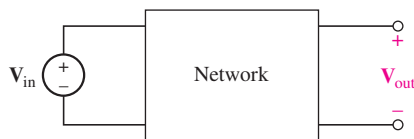

■ FIGURE 15.41 Given  $H(s) = V_{\text{out}}/V_{\text{in}}$ , we seek a network having a specified  $H(s)$ .

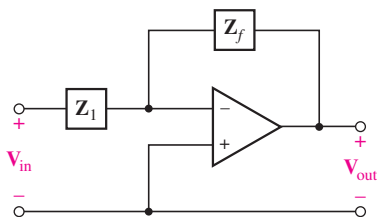

■ FIGURE 15.42 For an ideal op amp,  $H(s) = V_{\text{out}}/V_{\text{in}} = -Z_f/Z_1$ .

or

$$H_2(s) = \frac{-5s}{(s+8)^2}$$

or

$$H_3(s) = 0.1s(s+2)$$

Let us begin by finding the voltage gain of the network of Fig. 15.42, which contains an ideal op amp. The voltage between the two input terminals of the op amp is essentially zero, and the input impedance of the op amp is essentially infinite. We therefore may set the sum of the currents entering the inverting input terminal equal to zero:

$$\frac{V_{\text{in}}}{Z_1} + \frac{V_{\text{out}}}{Z_f} = 0$$

or

$$\frac{V_{\text{out}}}{V_{\text{in}}} = -\frac{Z_f}{Z_1}$$

If  $\mathbf{Z}_f$  and  $\mathbf{Z}_1$  are both resistances, the circuit acts as an inverting amplifier, or possibly an *attenuator* (if the ratio is less than unity). Our present interest, however, lies with those cases in which one of these impedances is a resistance while the other is an  $RC$  network.

In Fig. 15.43a, we let  $\mathbf{Z}_1 = R_1$ , while  $\mathbf{Z}_f$  is the parallel combination of  $R_f$  and  $C_f$ . Therefore,

$$\mathbf{Z}_f = \frac{R_f/sC_f}{R_f + (1/sC_f)} = \frac{R_f}{1 + sC_f R_f} = \frac{1/C_f}{s + (1/R_f C_f)}$$

and

$$\mathbf{H}(s) = \frac{\mathbf{V}_{out}}{\mathbf{V}_{in}} = -\frac{\mathbf{Z}_f}{\mathbf{Z}_1} = -\frac{1/R_f C_f}{s + (1/R_f C_f)}$$

We have a transfer function with a single (finite) critical frequency, a pole at  $s = -1/R_f C_f$ .

Moving on to Fig. 15.43b, we now let  $\mathbf{Z}_f$  be resistive while  $\mathbf{Z}_1$  is an  $RC$  parallel combination:

$$\mathbf{Z}_1 = \frac{1/C_1}{s + (1/R_1 C_1)}$$

and

$$\mathbf{H}(s) = \frac{\mathbf{V}_{out}}{\mathbf{V}_{in}} = -\frac{\mathbf{Z}_f}{\mathbf{Z}_1} = -R_f C_1 \left( s + \frac{1}{R_1 C_1} \right)$$

The only finite critical frequency is a zero at  $s = -1/R_1 C_1$ .

For our ideal op amps, the output or Thévenin impedance is zero and therefore  $\mathbf{V}_{out}$  and  $\mathbf{V}_{out}/\mathbf{V}_{in}$  are not functions of any load  $\mathbf{Z}_L$  that may be placed across the output terminals. This includes the input to another op amp as well, and therefore we may connect circuits having poles and zeros at specified locations in *cascade*, where the output of one op amp is connected directly to the input of the next, and thus generates any desired transfer function.

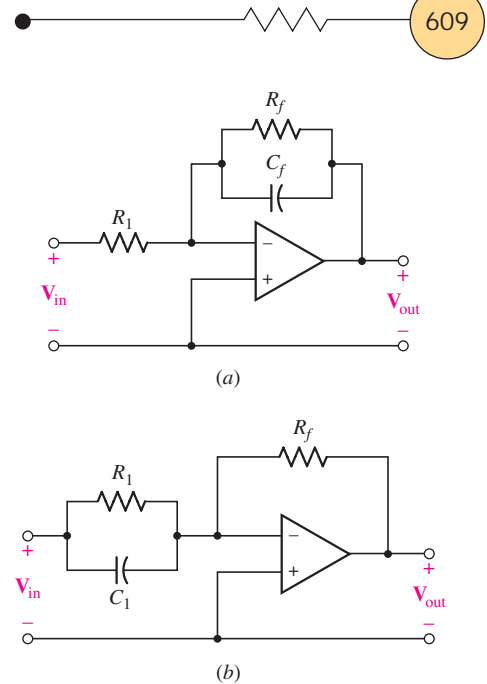

FIGURE 15.43 (a) The transfer function  $\mathbf{H}(s) = \mathbf{V}_{out}/\mathbf{V}_{in}$  has a pole at  $s = -1/R_f C_f$ . (b) Here, there is a zero at  $s = -1/R_1 C_1$ .

## EXAMPLE 15.13

### Synthesize a circuit that will yield the transfer function

$$\mathbf{H}(s) = \mathbf{V}_{out}/\mathbf{V}_{in} = 10(s + 2)/(s + 5).$$

The pole at  $s = -5$  may be obtained by a network of the form of Fig. 15.43a. Calling this network  $A$ , we have  $1/R_{fA}C_{fA} = 5$ . We arbitrarily select  $R_{fA} = 100 \text{ k}\Omega$ ; therefore,  $C_{fA} = 2 \text{ }\mu\text{F}$ . For this portion of the complete circuit,

$$\mathbf{H}_A(s) = -\frac{1/R_{1A}C_{fA}}{s + (1/R_{fA}C_{fA})} = -\frac{5 \times 10^5/R_{1A}}{s + 5}$$

Next, we consider the zero at  $s = -2$ . From Fig. 15.43b,  $1/R_{1B}C_{1B} = 2$ , and, with  $R_{1B} = 100 \text{ k}\Omega$ , we have  $C_{1B} = 5 \text{ }\mu\text{F}$ . Thus

$$\begin{aligned} \mathbf{H}_B(s) &= -R_{fB}C_{1B} \left( s + \frac{1}{R_{1B}C_{1B}} \right) \\ &= -5 \times 10^{-6} R_{fB}(s + 2) \end{aligned}$$

(Continued on next page)

and

$$\mathbf{H}(s) = \mathbf{H}_A(s)\mathbf{H}_B(s) = 2.5 \frac{R_{fB}}{R_{1A}} \frac{s + 2}{s + 5}$$

We complete the design by letting  $R_{fB} = 100 \text{ k}\Omega$  and  $R_{1A} = 25 \text{ k}\Omega$ . The result is shown in Fig. 15.44. The capacitors in this circuit are fairly large, but this is a direct consequence of the low frequencies selected for the pole and zero of  $\mathbf{H}(s)$ . If  $\mathbf{H}(s)$  were changed to  $10(s + 2000)/(s + 5000)$ , we could use 2 and 5 nF values.

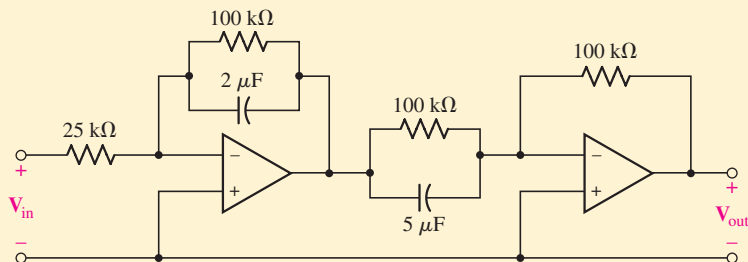

■ FIGURE 15.44 This network contains two ideal op amps and gives the voltage transfer function  $\mathbf{H}(s) = V_{\text{out}}/V_{\text{in}} = 10(s + 2)/(s + 5)$ .

### PRACTICE

15.17 Specify suitable element values for  $\mathbf{Z}_1$  and  $\mathbf{Z}_f$  in each of three cascaded stages to realize the transfer function  $\mathbf{H}(s) = -20s^2/(s + 1000)$ .

Ans:  $1 \mu\text{F} \parallel \infty, 1 \text{ M}\Omega; 1 \mu\text{F} \parallel \infty, 1 \text{ M}\Omega; 100 \text{ k}\Omega \parallel 10 \text{ nF}, 5 \text{ M}\Omega$ .

## SUMMARY AND REVIEW

After having been exposed to the concept of complex frequency in Chap. 14, we applied that concept to circuit analysis in this chapter. The first topic was impedance—perhaps familiar to those who have already read Chap. 10. The concept of impedance (or admittance) allows us to directly construct s-domain equations which describe nodal voltages, mesh currents, etc., without having to rely on taking the Laplace transform of each term of an integrodifferential equation. Somewhat surprisingly, we found that the impedance of inductors and capacitors includes the initial condition of that element. From that point forward, all of our familiar circuit analysis techniques apply. The only difficulty encountered is in factoring higher-order polynomials in order to perform an inverse transform. We also introduced the notion of a system transfer function, which allows the input to a network to be changed easily, and the new output predicted. Working in the s-domain proved very natural here, and we saw that convolution of two time-domain functions is easily performed by multiplying their s-domain equivalents.

The third major topic of the chapter was the complex-frequency plane, which allows us to create a graphical representation of any  $s$ -domain expression. In particular, it provides a tidy means for readily identifying poles and zeros. Since the sources connected to a circuit only determine the magnitude of the transient response, and not the form of the transient response itself, we found that  $s$ -domain analysis can reveal details about the natural as well as forced response of a network. We concluded the chapter with a description of how op amps can be employed to synthesize a desired transfer function, placing poles and zeros where they are needed through cascaded stages.

This topic will be revisited in future studies of signal analysis, and the concept of convolution in particular is applicable to a broad range of applications. At this stage, however, perhaps we should pause and allow the reader to focus on key issues and identify relevant examples as a start to reviewing what we have discussed.

- Resistors may be represented in the frequency domain by an impedance having the same magnitude. (Example 15.1)
- Inductors may be represented in the frequency domain by an impedance  $sL$ . If the initial current is nonzero, then the impedance must be placed in series with a voltage source  $-Li(0^-)$  or in parallel with a current source  $i(0^-)/s$ . (Example 15.1)
- Capacitors may be represented in the frequency domain by an impedance  $1/sC$ . If the initial voltage is nonzero, then the impedance must be placed in series with a voltage source  $v(0^-)/s$  or in parallel with a current source  $Cv(0^-)$ . (Example 15.2)
- Nodal and mesh analysis in the  $s$ -domain lead to simultaneous equations in terms of  $s$ -polynomials. MATLAB is a particularly useful tool for solving such systems of equations. (Examples 15.3, 15.4, 15.5)
- Superposition, source transformation, and the Thévenin and Norton theorems all apply in the  $s$ -domain. (Examples 15.6, 15.7)
- A circuit transfer function  $\mathbf{H}(s)$  is defined as the ratio of the  $s$ -domain output to the  $s$ -domain input. Either quantity may be a voltage or current. (Example 15.8)
- The *zeros* of  $\mathbf{H}(s)$  are those values that result in zero magnitude. The *poles* of  $\mathbf{H}(s)$  are those values that result in infinite magnitude.
- Convolution provides us with both an analytic and a graphical means of determining the output of a circuit from its impulse response  $h(t)$ . (Examples 15.8, 15.9, 15.10)
- There are several graphical approaches to representing  $s$ -domain expressions in terms of poles and zeros. Such plots can be used to synthesize a circuit to obtain a desired response. (Example 15.11)
- A source-free circuit can be analyzed using  $s$ -domain techniques to determine its transient response.
- Single op amp stages can be used to synthesize transfer functions having either a zero or a pole. More complex functions can be synthesized by cascading multiple stages.

These models are summarized in Table 15.1.

## READING FURTHER

More details regarding s-domain analysis of systems, use of Laplace transforms, and properties of transfer functions can be found in:

K. Ogata, *Modern Control Engineering*, 4th ed. Englewood Cliffs, N.J.: Prentice-Hall, 2002.

A good discussion of various types of oscillator circuits can be found in:

R. Mancini, *Op Amps for Everyone*, 2nd ed. Amsterdam: Newnes, 2003.

and

G. Clayton and S. Winder, *Operational Amplifiers*, 5th ed. Amsterdam: Newnes, 2003.

## EXERCISES

### 15.1 Z(s) and Y(s)

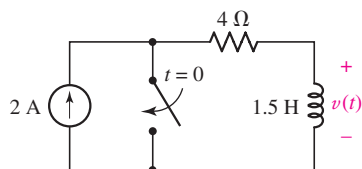

■ FIGURE 15.45

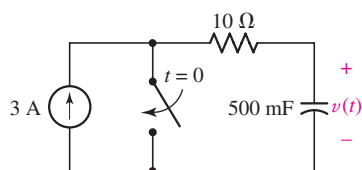

■ FIGURE 15.46

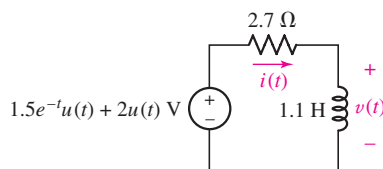

■ FIGURE 15.47

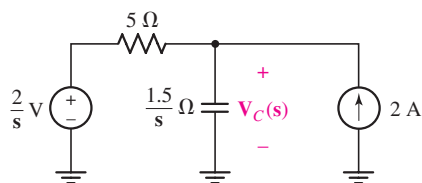

■ FIGURE 15.48

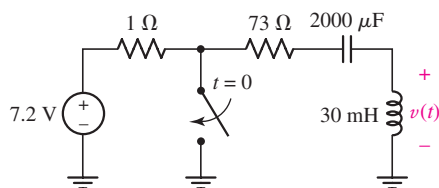

■ FIGURE 15.49

1. Draw an s-domain equivalent of the circuit depicted in Fig. 15.45, if the only quantity of interest is  $v(t)$ . (*Hint*: omit the source, but don't ignore it.)
2. For the circuit of Fig. 15.46, the only quantity of interest is the voltage  $v(t)$ . Draw an appropriate s-domain equivalent circuit. (*Hint*: omit the source, but don't ignore it.)
3. For the circuit represented in Fig. 15.47, draw an s-domain equivalent and analyze it to obtain a value for  $i(t)$  if  $i(0)$  is equal to (a) 0; (b)  $-2$  A.
4. For the circuit of Fig. 15.47, draw an s-domain equivalent and analyze it to obtain a value for  $v(t)$  if  $i(0)$  is equal to (a) 0; (b) 3 A.
5. With respect to the s-domain circuit drawn in Fig. 15.48, (a) calculate  $V_C(s)$ ; (b) determine  $v_C(t)$ ,  $t > 0$ ; (c) draw the time-domain representation of the circuit.
6. Draw all possible s-domain equivalents ( $t > 0$ ) of the circuit shown in Fig. 15.49.
7. Determine the input impedance  $Z_{in}(s)$  seen looking into the terminals of the network depicted in Fig. 15.50. Express your answer as a ratio of two s-polynomials.

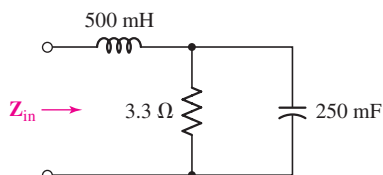

■ FIGURE 15.50

8. With respect to the network of Fig. 15.51, obtain an expression for the input admittance  $Y(s)$  as labeled. Express your answer as a ratio of two  $s$ -polynomials.
9. For the circuit of Fig. 15.52, (a) draw both  $s$ -domain equivalent circuits; (b) choose one and solve for  $V(s)$ ; (c) determine  $v(t)$ .

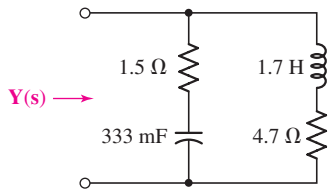

■ FIGURE 15.51

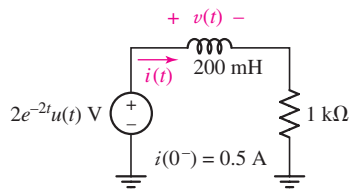

■ FIGURE 15.52

10. Determine the input impedance  $1/Y(s)$  of the network represented in Fig. 15.51 if the  $1.5 \Omega$  resistor is replaced with the parallel combination of a  $100 \text{ mF}$  capacitor and a  $1 \Omega$  resistor, and the initial current through the inductor (defined as flowing downward) is  $540 \text{ mA}$ .

## 15.2 Nodal and Mesh Analysis in the $s$ -Domain

11. For the circuit given in Fig. 15.53, (a) draw the  $s$ -domain equivalent; (b) write the three  $s$ -domain mesh equations; (c) determine  $i_1$ ,  $i_2$ , and  $i_3$ .

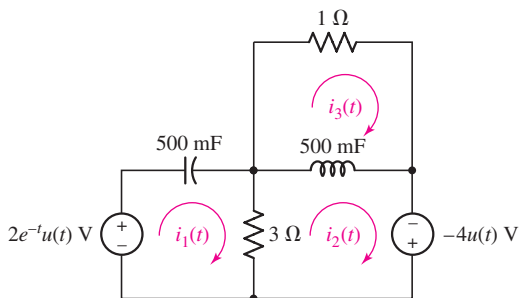

■ FIGURE 15.53

12. Replace the  $-4u(t)$  label in the circuit of Fig. 15.53 with  $4e^{-t}u(t)$  V. Calculate  $i_1$ ,  $i_2$ , and  $i_3$  if it transpires that the initial current through the inductor,  $i_2 - i_3$ , is equal to  $50 \text{ mA}$ .
13. For the circuit shown in Fig. 15.54, (a) write an  $s$ -domain nodal equation for  $V_x(s)$ ; (b) solve for  $v_x(t)$ .

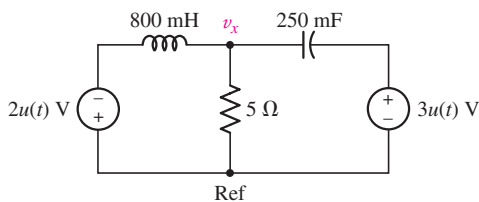

■ FIGURE 15.54

14. Determine  $v_1$  and  $v_2$  for the circuit of Fig. 15.55 using nodal analysis in the  $s$ -domain.

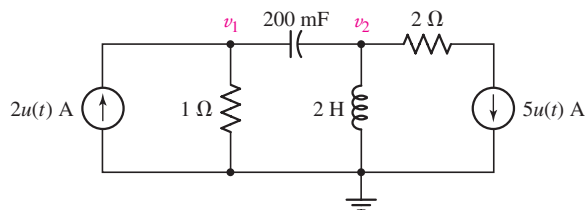

■ FIGURE 15.55

15. The  $2u(t)$  A source in Fig. 15.55 is replaced with a  $4e^{-t}u(t)$  A source. Employ  $s$ -domain analysis to determine the power dissipated by the  $1\ \Omega$  resistor.
16. Calculate the power dissipated in the  $3\ \Omega$  resistor of Fig. 15.56, if  $v_1(0^-) = 2$  V.

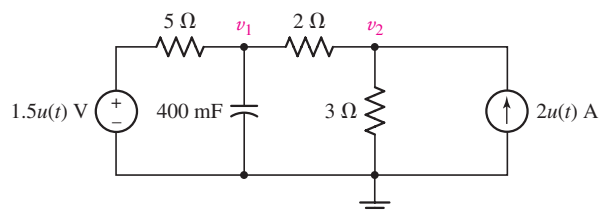

■ FIGURE 15.56

17. For the circuit shown in Fig. 15.57, let  $i_{s1} = 3u(t)$  A and  $i_{s2} = 5 \sin 2t$  A. Working initially in the  $s$ -domain, obtain an expression for  $v_x(t)$ .

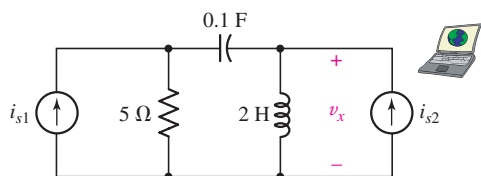

■ FIGURE 15.57

18. For the circuit in Fig. 15.58, (a) draw the corresponding  $s$ -domain circuit; (b) solve for  $v_1(t)$ ,  $v_2(t)$ , and  $v_3(t)$ ; (c) verify your solution with an appropriate PSpice simulation.

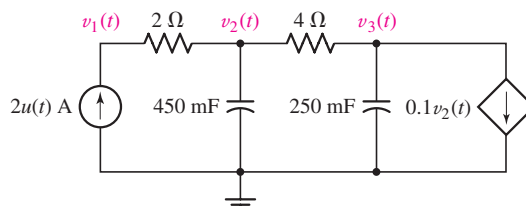

■ FIGURE 15.58

19. Determine the mesh currents  $i_1(t)$  and  $i_2(t)$  in Fig. 15.59 if the current through the  $1\ \text{mH}$  inductor ( $i_2 - i_4$ ) is  $1$  A at  $t = 0^-$ . Verify that your answer approaches the answer obtained using phasor analysis as the circuit response eventually reaches steady state.

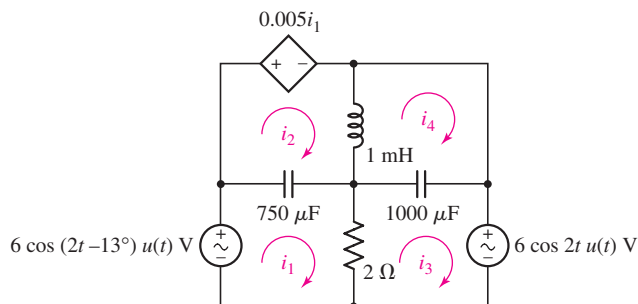

■ FIGURE 15.59



20. Assuming no energy initially stored in the circuit of Fig. 15.60, determine the value of  $v_2$  at  $t$  equal to (a) 1 ms; (b) 100 ms; (c) 10 s.

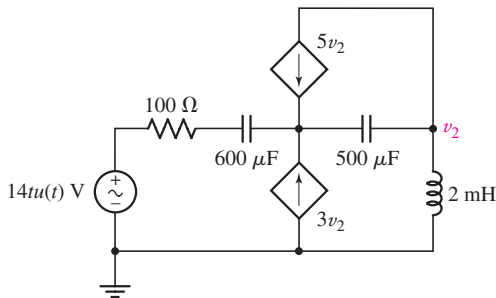

FIGURE 15.60

### 15.3 Additional Circuit Analysis Techniques

21. Using repeated source transformations, obtain an  $s$ -domain expression for the Thévenin equivalent seen by the element labeled  $Z$  in the circuit of Fig. 15.61.

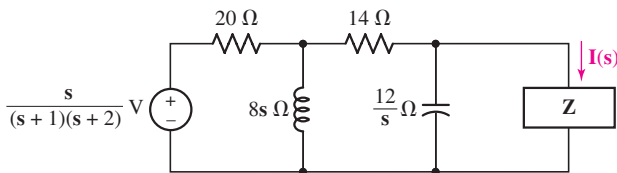

FIGURE 15.61

22. Calculate  $I(s)$  as labeled in the circuit of Fig. 15.61 if the element  $Z$  has impedance of (a)  $2 \Omega$ ; (b)  $\frac{1}{2s} \Omega$ ; (c)  $s + \frac{1}{2s} + 3 \Omega$ .
23. For the circuit shown in Fig. 15.62, determine the  $s$ -domain Thévenin equivalent seen by the (a)  $2 \Omega$  resistor; (b)  $4 \Omega$  resistor; (c)  $1.2 \text{ F}$  capacitor; (d) current source.
24. Calculate both currents labeled in the circuit of Fig. 15.62.
25. For the circuit of Fig. 15.63, take  $i_s(t) = 5u(t) \text{ A}$  and determine (a) the Thévenin equivalent impedance seen by the  $10 \Omega$  resistor; (b) the inductor current  $i_L(t)$ .

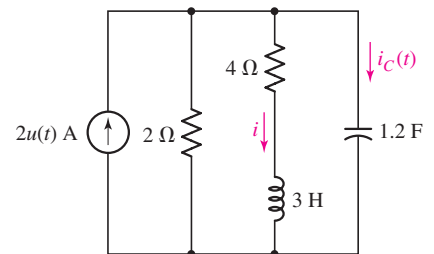

FIGURE 15.62

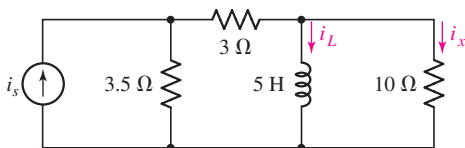

FIGURE 15.63

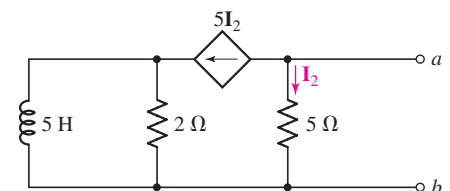
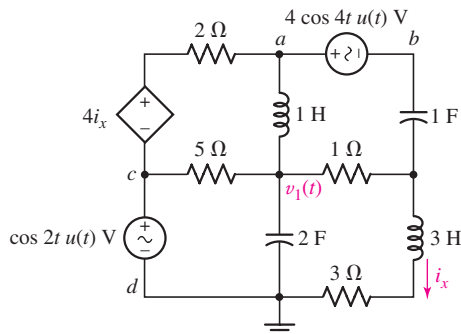

FIGURE 15.64

26. If the current source of Fig. 15.63 is  $1.5e^{-2t}u(t) \text{ A}$ , and  $i_L(0^-) = 1 \text{ A}$ , determine  $i_x(t)$ .
27. For the  $s$ -domain circuit of Fig. 15.64, determine the Thévenin equivalent seen looking into the terminals marked  $a$  and  $b$ .

28. (a) Use superposition in the  $s$ -domain to find an expression for  $\mathbf{V}_1(\mathbf{s})$  as labeled in Fig. 15.65. (b) Find  $v_1(t)$ .



■ FIGURE 15.65

29. If the top right voltage source of Fig. 15.65 is open-circuited, determine the Thévenin equivalent seen looking into the terminals marked  $a$  and  $b$ .
30. If the bottom left voltage source of Fig. 15.65 is open-circuited, determine the Thévenin equivalent seen looking into the terminals marked  $c$  and  $d$ .

#### 15.4 Poles, Zeros, and Transfer Functions

31. Determine the poles and zeros of the following  $s$ -domain functions:

$$(a) \frac{s}{s + 12.5}; (b) \frac{s(s + 1)}{(s + 5)(s + 3)}; (c) \frac{s + 4}{s^2 + 8s + 7}; (d) \frac{s^2 - s - 2}{3s^3 + 24s^2 + 21s}$$

32. Use appropriate means to ascertain the poles and zeros of

$$(a) s + 4; (b) \frac{2s}{s^2 - 8s + 16}; (c) \frac{4}{s^3 + 8s + 7}; (d) \frac{s - 5}{s^3 - 7s + 6}$$

33. Consider the following expressions and determine the critical frequencies of each:

$$(a) 5 + s^{-1}; (b) \frac{s(s + 1)(s + 4)}{(s + 5)(s + 3)^2}; (c) \frac{1}{s^2 + 4}; (d) \frac{0.5s^2 - 18}{s^2 + 1}$$

34. For the network represented schematically in Fig. 15.66, (a) write the transfer function  $\mathbf{H}(\mathbf{s}) \equiv \mathbf{V}_{\text{out}}(\mathbf{s})/\mathbf{V}_{\text{in}}(\mathbf{s})$ ; (b) determine the poles and zeros of  $\mathbf{H}(\mathbf{s})$ .

35. For each of the two networks represented schematically in Fig. 15.67, (a) write the transfer function  $\mathbf{H}(\mathbf{s}) \equiv \mathbf{V}_{\text{out}}(\mathbf{s})/\mathbf{V}_{\text{in}}(\mathbf{s})$ ; (b) determine the poles and zeros of  $\mathbf{H}(\mathbf{s})$ .

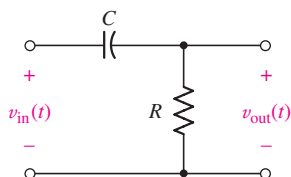

■ FIGURE 15.66

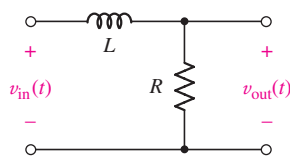

(a)

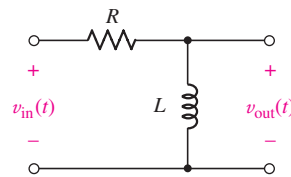

(b)

■ FIGURE 15.67

36. Determine the critical frequencies of  $\mathbf{Z}_{\text{in}}$  as defined in Fig. 15.50.

37. Specify the poles and zeros of  $\mathbf{Y}(\mathbf{s})$  as defined by Fig. 15.51.

38. If a network is found to have the transfer function  $\mathbf{H}(\mathbf{s}) = \frac{s}{s^2 + 8s + 7}$ , determine the  $s$ -domain output voltage for  $v_{\text{in}}(t)$  equal to (a)  $3u(t)$  V; (b)  $25e^{-2t}u(t)$  V; (c)  $4u(t + 1)$  V; (d)  $2 \sin 5t u(t)$  V.

39. A particular network is known to be characterized by the transfer function  $\mathbf{H}(s) = s + 1/(s^2 + 23s + 60)$ . Determine the critical frequencies of the output if the input is (a)  $2u(t) + 4\delta(t)$ ; (b)  $-5e^{-t}u(t)$ ; (c)  $4te^{-2t}u(t)$ ; (d)  $5\sqrt{2}e^{-10t} \cos 5t u(t)$  V.
40. For the network represented in Fig. 15.68, determine the critical frequencies of  $\mathbf{Z}_{in}(s)$ .

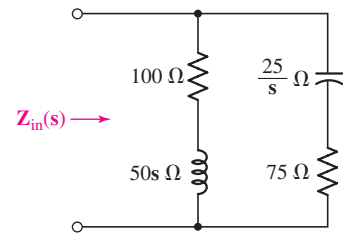

■ FIGURE 15.68

### 15.5 Convolution

41. Referring to Fig. 15.69, employ Eq. [11] to obtain  $x(t) * y(t)$ .

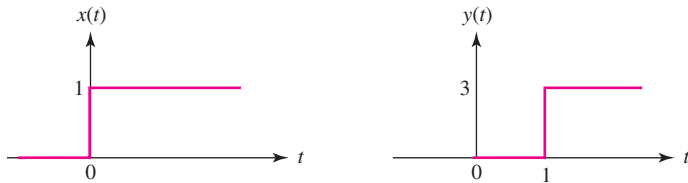

■ FIGURE 15.69

42. With respect to the functions  $x(t)$  and  $y(t)$  as plotted in Fig. 15.69, use Eq. [11] to obtain (a)  $x(t) * x(t)$ ; (b)  $y(t) * \delta(t)$ .
43. Employ graphical convolution techniques to determine  $f * g$  if  $f(t) = 5u(t)$  and  $g(t) = 2u(t) - 2u(t - 2) + 2u(t - 4) - 2u(t - 6)$ .
44. Let  $h(t) = 2e^{-3t}u(t)$  and  $x(t) = u(t) - \delta(t)$ . Find  $y(t) = h(t) * x(t)$  by (a) using convolution in the time domain; (b) finding  $\mathbf{H}(s)$  and  $\mathbf{X}(s)$  and then obtaining  $\mathcal{L}^{-1}\{\mathbf{H}(s)\mathbf{X}(s)\}$ .
45. (a) Determine the impulse response  $h(t)$  of the network shown in Fig. 15.70. (b) Use convolution to determine  $v_o(t)$  if  $v_{in}(t) = 8u(t)$  V.

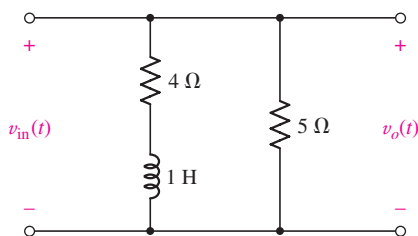

■ FIGURE 15.70

### 15.6 The Complex-Frequency Plane

46. A  $2 \Omega$  resistor is placed in series with a  $250 \text{ mF}$  capacitor. Sketch the magnitude of the equivalent impedance as a function of (a)  $\sigma$ ; (b)  $\omega$ ; (c)  $\sigma$  and  $\omega$ , using an elastic-sheet type approach. (d) Verify your solutions using MATLAB.
47. Sketch the magnitude of  $\mathbf{Z}(s) = s^2 + s$  as a function of (a)  $\sigma$ ; (b)  $\omega$ ; (c)  $\sigma$ , and  $\omega$ , using an elastic-sheet type approach. (d) Verify your solutions using MATLAB.
48. Sketch the pole-zero constellation of each of the following: (a)  $\frac{s(s+4)}{(s+5)(s+2)}$ ; (b)  $\frac{s-1}{s^2+8s+7}$ ; (c)  $\frac{s^2+1}{s(s^2+10s+16)}$ ; (d)  $\frac{5}{s^2+2s+5}$ .
49. The partially labeled pole-zero constellation of a particular transfer function  $\mathbf{H}(s)$  is shown in Fig. 15.71. Obtain an expression for  $\mathbf{H}(s)$  if  $\mathbf{H}(0)$  is equal to (a) 1; (b)  $-5$ . (c) Is the system  $\mathbf{H}(s)$  represents expected to be stable or unstable? Explain.

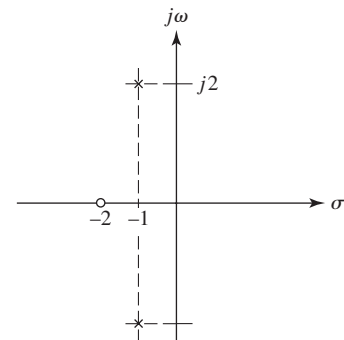

■ FIGURE 15.71

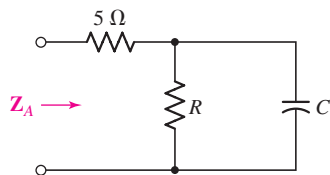

FIGURE 15.72

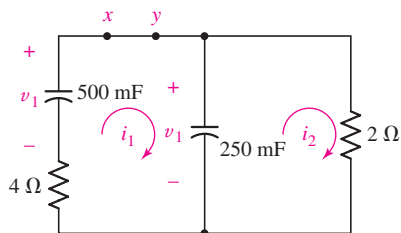

FIGURE 15.73

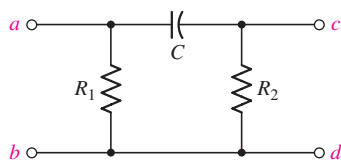

FIGURE 15.74

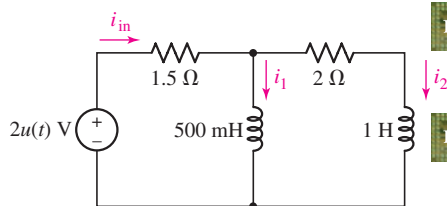

FIGURE 15.75

50. The three-element network shown in Fig. 15.72 has an input impedance  $Z_A(s)$  that has a zero at  $s = -10 + j0$ . If a  $20 \Omega$  resistor is placed in series with the network, the zero of the new impedance shifts to  $s = -3.6 + j0$ . Calculate  $R$  and  $C$ .
51. Let  $\mathbf{H}(s) = 100(s + 2)/(s^2 + 2s + 5)$  and (a) show the pole-zero plot for  $\mathbf{H}(s)$ ; (b) find  $\mathbf{H}(j\omega)$ ; (c) find  $|\mathbf{H}(j\omega)|$ ; (d) sketch  $|\mathbf{H}(j\omega)|$  versus  $\omega$ ; (e) find  $\omega_{\max}$ , the frequency at which  $|\mathbf{H}(j\omega)|$  is a maximum.

### 15.7 Natural Response and the s Plane

52. Determine expressions for  $i_1(t)$  and  $i_2(t)$  for the circuit of Fig. 15.73, assuming  $v_1(0^-) = 2 \text{ V}$  and  $v_2(0^-) = 0 \text{ V}$ .
53. The  $250 \text{ mF}$  capacitor in the circuit of Fig. 15.73 is replaced with a  $2 \text{ H}$  inductor. If  $v_1(t) = 0 \text{ V}$  and  $i_1(0^-) - i_2(0^-) = 1 \text{ A}$ , obtain an expression for  $i_2(t)$ .
54. In the network of Fig. 15.74, a current source  $i_x(t) = 2u(t) \text{ A}$  is connected between terminals  $c$  and  $d$  such that the arrow of the source points upward. Determine the natural frequencies present in the voltage  $v_{ab}(t)$  which results.
55. With regard to the circuit shown in Fig. 15.75, let  $i_1(0^-) = 1 \text{ A}$  and  $i_2(0^-) = 0$ . (a) Determine the poles of  $\mathbf{I}_{\text{in}}(s)/\mathbf{V}_{\text{in}}(s)$ ; (b) use this information to obtain expressions for  $i_1(t)$  and  $i_2(t)$ .

### 15.8 A Technique for Synthesizing the Voltage Ratio $\mathbf{H}(s) = \mathbf{V}_{\text{out}}/\mathbf{V}_{\text{in}}$

- DP 56. Design a circuit which produces the transfer function  $\mathbf{H}(s) = \mathbf{V}_{\text{out}}/\mathbf{V}_{\text{in}}$  equal to (a)  $5(s + 1)$ ; (b)  $\frac{5}{(s + 1)}$ ; (c)  $5\frac{s + 1}{s + 2}$ .
- DP 57. Design a circuit which produces the transfer function  $\mathbf{H}(s) = \mathbf{V}_{\text{out}}/\mathbf{V}_{\text{in}}$  equal to (a)  $2(s + 1)^2$ ; (b)  $\frac{3}{(s + 500)(s + 100)}$ .
- DP 58. Design a circuit which produces the transfer function  $\mathbf{H}(s) = \frac{\mathbf{V}_{\text{out}}}{\mathbf{V}_{\text{in}}} = 5\frac{s + 10^4}{s + 2 \times 10^5}$ .
- DP 59. Design a circuit which produces the transfer function  $\mathbf{H}(s) = \frac{\mathbf{V}_{\text{out}}}{\mathbf{V}_{\text{in}}} = 3\frac{s + 50}{(s + 75)^2}$ .
60. Find  $\mathbf{H}(s) = \mathbf{V}_{\text{out}}/\mathbf{V}_{\text{in}}$  as a ratio of polynomials in  $s$  for the op-amp circuit of Fig. 15.42, given the impedance values (in  $\Omega$ ): (a)  $\mathbf{Z}_1(s) = 10^3 + (10^8/s)$ ,  $\mathbf{Z}_f(s) = 5000$ ; (b)  $\mathbf{Z}_1(s) = 5000$ ,  $\mathbf{Z}_f(s) = 10^3 + (10^8/s)$ ; (c)  $\mathbf{Z}_1(s) = 10^3 + (10^8/s)$ ,  $\mathbf{Z}_f(s) = 10^4 + (10^8/s)$ .

### Chapter-Integrating Exercises

- DP 61. Design a circuit that provides a frequency of  $16 \text{ Hz}$ , which is near the lower end of the human hearing range. Verify your design with an appropriate simulation.
- DP 62. Design a circuit which provides a dual-tone multifrequency (DTMF) signal corresponding to the number 9, which is a voltage output composed of a  $1477 \text{ Hz}$  signal and an  $852 \text{ Hz}$  signal.
- DP 63. (a) Design a circuit which provides a signal at  $261.6 \text{ Hz}$ , which is approximately middle "C". Use only standard 5% tolerance resistance values. (b) Estimate the likely frequency range of your signal generator based on the range of possible resistor values which can be used in construction.
- DP 64. (a) Many people with partial hearing loss, especially the elderly, have difficulty in detecting standard smoke detectors. An alternative is to lower the frequency to approximately  $500 \text{ Hz}$ . Design a circuit which provides such a signal, using only standard 10% tolerance resistor and capacitor values. (b) Estimate the actual frequency range expected from your design if it is manufactured based on the possible range of component values.
- DP 65. Design a circuit which provides either a  $200 \text{ Hz}$  signal or a  $400 \text{ Hz}$  signal by closing appropriate switches.

# Frequency Response

## INTRODUCTION

We have already been introduced to the concept of frequency response, meaning that the behavior of our circuit can change dramatically depending on the frequency (or frequencies) of operation—a radical departure from our first experiences with simple dc circuits. In this chapter we take the topic to a more refined level, as even simple circuits designed for specific frequency response can be enormously useful in a wide variety of everyday applications. In fact, we make use of frequency-selective circuits throughout the day, probably without even realizing it. For example, switching to our favorite radio station is in fact tuning our radio to selectively amplify a narrow band of signal frequencies; heating microwave popcorn is possible while watching television or talking on a cell phone because the frequencies of each device can be isolated from one another. In addition, studying frequency response and filters can be particularly enjoyable as it provides us with a vehicle for pushing past analysis of existing circuits, and enabling the design of complex circuits from scratch to meet sometimes stringent specifications. We'll start this journey with a short discussion of *resonance*, *loss*, *quality factor*, and *bandwidth*—important concepts for filters as well as any circuit (or system, for that matter) containing energy storage elements.

### 16.1 PARALLEL RESONANCE

Suppose that a certain forcing function is found to contain sinusoidal *components* having frequencies within the range of 10 to 100 Hz. Now let us imagine that this forcing function is applied to a network that

## KEY CONCEPTS

Resonant Frequency of Circuits with Inductors and Capacitors

Quality Factor

Bandwidth

Frequency and Magnitude Scaling

Bode Diagram Techniques

Low- and High-Pass Filters

Bandpass Filter Design

Active Filters

Butterworth Filter Design



has the property that all sinusoidal voltages with frequencies from zero to 200 Hz applied at the input terminals appear doubled in magnitude at the output terminals, with no change in phase angle. The output function is therefore an undistorted facsimile of the input function, but with twice the amplitude. If, however, the network has a frequency response such that the magnitudes of input sinusoids between 10 and 50 Hz are multiplied by a different factor than are those between 50 and 100 Hz, then the output would in general be distorted; it would no longer be a magnified version of the input. This distorted output might be desirable in some cases and undesirable in others. That is, the network frequency response might be chosen *deliberately* to reject some frequency components of the forcing function, or to emphasize others.

Such behavior is characteristic of tuned circuits or resonant circuits, as we will see in this chapter. In discussing resonance we will be able to apply all the methods we have discussed in presenting frequency response.

## Resonance

In this section we will begin the study of a very important phenomenon that may occur in circuits that contain both inductors and capacitors. The phenomenon is called *resonance*, and it may be loosely described as the condition existing in any physical system when a fixed-amplitude sinusoidal forcing function produces a response of maximum amplitude. However, we often speak of resonance as occurring even when the forcing function is not sinusoidal. The resonant system may be electrical, mechanical, hydraulic, acoustic, or some other kind, but we will restrict our attention, for the most part, to electrical systems.

Resonance is a familiar phenomenon. Jumping up and down on the bumper of an automobile, for example, can put the vehicle into rather large oscillatory motion if the jumping is done at the proper frequency (about one jump per second), and if the shock absorbers are somewhat decrepit. However, if the jumping frequency is increased or decreased, the vibrational response of the automobile will be considerably less than it was before. A further illustration is furnished in the case of an opera singer who is able to shatter crystal goblets by means of a well-formed note at the proper frequency. In each of these examples, we are thinking of frequency as being adjusted until resonance occurs; it is also possible to adjust the size, shape, and material of the mechanical object being vibrated, but this may not be so easily accomplished physically.

The condition of resonance may or may not be desirable, depending upon the purpose which the physical system is to serve. In the automotive example, a large amplitude of vibration may help to separate locked bumpers, but it would be somewhat disagreeable at 65 mi/h (105 km/h).

Let us now define resonance more carefully. In a two-terminal electrical network containing at least one inductor and one capacitor, we define resonance as the condition which exists when the input impedance of the network is purely resistive. Thus,

a network is in resonance (or resonant) when the voltage and current at the network input terminals are in phase.

We will also find that a maximum-amplitude response is produced in the network when it is in the resonant condition.

We first apply the definition of resonance to a parallel  $RLC$  network driven by a sinusoidal current source as shown in Fig. 16.1. In many practical situations, this circuit is a very good approximation to the circuit we might build in the laboratory by connecting a physical inductor in parallel with a physical capacitor, where the parallel combination is driven by an energy source having a very high output impedance. The steady-state admittance offered to the ideal current source is

$$\mathbf{Y} = \frac{1}{R} + j\left(\omega C - \frac{1}{\omega L}\right) \quad [1]$$

Resonance occurs when the voltage and current at the input terminals are in phase. This corresponds to a purely real admittance, so that the necessary condition is given by

$$\omega C - \frac{1}{\omega L} = 0$$

The resonant condition may be achieved by adjusting  $L$ ,  $C$ , or  $\omega$ ; we will devote our attention to the case for which  $\omega$  is the variable. Hence, the resonant frequency  $\omega_0$  is

$$\omega_0 = \frac{1}{\sqrt{LC}} \quad \text{rad/s} \quad [2]$$

or

$$f_0 = \frac{1}{2\pi\sqrt{LC}} \quad \text{Hz} \quad [3]$$

This resonant frequency  $\omega_0$  is identical to the resonant frequency defined in Eq. [10], Chap. 9.

The pole-zero configuration of the admittance function can also be used to considerable advantage here. Given  $\mathbf{Y}(s)$ ,

$$\mathbf{Y}(s) = \frac{1}{R} + \frac{1}{sL} + sC$$

or

$$\mathbf{Y}(s) = C \frac{s^2 + s/RC + 1/LC}{s} \quad [4]$$

we may display the zeros of  $\mathbf{Y}(s)$  by factoring the numerator:

$$\mathbf{Y}(s) = C \frac{(s + \alpha - j\omega_d)(s + \alpha + j\omega_d)}{s}$$

where  $\alpha$  and  $\omega_d$  represent the same quantities that they did when we discussed the natural response of the parallel  $RLC$  circuit in Sec. 9.4. That is,  $\alpha$  is the *exponential damping coefficient*,

$$\alpha = \frac{1}{2RC}$$

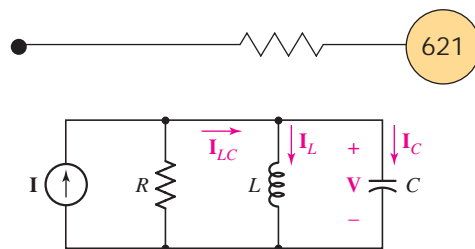
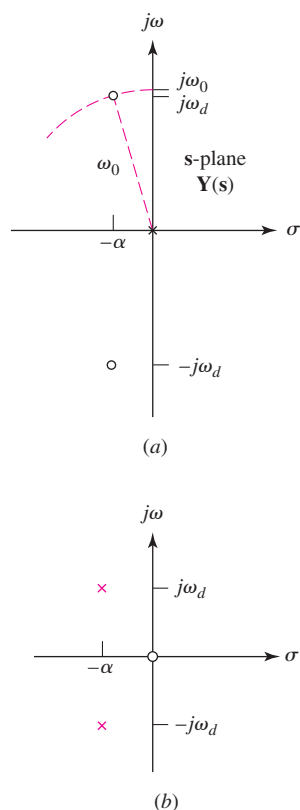

FIGURE 16.1 The parallel combination of a resistor, an inductor, and a capacitor, often referred to as a *parallel resonant circuit*.





■ FIGURE 16.2 (a) The pole-zero constellation of the input admittance of a parallel resonant circuit is shown on the  $s$ -plane;  $\omega_0^2 = \alpha^2 + \omega_d^2$ . (b) The pole-zero constellation of the input impedance.

and  $\omega_d$  is the *natural resonant frequency* (not the resonant frequency  $\omega_0$ ),

$$\omega_d = \sqrt{\omega_0^2 - \alpha^2}$$

The pole-zero constellation shown in Fig. 16.2a follows directly from the factored form.

In view of the relationship among  $\alpha$ ,  $\omega_d$ , and  $\omega_0$ , it is apparent that the distance from the origin of the  $s$  plane to one of the admittance zeros is numerically equal to  $\omega_0$ . Given the pole-zero configuration, the resonant frequency may therefore be obtained by purely graphical methods. We merely swing an arc, using the origin of the  $s$  plane as a center, through one of the zeros. The intersection of this arc and the positive  $j\omega$  axis locates the point  $s = j\omega_0$ . It is evident that  $\omega_0$  is slightly greater than the natural resonant frequency  $\omega_d$ , but their ratio approaches unity as the ratio of  $\omega_d$  to  $\alpha$  increases.

## Resonance and the Voltage Response

Next let us examine the magnitude of the response, the voltage  $\mathbf{V}(s)$  indicated in Fig. 16.1, as the frequency  $\omega$  of the forcing function is varied. If we assume a constant-amplitude sinusoidal current source, the voltage response is proportional to the input impedance. This response can be obtained from the pole-zero plot of the impedance

$$\mathbf{Z}(s) = \frac{s/C}{(s + \alpha - j\omega_d)(s + \alpha + j\omega_d)}$$

shown in Fig. 16.2b. The response of course starts at zero, reaches a maximum value in the vicinity of the natural resonant frequency, and then drops again to zero as  $\omega$  becomes infinite. The frequency response is sketched in Fig. 16.3. The maximum value of the response is indicated as  $R$  times the amplitude of the source current, implying that the maximum magnitude of the circuit impedance is  $R$ ; moreover, the response maximum is shown to occur exactly at the resonant frequency  $\omega_0$ . Two additional frequencies,  $\omega_1$  and  $\omega_2$ , which we will later use as a measure of the width of the response

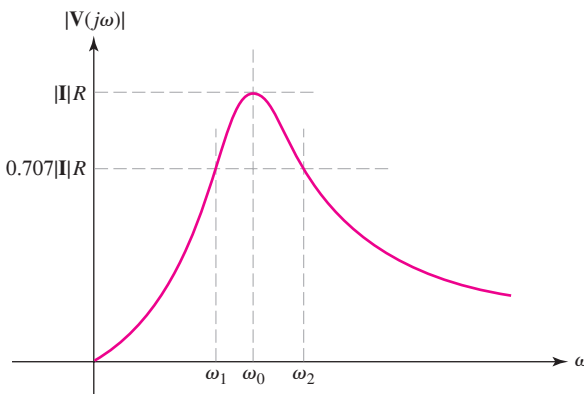

■ FIGURE 16.3 The magnitude of the voltage response of a parallel resonant circuit is shown as a function of frequency.



curve, are also identified. Let us first show that the maximum impedance magnitude is  $R$  and that this maximum occurs at resonance.

The admittance, as specified by Eq. [1], possesses a constant conductance and a susceptance which has a minimum magnitude (zero) at resonance. The minimum admittance magnitude therefore occurs at resonance, and it is  $1/R$ . Hence, the maximum impedance magnitude is  $R$ , and it occurs at resonance.

At the resonant frequency, therefore, the voltage across the parallel resonant circuit of Fig. 16.1 is simply  $\mathbf{I}R$ , and the *entire* source current  $\mathbf{I}$  flows through the resistor. However, current is also present in  $L$  and  $C$ . For the inductor,  $\mathbf{I}_{L,0} = \mathbf{V}_{L,0}/j\omega_0 L = \mathbf{I}R/j\omega_0 L$ , and the capacitor current at resonance is  $\mathbf{I}_{C,0} = (j\omega_0 C)\mathbf{V}_{C,0} = j\omega_0 CRI$ . Since  $1/\omega_0 C = \omega_0 L$  at resonance, we find that

$$\mathbf{I}_{C,0} = -\mathbf{I}_{L,0} = j\omega_0 CRI \quad [5]$$

and

$$\mathbf{I}_{C,0} + \mathbf{I}_{L,0} = \mathbf{I}_{LC} = 0$$

Thus, the *net* current flowing into the  $LC$  combination is zero. The maximum value of the response magnitude and the frequency at which it occurs are not always found so easily. In less standard resonant circuits, we may find it necessary to express the magnitude of the response in analytical form, usually as the square root of the sum of the real part squared and the imaginary part squared; then we should differentiate this expression with respect to frequency, equate the derivative to zero, solve for the frequency of maximum response, and finally substitute this frequency in the magnitude expression to obtain the maximum-amplitude response. The procedure may be carried out for this simple case merely as a corroborative exercise; but, as we have seen, it is not necessary.



## Quality Factor

It should be emphasized that, although the *height* of the response curve of Fig. 16.3 depends only upon the value of  $R$  for constant-amplitude excitation, the width of the curve or the steepness of the sides depends upon the other two element values also. We will shortly relate the “width of the response curve” to a more carefully defined quantity, the *bandwidth*, but it is helpful to express this relationship in terms of a very important parameter, the **quality factor  $Q$** .

We will find that the sharpness of the response curve of any resonant circuit is determined by the maximum amount of energy that can be stored in the circuit, compared with the energy that is lost during one complete period of the response.

We define  $Q$  as

$$Q = \text{quality factor} \equiv 2\pi \frac{\text{maximum energy stored}}{\text{total energy lost per period}} \quad [6]$$

The proportionality constant  $2\pi$  is included in the definition in order to simplify the more useful expressions for  $Q$  which we will now obtain. Since

We should be very careful not to confuse the quality factor with charge or reactive power, all of which unfortunately are represented by the letter  $Q$ .

energy can be stored only in the inductor and the capacitor, and can be lost only in the resistor, we may express  $Q$  in terms of the instantaneous energy associated with each of the reactive elements and the average power  $P_R$  dissipated in the resistor:

$$Q = 2\pi \frac{[w_L(t) + w_C(t)]_{\max}}{P_R T}$$

where  $T$  is the period of the sinusoidal frequency at which  $Q$  is evaluated.

Now let us apply this definition to the parallel  $RLC$  circuit of Fig. 16.1 and determine the value of  $Q$  at the resonant frequency; this value of  $Q$  is denoted by  $Q_0$ . We select the current forcing function

$$i(t) = \mathbf{I}_m \cos \omega_0 t$$

and obtain the corresponding voltage response at resonance,

$$v(t) = Ri(t) = R\mathbf{I}_m \cos \omega_0 t$$

The energy stored in the capacitor is then

$$w_C(t) = \frac{1}{2} C v^2 = \frac{\mathbf{I}_m^2 R^2 C}{2} \cos^2 \omega_0 t$$

and the instantaneous energy stored in the inductor is given by

$$w_L(t) = \frac{1}{2} L i_L^2 = \frac{1}{2} L \left( \frac{1}{L} \int v dt \right)^2 = \frac{1}{2L} \left[ \frac{R\mathbf{I}_m}{\omega_0} \sin \omega_0 t \right]^2$$

so that

$$w_L(t) = \frac{\mathbf{I}_m^2 R^2 C}{2} \sin^2 \omega_0 t$$

The total *instantaneous* stored energy is therefore constant:

$$w(t) = w_L(t) + w_C(t) = \frac{\mathbf{I}_m^2 R^2 C}{2}$$

and this constant value must also be the maximum value. In order to find the energy lost in the resistor in one period, we take the average power absorbed by the resistor (see Sec. 11.2),

$$P_R = \frac{1}{2} \mathbf{I}_m^2 R$$

and multiply by one period, obtaining

$$P_R T = \frac{1}{2f_0} \mathbf{I}_m^2 R$$

We thus find the quality factor at resonance:

$$Q_0 = 2\pi \frac{\mathbf{I}_m^2 R^2 C / 2}{\mathbf{I}_m^2 R / 2f_0}$$

or

$$Q_0 = 2\pi f_0 RC = \omega_0 RC \quad [7]$$

This equation (as well as any expression in Eq. [8]) holds only for the simple parallel  $RLC$  circuit of Fig. 16.1. Equivalent expressions for  $Q_0$  which

are often quite useful may be obtained by simple substitution:

$$Q_0 = R\sqrt{\frac{C}{L}} = \frac{R}{|X_{C,0}|} = \frac{R}{|X_{L,0}|} \quad [8]$$

So we see that for this specific circuit, decreasing the resistance decreases  $Q_0$ ; the lower the resistance, the greater the amount of energy lost in the element. Intriguingly, increasing the capacitance *increases*  $Q_0$ , but increasing the inductance leads to a *reduction* in  $Q_0$ . These statements, of course, apply to operation of the circuit at the resonant frequency.

## Other Interpretations of $Q$

Another useful interpretation of  $Q$  is obtained when we inspect the inductor and capacitor currents at resonance, as given by Eq. [5],

$$\mathbf{I}_{C,0} = -\mathbf{I}_{L,0} = j\omega_0 C R \mathbf{I} = jQ_0 \mathbf{I} \quad [9]$$

Note that each is  $Q_0$  times the source current in amplitude and that each is  $180^\circ$  out of phase with the other. Thus, if we apply 2 mA at the resonant frequency to a parallel resonant circuit with a  $Q_0$  of 50, we find 2 mA in the resistor, and 100 mA in both the inductor and the capacitor. A parallel resonant circuit can therefore act as a current amplifier, but not, of course, as a power amplifier, since it is a passive network.



Resonance, by definition, is fundamentally associated with the forced response, since it is defined in terms of a (purely resistive) input impedance, a sinusoidal steady-state concept. The two most important parameters of a resonant circuit are perhaps the resonant frequency  $\omega_0$  and the quality factor  $Q_0$ . Both the exponential damping coefficient and the natural resonant frequency may be expressed in terms of  $\omega_0$  and  $Q_0$ :

$$\alpha = \frac{1}{2RC} = \frac{1}{2(Q_0/\omega_0 C)C}$$

or

$$\alpha = \frac{\omega_0}{2Q_0} \quad [10]$$

and

$$\omega_d = \sqrt{\omega_0^2 - \alpha^2}$$

or

$$\omega_d = \omega_0 \sqrt{1 - \left(\frac{1}{2Q_0}\right)^2} \quad [11]$$

## Damping Factor

For future reference it may be helpful to note one additional relationship involving  $\omega_0$  and  $Q_0$ . The quadratic factor appearing in the numerator of Eq. [4],

$$s^2 + \frac{1}{RC}s + \frac{1}{LC}$$

may be written in terms of  $\alpha$  and  $\omega_0$ :

$$s^2 + 2\alpha s + \omega_0^2$$

In the field of system theory or automatic control theory, it is traditional to write this factor in a slightly different form that utilizes the dimensionless parameter  $\zeta$  (zeta), called the **damping factor**:

$$s^2 + 2\zeta\omega_0 s + \omega_0^2$$

Comparison of these expressions allows us to relate  $\zeta$  to other parameters:

$$\zeta = \frac{\alpha}{\omega_0} = \frac{1}{2Q_0} \quad [12]$$

### EXAMPLE 16.1

**Consider a parallel  $RLC$  circuit such that  $L = 2$  mH,  $Q_0 = 5$ , and  $C = 10$  nF. Determine the value of  $R$  and the magnitude of the steady-state admittance at  $0.1\omega_0$ ,  $\omega_0$ , and  $1.1\omega_0$ .**

We derived several expressions for  $Q_0$ , a parameter directly related to energy loss, and hence the resistance in our circuit. Rearranging the expression in Eq. [8], we calculate

$$R = Q_0 \sqrt{\frac{L}{C}} = 2.236 \text{ k}\Omega$$

Next, we compute  $\omega_0$ , a term we may recall from Chap. 9,

$$\omega_0 = \frac{1}{\sqrt{LC}} = 223.6 \text{ krad/s}$$

or, alternatively, we may exploit Eq. [7] and obtain the same answer,

$$\omega_0 = \frac{Q_0}{RC} = 223.6 \text{ krad/s}$$

The admittance of any parallel  $RLC$  network is simply

$$\mathbf{Y} = \frac{1}{R} + j\omega C + \frac{1}{j\omega L}$$

and hence

$$|\mathbf{Y}| = \frac{1}{R} + j\omega C + \frac{1}{j\omega L}$$

evaluated at the three designated frequencies is equal to

$$|\mathbf{Y}(0.9\omega_0)| = 6.504 \times 10^{-4} \text{ S} \quad |\mathbf{Y}(\omega_0)| = 4.472 \times 10^{-4} \text{ S}$$

$$|\mathbf{Y}(1.1\omega_0)| = 6.182 \times 10^{-4} \text{ S}$$

We thus obtain a minimum impedance at the resonant frequency, or a *maximum voltage response* to a particular input current. If we quickly compute the reactance at these three frequencies, we find

$$X(0.9\omega_0) = -4.72 \times 10^{-4} \text{ S} \quad X(1.1\omega_0) = 4.72 \times 10^{-4} \text{ S}$$

$$X(\omega_0) = -1.36 \times 10^{-7}$$

We leave it to the reader to show that our value for  $X(\omega_0)$  is nonzero only as a result of rounding error.

## PRACTICE

16.1 A parallel resonant circuit is composed of the elements  $R = 8 \text{ k}\Omega$ ,  $L = 50 \text{ mH}$ , and  $C = 80 \text{ nF}$ . Compute (a)  $\omega_0$ ; (b)  $Q_0$ ; (c)  $\omega_d$ ; (d)  $\alpha$ ; (e)  $\zeta$ .

16.2 Determine the values of  $R$ ,  $L$ , and  $C$  in a parallel resonant circuit for which  $\omega_0 = 1000 \text{ rad/s}$ ,  $\omega_d = 998 \text{ rad/s}$ , and  $\mathbf{Y}_{\text{in}} = 1 \text{ mS}$  at resonance.

Ans: 16.1: 15.811 krad/s; 10.12; 15.792 krad/s; 781 Np/s; 0.0494. 16.2: 1000  $\Omega$ ; 126.4 mH; 7.91  $\mu\text{F}$ .

Now let us interpret  $Q_0$  in terms of the pole-zero locations of the admittance  $\mathbf{Y}(s)$  of the parallel  $RLC$  circuit. We will keep  $\omega_0$  constant; this may be done, for example, by changing  $R$  while holding  $L$  and  $C$  constant. As  $Q_0$  is increased, the relationships relating  $\alpha$ ,  $Q_0$ , and  $\omega_0$  indicate that the two zeros must move closer to the  $j\omega$  axis. These relationships also show that the zeros must simultaneously move away from the  $\sigma$  axis. The exact nature of the movement becomes clearer when we remember that the point at which  $s = j\omega_0$  could be located on the  $j\omega$  axis by swinging an arc, centered at the origin, through one of the zeros and over to the positive  $j\omega$  axis; since  $\omega_0$  is to be held constant, the radius must be constant, and the zeros must therefore move along this arc toward the positive  $j\omega$  axis as  $Q_0$  increases.

The two zeros are indicated in Fig. 16.4, and the arrows show the path they take as  $R$  increases. When  $R$  is infinite,  $Q_0$  is also infinite, and the two zeros are found at  $s = \pm j\omega_0$  on the  $j\omega$  axis. As  $R$  decreases, the zeros move toward the  $\sigma$  axis along the circular locus, joining to form a double zero on the  $\sigma$  axis at  $s = -\omega_0$  when  $R = \frac{1}{2}\sqrt{L/C}$  or  $Q_0 = \frac{1}{2}$ . This condition may be recalled as that for critical damping, so that  $\omega_d = 0$  and  $\alpha = \omega_0$ . Lower values of  $R$  and lower values of  $Q_0$  cause the zeros to separate and move in opposite directions on the negative  $\sigma$  axis, but these low values of  $Q_0$  are not really typical of resonant circuits and we need not track them any further.

Later, we will use the criterion  $Q_0 \geq 5$  to describe a high- $Q$  circuit. When  $Q_0 = 5$ , the zeros are located at  $s = -0.1\omega_0 \pm j0.995\omega_0$ , and thus  $\omega_0$  and  $\omega_d$  differ by only one-half of 1 percent.

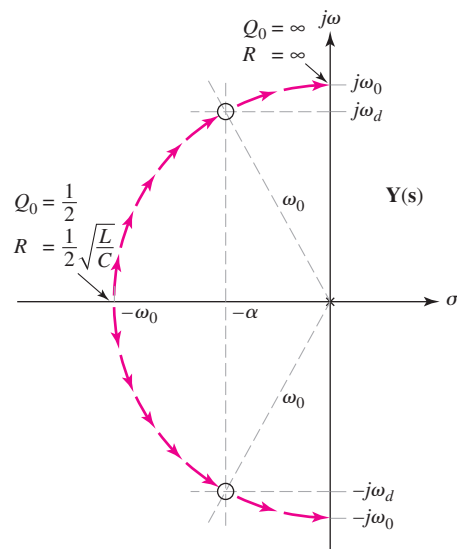

FIGURE 16.4 The two zeros of the admittance  $\mathbf{Y}(s)$ , located at  $s = -\alpha \pm j\omega_d$ , provide a semicircular locus as  $R$  increases from  $\frac{1}{2}\sqrt{L/C}$  to  $\infty$ .

## 16.2 BANDWIDTH AND HIGH-Q CIRCUITS

We continue our discussion of parallel resonance by defining half-power frequencies and bandwidth, and then we will make good use of these new concepts in obtaining approximate response data for high- $Q$  circuits. The “width” of a resonance response curve, such as the one shown in Fig. 16.3, may now be defined more carefully and related to  $Q_0$ . Let us first define the two half-power frequencies  $\omega_1$  and  $\omega_2$  as those frequencies at which the magnitude of the input admittance of a parallel resonant circuit is greater than the magnitude at resonance by a factor of  $\sqrt{2}$ . Since the response curve

These names arise from the fact that a voltage which is  $1/\sqrt{2}$  times the resonant voltage is equivalent to a squared voltage which is one-half the squared voltage at resonance. Thus, at the half-power frequencies, the resistor absorbs one-half the power that it does at resonance.

of Fig. 16.3 displays the voltage produced across the parallel circuit by a sinusoidal current source as a function of frequency, the half-power frequencies also locate those points at which the voltage response is  $1/\sqrt{2}$ , or 0.707, times its maximum value. A similar relationship holds for the impedance magnitude. We will designate  $\omega_1$  as the **lower half-power frequency** and  $\omega_2$  as the **upper half-power frequency**.

## Bandwidth

The (half-power) **bandwidth** of a resonant circuit is defined as the difference of these two half-power frequencies.

$$B \equiv \omega_2 - \omega_1 \quad [13]$$

We tend to think of bandwidth as the “width” of the response curve, even though the curve actually extends from  $\omega = 0$  to  $\omega = \infty$ . More exactly, the half-power bandwidth is measured by that portion of the response curve which is equal to or greater than 70.7 percent of the maximum value, as illustrated in Fig. 16.5.

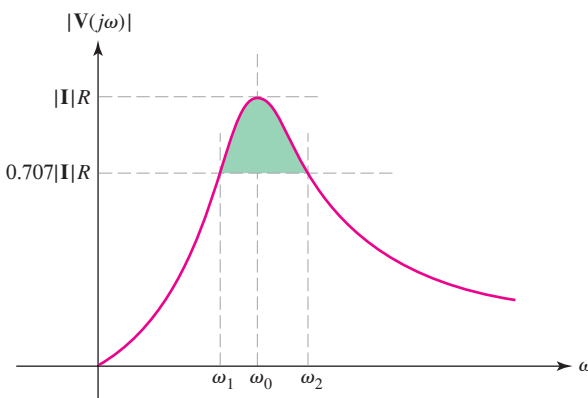

■ FIGURE 16.5 The bandwidth of the circuit response is highlighted in green; it corresponds to the portion of the response curve greater than or equal to 70.7% of the maximum value.

We can express the bandwidth in terms of  $Q_0$  and the resonant frequency. In order to do so, we first express the admittance of the parallel  $RLC$  circuit,

$$\mathbf{Y} = \frac{1}{R} + j \left( \omega C - \frac{1}{\omega L} \right)$$

in terms of  $Q_0$ :

$$\mathbf{Y} = \frac{1}{R} + j \frac{1}{R} \left( \frac{\omega \omega_0 CR}{\omega_0} - \frac{\omega_0 R}{\omega \omega_0 L} \right)$$

or

$$\mathbf{Y} = \frac{1}{R} \left[ 1 + jQ_0 \left( \frac{\omega}{\omega_0} - \frac{\omega_0}{\omega} \right) \right] \quad [14]$$

We note again that the magnitude of the admittance at resonance is  $1/R$ , and then realize that an admittance magnitude of  $\sqrt{2}/R$  can occur only when a frequency is selected such that the imaginary part of the bracketed quantity has a magnitude of unity. Thus

$$Q_0 \left( \frac{\omega_2}{\omega_0} - \frac{\omega_0}{\omega_2} \right) = 1 \quad \text{and} \quad Q_0 \left( \frac{\omega_1}{\omega_0} - \frac{\omega_0}{\omega_1} \right) = -1$$

Solving, we have

$$\omega_1 = \omega_0 \left[ \sqrt{1 + \left( \frac{1}{2Q_0} \right)^2} - \frac{1}{2Q_0} \right] \quad [15]$$

$$\omega_2 = \omega_0 \left[ \sqrt{1 + \left( \frac{1}{2Q_0} \right)^2} + \frac{1}{2Q_0} \right] \quad [16]$$

Although these expressions are somewhat unwieldy, their difference provides a very simple formula for the bandwidth:

$$\mathcal{B} = \omega_2 - \omega_1 = \frac{\omega_0}{Q_0}$$

Equations [15] and [16] may be multiplied by each other to show that  $\omega_0$  is exactly equal to the geometric mean of the half-power frequencies:

$$\omega_0^2 = \omega_1 \omega_2$$

or

$$\omega_0 = \sqrt{\omega_1 \omega_2}$$

Circuits possessing a higher  $Q_0$  have a narrower bandwidth, or a sharper response curve; they have greater **frequency selectivity**, or higher quality (factor).

## Approximations for High-Q Circuits

Many resonant circuits are deliberately designed to have a large  $Q_0$  in order to take advantage of the narrow bandwidth and high frequency selectivity associated with such circuits. When  $Q_0$  is larger than about 5, it is possible to make some useful approximations in the expressions for the upper and lower half-power frequencies and in the general expressions for the response in the neighborhood of resonance. Let us arbitrarily refer to a “high- $Q$  circuit” as one for which  $Q_0$  is equal to or greater than 5. The pole-zero configuration of  $\mathbf{Y}(s)$  for a parallel  $RLC$  circuit having a  $Q_0$  of about 5 is shown in Fig. 16.6. Since

$$\alpha = \frac{\omega_0}{2Q_0}$$

then

$$\alpha = \frac{1}{2}\mathcal{B}$$

Keep in mind that  $\omega_2 > \omega_0$ , while  $\omega_1 < \omega_0$ .

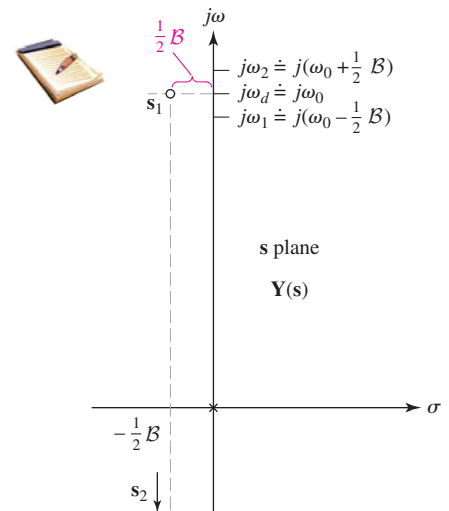

FIGURE 16.6 The pole-zero constellation of  $\mathbf{Y}(s)$  for a parallel  $RLC$  circuit. The two zeros are exactly  $\frac{1}{2}\mathcal{B}$  Np/s (or rad/s) to the left of the  $j\omega$  axis and approximately  $j\omega_0$  rad/s (or Np/s) from the  $\sigma$  axis. The upper and lower half-power frequencies are separated exactly  $\mathcal{B}$  rad/s, and each is approximately  $\frac{1}{2}\mathcal{B}$  rad/s away from the resonant frequency and the natural resonant frequency.

and the locations of the two zeros  $s_1$  and  $s_2$  may be approximated:

$$\begin{aligned} s_{1,2} &= -\alpha \pm j\omega_d \\ &\approx -\frac{1}{2}\mathcal{B} \pm j\omega_0 \end{aligned}$$

Moreover, the locations of the two half-power frequencies (on the positive  $j\omega$  axis) may also be determined in a concise approximate form:

$$\omega_{1,2} = \omega_0 \left[ \sqrt{1 + \left(\frac{1}{2Q_0}\right)^2} \mp \frac{1}{2Q_0} \right] \approx \omega_0 \left( 1 \mp \frac{1}{2Q_0} \right)$$

or

$$\omega_{1,2} \approx \omega_0 \mp \frac{1}{2}\mathcal{B} \quad [17]$$



In a high- $Q$  circuit, therefore, each half-power frequency is located approximately one-half bandwidth from the resonant frequency; this is indicated in Fig. 16.6.

The approximate relationships for  $\omega_1$  and  $\omega_2$  in Eq. [17] may be added to show that  $\omega_0$  is approximately equal to the arithmetic mean of  $\omega_1$  and  $\omega_2$  in high- $Q$  circuits:

$$\omega_0 \approx \frac{1}{2}(\omega_1 + \omega_2)$$

Now let us visualize a test point slightly above  $j\omega_0$  on the  $j\omega$  axis. In order to determine the admittance offered by the parallel  $RLC$  network at this frequency, we construct the three vectors from the critical frequencies to the test point. If the test point is close to  $j\omega_0$ , then the vector from the pole is approximately  $j\omega_0$  and that from the lower zero is nearly  $j2\omega_0$ . The admittance is therefore given approximately by

$$\mathbf{Y}(s) \approx C \frac{(j2\omega_0)(s - s_1)}{j\omega_0} \approx 2C(s - s_1) \quad [18]$$

where  $C$  is the capacitance, as shown in Eq. [4]. In order to determine a useful approximation for the vector  $(s - s_1)$ , let us consider an enlarged view of that portion of the  $s$  plane in the neighborhood of the zero  $s_1$  (Fig. 16.7).

In terms of its cartesian components, we see that

$$s - s_1 \approx \frac{1}{2}\mathcal{B} + j(\omega - \omega_0)$$

where this expression would be exact if  $\omega_0$  were replaced by  $\omega_d$ . We now substitute this equation in the approximation for  $\mathbf{Y}(s)$ , Eq. [18], and factor out  $\frac{1}{2}\mathcal{B}$ :

$$\mathbf{Y}(s) \approx 2C \left( \frac{1}{2}\mathcal{B} \right) \left( 1 + j \frac{\omega - \omega_0}{\frac{1}{2}\mathcal{B}} \right)$$

or

$$\mathbf{Y}(s) \approx \frac{1}{R} \left( 1 + j \frac{\omega - \omega_0}{\frac{1}{2}\mathcal{B}} \right)$$

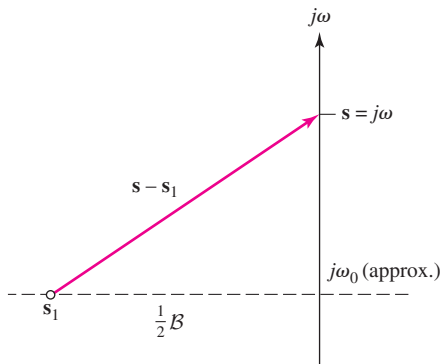

■ FIGURE 16.7 An enlarged portion of the pole-zero constellation for  $\mathbf{Y}(s)$  of a high- $Q_0$  parallel  $RLC$  circuit.



The fraction  $(\omega - \omega_0)/(\frac{1}{2}\mathcal{B})$  may be interpreted as the “number of half-bandwidths off resonance” and abbreviated by  $N$ . Thus,

$$\mathbf{Y}(s) \approx \frac{1}{R}(1 + jN) \quad [19]$$

where

$$N = \frac{\omega - \omega_0}{\frac{1}{2}\mathcal{B}} \quad [20]$$

At the upper half-power frequency,  $\omega_2 \approx \omega_0 + \frac{1}{2}\mathcal{B}$ ,  $N = +1$ , and we are one half-bandwidth above resonance. For the lower half-power frequency,  $\omega_1 \approx \omega_0 - \frac{1}{2}\mathcal{B}$ , so that  $N = -1$ , locating us one half-bandwidth below resonance.

Equation [19] is much easier to use than the exact relationships we have had up to now. It shows that the magnitude of the admittance is

$$|\mathbf{Y}(j\omega)| \approx \frac{1}{R}\sqrt{1 + N^2}$$

while the angle of  $\mathbf{Y}(j\omega)$  is given by the inverse tangent of  $N$ :

$$\text{ang } \mathbf{Y}(j\omega) \approx \tan^{-1} N$$

### EXAMPLE 16.2

**Estimate the location of the two half-power frequencies of the voltage response of a parallel  $RLC$  network for which  $R = 40 \text{ k}\Omega$ ,  $L = 1 \text{ H}$ , and  $C = \frac{1}{64} \mu\text{F}$ , and determine the approximate value of the admittance for an operating frequency of  $8200 \text{ rad/s}$ .**

► **Identify the goal of the problem.**

We seek the lower and upper half-power frequencies of the voltage response as well as  $\mathbf{Y}(\omega_0)$ . Since we are asked to “estimate” and “approximate,” the implication is that this is a high- $Q$  circuit, an assumption we should verify.

► **Collect the known information.**

Given  $R$ ,  $L$ , and  $C$ , we are able to compute  $\omega_0$  and  $Q_0$ . If  $Q_0 \geq 5$ , we may invoke approximate expressions for half-power frequencies and admittance near resonance, but regardless could compute these quantities exactly if required.

► **Devise a plan.**

To use approximate expressions, we must first determine  $Q_0$ , the quality factor at resonance, as well as the bandwidth.

The resonant frequency  $\omega_0$  is given by Eq. [2] as  $1/\sqrt{LC} = 8 \text{ krad/s}$ . Thus,  $Q_0 = \omega_0 RC = 5$ , and the bandwidth is  $\omega_0/Q_0 = 1.6 \text{ krad/s}$ . The value of  $Q_0$  for this circuit is sufficient to employ “high- $Q$ ” approximations.

(Continued on next page)

► **Construct an appropriate set of equations.**

The bandwidth is simply

$$B = \frac{\omega_0}{Q_0} = 1600 \text{ rad/s}$$

and so

$$\omega_1 \approx \omega_0 - \frac{B}{2} = 7200 \text{ rad/s} \quad \omega_2 \approx \omega_0 + \frac{B}{2} = 8800 \text{ rad/s}$$

Equation [19] states that

$$Y(s) \approx \frac{1}{R}(1 + jN)$$

so

$$|Y(j\omega)| \approx \frac{1}{R}\sqrt{1 + N^2} \quad \text{and} \quad \text{ang } Y(j\omega) \approx \tan^{-1} N$$

► **Determine if additional information is required.**

We still require  $N$ , which tells us how many half-bandwidths  $\omega$  is from the resonant frequency  $\omega_0$ :

$$N = (8.2 - 8)/0.8 = 0.25$$

► **Attempt a solution.**

Now we are ready to employ our approximate relationships for the magnitude and angle of the network admittance,

$$\text{ang } Y \approx \tan^{-1} 0.25 = 14.04^\circ$$

and

$$|Y| \approx 25\sqrt{1 + (0.25)^2} = 25.77 \mu\text{S}$$

► **Verify the solution. Is it reasonable or expected?**

An exact calculation of the admittance using Eq. [1] shows that

$$Y(j8200) = 25.75/13.87^\circ \mu\text{S}$$

The approximate method therefore leads to values of admittance magnitude and angle that are reasonably accurate (better than 2 percent) for this frequency. We leave it to the reader to judge the accuracy of our prediction for  $\omega_1$  and  $\omega_2$ .

## PRACTICE

16.3 A marginally high- $Q$  parallel resonant circuit has  $f_0 = 440$  Hz with  $Q_0 = 6$ . Use Eqs. [15] and [16] to obtain accurate values for (a)  $f_1$ ; (b)  $f_2$ . Now use Eq. [17] to calculate approximate values for (c)  $f_1$ ; (d)  $f_2$ .

Ans: 404.9 Hz; 478.2 Hz; 403.3 Hz; 476.7 Hz.

We conclude our coverage of the *parallel* resonant circuit by reviewing some key conclusions we have reached:

- The resonant frequency  $\omega_0$  is the frequency at which the imaginary part of the input admittance becomes zero, or the angle of the admittance becomes zero. For this circuit,  $\omega_0 = 1/\sqrt{LC}$ .
- The circuit's figure of merit  $Q_0$  is defined as  $2\pi$  times the ratio of the maximum energy stored in the circuit to the energy lost each period in the circuit. For this circuit,  $Q_0 = \omega_0 RC$ .
- We defined two half-power frequencies,  $\omega_1$  and  $\omega_2$ , as the frequencies at which the admittance magnitude is  $\sqrt{2}$  times the minimum admittance magnitude. (These are also the frequencies at which the voltage response is 70.7 percent of the maximum response.)
- The exact expressions for  $\omega_1$  and  $\omega_2$  are

$$\omega_{1,2} = \omega_0 \left[ \sqrt{1 + \left(\frac{1}{2Q_0}\right)^2} \mp \frac{1}{2Q_0} \right]$$

- The approximate (high- $Q_0$ ) expressions for  $\omega_1$  and  $\omega_2$  are

$$\omega_{1,2} \approx \omega_0 \mp \frac{1}{2}B$$

- The half-power bandwidth  $B$  is given by

$$B = \omega_2 - \omega_1 = \frac{\omega_0}{Q_0}$$

- The input admittance may also be expressed in approximate form for high- $Q$  circuits:

$$\mathbf{Y} \approx \frac{1}{R}(1 + jN) = \frac{1}{R}\sqrt{1 + N^2}/\underline{\tan^{-1} N}$$

where  $N$  is defined as the number of half-bandwidths off resonance, or

$$N = \frac{\omega - \omega_0}{\frac{1}{2}B}$$

This approximation is valid for  $0.9\omega_0 \leq \omega \leq 1.1\omega_0$ .

## 16.3 SERIES RESONANCE

Although we probably find less use for the series  $RLC$  circuit than we do for the parallel  $RLC$  circuit, it is still worthy of our attention. We will consider the circuit shown in Fig. 16.8. It should be noted that the various circuit

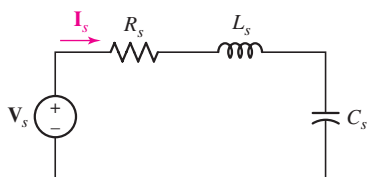

■ FIGURE 16.8 A series resonant circuit.

elements are given the subscript  $s$  (for series) for the time being in order to avoid confusing them with the parallel elements when the circuits are compared.

Our discussion of parallel resonance occupied two sections of considerable length. We could now give the series  $RLC$  circuit the same kind of treatment, but it is much cleverer to avoid such needless repetition and use the concept of duality. For simplicity, let us concentrate on the conclusions presented in the last paragraph of the preceding section on parallel resonance. The important results are contained there, and the use of dual language enables us to transcribe this paragraph to present the important results for the series  $RLC$  circuit.

“We conclude our coverage of the *series* resonant circuit by reviewing some key conclusions we have reached:

- The resonant frequency  $\omega_0$  is the frequency at which the imaginary part of the input impedance becomes zero, or the angle of the impedance becomes zero. For this circuit,  $\omega_0 = 1/\sqrt{C_s L_s}$ .
- The circuit's figure of merit  $Q_0$  is defined as  $2\pi$  times the ratio of the maximum energy stored in the circuit to the energy lost each period in the circuit. For this circuit,  $Q_0 = \omega_0 L_s / R_s$ .
- We defined two half-power frequencies,  $\omega_1$  and  $\omega_2$ , as the frequencies at which the impedance magnitude is  $\sqrt{2}$  times the minimum impedance magnitude. (These are also the frequencies at which the current response is 70.7 percent of the maximum response.)
- The exact expressions for  $\omega_1$  and  $\omega_2$  are

$$\omega_{1,2} = \omega_0 \left[ \sqrt{1 + \left(\frac{1}{2Q_0}\right)^2} \mp \frac{1}{2Q_0} \right]$$

- The approximate (high- $Q_0$ ) expressions for  $\omega_1$  and  $\omega_2$  are

$$\omega_{1,2} \approx \omega_0 \mp \frac{1}{2} \mathcal{B}$$

- The half-power bandwidth  $\mathcal{B}$  is given by

$$\mathcal{B} = \omega_2 - \omega_1 = \frac{\omega_0}{Q_0}$$

- The input admittance may also be expressed in approximate form for high- $Q$  circuits:

$$\mathbf{Y} \approx \frac{1}{R} (1 + jN) = \frac{1}{R} \sqrt{1 + N^2} \angle \tan^{-1} N$$

where  $N$  is defined as the number of half-bandwidths off resonance, or

$$N = \frac{\omega - \omega_0}{\frac{1}{2}\mathcal{B}}$$

This approximation is valid for  $0.9\omega_0 \leq \omega \leq 1.1\omega_0$ .

From this point on, we will no longer identify series resonant circuits by use of the subscript  $s$ , unless clarity requires it.

Again, this paragraph is the same as the last paragraph of Sec. 16.2, with the parallel  $RLC$  language converted to series  $RLC$  language using duality (hence the quotation marks).

## EXAMPLE 16.3

The voltage  $v_s = 100 \cos \omega t$  mV is applied to a series resonant circuit composed of a  $10 \Omega$  resistance, a  $200$  nF capacitance, and a  $2$  mH inductance. Use both exact and approximate methods to calculate the current amplitude if  $\omega = 48$  krad/s.

The resonant frequency of the circuit is given by

$$\omega_0 = \frac{1}{\sqrt{LC}} = \frac{1}{\sqrt{(2 \times 10^{-3})(200 \times 10^{-9})}} = 50 \text{ krad/s}$$

Since we are operating at  $\omega = 48$  krad/s, which is within 10 percent of the resonant frequency, it is reasonable to apply our approximate relationships to estimate the equivalent impedance of the network provided that we find that we are working with a high- $Q$  circuit:

$$\mathbf{Z}_{\text{eq}} \approx R\sqrt{1 + N^2}/\tan^{-1} N$$

where  $N$  is computed once we determine  $Q_0$ . This is a series circuit, so

$$Q_0 = \frac{\omega_0 L}{R} = \frac{(50 \times 10^3)(2 \times 10^{-3})}{10} = 10$$

which qualifies as a high- $Q$  circuit. Thus,

$$B = \frac{\omega_0}{Q_0} = \frac{50 \times 10^3}{10} = 5 \text{ krad/s}$$

The number of half-bandwidths off resonance ( $N$ ) is therefore

$$N = \frac{\omega - \omega_0}{B/2} = \frac{48 - 50}{2.5} = -0.8$$

Thus,

$$\mathbf{Z}_{\text{eq}} \approx R\sqrt{1 + N^2}/\tan^{-1} N = 12.81/\underline{-38.66^\circ} \Omega$$

The approximate current magnitude is then

$$\frac{|\mathbf{V}_s|}{|\mathbf{Z}_{\text{eq}}|} = \frac{100}{12.81} = 7.806 \text{ mA}$$

Using the exact expressions, we find that  $\mathbf{I} = 7.746/\underline{39.24^\circ}$  mA and thus

$$|\mathbf{I}| = 7.746 \text{ mA}$$

## PRACTICE

16.4 A series resonant circuit has a bandwidth of 100 Hz and contains a 20 mH inductance and a 2  $\mu$ F capacitance. Determine (a)  $f_0$ ; (b)  $Q_0$ ; (c)  $\mathbf{Z}_{\text{in}}$  at resonance; (d)  $f_2$ .

Ans: 796 Hz; 7.96; 12.57 +  $j0 \Omega$ ; 846 Hz (approx.).

The series resonant circuit is characterized by a minimum impedance at resonance, whereas the parallel resonant circuit produces a maximum resonant impedance. The latter circuit provides inductor currents and capacitor currents at resonance which have amplitudes  $Q_0$  times as great as the source current; the series resonant circuit provides inductor voltages and capacitor voltages which are greater than the source voltage by the factor  $Q_{0s}$ . The series circuit thus provides voltage amplification at resonance.



A comparison of our results for series and parallel resonance, as well as the exact and approximate expressions we have developed, appears in Table 16.1.

TABLE 16.1 A Short Summary of Resonance

$Q_0 = \omega_0 RC \quad \alpha = \frac{1}{2RC}$	$Q_0 = \frac{\omega_0 L}{R} \quad \alpha = \frac{R}{2L}$
$ I_L(j\omega_0)  =  I_C(j\omega_0)  = Q_0  I(j\omega_0) $	$ V_L(j\omega_0)  =  V_C(j\omega_0)  = Q_0  V(j\omega_0) $
$Y_p = \frac{1}{R} \left[ 1 + jQ_0 \left( \frac{\omega}{\omega_0} - \frac{\omega_0}{\omega} \right) \right]$	$Z_s = R \left[ 1 + jQ_0 \left( \frac{\omega}{\omega_0} - \frac{\omega_0}{\omega} \right) \right]$
Exact expressions	
$\omega_0 = \frac{1}{\sqrt{LC}} = \sqrt{\omega_1 \omega_2}$	
$\omega_d = \sqrt{\omega_0^2 - \alpha^2} = \omega_0 \sqrt{1 - \left( \frac{1}{2Q_0} \right)^2}$	
$\omega_{1,2} = \omega_0 \left[ \sqrt{1 + \left( \frac{1}{2Q_0} \right)^2} \mp \frac{1}{2Q_0} \right]$	
$N = \frac{\omega - \omega_0}{\frac{1}{2}\mathcal{B}}$	
$\mathcal{B} = \omega_2 - \omega_1 = \frac{\omega_0}{Q_0} = 2\alpha$	
Approximate expressions	
$(Q_0 \geq 5 \quad 0.9\omega_0 \leq \omega \leq 1.1\omega_0)$	
$\omega_d \approx \omega_0$	
$\omega_{1,2} \approx \omega_0 \mp \frac{1}{2}\mathcal{B}$	
$\omega_0 \approx \frac{1}{2}(\omega_1 + \omega_2)$	
$Y_p \approx \frac{\sqrt{1 + N^2}}{R} / \tan^{-1} N$	
$Z_s \approx R \sqrt{1 + N^2} / \tan^{-1} N$	

## 16.4 OTHER RESONANT FORMS

The parallel and series  $RLC$  circuits of the previous two sections represent *idealized* resonant circuits. The degree of accuracy with which the idealized model fits an *actual* circuit depends on the operating frequency range, the  $Q$  of the circuit, the materials present in the physical elements, the element sizes, and many other factors. We are not studying the techniques for determining the best model of a given physical circuit, for this requires some knowledge of electromagnetic field theory and the properties of materials; we are, however, concerned with the problem of reducing a more complicated model to one of the two simpler models with which we are more familiar.

The network shown in Fig. 16.9a is a reasonably accurate model for the parallel combination of a physical inductor, capacitor, and resistor. The resistor labeled  $R_1$  is a hypothetical resistor that is included to account for the ohmic, core, and radiation losses of the physical coil. The losses in the dielectric within the physical capacitor, as well as the resistance of the physical resistor in the given  $RLC$  circuit, are accounted for by the resistor labeled  $R_2$ . In this model, *there is no way* to combine elements and produce a simpler model which is equivalent to the original model *for all frequencies*. We will show, however, that a simpler equivalent may be constructed which is valid over a frequency band that is usually large enough to include all frequencies of interest. The equivalent will take the form of the network shown in Fig. 16.9b.

Before we learn how to develop such an equivalent circuit, let us first consider the given circuit, Fig. 16.9a. The resonant radian frequency for this network is *not*  $1/\sqrt{LC}$ , although if  $R_1$  is sufficiently small it may be very close to this value. The definition of resonance is unchanged, and we may determine the resonant frequency by setting the imaginary part of the input admittance equal to zero:

$$\text{Im}\{Y(j\omega)\} = \text{Im}\left\{\frac{1}{R_2} + j\omega C + \frac{1}{R_1 + j\omega L}\right\} = 0$$

or

$$\begin{aligned} \text{Im}\left\{\frac{1}{R_2} + j\omega C + \frac{1}{R_1 + j\omega L} \frac{R_1 - j\omega L}{R_1 - j\omega L}\right\} \\ = \text{Im}\left\{\frac{1}{R_2} + j\omega C + \frac{R_1 - j\omega L}{R_1^2 + \omega^2 L^2}\right\} = 0 \end{aligned}$$

Thus, we have the resonance condition that

$$C = \frac{L}{R_1^2 + \omega^2 L^2}$$

and so

$$\omega_0 = \sqrt{\frac{1}{LC} - \left(\frac{R_1}{L}\right)^2} \quad [21]$$

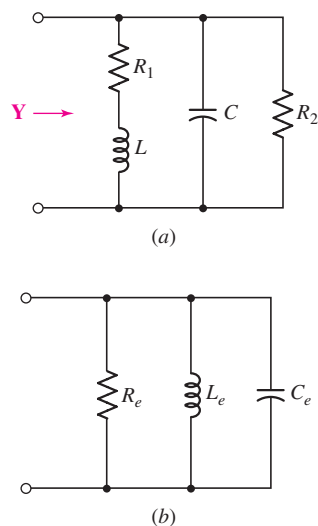

■ FIGURE 16.9 (a) A useful model of a physical network which consists of a physical inductor, capacitor, and resistor in parallel. (b) A network which can be equivalent to part (a) over a narrow frequency band.



We note that  $\omega_0$  is less than  $1/\sqrt{LC}$ , but sufficiently small values of the ratio  $R_1/L$  may result in a negligible difference between  $\omega_0$  and  $1/\sqrt{LC}$ .

The maximum magnitude of the input impedance also deserves consideration. It is not  $R_2$ , and it does not occur at  $\omega_0$  (or at  $\omega = 1/\sqrt{LC}$ ). The proof of these statements will not be shown, because the expressions soon become algebraically cumbersome; the theory, however, is straightforward. Let us be content with a numerical example.



### EXAMPLE 16.4

Using the values  $R_1 = 2 \Omega$ ,  $L = 1 \text{ H}$ ,  $C = 125 \text{ mF}$ , and  $R_2 = 3 \Omega$  for Fig. 16.9a, determine the resonant frequency and the impedance at resonance.

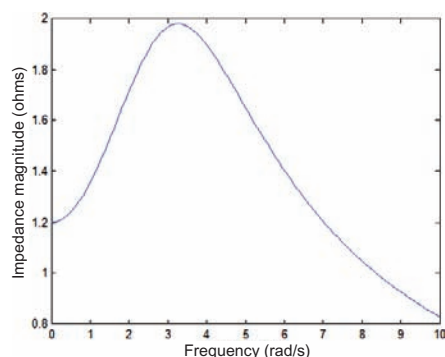

FIGURE 16.10 Plot of  $|Z|$  vs.  $\omega$ , generated using the following MATLAB script:

```

EDU» omega = linspace(0,10,100);
EDU» for i = 1:100
Y(i) = 1/3 + j*omega(i)/8 + 1/(2 + j*omega(i));
Z(i) = 1/Y(i);
end
EDU» plot(omega,abs(Z));
EDU» xlabel('frequency (rad/s)');
EDU» ylabel('impedance magnitude (ohms)');

```

Substituting the appropriate values in Eq. [21], we find

$$\omega_0 = \sqrt{8 - 2^2} = 2 \text{ rad/s}$$

and this enables us to calculate the input admittance,

$$\mathbf{Y} = \frac{1}{3} + j2 \left( \frac{1}{8} \right) + \frac{1}{2 + j(2)(1)} = \frac{1}{3} + \frac{1}{4} = 0.583 \text{ S}$$

and then the input impedance at resonance:

$$\mathbf{Z}(j2) = \frac{1}{0.583} = 1.714 \Omega$$

At the frequency which would be the resonant frequency if  $R_1$  were zero,

$$\frac{1}{\sqrt{LC}} = 2.83 \text{ rad/s}$$

the input impedance would be

$$\mathbf{Z}(j2.83) = 1.947 / -13.26^\circ \Omega$$

As can be seen in Fig. 16.10, however, the frequency at which the *maximum* impedance magnitude occurs, indicated by  $\omega_m$ , can be determined to be  $\omega_m = 3.26 \text{ rad/s}$ , and the *maximum* impedance magnitude is

$$\mathbf{Z}(j3.26) = 1.980 / -21.4^\circ \Omega$$

The impedance magnitude at resonance and the maximum magnitude differ by about 16 percent. Although it is true that such an error may be neglected occasionally in practice, it is too large to neglect on an exam. (The later work in this section will show that the  $Q$  of the inductor-resistor combination at 2 rad/s is unity; this low value accounts for the 16 percent discrepancy.)

### PRACTICE

16.5 Referring to the circuit of Fig. 16.9a, let  $R_1 = 1 \text{ k}\Omega$  and  $C = 2.533 \text{ pF}$ . Determine the inductance necessary to select a resonant frequency of 1 MHz. (*Hint*: Recall that  $\omega = 2\pi f$ .)

Ans: 10 mH.



## Equivalent Series and Parallel Combinations

In order to transform the given circuit of Fig. 16.9a into an equivalent of the form shown in Fig. 16.9b, we must discuss the  $Q$  of a simple series or parallel combination of a resistor and a reactor (inductor or capacitor). We first consider the series circuit shown in Fig. 16.11a. The  $Q$  of this network is again defined as  $2\pi$  times the ratio of the maximum stored energy to the energy lost each period, but the  $Q$  may be evaluated at any frequency we choose. In other words,  $Q$  is a function of  $\omega$ . It is true that we will choose to evaluate it at a frequency which is, or apparently is, the resonant frequency of some network of which the series arm is a part. This frequency, however, is not known until a more complete circuit is available. The reader is encouraged to show that the  $Q$  of this series arm is  $|X_s|/R_s$ , whereas the  $Q$  of the parallel network of Fig. 16.11b is  $R_p/|X_p|$ .

Let us now carry out the details necessary to find values for  $R_p$  and  $X_p$  so that the parallel network of Fig. 16.11b is equivalent to the series network of Fig. 16.11a at some single specific frequency. We equate  $Y_s$  and  $Y_p$ ,

$$\begin{aligned} Y_s &= \frac{1}{R_s + jX_s} = \frac{R_s - jX_s}{R_s^2 + X_s^2} \\ &= Y_p = \frac{1}{R_p} - j \frac{1}{X_p} \end{aligned}$$

and obtain

$$\begin{aligned} R_p &= \frac{R_s^2 + X_s^2}{R_s} \\ X_p &= \frac{R_s^2 + X_s^2}{X_s} \end{aligned}$$

Dividing these two expressions, we find

$$\frac{R_p}{X_p} = \frac{X_s}{R_s}$$

It follows that the  $Q$ 's of the series and parallel networks must be equal:

$$Q_p = Q_s = Q$$

The transformation equations may therefore be simplified:

$$R_p = R_s(1 + Q^2) \quad [22]$$

$$X_p = X_s \left( 1 + \frac{1}{Q^2} \right) \quad [23]$$

Also  $R_s$  and  $X_s$  may be found if  $R_p$  and  $X_p$  are the given values; the transformation in either direction may be performed.

If  $Q \geq 5$ , little error is introduced by using the approximate relationships

$$R_p \approx Q^2 R_s \quad [24]$$

$$X_p \approx X_s \quad (C_p \approx C_s \quad \text{or} \quad L_p \approx L_s) \quad [25]$$

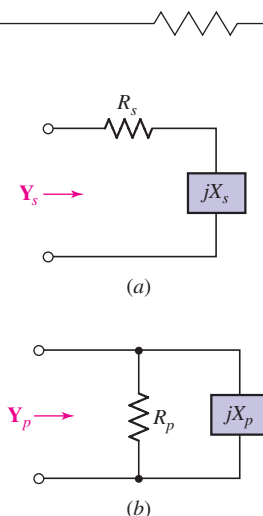

■ FIGURE 16.11 (a) A series network which consists of a resistance  $R_s$  and an inductive or capacitive reactance  $X_s$  may be transformed into (b) a parallel network such that  $Y_s = Y_p$  at one specific frequency. The reverse transformation is equally possible.

## EXAMPLE 16.5

Find the parallel equivalent of the series combination of a 100 mH inductor and a 5  $\Omega$  resistor at a frequency of 1000 rad/s. Details of the network to which this series combination is connected are unavailable.

At  $\omega = 1000$  rad/s,  $X_s = 1000(100 \times 10^{-3}) = 100 \Omega$ . The  $Q$  of this series combination is

$$Q = \frac{X_s}{R_s} = \frac{100}{5} = 20$$

Since the  $Q$  is sufficiently high (20 is much greater than 5), we use Eqs. [24] and [25] to obtain

$$R_p \approx Q^2 R_s = 2000 \Omega \quad \text{and} \quad L_p \approx L_s = 100 \text{ mH}$$

Our assertion here is that a 100 mH inductor in series with a 5  $\Omega$  resistor provides *essentially the same* input impedance as does a 100 mH inductor in parallel with a 2000  $\Omega$  resistor at the frequency 1000 rad/s.

To check the accuracy of the equivalence, let us evaluate the input impedance for each network at 1000 rad/s. We find

$$\mathbf{Z}_s(j1000) = 5 + j100 = 100.1/\underline{87.1^\circ} \Omega$$

$$\mathbf{Z}_p(j1000) = \frac{2000(j100)}{2000 + j100} = 99.9/\underline{87.1^\circ} \Omega$$

and conclude that the accuracy of our approximation at the transformation frequency is pretty impressive. The accuracy at 900 rad/s is also reasonably good, because

$$\mathbf{Z}_s(j900) = 90.1/\underline{86.8^\circ} \Omega$$

$$\mathbf{Z}_p(j900) = 89.9/\underline{87.4^\circ} \Omega$$

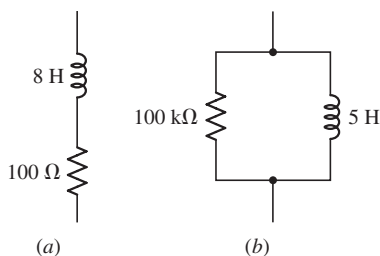

FIGURE 16.12 (a) A series network for which an equivalent parallel network (at  $\omega = 1000$  rad/s) is needed. (b) A parallel network for which an equivalent series network (at  $\omega = 1000$  rad/s) is needed.

## PRACTICE

16.6 At  $\omega = 1000$  rad/s, find a parallel network that is equivalent to the series combination in Fig. 16.12a.

16.7 Find a series equivalent for the parallel network shown in Fig. 16.12b, assuming  $\omega = 1000$  rad/s.

Ans: 16.6: 8 H, 640 k $\Omega$ ; 16.7: 5 H, 250  $\Omega$ .

An “ideal” meter is an instrument that measures a particular quantity of interest without disturbing the circuit being tested. Although this is impossible, modern instruments can come very close to being ideal in this respect.

As a further example of the replacement of a more complicated resonant circuit by an equivalent series or parallel  $RLC$  circuit, let us consider a problem in electronic instrumentation. The simple series  $RLC$  network in Fig. 16.13a is excited by a sinusoidal voltage source at the network’s resonant frequency. The effective (rms) value of the source voltage is 0.5 V, and we wish to measure the effective value of the voltage across the capacitor with an electronic voltmeter (VM) having an internal resistance of 100,000  $\Omega$ . That is, an equivalent representation of the voltmeter is an ideal voltmeter in parallel with a 100 k $\Omega$  resistor.

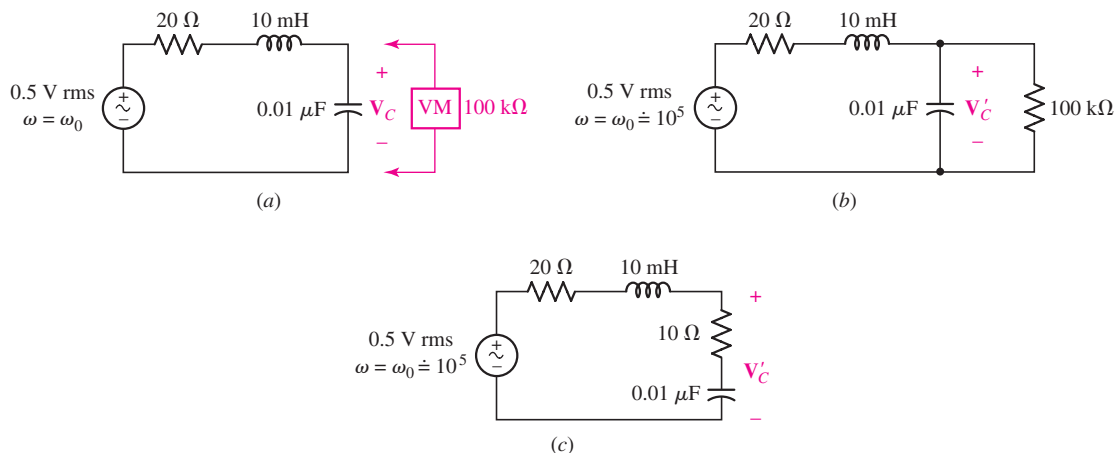

■ FIGURE 16.13 (a) A given series resonant circuit in which the capacitor voltage is to be measured by a nonideal electronic voltmeter. (b) The effect of the voltmeter is included in the circuit; it reads  $V'_C$ . (c) A series resonant circuit is obtained when the parallel  $RC$  network in part (b) is replaced by the series  $RC$  network which is equivalent at  $10^5$  rad/s.

Before the voltmeter is connected, we compute that the resonant frequency is  $10^5$  rad/s,  $Q_0 = 50$ , the current is 25 mA, and the rms capacitor voltage is 25 V. (As indicated at the end of Sec. 16.3, this voltage is  $Q_0$  times the applied voltage.) Thus, if the voltmeter were ideal, it would read 25 V when connected across the capacitor.

However, when the actual voltmeter is connected, the circuit shown in Fig. 16.13b results. In order to obtain a series  $RLC$  circuit, it is now necessary to replace the parallel  $RC$  network with a series  $RC$  network. Let us assume that the  $Q$  of this  $RC$  network is sufficiently high that the equivalent series capacitor will be the same as the given parallel capacitor. We do this in order to approximate the resonant frequency of the final series  $RLC$  circuit. Thus, if the series  $RLC$  circuit also contains a  $0.01 \mu\text{F}$  capacitor, the resonant frequency remains  $10^5$  rad/s. We need to know this estimated resonant frequency in order to calculate the  $Q$  of the parallel  $RC$  network; it is

$$Q = \frac{R_p}{|X_p|} = \omega R_p C_p = 10^5(10^5)(10^{-8}) = 100$$

Since this value is greater than 5, our vicious circle of assumptions is justified, and the equivalent series  $RC$  network consists of the capacitor  $C_s = 0.01 \mu\text{F}$  and the resistor

$$R_s \approx \frac{R_p}{Q^2} = 10 \Omega$$

Hence, the equivalent circuit of Fig. 16.13c is obtained. The resonant  $Q$  of this circuit is now only 33.3, and thus the voltage across the capacitor in the circuit of Fig. 16.13c is  $16\frac{2}{3}$  V. But we need to find  $|V'_C|$ , the voltage across the series  $RC$  combination; we obtain

$$|V'_C| = \frac{0.5}{30} |10 - j1000| = 16.67 \text{ V}$$

The capacitor voltage and  $|V_C|$  are essentially equal, since the voltage across the  $10\ \Omega$  resistor is quite small.

The final conclusion must be that an apparently good voltmeter may still produce a severe effect on the response of a high- $Q$  resonant circuit. A similar effect may occur when a nonideal ammeter is inserted in the circuit.

We wrap up this section with a technical fable.



*Once upon a time* there was a student named Sean, who had a professor identified simply as Dr. Abel.

In the laboratory one afternoon, Dr. Abel gave Sean three practical circuit devices: a resistor, an inductor, and a capacitor, having nominal element values of  $20\ \Omega$ ,  $20\ \text{mH}$ , and  $1\ \mu\text{F}$ . The student was asked to connect a variable-frequency voltage source to the series combination of these three elements, to measure the resultant voltage across the resistor as a function of frequency, and then to calculate numerical values for the resonant frequency, the  $Q$  at resonance, and the half-power bandwidth. The student was also asked to predict the results of the experiment before making the measurements.

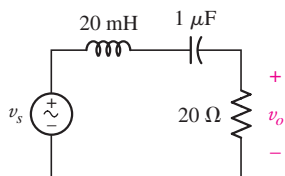

■ FIGURE 16.14 A first model for a  $20\ \text{mH}$  inductor, a  $1\ \mu\text{F}$  capacitor, and a  $20\ \Omega$  resistor in series with a voltage generator.

Sean, first drew an equivalent circuit for this problem that was like the circuit of Fig. 16.14, and then calculated

$$f_0 = \frac{1}{2\pi\sqrt{LC}} = \frac{1}{2\pi\sqrt{20 \times 10^{-3} \times 10^{-6}}} = 1125\ \text{Hz}$$

$$Q_0 = \frac{\omega_0 L}{R} = 7.07$$

$$B = \frac{f_0}{Q_0} = 159\ \text{Hz}$$

Next, Sean made the measurements that Dr. Abel requested, compared them with the predicted values, and then felt a strong urge to transfer to the business school. The results were

$$f_0 = 1000\ \text{Hz} \quad Q_0 = 0.625 \quad B = 1600\ \text{Hz}$$

Sean knew that discrepancies of this magnitude could not be characterized as being “within engineering accuracy” or “due to meter errors.” Sadly, the results were handed to the professor.

Remembering many past errors in judgment, some of which were even (possibly) self-made, Dr. Abel smiled kindly and called Sean’s attention to the  $Q$ -meter (or impedance bridge) which is present in most well-equipped laboratories, and suggested that it might be used to find out what these practical circuit elements really looked like at some convenient frequency near resonance,  $1000\ \text{Hz}$ , for example.

Upon doing so, Sean discovered that the resistor had a measured value of  $18\ \Omega$  and the inductor was  $21.4\ \text{mH}$  with a  $Q$  of  $1.2$ , while the capacitor had a capacitance of  $1.41\ \mu\text{F}$  and a dissipation factor (the reciprocal of  $Q$ ) equal to  $0.123$ .

So, with the hope that springs eternal within the heart of every engineering undergraduate, Sean reasoned that a better model for the practical inductor would be  $21.4\ \text{mH}$  in series with  $\omega L/Q = 112\ \Omega$ , while a more

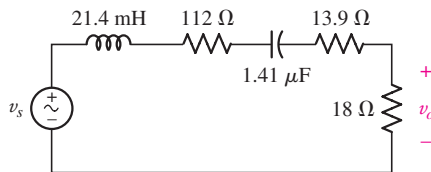

■ FIGURE 16.15 An improved model in which more accurate values are used and the losses in the inductor and capacitor are acknowledged.

appropriate model for the capacitor would be  $1.41 \mu\text{F}$  in series with  $1/\omega C Q = 13.9 \Omega$ . Using these data, Sean prepared the modified circuit model shown as Fig. 16.15 and calculated a new set of predicted values:

$$f_0 = \frac{1}{2\pi \sqrt{21.4 \times 10^{-3} \times 1.41 \times 10^{-6}}} = 916 \text{ Hz}$$

$$Q_0 = \frac{2\pi \times 916 \times 21.4 \times 10^{-3}}{143.9} = 0.856$$

$$B = 916/0.856 = 1070 \text{ Hz}$$

Since these results were much closer to the measured values, Sean was much happier. Dr. Abel, however, being a stickler for detail, pondered the differences in the predicted and measured values for both  $Q_0$  and the bandwidth. “Have you,” Dr. Abel asked, “given any consideration to the output impedance of the voltage source?” “Not yet,” said Sean, trotting back to the laboratory bench.

It turned out that the output impedance in question was  $50 \Omega$  and so Sean added this value to the circuit diagram, as shown in Fig. 16.16. Using the new equivalent resistance value of  $193.9 \Omega$ , improved values for  $Q_0$  and  $B$  were then obtained:

$$Q_0 = 0.635 \quad B = 1442 \text{ Hz}$$

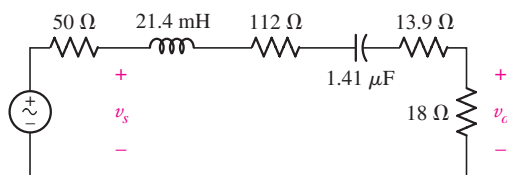

■ FIGURE 16.16 The final model also contains the output resistance of the voltage source.

Since all the theoretical and experimental values now agreed within 10 percent, Sean was once again an enthusiastic, confident engineering student, motivated to start homework early and read the textbook prior to class.<sup>1</sup> Dr. Abel simply nodded her head agreeably as she moralized:

*When using real devices,  
Watch the models that you choose;  
Think well before you calculate,  
And mind your Z's and Q's!*

(1) Okay, this last part is a bit much. Sorry about that.

## PRACTICE

16.8 The series combination of  $10\ \Omega$  and  $10\ \text{nF}$  is in parallel with the series combination of  $20\ \Omega$  and  $10\ \text{mH}$ . (a) Find the approximate resonant frequency of the parallel network. (b) Find the  $Q$  of the  $RC$  branch. (c) Find the  $Q$  of the  $RL$  branch. (d) Find the three-element equivalent of the original network.

Ans:  $10^5\ \text{rad/s}$ ; 100; 50;  $10\ \text{nF} \parallel 10\ \text{mH} \parallel 33.3\ \text{k}\Omega$ .

## 16.5 SCALING

Some of the examples and problems that we have been solving have involved circuits containing passive element values ranging around a few ohms, a few henrys, and a few farads. The applied frequencies were a few radians per second. These particular numerical values were used not because they are those commonly met in practice, but because arithmetic manipulations are so much easier than they would be if it were necessary to carry along various powers of 10 throughout the calculations. The scaling procedures that will be discussed in this section enable us to analyze networks composed of practical-sized elements by scaling the element values to permit more convenient numerical calculations. We will consider both *magnitude scaling* and *frequency scaling*.

Let us select the parallel resonant circuit shown in Fig. 16.17a as our example. The impractical element values lead to the unlikely response curve drawn as Fig. 16.17b; the maximum impedance is  $2.5\ \Omega$ , the resonant frequency is  $1\ \text{rad/s}$ ,  $Q_0$  is 5, and the bandwidth is  $0.2\ \text{rad/s}$ . These numerical values are much more characteristic of the electrical analog of some mechanical system than they are of any basically electrical device. We have convenient numbers with which to calculate, but an impractical circuit to construct.

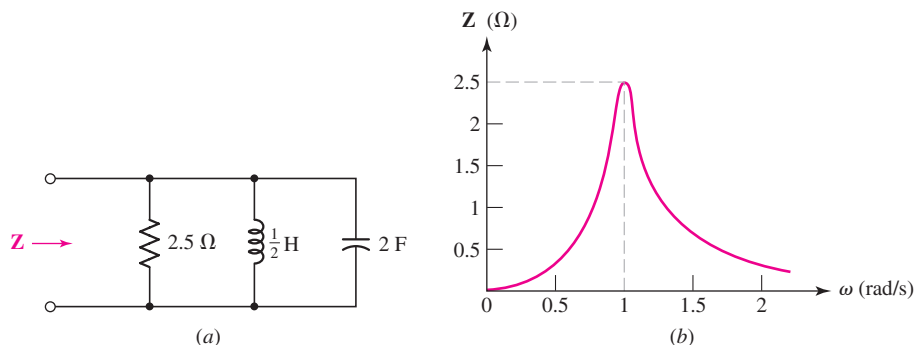

FIGURE 16.17 (a) A parallel resonant circuit used as an example to illustrate magnitude and frequency scaling. (b) The magnitude of the input impedance is shown as a function of frequency.

Recall that “ordinate” refers to the vertical axis and “abscissa” refers to the horizontal axis.

Our goal is to scale this network in such a way as to provide an impedance maximum of  $5000\ \Omega$  at a resonant frequency of  $5 \times 10^6\ \text{rad/s}$ , or  $796\ \text{kHz}$ . In other words, we may use the same response curve shown in Fig. 16.17b if

every number on the *ordinate* scale is increased by a factor of 2000 and every number on the *abscissa* scale is increased by a factor of  $5 \times 10^6$ . We will treat this as two problems: (1) scaling in magnitude by a factor of 2000 and (2) scaling in frequency by a factor of  $5 \times 10^6$ .

Magnitude scaling is defined as the process by which the impedance of a two-terminal network is increased by a factor of  $K_m$ , the frequency remaining constant. The factor  $K_m$  is real and positive; it may be greater or smaller than unity. We will understand that the shorter statement “*the network is scaled in magnitude by a factor of 2*” indicates that the impedance of the new network is to be twice that of the old network at any frequency. Let us now determine how we must scale each type of passive element. To increase the input impedance of a network by a factor of  $K_m$ , it is sufficient to increase the impedance of each element in the network by this same factor. Thus, a resistance  $R$  must be replaced by a resistance  $K_m R$ . Each inductance must also exhibit an impedance which is  $K_m$  times as great at any frequency. In order to increase an impedance  $sL$  by a factor of  $K_m$  when  $s$  remains constant, the inductance  $L$  must be replaced by an inductance  $K_m L$ . In a similar manner, each capacitance  $C$  must be replaced by a capacitance  $C/K_m$ . In summary, these changes will produce a network which is scaled in magnitude by a factor of  $K_m$ :

$$\left. \begin{array}{l} R \rightarrow K_m R \\ L \rightarrow K_m L \\ C \rightarrow \frac{C}{K_m} \end{array} \right\} \text{magnitude scaling}$$

When each element in the network of Fig. 16.17a is scaled in magnitude by a factor of 2000, the network shown in Fig. 16.18a results. The response curve shown in Fig. 16.18b indicates that no change in the previously drawn response curve need be made other than a change in the scale of the ordinate.

Let us now take this new network and scale it in frequency. We define frequency scaling as the process by which the frequency at which any impedance occurs is increased by a factor of  $K_f$ . Again, we will make use of the shorter expression “*the network is scaled in frequency by a factor of 2*” to indicate that the same impedance is now obtained at a frequency twice as great. Frequency scaling is accomplished by scaling each passive element in frequency. It is apparent that no resistor is affected. The impedance of any inductor is  $sL$ , and if this same impedance is to be obtained at a frequency  $K_f$  times as great, then the inductance  $L$  must be replaced by an inductance of  $L/K_f$ . Similarly, a capacitance  $C$  is to be replaced by a capacitance  $C/K_f$ . Thus, if a network is to be scaled in frequency by a factor of  $K_f$ , then the changes necessary in each passive element are

$$\left. \begin{array}{l} R \rightarrow R \\ L \rightarrow \frac{L}{K_f} \\ C \rightarrow \frac{C}{K_f} \end{array} \right\} \text{frequency scaling}$$

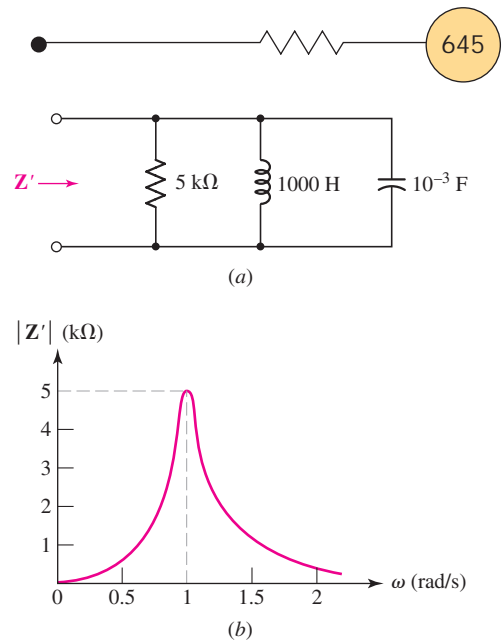

■ FIGURE 16.18 (a) The network of Fig. 16.17a after being scaled in magnitude by a factor  $K_m = 2000$ . (b) The corresponding response curve.

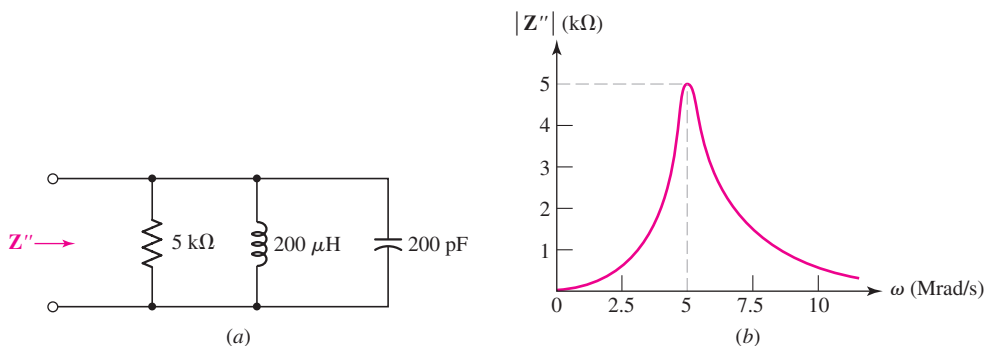

■ FIGURE 16.19 (a) The network of Fig. 16.18a after being scaled in frequency by a factor  $K_f = 5 \times 10^6$ . (b) The corresponding response curve.

When each element of the magnitude-scaled network of Fig. 16.18a is scaled in frequency by a factor of  $5 \times 10^6$ , the network of Fig. 16.19a is obtained. The corresponding response curve is shown in Fig. 16.19b.

The circuit elements in this last network have values which are easily achieved in physical circuits; the network can actually be built and tested. It follows that, if the original network of Fig. 16.17a were actually an analog of some mechanical resonant system, we could have scaled this analog in both magnitude and frequency in order to achieve a network which we might construct in the laboratory; tests that are expensive or inconvenient to run on the mechanical system could then be made on the scaled electrical system, and the results should then be “unscaled” and converted into mechanical units to complete the analysis.

An impedance that is given as a function of  $s$  may also be scaled in magnitude or frequency, and this may be done without any knowledge of the specific elements of which the two-terminal network is composed. In order to scale  $\mathbf{Z}(s)$  in magnitude, the definition of magnitude scaling shows that it is necessary only to multiply  $\mathbf{Z}(s)$  by  $K_m$  in order to obtain the magnitude-scaled impedance. Hence, the impedance  $\mathbf{Z}'(s)$  of the magnitude-scaled network is

$$\mathbf{Z}'(s) = K_m \mathbf{Z}(s)$$

If  $\mathbf{Z}'(s)$  is now to be scaled in frequency by a factor of  $5 \times 10^6$ , then  $\mathbf{Z}''(s)$  and  $\mathbf{Z}'(s)$  are to provide identical values of impedance if  $\mathbf{Z}''(s)$  is evaluated at a frequency  $K_f$  times that at which  $\mathbf{Z}'(s)$  is evaluated, or

$$\mathbf{Z}''(s) = \mathbf{Z}'\left(\frac{s}{K_f}\right)$$

Although scaling is a process normally applied to passive elements, dependent sources may also be scaled in magnitude and frequency. We assume that the output of any source is given as  $k_x v_x$  or  $k_y i_y$ , where  $k_x$  has the dimensions of an admittance for a dependent current source and is dimensionless for a dependent voltage source, while  $k_y$  has the dimensions of ohms for a dependent voltage source and is dimensionless for a dependent



current source. If the network containing the dependent source is scaled in magnitude by  $K_m$ , then it is necessary only to treat  $k_x$  or  $k_y$  as if it were the type of element consistent with its dimensions. That is, if  $k_x$  (or  $k_y$ ) is dimensionless, it is left unchanged; if it is an admittance, it is divided by  $K_m$ ; and if it is an impedance, it is multiplied by  $K_m$ . *Frequency scaling does not affect the dependent sources.*



## EXAMPLE 16.6

Scale the network shown in Fig. 16.20 by  $K_m = 20$  and  $K_f = 50$ , and then find  $Z_{in}(s)$  for the scaled network.

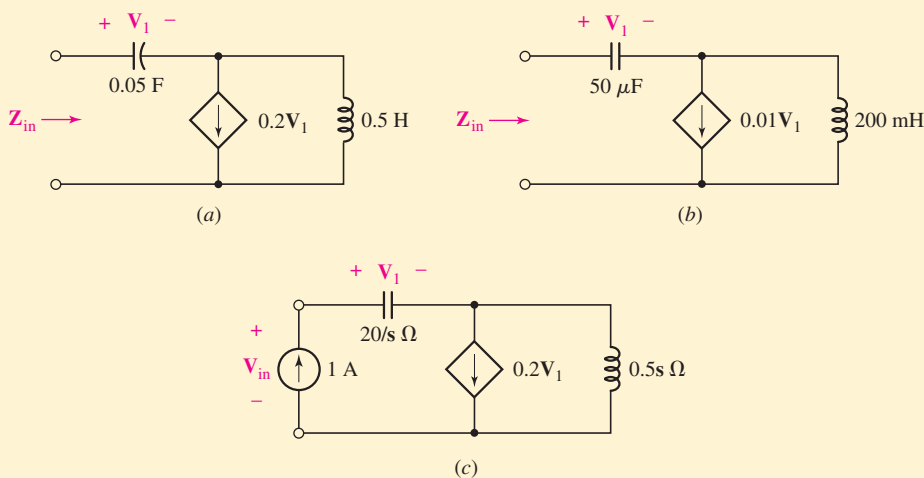

■ FIGURE 16.20 (a) A network to be magnitude-scaled by a factor of 20, and frequency-scaled by a factor of 50. (b) The scaled network. (c) A 1 A test source is applied to the input terminals in order to obtain the impedance of the unscaled network in part (a).

Magnitude scaling of the capacitor is accomplished by dividing 0.05 F by the scaling factor  $K_m = 20$ , and frequency scaling is accomplished by dividing by  $K_f = 50$ . Carrying out both operations simultaneously,

$$C_{\text{scaled}} = \frac{0.05}{(20)(50)} = 50 \mu\text{F}$$

The inductor is also scaled:

$$L_{\text{scaled}} = \frac{(20)(0.5)}{50} = 200 \text{ mH}$$

In scaling the dependent source, only magnitude scaling need be considered, as frequency scaling does not affect dependent sources. Since

(Continued on next page)

this is a *voltage*-controlled *current* source, the multiplying constant 0.2 has units of A/V, or S. Since the factor has units of admittance, we divide by  $K_m$ , so that the new term is  $0.01\mathbf{V}_1$ . The resulting (scaled) network is shown in Fig. 16.20*b*.

To find the impedance of the new network, we need to apply a 1 A test source at the input terminals. We may work with either circuit; however, let's proceed by first finding the impedance of the *unscaled* network in Fig. 16.20*a*, and then scaling the result.

Referring to Fig. 16.20*c*,

$$\mathbf{V}_{\text{in}} = \mathbf{V}_1 + 0.5s(1 - 0.2\mathbf{V}_1)$$

Also,

$$\mathbf{V}_1 = \frac{20}{s}(1)$$

Performing the indicated substitution followed by a little algebraic manipulation yields

$$\mathbf{Z}_{\text{in}} = \frac{\mathbf{V}_{\text{in}}}{1} = \frac{s^2 - 4s + 40}{2s}$$

To scale this quantity to correspond to the circuit of Fig. 16.20*b* we multiply by  $K_m = 20$ , and replace  $s$  with  $s/\mathbf{K}_f = s/50$ . Thus,

$$\mathbf{Z}_{\text{in, scaled}} = \frac{0.2s^2 - 40s + 20,000}{s} \quad \Omega$$

### PRACTICE

16.9 A parallel resonant circuit is defined by  $C = 0.01$  F,  $\mathcal{B} = 2.5$  rad/s, and  $\omega_0 = 20$  rad/s. Find the values of  $R$  and  $L$  if the network is scaled in (a) magnitude by a factor of 800; (b) frequency by a factor of  $10^4$ ; (c) magnitude by a factor of 800 and frequency by a factor of  $10^4$ .

Ans: 32 k $\Omega$ , 200 H; 40  $\Omega$ , 25  $\mu$ H; 32 k $\Omega$ , 20 mH.

## 16.6 BODE DIAGRAMS

In this section we will discover a quick method of obtaining an *approximate* picture of the amplitude and phase variation of a given transfer function as functions of  $\omega$ . Accurate curves may, of course, be plotted after calculating values with a programmable calculator or a computer; curves may also be produced directly on the computer. Our object here, however, is to obtain a better picture of the response than we could visualize from a pole-zero plot, but yet not mount an all-out computational offensive.

## The Decibel (dB) Scale

The approximate response curve we construct is called an asymptotic plot, or a *Bode plot*, or a *Bode diagram*, after its developer, Hendrik W. Bode, who was an electrical engineer and mathematician with the Bell Telephone Laboratories. Both the magnitude and phase curves are shown using a logarithmic frequency scale for the abscissa, and the magnitude itself is also shown in logarithmic units called *decibels* (dB). We define the value of  $|\mathbf{H}(j\omega)|$  in dB as follows:

$$H_{\text{dB}} = 20 \log |\mathbf{H}(j\omega)|$$

where the common logarithm (base 10) is used. (A multiplier of 10 instead of 20 is used for power transfer functions, but we will not need it here.) The inverse operation is

$$|\mathbf{H}(j\omega)| = 10^{H_{\text{dB}}/20}$$

Before we actually begin a detailed discussion of the technique for drawing Bode diagrams, it will help to gain some feeling for the size of the decibel unit, to learn a few of its important values, and to recall some of the properties of the logarithm. Since  $\log 1 = 0$ ,  $\log 2 = 0.30103$ , and  $\log 10 = 1$ , we note the correspondences:

$$|\mathbf{H}(j\omega)| = 1 \Leftrightarrow H_{\text{dB}} = 0$$

$$|\mathbf{H}(j\omega)| = 2 \Leftrightarrow H_{\text{dB}} \approx 6 \text{ dB}$$

$$|\mathbf{H}(j\omega)| = 10 \Leftrightarrow H_{\text{dB}} = 20 \text{ dB}$$

An increase of  $|\mathbf{H}(j\omega)|$  by a factor of 10 corresponds to an increase in  $H_{\text{dB}}$  by 20 dB. Moreover,  $\log 10^n = n$ , and thus  $10^n \Leftrightarrow 20n$  dB, so that 1000 corresponds to 60 dB, while 0.01 is represented as  $-40$  dB. Using only the values already given, we may also note that  $20 \log 5 = 20 \log \frac{10}{2} = 20 \log 10 - 20 \log 2 = 20 - 6 = 14$  dB, and thus  $5 \Leftrightarrow 14$  dB. Also,  $\log \sqrt{x} = \frac{1}{2} \log x$ , and therefore  $\sqrt{2} \Leftrightarrow 3$  dB and  $1/\sqrt{2} \Leftrightarrow -3$  dB.<sup>2</sup>

We will write our transfer functions in terms of  $s$ , substituting  $s = j\omega$  when we are ready to find the magnitude or phase angle. If desired, the magnitude may be written in terms of dB at that point.



The decibel is named in honor of Alexander Graham Bell.

### PRACTICE

16.10 Calculate  $H_{\text{dB}}$  at  $\omega = 146$  rad/s if  $\mathbf{H}(s)$  equals (a)  $20/(s + 100)$ ; (b)  $20(s + 100)$ ; (c)  $20s$ . Calculate  $|\mathbf{H}(j\omega)|$  if  $H_{\text{dB}}$  equals (d) 29.2 dB; (e)  $-15.6$  dB; (f)  $-0.318$  dB.

Ans:  $-18.94$  dB;  $71.0$  dB;  $69.3$  dB;  $28.8$ ;  $0.1660$ ;  $0.964$ .

(2) Note that we are being slightly dishonest here by using  $20 \log 2 = 6$  dB rather than  $6.02$  dB. It is customary, however, to represent  $\sqrt{2}$  as 3 dB; since the dB scale is inherently logarithmic, the small inaccuracy is seldom significant.

## Determination of Asymptotes

Our next step is to factor  $\mathbf{H}(s)$  to display its poles and zeros. We first consider a zero at  $s = -a$ , written in a standardized form as

$$\mathbf{H}(s) = 1 + \frac{s}{a} \quad [26]$$

The Bode diagram for this function consists of the two asymptotic curves approached by  $H_{\text{dB}}$  for very large and very small values of  $\omega$ . Thus, we begin by finding

$$|\mathbf{H}(j\omega)| = \left| 1 + \frac{j\omega}{a} \right| = \sqrt{1 + \frac{\omega^2}{a^2}}$$

and thus

$$H_{\text{dB}} = 20 \log \left| 1 + \frac{j\omega}{a} \right| = 20 \log \sqrt{1 + \frac{\omega^2}{a^2}}$$

When  $\omega \ll a$ ,

$$H_{\text{dB}} \approx 20 \log 1 = 0 \quad (\omega \ll a)$$

This simple asymptote is shown in Fig. 16.21. It is drawn as a solid line for  $\omega < a$ , and as a dashed line for  $\omega > a$ .

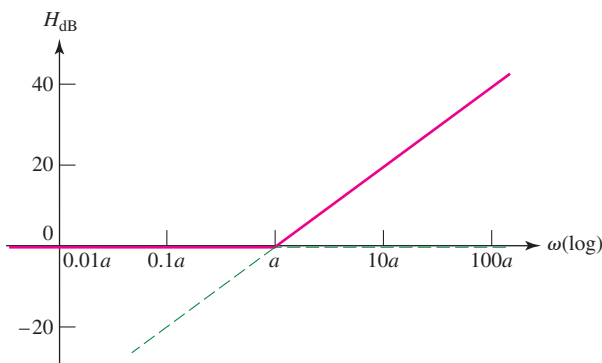

■ FIGURE 16.21 The Bode amplitude plot for  $\mathbf{H}(s) = 1 + s/a$  consists of the low- and high-frequency asymptotes, shown as dashed lines. They intersect on the abscissa at the corner frequency. The Bode plot represents the response in terms of two asymptotes, both straight lines and both easily drawn.

When  $\omega \gg a$ ,

$$H_{\text{dB}} \approx 20 \log \frac{\omega}{a} \quad (\omega \gg a)$$

A **decade** refers to a range of frequencies defined by a factor of 10, such as 3 Hz to 30 Hz, or 12.5 MHz to 125 MHz. An **octave** refers to a range of frequencies defined by a factor of 2, such as 7 GHz to 14 GHz.

At  $\omega = a$ ,  $H_{\text{dB}} = 0$ ; at  $\omega = 10a$ ,  $H_{\text{dB}} = 20$  dB; and at  $\omega = 100a$ ,  $H_{\text{dB}} = 40$  dB. Thus, the value of  $H_{\text{dB}}$  increases 20 dB for every 10-fold increase in frequency. The asymptote therefore has a slope of 20 dB/decade. Since  $H_{\text{dB}}$  increases by 6 dB when  $\omega$  doubles, an alternate value for the slope is 6 dB/octave. The high-frequency asymptote is also shown in Fig. 16.21, a solid

line for  $\omega > a$ , and a broken line for  $\omega < a$ . Note that the two asymptotes intersect at  $\omega = a$ , the frequency of the zero. This frequency is also described as the *corner, break, 3 dB, or half-power frequency*.

## Smoothing Bode Plots

Let us see how much error is embodied in our asymptotic response curve. At the corner frequency ( $\omega = a$ ),

$$H_{\text{dB}} = 20 \log \sqrt{1 + \frac{a^2}{a^2}} = 3 \text{ dB}$$

as compared with an asymptotic value of 0 dB. At  $\omega = 0.5a$ , we have

$$H_{\text{dB}} = 20 \log \sqrt{1.25} \approx 1 \text{ dB}$$

Thus, the exact response is represented by a smooth curve that lies 3 dB above the asymptotic response at  $\omega = a$ , and 1 dB above it at  $\omega = 0.5a$  (and also at  $\omega = 2a$ ). This information can always be used to smooth out the corner if a more exact result is desired.

Note that we continue to abide by the convention of taking  $\sqrt{2}$  as corresponding to 3 dB.

## Multiple Terms

Most transfer functions will consist of more than a simple zero (or simple pole). This, however, is easily handled by the Bode method, since we are in fact working with logarithms. For example, consider a function

$$\mathbf{H}(s) = K \left(1 + \frac{s}{s_1}\right) \left(1 + \frac{s}{s_2}\right)$$

where  $K = \text{constant}$ , and  $-s_1$  and  $-s_2$  represent the two zeros of our function  $\mathbf{H}(s)$ . For this function  $H_{\text{dB}}$  may be written as

$$\begin{aligned} H_{\text{dB}} &= 20 \log \left| K \left(1 + \frac{j\omega}{s_1}\right) \left(1 + \frac{j\omega}{s_2}\right) \right| \\ &= 20 \log \left[ K \sqrt{1 + \left(\frac{\omega}{s_1}\right)^2} \sqrt{1 + \left(\frac{\omega}{s_2}\right)^2} \right] \end{aligned}$$

or

$$H_{\text{dB}} = 20 \log K + 20 \log \sqrt{1 + \left(\frac{\omega}{s_1}\right)^2} + 20 \log \sqrt{1 + \left(\frac{\omega}{s_2}\right)^2}$$

which is simply the sum of a constant (frequency-independent) term  $20 \log K$  and two simple zero terms of the form previously considered. In other words, we may construct a sketch of  $H_{\text{dB}}$  by simply graphically adding the plots of the separate terms. We explore this in the following example.

## EXAMPLE 16.7

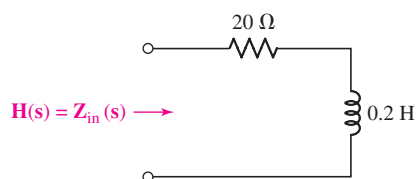

■ FIGURE 16.22 If  $\mathbf{H}(s)$  is selected as  $\mathbf{Z}_{in}(s)$  for this network, then the Bode plot for  $H_{dB}$  is as shown in Fig. 16.23b.

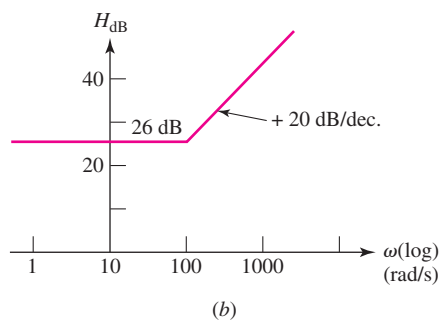
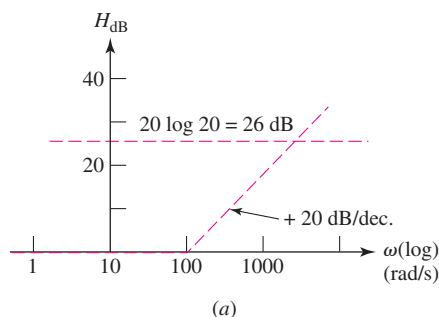

■ FIGURE 16.23 (a) The Bode plots for the factors of  $\mathbf{H}(s) = 20(1 + s/100)$  are sketched individually. (b) The composite Bode plot is shown as the sum of the plots of part (a).

Obtain the Bode plot of the input impedance of the network shown in Fig. 16.22.

We have the input impedance,

$$\mathbf{Z}_{in}(s) = \mathbf{H}(s) = 20 + 0.2s$$

Putting this in standard form, we obtain

$$\mathbf{H}(s) = 20 \left( 1 + \frac{s}{100} \right)$$

The two factors constituting  $\mathbf{H}(s)$  are a zero at  $s = -100$ , leading to a break frequency of  $\omega = 100$  rad/s, and a constant equivalent to  $20 \log 20 = 26$  dB. Each of these is sketched lightly in Fig. 16.23a. Since we are working with the logarithm of  $|\mathbf{H}(j\omega)|$ , we next add together the Bode plots corresponding to the individual factors. The resultant magnitude plot appears as Fig. 16.23b. No attempt has been made to smooth out the corner with a +3 dB correction at  $\omega = 100$  rad/s; this is left to the reader as a quick exercise.

## PRACTICE

16.11 Construct a Bode magnitude plot for  $\mathbf{H}(s) = 50 + s$ .

Ans: 34 dB,  $\omega < 50$  rad/s; slope = +20 dB/decade  $\omega > 50$  rad/s.

## Phase Response

Returning to the transfer function of Eq. [26], we would now like to determine the *phase response* for the simple zero,

$$\text{ang } \mathbf{H}(j\omega) = \text{ang} \left( 1 + \frac{j\omega}{a} \right) = \tan^{-1} \frac{\omega}{a}$$

This expression is also represented by its asymptotes, although three straight-line segments are required. For  $\omega \ll a$ ,  $\text{ang } \mathbf{H}(j\omega) \approx 0^\circ$ , and we use this as our asymptote when  $\omega < 0.1a$ :

$$\text{ang } \mathbf{H}(j\omega) = 0^\circ \quad (\omega < 0.1a)$$

At the high end,  $\omega \gg a$ , we have  $\text{ang } \mathbf{H}(j\omega) \approx 90^\circ$ , and we use this above  $\omega = 10a$ :

$$\text{ang } \mathbf{H}(j\omega) = 90^\circ \quad (\omega > 10a)$$

Since the angle is  $45^\circ$  at  $\omega = a$ , we now construct the straight-line asymptote extending from  $0^\circ$  at  $\omega = 0.1a$ , through  $45^\circ$  at  $\omega = a$ , to  $90^\circ$  at  $\omega = 10a$ . This straight line has a slope of  $45^\circ/\text{decade}$ . It is shown as a solid curve in Fig. 16.24, while the exact angle response is shown as a broken line. The maximum differences between the asymptotic and true responses are  $\pm 5.71^\circ$  at  $\omega = 0.1a$  and  $10a$ . Errors of  $\mp 5.29^\circ$  occur at  $\omega = 0.394a$  and

$2.54a$ ; the error is zero at  $\omega = 0.159a$ ,  $a$ , and  $6.31a$ . The phase angle plot is typically left as a straight-line approximation, although smooth curves can also be drawn in a manner similar to that depicted in Fig. 16.24 by the dashed line.

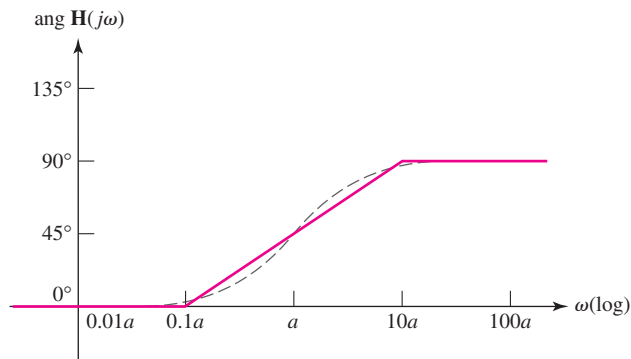

■ FIGURE 16.24 The asymptotic angle response for  $H(s) = 1 + s/a$  is shown as the three straight-line segments in solid color. The endpoints of the ramp are  $0^\circ$  at  $0.1a$  and  $90^\circ$  at  $10a$ . The dashed line represents a more accurate (smoothed) response.

It is worth pausing briefly here to consider what the phase plot is telling us. In the case of a simple zero at  $s = a$ , we see that for frequencies much less than the corner frequency, the phase of the response function is  $0^\circ$ . For high frequencies, however ( $\omega \gg a$ ), the phase is  $90^\circ$ . In the vicinity of the corner frequency, the phase of the transfer function varies somewhat rapidly. The actual phase angle imparted to the response can therefore be selected through the design of the circuit (which determines  $a$ ).

### PRACTICE

16.12 Draw the Bode phase plot for the transfer function of Example 16.7.

Ans:  $0^\circ$ ,  $\omega \leq 10$ ;  $90^\circ$ ,  $\omega \geq 1000$ ;  $45^\circ$ ,  $\omega = 100$ ;  $45^\circ/\text{dec}$  slope,  $10 < \omega < 1000$ . ( $\omega$  in rad/s).

## Additional Considerations in Creating Bode Plots

We next consider a simple pole,

$$\mathbf{H}(s) = \frac{1}{1 + s/a} \quad [27]$$

Since this is the reciprocal of a zero, the logarithmic operation leads to a Bode plot which is the *negative* of that obtained previously. The amplitude is 0 dB up to  $\omega = a$ , and then the slope is  $-20$  dB/decade for  $\omega > a$ . The angle plot is  $0^\circ$  for  $\omega < 0.1a$ ,  $-90^\circ$  for  $\omega > 10a$ , and  $-45^\circ$  at  $\omega = a$ , and it has a slope of  $-45^\circ/\text{decade}$  when  $0.1a < \omega < 10a$ . The reader is encouraged to generate the Bode plot for this function by working directly with Eq. [27].

Another term that can appear in  $\mathbf{H}(s)$  is a factor of  $s$  in the numerator or denominator. If  $\mathbf{H}(s) = s$ , then

$$H_{\text{dB}} = 20 \log |\omega|$$

Thus, we have an infinite straight line passing through 0 dB at  $\omega = 1$  and having a slope everywhere of 20 dB/decade. This is shown in Fig. 16.25a. If the  $s$  factor occurs in the denominator, a straight line is obtained having a slope of  $-20$  dB/decade and passing through 0 dB at  $\omega = 1$ , as shown in Fig. 16.25b.

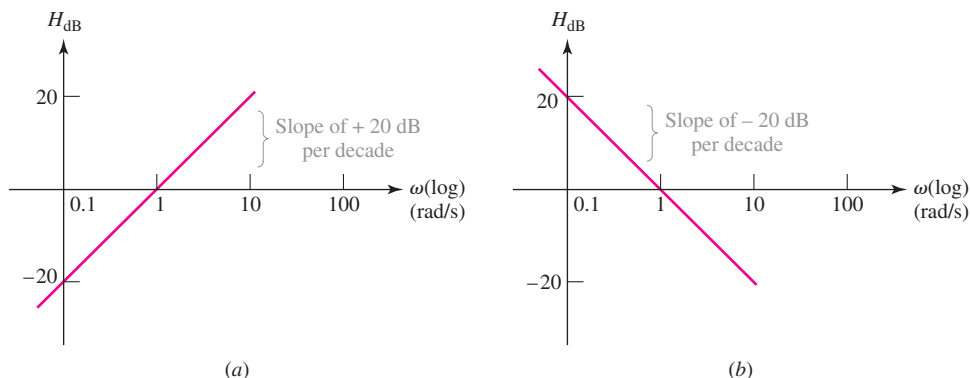

■ FIGURE 16.25 The asymptotic diagrams are shown for (a)  $\mathbf{H}(s) = s$  and (b)  $\mathbf{H}(s) = 1/s$ . Both are infinitely long straight lines passing through 0 dB at  $\omega = 1$  and having slopes of  $\pm 20$  dB/decade.

Another simple term found in  $\mathbf{H}(s)$  is the multiplying constant  $K$ . This yields a Bode plot which is a horizontal straight line lying  $20 \log |K|$  dB above the abscissa. It will actually be below the abscissa if  $|K| < 1$ .

## EXAMPLE 16.8

Obtain the Bode plot for the gain of the circuit shown in Fig. 16.26.

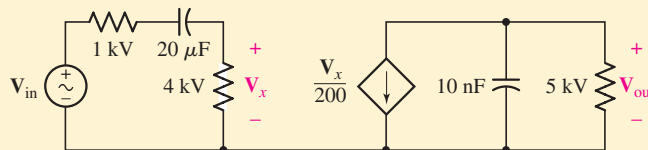

■ FIGURE 16.26 If  $\mathbf{H}(s) = \mathbf{V}_{\text{out}}/\mathbf{V}_{\text{in}}$ , this amplifier is found to have the Bode amplitude plot shown in Fig. 16.27a, and the phase plot shown in Fig. 16.28.

We work from left to right through the circuit and write the expression for the voltage gain,

$$\mathbf{H}(s) = \frac{\mathbf{V}_{\text{out}}}{\mathbf{V}_{\text{in}}} = \frac{4000}{5000 + 10^6/20s} \left( -\frac{1}{200} \right) \frac{5000(10^8/s)}{5000 + 10^8/s}$$

which simplifies (mercifully) to

$$\mathbf{H}(s) = \frac{-2s}{(1 + s/10)(1 + s/20,000)} \quad [28]$$



We see a constant,  $20 \log |-2| = 6 \text{ dB}$ , break points at  $\omega = 10 \text{ rad/s}$  and  $\omega = 20,000 \text{ rad/s}$ , and a linear factor  $s$ . Each of these is sketched in Fig. 16.27a, and the four sketches are added to give the Bode magnitude plot in Fig. 16.27b.

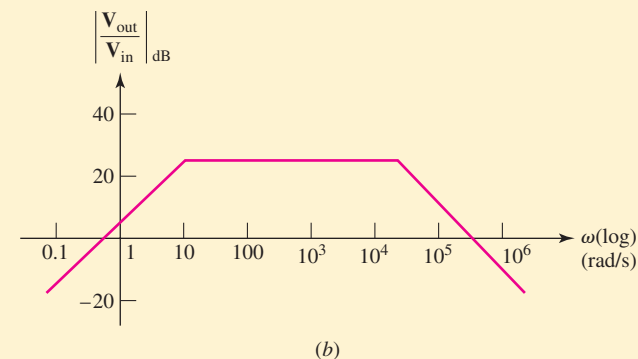
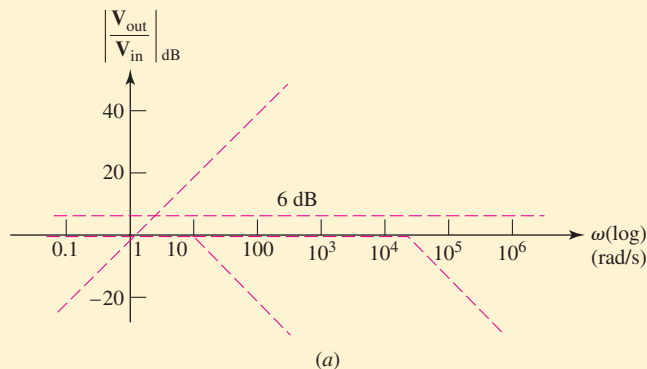

■ FIGURE 16.27 (a) Individual Bode magnitude sketches are made for the factors  $(-2)$ ,  $(s)$ ,  $(1 + s/10)^{-1}$ , and  $(1 + s/20,000)^{-1}$ . (b) The four separate plots of part (a) are added to give the Bode magnitude plots for the amplifier of Fig. 16.26.

## PRACTICE

16.13 Construct a Bode magnitude plot for  $\mathbf{H}(s)$  equal to  
(a)  $50/(s + 100)$ ; (b)  $(s + 10)/(s + 100)$ ; (c)  $(s + 10)/s$ .

Ans: (a)  $-6 \text{ dB}$ ,  $\omega < 100$ ;  $-20 \text{ dB/decade}$ ,  $\omega > 100$ ; (b)  $-20 \text{ dB}$ ,  $\omega < 10$ ;  $+20 \text{ dB/decade}$ ,  $10 < \omega < 100$ ;  $0 \text{ dB}$ ,  $\omega > 100$ ; (c)  $0 \text{ dB}$ ,  $\omega > 10$ ;  $-20 \text{ dB/decade}$ ,  $\omega < 10$ .

Before we construct the phase plot for the amplifier of Fig. 16.26, let us take a few moments to investigate several of the details of the magnitude plot.

First, it is wise not to rely too heavily on graphical addition of the individual magnitude plots. Instead, the exact value of the combined magnitude plot may be found easily at selected points by considering the asymptotic



value of each factor of  $\mathbf{H}(s)$  at the point in question. For example, in the flat region of Fig. 16.27a between  $\omega = 10$  and  $\omega = 20,000$ , we are below the corner at  $\omega = 20,000$ , and so we represent  $(1 + s/20,000)$  by 1; but we are above  $\omega = 10$ , so  $(1 + s/10)$  is represented as  $\omega/10$ . Hence,

$$\begin{aligned} H_{\text{dB}} &= 20 \log \left| \frac{-2\omega}{(\omega/10)(1)} \right| \\ &= 20 \log 20 = 26 \text{ dB} \quad (10 < \omega < 20,000) \end{aligned}$$

We might also wish to know the frequency at which the asymptotic response crosses the abscissa at the high end. The two factors are expressed here as  $\omega/10$  and  $\omega/20,000$ ; thus

$$H_{\text{dB}} = 20 \log \left| \frac{-2\omega}{(\omega/10)(\omega/20,000)} \right| = 20 \log \left| \frac{400,000}{\omega} \right|$$

Since  $H_{\text{dB}} = 0$  at the abscissa crossing,  $400,000/\omega = 1$ , and therefore  $\omega = 400,000$  rad/s.

Many times we do not need an accurate Bode plot drawn on printed semilog paper. Instead we construct a rough logarithmic frequency axis on simple lined paper. After selecting the interval for a decade—say, a distance  $L$  extending from  $\omega = \omega_1$  to  $\omega = 10\omega_1$  (where  $\omega_1$  is usually an integral power of 10)—we let  $x$  locate the distance that  $\omega$  lies to the right of  $\omega_1$ , so that  $x/L = \log(\omega/\omega_1)$ . Of particular help is the knowledge that  $x = 0.3L$  when  $\omega = 2\omega_1$ ,  $x = 0.6L$  at  $\omega = 4\omega_1$ , and  $x = 0.7L$  at  $\omega = 5\omega_1$ .

### EXAMPLE 16.9

**Draw the phase plot for the transfer function given by Eq. [28],  $\mathbf{H}(s) = -2s/[(1 + s/10)(1 + s/20,000)]$ .**

We begin by inspecting  $\mathbf{H}(j\omega)$ :

$$\mathbf{H}(j\omega) = \frac{-j2\omega}{(1 + j\omega/10)(1 + j\omega/20,000)} \quad [29]$$

The angle of the numerator is a constant,  $-90^\circ$ .

The remaining factors are represented as the sum of the angles contributed by break points at  $\omega = 10$  and  $\omega = 20,000$ . These three terms appear as broken-line asymptotic curves in Fig. 16.28, and their sum is shown as the solid curve. An equivalent representation is obtained if the curve is shifted upward by  $360^\circ$ .

Exact values can also be obtained for the asymptotic phase response. For example, at  $\omega = 10^4$  rad/s, the angle in Fig. 16.28 is obtained from the numerator and denominator terms in Eq. [29]. The numerator angle is  $-90^\circ$ . The angle for the pole at  $\omega = 10$  is  $-90^\circ$ , since  $\omega$  is greater than 10 times the corner frequency. Between 0.1 and 10 times the corner frequency, we recall that the slope is  $-45^\circ$  per decade for a simple pole. For the break point at 20,000 rad/s, we therefore calculate the angle,  $-45^\circ \log(\omega/0.1a) = -45^\circ \log[10,000/(0.1 \times 20,000)] = -31.5^\circ$ .

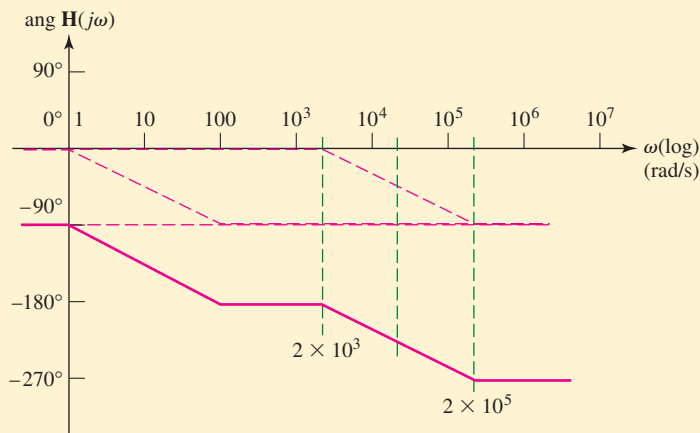

■ FIGURE 16.28 The solid curve displays the asymptotic phase response of the amplifier shown in Fig. 16.26.

The algebraic sum of these three contributions is  $-90^\circ - 90^\circ - 31.5^\circ = -211.5^\circ$ , a value that appears to be moderately near the asymptotic phase curve of Fig. 16.28.

## PRACTICE

16.14 Draw the Bode phase plot for  $\mathbf{H}(s)$  equal to (a)  $50/(s + 100)$ ; (b)  $(s + 10)/(s + 100)$ ; (c)  $(s + 10)/s$ .

Ans: (a)  $0^\circ, \omega < 10$ ;  $-45^\circ/\text{decade}, 10 < \omega < 1000$ ;  $-90^\circ, \omega > 1000$ ;  
 (b)  $0^\circ, \omega < 1$ ;  $+45^\circ/\text{decade}, 1 < \omega < 10$ ;  $45^\circ, 10 < \omega < 100$ ;  $-45^\circ/\text{decade}, 100 < \omega < 1000$ ;  $0^\circ, \omega > 1000$ ; (c)  $-90^\circ, \omega < 1$ ;  $+45^\circ/\text{decade}, 1 < \omega < 100$ ;  $0^\circ, \omega > 100$ .

## Higher-Order Terms

The zeros and poles that we have been considering are all first-order terms, such as  $s^{\pm 1}$ ,  $(1 + 0.2s)^{\pm 1}$ , and so forth. We may extend our analysis to higher-order poles and zeros very easily, however. A term  $s^{\pm n}$  yields a magnitude response that passes through  $\omega = 1$  with a slope of  $\pm 20n$  dB/decade; the phase response is a constant angle of  $\pm 90n^\circ$ . Also, a multiple zero,  $(1 + s/a)^n$ , must represent the sum of  $n$  of the magnitude-response curves, or  $n$  of the phase-response curves of the simple zero. We therefore obtain an asymptotic magnitude plot that is 0 dB for  $\omega < a$  and has a slope of  $20n$  dB/decade when  $\omega > a$ ; the error is  $-3n$  dB at  $\omega = a$ , and  $-n$  dB at  $\omega = 0.5a$  and  $2a$ . The phase plot is  $0^\circ$  for  $\omega < 0.1a$ ,  $90n^\circ$  for  $\omega > 10a$ ,  $45n^\circ$  at  $\omega = a$ , and a straight line with a slope of  $45n^\circ/\text{decade}$  for  $0.1a < \omega < 10a$ , and it has errors as large as  $\pm 5.71n^\circ$  at two frequencies.

The asymptotic magnitude and phase curves associated with a factor such as  $(1 + s/20)^{-3}$  may be drawn quickly, but the relatively large errors associated with the higher powers should be kept in mind.



## Complex Conjugate Pairs

The last type of factor we should consider represents a conjugate complex pair of poles or zeros. We adopt the following as the standard form for a pair of zeros:

$$\mathbf{H}(s) = 1 + 2\zeta \left( \frac{s}{\omega_0} \right) + \left( \frac{s}{\omega_0} \right)^2$$

The quantity  $\zeta$  is the damping factor introduced in Sec. 16.1, and we will see shortly that  $\omega_0$  is the corner frequency of the asymptotic response.

If  $\zeta = 1$ , we see that  $\mathbf{H}(s) = 1 + 2(s/\omega_0) + (s/\omega_0)^2 = (1 + s/\omega_0)^2$ , a second-order zero such as we have just considered. If  $\zeta > 1$ , then  $\mathbf{H}(s)$  may be factored to show two simple zeros. Thus, if  $\zeta = 1.25$ , then  $\mathbf{H}(s) = 1 + 2.5(s/\omega_0) + (s/\omega_0)^2 = (1 + s/2\omega_0)(1 + s/0.5\omega_0)$ , and we again have a familiar situation.

A new case arises when  $0 \leq \zeta \leq 1$ . There is no need to find values for the conjugate complex pair of roots. Instead, we determine the low- and high-frequency asymptotic values for both the magnitude and phase response, and then apply a correction that depends on the value of  $\zeta$ .

For the magnitude response, we have

$$H_{\text{dB}} = 20 \log |\mathbf{H}(j\omega)| = 20 \log \left| 1 + j2\zeta \left( \frac{\omega}{\omega_0} \right) - \left( \frac{\omega}{\omega_0} \right)^2 \right| \quad [30]$$

When  $\omega \ll \omega_0$ ,  $\mathbf{H}_{\text{dB}} = 20 \log |1| = 0$  dB. This is the low-frequency asymptote. Next, if  $\omega \gg \omega_0$ , only the squared term is important, and  $\mathbf{H}_{\text{dB}} = 20 \log |-(\omega/\omega_0)^2| = 40 \log(\omega/\omega_0)$ . We have a slope of +40 dB/decade. This is the high-frequency asymptote, and the two asymptotes intersect at 0 dB,  $\omega = \omega_0$ . The solid curve in Fig. 16.29 shows this asymptotic representation of the magnitude response. However, a correction must be applied

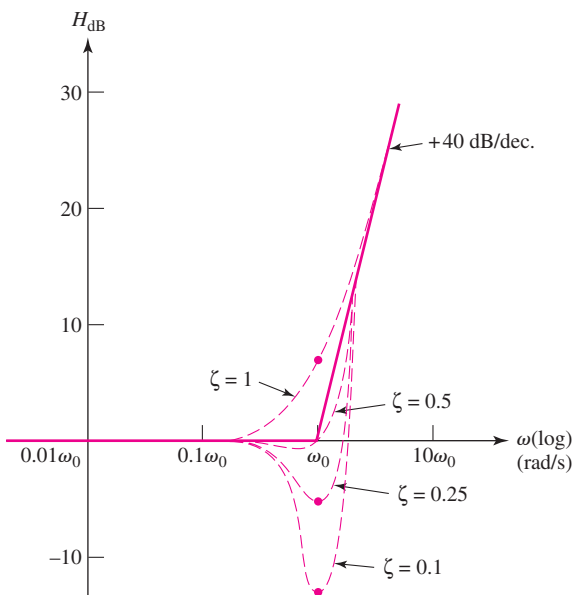

■ FIGURE 16.29 Bode amplitude plots are shown for  $\mathbf{H}(s) = 1 + 2\zeta(s/\omega_0) + (s/\omega_0)^2$  for several values of the damping factor  $\zeta$ .

in the neighborhood of the corner frequency. We let  $\omega = \omega_0$  in Eq. [30] and have

$$H_{\text{dB}} = 20 \log \left| j2\zeta \left( \frac{\omega}{\omega_0} \right) \right| = 20 \log(2\zeta) \quad [31]$$

If  $\zeta = 1$ , a limiting case, the correction is +6 dB; for  $\zeta = 0.5$ , no correction is required; and if  $\zeta = 0.1$ , the correction is -14 dB. Knowing this one correction value is often sufficient to draw a satisfactory asymptotic magnitude response. Figure 16.29 shows more accurate curves for  $\zeta = 1, 0.5, 0.25,$  and  $0.1$ , as calculated from Eq. [30]. For example, if  $\zeta = 0.25$ , then the exact value of  $H_{\text{dB}}$  at  $\omega = 0.5\omega_0$  is

$$H_{\text{dB}} = 20 \log |1 + j0.25 - 0.25| = 20 \log \sqrt{0.75^2 + 0.25^2} = -2.0 \text{ dB}$$

The negative peaks do not show a minimum value exactly at  $\omega = \omega_0$ , as we can see by the curve for  $\zeta = 0.5$ . The valley is always found at a slightly lower frequency.

If  $\zeta = 0$ , then  $\mathbf{H}(j\omega_0) = 0$  and  $H_{\text{dB}} = -\infty$ . Bode plots are not usually drawn for this situation.

Our last task is to draw the asymptotic phase response for  $\mathbf{H}(j\omega) = 1 + j2\zeta(\omega/\omega_0) - (\omega/\omega_0)^2$ . Below  $\omega = 0.1\omega_0$ , we let  $\text{ang } \mathbf{H}(j\omega) = 0^\circ$ ; above  $\omega = 10\omega_0$ , we have  $\text{ang } \mathbf{H}(j\omega) = \text{ang } [-(\omega/\omega_0)^2] = 180^\circ$ . At the corner frequency,  $\text{ang } \mathbf{H}(j\omega_0) = \text{ang } (j2\zeta) = 90^\circ$ . In the interval  $0.1\omega_0 < \omega < 10\omega_0$ , we begin with the straight line shown as a solid curve in Fig. 16.30. It extends from  $(0.1\omega_0, 0^\circ)$ , through  $(\omega_0, 90^\circ)$ , and terminates at  $(10\omega_0, 180^\circ)$ ; it has a slope of  $90^\circ/\text{decade}$ .

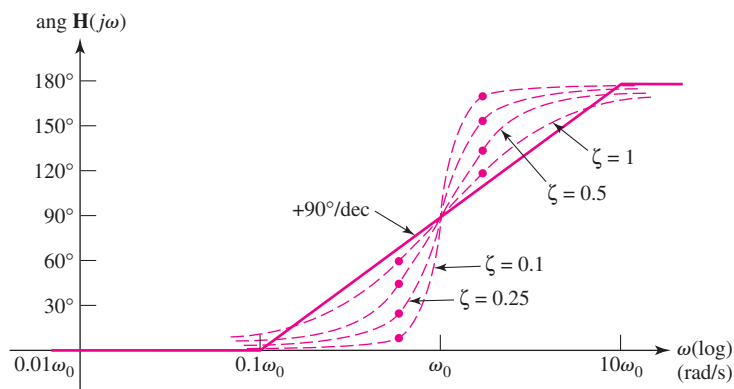

■ FIGURE 16.30 The straight-line approximation to the phase characteristic for  $\mathbf{H}(j\omega) = 1 + j2\zeta(\omega/\omega_0) - (\omega/\omega_0)^2$  is shown as a solid curve, and the true phase response is shown for  $\zeta = 1, 0.5, 0.25,$  and  $0.1$  as broken lines.

We must now provide some correction to this basic curve for various values of  $\zeta$ . From Eq. [30], we have

$$\text{ang } \mathbf{H}(j\omega) = \tan^{-1} \frac{2\zeta(\omega/\omega_0)}{1 - (\omega/\omega_0)^2}$$

One accurate value above and one below  $\omega = \omega_0$  may be sufficient to give an approximate shape to the curve. If we take  $\omega = 0.5\omega_0$ , we find  $\text{ang } \mathbf{H}(j0.5\omega_0) = \tan^{-1}(4\zeta/3)$ , while the angle is  $180^\circ - \tan^{-1}(4\zeta/3)$  at

$\omega = 2\omega_0$ . Phase curves are shown as broken lines in Fig. 16.30 for  $\zeta = 1, 0.5, 0.25,$  and  $0.1$ ; heavy dots identify accurate values at  $\omega = 0.5\omega_0$  and  $\omega = 2\omega_0$ .

If the quadratic factor appears in the denominator, both the magnitude and phase curves are the *negatives* of those just discussed. We conclude with an example that contains both linear and quadratic factors.

### EXAMPLE 16.10

**Construct the Bode plot for the transfer function  $H(s) = 100,000s/[(s + 1)(10,000 + 20s + s^2)]$ .**

Let's consider the quadratic factor first and arrange it in a form such that we can see the value of  $\zeta$ . We begin by dividing the second-order factor by its constant term, 10,000:

$$H(s) = \frac{10s}{(1 + s)(1 + 0.002s + 0.0001s^2)}$$

An inspection of the  $s^2$  term next shows that  $\omega_0 = \sqrt{1/0.0001} = 100$ . Then the linear term of the quadratic is written to display the factor 2, the factor  $(s/\omega_0)$ , and finally the factor  $\zeta$ :

$$H(s) = \frac{10s}{(1 + s)[1 + (2)(0.1)(s/100) + (s/100)^2]}$$

We see that  $\zeta = 0.1$ .

The asymptotes of the magnitude-response curve are sketched in lightly in Fig. 16.31: 20 dB for the factor of 10, an infinite straight line through  $\omega = 1$  with a +20 dB/decade slope for the  $s$  factor, a corner at  $\omega = 1$  for the simple pole, and a corner at  $\omega = 100$  with a slope of  $-40$  dB/decade for the second-order term in the denominator. Adding these four curves and supplying a correction of +14 dB for the quadratic factor lead to the heavy curve of Fig. 16.31.

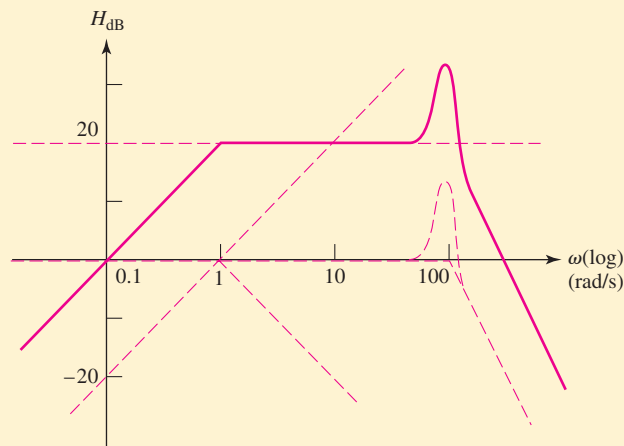

■ FIGURE 16.31 The Bode magnitude plot of the transfer function

$$H(s) = \frac{100,000s}{(s + 1)(10,000 + 20s + s^2)}$$

The phase response contains three components:  $+90^\circ$  for the factor  $s$ ;  $0^\circ$  for  $\omega < 0.1$ ,  $-90^\circ$  for  $\omega > 10$ , and  $-45^\circ/\text{decade}$  for the simple pole; and  $0^\circ$  for  $\omega < 10$ ,  $-180^\circ$  for  $\omega > 1000$ , and  $-90^\circ$  per decade for

the quadratic factor. The addition of these three asymptotes plus some improvement for  $\zeta = 0.1$  is shown as the solid curve in Fig. 16.32.

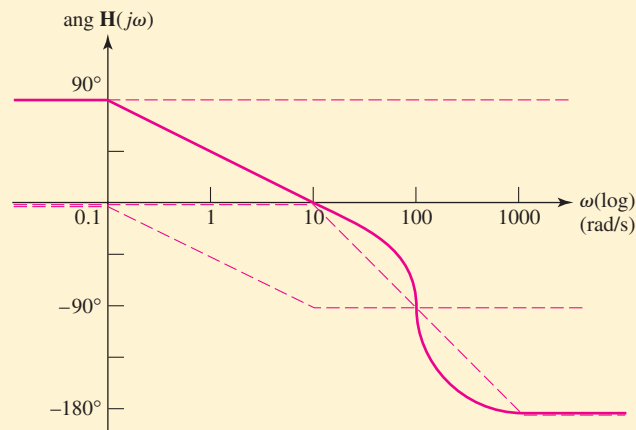

■ FIGURE 16.32 The Bode phase plot of the transfer function

$$H(s) = \frac{100,000s}{(s+1)(10,000 + 20s + s^2)}$$

### PRACTICE

16.15 If  $H(s) = 1000s^2/(s^2 + 5s + 100)$ , sketch the Bode amplitude plot and calculate a value for (a)  $\omega$  when  $H_{dB} = 0$ ; (b)  $H_{dB}$  at  $\omega = 1$ ; (c)  $H_{dB}$  as  $\omega \rightarrow \infty$ .

Ans: 0.316 rad/s; 20 dB; 60 dB.

## COMPUTER-AIDED ANALYSIS

The technique of generating Bode plots is a valuable one. There are many situations in which an approximate diagram is needed quickly (such as on exams, or when evaluating a particular circuit topology for a specific application), and simply knowing the general shape of the response is adequate. Further, Bode plots can be invaluable when designing filters in terms of enabling us to select factors and coefficient values.

In situations where *exact* response curves are required (such as when verifying a final circuit design), there are several computer-assisted options available to the engineer. The first technique we will consider here is the use of MATLAB to generate a frequency response curve. In order to accomplish this, the circuit must first be analyzed to obtain the correct transfer function. However, it is not necessary to factor or simplify the expression.

Consider the circuit in Fig. 16.26. We previously determined that the transfer function for this circuit can be expressed as

$$H(s) = \frac{-2s}{(1 + s/10)(1 + s/20,000)}$$

(Continued on next page)

We seek a detailed graph of this function over the frequency range of 100 mrad/s to 1 Mrad/s. Since the final graph will be plotted on a logarithmic scale, there is no need to uniformly space our discrete frequencies. Instead, we use the MATLAB function `logspace()` to generate a frequency vector, where the first two arguments represent the power of 10 for starting and ending frequencies, respectively (–1 and 6 in the present example), and the third argument is the total number of points desired. Thus, our MATLAB script is

```
EDU» w = logspace(-1,6,100);
EDU» denom = (1+j*w/10) .* (1+j*w/20000);
EDU» H = -2*j*w ./ denom;
EDU» Hdb = 20*log10(abs(H));
EDU» semilogx(w,Hdb)
EDU» xlabel('frequency (rad/s)')
EDU» ylabel ('|H(jw)| (dB)')
```

which yields the graph depicted in Fig. 16.33.

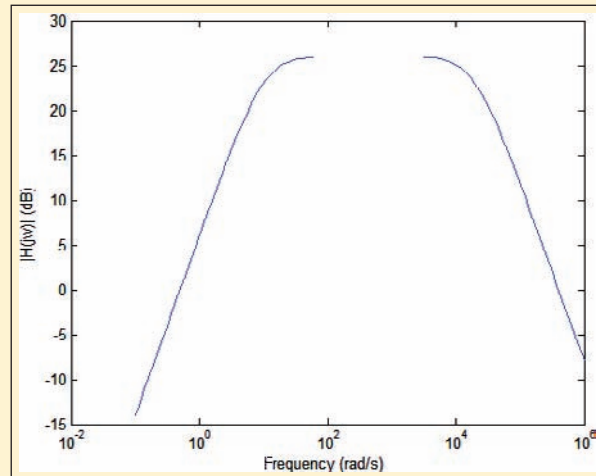

■ FIGURE 16.33 Plot of  $H_{dB}$  generated using MATLAB.

A few comments about the MATLAB code are warranted. First, note that we have substituted  $s = j\omega$  in our expression for  $\mathbf{H}(s)$ . Also, MATLAB treats the variable  $w$  as a vector, or one-dimensional matrix. As such, this variable can cause difficulties in the denominator of an expression as MATLAB will attempt to apply matrix algebra rules to any expression. Thus, the denominator of  $\mathbf{H}(j\omega)$  is computed in a separate line, and the operator “`.*`” is required instead of “`*`” to multiply the two terms. This new operator is equivalent to the following MATLAB code:

```
EDU» for k = 1:100
    denom = (1 + j*w(k)/10) * (1 + j*w(k)/20000);
end
```

In a similar fashion, the new operator “`./`” is used in the subsequent line of code. The results are desired in dB, so the function `log10()` is



invoked;  $\log()$  represents the natural logarithm in MATLAB. Finally, the new plot command  $\text{semilogx}()$  is used to generate a graph with the  $x$  axis having a logarithmic scale. The reader is encouraged at this point to return to previous examples, and use these techniques to generate exact curves for comparison to the corresponding Bode plots.

PSpice is also commonly used to generate frequency response curves, especially to evaluate a final design. Figure 16.34a depicts the circuit of Fig. 16.26, where the voltage across the resistor R3 represents the desired output voltage. The source component VAC has been

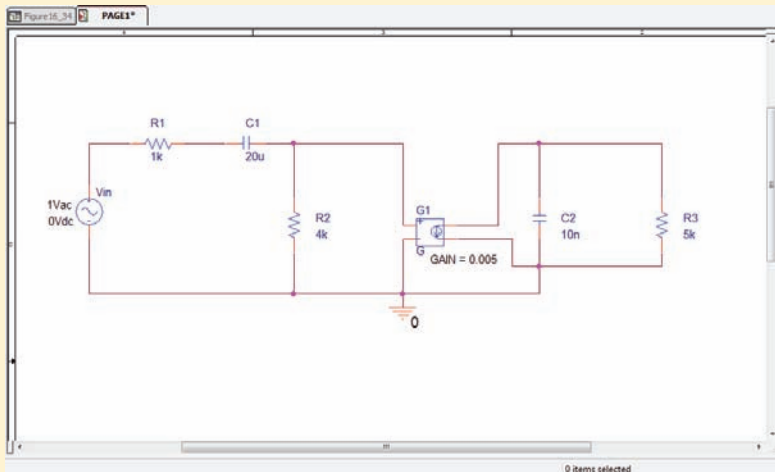

(a)

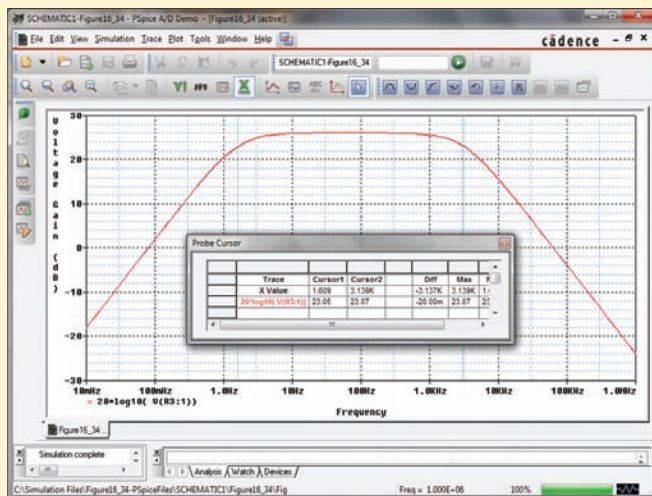

(b)

■ FIGURE 16.34 (a) The circuit of Fig. 16.26. (b) Frequency response of the circuit plotted in dB scale.

(Continued on next page)

employed with a fixed voltage of 1 V for convenience. An ac sweep simulation is required to determine the frequency response of our circuit; Fig. 16.34b was generated using 10 points per decade (with Decade selected under **Logarithmic AC Sweep Type**) from 10 mHz to 1 MHz. Note the simulation has been performed in Hz, not rad/s, so the cursor tool is indicating a bandwidth of 3.137 kHz.

Again, the reader is encouraged to simulate example circuits and compare the results to the Bode plots generated previously.

## 16.7 BASIC FILTER DESIGN

The design of filters is a very practical (and interesting) subject, worthy of a separate textbook in its own right. In this section, we introduce some of the basic concepts of filtering, and explore both passive and active filter circuits. These circuits may be very simple, consisting of a single capacitor or inductor whose addition to a given network leads to improved performance. They may also be fairly sophisticated, consisting of many resistors, capacitors, inductors, and op amps in order to obtain the precise response curve required

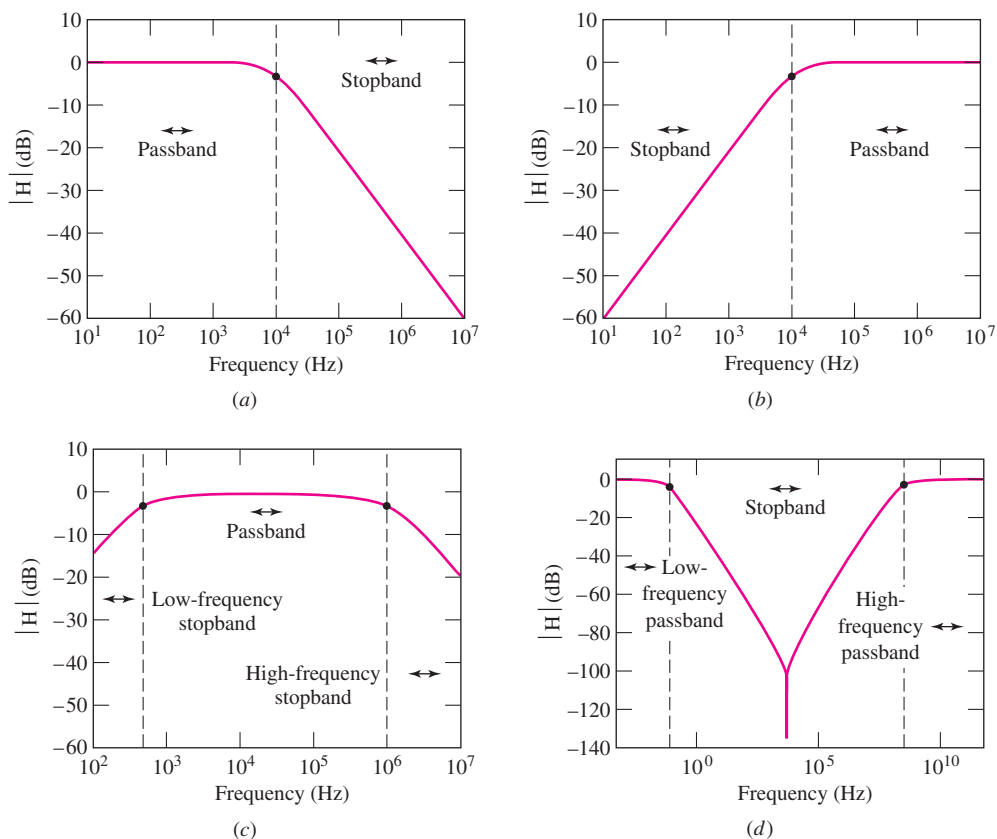

■ FIGURE 16.35 Frequency response curves for (a) a low-pass filter; (b) a high-pass filter; (c) a bandpass filter; (d) a bandstop filter. In each diagram, a solid dot corresponds to  $-3$  dB.

for a given application. Filters are used in modern electronics to obtain dc voltages in power supplies, eliminate noise in communication channels, separate radio and television channels from the multiplexed signal provided by antennas, and boost the bass signal in a car stereo, to name just a few applications.

The underlying concept of a filter is that it selects the frequencies that may pass through a network. There are several varieties, depending on the needs of a particular application. A **low-pass filter**, the response of which is illustrated in Fig. 16.35a, passes frequencies below a cutoff frequency, while significantly damping frequencies above that cutoff. A **high-pass filter**, on the other hand, does just the opposite, as shown in Fig. 16.35b. The chief figure of merit of a filter is the sharpness of the cutoff, or the steepness of the curve in the vicinity of the corner frequency. In general, steeper response curves require more complex circuits.

Combining a low-pass and a high-pass filter can lead to what is known as a **bandpass filter**, as illustrated by the response curve shown in Fig. 16.35c. In this type of filter, the region between the two corner frequencies is referred to as the **passband**; the region outside the passband is referred to as the **stopband**. These terms may also be applied to the low- and high-pass filters, as indicated in Fig. 16.35a and b. We can also create a **bandstop filter**, which allows both high and low frequencies to pass but attenuates any signal with a frequency between the two corner frequencies (Fig. 16.35d).

The **notch filter** is a specialized bandstop filter, designed with a narrow response characteristic that blocks a single frequency component of a signal. **Multiband filters** are also possible; these are filter circuits which have multiple passbands and stopbands. The design of such filters is straightforward, but beyond the range of this book.

## Passive Low-Pass and High-Pass Filters

A filter can be constructed by simply using a single capacitor and a single resistor, as shown in Fig. 16.36a. The transfer function for this low-pass filter circuit is

$$\mathbf{H}(s) \equiv \frac{V_{\text{out}}}{V_{\text{in}}} = \frac{1}{1 + RCs} \quad [32]$$

$\mathbf{H}(s)$  has a single corner frequency, which occurs at  $\omega = 1/RC$ , and a zero at  $s = \infty$ , leading to its “low-pass” filtering behavior. Low frequencies ( $s \rightarrow 0$ ) result in  $|\mathbf{H}(s)|$  near its maximum value (unity, or 0 dB), and high frequencies ( $s \rightarrow \infty$ ) result in  $|\mathbf{H}(s)| \rightarrow 0$ . This behavior can be understood qualitatively by considering the impedance of the capacitor: as the frequency increases, the capacitor begins to act like a short-circuit to ac signals, leading to a reduction in the output voltage. An example response curve for such a filter with  $R = 500 \Omega$  and  $C = 2 \text{ nF}$  is shown in Fig. 16.36b; the corner frequency of 159 kHz (1 Mrad/s) can be found by moving the cursor to  $-3 \text{ dB}$ . The sharpness of the response curve in the vicinity of the cutoff frequency can be improved by moving to a circuit containing additional reactive (i.e., capacitive and/or inductive) elements.

A high-pass filter can be constructed by simply swapping the locations of the resistor and capacitor in Fig. 16.36a, as we see in the next example.

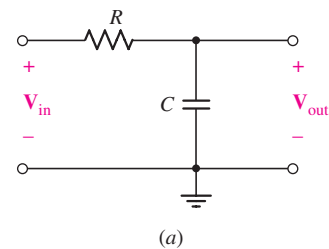

(a)

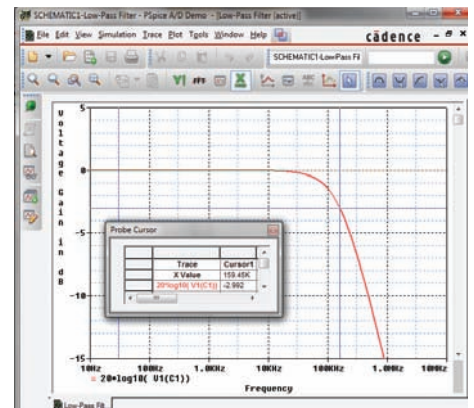

(b)

■ FIGURE 16.36 (a) A simple low-pass RC filter. (b) Simulated frequency response for  $R = 500 \Omega$  and  $C = 2 \text{ nF}$ , showing a corner frequency at 159 kHz.

## EXAMPLE 16.11

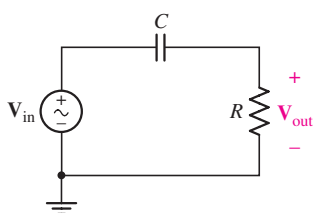

■ FIGURE 16.37 A simple high-pass filter circuit, for which values for  $R$  and  $C$  must be selected to obtain a cutoff frequency of 3 kHz.

## Design a high-pass filter with a corner frequency of 3 kHz.

We begin by selecting a circuit topology. Since no requirements as to the sharpness of the response are given, we choose the simple circuit of Fig. 16.37.

The transfer function of this circuit is easily found to be

$$\mathbf{H}(s) \equiv \frac{\mathbf{V}_{\text{out}}}{\mathbf{V}_{\text{in}}} = \frac{RCs}{1 + RCs}$$

which has a zero at  $s = 0$  and a pole at  $s = -1/RC$ , leading to “high-pass” filter behavior (i.e.,  $|\mathbf{H}| \rightarrow 0$  as  $\omega \rightarrow \infty$ ).

The corner frequency of the filter circuit is  $\omega_c = 1/RC$ , and we seek a value of  $\omega_c = 2\pi f_c = 2\pi(3000) = 18.85$  krad/s. Again, we must select a value for either  $R$  or  $C$ . In practice, our decision would most likely be based on the values of resistors and capacitors at hand, but since no such information has been provided here, we are free to make arbitrary choices.

We therefore choose the standard resistor value 4.7 k $\Omega$  for  $R$ , leading to a requirement of  $C = 11.29$  nF.

The only remaining step is to verify our design with a PSpice simulation; the predicted frequency response curve is shown in Fig. 16.38.

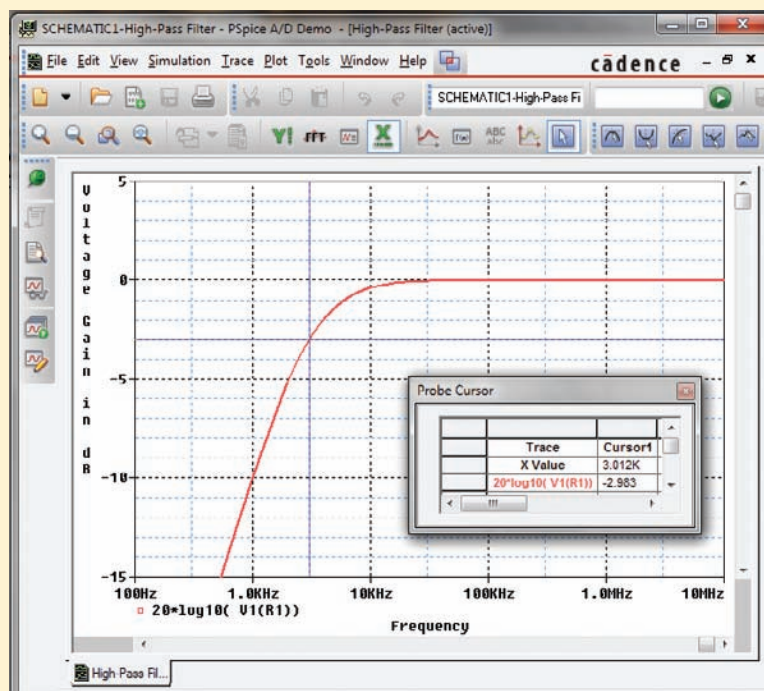

■ FIGURE 16.38 Simulated frequency response of the final filter design, showing a cutoff (3 dB frequency) of 3 kHz as expected.

## PRACTICE

16.16 Design a high-pass filter with a cutoff frequency of 13.56 MHz, a common RF power supply frequency. Verify your design using PSpice.

## Bandpass Filters

We have already seen several circuits earlier in this chapter which could be classified as “bandpass” filters (e.g., Figs. 16.1 and 16.8). Consider the simple circuit of Fig. 16.39, in which the output is taken across the resistor. The transfer function of this circuit is easily found to be

$$\mathbf{A}_V = \frac{sRC}{LCs^2 + RCs + 1} \quad [33]$$

The magnitude of this function is (after a few algebraic maneuvers)

$$|\mathbf{A}_V| = \frac{\omega RC}{\sqrt{(1 - \omega^2 LC)^2 + \omega^2 R^2 C^2}} \quad [34]$$

which, in the limit of  $\omega \rightarrow 0$ , becomes

$$|\mathbf{A}_V| \approx \omega RC \rightarrow 0$$

and in the limit of  $\omega \rightarrow \infty$  becomes

$$|\mathbf{A}_V| \approx \frac{R}{\omega L} \rightarrow 0$$

We know from our experience with Bode plots that Eq. [33] represents three critical frequencies: one zero and two poles. In order to obtain a bandpass filter response with a peak value of unity (0 dB), both pole frequencies must be greater than 1 rad/s, the 0 dB crossover frequency of the zero term. These two critical frequencies can be obtained by factoring Eq. [33] or determining the values of  $\omega$  at which Eq. [34] is equal to  $1/\sqrt{2}$ . The center frequency of this filter then occurs at  $\omega = 1/\sqrt{LC}$ . Thus, applying a minor amount of algebraic manipulation after setting Eq. [34] equal to  $1/\sqrt{2}$ , we find that

$$(1 - LC\omega_c^2)^2 = \omega_c^2 R^2 C^2 \quad [35]$$

Taking the square root of both sides yields

$$LC\omega_c^2 + RC\omega_c - 1 = 0$$

Applying the quadratic equation, we find that

$$\omega_c = -\frac{R}{2L} \pm \frac{\sqrt{R^2 C^2 + 4LC}}{2LC} \quad [36]$$

Negative frequency is a nonphysical solution to our original equation, and so only the positive radicand of Eq. [36] is applicable. However, we may have been a little too hasty in taking the positive square root of both sides of Eq. [35]. Considering the negative square root as well, which is equally valid, we also obtain

$$\omega_c = \frac{R}{2L} \pm \frac{\sqrt{R^2 C^2 + 4LC}}{2LC} \quad [37]$$

from which it can be shown that only the positive radicand is physical. Thus, we obtain  $\omega_L$  from Eq. [36] and  $\omega_H$  from Eq. [37]; since  $\omega_H - \omega_L = B$ , simple algebra shows that  $B = R/L$ .

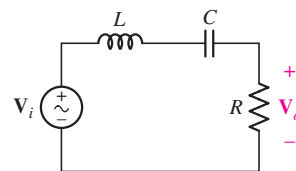

FIGURE 16.39 A simple bandpass filter, constructed using a series  $RLC$  circuit.

## EXAMPLE 16.12

**Design a bandpass filter characterized by a bandwidth of 1 MHz and a high-frequency cutoff of 1.1 MHz.**

We choose the circuit topology of Fig. 16.39, and begin by determining the corner frequencies required. The bandwidth is given by  $f_H - f_L$ , so

$$f_L = 1.1 \times 10^6 - 1 \times 10^6 = 100 \text{ kHz}$$

and

$$\omega_L = 2\pi f_L = 628.3 \text{ krad/s}$$

The high-frequency cutoff ( $\omega_H$ ) is simply 6.912 Mrad/s.

In order to proceed to design a circuit with these characteristics, it is necessary to obtain an expression for each frequency in terms of the variables  $R$ ,  $L$ , and  $C$ .

Setting Eq. [37] equal to  $2\pi(1.1 \times 10^6)$  allows us to solve for  $1/LC$ , as we already know that  $B = 2\pi(f_H - f_L) = 6.283 \times 10^6$ .

$$\frac{1}{2}B + \left[ \frac{1}{4}B^2 + \frac{1}{LC} \right]^{1/2} = 2\pi(1.1 \times 10^6)$$

Solving, we find that  $1/LC = 4.343 \times 10^{12}$ . Arbitrarily selecting  $L = 50 \text{ mH}$ , we obtain  $R = 314 \text{ k}\Omega$  and  $C = 4.6 \text{ pF}$ . It should be noted that there is no unique solution for this “design” problem— $R$ ,  $L$ , or  $C$  can be selected as a starting point.

PSpice verification of our design is shown in Fig. 16.40.

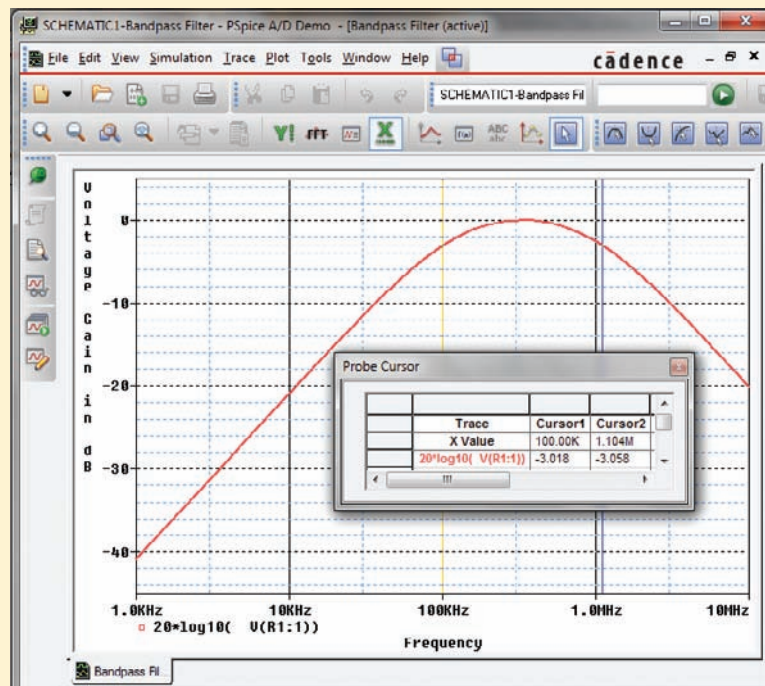

FIGURE 16.40 Simulated response of the bandpass filter design showing a bandwidth of 1 MHz and a high-frequency cutoff of 1.1 MHz as desired.

**PRACTICE**

16.17 Design a bandpass filter with a low-frequency cutoff of 100 rad/s and a high-frequency cutoff of 10 krad/s.

Ans: One possible answer of many:  $R = 990\ \Omega$ ,  $L = 100\ \text{mH}$ , and  $C = 10\ \mu\text{F}$ .

The type of circuit we have been considering is known as a *passive filter*, as it is constructed of only passive components (i.e., no transistors, op amps, or other “active” elements). Although passive filters are relatively common, they are not well suited to all applications. The gain (defined as the output voltage divided by the input voltage) of a passive filter can be difficult to set, and amplification is often desirable in filter circuits.

**Active Filters**

The use of an active element such as the op amp in filter design can overcome many of the shortcomings of passive filters. As we saw in Chap. 6, op amp circuits can easily be designed to provide gain. Op amp circuits can also exhibit inductorlike behavior through the strategic location of capacitors.

The internal circuitry of an op amp contains very small capacitances (typically on the order of 100 pF), and these limit the maximum frequency at which the op amp will function properly. Thus, any op amp circuit will behave as a low-pass filter, with a cutoff frequency for modern devices of perhaps 20 MHz or more (depending on the circuit gain).

**EXAMPLE 16.13**

**Design an active low-pass filter with a cutoff frequency of 10 kHz and a voltage gain of 40 dB.**

For frequencies much less than 10 kHz, we require an amplifier circuit capable of providing a gain of 40 dB, or 100 V/V. This can be accomplished by simply using a noninverting amplifier (such as the one shown in Fig. 16.41a) with

$$\frac{R_f}{R_1} + 1 = 100$$

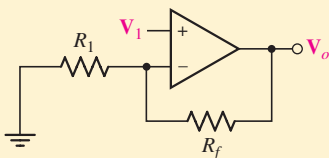

(a)

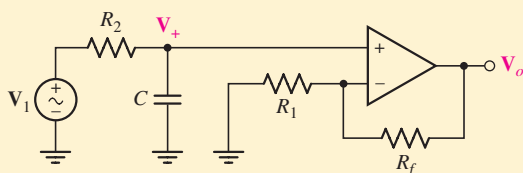

(b)

■ FIGURE 16.41 (a) A simple noninverting op amp circuit. (b) A low-pass filter consisting of a resistor  $R_2$  and a capacitor  $C$  has been added to the input.

(Continued on next page)

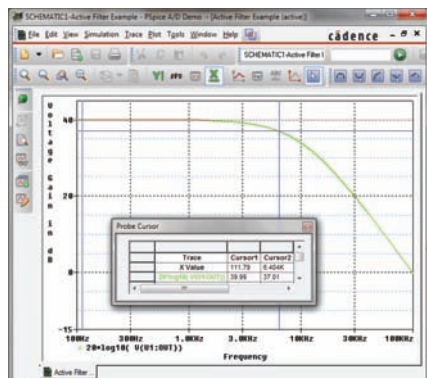

(a)

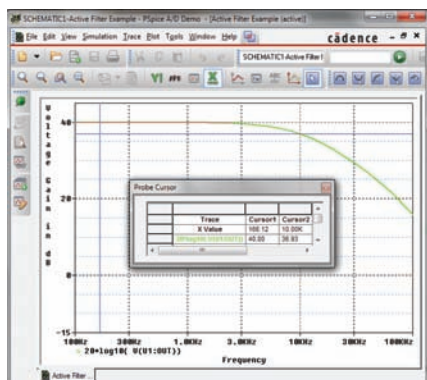

(b)

■ FIGURE 16.42 (a) Frequency response for filter circuit using a  $\mu\text{A}741$  op amp, showing a corner frequency of 6.4 kHz. (b) Frequency response of the same filter circuit, but using an LF411 op amp instead. The cutoff frequency for this circuit is 10 kHz, the desired value.

To provide a high-frequency corner at 10 kHz, we require a low-pass filter at the input to the op amp (as in Fig. 16.41b). To derive the transfer function, we begin at the noninverting input,

$$\mathbf{V}_+ = \mathbf{V}_i \frac{1/sC}{R_2 + 1/sC} = \mathbf{V}_i \frac{1}{1 + sR_2C}$$

At the inverting input we have

$$\frac{\mathbf{V}_o - \mathbf{V}_+}{R_f} = \frac{\mathbf{V}_+}{R_1}$$

Combining these two equations and solving for  $\mathbf{V}_o$ , we find that

$$\mathbf{V}_o = \mathbf{V}_i \left( \frac{1}{1 + sR_2C} \right) \left( 1 + \frac{R_f}{R_1} \right)$$

The maximum value of the gain  $\mathbf{A}_V = \mathbf{V}_o/\mathbf{V}_i$  is  $1 + R_f/R_1$ , so we set this quantity equal to 100. Since neither resistor appears in the expression for the corner frequency  $(R_2C)^{-1}$ , either may be selected first. We thus choose  $R_1 = 1 \text{ k}\Omega$ , so  $R_f = 99 \text{ k}\Omega$ .

Arbitrarily selecting  $C = 1 \mu\text{F}$ , we find that

$$R_2 = \frac{1}{2\pi(10 \times 10^3)C} = 15.9 \Omega$$

At this point, our design is complete. Or is it? The simulated frequency response of this circuit is shown in Fig. 16.42a.

It is readily apparent that our design does not in fact meet the 10 kHz cutoff specification. What did we do wrong? A careful check of our algebra does not yield any errors, so an erroneous assumption must have been made somewhere. The simulation was performed using a  $\mu\text{A}741$  op amp, as opposed to the ideal op amp assumed in the derivations. It turns out that this is the source of our discomfort—the same circuit with an LF411 op amp substituted for the  $\mu\text{A}741$  results in a cutoff frequency of 10 kHz as desired; the corresponding simulation result is shown in Fig. 16.42b.

Unfortunately, the  $\mu\text{A}741$  op amp with a gain of 40 dB has a corner frequency in the vicinity of 10 kHz, which cannot be neglected in this instance. The LF411, however, does not reach its first corner frequency until approximately 75 kHz, which is far enough away from 10 kHz that it does not affect our design.

## PRACTICE

16.18 Design a low-pass filter circuit with a gain of 30 dB and a cutoff frequency of 1 kHz.

Ans: One possible answer of many:  $R_1 = 100 \text{ k}\Omega$ ,  $R_f = 3.062 \text{ M}\Omega$ ,  $R_2 = 79.58 \Omega$ , and  $C = 2 \mu\text{F}$ .



# PRACTICAL APPLICATION

## Bass, Treble, and Midrange Adjustment

The ability to independently adjust the bass, treble, and midrange settings on a sound system is commonly desirable, even in the case of inexpensive equipment. The audio frequency range (at least for the human ear) is commonly accepted to be 20 Hz to 20 kHz, with bass corresponding to lower frequencies (< 500 Hz or so) and treble corresponding to higher frequencies (> 5 kHz or thereabouts).

Designing a simple graphic equalizer is a relatively straightforward endeavor, although a system such as that shown in Fig. 16.43 requires a bit more effort. In the bass, midrange, treble type equalizer common on many portable radios, the main signal (provided by the radio receiver circuit, or perhaps a CD player) consists of a wide spectrum of frequencies having a bandwidth of approximately 20 kHz.



FIGURE 16.43 An example of a graphic equalizer. Courtesy of Alesis.

This signal must be sent to three different op amp circuits, each with a different filter at the input. The bass adjustment circuit will require a low-pass filter, the treble adjustment circuit will require a high-pass filter, and the midrange adjustment circuit requires a bandpass filter. The output of each op amp circuit is then fed into a summing amplifier circuit; a block diagram of the complete circuit is shown in Fig. 16.44.

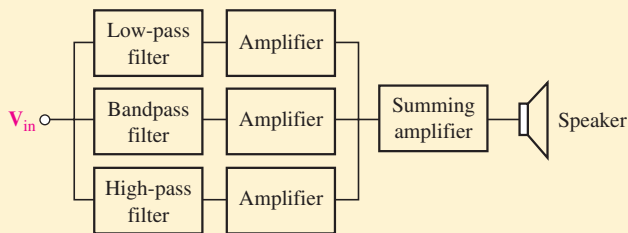

FIGURE 16.44 Block diagram of a simple graphic equalizer circuit.

Our basic building block is shown in Fig. 16.45. This circuit consists of a noninverting op amp circuit characterized by a voltage gain of  $1 + R_f/R_1$ , and a simple low-pass filter composed of a resistor  $R_2$  and a capacitor  $C$ . The feedback resistor  $R_f$  is a variable resistor (sometimes referred to as a *potentiometer*), and allows the gain to be varied through the rotation of a knob; the layperson

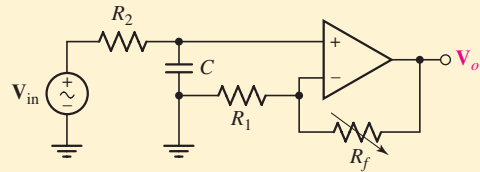

FIGURE 16.45 The bass adjustment section of the amplifier circuit.

would call this resistor the volume control. The low-pass filter network restricts the frequencies that will enter the op amp and hence be amplified; the corner frequency is simply  $(R_2C)^{-1}$ . If the circuit designer needs to allow the user to also select the break frequency for the filter,  $R_2$  may be replaced by a potentiometer, or, alternatively,  $C$  could be replaced by a variable capacitor. The remaining stages are constructed in essentially the same way, but with a different filter network at the input.

In order to keep the resistors, capacitors, and op amps separate, we should add an appropriate subscript to each as an indication of the stage to which it belongs ( $t, m, b$ ). Beginning with the treble stage, we have already encountered problems in using the  $\mu A741$  in the 10 to 20 kHz range at high gain, so perhaps the LF411 is a better choice here as well. Selecting a treble cutoff frequency of 5 kHz (there is some variation among values selected by different audio circuit designers), we require

$$\frac{1}{R_{2t}C_t} = 2\pi(5 \times 10^3) = 3.142 \times 10^4$$

Arbitrarily selecting  $C_t = 1 \mu\text{F}$  results in a required value of  $31.83 \Omega$  for  $R_{2t}$ . Selecting  $C_b = 1 \mu\text{F}$  as well (perhaps we can negotiate a quantity discount), we need  $R_{2b} = 318.3 \Omega$  for a bass cutoff frequency of 500 Hz. We leave the design of a suitable bandpass filter for the reader.

The next part of our design is to choose suitable values for  $R_{1t}$  and  $R_{1b}$ , as well as the corresponding feedback resistors. Without any instructions to the contrary, it is probably simplest to make both stages identical. Therefore, we arbitrarily select both  $R_{1t}$  and  $R_{1b}$  as 1 k $\Omega$ , and  $R_{ft}$  and  $R_{fb}$  as 10 k $\Omega$  potentiometers (meaning that the range will be from 0 to 10 k $\Omega$ ). This allows the volume of one signal to be up to 11 times louder than the other. In case we need our design to be portable, we select  $\pm 9$  V supply voltages, although this can be easily changed if needed.

(Continued on next page)

Now that the design of the filter stage is complete, we are ready to consider the design of the summing stage. For the sake of simplicity, we should power this op amp stage with the same voltage sources as the other stages, which limits the maximum output voltage magnitude to less than 9 V. We use an inverting op amp configuration, with the output of each of the filter op amp stages fed directly into its own 1 k $\Omega$  resistor. The other terminal of

each 1 k $\Omega$  resistor is then connected to the inverting input of the summing amplifier stage. The appropriate potentiometer for the summing amplifier stage must be selected in order to prevent saturation, so that knowledge of both the input voltage range and the output speaker wattage is required. A limited simulation of the final design is shown in Fig. 16.46.

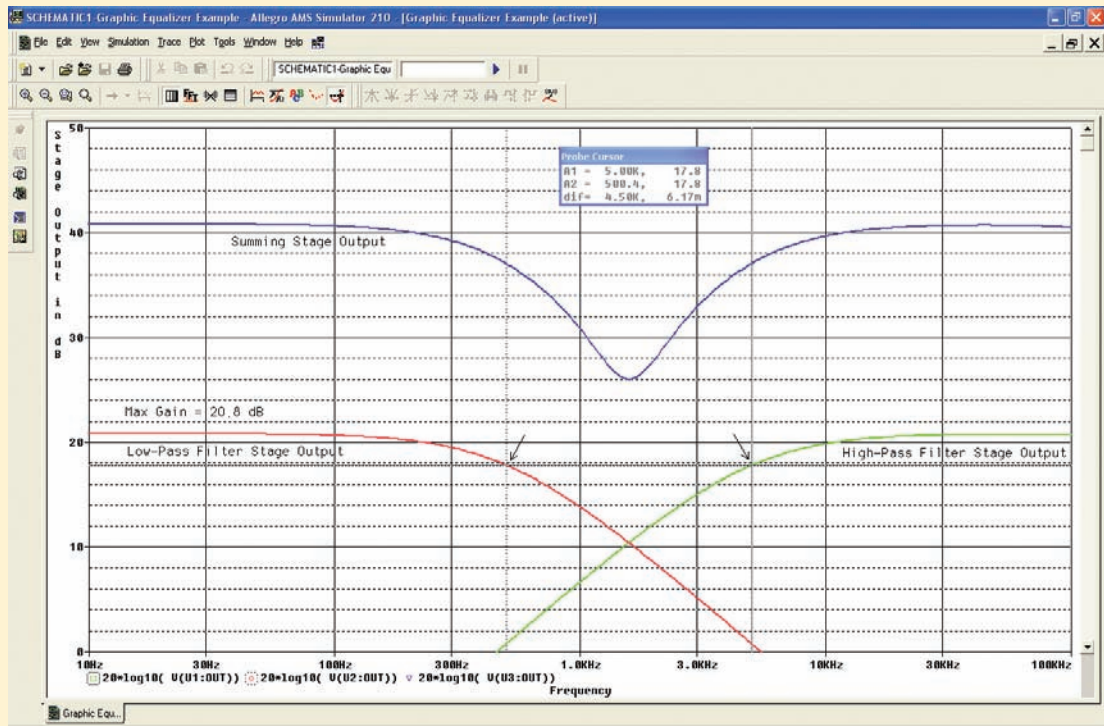

■ FIGURE 16.46 Simulated frequency response of the equalizer design.

## 16.8 • ADVANCED FILTER DESIGN

Although the basic filters we have encountered so far function adequately for a number of applications, their characteristics are far from an ideal “step-function-like” magnitude response. Fortunately, we have alternatives—known as higher-order filters—with improved behavior, at the cost of increased complexity and more components. For example, the general low-pass filter transfer function of order  $n$  may be written as

$$N(s) = \frac{K a_0}{s^n + a_{n-1}s^{n-1} + \cdots + a_1s + a_0}$$

and that of the general high-pass filter (of order  $n$ ) is only subtly different:

$$N(s) = \frac{K s^n}{s^n + a_{n-1}s^{n-1} + \cdots + a_1s + a_0}$$

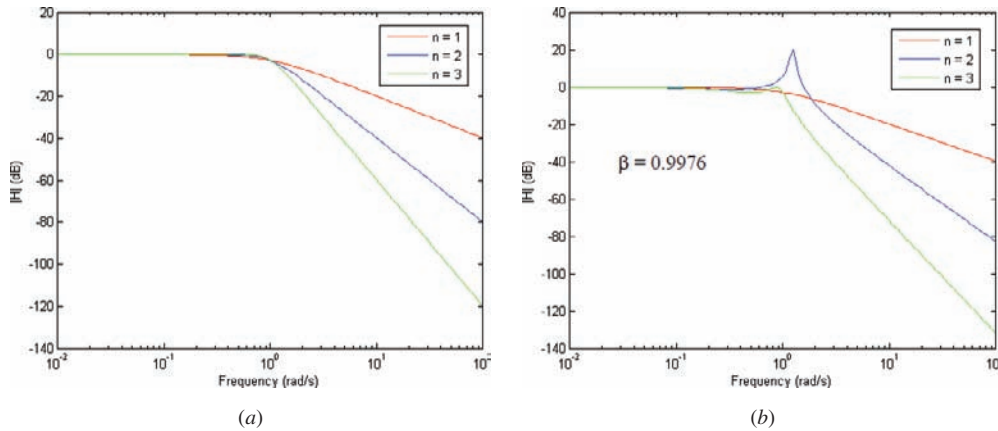

■ FIGURE 16.47 Plot of  $|H(j\omega)|$  for first-, second-, and third-order low-pass (a) Butterworth filters and (b) Chebyshev filters. All filters were normalized to a corner frequency of 1 rad/s.

To represent a bandpass filter, we need only alter the numerator to  $Ks^{n/2}$ , and the band-reject filter (shown in Fig. 16.35d) has the transfer function

$$N(s) = \frac{K(s^2 + \omega_0^2)^{n/2}}{s^n + a_{n-1}s^{n-1} + \cdots + a_1s + a_0}$$

Design of a specific filter, then, requires selecting the appropriate transfer function, and choosing a class of polynomials which specify the coefficients  $a_1, a_2$ , etc. In this section, we introduce filters based on **Butterworth** and **Chebyshev polynomials**, two of the most commonly employed in filter design.

The low-pass Butterworth filter is one of the best-known filters. It is characterized by an amplitude magnitude

$$|H(j\omega)| = \frac{K}{\sqrt{1 + (\omega/\omega_c)^{2n}}} \quad n = 1, 2, 3, \dots$$

which is sketched in Fig. 16.47a for  $n = 1, 2, 3$ , and 5;  $K$  is a real constant, and  $\omega_c$  represents the critical frequency. As can be seen, the magnitude approaches a step-function-like shape as the order  $n$  increases. In contrast, the low-pass Chebyshev filter is characterized by rather prominent ripples in the passband, the number of which depends upon the order of the filter as illustrated in Fig. 16.47b. Its magnitude response is described by

$$|H(j\omega)| = \frac{K}{\sqrt{1 + \beta^2 C_n^2(\omega/\omega_c)}} \quad n = 1, 2, 3, \dots$$

where  $\beta$  is a real constant known as the **ripple factor** and  $C_n(\omega/\omega_c)$  denotes the Chebyshev polynomial of the first kind of degree  $n$ . For convenience, selected coefficients of both polynomial types are listed in Table 16.2.

## The Sallen-Key Amplifier

As seen in Sec. 15.8, we may create an op-amp-based filter circuit having a double pole simply by cascading two circuits such as the one shown in Fig. 15.49a, in which case we obtain a transfer function

$$H(s) = \frac{(1/R_1 C_f)^2}{s^2 + 2/R_f C_f + (1/R_f C_f)^2} \quad [36]$$

TABLE 16.2 Coefficients for Low-Pass Butterworth and Chebyshev ( $\beta = 0.9976$ , or 3 dB) Filter Functions, Normalized to  $\omega_c = 1$

Butterworth					
$n$	$a_0$	$a_1$	$a_2$	$a_3$	$a_4$
1	1.0000				
2	1.0000	1.4142			
3	1.0000	2.0000	2.0000		
4	1.0000	2.6131	3.4142	2.6131	
5	1.0000	3.2361	5.2361	5.2361	3.2361
Chebyshev ( $\beta = 0.9976$ )					
$n$	$a_0$	$a_1$	$a_2$	$a_3$	$a_4$
1	1.0024				
2	0.7080	0.6449			
3	0.2506	0.9284	0.5972		
4	0.1770	0.4048	1.1691	0.5816	
5	0.0626	0.4080	0.5489	1.4150	0.5744

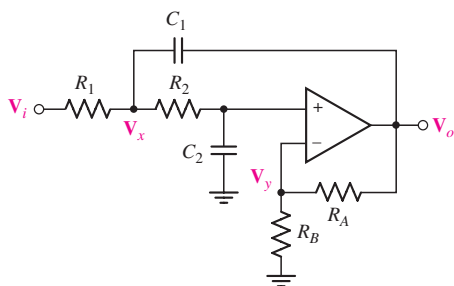

FIGURE 16.48 General low-pass Sallen-Key filter circuit.

If we wish to improve upon this basic approach, a circuit worth considering is known as the Sallen-Key amplifier, shown in Fig. 16.48, configured as a low-pass filter. Analysis of this circuit by nodal analysis is straightforward. We first define the gain  $G$  of the noninverting amplifier as

$$G \equiv \frac{R_A + R_B}{R_B} \quad [37]$$

Then voltage division yields

$$V_y = V_x \frac{1}{1 + R_2 C_2 s} \quad [38]$$

and we may write a single nodal equation

$$0 = \frac{V_x - V_i}{R_1} + \frac{V_x - V_y}{R_2} + \frac{V_x - V_o}{1/sC_1} \quad [39]$$

Substituting Eqs. [37] and [38] into Eq. [39] and performing a few algebraic maneuvers, we arrive at an expression for the transfer function of the amplifier,

$$\frac{V_o}{V_i} = \frac{G/R_1 R_2 C_1 C_2}{s^2 + \left[ \frac{1}{R_1 C_1} + \frac{1}{R_2 C_1} + \frac{1-G}{R_2 C_2} \right] s + \frac{1}{R_1 R_2 C_1 C_2}} \quad [40]$$

Noting that the coefficients in Table 16.2 represent filters with a cutoff frequency of 1 rad/s, so that when finished we will need to make use of the simple scaling techniques described in Sec. 16.5, we are now ready to explore the design of a second-order Butterworth low-pass filter.

## EXAMPLE 16.14

**Design a second-order low-pass Butterworth filter having a gain of 4 and a corner frequency at 1400 rad/s.**

We begin by selecting the Sallen-Key prototype shown in Fig. 16.48, and opt for the simplification which arises when we set  $R_1 = R_2 = R$  and  $C_1 = C_2 = C$ . With a second-order Butterworth filter we expect from Table 16.2 to have a denominator polynomial

$$s^2 + 1.4142s + 1$$

and comparing to Eq. [42]

$$RC = 1$$

and

$$\frac{2}{RC} + \frac{1-G}{RC} = 1.414$$

hence

$$G = \frac{R_A + R_B}{R_B} = 1.586$$

We first set values for the two resistors in our gain network (which do not need to undergo scaling) by arbitrarily choosing  $R_B = 1 \text{ k}\Omega$ , so that  $R_A = 586 \Omega$ .

Next, we note that if  $C = 1 \text{ F}$ , then  $R = 1 \Omega$ , neither of which is a particularly conventional value. Instead we select  $C' = 1 \mu\text{F}$ ; this requires scaling the resistor by  $10^6$ . We also need to frequency-scale to 1400 rad/s. Thus,

$$10^{-6} \text{ F} = \frac{1 \text{ F}}{k_m k_f} = \frac{1 \text{ F}}{1400 k_m}$$

and  $k_m = 714 \Omega$ . Consequently,  $R' = k_m R = 714 \Omega$ .

Unfortunately, our design is not quite done. We were constrained to an amplifier gain of 1.586, or 4 dB, but the specifications called for a gain of 4, or 12 dB. The only option available to us is to feed the output of our circuit into a noninverting amplifier such as the one in Fig. 6.6a. Choosing 1 k $\Omega$  and 1.52 k $\Omega$  for  $R_1$  (output stage) and  $R_f$  completes the design.

## PRACTICE

**16.19** Design a second-order Butterworth low-pass filter having a gain of 10 dB and a cutoff frequency of 1000 Hz.

Ans: A two-stage circuit, with the output of the circuit of Fig. 16.48 fed into the input of a noninverting amplifier, with component values  $C_1 = C_2 = 1 \mu\text{F}$ ,  $R_1 = R_2 = 159 \Omega$ ,  $R_A = 586 \Omega$ ,  $R_B = 1 \text{ k}\Omega$  (stage 1) and  $R_1 = 1 \text{ k}\Omega$ ,  $R_f = 994 \Omega$  (stage 2).

Design of high-pass filters based on the Sallen-Key model is similarly straightforward; the only modification required is to replace capacitors  $C_1$  and  $C_2$  with resistors, and resistors  $R_1$  and  $R_2$  with capacitors. The remainder of the circuit remains unchanged. Nodal analysis of the resulting circuit with  $C_1 = C_2 = C$  and  $R_1 = R_2 = R$  yields

$$a_0 = \frac{1}{R^2 C^2} \quad [41]$$

and

$$a_1 = \frac{3 - G}{RC} \quad [42]$$

as we found for the low-pass filter.

Higher-order filters can be realized by cascading appropriate op amp stages. For example, Butterworth filters of odd order (e.g., 3, 5, ...) require an additional pole at  $s = -1$ . Thus, a third-order Butterworth filter is constructed using a Sallen-Key stage which provides a transfer function denominator  $\mathbf{D}(s)$  of

$$(s + 1) \frac{s^2 + s + 1}{s^3 + 2s^2 + 2s + 1}$$

or

$$\mathbf{D}(s) = s^2 + s + 1 \quad [43]$$

with an additional op amp stage such as the one in Fig. 15.49a to provide the term  $(s + 1)$ .

## EXAMPLE 16.15

**Design a third-order low-pass Butterworth filter having a voltage gain magnitude of 4 and a corner frequency at 2000 rad/s.**

We begin by again selecting the Sallen-Key prototype shown in Fig. 16.48, and opt for the simplification which arises when we set  $R_1 = R_2 = R$  and  $C_1 = C_2 = C$ . We will also add an input stage of the form shown in Fig. 15.49a to add the necessary pole. The basic design is shown in Fig. 16.49.

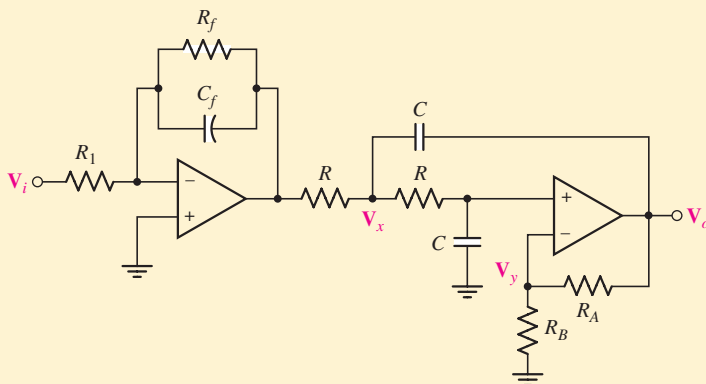

■ FIGURE 16.49 Basic structure of the proposed third-order low-pass Butterworth filter, with component values still to be chosen.

Comparing Eqs. [41], [42], and [43], we determine that our design must ensure that

$$1 = \frac{1}{R^2 C^2}$$

and

$$1 = \frac{3 - G}{RC}$$

Consequently,  $RC = 1$  and  $G = 4$ . If we choose  $R_A = 3 \text{ k}\Omega$ , it follows that  $R_B = 1 \text{ k}\Omega$ . We may scale these values later if we choose when adjusting for operation at  $2000 \text{ rad/s}$ , but this is unnecessary as the dc gain is set by the ratio of the two resistors.

Initially we design for  $R = 1 \text{ }\Omega$  and  $C = 1 \text{ F}$  as this automatically satisfies the  $RC = 1$  requirement. Neither value being easy to locate, however, we select a more reasonable capacitor value of  $0.1 \text{ }\mu\text{F}$ , which combined with our frequency scaling factor  $k_f = 2000$ , results in a resistor scaling factor  $k_m = 5000$ . Thus,  $R = 5 \text{ k}\Omega$  in our final design.

All that remains is to select values for  $R_1$ ,  $R_f$ , and  $C_f$  in our front-end stage. Recall that the transfer function of this stage is

$$\frac{1/R_1 C_f}{s + (1/R_f C_f)}$$

Setting  $R_f = 1 \text{ }\Omega$  and  $C_f = 1 \text{ F}$  initially allows the pole to be properly located prior to scaling operations, which dictate that we build the circuit with  $R_f = 5 \text{ k}\Omega$  and  $C_f = 0.1 \text{ }\mu\text{F}$ . Our only remaining choice, then, is to ensure that  $R_1$  allows us to meet our gain requirement of 4. Since we have already achieved this with our Sallen-Key stage,  $R_1$  must be equal to  $R_f$ , or  $5 \text{ k}\Omega$ .

Design of Chebyshev filters proceeds along the same lines as that of Butterworth filters, except we have more choices now with the ripple factor. Also, for filters not having a 3 dB ripple factor, the critical frequency is where the ripple channel in the passband terminates, which is slightly different than what we have specified previously. Filters with order  $n > 2$  are constructed by cascading stages, either multiple Sallen-Key stages for even orders, or a simple stage such as Fig. 15.49a in conjunction with the appropriate number of Sallen-Key stages for odd orders. For filters with a specific gain requirement, an op amp stage containing only resistors is typically required at the output.

## SUMMARY AND REVIEW

We began this chapter with a short discussion of *resonance*. Of course the reader was likely to already have an intuitive understanding of the basic concept—timing when to kick our legs on a swing as a child; watching videos of crystal glasses shattering under the power of a trained soprano's voice; instinctively slowing down when driving over a corrugated surface. In

the context of linear circuit analysis, we found (perhaps surprisingly) that a frequency can be chosen even for networks with capacitors and inductors such that the voltage and current are in phase (hence the network appears purely resistive at that particular frequency). How quickly our circuit response changes as we move “off resonance” was related to a new term—the *quality factor* ( $Q$ ) of our circuit. After defining what is meant by *critical frequencies* for our circuit response, we introduced the concept of *bandwidth*, and discovered that our expressions may be simplified rather dramatically for high- $Q$  ( $Q > 5$ ) circuits. We briefly extended this discussion to consider the differences between series and parallel circuits near resonance, along with more practical networks which cannot be classed as either.

The remainder of this chapter dealt with the analysis and design of filter circuits. Prior to launching into that discussion, the topic of “scaled” circuit components dealt with both *frequency* and *magnitude scaling* as a convenient design tool. We also introduced the handy method of *Bode plots*, which allows us to quickly sketch a reasonable approximation to the response of a filter circuit as a function of frequency. We next considered both *passive* and *active filters*, starting with simple designs using a single capacitor to achieve either low-pass or high-pass behavior. Shortly thereafter, *bandpass filter* design was studied. Although they are straightforward to work with, the response of such simple circuits is not particularly abrupt. As an alternative, filter designs based on either Butterworth or Chebyshev polynomials were examined, with higher-order filters yielding sharper magnitude response at the expense of increased complexity.

- Resonance is the condition in which a fixed-amplitude sinusoidal forcing function produces a response of maximum amplitude. (Example 16.1)
- An electrical network is in resonance when the voltage and current at the network input terminals are in phase. (Example 16.1)
- The quality factor is proportional to the maximum energy stored in a network divided by the total energy lost per period.
- A half-power frequency is defined as the frequency at which the magnitude of a circuit response function is reduced to  $1/\sqrt{2}$  times its maximum value.
- A high- $Q$  circuit is a resonant circuit in which the quality factor is  $\geq 5$ . (Example 16.2)
- The bandwidth of a resonant circuit is defined as the difference between the upper and lower half-power frequencies.
- In a high- $Q$  circuit, each half-power frequency is located approximately one-half bandwidth from the resonant frequency. (Example 16.2)
- A series resonant circuit is characterized by a *low* impedance at resonance, whereas a parallel resonant circuit is characterized by a *high* impedance at resonance. (Examples 16.1 and 16.3)
- A series resonant circuit and a parallel resonant circuit are equivalent if  $R_p = R_s(1 + Q^2)$  and  $X_p = X_s(1 + Q^{-2})$ . (Examples 16.4, 16.5)
- Impractical values for components often make design easier. The transfer function of a network may be scaled in magnitude or frequency using appropriate replacement values for components. (Example 16.6)



- Bode diagrams allow the rough shape of a transfer function to be plotted quickly from the poles and zeros. (Examples 16.7, 16.8, 16.9, 16.10)
- The four basic types of filters are low-pass, high-pass, bandpass, and bandstop. (Examples 16.11, 16.12)
- Passive filters use only resistors, capacitors, and inductors; active filters are based on op amps or other active elements. (Example 16.13)
- Butterworth and Chebyshev filters can be designed based on the simple Sallen-Key amplifier. Filter gain typically must be adjusted by adding a purely resistor-based amplifier circuit at the output.

## READING FURTHER

A good discussion of a large variety of filters can be found in:

J. T. Taylor and Q. Huang, eds., *CRC Handbook of Electrical Filters*. Boca Raton, Fla.: CRC Press, 1997.

A comprehensive compilation of various active filter circuits and design procedures is given in:

D. Lancaster, *Lancaster's Active Filter Cookbook*, 2nd ed. Burlington, Mass.: Newnes, 1996.

Additional filter references which the reader might find useful include:

D. E. Johnson and J. L. Hilburn, *Rapid Practical Design of Active Filters*. New York: John Wiley & Sons, Inc., 1975.

J. V. Wait, L. P. Huelsman, and G. A. Korn, *Introduction to Operational Amplifier Theory and Applications*, 2nd ed. New York: McGraw-Hill, 1992.

## EXERCISES

### 16.1 Parallel Resonance

1. Compute  $Q_0$  and  $\zeta$  for a simple parallel  $RLC$  network if (a)  $R = 1 \text{ k}\Omega$ ,  $C = 10 \text{ mF}$ , and  $L = 1 \text{ H}$ ; (b)  $R = 1 \Omega$ ,  $C = 10 \text{ mF}$ , and  $L = 1 \text{ H}$ ; (c)  $R = 1 \text{ k}\Omega$ ,  $C = 1 \text{ F}$ , and  $L = 1 \text{ H}$ ; (d)  $R = 1 \Omega$ ,  $C = 1 \text{ F}$ , and  $L = 1 \text{ H}$ .
2. For the circuit shown in Fig. 16.1, let  $R = 1 \text{ k}\Omega$ ,  $C = 22 \text{ mF}$ , and  $L = 12 \text{ mH}$ . (a) Calculate  $\alpha$ ,  $\omega_0$ ,  $\zeta$ ,  $f_0$ , and  $\omega_d$  for the circuit. (b) If  $\mathbf{I} = 1\angle 0^\circ \text{ A}$ , plot  $\mathbf{V}$ ,  $\mathbf{I}_{LC}$ ,  $\mathbf{I}_L$ , and  $\mathbf{I}_C$  as a function of frequency, and verify that  $\mathbf{I}$  and  $\mathbf{V}$  are in phase at  $\omega_0$ . (c) What is the relationship of  $\mathbf{I}_L$  to  $\mathbf{I}_C$  at  $\omega_0$ ?
3. A certain parallel  $RLC$  circuit is built using component values  $L = 50 \text{ mH}$  and  $C = 33 \text{ mF}$ . If  $Q_0 = 10$ , determine the value of  $R$ , and sketch the magnitude of the steady-state impedance over the range of  $2 < \omega < 40 \text{ rad/s}$ .
4. A parallel  $RLC$  network is constructed using  $R = 5 \Omega$ ,  $L = 100 \text{ mH}$ , and  $C = 1 \text{ mF}$ . (a) Compute  $Q_0$ . (b) Determine at which frequencies the impedance magnitude drops to 90% of its maximum value.
5. For the network of Fig. 16.50, derive an expression for the steady-state input impedance and determine the frequency at which it has maximum amplitude.
6. Plot the input admittance of the network depicted in Fig. 16.50 using a logarithmic frequency scale over the range  $0.01\omega_0 < \omega < 100\omega_0$ , and determine the resonant frequency and the bandwidth of the network.
7. Delete the  $2 \Omega$  resistor in the network of Fig. 16.50 and determine (a) the magnitude of the input impedance at resonance; (b) the resonant frequency; (c)  $Q_0$ .

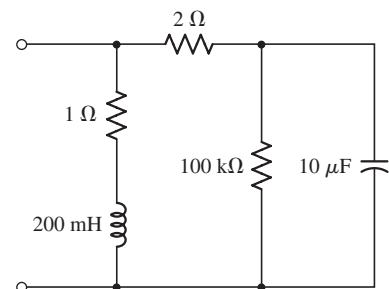

■ FIGURE 16.50

8. Delete the  $1\ \Omega$  resistor in the network of Fig. 16.50 and determine (a) the magnitude of the input impedance at resonance; (b) the resonant frequency; (c)  $Q_0$ .
9. A varactor is a semiconductor device whose reactance may be varied by applying a bias voltage. The quality factor can be expressed<sup>3</sup> as

$$Q \approx \frac{\omega C_J R_P}{1 + \omega^2 C_J^2 R_P R_S}$$

where  $C_J$  is the junction capacitance (which depends on the voltage applied to the device),  $R_S$  is the series resistance of the device, and  $R_P$  is an equivalent parallel resistance term. (a) If  $C_J = 3.77\ \text{pF}$  at  $1.5\ \text{V}$ ,  $R_P = 1.5\ \text{M}\Omega$ , and  $R_S = 2.8\ \Omega$ , plot the quality factor as a function of frequency  $\omega$ . (b) Differentiate the expression for  $Q$  to obtain both  $\omega_0$  and  $Q_{\text{max}}$ .

## 16.2 Bandwidth and High-Q Circuits

10. The circuit of Fig. 16.1 is built using component values  $L = 1\ \text{mH}$  and  $C = 100\ \mu\text{F}$ . If  $Q_0 = 15$ , determine the bandwidth and estimate the magnitude and angle of the input impedance for operation at (a)  $3162\ \text{rad/s}$ ; (b)  $3000\ \text{rad/s}$ ; (c)  $3200\ \text{rad/s}$ ; (d)  $2000\ \text{rad/s}$ . (e) Verify your estimates using an exact expression for  $\mathbf{Y}(j\omega)$ .
11. A parallel  $RLC$  network is constructed with a  $5\ \text{mH}$  inductor, and the remaining component values are chosen such that  $Q_0 = 6.5$  and  $\omega_0 = 1000\ \text{rad/s}$ . Determine the approximate value of the input impedance magnitude for operation at (a)  $500\ \text{rad/s}$ ; (b)  $750\ \text{rad/s}$ ; (c)  $900\ \text{rad/s}$ ; (d)  $1100\ \text{rad/s}$ . (e) Plot your estimates along with the exact result using a linear frequency ( $\text{rad/s}$ ) axis.
12. A parallel  $RLC$  network is constructed with a  $200\ \mu\text{H}$  inductor, and the remaining component values are chosen such that  $Q_0 = 8$  and  $\omega_0 = 5000\ \text{rad/s}$ . Use approximate expressions to estimate the input impedance angle for operation at (a)  $2000\ \text{rad/s}$ ; (b)  $3000\ \text{rad/s}$ ; (c)  $4000\ \text{rad/s}$ ; (d)  $4500\ \text{rad/s}$ . (e) Plot your estimates along with the exact result using a linear frequency ( $\text{rad/s}$ ) axis.
13. Find the bandwidth of each of the response curves shown in Fig. 16.51.

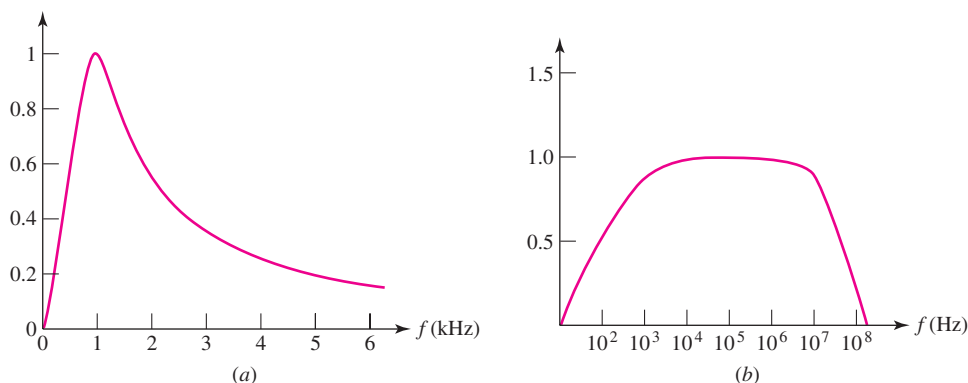

■ FIGURE 16.51

14. A parallel  $RLC$  circuit is constructed such that it has the impedance magnitude characteristic plotted in Fig. 16.52. (a) Determine the resistor value. (b) Determine the capacitor value if a  $1\ \text{H}$  inductor was used. (c) Obtain values for the bandwidth,  $Q_0$ , and both the low half-power frequency and the high half-power frequency.

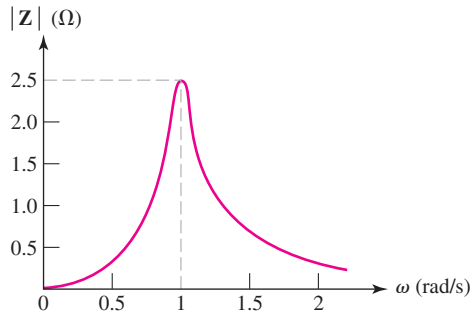

■ FIGURE 16.52

### 16.3 Series Resonance

15. A series  $RLC$  circuit is constructed employing component values  $R = 100 \Omega$  and  $L = 1.5 \text{ mH}$  along with a sinusoidal voltage source  $v_s$ . If  $Q_0 = 7$ , determine (a) the magnitude of the impedance at  $500 \text{ Mrad/s}$ ; (b) the current which flows in response to a voltage  $v_s = 2.5 \cos(425 \times 10^6 t) \text{ V}$ .
16. With regard to the series  $RLC$  circuit described in Exercise 15, adjust the resistor value such that  $Q_0$  is reduced to 5, and (a) estimate the angle of the impedance at  $90 \text{ krad/s}$ ,  $100 \text{ krad/s}$ , and  $110 \text{ krad/s}$ . (b) Determine the percent error in the estimated values, compared to the exact expression.
17. An  $RLC$  circuit is constructed using  $R = 5 \Omega$ ,  $L = 20 \text{ mH}$ , and  $C = 1 \text{ mF}$ . Calculate  $Q_0$ , the bandwidth, and the magnitude of the impedance at  $0.95\omega_0$  if the circuit is (a) parallel-connected; (b) series-connected. (c) Verify your solutions using appropriate PSpice simulations. (Hint: a large resistor in parallel with the capacitor will avoid error messages associated with no dc path to ground, and a small resistance in series with the VAC source will avoid shorting by the inductor during dc bias point determination.)
18. Inspect the circuit of Fig. 16.53, noting the amplitude of the source voltage. Now decide whether you would be willing to put your bare hands across the capacitor if the circuit were actually built in the lab. Plot  $|V_C|$  versus  $\omega$  to justify your answer.

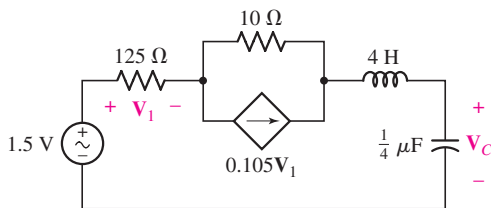

■ FIGURE 16.53

19. After deriving  $Z_{in}(s)$  in Fig. 16.54, find (a)  $\omega_0$ ; (b)  $Q_0$ .

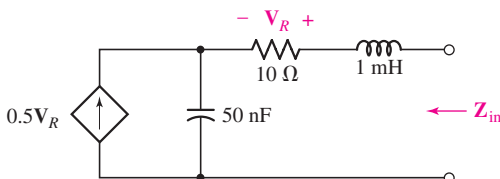

■ FIGURE 16.54

### 16.4 Other Resonant Forms

20. For the network of Fig. 16.9a,  $R_1 = 100 \Omega$ ,  $R_2 = 150 \Omega$ ,  $L = 30 \text{ mH}$ , and  $C$  is chosen so that  $\omega_0 = 750 \text{ rad/s}$ . Calculate the impedance magnitude at (a) the frequency corresponding to resonance when  $R_1 = 0$ ; (b)  $700 \text{ rad/s}$ ; (c)  $800 \text{ rad/s}$ .
21. Assuming an operating frequency of  $200 \text{ rad/s}$ , find a series equivalent of the parallel combination of a  $500 \Omega$  resistor and (a) a  $1.5 \mu\text{F}$  capacitor; (b) a  $200 \text{ mH}$  inductor.
22. If the frequency of operation is either  $40 \text{ rad/s}$  or  $80 \text{ rad/s}$ , find a parallel equivalent of the series combination of a  $2 \Omega$  resistor and (a) a  $100 \text{ mF}$  capacitor; (b) a  $3 \text{ mH}$  inductor.
23. For the network represented in Fig. 16.55, determine the resonant frequency and the corresponding value of  $|Z_{\text{in}}|$ .

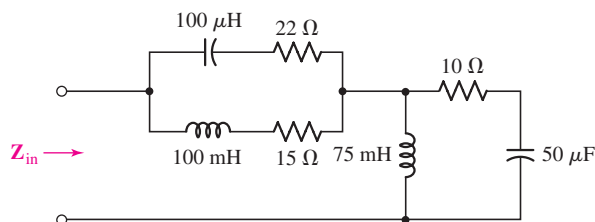

■ FIGURE 16.55

24. For the circuit shown in Fig. 16.56, the voltage source has magnitude  $1 \text{ V}$  and phase angle  $0^\circ$ . Determine the resonant frequency  $\omega_0$  and the value of  $V_x$  at  $0.95\omega_0$ .

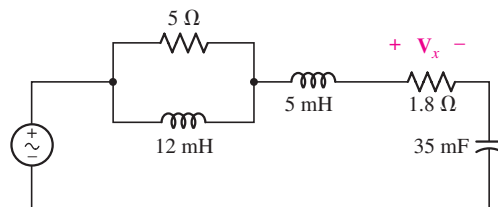

■ FIGURE 16.56

### 16.5 Scaling

25. A parallel  $RLC$  circuit is constructed using component values  $R = 1 \Omega$ ,  $C = 3 \text{ F}$ , and  $L = \frac{1}{3} \text{ H}$ . Determine the required component values if the network is to have (a) a resonant frequency of  $200 \text{ kHz}$ ; (b) a peak impedance of  $500 \text{ k}\Omega$ ; (c) a resonant frequency of  $750 \text{ kHz}$  and an impedance magnitude at resonance of  $25 \Omega$ .
26. A series  $RLC$  circuit is constructed using component values  $R = 1 \Omega$ ,  $C = 5 \text{ F}$ , and  $L = \frac{1}{5} \text{ H}$ . Determine the required component values if the network is to have (a) a resonant frequency of  $430 \text{ Hz}$ ; (b) a peak impedance of  $100 \Omega$ ; (c) a resonant frequency of  $75 \text{ kHz}$  and an impedance magnitude at resonance of  $15 \text{ k}\Omega$ .
27. Scale the network shown in Fig. 16.57 by  $K_m = 200$  and  $K_f = 700$ , and obtain an expression for the new impedance  $Z_{\text{in}}(s)$ .

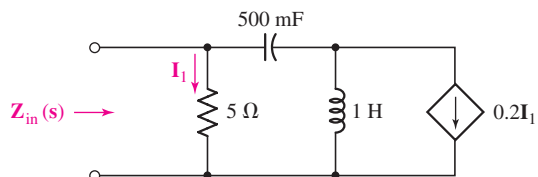

■ FIGURE 16.57

28. The filter shown in Fig. 16.58a has the response curve shown in Fig. 16.58b.  
 (a) Scale the filter so that it operates between a  $50\ \Omega$  source and a  $50\ \Omega$  load and has a cutoff frequency of 20 kHz. (b) Draw the new response curve.

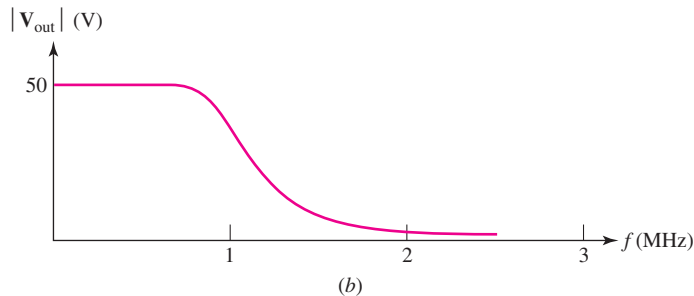
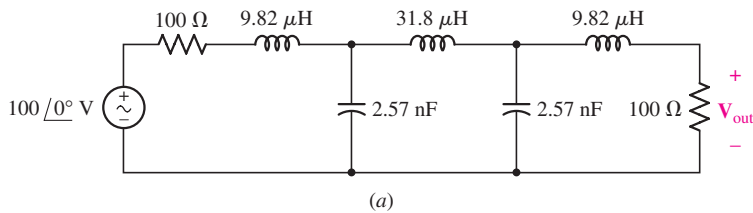

■ FIGURE 16.58

29. (a) Draw the new configuration for Fig. 16.59 after the network is scaled by  $K_m = 250$  and  $K_f = 400$ . (b) Determine the Thévenin equivalent of the scaled network at  $\omega = 1$  krad/s.

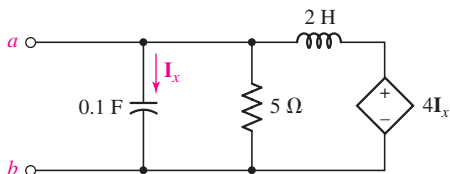

■ FIGURE 16.59

## 16.6 Bode Diagrams

30. Sketch the Bode magnitude and phase plots for the following functions:  
 (a)  $3 + 4s$ ; (b)  $\frac{1}{3 + 4s}$ .
31. For the following functions, sketch the Bode magnitude and phase plots:  
 (a)  $25 \left(1 + \frac{s}{3}\right) (5 + s)$ ; (b)  $\frac{0.1}{(1 + 5s)(2 + s)}$ .
32. Use the Bode approach to sketch the magnitude of each of the following responses, then verify your solutions with appropriate MATLAB simulations:  
 (a)  $3 \frac{s}{s^2 + 7s + 10}$ ; (b)  $\frac{4}{s^3 + 7s^2 + 12s}$ .
33. If a particular network is described by transfer function  $\mathbf{H}(s)$ , plot the magnitude of  $\mathbf{H}(s)$  as a function of frequency for  $\mathbf{H}(s)$  equal to  
 (a)  $\frac{s + 300}{s(5s + 8)}$ ; (b)  $\frac{s(s^2 + 7s + 7)}{s(2s + 4)^2}$ .
34. Sketch the phase plot of each of the following transfer functions:  
 (a)  $\frac{s + 1}{s(s + 2)^2}$ ; (b)  $5 \frac{s^2 + s}{s + 2}$ .





35. Determine the Bode magnitude plot for the following transfer functions, and compare to what is predicted using MATLAB: (a)  $s^2 + 0.2s + 1$ ;

(b)  $\left(\frac{s}{4}\right)^2 + 0.1\left(\frac{s}{4}\right) + 1$ .



36. Determine the phase plot corresponding to each of the transfer functions in Exercises 33 and 35, and compare your sketches to what is predicted using MATLAB.

37. Determine the Bode magnitude plot for each of the following:

(a)  $\frac{3 + 0.1s + s^2/3}{s^2 + 1}$ ; (b)  $2\frac{s^2 + 9s + 20}{s^2(s + 1)^3}$ .

38. For the circuit of Fig. 16.60, (a) derive an expression for the transfer function  $H(s) = V_{out}/V_{in}$ . (b) Sketch the corresponding Bode magnitude and phase plots.

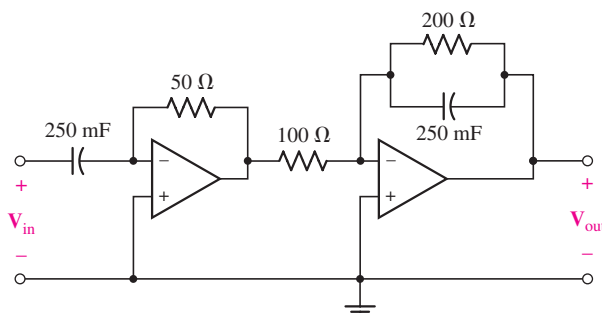

■ FIGURE 16.60

39. (a) Modify the circuit shown in Fig. 16.60 to add a double pole at 0.05 rad/s and a zero at 0.01 rad/s. (b) Sketch the corresponding Bode magnitude and phase plots.

### 16.7 Basic Filter Design



40. (a) Design a high-pass filter with a corner frequency of 100 rad/s. (b) Verify your design with an appropriate PSpice simulation.



41. (a) Design a low-pass filter with a break frequency of 1450 rad/s. (b) Sketch the Bode magnitude and phase plots for your design. (c) Verify your filter performance with an appropriate simulation.



42. (a) Design a bandpass filter characterized by a bandwidth of 1000 rad/s and a low-frequency corner of 250 Hz. (b) Verify your design with an appropriate PSpice simulation.



43. Design a bandpass filter having a low-frequency cutoff of 500 Hz and a high-frequency cutoff of 1580 Hz.



44. Design a notch filter which removes 60 Hz “noise” from power line influences on a particular signal by taking the output across the inductor-capacitor series connection in the circuit of Fig. 16.39.



45. Design a low-pass filter characterized by a voltage gain of 25 dB and a corner frequency of 5000 rad/s.



46. Design a high-pass filter characterized by a voltage gain of 30 dB and a corner frequency of 50 rad/s.



47. (a) Design a two-stage op amp filter circuit with a bandwidth of 1000 rad/s, a low-frequency cutoff of 100 rad/s, and a voltage gain of 20 dB. (b) Verify your design with an appropriate PSpice simulation.



48. Design a circuit which removes the entire audio frequency range (approximately 20 Hz to 20 kHz, for human hearing), but amplifies the signal voltage of all other frequencies by a factor of 15.

- DP** 49. Depending on which song you're listening to, your MP3 player sometimes provides too little bass, even when the appropriate setting is maximized. Design a filter which allows you to vary the gain real time of all signals less than 500 Hz prior to reaching your earphones. Include a diagram of the overall system.

### 16.8 Advanced Filter Design

- DP** 50. Show that the circuit represented by Eq. [36] cannot be implemented as either a Butterworth or a Chebyshev low-pass filter.
- DP** 51. Design a second-order low-pass filter having a voltage gain of 5 dB and a cutoff frequency of 1700 kHz based on (a) Butterworth polynomials; (b) Chebyshev polynomials for 3 dB ripple factor.
- DP** 52. If a high-pass filter is required having gain of 6 dB and a cutoff frequency of 350 Hz, design a suitable second-order Butterworth-based solution.
- DP** 53. (a) Design a second-order low-pass Butterworth filter with a cutoff frequency of 890 rad/s and a voltage gain of 8 dB. (b) Verify your design with an appropriate PSpice simulation.
- DP** 54. (a) Design a second-order high-pass Butterworth filter with a cutoff frequency of 2000 Hz and a voltage gain of 4.5 dB. (b) Verify your design with an appropriate PSpice simulation.
- DP** 55. A third-order low-pass Butterworth filter is required having a cutoff frequency of 1200 Hz and a voltage gain of at least 3 dB. Design a suitable circuit.
- DP** 56. (a) Design a third-order low-pass Butterworth filter having a gain of 13 dB and a corner frequency at 1800 Hz. (b) Compare your filter response to that of a Chebyshev filter with the same specifications.
- DP** 57. Design a fourth-order high-pass Butterworth filter having a minimum gain of 15 dB and a corner frequency of 1100 rad/s.
- DP** 58. Choose parameters for the circuit described by Eq. [36] such that it has a cutoff frequency at 450 rad/s, and compare its performance to a comparable second-order Butterworth filter.

DP

DP

DP

DP

### Chapter-Integrating Exercises

- DP** 59. Design a parallel resonant circuit for an AM radio so that a variable inductor can adjust the resonant frequency over the AM broadcast band, 535 to 1605 kHz, with  $Q_0 = 45$  at one end of the band and  $Q_0 \leq 45$  throughout the band. Let  $R = 20 \text{ k}\Omega$ , and specify values for  $C$ ,  $L_{\min}$ , and  $L_{\max}$ .
60. Derive an expression for the transfer function  $V_{\text{out}}/V_{\text{in}}$  which describes the circuit shown in Fig. 16.61, and sketch its magnitude as a function of frequency.

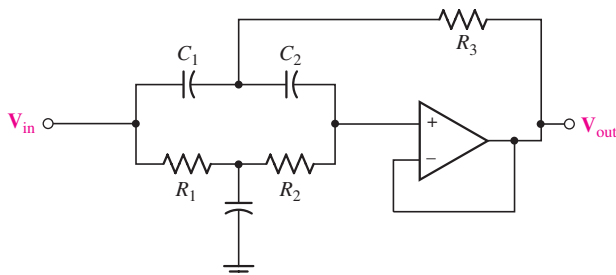
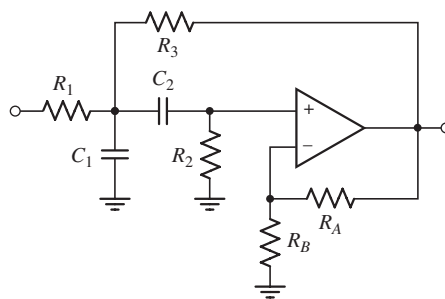

FIGURE 16.61

- DP** 61. The network of Fig. 16.36 was implemented as a low-pass filter designed with a corner frequency of 1250 rad/s. Its performance is inadequate in two respects: (1) a voltage gain of at least 2 dB is required, and (2) the magnitude of the output voltage does not decrease quickly enough in the stopband.

Design a better alternative if only one op amp is available and only two  $1\ \mu\text{F}$  capacitors can be located.

62. Determine the effect of component tolerance on the circuit designed in Example 16.14 if each component is specified to be only within 10% of its stated value.
63. Derive an expression for the transfer function  $V_{\text{out}}/V_{\text{in}}$  which describes the circuit shown in Fig. 16.62, and sketch its magnitude as a function of frequency.
- DP** 64. For the circuit shown in Fig. 16.62, select component values to design for corner frequencies at 500 rad/s and 1500 rad/s. Verify your design.



■ FIGURE 16.62

- DP** 65. Design a bandpass filter that spans the portion of the audio spectrum from 200 Hz to 2 kHz which has a minimum gain of 5 dB, and a steeper magnitude characteristic on the high-frequency side than on the low-frequency side. Verify your design using a suitable simulation.



# Two-Port Networks

## INTRODUCTION

A general network having two pairs of terminals, one often labeled the “input terminals” and the other the “output terminals,” is a very important building block in electronic systems, communication systems, automatic control systems, transmission and distribution systems, or other systems in which an electrical signal or electric energy enters the input terminals, is acted upon by the network, and leaves via the output terminals. The output terminal pair may very well connect with the input terminal pair of another network. When we studied the concept of Thévenin and Norton equivalent networks in Chap. 5, we were introduced to the idea that it is not always necessary to know the detailed workings of part of a circuit. This chapter extends such concepts to linear networks, resulting in parameters that allow us to predict how any network will interact with other networks.

## 17.1 ONE-PORT NETWORKS

A pair of terminals at which a signal may enter or leave a network is called a **port**, and a network having only one such pair of terminals is called a **one-port network**, or simply a **one-port**. No connections may be made to any other nodes internal to the one-port, and it is therefore evident that  $i_a$  must equal  $i_b$  in the one-port shown in Fig. 17.1a. When more than one pair of terminals is present, the network is known as a **multiport network**. The two-port network to which this chapter is principally devoted is shown in Fig. 17.1b. The currents in the two leads making up each port must be equal, and so it follows that  $i_a = i_b$  and  $i_c = i_d$  in the two-port shown in Fig. 17.1b. Sources and loads must be connected directly across the two terminals of a port if the methods of this chapter are to be used. In other

## KEY CONCEPTS

The Distinction Between One-Port and Two-Port Networks

Admittance ( $y$ ) Parameters

Impedance ( $z$ ) Parameters

Hybrid ( $h$ ) Parameters

Transmission ( $t$ ) Parameters

Transformation Methods Between  $y$ ,  $z$ ,  $h$ , and  $t$  Parameters

Circuit Analysis Techniques Using Network Parameters



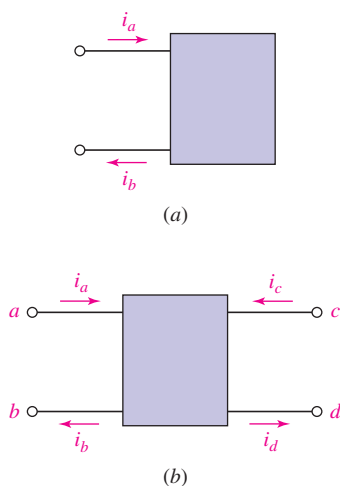

■ FIGURE 17.1 (a) A one-port network. (b) A two-port network.

words, each port can be connected only to a one-port network or to a port of another multiport network. For example, no device may be connected between terminals  $a$  and  $c$  of the two-port network in Fig. 17.1b. If such a circuit must be analyzed, general loop or nodal equations should be written.

Some of the introductory study of one- and two-port networks is accomplished best by using a generalized network notation and the abbreviated nomenclature for determinants introduced in Appendix 2. Thus, if we write a set of loop equations for a passive network,

$$\begin{aligned} \mathbf{Z}_{11}\mathbf{I}_1 + \mathbf{Z}_{12}\mathbf{I}_2 + \mathbf{Z}_{13}\mathbf{I}_3 + \cdots + \mathbf{Z}_{1N}\mathbf{I}_N &= \mathbf{V}_1 \\ \mathbf{Z}_{21}\mathbf{I}_1 + \mathbf{Z}_{22}\mathbf{I}_2 + \mathbf{Z}_{23}\mathbf{I}_3 + \cdots + \mathbf{Z}_{2N}\mathbf{I}_N &= \mathbf{V}_2 \\ \mathbf{Z}_{31}\mathbf{I}_1 + \mathbf{Z}_{32}\mathbf{I}_2 + \mathbf{Z}_{33}\mathbf{I}_3 + \cdots + \mathbf{Z}_{3N}\mathbf{I}_N &= \mathbf{V}_3 \\ \cdots &\cdots \\ \mathbf{Z}_{N1}\mathbf{I}_1 + \mathbf{Z}_{N2}\mathbf{I}_2 + \mathbf{Z}_{N3}\mathbf{I}_3 + \cdots + \mathbf{Z}_{NN}\mathbf{I}_N &= \mathbf{V}_N \end{aligned} \quad [1]$$

then the coefficient of each current will be an impedance  $\mathbf{Z}_{ij}(\mathbf{s})$ , and the circuit determinant, or determinant of the coefficients, is

$$\Delta_{\mathbf{Z}} = \begin{vmatrix} \mathbf{Z}_{11} & \mathbf{Z}_{12} & \mathbf{Z}_{13} & \cdots & \mathbf{Z}_{1N} \\ \mathbf{Z}_{21} & \mathbf{Z}_{22} & \mathbf{Z}_{23} & \cdots & \mathbf{Z}_{2N} \\ \mathbf{Z}_{31} & \mathbf{Z}_{32} & \mathbf{Z}_{33} & \cdots & \mathbf{Z}_{3N} \\ \cdots & \cdots & \cdots & \cdots & \cdots \\ \mathbf{Z}_{N1} & \mathbf{Z}_{N2} & \mathbf{Z}_{N3} & \cdots & \mathbf{Z}_{NN} \end{vmatrix} \quad [2]$$

Here  $N$  loops have been assumed, the currents appear in subscript order in each equation, and the order of the equations is the same as that of the currents. We also assume that KVL is applied so that the sign of each  $\mathbf{Z}_{ii}$  term ( $\mathbf{Z}_{11}, \mathbf{Z}_{22}, \dots, \mathbf{Z}_{NN}$ ) is positive; the sign of any  $\mathbf{Z}_{ij}$  ( $i \neq j$ ) or mutual term may be either positive or negative, depending on the reference directions assigned to  $\mathbf{I}_i$  and  $\mathbf{I}_j$ .

If there are dependent sources within the network, then it is possible that not all the coefficients in the loop equations must be resistances or impedances. Even so, we will continue to refer to the circuit determinant as  $\Delta_{\mathbf{Z}}$ .

The use of minor notation (Appendix 2) allows for the input or driving-point impedance at the terminals of a *one-port* network to be expressed very concisely. The result is also applicable to a *two-port* network if one of the two ports is terminated in a passive impedance, including an open or a short circuit.

Let us suppose that the one-port network shown in Fig. 17.2 is composed entirely of passive elements and dependent sources; linearity is also assumed. An ideal voltage source  $\mathbf{V}_1$  is connected to the port, and the source current is identified as the current in loop 1. Employing Cramer's rule, then,

$$\mathbf{I}_1 = \frac{\begin{vmatrix} \mathbf{V}_1 & \mathbf{Z}_{12} & \mathbf{Z}_{13} & \cdots & \mathbf{Z}_{1N} \\ 0 & \mathbf{Z}_{22} & \mathbf{Z}_{23} & \cdots & \mathbf{Z}_{2N} \\ 0 & \mathbf{Z}_{32} & \mathbf{Z}_{33} & \cdots & \mathbf{Z}_{3N} \\ \cdots & \cdots & \cdots & \cdots & \cdots \\ 0 & \mathbf{Z}_{N2} & \mathbf{Z}_{N3} & \cdots & \mathbf{Z}_{NN} \end{vmatrix}}{\begin{vmatrix} \mathbf{Z}_{11} & \mathbf{Z}_{12} & \mathbf{Z}_{13} & \cdots & \mathbf{Z}_{1N} \\ \mathbf{Z}_{21} & \mathbf{Z}_{22} & \mathbf{Z}_{23} & \cdots & \mathbf{Z}_{2N} \\ \mathbf{Z}_{31} & \mathbf{Z}_{32} & \mathbf{Z}_{33} & \cdots & \mathbf{Z}_{3N} \\ \cdots & \cdots & \cdots & \cdots & \cdots \\ \mathbf{Z}_{N1} & \mathbf{Z}_{N2} & \mathbf{Z}_{N3} & \cdots & \mathbf{Z}_{NN} \end{vmatrix}}$$

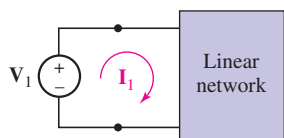

■ FIGURE 17.2 An ideal voltage source  $\mathbf{V}_1$  is connected to the single port of a linear one-port network containing no independent sources;  $\mathbf{Z}_{\text{in}} = \Delta_{\mathbf{Z}}/\Delta_{11}$ .



Cramer's rule is reviewed in Appendix 2.

or, more concisely,

$$\mathbf{I}_1 = \frac{\mathbf{V}_1 \Delta_{11}}{\Delta_{\mathbf{Z}}}$$

Thus,

$$\mathbf{Z}_{\text{in}} = \frac{\mathbf{V}_1}{\mathbf{I}_1} = \frac{\Delta_{\mathbf{Z}}}{\Delta_{11}} \quad [3]$$

### EXAMPLE 17.1

Calculate the input impedance for the one-port resistive network shown in Fig. 17.3.

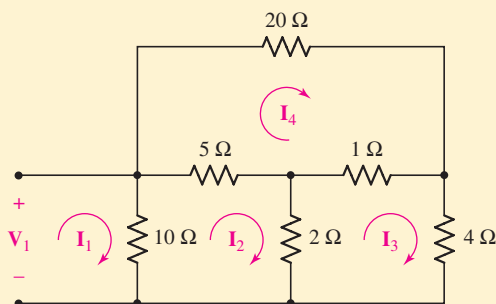

■ FIGURE 17.3 An example one-port network containing only resistive elements.

We first assign the four mesh currents as shown and write the corresponding mesh equations by inspection:

$$\begin{aligned} \mathbf{V}_1 &= 10\mathbf{I}_1 - 10\mathbf{I}_2 \\ 0 &= -10\mathbf{I}_1 + 17\mathbf{I}_2 - 2\mathbf{I}_3 - 5\mathbf{I}_4 \\ 0 &= \quad - 2\mathbf{I}_2 + 7\mathbf{I}_3 - \mathbf{I}_4 \\ 0 &= \quad - 5\mathbf{I}_2 - \mathbf{I}_3 + 26\mathbf{I}_4 \end{aligned}$$

The circuit determinant is then given by

$$\Delta_{\mathbf{Z}} = \begin{vmatrix} 10 & -10 & 0 & 0 \\ -10 & 17 & -2 & -5 \\ 0 & -2 & 7 & -1 \\ 0 & -5 & -1 & 26 \end{vmatrix}$$

and has the value  $9680 \Omega^4$ . Eliminating the first row and first column, we have

$$\Delta_{11} = \begin{vmatrix} 17 & -2 & -5 \\ -2 & 7 & -1 \\ -5 & -1 & 26 \end{vmatrix} = 2778 \Omega^3$$

(Continued on next page)

Thus, Eq. [3] provides the value of the input impedance,

$$Z_{in} = \frac{9680}{2778} = 3.485 \Omega$$

### PRACTICE

17.1 Find the input impedance of the network shown in Fig. 17.4 if it is formed into a one-port network by breaking it at terminals (a) a and a'; (b) b and b'; (c) c and c'.

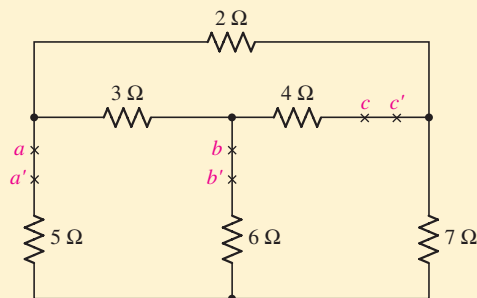

FIGURE 17.4

Ans: 9.47 Ω; 10.63 Ω; 7.58 Ω.

### EXAMPLE 17.2

Find the input impedance of the network shown in Fig. 17.5.

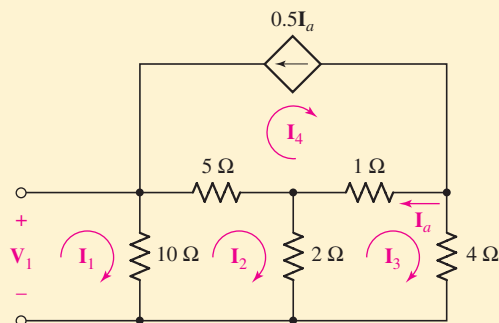

FIGURE 17.5 A one-port network containing a dependent source.

The four mesh equations are written in terms of the four assigned mesh currents:

$$\begin{aligned} 10\mathbf{I}_1 - 10\mathbf{I}_2 &= \mathbf{V}_1 \\ -10\mathbf{I}_1 + 17\mathbf{I}_2 - 2\mathbf{I}_3 - 5\mathbf{I}_4 &= 0 \\ -2\mathbf{I}_2 + 7\mathbf{I}_3 - \mathbf{I}_4 &= 0 \end{aligned}$$

and

$$\mathbf{I}_4 = -0.5\mathbf{I}_a = -0.5(\mathbf{I}_4 - \mathbf{I}_3)$$

or

$$-0.5\mathbf{I}_3 + 1.5\mathbf{I}_4 = 0$$

Thus we can write

$$\Delta_{\mathbf{Z}} = \begin{vmatrix} 10 & -10 & 0 & 0 \\ -10 & 17 & -2 & -5 \\ 0 & -2 & 7 & -1 \\ 0 & 0 & -0.5 & 1.5 \end{vmatrix} = 590 \Omega^4$$

while

$$\Delta_{11} = \begin{vmatrix} 17 & -2 & -5 \\ -2 & 7 & -1 \\ 0 & -0.5 & 1.5 \end{vmatrix} = 159 \Omega^3$$

giving

$$\mathbf{Z}_{\text{in}} = \frac{590}{159} = 3.711 \Omega$$

We may also select a similar procedure using nodal equations, yielding the input admittance:

$$\mathbf{Y}_{\text{in}} = \frac{1}{\mathbf{Z}_{\text{in}}} = \frac{\Delta_{\mathbf{Y}}}{\Delta_{11}} \quad [4]$$

where  $\Delta_{11}$  now refers to the minor of  $\Delta_{\mathbf{Y}}$ .

## PRACTICE

17.2 Write a set of nodal equations for the circuit of Fig. 17.6, calculate  $\Delta_{\mathbf{Y}}$ , and then find the input admittance seen between (a) node 1 and the reference node; (b) node 2 and the reference.

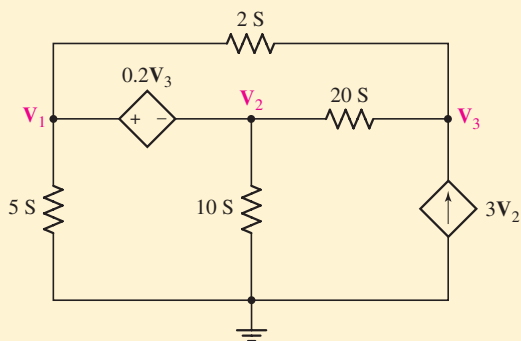

FIGURE 17.6

Ans: 10.68 S; 13.16 S.

## EXAMPLE 17.3

Use Eq. [4] to again determine the input impedance of the network shown in Fig. 17.3, repeated here as Fig. 17.7.

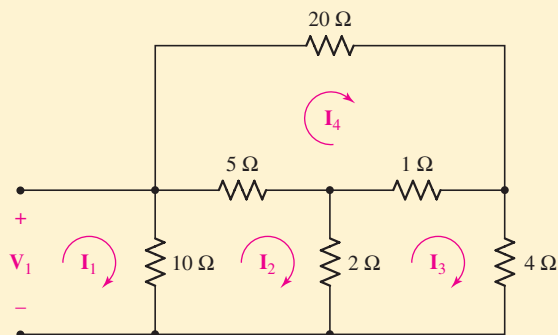

FIGURE 17.7 The circuit from Example 17.1, repeated for convenience.

We first order the node voltages  $V_1$ ,  $V_2$ , and  $V_3$  from left to right, select the reference at the bottom node, and then write the system admittance matrix by inspection:

$$\Delta_{\mathbf{Y}} = \begin{vmatrix} 0.35 & -0.2 & -0.05 \\ -0.2 & 1.7 & -1 \\ -0.05 & -1 & 1.3 \end{vmatrix} = 0.3473 \text{ S}^3$$

$$\Delta_{11} = \begin{vmatrix} 1.7 & -1 \\ -1 & 1.3 \end{vmatrix} = 1.21 \text{ S}^2$$

so that

$$\mathbf{Y}_{\text{in}} = \frac{0.3473}{1.21} = 0.2870 \text{ S}$$

which corresponds to

$$\mathbf{Z}_{\text{in}} = \frac{1}{0.287} = 3.484 \Omega$$

which agrees with our previous answer to within expected rounding error (we only retained four digits throughout the calculations).



Exercises 9 and 10 at the end of the chapter give one-ports that can be built using operational amplifiers. These exercises illustrate that *negative* resistances may be obtained from networks whose only passive circuit elements are resistors, and that inductors may be simulated with only resistors and capacitors.

## 17.2 ADMITTANCE PARAMETERS

Let us now turn our attention to two-port networks. We will assume in all that follows that the network is composed of linear elements and contains no independent sources; dependent sources *are* permissible, however. Further conditions will also be placed on the network in some special cases.

We will consider the two-port as it is shown in Fig. 17.8; the voltage and current at the input terminals are  $\mathbf{V}_1$  and  $\mathbf{I}_1$ , and  $\mathbf{V}_2$  and  $\mathbf{I}_2$  are specified at the output port. The directions of  $\mathbf{I}_1$  and  $\mathbf{I}_2$  are both customarily selected as *into* the network at the upper conductors (and out at the lower conductors). Since the network is linear and contains no independent sources within it,  $\mathbf{I}_1$  may be considered to be the superposition of two components, one caused by  $\mathbf{V}_1$  and the other by  $\mathbf{V}_2$ . When the same argument is applied to  $\mathbf{I}_2$ , we may begin with the set of equations

$$\mathbf{I}_1 = y_{11}\mathbf{V}_1 + y_{12}\mathbf{V}_2 \quad [5]$$

$$\mathbf{I}_2 = y_{21}\mathbf{V}_1 + y_{22}\mathbf{V}_2 \quad [6]$$

where the  $y$ 's are no more than proportionality constants, or unknown coefficients, for the present. However, it should be clear that their dimensions must be A/V, or S. They are therefore called the  $y$  (or admittance) parameters, and are defined by Eqs. [5] and [6].

The  $y$  parameters, as well as other sets of parameters we will define later in the chapter, are represented concisely as matrices. Here, we define the  $(2 \times 1)$  column matrix  $\mathbf{I}$ ,

$$\mathbf{I} = \begin{bmatrix} \mathbf{I}_1 \\ \mathbf{I}_2 \end{bmatrix} \quad [7]$$

the  $(2 \times 2)$  square matrix of the  $y$  parameters,

$$\mathbf{y} = \begin{bmatrix} y_{11} & y_{12} \\ y_{21} & y_{22} \end{bmatrix} \quad [8]$$

and the  $(2 \times 1)$  column matrix  $\mathbf{V}$ ,

$$\mathbf{V} = \begin{bmatrix} \mathbf{V}_1 \\ \mathbf{V}_2 \end{bmatrix} \quad [9]$$

Thus, we may write the matrix equation  $\mathbf{I} = \mathbf{yV}$ , or

$$\begin{bmatrix} \mathbf{I}_1 \\ \mathbf{I}_2 \end{bmatrix} = \begin{bmatrix} y_{11} & y_{12} \\ y_{21} & y_{22} \end{bmatrix} \begin{bmatrix} \mathbf{V}_1 \\ \mathbf{V}_2 \end{bmatrix}$$

and matrix multiplication of the right-hand side gives us the equality

$$\begin{bmatrix} \mathbf{I}_1 \\ \mathbf{I}_2 \end{bmatrix} = \begin{bmatrix} y_{11}\mathbf{V}_1 + y_{12}\mathbf{V}_2 \\ y_{21}\mathbf{V}_1 + y_{22}\mathbf{V}_2 \end{bmatrix}$$

These  $(2 \times 1)$  matrices must be equal, element by element, and thus we are led to the defining equations, [5] and [6].

The most useful and informative way to attach a physical meaning to the  $y$  parameters is through a direct inspection of Eqs. [5] and [6]. Consider Eq. [5], for example; if we let  $\mathbf{V}_2$  be zero, then we see that  $y_{11}$  must be given by the ratio of  $\mathbf{I}_1$  to  $\mathbf{V}_1$ . We therefore describe  $y_{11}$  as the admittance measured at the input terminals with the output terminals *short-circuited* ( $\mathbf{V}_2 = 0$ ). Since there can be no question which terminals are short-circuited,  $y_{11}$  is best described as the *short-circuit input admittance*. Alternatively, we might describe  $y_{11}$  as the reciprocal of the input impedance measured with the output terminals short-circuited, but a description as an admittance is obviously more direct. It is not the *name* of the parameter that is important. Rather, it

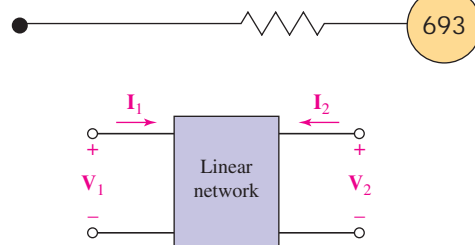

FIGURE 17.8 A general two-port with terminal voltages and currents specified. The two-port is composed of linear elements, possibly including dependent sources, but not containing any independent sources.

The notation adopted in this text to represent a matrix is standard, but also can be easily confused with our previous notation for phasors or general complex quantities. The nature of any such symbol should be clear from the context in which it is used.

is the conditions which must be applied to Eq. [5] or [6], and hence to the network, that are most meaningful; when the conditions are determined, the parameter can be found directly from an analysis of the circuit (or by experiment on the physical circuit). Each of the  $y$  parameters may be described as a current-voltage ratio with either  $V_1 = 0$  (the input terminals short-circuited) or  $V_2 = 0$  (the output terminals short-circuited):

$$y_{11} = \left. \frac{I_1}{V_1} \right|_{V_2=0} \quad [10]$$

$$y_{12} = \left. \frac{I_1}{V_2} \right|_{V_1=0} \quad [11]$$

$$y_{21} = \left. \frac{I_2}{V_1} \right|_{V_2=0} \quad [12]$$

$$y_{22} = \left. \frac{I_2}{V_2} \right|_{V_1=0} \quad [13]$$

Because each parameter is an admittance which is obtained by short-circuiting either the output or the input port, the  $y$  parameters are known as the **short-circuit admittance parameters**. The specific name of  $y_{11}$  is the **short-circuit input admittance**,  $y_{22}$  is the **short-circuit output admittance**, and  $y_{12}$  and  $y_{21}$  are the **short-circuit transfer admittances**.

#### EXAMPLE 17.4

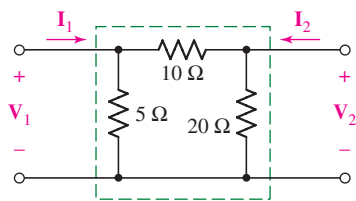

FIGURE 17.9 A resistive two-port.

**Find the four short-circuit admittance parameters for the resistive two-port shown in Fig. 17.9.**

The values of the parameters may be easily established by applying Eqs. [10] to [13], which we obtained directly from the defining equations, [5] and [6]. To determine  $y_{11}$ , we short-circuit the output and find the ratio of  $I_1$  to  $V_1$ . This may be done by letting  $V_1 = 1$  V, for then  $y_{11} = I_1$ . By inspection of Fig. 17.9, it is apparent that 1 V applied at the input with the output short-circuited will cause an input current of  $(\frac{1}{5} + \frac{1}{10})$ , or 0.3 A. Hence,

$$y_{11} = 0.3 \text{ S}$$

In order to find  $y_{12}$ , we short-circuit the input terminals and apply 1 V at the output terminals. The input current flows through the short circuit and is  $I_1 = -\frac{1}{10}$  A. Thus

$$y_{12} = -0.1 \text{ S}$$

By similar methods,

$$y_{21} = -0.1 \text{ S} \quad y_{22} = 0.15 \text{ S}$$

The describing equations for this two-port in terms of the admittance parameters are, therefore,

$$I_1 = 0.3V_1 - 0.1V_2 \quad [14]$$

$$I_2 = -0.1V_1 + 0.15V_2 \quad [15]$$



and

$$\mathbf{y} = \begin{bmatrix} 0.3 & -0.1 \\ -0.1 & 0.15 \end{bmatrix} \quad (\text{all S})$$

It is not necessary to find these parameters one at a time by using Eqs. [10] to [13], however. We may find them all at once—as shown in the next example.

### EXAMPLE 17.5

Assign node voltages  $V_1$  and  $V_2$  in the two-port of Fig. 17.9 and write the expressions for  $I_1$  and  $I_2$  in terms of them.

We have

$$I_1 = \frac{V_1}{5} + \frac{V_1 - V_2}{10} = 0.3V_1 - 0.1V_2$$

and

$$I_2 = \frac{V_2 - V_1}{10} + \frac{V_2}{20} = -0.1V_1 + 0.15V_2$$

These equations are identical with Eqs. [14] and [15], and the four  $y$  parameters may be read from them *directly*.

### PRACTICE

17.3 By applying the appropriate 1 V sources and short circuits to the circuit shown in Fig. 17.10, find (a)  $y_{11}$ ; (b)  $y_{21}$ ; (c)  $y_{22}$ ; (d)  $y_{12}$ .

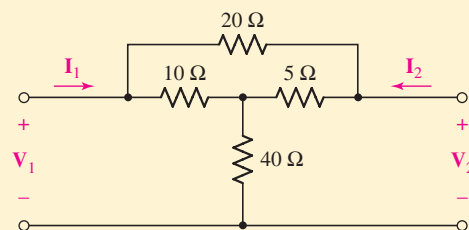
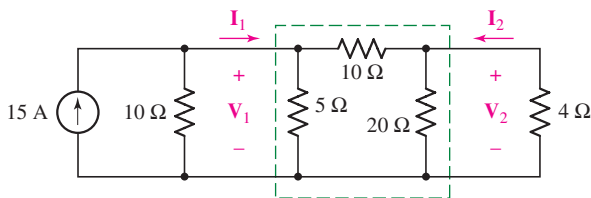

FIGURE 17.10

Ans: 0.1192 S;  $-0.1115$  S; 0.1269 S;  $-0.1115$  S.

In general, it is easier to use Eq. [10], [11], [12], or [13] when only one parameter is desired. If we need all of them, however, it is usually easier to assign  $V_1$  and  $V_2$  to the input and output nodes, to assign other node-to-reference voltages at any interior nodes, and then to carry through with the general solution.

In order to see what use might be made of such a system of equations, let us now terminate each port with some specific one-port network.



■ FIGURE 17.11 The resistive two-port network of Fig. 17.9, terminated with specific one-port networks.

Consider the simple two-port network of Example 17.4, shown in Fig. 17.11 with a practical current source connected to the input port and a resistive load connected to the output port. A relationship must now exist between  $\mathbf{V}_1$  and  $\mathbf{I}_1$  that is independent of the two-port network. This relationship may be determined solely from this external circuit. If we apply KCL (or write a single nodal equation) at the input,

$$\mathbf{I}_1 = 15 - 0.1\mathbf{V}_1$$

For the output, Ohm's law yields

$$\mathbf{I}_2 = -0.25\mathbf{V}_2$$

Substituting these expressions for  $\mathbf{I}_1$  and  $\mathbf{I}_2$  in Eqs. [14] and [15], we have

$$15 = 0.4\mathbf{V}_1 - 0.1\mathbf{V}_2$$

$$0 = -0.1\mathbf{V}_1 + 0.4\mathbf{V}_2$$

from which are obtained

$$\mathbf{V}_1 = 40 \text{ V} \quad \mathbf{V}_2 = 10 \text{ V}$$

The input and output currents are also easily found:

$$\mathbf{I}_1 = 11 \text{ A} \quad \mathbf{I}_2 = -2.5 \text{ A}$$

and the complete terminal characteristics of this resistive two-port are then known.

The advantages of two-port analysis do not show up very strongly for such a simple example, but it should be apparent that once the  $\mathbf{y}$  parameters are determined for a more complicated two-port, the performance of the two-port for different terminal conditions is easily determined; it is necessary only to relate  $\mathbf{V}_1$  to  $\mathbf{I}_1$  at the input and  $\mathbf{V}_2$  to  $\mathbf{I}_2$  at the output.

In the example just concluded,  $y_{12}$  and  $y_{21}$  were both found to be  $-0.1 \text{ S}$ . It is not difficult to show that this equality is also obtained if three general impedances  $\mathbf{Z}_A$ ,  $\mathbf{Z}_B$ , and  $\mathbf{Z}_C$  are contained in this  $\Pi$  network. It is somewhat more difficult to determine the specific conditions which are necessary in order that  $y_{12} = y_{21}$ , but the use of determinant notation is of some help. Let us see if the relationships of Eqs. [10] to [13] can be expressed in terms of the impedance determinant and its minors.

Since our concern is with the two-port and not with the specific networks with which it is terminated, we will let  $\mathbf{V}_1$  and  $\mathbf{V}_2$  be represented by two ideal voltage sources. Equation [10] is applied by letting  $\mathbf{V}_2 = 0$  (thus short-circuiting the output) and finding the input admittance. The network now, however, is simply a one-port, and the input impedance of a one-port was found in Sec. 17.1. We select loop 1 to include the input terminals, and let  $\mathbf{I}_1$  be that loop's current; we identify  $(-\mathbf{I}_2)$  as the loop current in loop 2

and assign the remaining loop currents in any convenient manner. Thus,

$$\mathbf{Z}_{\text{in}}|_{V_2=0} = \frac{\Delta_{\mathbf{Z}}}{\Delta_{11}}$$

and, therefore,

$$\mathbf{y}_{11} = \frac{\Delta_{11}}{\Delta_{\mathbf{Z}}}$$

Similarly,

$$\mathbf{y}_{22} = \frac{\Delta_{22}}{\Delta_{\mathbf{Z}}}$$

In order to find  $\mathbf{y}_{12}$ , we let  $\mathbf{V}_1 = 0$  and find  $\mathbf{I}_1$  as a function of  $\mathbf{V}_2$ . We find that  $\mathbf{I}_1$  is given by the ratio

$$\mathbf{I}_1 = \frac{\begin{vmatrix} 0 & \mathbf{Z}_{12} & \cdots & \mathbf{Z}_{1N} \\ -\mathbf{V}_2 & \mathbf{Z}_{22} & \cdots & \mathbf{Z}_{2N} \\ 0 & \mathbf{Z}_{32} & \cdots & \mathbf{Z}_{3N} \\ \cdots & \cdots & \cdots & \cdots \\ 0 & \mathbf{Z}_{N2} & \cdots & \mathbf{Z}_{NN} \end{vmatrix}}{\begin{vmatrix} \mathbf{Z}_{11} & \mathbf{Z}_{12} & \cdots & \mathbf{Z}_{1N} \\ \mathbf{Z}_{21} & \mathbf{Z}_{22} & \cdots & \mathbf{Z}_{2N} \\ \mathbf{Z}_{31} & \mathbf{Z}_{32} & \cdots & \mathbf{Z}_{3N} \\ \cdots & \cdots & \cdots & \cdots \\ \mathbf{Z}_{N1} & \mathbf{Z}_{N2} & \cdots & \mathbf{Z}_{NN} \end{vmatrix}}$$

Thus,

$$\mathbf{I}_1 = -\frac{(-\mathbf{V}_2)\Delta_{21}}{\Delta_{\mathbf{Z}}}$$

and

$$\mathbf{y}_{12} = \frac{\Delta_{21}}{\Delta_{\mathbf{Z}}}$$

In a similar manner, we may show that

$$\mathbf{y}_{21} = \frac{\Delta_{12}}{\Delta_{\mathbf{Z}}}$$

The equality of  $\mathbf{y}_{12}$  and  $\mathbf{y}_{21}$  is thus contingent on the equality of the two minors of  $\Delta_{\mathbf{Z}}$ — $\Delta_{12}$  and  $\Delta_{21}$ . These two minors are

$$\Delta_{21} = \begin{vmatrix} \mathbf{Z}_{12} & \mathbf{Z}_{13} & \mathbf{Z}_{14} & \cdots & \mathbf{Z}_{1N} \\ \mathbf{Z}_{32} & \mathbf{Z}_{33} & \mathbf{Z}_{34} & \cdots & \mathbf{Z}_{3N} \\ \mathbf{Z}_{42} & \mathbf{Z}_{43} & \mathbf{Z}_{44} & \cdots & \mathbf{Z}_{4N} \\ \cdots & \cdots & \cdots & \cdots & \cdots \\ \mathbf{Z}_{N2} & \mathbf{Z}_{N3} & \mathbf{Z}_{N4} & \cdots & \mathbf{Z}_{NN} \end{vmatrix}$$

and

$$\Delta_{12} = \begin{vmatrix} \mathbf{Z}_{21} & \mathbf{Z}_{23} & \mathbf{Z}_{24} & \cdots & \mathbf{Z}_{2N} \\ \mathbf{Z}_{31} & \mathbf{Z}_{33} & \mathbf{Z}_{34} & \cdots & \mathbf{Z}_{3N} \\ \mathbf{Z}_{41} & \mathbf{Z}_{43} & \mathbf{Z}_{44} & \cdots & \mathbf{Z}_{4N} \\ \cdots & \cdots & \cdots & \cdots & \cdots \\ \mathbf{Z}_{N1} & \mathbf{Z}_{N3} & \mathbf{Z}_{N4} & \cdots & \mathbf{Z}_{NN} \end{vmatrix}$$

Their equality is shown by first interchanging the rows and columns of one minor (for example,  $\Delta_{21}$ ), an operation which any college algebra book proves is valid, and then letting every mutual impedance  $\mathbf{Z}_{ij}$  be replaced by  $\mathbf{Z}_{ji}$ . Thus, we set

$$\mathbf{Z}_{12} = \mathbf{Z}_{21} \quad \mathbf{Z}_{23} = \mathbf{Z}_{32} \quad \text{etc.}$$

This equality of  $\mathbf{Z}_{ij}$  and  $\mathbf{Z}_{ji}$  is evident for the three familiar passive elements—the resistor, capacitor, and inductor—and it is also true for mutual inductance. However, it is *not* true for *every* type of device which we may wish to include inside a two-port network. Specifically, it is not true in general for a dependent source, and it is not true for the gyrator, a useful model for Hall-effect devices and for waveguide sections containing ferrites. Over a narrow range of radian frequencies, the gyrator provides an additional phase shift of  $180^\circ$  for a signal passing from the output to the input over that for a signal in the forward direction, and thus  $\mathbf{y}_{12} = -\mathbf{y}_{21}$ . A common type of passive element leading to the inequality of  $\mathbf{Z}_{ij}$  and  $\mathbf{Z}_{ji}$ , however, is a nonlinear element.

Any device for which  $\mathbf{Z}_{ij} = \mathbf{Z}_{ji}$  is called a *bilateral element*, and a circuit which contains only bilateral elements is called a *bilateral circuit*. We have therefore shown that an important property of a bilateral two-port is

$$\mathbf{y}_{12} = \mathbf{y}_{21}$$

and this property is glorified by stating it as the *reciprocity theorem*:

Another way of stating the theorem is to say that the interchange of an ideal voltage source and an ideal ammeter in any passive, linear, bilateral circuit will not change the ammeter reading.

In any passive linear bilateral network, if the single voltage source  $\mathbf{V}_x$  in branch  $x$  produces the current response  $\mathbf{I}_y$  in branch  $y$ , then the removal of the voltage source from branch  $x$  and its insertion in branch  $y$  will produce the current response  $\mathbf{I}_y$  in branch  $x$ .

If we had been working with the admittance determinant of the circuit and had proved that the minors  $\Delta_{21}$  and  $\Delta_{12}$  of the admittance determinant  $\Delta_{\mathbf{Y}}$  were equal, then we should have obtained the reciprocity theorem in its dual form:

In other words, the interchange of an ideal current source and an ideal voltmeter in any passive linear bilateral circuit will not change the voltmeter reading.

In any passive linear bilateral network, if the single current source  $\mathbf{I}_x$  between nodes  $x$  and  $x'$  produces the voltage response  $\mathbf{V}_y$  between nodes  $y$  and  $y'$ , then the removal of the current source from nodes  $x$  and  $x'$  and its insertion between nodes  $y$  and  $y'$  will produce the voltage response  $\mathbf{V}_y$  between nodes  $x$  and  $x'$ .

## PRACTICE

17.4 In the circuit of Fig. 17.10, let  $\mathbf{I}_1$  and  $\mathbf{I}_2$  represent ideal current sources. Assign the node voltage  $\mathbf{V}_1$  at the input,  $\mathbf{V}_2$  at the output, and  $\mathbf{V}_x$  from the central node to the reference node. Write three nodal equations, eliminate  $\mathbf{V}_x$  to obtain two equations, and then rearrange these equations into the form of Eqs. [5] and [6] so that all four  $\mathbf{y}$  parameters may be read directly from the equations.

17.5 Find  $\mathbf{y}$  for the two-port shown in Fig. 17.12.

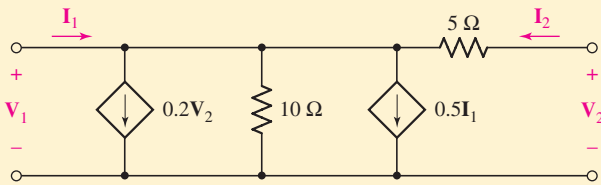

FIGURE 17.12

Ans: 17.4:  $\begin{bmatrix} 0.1192 & -0.1115 \\ -0.1115 & 0.1269 \end{bmatrix}$  (all S). 17.5:  $\begin{bmatrix} 0.6 & 0 \\ -0.2 & 0.2 \end{bmatrix}$  (all S).

### 17.3 SOME EQUIVALENT NETWORKS

When analyzing electronic circuits, it is often necessary to replace the active device (and perhaps some of its associated passivity) with an equivalent two-port containing only three or four impedances. The validity of the equivalent may be restricted to small signal amplitudes and a single frequency, or perhaps a limited range of frequencies. The equivalent is also a linear approximation of a nonlinear circuit. However, if we are faced with a network containing a number of resistors, capacitors, and inductors, plus a transistor labeled 2N3823, then we cannot analyze the circuit by any of the techniques we have studied previously; the transistor must first be replaced by a linear model, just as we replaced the op amp by a linear model in Chap. 6. The  $\mathbf{y}$  parameters provide one such model in the form of a two-port network that is often used at high frequencies. Another common linear model for a transistor appears in Sec. 17.5.

The two equations that determine the short-circuit admittance parameters,

$$\mathbf{I}_1 = y_{11}\mathbf{V}_1 + y_{12}\mathbf{V}_2 \quad [16]$$

$$\mathbf{I}_2 = y_{21}\mathbf{V}_1 + y_{22}\mathbf{V}_2 \quad [17]$$

have the form of a pair of nodal equations written for a circuit containing two nonreference nodes. The determination of an equivalent circuit that leads to Eqs. [16] and [17] is made more difficult by the inequality, in general, of  $y_{12}$  and  $y_{21}$ ; it helps to resort to a little trickery in order to obtain a pair of equations that possess equal mutual coefficients. Let us both add and subtract  $y_{12}\mathbf{V}_1$  (the term we would like to see present on the right side of Eq. [17]):

$$\mathbf{I}_2 = y_{12}\mathbf{V}_1 + y_{22}\mathbf{V}_2 + (y_{21} - y_{12})\mathbf{V}_1 \quad [18]$$

or

$$\mathbf{I}_2 - (y_{21} - y_{12})\mathbf{V}_1 = y_{12}\mathbf{V}_1 + y_{22}\mathbf{V}_2 \quad [19]$$

The right-hand sides of Eqs. [16] and [19] now show the proper symmetry for a bilateral circuit; the left-hand side of Eq. [19] may be interpreted as the algebraic sum of two current sources, one an independent source  $\mathbf{I}_2$  entering node 2, and the other a dependent source  $(y_{21} - y_{12})\mathbf{V}_1$  leaving node 2.

Let us now “read” the equivalent network from Eqs. [16] and [19]. We first provide a reference node, and then a node labeled  $\mathbf{V}_1$  and one labeled  $\mathbf{V}_2$ .

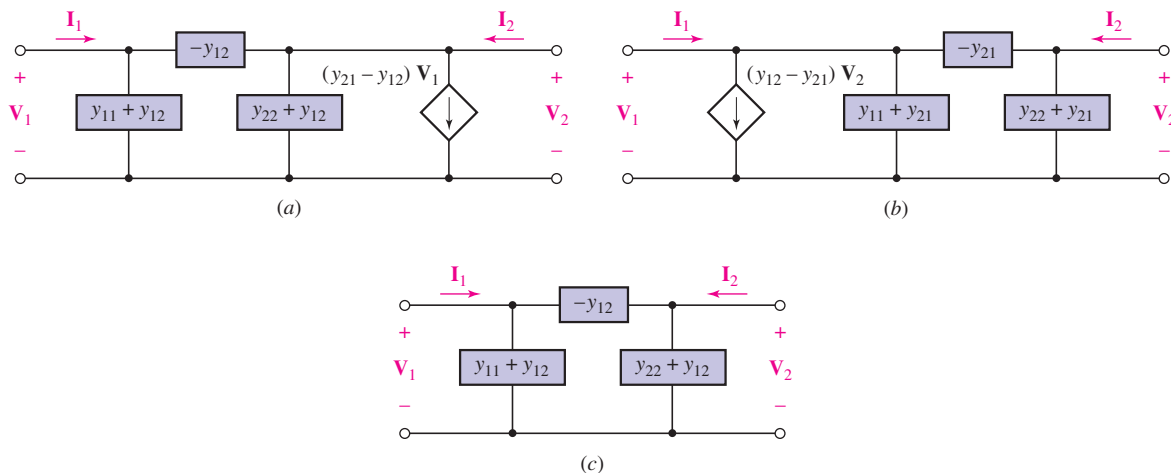

■ FIGURE 17.13 (a, b) Two-ports which are equivalent to any general linear two-port. The dependent source in part (a) depends on  $V_1$ , and that in part (b) depends on  $V_2$ . (c) An equivalent for a bilateral network.

From Eq. [16], we establish the current  $I_1$  flowing into node 1, we supply a mutual admittance ( $-y_{12}$ ) between nodes 1 and 2, and we supply an admittance of  $(y_{11} + y_{12})$  between node 1 and the reference node. With  $V_2 = 0$ , the ratio of  $I_1$  to  $V_1$  is then  $y_{11}$ , as it should be. Now consider Eq. [19]; we cause the current  $I_2$  to flow into the second node, we cause the current  $(y_{21} - y_{12})V_1$  to leave the node, we note that the proper admittance ( $-y_{12}$ ) exists between the nodes, and we complete the circuit by installing the admittance  $(y_{22} + y_{12})$  from node 2 to the reference node. The completed circuit is shown in Fig. 17.13a.

Another form of equivalent network is obtained by subtracting and adding  $y_{21}V_2$  in Eq. [16]; this equivalent circuit is shown in Fig. 17.13b. If the two-port is bilateral, then  $y_{12} = y_{21}$ , and either of the equivalents reduces to a simple passive  $\Pi$  network. The dependent source disappears. This equivalent of the bilateral two-port is shown in Fig. 17.13c.

There are several uses to which these equivalent circuits may be put. In the first place, we have succeeded in showing that an equivalent of any complicated linear two-port *exists*. It does not matter how many nodes or loops are contained within the network; the equivalent is no more complex than the circuits of Fig. 17.13. One of these may be much simpler to use than the given circuit if we are interested only in the terminal characteristics of the given network.

The three-terminal network shown in Fig. 17.14a is often referred to as a  $\Delta$  of impedances, while that in Fig. 17.14b is called a Y. One network may be replaced by the other if certain specific relationships between the impedances are satisfied, and these interrelationships may be established by use of the  $y$  parameters. We find that

$$y_{11} = \frac{1}{Z_A} + \frac{1}{Z_B} = \frac{1}{Z_1 + Z_2 Z_3 / (Z_2 + Z_3)}$$

$$y_{12} = y_{21} = -\frac{1}{Z_B} = \frac{-Z_3}{Z_1 Z_2 + Z_2 Z_3 + Z_3 Z_1}$$

$$y_{22} = \frac{1}{Z_C} + \frac{1}{Z_B} = \frac{1}{Z_2 + Z_1 Z_3 / (Z_1 + Z_3)}$$

■ FIGURE 17.14 The three-terminal  $\Delta$  network (a) and the three-terminal Y network (b) are equivalent if the six impedances satisfy the conditions of the Y- $\Delta$  (or  $\Pi$ -T) transformation, Eqs. [20] to [25].

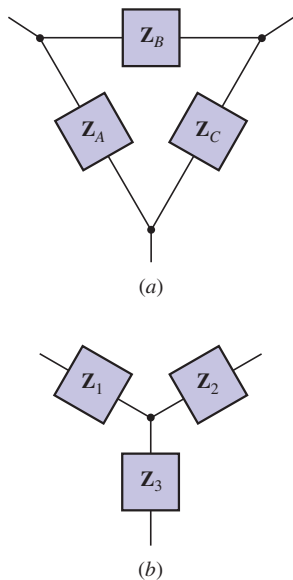

These equations may be solved for  $\mathbf{Z}_A$ ,  $\mathbf{Z}_B$ , and  $\mathbf{Z}_C$  in terms of  $\mathbf{Z}_1$ ,  $\mathbf{Z}_2$ , and  $\mathbf{Z}_3$ :

$$\mathbf{Z}_A = \frac{\mathbf{Z}_1\mathbf{Z}_2 + \mathbf{Z}_2\mathbf{Z}_3 + \mathbf{Z}_3\mathbf{Z}_1}{\mathbf{Z}_2} \quad [20]$$

$$\mathbf{Z}_B = \frac{\mathbf{Z}_1\mathbf{Z}_2 + \mathbf{Z}_2\mathbf{Z}_3 + \mathbf{Z}_3\mathbf{Z}_1}{\mathbf{Z}_3} \quad [21]$$

$$\mathbf{Z}_C = \frac{\mathbf{Z}_1\mathbf{Z}_2 + \mathbf{Z}_2\mathbf{Z}_3 + \mathbf{Z}_3\mathbf{Z}_1}{\mathbf{Z}_1} \quad [22]$$

or, for the inverse relationships:

$$\mathbf{Z}_1 = \frac{\mathbf{Z}_A\mathbf{Z}_B}{\mathbf{Z}_A + \mathbf{Z}_B + \mathbf{Z}_C} \quad [23]$$

$$\mathbf{Z}_2 = \frac{\mathbf{Z}_B\mathbf{Z}_C}{\mathbf{Z}_A + \mathbf{Z}_B + \mathbf{Z}_C} \quad [24]$$

$$\mathbf{Z}_3 = \frac{\mathbf{Z}_C\mathbf{Z}_A}{\mathbf{Z}_A + \mathbf{Z}_B + \mathbf{Z}_C} \quad [25]$$

The reader may recall these useful relationships from Chap. 5, where their derivation was described.

These equations enable us to transform easily between the equivalent Y and  $\Delta$  networks, a process known as the Y- $\Delta$  transformation (or  $\Pi$ -T transformation if the networks are drawn in the forms of those letters). In going from Y to  $\Delta$ , Eqs. [20] to [22], first find the value of the common numerator as the sum of the products of the impedances in the Y taken two at a time. Each impedance in the  $\Delta$  is then found by dividing the numerator by the impedance of that element in the Y which has no common node with the desired  $\Delta$  element. Conversely, given the  $\Delta$ , first take the sum of the three impedances around the  $\Delta$ ; then divide the product of the two  $\Delta$  impedances having a common node with the desired Y element by that sum.

These transformations are often useful in simplifying passive networks, particularly resistive ones, thus avoiding the need for any mesh or nodal analysis.

## EXAMPLE 17.6

Find the input resistance of the circuit shown in Fig. 17.15a.

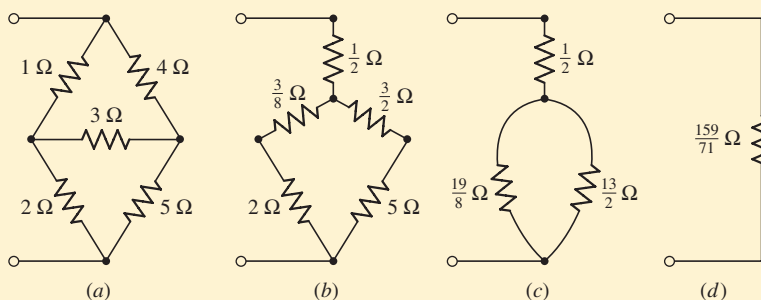

■ FIGURE 17.15 (a) A resistive network whose input resistance is desired. This example is repeated from Chap. 5. (b) The upper  $\Delta$  is replaced by an equivalent Y. (c, d) Series and parallel combinations give the equivalent input resistance  $\frac{159}{71}\Omega$ .

(Continued on next page)

We first make a  $\Delta$ -Y transformation on the upper  $\Delta$  appearing in Fig. 17.15a. The sum of the three resistances forming this  $\Delta$  is  $1 + 4 + 3 = 8 \Omega$ . The product of the two resistors connected to the top node is  $1 \times 4 = 4 \Omega^2$ . Thus, the upper resistor of the Y is  $\frac{4}{8}$ , or  $\frac{1}{2} \Omega$ . Repeating this procedure for the other two resistors, we obtain the network shown in Fig. 17.15b.

We next make the series and parallel combinations indicated, obtaining in succession Fig. 17.15c and d. Thus, the input resistance of the circuit in Fig. 17.15a is found to be  $\frac{159}{71}$ , or  $2.24 \Omega$ .

Now let us tackle a slightly more complicated example, shown as Fig. 17.16. We note that the circuit contains a dependent source, and thus the Y- $\Delta$  transformation is not applicable.

### EXAMPLE 17.7

The circuit shown in Fig. 17.16 is an approximate linear equivalent of a transistor amplifier in which the emitter terminal is the bottom node, the base terminal is the upper input node, and the collector terminal is the upper output node. A  $2000 \Omega$  resistor is connected between collector and base for some special application and makes the analysis of the circuit more difficult. Determine the y parameters for this circuit.

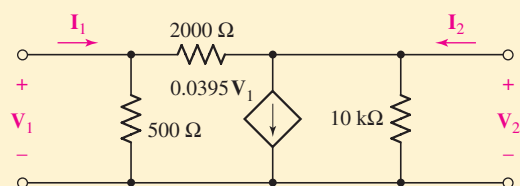

FIGURE 17.16 The linear equivalent circuit of a transistor in common-emitter configuration with resistive feedback between collector and base.

#### ► Identify the goal of the problem.

Cutting through the problem-specific jargon, we realize that we have been presented with a two-port network and require the y parameters.

#### ► Collect the known information.

Figure 17.16 shows a two-port network with  $V_1$ ,  $I_1$ ,  $V_2$ , and  $I_2$  already indicated, and a value for each component has been provided.

#### ► Devise a plan.

There are several ways we might think about this circuit. If we recognize it as being in the form of the equivalent circuit shown in Fig. 17.13a, then we may immediately determine the values of the y parameters. If recognition is not immediate, then the y parameters



may be determined for the two-port by applying the relationships of Eqs. [10] to [13]. We also might avoid any use of two-port analysis methods and write equations directly for the circuit as it stands. The first option seems best in this case.

► **Construct an appropriate set of equations.**

By inspection, we find that  $-y_{21}$  corresponds to the admittance of our 2 k $\Omega$  resistor, that  $y_{11} + y_{12}$  corresponds to the admittance of the 500  $\Omega$  resistor, the gain of the dependent current source corresponds to  $y_{21} - y_{12}$ , and finally that  $y_{22} + y_{12}$  corresponds to the admittance of the 10 k $\Omega$  resistor. Hence we may write

$$y_{12} = -\frac{1}{2000}$$

$$y_{11} = \frac{1}{500} - y_{12}$$

$$y_{21} = 0.0395 + y_{12}$$

$$y_{22} = \frac{1}{10,000} - y_{12}$$

► **Determine if additional information is required.**

With the equations written as they are, we see that once  $y_{12}$  is computed, the remaining  $y$  parameters may also be obtained.

► **Attempt a solution.**

Plugging the numbers into a calculator, we find that

$$y_{12} = -\frac{1}{2000} = -0.5 \text{ mS}$$

$$y_{11} = \frac{1}{500} - \left(-\frac{1}{2000}\right) = 2.5 \text{ mS}$$

$$y_{22} = \frac{1}{10,000} - \left(-\frac{1}{2000}\right) = 0.6 \text{ mS}$$

and

$$y_{21} = 0.0395 + \left(-\frac{1}{2000}\right) = 39 \text{ mS}$$

The following equations must then apply:

$$\mathbf{I}_1 = 2.5\mathbf{V}_1 - 0.5\mathbf{V}_2 \quad [26]$$

$$\mathbf{I}_2 = 39\mathbf{V}_1 + 0.6\mathbf{V}_2 \quad [27]$$

where we are now using units of mA, V, and mS or k $\Omega$ .

► **Verify the solution. Is it reasonable or expected?**

Writing two nodal equations directly from the circuit, we find

$$\mathbf{I}_1 = \frac{\mathbf{V}_1 - \mathbf{V}_2}{2} + \frac{\mathbf{V}_1}{0.5} \quad \text{or} \quad \mathbf{I}_1 = 2.5\mathbf{V}_1 - 0.5\mathbf{V}_2$$

and

$$-39.5\mathbf{V}_1 + \mathbf{I}_2 = \frac{\mathbf{V}_2 - \mathbf{V}_1}{2} + \frac{\mathbf{V}_2}{10} \quad \text{or} \quad \mathbf{I}_2 = 39\mathbf{V}_1 + 0.6\mathbf{V}_2$$

which agree with Eqs. [26] and [27] obtained directly from the  $y$  parameters.

Now let us make use of Eqs. [26] and [27] by analyzing the performance of the two-port in Fig. 17.16 under several different operating conditions. We first provide a current source of  $1/0^\circ$  mA at the input and connect a  $0.5 \text{ k}\Omega$  ( $2 \text{ mS}$ ) load to the output. The terminating networks are therefore both one-ports and give us the following specific information relating  $\mathbf{I}_1$  to  $\mathbf{V}_1$  and  $\mathbf{I}_2$  to  $\mathbf{V}_2$ :

$$\mathbf{I}_1 = 1 \text{ (for any } \mathbf{V}_1) \quad \mathbf{I}_2 = -2\mathbf{V}_2$$

We now have four equations in the four variables,  $\mathbf{V}_1$ ,  $\mathbf{V}_2$ ,  $\mathbf{I}_1$ , and  $\mathbf{I}_2$ . Substituting the two one-port relationships in Eqs. [26] and [27], we obtain two equations relating  $\mathbf{V}_1$  and  $\mathbf{V}_2$ :

$$1 = 2.5\mathbf{V}_1 - 0.5\mathbf{V}_2 \quad 0 = 39\mathbf{V}_1 + 2.6\mathbf{V}_2$$

Solving, we find that

$$\begin{aligned} \mathbf{V}_1 &= 0.1 \text{ V} & \mathbf{V}_2 &= -1.5 \text{ V} \\ \mathbf{I}_1 &= 1 \text{ mA} & \mathbf{I}_2 &= 3 \text{ mA} \end{aligned}$$

These four values apply to the two-port operating with a prescribed input ( $\mathbf{I}_1 = 1 \text{ mA}$ ) and a specified load ( $R_L = 0.5 \text{ k}\Omega$ ).

The performance of an amplifier is often described by giving a few specific values. Let us calculate four of these values for this two-port with its terminations. We will define and evaluate the voltage gain, the current gain, the power gain, and the input impedance.

The *voltage gain*  $\mathbf{G}_V$  is

$$\mathbf{G}_V = \frac{\mathbf{V}_2}{\mathbf{V}_1}$$

From the numerical results, it is easy to see that  $\mathbf{G}_V = -15$ .

The *current gain*  $\mathbf{G}_I$  is defined as

$$\mathbf{G}_I = \frac{\mathbf{I}_2}{\mathbf{I}_1}$$

and we have

$$\mathbf{G}_I = 3$$

Let us define and calculate the *power gain*  $G_P$  for an assumed sinusoidal excitation. We have

$$G_P = \frac{P_{\text{out}}}{P_{\text{in}}} = \frac{\text{Re} \left\{ -\frac{1}{2} \mathbf{V}_2 \mathbf{I}_2^* \right\}}{\text{Re} \left\{ \frac{1}{2} \mathbf{V}_1 \mathbf{I}_1^* \right\}} = 45$$

The device might be termed either a voltage, a current, or a power amplifier, since all the gains are greater than unity. If the  $2 \text{ k}\Omega$  resistor were removed, the power gain would rise to 354.

The input and output impedances of the amplifier are often desired in order that maximum power transfer may be achieved to or from an adjacent two-port. We define the *input impedance*  $\mathbf{Z}_{\text{in}}$  as the ratio of input voltage to current:

$$\mathbf{Z}_{\text{in}} = \frac{\mathbf{V}_1}{\mathbf{I}_1} = 0.1 \text{ k}\Omega$$

This is the impedance offered to the current source when the  $500\ \Omega$  load is connected to the output. (With the output short-circuited, the input impedance is necessarily  $1/y_{11}$ , or  $400\ \Omega$ .)

It should be noted that the input impedance *cannot* be determined by replacing every source with its internal impedance and then combining resistances or conductances. In the given circuit, such a procedure would yield a value of  $416\ \Omega$ . The error, of course, comes from treating the *dependent* source as an *independent* source. If we think of the input impedance as being numerically equal to the input voltage produced by an input current of  $1\ \text{A}$ , the application of the  $1\ \text{A}$  source produces some input voltage  $\mathbf{V}_1$ , and the strength of the dependent source ( $0.0395\mathbf{V}_1$ ) cannot be zero. We should recall that when we obtain the Thévenin equivalent impedance of a circuit containing a dependent source along with one or more independent sources, we must replace the independent sources with short circuits or open circuits, but a dependent source must not be deactivated. Of course, if the voltage or current on which the dependent source depends is zero, then the dependent source will itself be inactive; occasionally a circuit may be simplified by recognizing such an occurrence.

Besides  $\mathbf{G}_V$ ,  $\mathbf{G}_I$ ,  $G_P$ , and  $\mathbf{Z}_{in}$ , there is one other performance parameter that is quite useful. This is the *output impedance*  $\mathbf{Z}_{out}$ , and it is determined for a different circuit configuration.

The output impedance is just another term for the Thévenin impedance appearing in the Thévenin equivalent circuit of that portion of the network faced by the load. In our circuit, which we have assumed is driven by a  $1\angle 0^\circ$  mA current source, we therefore replace this independent source with an open circuit, leave the dependent source alone, and seek the *input* impedance seen looking to the left from the output terminals (with the load removed). Thus, we define

$$\mathbf{Z}_{out} = \mathbf{V}_2 |_{\mathbf{I}_2=1\ \text{A}} \text{ with all other independent sources deactivated and } R_L \text{ removed}$$

We therefore remove the load resistor, apply  $1\angle 0^\circ$  mA (since we are working in V, mA, and  $\text{k}\Omega$ ) at the output terminals, and determine  $\mathbf{V}_2$ . We place these requirements on Eqs. [26] and [27], and obtain

$$0 = 2.5\mathbf{V}_1 - 0.5\mathbf{V}_2 \quad 1 = 39\mathbf{V}_1 + 0.6\mathbf{V}_2$$

Solving,

$$\mathbf{V}_2 = 0.1190\ \text{V}$$

and thus

$$\mathbf{Z}_{out} = 0.1190\ \text{k}\Omega$$

An alternative procedure might be to find the open-circuit output voltage and the short-circuit output current. That is, the Thévenin impedance is the output impedance:

$$\mathbf{Z}_{out} = \mathbf{Z}_{th} = -\frac{\mathbf{V}_{2oc}}{\mathbf{I}_{2sc}}$$

Carrying out this procedure, we first rekindle the independent source so that  $\mathbf{I}_1 = 1\ \text{mA}$ , and then open-circuit the load so that  $\mathbf{I}_2 = 0$ . We have

$$1 = 2.5\mathbf{V}_1 - 0.5\mathbf{V}_2 \quad 0 = 39\mathbf{V}_1 + 0.6\mathbf{V}_2$$



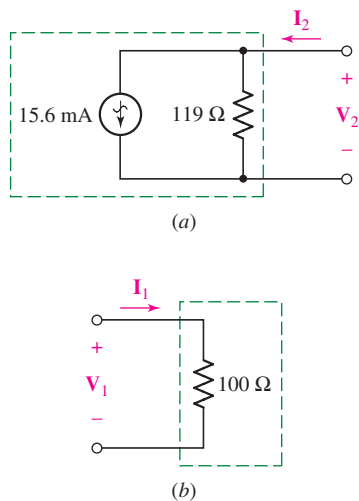

■ FIGURE 17.17 (a) The Norton equivalent of the network in Fig. 17.16 to the left of the output terminal,  $I_1 = 1/0^\circ$  mA. (b) The Thévenin equivalent of that portion of the network to the right of the input terminals, if  $I_2 = -2V_2$  mA.

and thus

$$V_{2oc} = -1.857 \text{ V}$$

Next, we apply short-circuit conditions by setting  $V_2 = 0$  and again let  $I_1 = 1$  mA. We find that

$$I_1 = 1 = 2.5V_1 - 0 \quad I_2 = 39V_1 + 0$$

and thus

$$I_{2sc} = 15.6 \text{ mA}$$

The assumed directions of  $V_2$  and  $I_2$  therefore result in a Thévenin or output impedance

$$Z_{out} = -\frac{V_{2oc}}{I_{2sc}} = -\frac{-1.857}{15.6} = 0.1190 \text{ k}\Omega$$

as before.

We now have enough information to enable us to draw the Thévenin or Norton equivalent of the two-port of Fig. 17.16 when it is driven by a  $1/0^\circ$  mA current source and terminated in a  $500 \Omega$  load. Thus, the Norton equivalent presented to the load must contain a current source equal to the short-circuit current  $I_{2sc}$  in parallel with the output impedance; this equivalent is shown in Fig. 17.17a. Also, the Thévenin equivalent offered to the  $1/0^\circ$  mA input source must consist solely of the input impedance, as drawn in Fig. 17.17b.

Before leaving the  $y$  parameters, we should recognize their usefulness in describing the parallel connection of two-ports, as indicated in Fig. 17.18. When we first defined a port in Sec. 17.1, we noted that the currents entering and leaving the two terminals of a port had to be equal, and there could be no external connections made that bridged between ports. Apparently the parallel connection shown in Fig. 17.18 violates this condition. However, if each two-port has a reference node that is common to its input and output port, and if the two-ports are connected in parallel so that they have a common reference node, then all ports remain ports after the connection. Thus, for the  $A$  network,

$$I_A = y_A V_A$$

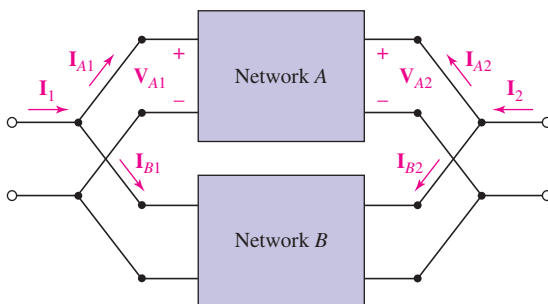

■ FIGURE 17.18 The parallel connection of two two-port networks. If both inputs and outputs have the same reference node, then the admittance matrix  $y = y_A + y_B$ .

where

$$\mathbf{I}_A = \begin{bmatrix} \mathbf{I}_{A1} \\ \mathbf{I}_{A2} \end{bmatrix} \quad \text{and} \quad \mathbf{V}_A = \begin{bmatrix} \mathbf{V}_{A1} \\ \mathbf{V}_{A2} \end{bmatrix}$$

and for the  $B$  network

$$\mathbf{I}_B = \mathbf{y}_B \mathbf{V}_B$$

But

$$\mathbf{V}_A = \mathbf{V}_B = \mathbf{V} \quad \text{and} \quad \mathbf{I} = \mathbf{I}_A + \mathbf{I}_B$$

Thus,

$$\mathbf{I} = (\mathbf{y}_A + \mathbf{y}_B) \mathbf{V}$$

and we see that each  $\mathbf{y}$  parameter of the parallel network is given as the sum of the corresponding parameters of the individual networks,

$$\mathbf{y} = \mathbf{y}_A + \mathbf{y}_B \quad [28]$$

This may be extended to any number of two-ports connected in parallel.

### PRACTICE

17.6 Find  $\mathbf{y}$  and  $\mathbf{Z}_{\text{out}}$  for the terminated two-port shown in Fig. 17.19.

17.7 Use  $\Delta$ - $Y$  and  $Y$ - $\Delta$  transformations to determine  $R_{\text{in}}$  for the network shown in (a) Fig. 17.20a; (b) Fig. 17.20b.

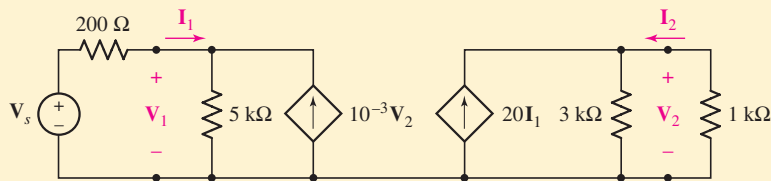

FIGURE 17.19

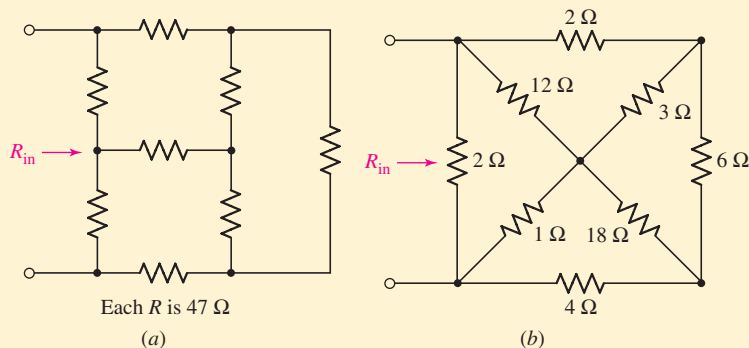

FIGURE 17.20

Ans: 17.6:  $\begin{bmatrix} 2 \times 10^{-4} & -10^{-3} \\ -4 \times 10^{-3} & 20.3 \times 10^{-3} \end{bmatrix}$  (S); 51.1  $\Omega$ . 17.7: 53.71  $\Omega$ , 1.311  $\Omega$ .

## 17.4 IMPEDANCE PARAMETERS

The concept of two-port parameters has been introduced in terms of the short-circuit admittance parameters. There are other sets of parameters, however, and each set is associated with a particular class of networks for which its use provides the simplest analysis. We will consider three other types of parameters, the open-circuit impedance parameters, which are the subject of this section; and the hybrid and the transmission parameters, which are discussed in following sections.

We begin again with a general linear two-port that does not contain any independent sources; the currents and voltages are assigned as before (Fig. 17.8). Now let us consider the voltage  $\mathbf{V}_1$  as the response produced by two current sources  $\mathbf{I}_1$  and  $\mathbf{I}_2$ . We thus write for  $\mathbf{V}_1$

$$\mathbf{V}_1 = \mathbf{z}_{11}\mathbf{I}_1 + \mathbf{z}_{12}\mathbf{I}_2 \quad [29]$$

and for  $\mathbf{V}_2$

$$\mathbf{V}_2 = \mathbf{z}_{21}\mathbf{I}_1 + \mathbf{z}_{22}\mathbf{I}_2 \quad [30]$$

or

$$\mathbf{V} = \begin{bmatrix} \mathbf{V}_1 \\ \mathbf{V}_2 \end{bmatrix} = \mathbf{z}\mathbf{I} = \begin{bmatrix} \mathbf{z}_{11} & \mathbf{z}_{12} \\ \mathbf{z}_{21} & \mathbf{z}_{22} \end{bmatrix} \begin{bmatrix} \mathbf{I}_1 \\ \mathbf{I}_2 \end{bmatrix} \quad [31]$$



Of course, in using these equations it is not necessary that  $\mathbf{I}_1$  and  $\mathbf{I}_2$  be current sources; nor is it necessary that  $\mathbf{V}_1$  and  $\mathbf{V}_2$  be voltage sources. In general, we may have any networks terminating the two-port at either end. As the equations are written, we probably think of  $\mathbf{V}_1$  and  $\mathbf{V}_2$  as given quantities, or independent variables, and  $\mathbf{I}_1$  and  $\mathbf{I}_2$  as unknowns, or dependent variables.

The six ways in which two equations may be written to relate these four quantities define the different systems of parameters. We study the four most important of these six systems of parameters.

The most informative description of the  $\mathbf{z}$  parameters, defined in Eqs. [29] and [30], is obtained by setting each of the currents equal to zero. Thus

$$\mathbf{z}_{11} = \left. \frac{\mathbf{V}_1}{\mathbf{I}_1} \right|_{\mathbf{I}_2=0} \quad [32]$$

$$\mathbf{z}_{12} = \left. \frac{\mathbf{V}_1}{\mathbf{I}_2} \right|_{\mathbf{I}_1=0} \quad [33]$$

$$\mathbf{z}_{21} = \left. \frac{\mathbf{V}_2}{\mathbf{I}_1} \right|_{\mathbf{I}_2=0} \quad [34]$$

$$\mathbf{z}_{22} = \left. \frac{\mathbf{V}_2}{\mathbf{I}_2} \right|_{\mathbf{I}_1=0} \quad [35]$$

Since zero current results from an open-circuit termination, the  $\mathbf{z}$  parameters are known as the *open-circuit impedance parameters*. They are easily related to the short-circuit admittance parameters by solving Eqs. [29] and

[30] for  $\mathbf{I}_1$  and  $\mathbf{I}_2$ :

$$\mathbf{I}_1 = \frac{\begin{vmatrix} \mathbf{V}_1 & \mathbf{z}_{12} \\ \mathbf{V}_2 & \mathbf{z}_{22} \end{vmatrix}}{\begin{vmatrix} \mathbf{z}_{11} & \mathbf{z}_{12} \\ \mathbf{z}_{21} & \mathbf{z}_{22} \end{vmatrix}}$$

or

$$\mathbf{I}_1 = \left( \frac{\mathbf{z}_{22}}{\mathbf{z}_{11}\mathbf{z}_{22} - \mathbf{z}_{12}\mathbf{z}_{21}} \right) \mathbf{V}_1 - \left( \frac{\mathbf{z}_{12}}{\mathbf{z}_{11}\mathbf{z}_{22} - \mathbf{z}_{12}\mathbf{z}_{21}} \right) \mathbf{V}_2$$

Using determinant notation, and being careful that the subscript is a lower-case  $\mathbf{z}$ , we assume that  $\Delta_{\mathbf{z}} \neq 0$  and obtain

$$\mathbf{y}_{11} = \frac{\Delta_{11}}{\Delta_{\mathbf{z}}} = \frac{\mathbf{z}_{22}}{\Delta_{\mathbf{z}}} \quad \mathbf{y}_{12} = -\frac{\Delta_{21}}{\Delta_{\mathbf{z}}} = -\frac{\mathbf{z}_{12}}{\Delta_{\mathbf{z}}}$$

and from solving for  $\mathbf{I}_2$ ,

$$\mathbf{y}_{21} = -\frac{\Delta_{12}}{\Delta_{\mathbf{z}}} = -\frac{\mathbf{z}_{21}}{\Delta_{\mathbf{z}}} \quad \mathbf{y}_{22} = \frac{\Delta_{22}}{\Delta_{\mathbf{z}}} = \frac{\mathbf{z}_{11}}{\Delta_{\mathbf{z}}}$$

In a similar manner, the  $\mathbf{z}$  parameters may be expressed in terms of the admittance parameters. Transformations of this nature are possible between any of the various parameter systems, and quite a collection of occasionally useful formulas may be obtained. Transformations between the  $\mathbf{y}$  and  $\mathbf{z}$  parameters (as well as the  $\mathbf{h}$  and  $\mathbf{t}$  parameters which we will consider in the following sections) are given in Table 17.1 as a helpful reference.

TABLE 17.1 Transformations Between  $\mathbf{y}$ ,  $\mathbf{z}$ ,  $\mathbf{h}$ , and  $\mathbf{t}$  Parameters

	$\mathbf{y}$		$\mathbf{z}$		$\mathbf{h}$		$\mathbf{t}$	
$\mathbf{y}$	$\mathbf{y}_{11}$	$\mathbf{y}_{12}$	$\frac{\mathbf{z}_{22}}{\Delta_{\mathbf{z}}}$	$-\frac{\mathbf{z}_{12}}{\Delta_{\mathbf{z}}}$	$\frac{1}{\mathbf{h}_{11}}$	$-\frac{\mathbf{h}_{12}}{\mathbf{h}_{11}}$	$\frac{\mathbf{t}_{22}}{\mathbf{t}_{12}}$	$-\frac{\Delta_{\mathbf{t}}}{\mathbf{t}_{12}}$
	$\mathbf{y}_{21}$	$\mathbf{y}_{22}$	$-\frac{\mathbf{z}_{21}}{\Delta_{\mathbf{z}}}$	$\frac{\mathbf{z}_{11}}{\Delta_{\mathbf{z}}}$	$\frac{\mathbf{h}_{21}}{\mathbf{h}_{11}}$	$\frac{\Delta_{\mathbf{h}}}{\mathbf{h}_{11}}$	$-\frac{1}{\mathbf{t}_{12}}$	$\frac{\mathbf{t}_{11}}{\mathbf{t}_{12}}$
$\mathbf{z}$	$\frac{\mathbf{y}_{22}}{\Delta_{\mathbf{y}}}$	$-\frac{\mathbf{y}_{12}}{\Delta_{\mathbf{y}}}$	$\mathbf{z}_{11}$	$\mathbf{z}_{12}$	$\frac{\Delta_{\mathbf{h}}}{\mathbf{h}_{22}}$	$\frac{\mathbf{h}_{12}}{\mathbf{h}_{22}}$	$\frac{\mathbf{t}_{11}}{\mathbf{t}_{21}}$	$\frac{\Delta_{\mathbf{t}}}{\mathbf{t}_{21}}$
	$-\frac{\mathbf{y}_{21}}{\Delta_{\mathbf{y}}}$	$\frac{\mathbf{y}_{11}}{\Delta_{\mathbf{y}}}$	$\mathbf{z}_{21}$	$\mathbf{z}_{22}$	$-\frac{\mathbf{h}_{21}}{\mathbf{h}_{22}}$	$\frac{1}{\mathbf{h}_{22}}$	$\frac{1}{\mathbf{t}_{21}}$	$\frac{\mathbf{t}_{22}}{\mathbf{t}_{21}}$
$\mathbf{h}$	$\frac{1}{\mathbf{y}_{11}}$	$-\frac{\mathbf{y}_{12}}{\mathbf{y}_{11}}$	$\frac{\Delta_{\mathbf{z}}}{\mathbf{z}_{22}}$	$\frac{\mathbf{z}_{12}}{\mathbf{z}_{22}}$	$\mathbf{h}_{11}$	$\mathbf{h}_{12}$	$\frac{\mathbf{t}_{12}}{\mathbf{t}_{22}}$	$\frac{\Delta_{\mathbf{t}}}{\mathbf{t}_{22}}$
	$\frac{\mathbf{y}_{21}}{\mathbf{y}_{11}}$	$\frac{\Delta_{\mathbf{y}}}{\mathbf{y}_{11}}$	$-\frac{\mathbf{z}_{21}}{\mathbf{z}_{22}}$	$\frac{1}{\mathbf{z}_{22}}$	$\mathbf{h}_{21}$	$\mathbf{h}_{22}$	$-\frac{1}{\mathbf{t}_{22}}$	$\frac{\mathbf{t}_{21}}{\mathbf{t}_{22}}$
	$-\frac{\mathbf{y}_{22}}{\mathbf{y}_{11}}$	$-\frac{1}{\mathbf{y}_{11}}$	$\frac{\mathbf{z}_{11}}{\mathbf{z}_{22}}$	$\frac{\Delta_{\mathbf{z}}}{\mathbf{z}_{22}}$	$-\frac{\Delta_{\mathbf{h}}}{\mathbf{h}_{22}}$	$-\frac{\mathbf{h}_{11}}{\mathbf{h}_{22}}$	$\mathbf{t}_{11}$	$\mathbf{t}_{12}$
$\mathbf{t}$	$\frac{\mathbf{y}_{21}}{\mathbf{y}_{11}}$	$-\frac{\mathbf{y}_{12}}{\mathbf{y}_{11}}$	$\frac{1}{\mathbf{z}_{21}}$	$\frac{\mathbf{z}_{22}}{\mathbf{z}_{21}}$	$-\frac{\mathbf{h}_{21}}{\mathbf{h}_{21}}$	$-\frac{1}{\mathbf{h}_{21}}$	$\mathbf{t}_{21}$	$\mathbf{t}_{22}$
	$\frac{\mathbf{y}_{22}}{\mathbf{y}_{11}}$	$-\frac{1}{\mathbf{y}_{11}}$	$\frac{\mathbf{z}_{11}}{\mathbf{z}_{21}}$	$\frac{\Delta_{\mathbf{z}}}{\mathbf{z}_{21}}$	$-\frac{\Delta_{\mathbf{h}}}{\mathbf{h}_{21}}$	$-\frac{\mathbf{h}_{11}}{\mathbf{h}_{21}}$	$\mathbf{t}_{11}$	$\mathbf{t}_{12}$

For all parameter sets:  $\Delta_{\mathbf{p}} = \mathbf{p}_{11}\mathbf{p}_{22} - \mathbf{p}_{12}\mathbf{p}_{21}$ .

If the two-port is a bilateral network, reciprocity is present; it is easy to show that this results in the equality of  $z_{12}$  and  $z_{21}$ .

Equivalent circuits may again be obtained from an inspection of Eqs. [29] and [30]; their construction is facilitated by adding and subtracting either  $z_{12}\mathbf{I}_1$  in Eq. [30] or  $z_{21}\mathbf{I}_2$  in Eq. [29]. Each of these equivalent circuits contains a dependent voltage source.

Let us leave the derivation of such an equivalent to some leisure moment, and consider next an example of a rather general nature. Can we construct a general Thévenin equivalent of the two-port, as viewed from the output terminals? It is necessary first to assume a specific input circuit configuration, and we will select an independent voltage source  $\mathbf{V}_s$  (positive sign at top) in series with a generator impedance  $\mathbf{Z}_g$ . Thus

$$\mathbf{V}_s = \mathbf{V}_1 + \mathbf{I}_1\mathbf{Z}_g$$

Combining this result with Eqs. [29] and [30], we may eliminate  $\mathbf{V}_1$  and  $\mathbf{I}_1$  and obtain

$$\mathbf{V}_2 = \frac{z_{21}}{z_{11} + \mathbf{Z}_g} \mathbf{V}_s + \left( z_{22} - \frac{z_{12}z_{21}}{z_{11} + \mathbf{Z}_g} \right) \mathbf{I}_2$$

The Thévenin equivalent circuit may be drawn directly from this equation; it is shown in Fig. 17.21. The output impedance, expressed in terms of the  $z$  parameters, is

$$\mathbf{Z}_{\text{out}} = z_{22} - \frac{z_{12}z_{21}}{z_{11} + \mathbf{Z}_g}$$

If the generator impedance is zero, the simpler expression

$$\mathbf{Z}_{\text{out}} = \frac{z_{11}z_{22} - z_{12}z_{21}}{z_{11}} = \frac{\Delta_z}{\Delta_{22}} = \frac{1}{y_{22}} \quad (\mathbf{Z}_g = 0)$$

is obtained. For this special case, the output *admittance* is identical to  $y_{22}$ , as indicated by the basic relationship of Eq. [13].

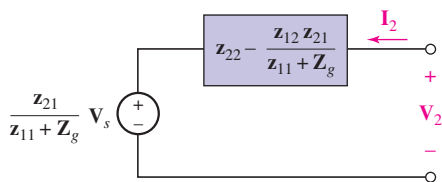

■ FIGURE 17.21 The Thévenin equivalent of a general two-port, as viewed from the output terminals, expressed in terms of the open-circuit impedance parameters.

## EXAMPLE 17.8

Given the set of impedance parameters

$$\mathbf{z} = \begin{bmatrix} 10^3 & 10 \\ -10^6 & 10^4 \end{bmatrix} \quad (\text{all } \Omega)$$

which is representative of a bipolar junction transistor operating in the common-emitter configuration, determine the voltage, current, and power gains, as well as the input and output impedances. The two-port is driven by an ideal sinusoidal voltage source  $\mathbf{V}_s$  in series with a  $500 \Omega$  resistor, and terminated in a  $10 \text{ k}\Omega$  load resistor.

The two describing equations for the two-port are

$$\mathbf{V}_1 = 10^3\mathbf{I}_1 + 10\mathbf{I}_2 \quad [36]$$

$$\mathbf{V}_2 = -10^6\mathbf{I}_1 + 10^4\mathbf{I}_2 \quad [37]$$



and the characterizing equations of the input and output networks are

$$\mathbf{V}_s = 500\mathbf{I}_1 + \mathbf{V}_1 \quad [38]$$

$$\mathbf{V}_2 = -10^4\mathbf{I}_2 \quad [39]$$

From these last four equations, we may easily obtain expressions for  $\mathbf{V}_1$ ,  $\mathbf{I}_1$ ,  $\mathbf{V}_2$ , and  $\mathbf{I}_2$  in terms of  $\mathbf{V}_s$ :

$$\mathbf{V}_1 = 0.75\mathbf{V}_s \quad \mathbf{I}_1 = \frac{\mathbf{V}_s}{2000}$$

$$\mathbf{V}_2 = -250\mathbf{V}_s \quad \mathbf{I}_2 = \frac{\mathbf{V}_s}{40}$$

From this information, it is simple to determine the voltage gain,

$$\mathbf{G}_V = \frac{\mathbf{V}_2}{\mathbf{V}_1} = -333$$

the current gain,

$$\mathbf{G}_I = \frac{\mathbf{I}_2}{\mathbf{I}_1} = 50$$

the power gain,

$$\mathbf{G}_P = \frac{\operatorname{Re}\left\{-\frac{1}{2}\mathbf{V}_2\mathbf{I}_2^*\right\}}{\operatorname{Re}\left\{\frac{1}{2}\mathbf{V}_1\mathbf{I}_1^*\right\}} = 16,670$$

and the input impedance,

$$\mathbf{Z}_{\text{in}} = \frac{\mathbf{V}_1}{\mathbf{I}_1} = 1500 \Omega$$

The output impedance may be obtained by referring to Fig. 17.21:

$$\mathbf{Z}_{\text{out}} = \mathbf{z}_{22} - \frac{\mathbf{z}_{12}\mathbf{z}_{21}}{\mathbf{z}_{11} + \mathbf{Z}_g} = 16.67 \text{ k}\Omega$$

In accordance with the predictions of the maximum power transfer theorem, the power gain reaches a maximum value when  $\mathbf{Z}_L = \mathbf{Z}_{\text{out}}^* = 16.67 \text{ k}\Omega$ ; that maximum value is 17,045.

The  $\mathbf{y}$  parameters are useful when two-ports are interconnected in parallel, and, in a dual manner, the  $\mathbf{z}$  parameters simplify the problem of a series connection of networks, shown in Fig. 17.22. Note that the series connection is *not* the same as the cascade connection that we will discuss later in connection with the transmission parameters. If each two-port has a common reference node for its input and output, and if the references are connected together as indicated in Fig. 17.22, then  $\mathbf{I}_1$  flows through the input ports of the two networks in series. A similar statement holds for  $\mathbf{I}_2$ . Thus, ports remain ports after the interconnection. It follows that  $\mathbf{I} = \mathbf{I}_A = \mathbf{I}_B$  and

$$\begin{aligned} \mathbf{V} &= \mathbf{V}_A + \mathbf{V}_B = \mathbf{z}_A\mathbf{I}_A + \mathbf{z}_B\mathbf{I}_B \\ &= (\mathbf{z}_A + \mathbf{z}_B)\mathbf{I} = \mathbf{z}\mathbf{I} \end{aligned}$$

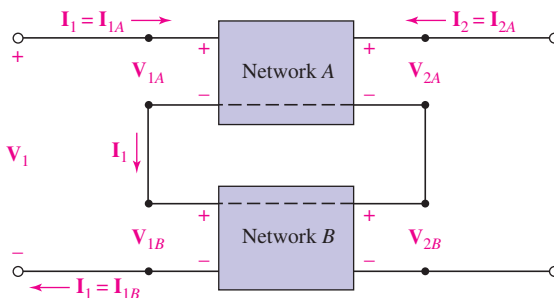

■ FIGURE 17.22 The series connection of two two-port networks is made by connecting the four common reference nodes together; then the matrix  $\mathbf{z} = \mathbf{z}_A + \mathbf{z}_B$ .

where

$$\mathbf{z} = \mathbf{z}_A + \mathbf{z}_B$$

so that  $\mathbf{z}_{11} = \mathbf{z}_{11A} + \mathbf{z}_{11B}$ , and so forth.

### PRACTICE

17.8 Find  $\mathbf{z}$  for the two-port shown in (a) Fig. 17.23a; (b) Fig. 17.23b.

17.9 Find  $\mathbf{z}$  for the two-port shown in Fig. 17.23c.

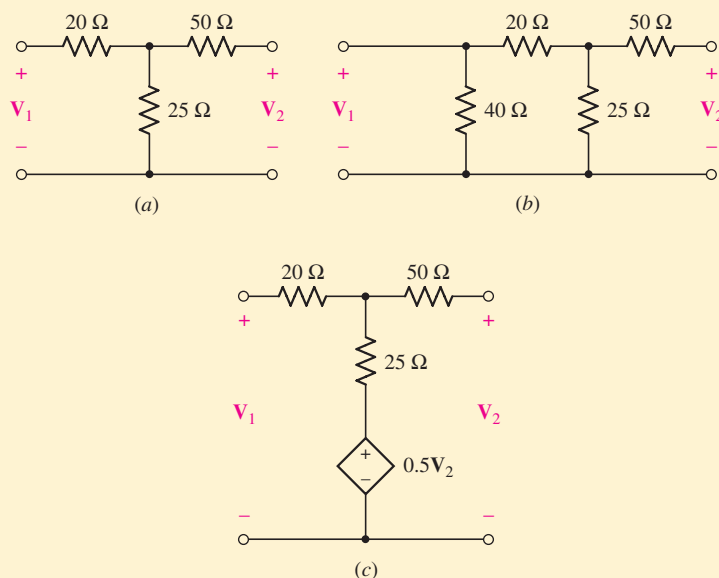

■ FIGURE 17.23

Ans: 17.8:  $\begin{bmatrix} 45 & 25 \\ 25 & 75 \end{bmatrix} (\Omega)$ ,  $\begin{bmatrix} 21.2 & 11.76 \\ 11.76 & 67.6 \end{bmatrix} (\Omega)$ . 17.9:  $\begin{bmatrix} 70 & 100 \\ 50 & 150 \end{bmatrix} (\Omega)$ .

## 17.5 HYBRID PARAMETERS

The difficulty in measuring quantities such as the open-circuit impedance parameters arises when a parameter such as  $z_{21}$  must be measured. A known sinusoidal current is easily supplied at the input terminals, but because of the exceedingly high output impedance of the transistor circuit, it is difficult to open-circuit the output terminals and yet supply the necessary dc biasing voltages and measure the sinusoidal output voltage. A short-circuit current measurement at the output terminals is much simpler to implement.

The hybrid parameters are defined by writing the pair of equations relating  $V_1$ ,  $I_1$ ,  $V_2$ , and  $I_2$  as if  $V_1$  and  $I_2$  were the independent variables:

$$V_1 = h_{11}I_1 + h_{12}V_2 \quad [40]$$

$$I_2 = h_{21}I_1 + h_{22}V_2 \quad [41]$$

or

$$\begin{bmatrix} V_1 \\ I_2 \end{bmatrix} = \mathbf{h} \begin{bmatrix} I_1 \\ V_2 \end{bmatrix} \quad [42]$$

The nature of the parameters is made clear by first setting  $V_2 = 0$ . Thus,

$$h_{11} = \left. \frac{V_1}{I_1} \right|_{V_2=0} = \text{short-circuit input impedance}$$

$$h_{21} = \left. \frac{I_2}{I_1} \right|_{V_2=0} = \text{short-circuit forward current gain}$$

Letting  $I_1 = 0$ , we obtain

$$h_{12} = \left. \frac{V_1}{V_2} \right|_{I_1=0} = \text{open-circuit reverse voltage gain}$$

$$h_{22} = \left. \frac{I_2}{V_2} \right|_{I_1=0} = \text{open-circuit output admittance}$$

Since the parameters represent an impedance, an admittance, a voltage gain, and a current gain, they are called the “hybrid” parameters.

The subscript designations for these parameters are often simplified when they are applied to transistors. Thus,  $h_{11}$ ,  $h_{12}$ ,  $h_{21}$ , and  $h_{22}$  become  $h_i$ ,  $h_r$ ,  $h_f$ , and  $h_o$ , respectively, where the subscripts denote input, reverse, forward, and output.

### EXAMPLE 17.9

#### Find $\mathbf{h}$ for the bilateral resistive circuit drawn in Fig. 17.24.

With the output short-circuited ( $V_2 = 0$ ), the application of a 1 A source at the input ( $I_1 = 1$  A) produces an input voltage of 3.4 V ( $V_1 = 3.4$  V); hence,  $h_{11} = 3.4 \Omega$ . Under these same conditions, the output current is easily obtained by current division:  $I_2 = -0.4$  A; thus,  $h_{21} = -0.4$ .

The remaining two parameters are obtained with the input open-circuited ( $I_1 = 0$ ). We apply 1 V to the output terminals ( $V_2 = 1$  V).

(Continued on next page)

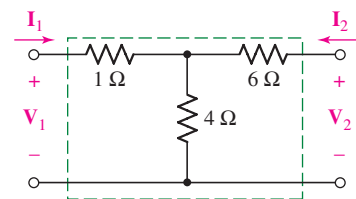

FIGURE 17.24 A bilateral network for which the  $\mathbf{h}$  parameters are found:  $h_{12} = -h_{21}$ .

The response at the input terminals is 0.4 V ( $V_1 = 0.4$  V), and thus  $h_{12} = 0.4$ . The current delivered by this source at the output terminals is 0.1 A ( $I_2 = 0.1$  A), and therefore  $h_{22} = 0.1$  S.

We therefore have  $\mathbf{h} = \begin{bmatrix} 3.4 \Omega & 0.4 \\ -0.4 & 0.1 \text{ S} \end{bmatrix}$ . It is a consequence of the reciprocity theorem that  $h_{12} = -h_{21}$  for a bilateral network.

### PRACTICE

17.10 Find  $\mathbf{h}$  for the two-port shown in (a) Fig. 17.25a; (b) Fig. 17.25b.

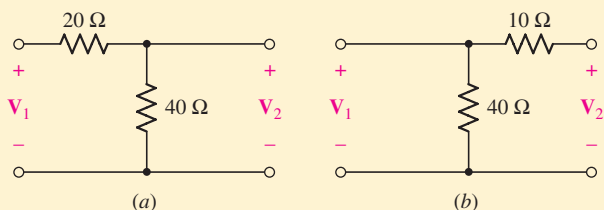

FIGURE 17.25

17.11 If  $\mathbf{h} = \begin{bmatrix} 5 \Omega & 2 \\ -0.5 & 0.1 \text{ S} \end{bmatrix}$ , find (a)  $y$ ; (b)  $z$ .

Ans: 17.10:  $\begin{bmatrix} 20 \Omega & 1 \\ -1 & 25 \text{ ms} \end{bmatrix}$ ,  $\begin{bmatrix} 8 \Omega & 0.8 \\ -0.8 & 20 \text{ ms} \end{bmatrix}$ . 17.11:  $\begin{bmatrix} 0.2 & -0.4 \\ -0.1 & 0.3 \end{bmatrix}$  (S),  
 $\begin{bmatrix} 15 & 20 \\ 5 & 10 \end{bmatrix}$  ( $\Omega$ ).

The circuit shown in Fig. 17.26 is a direct translation of the two defining equations, [40] and [41]. The first represents KVL about the input loop, while the second is obtained from KCL at the upper output node. This circuit is also a popular transistor equivalent circuit. Let us assume some reasonable values for the common-emitter configuration:  $h_{11} = 1200 \Omega$ ,  $h_{12} = 2 \times 10^{-4}$ ,  $h_{21} = 50$ ,  $h_{22} = 50 \times 10^{-6}$  S, a voltage generator of  $1/0^\circ$  mV in series with  $800 \Omega$ , and a  $5 \text{ k}\Omega$  load. For the input,

$$10^{-3} = (1200 + 800)I_1 + 2 \times 10^{-4}V_2$$

and at the output,

$$I_2 = -2 \times 10^{-4}V_2 = 50I_1 + 50 \times 10^{-6}V_2$$

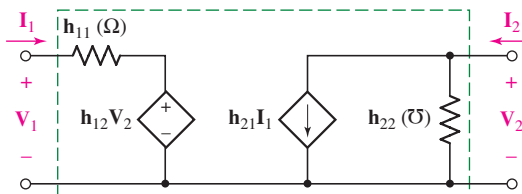

FIGURE 17.26 The four  $h$  parameters are referred to a two-port. The pertinent equations are  $V_1 = h_{11}I_1 + h_{12}V_2$  and  $I_2 = h_{21}I_1 + h_{22}V_2$ .

# PRACTICAL APPLICATION

## Characterizing Transistors

Parameter values for bipolar junction transistors are commonly quoted in terms of  $h$  parameters. Invented in the late 1940s by researchers at Bell Laboratories (Fig. 17.27), the transistor is a nonlinear three-terminal passive semiconductor device that forms the basis for almost all amplifiers and digital logic circuits.



■ FIGURE 17.27 Photograph of the first demonstrated bipolar junction transistor (“bjt”).

Lucent Technologies Inc/Bell Labs

The three terminals of a transistor are labeled the *base* ( $b$ ), *collector* ( $c$ ), and *emitter* ( $e$ ) as shown in Fig. 17.28, and are named after their roles in the transport of charge within the device. The  $h$  parameters of a bipolar junction transistor are typically measured with the emitter terminal grounded, also known as the *common-emitter* configuration; the base is then designated as the input and the collector as the output. As mentioned previously, however, the transistor is a nonlinear device, and so definition of  $h$  parameters which

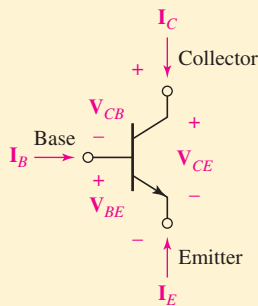

■ FIGURE 17.28 Schematic of a bjt showing currents and voltages defined using the IEEE convention.

are valid for all voltages and currents is not possible. Therefore, it is common practice to quote  $h$  parameters at a specific value of collector current  $I_C$  and collector-emitter voltage  $V_{CE}$ . Another consequence of the nonlinearity of the device is that ac  $h$  parameters and dc  $h$  parameters are often quite different in value.

There are many types of instruments which may be employed to obtain the  $h$  parameters for a particular transistor. One example is a semiconductor parameter analyzer, shown in Fig. 17.29. This instrument sweeps the desired current (plotted on the vertical axis) against a specified voltage (plotted on the horizontal axis). A “family” of curves is produced by varying a third parameter, often the base current, in discrete steps.

As an example, the manufacturer of the 2N3904 NPN silicon transistor quotes  $h$  parameters as indicated in Table 17.2; note that the specific parameters are given alternative designations ( $h_{ie}$ ,  $h_{re}$ , etc.) by transistor engineers. The measurements were made at  $I_C = 1.0$  mA,  $V_{CE} = 10$  V dc, and  $f = 1.0$  kHz.

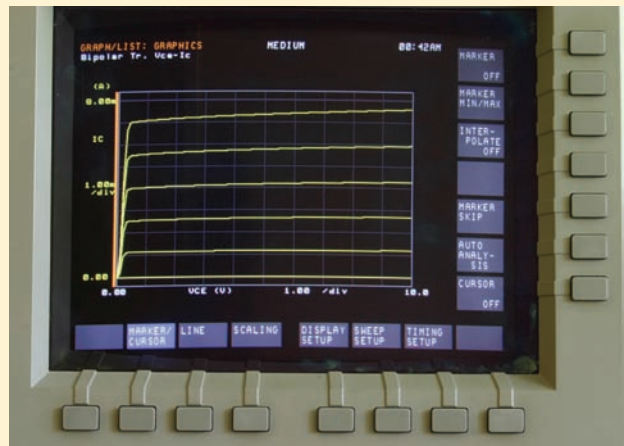

■ FIGURE 17.29 Display snapshot of an HP 4155A Semiconductor Parameter Analyzer used to measure the  $h$  parameters of a 2N3904 bipolar junction transistor (bjt).

Just for fun, one of the authors and a friend decided to measure these parameters for themselves. Grabbing an inexpensive device off the shelf and using the instrument in Fig. 17.29, they found

$$\begin{aligned} h_{oe} &= 3.3 \mu\text{mhos} & h_{fe} &= 109 \\ h_{ie} &= 3.02 \text{ k}\Omega & h_{re} &= 4 \times 10^{-3} \end{aligned}$$

(Continued on next page)

TABLE 17.2 Summary of 2N3904 AC Parameters

Parameter	Name	Specification	Units
$h_{ie}$ ( $h_{11}$ )	Input impedance	1.0–10	k $\Omega$
$h_{re}$ ( $h_{12}$ )	Voltage feedback ratio	$0.5\text{--}8.0 \times 10^{-4}$	–
$h_{fe}$ ( $h_{21}$ )	Small-signal current gain	100–400	–
$h_{oe}$ ( $h_{22}$ )	Output admittance	1.0–40	$\mu\text{mhos}$

the first three of which were all well within the manufacturer’s published tolerances, although much closer to the minimum values than to the maximum values. The value for  $h_{re}$ , however, was an order of magnitude larger than the maximum value specified by the manufacturer’s datasheet! This was rather disconcerting, as we thought we were doing pretty well up to that point.

Upon further reflection, we realized that the experimental setup allowed the device to heat up during the

measurement, as we were sweeping below and above  $I_C = 1$  mA. Transistors, unfortunately, can change their properties rather dramatically as a function of temperature; the manufacturer values were specifically for 25°C. Once the sweep was changed to minimize device heating, we obtained a value of  $2.0 \times 10^{-4}$  for  $h_{re}$ . Linear circuits are by far much easier to work with, but nonlinear circuits can be much more interesting!

Solving,

$$\begin{aligned} \mathbf{I}_1 &= 0.510 \mu\text{A} & \mathbf{V}_1 &= 0.592 \text{ mV} \\ \mathbf{I}_2 &= 20.4 \mu\text{A} & \mathbf{V}_2 &= -102 \text{ mV} \end{aligned}$$

Through the transistor we have a current gain of 40, a voltage gain of  $-172$ , and a power gain of 6880. The input impedance to the transistor is 1160  $\Omega$ , and a few more calculations show that the output impedance is 22.2 k $\Omega$ .



Hybrid parameters may be added directly when two-ports are connected in series at the input and in parallel at the output. This is called a series-parallel interconnection, and it is not used very often.

## 17.6 TRANSMISSION PARAMETERS

The last two-port parameters that we will consider are called the *t parameters*, the *ABCD parameters*, or simply the *transmission parameters*. They are defined by

$$\mathbf{V}_1 = \mathbf{t}_{11}\mathbf{V}_2 - \mathbf{t}_{12}\mathbf{I}_2 \quad [43]$$

and

$$\mathbf{I}_1 = \mathbf{t}_{21}\mathbf{V}_2 - \mathbf{t}_{22}\mathbf{I}_2 \quad [44]$$

or

$$\begin{bmatrix} \mathbf{V}_1 \\ \mathbf{I}_1 \end{bmatrix} = \mathbf{t} \begin{bmatrix} \mathbf{V}_2 \\ -\mathbf{I}_2 \end{bmatrix} \quad [45]$$

where  $\mathbf{V}_1$ ,  $\mathbf{V}_2$ ,  $\mathbf{I}_1$ , and  $\mathbf{I}_2$  are defined as usual (Fig. 17.8). The minus signs that appear in Eqs. [43] and [44] should be associated with the output

current, as  $(-I_2)$ . Thus, both  $I_1$  and  $-I_2$  are directed to the right, the direction of energy or signal transmission.

Other widely used nomenclature for this set of parameters is

$$\begin{bmatrix} \mathbf{t}_{11} & \mathbf{t}_{12} \\ \mathbf{t}_{21} & \mathbf{t}_{22} \end{bmatrix} = \begin{bmatrix} \mathbf{A} & \mathbf{B} \\ \mathbf{C} & \mathbf{D} \end{bmatrix} \quad [46]$$

Note that there are no minus signs in the  $\mathbf{t}$  or **ABCD** matrices.

Looking again at Eqs. [43] to [45], we see that the quantities on the left, often thought of as the given or independent variables, are the input voltage and current,  $V_1$  and  $I_1$ ; the dependent variables,  $V_2$  and  $I_2$ , are the output quantities. Thus, the transmission parameters provide a direct relationship between input and output. Their major use arises in transmission-line analysis and in cascaded networks.

Let us find the  $\mathbf{t}$  parameters for the bilateral resistive two-port of Fig. 17.30a. To illustrate one possible procedure for finding a single parameter, consider

$$\mathbf{t}_{12} = \left. \frac{V_1}{-I_2} \right|_{V_2=0}$$

We therefore short-circuit the output ( $V_2 = 0$ ) and set  $V_1 = 1$  V, as shown in Fig. 17.30b. Note that we cannot set the denominator equal to unity by placing a 1 A current source at the output; we already have a short circuit there. The equivalent resistance offered to the 1 V source is  $R_{\text{eq}} = 2 + (4 \parallel 10) \Omega$ , and we then use current division to get

$$-I_2 = \frac{1}{2 + (4 \parallel 10)} \times \frac{10}{10 + 4} = \frac{5}{34} \text{ A}$$

Hence,

$$\mathbf{t}_{12} = \frac{1}{-I_2} = \frac{34}{5} = 6.8 \Omega$$

If it is necessary to find all four parameters, we write any convenient pair of equations using all four terminal quantities,  $V_1$ ,  $V_2$ ,  $I_1$ , and  $I_2$ . From Fig. 17.30a, we have two mesh equations:

$$V_1 = 12I_1 + 10I_2 \quad [47]$$

$$V_2 = 10I_1 + 14I_2 \quad [48]$$

Solving Eq. [48] for  $I_1$ , we get

$$I_1 = 0.1V_2 - 1.4I_2$$

so that  $\mathbf{t}_{21} = 0.1$  S and  $\mathbf{t}_{22} = 1.4$ . Substituting the expression for  $I_1$  in Eq. [47], we find

$$V_1 = 12(0.1V_2 - 1.4I_2) + 10I_2 = 1.2V_2 - 6.8I_2$$

and  $\mathbf{t}_{11} = 1.2$  and  $\mathbf{t}_{12} = 6.8 \Omega$ , once again.

For reciprocal networks, the determinant of the  $\mathbf{t}$  matrix is equal to unity:

$$\Delta_{\mathbf{t}} = \mathbf{t}_{11}\mathbf{t}_{22} - \mathbf{t}_{12}\mathbf{t}_{21} = 1$$

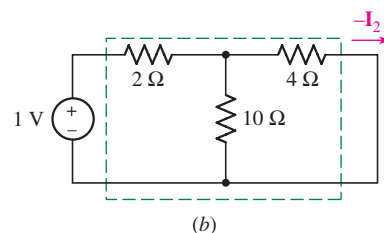
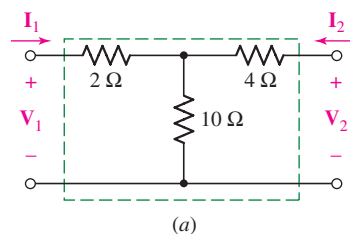
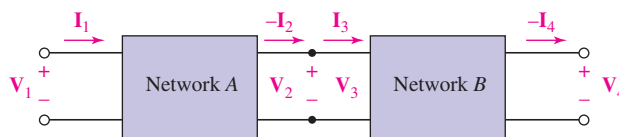

FIGURE 17.30 (a) A two-port resistive network for which the  $\mathbf{t}$  parameters are to be found. (b) To find  $\mathbf{t}_{12}$ , set  $V_1 = 1$  V with  $V_2 = 0$ ; then  $\mathbf{t}_{12} = 1/(-I_2) = 6.8 \Omega$ .

In the resistive example of Fig. 17.30,  $\Delta_t = 1.2 \times 1.4 - 6.8 \times 0.1 = 1$ . Good!

We conclude our two-port discussion by connecting two two-ports in cascade, as illustrated for two networks in Fig. 17.31. Terminal voltages and currents are indicated for each two-port, and the corresponding  $\mathbf{t}$  parameter relationships are, for network  $A$ ,



■ FIGURE 17.31 When two-port networks  $A$  and  $B$  are cascaded, the  $\mathbf{t}$  parameter matrix for the combined network is given by the matrix product  $\mathbf{t} = \mathbf{t}_A \mathbf{t}_B$ .

$$\begin{bmatrix} \mathbf{V}_1 \\ \mathbf{I}_1 \end{bmatrix} = \mathbf{t}_A \begin{bmatrix} \mathbf{V}_2 \\ -\mathbf{I}_2 \end{bmatrix} = \mathbf{t}_A \begin{bmatrix} \mathbf{V}_3 \\ \mathbf{I}_3 \end{bmatrix}$$

and for network  $B$ ,

$$\begin{bmatrix} \mathbf{V}_3 \\ \mathbf{I}_3 \end{bmatrix} = \mathbf{t}_B \begin{bmatrix} \mathbf{V}_4 \\ -\mathbf{I}_4 \end{bmatrix}$$

Combining these results, we have

$$\begin{bmatrix} \mathbf{V}_1 \\ \mathbf{I}_1 \end{bmatrix} = \mathbf{t}_A \mathbf{t}_B \begin{bmatrix} \mathbf{V}_4 \\ -\mathbf{I}_4 \end{bmatrix}$$

Therefore, the  $\mathbf{t}$  parameters for the cascaded networks are found by the matrix product,

$$\mathbf{t} = \mathbf{t}_A \mathbf{t}_B$$



This product is *not* obtained by multiplying corresponding elements in the two matrices. If necessary, review the correct procedure for matrix multiplication in Appendix 2.

## EXAMPLE 17.10

Find the  $\mathbf{t}$  parameters for the cascaded networks shown in Fig. 17.32.

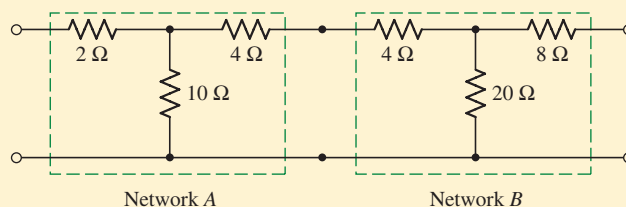

■ FIGURE 17.32 A cascaded connection.



Network  $A$  is the two-port of Fig. 17.32, and, therefore

$$\mathbf{t}_A = \begin{bmatrix} 1.2 & 6.8 \Omega \\ 0.1 \text{ S} & 1.4 \end{bmatrix}$$

while network  $B$  has resistance values twice as large, so that

$$\mathbf{t}_B = \begin{bmatrix} 1.2 & 13.6 \Omega \\ 0.05 \text{ S} & 1.4 \end{bmatrix}$$

For the combined network,

$$\begin{aligned} \mathbf{t} &= \mathbf{t}_A \mathbf{t}_B = \begin{bmatrix} 1.2 & 6.8 \\ 0.1 & 1.4 \end{bmatrix} \begin{bmatrix} 1.2 & 13.6 \\ 0.05 & 1.4 \end{bmatrix} \\ &= \begin{bmatrix} 1.2 \times 1.2 + 6.8 \times 0.05 & 1.2 \times 13.6 + 6.8 \times 1.4 \\ 0.1 \times 1.2 + 1.4 \times 0.05 & 0.1 \times 13.6 + 1.4 \times 1.4 \end{bmatrix} \end{aligned}$$

and

$$\mathbf{t} = \begin{bmatrix} 1.78 & 25.84 \Omega \\ 0.19 \text{ S} & 3.32 \end{bmatrix}$$

### PRACTICE

17.12 Given  $\mathbf{t} = \begin{bmatrix} 3.2 & 8 \Omega \\ 0.2 \text{ S} & 4 \end{bmatrix}$ , find (a)  $\mathbf{z}$ ; (b)  $\mathbf{t}$  for two identical networks in cascade; (c)  $\mathbf{z}$  for two identical networks in cascade.

Ans:  $\begin{bmatrix} 16 & 56 \\ 5 & 20 \end{bmatrix} (\Omega)$ ;  $\begin{bmatrix} 11.84 & 57.6 \Omega \\ 1.44 \text{ S} & 17.6 \end{bmatrix}$ ;  $\begin{bmatrix} 8.22 & 87.1 \\ 0.694 & 12.22 \end{bmatrix} (\Omega)$ .

### COMPUTER-AIDED ANALYSIS

The characterization of two-port networks using  $\mathbf{t}$  parameters creates the opportunity for vastly simplified analysis of cascaded two-port network circuits. As seen in this section, where, for example,

$$\mathbf{t}_A = \begin{bmatrix} 1.2 & 6.8 \Omega \\ 0.1 \text{ S} & 1.4 \end{bmatrix}$$

and

$$\mathbf{t}_B = \begin{bmatrix} 1.2 & 13.6 \Omega \\ 0.05 \text{ S} & 1.4 \end{bmatrix}$$

we found that the  $\mathbf{t}$  parameters characterizing the cascaded network can be found by simply multiplying  $\mathbf{t}_A$  and  $\mathbf{t}_B$ :

$$\mathbf{t} = \mathbf{t}_A \cdot \mathbf{t}_B$$

Such matrix operations are easily carried out using scientific calculators or software packages such as MATLAB. The MATLAB script,

*(Continued on next page)*

for example, would be

```
EDU> tA = [1.2 6.8; 0.1 1.4];
EDU> tB = [1.2 13.6; 0.05 1.4];
EDU> t = tA*tB
```

```
t =
```

```
1.7800    25.8400
0.1900    3.3200
```

as we found in Example 17.10.

In terms of entering matrices in MATLAB, each has a case-sensitive variable name ( $t_A$ ,  $t_B$ , and  $t$  in this example). Matrix elements are entered a row at a time, beginning with the top row; rows are separated by a semicolon. Again, the reader should always be careful to remember that the order to operations is critical when performing matrix algebra. For example,  $t_B \cdot t_A$  results in a totally different matrix than the one we sought:

$$t_B \cdot t_A = \begin{bmatrix} 2.8 & 27.2 \\ 0.2 & 2.3 \end{bmatrix}$$

For simple matrices such as seen in this example, a scientific calculator is just as handy (if not more so). However, larger cascaded networks are more easily handled on a computer, where it is more convenient to see all arrays on the screen simultaneously.

## SUMMARY AND REVIEW

In this chapter we encountered a somewhat abstract way to represent networks. This new approach is especially useful if the network is *passive*, and will either be connected somehow to other networks at some point, or perhaps component values will frequently be changed. We introduced the concept through the idea of a *one-port network*, where all we really did was determine the Thévenin equivalent resistance (or impedance, more generally speaking). Our first exposure to the idea of a two-port network (perhaps one port is an input, the other an output?) was through admittance parameters, also called  $y$  parameters. The result is a matrix which, when multiplied by the vector containing the terminal voltages, yields a vector with the currents into each port. A little manipulation yielded what we called  $\Delta$ -Y equivalents in Chap. 5. The direct counterpart to  $y$  parameters are  $z$  parameters, where each matrix element is the ratio of a voltage to a current. Occasionally  $y$  and  $z$  parameters are not particularly convenient, so we also introduced “hybrid” or  $h$  parameters, as well as “transmission” or  $t$  parameters, also referred to as  $ABCD$  parameters.

Table 17.1 summarizes the conversion process between  $y$ ,  $z$ ,  $h$ , and  $t$  parameters; having one set of parameters which completely describes a network is sufficient regardless of what type of matrix we prefer for a particular analysis.

As a convenience to the reader, we will now proceed directly to a list of key concepts in the chapter, along with corresponding examples.

- In order to employ the analysis methods described in this chapter, it is critical to remember that each port can only be connected to either a one-port network or a port of another multiport network.
- The input impedance of a one-port (*passive*) linear network can be obtained using either nodal or mesh analysis; in some instances the set of coefficients can be written directly by inspection. (Examples 17.1, 17.2, 17.3)
- The defining equations for analyzing a two-port network in terms of its admittance ( $\mathbf{y}$ ) parameters are:

$$\mathbf{I}_1 = y_{11}\mathbf{V}_1 + y_{12}\mathbf{V}_2 \quad \text{and} \quad \mathbf{I}_2 = y_{21}\mathbf{V}_1 + y_{22}\mathbf{V}_2$$

where

$$y_{11} = \left. \frac{\mathbf{I}_1}{\mathbf{V}_1} \right|_{\mathbf{V}_2=0} \quad y_{12} = \left. \frac{\mathbf{I}_1}{\mathbf{V}_2} \right|_{\mathbf{V}_1=0}$$

$$y_{21} = \left. \frac{\mathbf{I}_2}{\mathbf{V}_1} \right|_{\mathbf{V}_2=0} \quad \text{and} \quad y_{22} = \left. \frac{\mathbf{I}_2}{\mathbf{V}_2} \right|_{\mathbf{V}_1=0}$$

(Examples 17.4, 17.5, 17.7)

- The defining equations for analyzing a two-port network in terms of its impedance ( $\mathbf{z}$ ) parameters are:

$$\mathbf{V}_1 = z_{11}\mathbf{I}_1 + z_{12}\mathbf{I}_2 \quad \text{and} \quad \mathbf{V}_2 = z_{21}\mathbf{I}_1 + z_{22}\mathbf{I}_2$$

(Example 17.8)

- The defining equations for analyzing a two-port network in terms of its hybrid ( $\mathbf{h}$ ) parameters are:

$$\mathbf{V}_1 = \mathbf{h}_{11}\mathbf{I}_1 + \mathbf{h}_{12}\mathbf{V}_2 \quad \text{and} \quad \mathbf{I}_2 = \mathbf{h}_{21}\mathbf{I}_1 + \mathbf{h}_{22}\mathbf{V}_2$$

(Example 17.9)

- The defining equations for analyzing a two-port network in terms of its transmission ( $\mathbf{t}$ ) parameters (also called the **ABCD** parameters) are:

$$\mathbf{V}_1 = t_{11}\mathbf{V}_2 - t_{12}\mathbf{I}_2 \quad \text{and} \quad \mathbf{I}_1 = t_{21}\mathbf{V}_2 - t_{22}\mathbf{I}_2$$

(Example 17.10)

- It is straightforward to convert between  $\mathbf{h}$ ,  $\mathbf{z}$ ,  $\mathbf{t}$ , and  $\mathbf{y}$  parameters, depending on circuit analysis needs; the transformations are summarized in Table 17.1. (Example 17.6)

## READING FURTHER

Further details of matrix methods for circuit analysis can be found in:

R. A. DeCarlo and P. M. Lin, *Linear Circuit Analysis*, 2nd ed. New York: Oxford University Press, 2001.

Analysis of transistor circuits using network parameters is described in:

W. H. Hayt, Jr., and G. W. Neudeck, *Electronic Circuit Analysis and Design*, 2nd ed. New York: Wiley, 1995.

## EXERCISES

## 17.1 One-Port Networks

1. Consider the following system of equations:

$$-2\mathbf{I}_1 + 4\mathbf{I}_2 = 3$$

$$5\mathbf{I}_1 + \mathbf{I}_2 - 9\mathbf{I}_3 = 0$$

$$2\mathbf{I}_1 - 5\mathbf{I}_2 + 4\mathbf{I}_3 = -1$$

(a) Write the set of equations in matrix form. (b) Determine  $\Delta_Z$  and  $\Delta_{I_1}$ . (c) Calculate  $\mathbf{I}_1$ .

2. For the following system of equations,

$$100\mathbf{V}_1 - 45\mathbf{V}_2 + 30\mathbf{V}_3 = 0.2$$

$$75\mathbf{V}_1 + 80\mathbf{V}_3 = -0.1$$

$$48\mathbf{V}_1 + 200\mathbf{V}_2 + 42\mathbf{V}_3 = 0.5$$

(a) Write the set of equations in matrix form. (b) Use  $\Delta_Y$  to calculate  $\mathbf{V}_2$  only.

3. With regard to the passive network depicted in Fig. 17.33, (a) obtain the four mesh equations; (b) compute  $\Delta_Z$ ; and (c) calculate the input impedance.

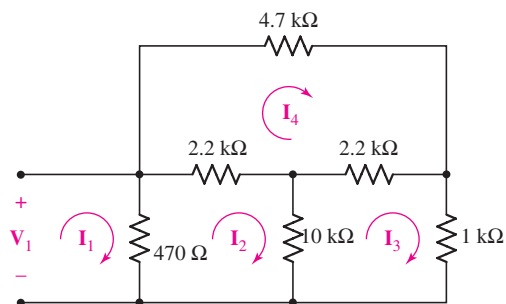

FIGURE 17.33

4. Determine the input impedance of the network shown in Fig. 17.34 after first calculating  $\Delta_Z$ .

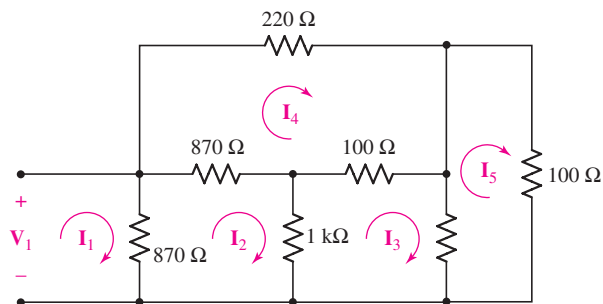

FIGURE 17.34

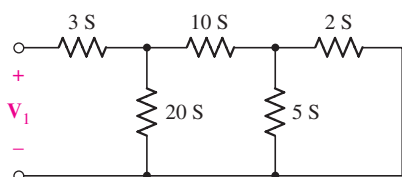
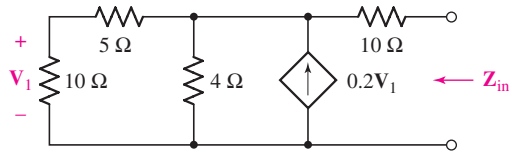

FIGURE 17.35

5. For the one-port network represented schematically in Fig. 17.35, choose the bottom node as the reference; name the junction between the 3, 10, and 20 S conductances  $\mathbf{V}_2$  and the remaining node  $\mathbf{V}_3$ . (a) Write the three nodal equations. (b) Compute  $\Delta_Y$ . (c) Calculate the input admittance.

6. Calculate  $\Delta_Z$  and  $Z_{in}$  for the network of Fig. 17.36 if  $\omega$  is equal to (a) 1 rad/s; (b) 320 krad/s.
7. Set  $\omega = 100\pi$  rad/s in the one-port of Fig. 17.36. (a) Calculate  $\Delta_Y$  and the input admittance at  $\omega$ ,  $Y_{in}(\omega)$ . (b) A sinusoidal current source having magnitude 100 A, frequency  $100\pi$  rad/s, and  $0^\circ$  phase is connected to the network. Calculate the voltage across the current source (express answer as a phasor).
8. With reference to the one-port of Fig. 17.37, which contains a dependent current source controlled by a resistor voltage, (a) calculate  $\Delta_Z$ ; (b) compute  $Z_{in}$ .



■ FIGURE 17.37

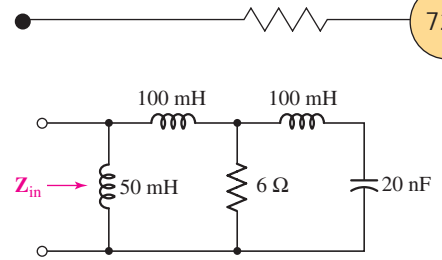

■ FIGURE 17.36

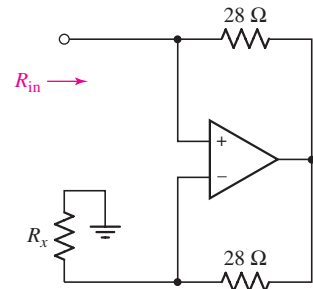

■ FIGURE 17.38

9. For the ideal op amp circuit represented in Fig. 17.38, the input resistance is defined by looking between the positive input terminal of the op amp and ground. (a) Write the appropriate nodal equations for the one-port. (b) Obtain an expression for  $R_{in}$ . Is your answer somewhat unexpected? Explain.
10. (a) If both the op amps shown in the circuit of Fig. 17.39 are assumed to be ideal ( $R_i = \infty$ ,  $R_o = 0$ , and  $A = \infty$ ), find  $Z_{in}$ . (b)  $R_1 = 4$  k $\Omega$ ,  $R_2 = 10$  k $\Omega$ ,  $R_3 = 10$  k $\Omega$ ,  $R_4 = 1$  k $\Omega$ , and  $C = 200$  pF; show that  $Z_{in} = j\omega L_{in}$ , where  $L_{in} = 0.8$  mH.

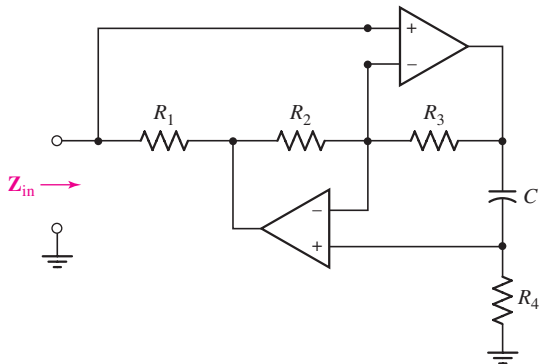

■ FIGURE 17.39

## 17.2 Admittance Parameters

11. Obtain a complete set of  $y$  parameters which describe the two-port shown in Fig. 17.40.

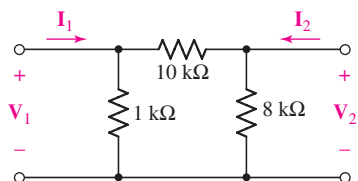

■ FIGURE 17.40

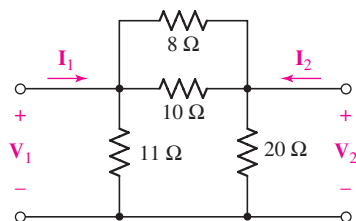

FIGURE 17.41

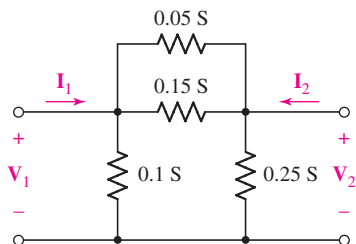

FIGURE 17.42

12. (a) Determine the short-circuit admittance parameters which completely describe the two-port network of Fig. 17.41. (b) If  $V_1 = 3$  V and  $V_2 = -2$  V, use your answer in part (a) to compute  $I_1$  and  $I_2$ .
13. (a) Determine the  $y$  parameters for the two-port of Fig. 17.42. (b) Define the bottom node of Fig. 17.42 as the reference node, and apply nodal analysis to obtain expressions for  $I_1$  and  $I_2$  in terms of  $V_1$  and  $V_2$ . Use these expressions to write down the admittance matrix. (c) If  $V_1 = 2V_2 = 10$  V, calculate the power dissipated in the 100 mS conductance.
14. Obtain an complete set of  $y$  parameters to describe the two-port network depicted in Fig. 17.43.

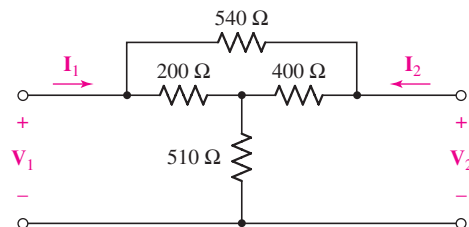

FIGURE 17.43

15. The circuit of Fig. 17.44 is simply the two-port of Fig. 17.40 terminated by a passive one-port and a separate one-port consisting of a voltage source in series with a resistor. (a) Determine the complete set of admittance parameters which describe the two-port network. (*Hint*: draw the two-port by itself, properly labeled with a voltage and current at each port.) (b) Calculate the power dissipated in the passive one-port, using your answer to part (a).

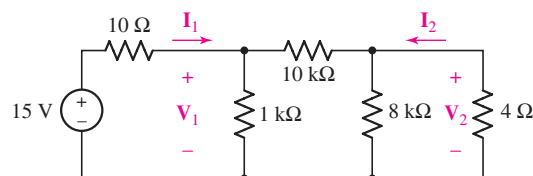

FIGURE 17.44

16. Replace the 10 Ω resistor of Fig. 17.44 with a 1 kΩ resistor, the 15 V source with a 9 V source, and the 4 Ω resistor with a 4 kΩ resistor. (a) Determine the complete set of admittance parameters which describe the two-port network consisting of the 1 kΩ, 10 kΩ, and 8 kΩ resistors. (*Hint*: draw the two port by itself, properly labeled with a voltage and current at each port.) (b) Calculate the power dissipated in the passive one-port, using your answer to part (a).
17. Determine the admittance parameters which describe the two-port shown in Fig. 17.45.

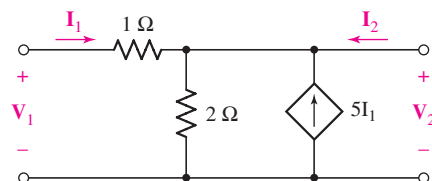
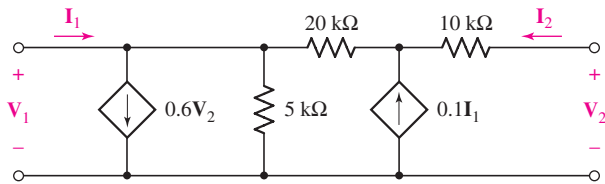

FIGURE 17.45

18. Obtain the  $y$  parameter for the network shown in Fig. 17.46 and use it to determine  $I_1$  and  $I_2$  if (a)  $V_1 = 0$ ,  $V_2 = 1$  V; (b)  $V_1 = -8$  V,  $V_2 = 3$  V; (c)  $V_1 = V_2 = 5$  V.



■ FIGURE 17.46

19. Employ an appropriate method to obtain  $y$  for the network of Fig. 17.47.

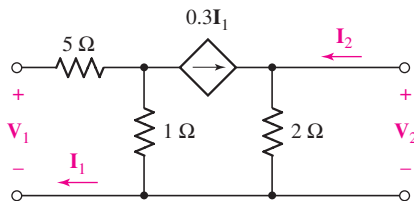

■ FIGURE 17.47

20. The metal-oxide-semiconductor field effect transistor (MOSFET), a three-terminal nonlinear element used in many electronics applications, is often specified in terms of its  $y$  parameters. The ac parameters are strongly dependent on the measurement conditions, and commonly named  $y_{is}$ ,  $y_{rs}$ ,  $y_{fs}$ , and  $y_{os}$ , as in

$$I_g = y_{is}V_{gs} + y_{rs}V_{ds} \quad [49]$$

$$I_d = y_{fs}V_{gs} + y_{os}V_{ds} \quad [50]$$

where  $I_g$  is the transistor gate current,  $I_d$  is the transistor drain current, and the third terminal (the source) is common to the input and output during the measurement. Thus,  $V_{gs}$  is the voltage between the gate and the source, and  $V_{ds}$  is the voltage between the drain and the source. The typical high-frequency model used to approximate the behavior of a MOSFET is shown in Fig. 17.48.

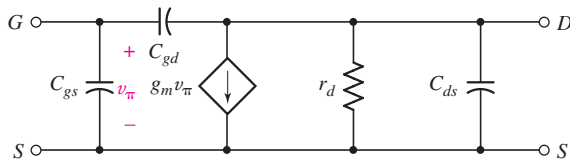

■ FIGURE 17.48

- (a) For the configuration stated above, which transistor terminal is used as the input, and which terminal is used as the output? (b) Derive expressions for the parameters  $y_{is}$ ,  $y_{rs}$ ,  $y_{fs}$ , and  $y_{os}$  defined in Eqs. [49] and [50], in terms of the model parameters  $C_{gs}$ ,  $C_{gd}$ ,  $g_m$ ,  $r_d$ , and  $C_{ds}$  of Fig. 17.48. (c) Compute  $y_{is}$ ,  $y_{rs}$ ,  $y_{fs}$ , and  $y_{os}$  if  $g_m = 4.7$  mS,  $C_{gs} = 3.4$  pF,  $C_{gd} = 1.4$  pF,  $C_{ds} = 0.4$  pF, and  $r_d = 10$  kΩ.

### 17.3 Some Equivalent Networks

21. For the two-port displayed in Fig. 17.49, (a) determine the input resistance; (b) compute the power dissipated by the network if connected in parallel with a 2 A current source; (c) compute the power dissipated by the network if connected in parallel with a 9 V voltage source.

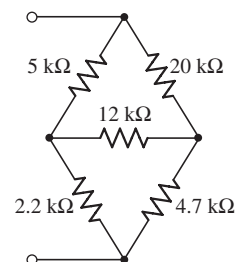

■ FIGURE 17.49

22. With reference to the two networks in Fig. 17.50, convert the  $\Delta$ -connected network to a Y-connected network, and vice versa.

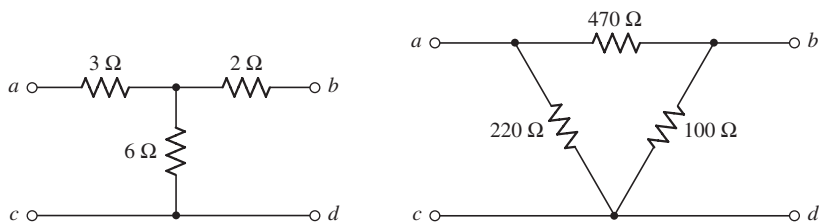

■ FIGURE 17.50

23. Determine the input impedance  $Z_{in}$  of the one-port shown in Fig. 17.51 if  $\omega$  is equal to (a) 50 rad/s; (b) 1000 rad/s.

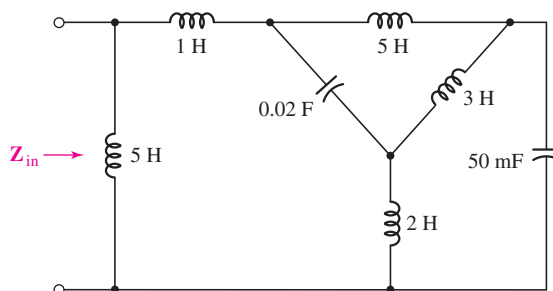

■ FIGURE 17.51

24. Determine the input impedance  $Z_{in}$  of the one-port shown in Fig. 17.52 if  $\omega$  is equal to (a) 50 rad/s; (b) 1000 rad/s.

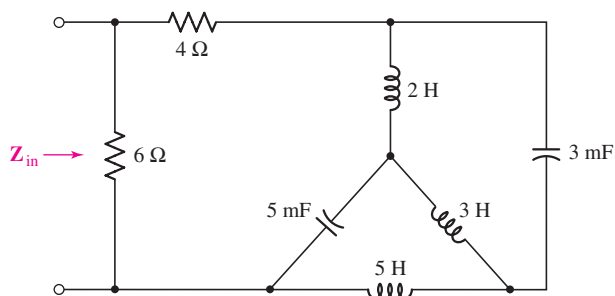

■ FIGURE 17.52

25. Employ  $\Delta$ -Y conversion techniques as appropriate to determine the input resistance  $R_{in}$  of the one-port shown in Fig. 17.53.

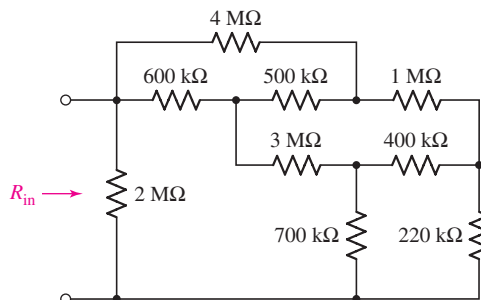

■ FIGURE 17.53



26. Employ appropriate techniques to find a value for the input resistance of the one-port network represented by the schematic of Fig. 17.54.

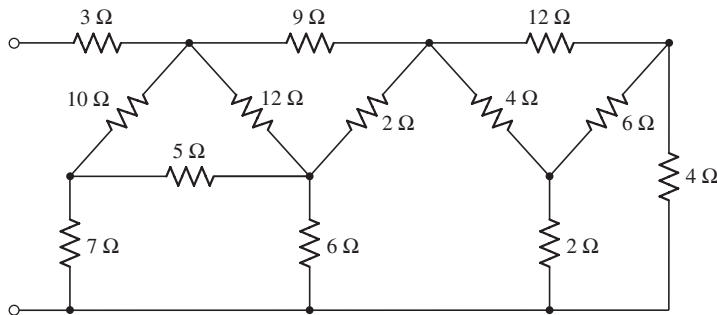

■ FIGURE 17.54

27. (a) Determine the parameter values required to model the network of Fig. 17.43 with the alternative network shown in Fig. 17.13a. (b) Verify that the two networks are in fact equivalent by computing the power dissipated in a  $2\ \Omega$  resistor connected to the right of each network and connecting a  $1\ \text{A}$  current source to the left-hand terminals.
28. (a) The network of Fig. 17.13b is equivalent to the network of Fig. 17.43 assuming the appropriate parameter values are chosen. (a) Compute the necessary parameter values. (b) Verify the equivalence of the two networks by terminating each with a  $1\ \Omega$  resistor (across their  $V_2$  terminals), connecting a  $10\ \text{mA}$  source to the other terminals, and showing that  $I_1$ ,  $V_1$ ,  $I_2$ , and  $V_2$  are equal for both networks.
29. Compute the three parameter values necessary to construct an equivalent network for Fig. 17.43 modeled after the network of Fig. 17.13c. Verify their equivalence with an appropriate PSpice simulation. (*Hint*: connect some type of source(s) and load(s).)
30. It is possible to construct an alternative two-port to the one shown in Fig. 17.47, by selecting appropriate parameter values as labeled on the diagram in Fig. 17.13. (a) Construct such an equivalent network. (b) Verify their equivalence with an appropriate PSpice simulation. (*Hint*: connect some type of source(s) and load(s).)

31. Let  $\mathbf{y} = \begin{bmatrix} 0.1 & -0.05 \\ -0.5 & 0.2 \end{bmatrix}$  (S) for the two-port of Fig. 17.55. Find (a)  $G_V$ ; (b)  $G_I$ ; (c)  $G_P$ ; (d)  $\mathbf{Z}_{\text{in}}$ ; (e)  $\mathbf{Z}_{\text{out}}$ . (f) If the reverse voltage gain  $G_{V,\text{rev}}$  is defined as  $V_1/V_2$  with  $V_s = 0$  and  $R_L$  removed, calculate  $G_{V,\text{rev}}$ . (g) If the insertion power gain  $G_{\text{ins}}$  is defined as the ratio of  $P_{5\Omega}$  with the two-port in place to  $P_{5\Omega}$  with the two-port replaced by jumpers connecting each input terminal to the corresponding output terminal, calculate  $G_{\text{ins}}$ .

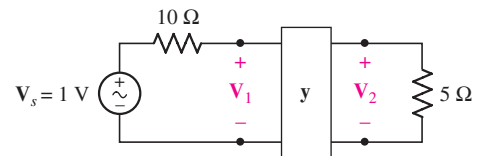

■ FIGURE 17.55

## 17.4 Impedance Parameters

32. Convert the following  $\mathbf{z}$  parameters to  $\mathbf{y}$  parameters, or vice versa, as appropriate:

$$\mathbf{z} = \begin{bmatrix} 2 & 3 \\ 5 & 1 \end{bmatrix} \Omega \quad \mathbf{z} = \begin{bmatrix} 1000 & 470 \\ 2500 & 900 \end{bmatrix} \Omega$$

$$\mathbf{y} = \begin{bmatrix} 0.001 & 0.005 \\ 0.006 & 0.03 \end{bmatrix} \text{S} \quad \mathbf{y} = \begin{bmatrix} 1 & 2 \\ -1 & 3 \end{bmatrix} \text{S}$$

33. By employing Eqs. [32] to [35], obtain a complete set of  $\mathbf{z}$  parameters for the network given in Fig. 17.56.

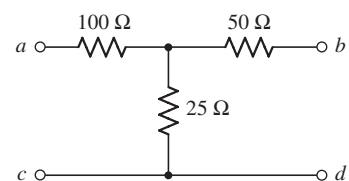

■ FIGURE 17.56

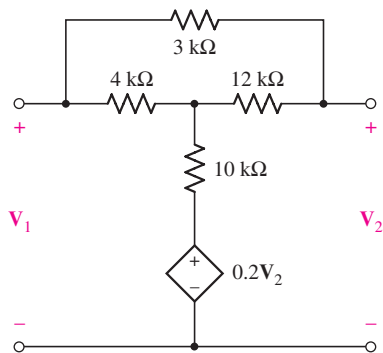

■ FIGURE 17.57

34. The network of Fig. 17.56 is terminated with a  $10\ \Omega$  resistor across terminals  $b$  and  $d$ , and a  $6\ \text{mA}$  sinusoidal current source operating at  $100\ \text{Hz}$  in parallel with a  $50\ \Omega$  resistor is connected across terminals  $a$  and  $c$ . Calculate the voltage, current, and power gains, respectively, as well as the input and output impedance.
35. The two-port networks of Fig. 17.50 are connected in series. (a) Determine the impedance parameters for the series connection by first finding the  $z$  parameters of the individual networks. (b) If the two networks are instead connected in parallel, determine the admittance parameters of the combination by first finding the  $y$  parameters of the individual networks. (c) Verify your answer to part (b) by using Table 17.1 in conjunction with your answer to part (a).
36. (a) Use an appropriate method to obtain the impedance parameters which describe the network illustrated in Fig. 17.57. (b) If a  $1\ \text{V}$  source in series with a  $1\ \text{k}\Omega$  resistor is connected to the left-hand port such that the negative reference terminal of the source is connected to the common terminal of the network, and a  $5\ \text{k}\Omega$  load is connected across the right-hand terminals, compute the current, voltage, and power gain.
37. Determine the impedance parameters for the two-port exhibited in Fig. 17.58.

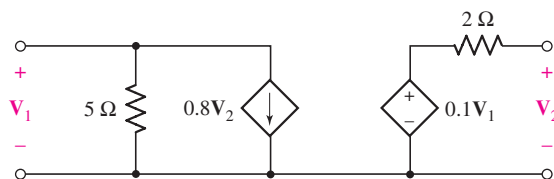

■ FIGURE 17.58

38. Obtain both the impedance and admittance parameters for the two-port network of Fig. 17.59.

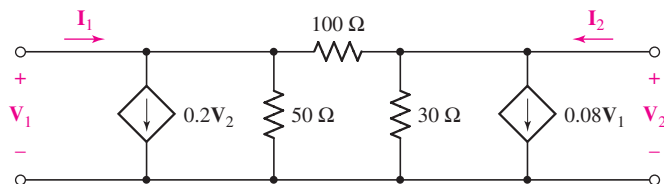

■ FIGURE 17.59

39. Find the four  $z$  parameters at  $\omega = 10^8\ \text{rad/s}$  for the transistor high-frequency equivalent circuit shown in Fig. 17.60.

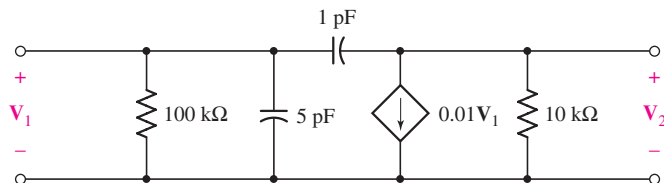

■ FIGURE 17.60

### 17.5 Hybrid Parameters

40. Determine the  $h$  parameters which describe the purely resistive network shown in Fig. 17.56 by connecting appropriate  $1\ \text{V}$ ,  $1\ \text{A}$ , and short circuits to terminals as required.

41. Obtain the  $\mathbf{h}$  parameters of the two-ports of Fig. 17.61.

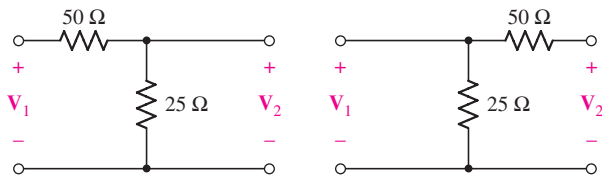

■ FIGURE 17.61

42. If  $\mathbf{h}$  for some particular two-port is given by  $\mathbf{h} = \begin{bmatrix} 2 \text{ k}\Omega & -3 \\ 5 & 0.01 \text{ S} \end{bmatrix}$ , calculate (a)  $\mathbf{z}$ ; (b)  $\mathbf{y}$ .
43. A certain two-port network is described by hybrid parameters  $\mathbf{h} = \begin{bmatrix} 100 \Omega & -2 \\ 5 & 0.1 \text{ S} \end{bmatrix}$ . Determine the new  $\mathbf{h}$  parameters if a  $25 \Omega$  resistor is connected in parallel with (a) the input; (b) the output.
44. A bipolar junction transistor is connected in common-emitter configuration, and found to have  $\mathbf{h}$  parameters  $h_{11} = 5 \text{ k}\Omega$ ,  $h_{12} = 0.55 \times 10^{-4}$ ,  $h_{21} = 300$ , and  $h_{22} = 39 \mu\text{S}$ . (a) Write  $\mathbf{h}$  in matrix form. (b) Determine the small-signal current gain. (c) Determine the output resistance in  $\text{k}\Omega$ . (d) If a sinusoidal voltage source having frequency  $100 \text{ rad/s}$  and amplitude  $5 \text{ mV}$  in series with a  $100 \Omega$  resistor is connected to the input terminals, calculate the peak voltage which appears across the output terminals.
45. The two-port which plays a central role in the circuit of Fig. 17.62 can be characterized by hybrid parameters  $\mathbf{h} = \begin{bmatrix} 1 \Omega & -1 \\ 2 & 0.5 \text{ S} \end{bmatrix}$ . Determine  $\mathbf{I}_1$ ,  $\mathbf{I}_2$ ,  $\mathbf{V}_1$ , and  $\mathbf{V}_2$ .

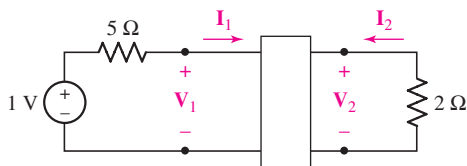

■ FIGURE 17.62

46. The two networks of Fig. 17.61 are connected in series by connecting the terminals as illustrated in Fig. 17.22 (assume the left-hand network of Fig. 17.61 is network A). Determine the new set of  $\mathbf{h}$  parameters which describe the series connection.
47. The two networks of Fig. 17.61 are connected in parallel by tying the corresponding input terminals together, and then tying the corresponding output terminals together. Determine the new set of  $\mathbf{h}$  parameters which describe the parallel connection.
48. Find  $\mathbf{y}$ ,  $\mathbf{z}$ , and  $\mathbf{h}$  for both of the two-ports shown in Fig. 17.63. If any parameter is infinite, skip that parameter set.

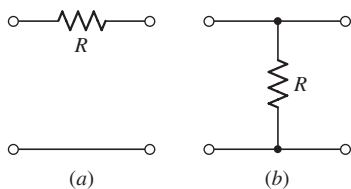

■ FIGURE 17.63

49. (a) Find  $\mathbf{h}$  for the two-port of Fig. 17.64. (b) Find  $\mathbf{Z}_{\text{out}}$  if the input contains  $\mathbf{V}_s$  in series with  $R_s = 200 \Omega$ .

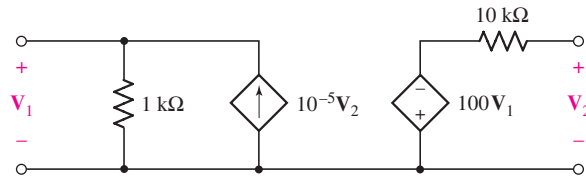

■ FIGURE 17.64

## 17.6 Transmission Parameters

50. (a) With the assistance of appropriate mesh equations, determine the  $ABCD$  matrix which represents the two-port shown in Fig. 17.9. (b) Convert your answer to  $\mathbf{h}$ .
51. (a) Employ suitably written mesh equations to obtain the  $\mathbf{t}$  parameters which characterize the network of Fig. 17.57. (b) If currents  $\mathbf{I}_1$  and  $\mathbf{I}_2$  are defined as flowing into the (+) reference terminals of  $\mathbf{V}_1$  and  $\mathbf{V}_2$ , respectively, compute the voltages if  $\mathbf{I}_1 = 2\mathbf{I}_2 = 3 \text{ mA}$ .
52. Consider the following matrices:
- $$\mathbf{a} = \begin{bmatrix} 5 & 2 \\ 4 & 1 \end{bmatrix} \quad \mathbf{b} = \begin{bmatrix} 1.5 & 1 \\ 1 & 0.5 \end{bmatrix} \quad \mathbf{c} = \begin{bmatrix} -4 \\ 2 \end{bmatrix}$$
- Calculate (a)  $\mathbf{a} \cdot \mathbf{b}$ ; (b)  $\mathbf{b} \cdot \mathbf{a}$ ; (c)  $\mathbf{a} \cdot \mathbf{c}$ ; (d)  $\mathbf{b} \cdot \mathbf{c}$ ; (e)  $\mathbf{b} \cdot \mathbf{a} \cdot \mathbf{c}$ ; (f)  $\mathbf{a} \cdot \mathbf{a}$ .
53. Two networks are represented by the following impedance matrices:
- $$\mathbf{z}_1 = \begin{bmatrix} 4.7 & 0.5 \\ 0.87 & 1.8 \end{bmatrix} \text{ k}\Omega \quad \text{and} \quad \mathbf{z}_2 = \begin{bmatrix} 1.1 & 2.2 \\ 0.89 & 1.8 \end{bmatrix} \text{ k}\Omega, \text{ respectively.}$$
- (a) Determine the  $\mathbf{t}$  matrix which characterizes the cascaded network resulting from connecting network 2 to the output of network 1. (b) Reverse the order of the networks and compute the new  $\mathbf{t}$  matrix which results.
54. The two-port of Fig. 17.65 can be viewed as three separate cascaded two-ports  $A$ ,  $B$ , and  $C$ . (a) Compute  $\mathbf{t}$  for each network. (b) Obtain  $\mathbf{t}$  for the cascaded network. (c) Verify your answer by naming the two middle nodes  $V_x$  and  $V_y$ , respectively, writing nodal equations, obtaining the admittance parameters from your nodal equations, and converting to  $\mathbf{t}$  parameters using Table 17.1.

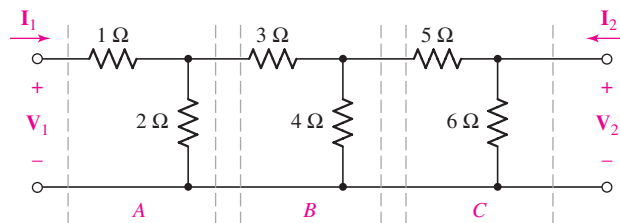

■ FIGURE 17.65

55. Consider the two separate two-ports of Fig. 17.61. Determine the  $ABCD$  matrix which characterizes the cascaded network resulting from connecting (a) the output of the left-hand network to the input of the right-hand network; (b) the output of the right-hand network to the input of the left-hand network.
56. (a) Determine the  $\mathbf{t}$  parameters which describe the two-port of Fig. 17.58. (b) Compute  $\mathbf{Z}_{\text{out}}$  if a practical voltage source having a  $100 \Omega$  series resistance is connected to the input terminals of the network.

57. Three identical networks as the one depicted in Fig. 17.56 are cascaded together. Determine the  $\mathbf{t}$  parameters which fully represent the result.
58. (a) Find  $\mathbf{t}_a$ ,  $\mathbf{t}_b$ , and  $\mathbf{t}_c$  for the networks shown in Fig. 17.66a, b, and c.  
 (b) By using the rules for interconnecting two-ports in cascade, find  $\mathbf{t}$  for the network of Fig. 17.66d.

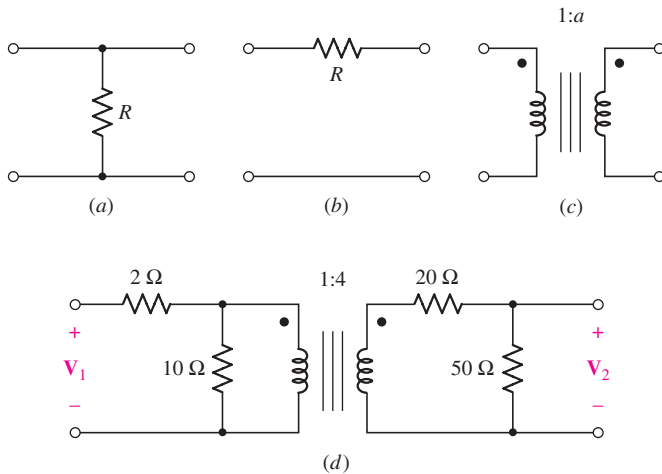

■ FIGURE 17.66

### Chapter-Integrating Exercises

59. (a) Obtain  $\mathbf{y}$ ,  $\mathbf{z}$ ,  $\mathbf{h}$ , and  $\mathbf{t}$  parameters for the network shown in Fig. 17.67 using either the defining equations or mesh/nodal equations. (b) Verify your answers, using the relationships in Table 17.1.

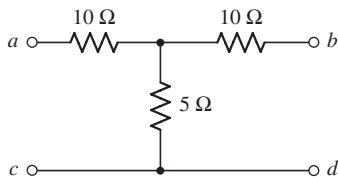

■ FIGURE 17.67

60. Four networks, each identical to the one depicted in Fig. 17.67, are connected in parallel such that all terminals labeled  $a$  are tied together, all terminals designated  $b$  are tied together, and all terminals labeled  $c$  and  $d$  are connected. Obtain the  $\mathbf{y}$ ,  $\mathbf{z}$ ,  $\mathbf{h}$ , and  $\mathbf{t}$  parameters which describe the parallel-connected network.
61. A cascaded 12-element network is formed using four two-ports identical to the one shown in Fig. 17.67. Determine the  $\mathbf{y}$ ,  $\mathbf{z}$ ,  $\mathbf{h}$ , and  $\mathbf{t}$  parameters which describe the result.
62. The concept of  $ABCD$  matrices extends to systems beyond electrical circuits. For example, they are commonly employed for ray-tracing calculations in optical systems. In that case, we envision parallel input and output planes in  $xy$ , skewed by an optical axis  $z$ . An inbound ray crosses the input plane a distance  $x = r_{in}$  from the optical axis, making an angle  $\theta_{in}$ . The corresponding

parameters  $r_{\text{out}}, \theta_{\text{out}}$  for the outbound ray crossing the output plane are then given by the  $ABCD$  matrix such that

$$\begin{bmatrix} r_{\text{out}} \\ \theta_{\text{out}} \end{bmatrix} = \begin{bmatrix} A & B \\ C & D \end{bmatrix} \begin{bmatrix} r_{\text{in}} \\ \theta_{\text{in}} \end{bmatrix}$$

Each type of optical element (e.g., mirror, lens, or even propagation through free space) has its own  $ABCD$  matrix. If the ray passes through several elements, the net effect can be predicted by simply cascading the individual  $ABCD$  matrices (in the proper order).

(a) Obtain expressions for  $A, B, C,$  and  $D$  similar to Eqs. [32] to [35].

(b) If the  $ABCD$  matrix for a perfectly reflecting flat mirror is given by

$$\begin{bmatrix} 1 & 0 \\ 0 & 1 \end{bmatrix},$$

sketch the system along with the inbound and outbound rays, taking care to note the orientation of the mirror.

63. Continuing from Exercise 62, the behavior of a ray propagating through free space a distance  $d$  can be modeled with the  $ABCD$  matrix  $\begin{bmatrix} 1 & d \\ 0 & 1 \end{bmatrix}$ . (a) Show that the same result is obtained ( $r_{\text{out}}, \theta_{\text{out}}$ ) whether a single  $ABCD$  matrix is used with  $d$ , or two cascaded matrices are used, each with  $d/2$ . (b) What are the units of  $A, B, C,$  and  $D$ , respectively?

# Fourier Circuit Analysis

## INTRODUCTION

In this chapter we continue our introduction to circuit analysis by studying periodic functions in both the time and frequency domains. Specifically, we will consider forcing functions which are *periodic* and have functional natures which satisfy certain mathematical restrictions that are characteristic of any function which we can generate in the laboratory. Such functions may be represented as the sum of an infinite number of sine and cosine functions which are harmonically related. Therefore, since the forced response to each sinusoidal component can be determined easily by sinusoidal steady-state analysis, the response of the linear network to the general periodic forcing function may be obtained by superposing the partial responses.

The topic of Fourier series is of vital importance in a number of fields, particularly communications. The use of Fourier-based techniques to assist in circuit analysis, however, had been slowly falling out of fashion for a number of years. Now as we face an increasingly larger fraction of global power usage coming from equipment employing pulse-modulated power supplies (e.g., computers), the subject of harmonics in power systems and power electronics is rapidly becoming a serious problem in even large-scale generation plants. It is only with Fourier-based analysis that the underlying problems and possible solutions can be understood.

## 18.1 TRIGONOMETRIC FORM OF THE FOURIER SERIES

We know that the complete response of a linear circuit to an arbitrary forcing function is composed of the sum of a *forced response* and a *natural response*. The natural response has been considered

## KEY CONCEPTS

Representing Periodic Functions as a Sum of Sines and Cosines

Harmonic Frequencies

Even and Odd Symmetry

Half-Wave Symmetry

Complex Form of the Fourier Series

Discrete Line Spectra

Fourier Transform

Using Fourier Series and Fourier Transform Techniques in Circuit Analysis

System Response and Convolution in the Frequency Domain



both in the time domain (Chaps. 7, 8, and 9) and in the frequency domain (Chaps. 14 and 15). The forced response has also been considered from several perspectives, including the phasor-based techniques of Chap. 10. As we have discovered, in some cases we need *both* components of the total response of a particular circuit, while in others we need only the natural or the forced response. In this section, we refocus our attention on forcing functions that are *sinusoidal* in nature, and discover how to write a general periodic function as a *sum* of such functions—leading us into a discussion of a new set of circuit analysis procedures.

## Harmonics

Some feeling for the validity of representing a general *periodic* function by an infinite sum of sine and cosine functions may be gained by considering a simple example. Let us first assume a cosine function of radian frequency  $\omega_0$ ,

$$v_1(t) = 2 \cos \omega_0 t$$

where

$$\omega_0 = 2\pi f_0$$

and the period  $T$  is

$$T = \frac{1}{f_0} = \frac{2\pi}{\omega_0}$$

Although  $T$  does not usually carry a zero subscript, it is the period of the fundamental frequency. The **harmonics** of this sinusoid have frequencies  $n\omega_0$ , where  $\omega_0$  is the fundamental frequency and  $n = 1, 2, 3, \dots$ . The frequency of the first harmonic is the **fundamental frequency**.

Next let us select a third-harmonic voltage

$$v_{3a}(t) = \cos 3\omega_0 t$$

The fundamental  $v_1(t)$ , the third harmonic  $v_{3a}(t)$ , and the sum of these two waves are shown as functions of time in Fig. 18.1a. Note that the sum is also periodic, with period  $T = 2\pi/\omega_0$ .

The form of the resultant periodic function changes as the phase and amplitude of the third-harmonic component change. Thus, Fig. 18.1b shows the effect of combining  $v_1(t)$  and a third harmonic of slightly larger amplitude,

$$v_{3b}(t) = 1.5 \cos 3\omega_0 t$$

By shifting the phase of the third harmonic by 90 degrees to give

$$v_{3c}(t) = \sin 3\omega_0 t$$



the sum, shown in Fig. 18.1c, takes on a still different character. In all cases, the period of the resultant waveform is the same as the period of the fundamental waveform. The nature of the waveform depends on the amplitude and phase of every possible harmonic component, and we will find that we are able to generate waveforms which have extremely nonsinusoidal characteristics by an appropriate combination of sinusoidal functions.

After we have become familiar with the use of the sum of an infinite number of sine and cosine functions to represent a periodic waveform, we will consider the frequency-domain representation of a general nonperiodic waveform in a manner similar to the Laplace transform.



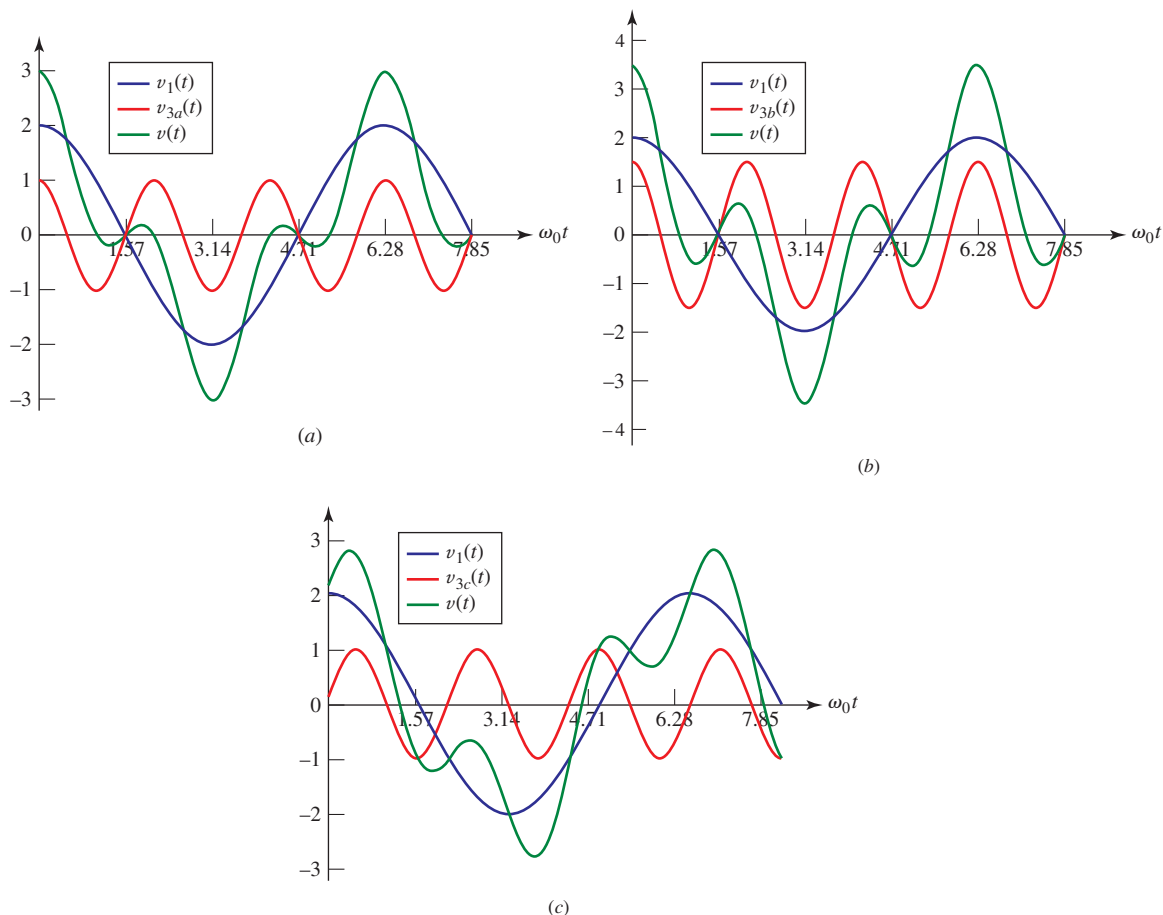

FIGURE 18.1 Several of the infinite number of different waveforms which may be obtained by combining a fundamental and a third harmonic. The fundamental is  $v_1 = 2 \cos \omega_0 t$ , and the third harmonic is (a)  $v_{3a} = \cos 3\omega_0 t$ ; (b)  $v_{3b} = 1.5 \cos 3\omega_0 t$ ; (c)  $v_{3c} = \sin 3\omega_0 t$ .

### PRACTICE

18.1 Let a third-harmonic voltage be added to the fundamental to yield  $v = 2 \cos \omega_0 t + V_{m3} \sin 3\omega_0 t$ , the waveform shown in Fig. 18.1c for  $V_{m3} = 1$ . (a) Find the value of  $V_{m3}$  so that  $v(t)$  will have zero slope at  $\omega_0 t = 2\pi/3$ . (b) Evaluate  $v(t)$  at  $\omega_0 t = 2\pi/3$ .

Ans: 0.577;  $-1.000$ .

## The Fourier Series

We first consider a *periodic* function  $f(t)$ , defined in Sec. 11.2 by the functional relationship

$$f(t) = f(t + T)$$

where  $T$  is the period. We further assume that the function  $f(t)$  satisfies the following properties:

We will take  $f(t)$  to represent either a voltage or a current waveform, and any such waveform which we can actually produce must satisfy these four conditions; perhaps it should be noted, however, that certain mathematical functions do exist for which these four conditions are not satisfied.

1.  $f(t)$  is single-valued everywhere; that is,  $f(t)$  satisfies the mathematical definition of a function.
2. The integral  $\int_{t_0}^{t_0+T} |f(t)| dt$  exists (i.e., is not infinite) for any choice of  $t_0$ .
3.  $f(t)$  has a finite number of discontinuities in any one period.
4.  $f(t)$  has a finite number of maxima and minima in any one period.

Given such a periodic function  $f(t)$ , the Fourier theorem states that  $f(t)$  may be represented by the infinite series

$$\begin{aligned} f(t) &= a_0 + a_1 \cos \omega_0 t + a_2 \cos 2\omega_0 t + \cdots \\ &\quad + b_1 \sin \omega_0 t + b_2 \sin 2\omega_0 t + \cdots \\ &= a_0 + \sum_{n=1}^{\infty} (a_n \cos n\omega_0 t + b_n \sin n\omega_0 t) \end{aligned} \quad [1]$$

where the fundamental frequency  $\omega_0$  is related to the period  $T$  by

$$\omega_0 = \frac{2\pi}{T}$$

and where  $a_0$ ,  $a_n$ , and  $b_n$  are constants that depend upon  $n$  and  $f(t)$ . Equation [1] is the trigonometric form of the **Fourier series** for  $f(t)$ , and the process of determining the values of the constants  $a_0$ ,  $a_n$ , and  $b_n$  is called **Fourier analysis**. Our object is not the proof of this theorem, but only a simple development of the procedures of Fourier analysis and a feeling that the theorem is plausible.

### Some Useful Trigonometric Integrals

Before we discuss the evaluation of the constants appearing in the Fourier series, let us collect a set of useful trigonometric integrals. We let both  $n$  and  $k$  represent any element of the set of integers 1, 2, 3, . . . . In the following integrals, 0 and  $T$  are used as the integration limits, but it is understood that any interval of one period is equally correct.

$$\int_0^T \sin n\omega_0 t dt = 0 \quad [2]$$

$$\int_0^T \cos n\omega_0 t dt = 0 \quad [3]$$

$$\int_0^T \sin k\omega_0 t \cos n\omega_0 t dt = 0 \quad [4]$$

$$\int_0^T \sin k\omega_0 t \sin n\omega_0 t dt = 0 \quad (k \neq n) \quad [5]$$

$$\int_0^T \cos k\omega_0 t \cos n\omega_0 t dt = 0 \quad (k \neq n) \quad [6]$$

Those cases which are excepted in Eqs. [5] and [6] are also easily evaluated; we obtain

$$\int_0^T \sin^2 n\omega_0 t dt = \frac{T}{2} \quad [7]$$

$$\int_0^T \cos^2 n\omega_0 t dt = \frac{T}{2} \quad [8]$$

### Evaluation of the Fourier Coefficients

The evaluation of the unknown constants in the Fourier series may now be accomplished readily. We first attack  $a_0$ . If we integrate each side of Eq. [1] over a full period, we obtain

$$\int_0^T f(t) dt = \int_0^T a_0 dt + \int_0^T \sum_{n=1}^{\infty} (a_n \cos n\omega_0 t + b_n \sin n\omega_0 t) dt$$

But every term in the summation is of the form of Eq. [2] or [3], and thus

$$\int_0^T f(t) dt = a_0 T$$

or

$$a_0 = \frac{1}{T} \int_0^T f(t) dt \quad [9]$$

This constant  $a_0$  is simply the average value of  $f(t)$  over a period, and we therefore describe it as the dc component of  $f(t)$ .

To evaluate one of the cosine coefficients, for example,  $a_k$ , the coefficient of  $\cos k\omega_0 t$ , we first multiply each side of Eq. [1] by  $\cos k\omega_0 t$  and then integrate both sides of the equation over a full period:

$$\begin{aligned} \int_0^T f(t) \cos k\omega_0 t dt &= \int_0^T a_0 \cos k\omega_0 t dt \\ &+ \int_0^T \sum_{n=1}^{\infty} a_n \cos k\omega_0 t \cos n\omega_0 t dt \\ &+ \int_0^T \sum_{n=1}^{\infty} b_n \cos k\omega_0 t \sin n\omega_0 t dt \end{aligned}$$

From Eqs. [3], [4], and [6] we note that every term on the right-hand side of this equation is zero except for the single  $a_n$  term where  $k = n$ . We evaluate that term using Eq. [8], and in so doing we find  $a_k$ , or  $a_n$ :

$$a_n = \frac{2}{T} \int_0^T f(t) \cos n\omega_0 t dt \quad [10]$$

This result is *twice* the average value of the product  $f(t) \cos n\omega_0 t$  over a period.

In a similar way, we obtain  $b_k$  by multiplying by  $\sin k\omega_0 t$ , integrating over a period, noting that all but one of the terms on the right-hand side are zero, and performing that single integration by Eq. [7]. The result is

$$b_n = \frac{2}{T} \int_0^T f(t) \sin n\omega_0 t \, dt \quad [11]$$

which is *twice* the average value of  $f(t) \sin n\omega_0 t$  over a period.

Equations [9] to [11] now enable us to determine values for  $a_0$  and all the  $a_n$  and  $b_n$  in the Fourier series, Eq. [1], as summarized below:

$$f(t) = a_0 + \sum_{n=1}^{\infty} (a_n \cos n\omega_0 t + b_n \sin n\omega_0 t) \quad [1]$$

$$\omega_0 = \frac{2\pi}{T} = 2\pi f_0$$

$$a_0 = \frac{1}{T} \int_0^T f(t) \, dt \quad [9]$$

$$a_n = \frac{2}{T} \int_0^T f(t) \cos n\omega_0 t \, dt \quad [10]$$

$$b_n = \frac{2}{T} \int_0^T f(t) \sin n\omega_0 t \, dt \quad [11]$$

### EXAMPLE 18.1

The “half-sinusoidal” waveform shown in Fig. 18.2 represents the voltage response obtained at the output of a half-wave rectifier circuit, a nonlinear circuit whose purpose is to convert a sinusoidal input voltage to a (pulsating) approximation to dc. Find the Fourier series representation of this waveform.

#### ► Identify the goal of the problem.

We are presented with a periodic function and are asked to find the Fourier series representation. If not for the removal of all negative voltages, the problem would be trivial, as only *one* sinusoid would be required.

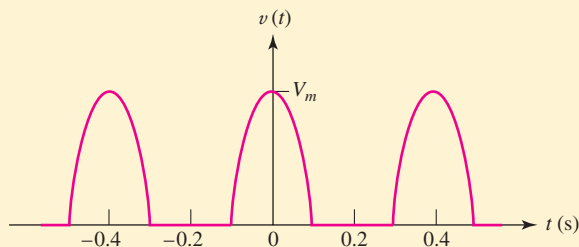

■ FIGURE 18.2 The output of a half-wave rectifier to which a sinusoidal input is applied.

► **Collect the known information.**

In order to represent this voltage as a Fourier series, we must first determine the period and then express the graphical voltage as an analytical function of time. From the graph, the period is seen to be

$$T = 0.4 \text{ s}$$

and thus

$$f_0 = 2.5 \text{ Hz}$$

and

$$\omega_0 = 5\pi \text{ rad/s}$$

► **Devise a plan.**

The most straightforward approach is to apply Eqs. [9] to [11] to calculate the set of coefficients  $a_0$ ,  $a_n$ , and  $b_n$ . To do this, we need a functional expression for  $v(t)$ , the most straightforward being defined over the interval  $t = 0$  to  $t = 0.4$  as

$$v(t) = \begin{cases} V_m \cos 5\pi t & 0 \leq t \leq 0.1 \\ 0 & 0.1 \leq t \leq 0.3 \\ V_m \cos 5\pi t & 0.3 \leq t \leq 0.4 \end{cases}$$

However, choosing the period to extend from  $t = -0.1$  to  $t = 0.3$  will result in fewer equations and, hence, fewer integrals:

$$v(t) = \begin{cases} V_m \cos 5\pi t & -0.1 \leq t \leq 0.1 \\ 0 & 0.1 \leq t \leq 0.3 \end{cases} \quad [12]$$

This form is preferable, although either description will yield the correct results.

► **Construct an appropriate set of equations.**

The zero-frequency component is easily obtained:

$$a_0 = \frac{1}{0.4} \int_{-0.1}^{0.3} v(t) dt = \frac{1}{0.4} \left[ \int_{-0.1}^{0.1} V_m \cos 5\pi t dt + \int_{0.1}^{0.3} 0 dt \right]$$

The amplitude of a *general* cosine term is

$$a_n = \frac{2}{0.4} \int_{-0.1}^{0.1} V_m \cos 5\pi t \cos 5\pi n t dt$$

and the amplitude of a general sine term is

$$b_n = \frac{2}{0.4} \int_{-0.1}^{0.1} V_m \cos 5\pi t \sin 5\pi n t dt$$

which, in fact, is always zero, and hence will not be considered further.

► **Determine if additional information is required.**

The form of the function we obtain upon integrating is different when  $n$  is unity than it is for any other choice of  $n$ . If  $n = 1$ , we have

$$a_1 = 5V_m \int_{-0.1}^{0.1} \cos^2 5\pi t dt = \frac{V_m}{2} \quad [13]$$

Notice that integration over an entire period must be broken up into subintervals of the period, in each of which the functional form of  $v(t)$  is known.

(Continued on next page)

whereas if  $n$  is not equal to unity, we find

$$a_n = 5V_m \int_{-0.1}^{0.1} \cos 5\pi t \cos 5\pi n t \, dt$$

► **Attempt a solution.**

Solving, we find that

$$a_0 = \frac{V_m}{\pi} \quad [14]$$

$$a_n = 5V_m \int_{-0.1}^{0.1} \frac{1}{2} [\cos 5\pi(1+n)t + \cos 5\pi(1-n)t] \, dt$$

or

$$a_n = \frac{2V_m \cos(\pi n/2)}{\pi(1-n^2)} \quad (n \neq 1) \quad [15]$$

(A similar integration shows that  $b_n = 0$  for any value of  $n$ , and the Fourier series thus contains no sine terms.) The Fourier series is therefore obtained from Eqs. [1], [13], [14], and [15]:

$$\begin{aligned} v(t) = & \frac{V_m}{\pi} + \frac{V_m}{2} \cos 5\pi t + \frac{2V_m}{3\pi} \cos 10\pi t - \frac{2V_m}{15\pi} \cos 20\pi t \\ & + \frac{2V_m}{35\pi} \cos 30\pi t - \dots \end{aligned} \quad [16]$$

► **Verify the solution. Is it reasonable or expected?**

Our solution can be checked by plugging values into Eq. [16] and truncating after a specific number of terms. Another approach, however, is to plot the function as shown in Fig. 18.3 for  $n = 1, 2,$  and  $6$ .

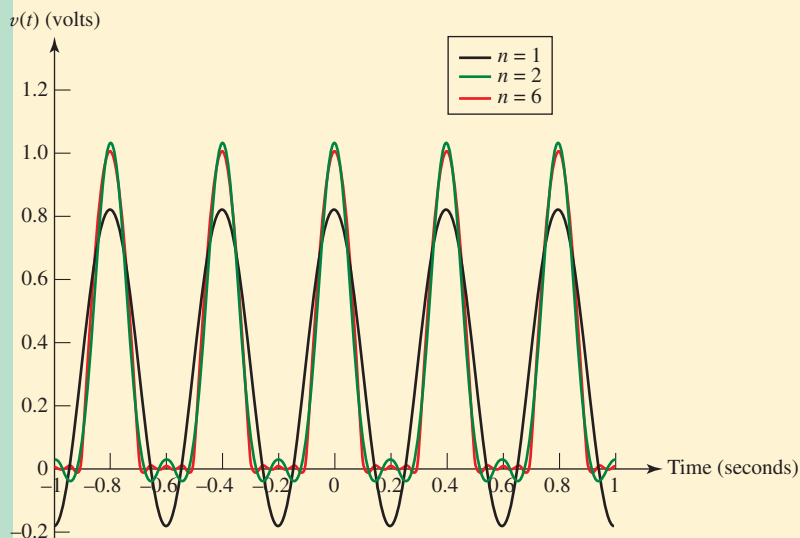

■ FIGURE 18.3 Equation [16] truncated after  $n = 1$  term,  $n = 2$  term, and  $n = 6$  term, showing convergence to the half-sinusoid  $v(t)$ . A magnitude of  $V_m = 1$  has been chosen for convenience.

It should be pointed out, incidentally, that the expression for  $a_n$  when  $n \neq 1$  will yield the correct result for  $n = 1$  in the limit as  $n \rightarrow 1$ .

As can be seen, as more terms are included, the more the plot resembles that of Fig. 18.2.

### PRACTICE

18.2 A periodic waveform  $f(t)$  is described as follows:  $f(t) = -4$ ,  $0 < t < 0.3$ ;  $f(t) = 6$ ,  $0.3 < t < 0.4$ ;  $f(t) = 0$ ,  $0.4 < t < 0.5$ ;  $T = 0.5$ . Evaluate (a)  $a_0$ ; (b)  $a_3$ ; (c)  $b_1$ .

18.3 Write the Fourier series for the three voltage waveforms shown in Fig. 18.4.

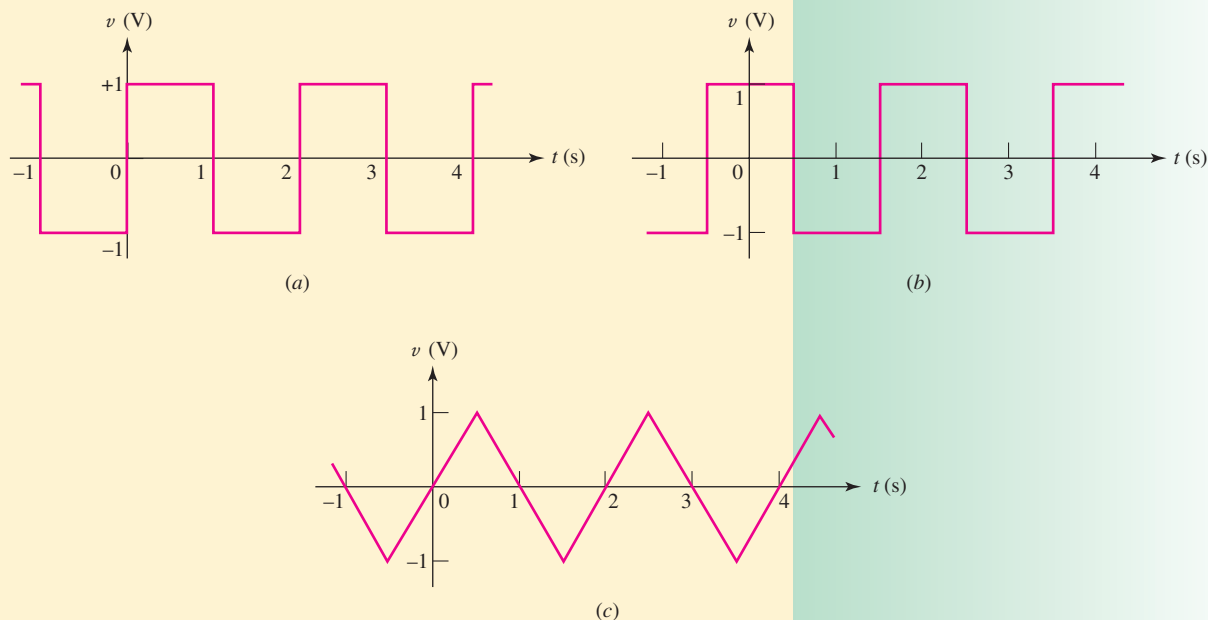
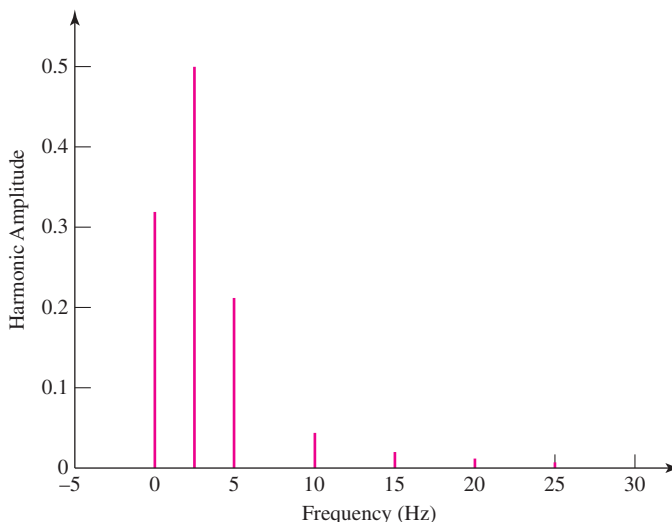

FIGURE 18.4

Ans: 18.2:  $-1.200$ ;  $1.383$ ;  $-4.44$ . 18.3:  $(4/\pi)(\sin \pi t + \frac{1}{3} \sin 3\pi t + \frac{1}{5} \sin 5\pi t + \dots)$  V;  
 $(4/\pi)(\cos \pi t - \frac{1}{3} \cos 3\pi t + \frac{1}{5} \cos 5\pi t - \dots)$  V;  $(8/\pi^2)(\sin \pi t - \frac{1}{9} \sin 3\pi t + \frac{1}{25} \sin 5\pi t - \dots)$ .

## Line and Phase Spectra

We depicted the function  $v(t)$  of Example 18.1 graphically in Fig. 18.2, and analytically in Eq. [12]—both representations being in the time domain. The Fourier series representation of  $v(t)$  given in Eq. [16] is also a time-domain expression, but may be transformed into a *frequency-domain* representation as well. For example, Fig. 18.5 shows the amplitude of each frequency component of  $v(t)$ , a type of plot known as a **line spectrum**. Here, the magnitude of each frequency component (i.e.,  $|a_0|$ ,  $|a_1|$ , etc.) is indicated by the length of the vertical line at the corresponding frequency ( $f_0, f_1$ , etc.); for the sake of convenience, we have taken  $V_m = 1$ . Given a different value of  $V_m$ , we simply scale the y axis values by the new value.



■ FIGURE 18.5 The discrete line spectrum of  $v(t)$  as represented in Eq. [16], showing the first seven frequency components. A magnitude of  $V_m = 1$  has been chosen for convenience.

Such a plot, sometimes referred to as a *discrete spectrum*, gives a great deal of information at a glance. In particular, we can see how many terms of the series are required to obtain a reasonable approximation of the original waveform. In the line spectrum of Fig. 18.5, we note that the 8th and 10th harmonics (20 and 25 Hz, respectively) add only a small correction. Truncating the series after the 6th harmonic therefore should lead to a reasonable approximation; the reader can judge this for herself/himself by considering Fig. 18.3.



One note of caution must be injected. The example we have considered contains no sine terms, and the amplitude of the  $n$ th harmonic is therefore  $|a_n|$ . If  $b_n$  is not zero, then the amplitude of the component at a frequency  $n\omega_0$  must be  $\sqrt{a_n^2 + b_n^2}$ . This is the general quantity which we must show in a line spectrum. When we discuss the complex form of the Fourier series, we will see that this amplitude is obtained more directly.

In addition to the amplitude spectrum, we may construct a discrete *phase spectrum*. At any frequency  $n\omega_0$ , we combine the cosine and sine terms to determine the phase angle  $\phi_n$ :

$$\begin{aligned} a_n \cos n\omega_0 t + b_n \sin n\omega_0 t &= \sqrt{a_n^2 + b_n^2} \cos \left( n\omega_0 t + \tan^{-1} \frac{-b_n}{a_n} \right) \\ &= \sqrt{a_n^2 + b_n^2} \cos(n\omega_0 t + \phi_n) \end{aligned}$$

or

$$\phi_n = \tan^{-1} \frac{-b_n}{a_n}$$

In Eq. [16],  $\phi_n = 0^\circ$  or  $180^\circ$  for every  $n$ .

The Fourier series obtained for this example includes no sine terms and no odd harmonics (except the fundamental) among the cosine terms. It is



possible to anticipate the absence of certain terms in a Fourier series, before any integrations are performed, by an inspection of the symmetry of the given time function. We will investigate the use of symmetry in the following section.

## 18.2 THE USE OF SYMMETRY

### Even and Odd Symmetry

The two types of symmetry which are most readily recognized are *even-function symmetry* and *odd-function symmetry*, or simply *even symmetry* and *odd symmetry*. We say that  $f(t)$  possesses the property of even symmetry if

$$f(t) = f(-t) \quad [17]$$

Such functions as  $t^2$ ,  $\cos 3t$ ,  $\ln(\cos t)$ ,  $\sin^2 7t$ , and a constant  $C$  all possess even symmetry; the replacement of  $t$  by  $(-t)$  does not change the value of any of these functions. This type of symmetry may also be recognized graphically, for if  $f(t) = f(-t)$ , then mirror symmetry exists about the  $f(t)$  axis. The function shown in Fig. 18.6a possesses even symmetry; if the figure were to be folded along the  $f(t)$  axis, then the portions of the graph for positive and negative time would fit exactly, one on top of the other.

We define odd symmetry by stating that if odd symmetry is a property of  $f(t)$ , then

$$f(t) = -f(-t) \quad [18]$$

In other words, if  $t$  is replaced by  $(-t)$ , then the negative of the given function is obtained; for example,  $t$ ,  $\sin t$ ,  $t \cos 70t$ ,  $t\sqrt{1+t^2}$ , and the function sketched in Fig. 18.6b are all odd functions and possess odd symmetry. The graphical characteristics of odd symmetry are apparent if the portion of  $f(t)$  for  $t > 0$  is rotated about the positive  $t$  axis and the resultant figure is then rotated about the  $f(t)$  axis; the two curves will fit exactly, one on top of the other. That is, we now have symmetry about the origin, rather than about the  $f(t)$  axis as we did for even functions.

Having definitions for even and odd symmetry, we should note that the product of two functions with even symmetry, or of two functions with odd symmetry, yields a function with even symmetry. Furthermore, the product of an even and an odd function gives a function with odd symmetry.

### Symmetry and Fourier Series Terms

Now let us investigate the effect that even symmetry produces in a Fourier series. If we think of the expression which equates an even function  $f(t)$  and the sum of an infinite number of sine and cosine functions, then it is apparent that the sum must also be an even function. A sine wave, however, is an odd function, and *no sum of sine waves can produce any even function other than zero* (which is both even and odd). It is thus plausible that the Fourier series of any even function is composed of only a constant and cosine functions. Let us now show carefully that  $b_n = 0$ . We have

$$\begin{aligned} b_n &= \frac{2}{T} \int_{-T/2}^{T/2} f(t) \sin n\omega_0 t \, dt \\ &= \frac{2}{T} \left[ \int_{-T/2}^0 f(t) \sin n\omega_0 t \, dt + \int_0^{T/2} f(t) \sin n\omega_0 t \, dt \right] \end{aligned}$$

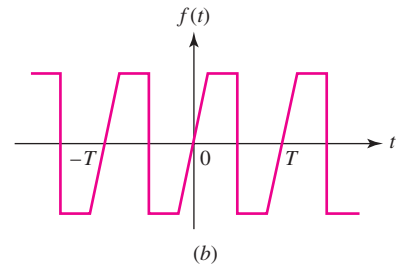
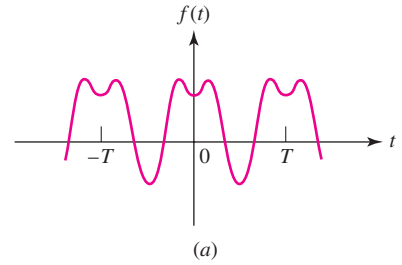

FIGURE 18.6 (a) A waveform showing even symmetry. (b) A waveform showing odd symmetry.



We replace the variable  $t$  in the first integral by  $-\tau$ , or  $\tau = -t$ , and make use of the fact that  $f(t) = f(-t) = f(\tau)$ :

$$\begin{aligned} b_n &= \frac{2}{T} \left[ \int_{T/2}^0 f(-\tau) \sin(-n\omega_0\tau)(-d\tau) + \int_0^{T/2} f(t) \sin n\omega_0t dt \right] \\ &= \frac{2}{T} \left[ - \int_0^{T/2} f(\tau) \sin n\omega_0\tau d\tau + \int_0^{T/2} f(t) \sin n\omega_0t dt \right] \end{aligned}$$

but the symbol we use to identify the variable of integration cannot affect the value of the integral. Thus,

$$\int_0^{T/2} f(\tau) \sin n\omega_0\tau d\tau = \int_0^{T/2} f(t) \sin n\omega_0t dt$$

and

$$b_n = 0 \quad (\text{even sym.}) \quad [19]$$

No sine terms are present. Therefore, if  $f(t)$  shows even symmetry, then  $b_n = 0$ ; conversely, if  $b_n = 0$ , then  $f(t)$  must have even symmetry.

A similar examination of the expression for  $a_n$  leads to an integral over the *half period* extending from  $t = 0$  to  $t = \frac{1}{2}T$ :

$$a_n = \frac{4}{T} \int_0^{T/2} f(t) \cos n\omega_0t dt \quad (\text{even sym.}) \quad [20]$$

The fact that  $a_n$  may be obtained for an even function by taking “twice the integral over half the range” should seem logical.

A function having odd symmetry can contain no constant term or cosine terms in its Fourier expansion. Let us prove the second part of this statement. We have

$$\begin{aligned} a_n &= \frac{2}{T} \int_{-T/2}^{T/2} f(t) \cos n\omega_0t dt \\ &= \frac{2}{T} \left[ \int_{-T/2}^0 f(t) \cos n\omega_0t dt + \int_0^{T/2} f(t) \cos n\omega_0t dt \right] \end{aligned}$$

and we now let  $t = -\tau$  in the first integral:

$$\begin{aligned} a_n &= \frac{2}{T} \left[ \int_{T/2}^0 f(-\tau) \cos(-n\omega_0\tau)(-d\tau) + \int_0^{T/2} f(t) \cos n\omega_0t dt \right] \\ &= \frac{2}{T} \left[ \int_0^{T/2} f(-\tau) \cos n\omega_0\tau d\tau + \int_0^{T/2} f(t) \cos n\omega_0t dt \right] \end{aligned}$$

But  $f(-\tau) = -f(\tau)$ , and therefore

$$a_n = 0 \quad (\text{odd sym.}) \quad [21]$$

A similar, but simpler, proof shows that

$$a_0 = 0 \quad (\text{odd sym.})$$

With odd symmetry, therefore,  $a_n = 0$  and  $a_0 = 0$ ; conversely, if  $a_n = 0$  and  $a_0 = 0$ , odd symmetry is present.

The values of  $b_n$  may again be obtained by integrating over half the range:

$$b_n = \frac{4}{T} \int_0^{T/2} f(t) \sin n\omega_0 t \, dt \quad (\text{odd sym.}) \quad [22]$$



## Half-Wave Symmetry

The Fourier series for both of these square waves have one other interesting characteristic: neither contains any *even harmonics*.<sup>1</sup> That is, the only frequency components present in the series have frequencies which are odd multiples of the fundamental frequency;  $a_n$  and  $b_n$  are zero for even values of  $n$ . This result is caused by another type of symmetry, called half-wave symmetry. We will say that  $f(t)$  possesses *half-wave symmetry* if

$$f(t) = -f\left(t - \frac{1}{2}T\right)$$

or the equivalent expression,

$$f(t) = -f\left(t + \frac{1}{2}T\right)$$

Except for a change of sign, each half cycle is like the adjacent half cycles. Half-wave symmetry, unlike even and odd symmetry, is not a function of the choice of the point  $t = 0$ . Thus, we can state that the square wave (Fig. 18.4a or b) shows half-wave symmetry. Neither waveform shown in Fig. 18.6 has half-wave symmetry, but the two somewhat similar functions plotted in Fig. 18.7 do possess half-wave symmetry.

It may be shown that the Fourier series of any function which has half-wave symmetry contains only odd harmonics. Let us consider the coefficients  $a_n$ . We have again

$$\begin{aligned} a_n &= \frac{2}{T} \int_{-T/2}^{T/2} f(t) \cos n\omega_0 t \, dt \\ &= \frac{2}{T} \left[ \int_{-T/2}^0 f(t) \cos n\omega_0 t \, dt + \int_0^{T/2} f(t) \cos n\omega_0 t \, dt \right] \end{aligned}$$

which we may represent as

$$a_n = \frac{2}{T}(I_1 + I_2)$$

Now we substitute the new variable  $\tau = t + \frac{1}{2}T$  in the integral  $I_1$ :

$$\begin{aligned} I_1 &= \int_0^{T/2} f\left(\tau - \frac{1}{2}T\right) \cos n\omega_0 \left(\tau - \frac{1}{2}T\right) d\tau \\ &= \int_0^{T/2} -f(\tau) \left( \cos n\omega_0 \tau \cos \frac{n\omega_0 T}{2} + \sin n\omega_0 \tau \sin \frac{n\omega_0 T}{2} \right) d\tau \end{aligned}$$

(1) Constant vigilance is required to avoid confusion between an even function and an even harmonic, or between an odd function and an odd harmonic. For example,  $b_{10}$  is the coefficient of an even harmonic, and it is zero if  $f(t)$  is an even function.

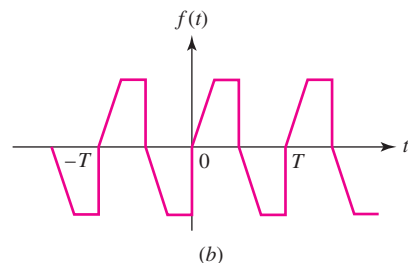
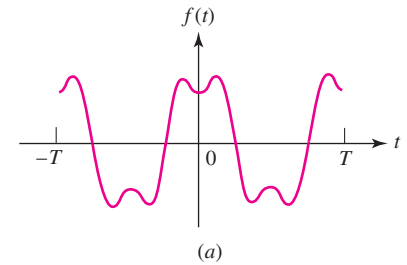

■ FIGURE 18.7 (a) A waveform somewhat similar to the one shown in Fig. 18.6a but possessing half-wave symmetry. (b) A waveform somewhat similar to the one shown in Fig. 18.6b but possessing half-wave symmetry.



But  $\omega_0 T$  is  $2\pi$ , and thus

$$\sin \frac{n\omega_0 T}{2} = \sin n\pi = 0$$

Hence

$$I_1 = -\cos n\pi \int_0^{T/2} f(\tau) \cos n\omega_0 \tau d\tau$$

After noting the form of  $I_2$ , we therefore may write

$$a_n = \frac{2}{T}(1 - \cos n\pi) \int_0^{T/2} f(t) \cos n\omega_0 t dt$$

The factor  $(1 - \cos n\pi)$  indicates that  $a_n$  is zero if  $n$  is even. Thus,

$$a_n = \begin{cases} \frac{4}{T} \int_0^{T/2} f(t) \cos n\omega_0 t dt & n \text{ odd} \\ 0 & n \text{ even} \end{cases} \quad \left(\frac{1}{2}\text{-wave sym.}\right) \quad [23]$$

A similar investigation shows that  $b_n$  is also zero for all even  $n$ , and therefore

$$b_n = \begin{cases} \frac{4}{T} \int_0^{T/2} f(t) \sin n\omega_0 t dt & n \text{ odd} \\ 0 & n \text{ even} \end{cases} \quad \left(\frac{1}{2}\text{-wave sym.}\right) \quad [24]$$



It should be noted that half-wave symmetry may be present in a waveform which also shows odd symmetry or even symmetry. The waveform sketched in Fig. 18.7a, for example, possesses both even symmetry and half-wave symmetry. When a waveform possesses half-wave symmetry and either even or odd symmetry, then it is possible to reconstruct the waveform if the function is known over any quarter-period interval. The value of  $a_n$  or  $b_n$  may also be found by integrating over any quarter period. Thus,

$$\left. \begin{aligned} a_n &= \frac{8}{T} \int_0^{T/4} f(t) \cos n\omega_0 t dt & n \text{ odd} \\ a_n &= 0 & n \text{ even} \\ b_n &= 0 & \text{all } n \end{aligned} \right\} \quad \left(\frac{1}{2}\text{-wave and even sym.}\right) \quad [25]$$

It is *always* worthwhile to spend a few moments investigating the symmetry of a function for which a Fourier series is to be determined.

$$\left. \begin{aligned} a_n &= 0 & \text{all } n \\ b_n &= \frac{8}{T} \int_0^{T/4} f(t) \sin \omega_0 t dt & n \text{ odd} \\ b_n &= 0 & n \text{ even} \end{aligned} \right\} \quad \left(\frac{1}{2}\text{-wave and odd sym.}\right) \quad [26]$$

Table 18.1 provides a short summary of the simplifications arising from the various types of symmetry discussed.

TABLE 18.1 Summary of Symmetry-Based Simplifications in Fourier Series

Symmetry Type	Characteristic	Simplification
Even	$f(t) = -f(t)$	$b_n = 0$
Odd	$f(t) = -f(-t)$	$a_n = 0$
Half-Wave	$f(t) = -f\left(t - \frac{T}{2}\right)$ or $f(t) = -f\left(t + \frac{T}{2}\right)$	$a_n = \begin{cases} \frac{4}{T} \int_0^{T/2} f(t) \cos n\omega_0 t \, dt & n \text{ odd} \\ 0 & n \text{ even} \end{cases}$ $b_n = \begin{cases} \frac{4}{T} \int_0^{T/2} f(t) \sin n\omega_0 t \, dt & n \text{ odd} \\ 0 & n \text{ even} \end{cases}$
Half-Wave and Even	$f(t) = -f\left(t - \frac{T}{2}\right)$ and $f(t) = -f(t)$ or $f(t) = -f\left(t + \frac{T}{2}\right)$ and $f(t) = -f(t)$	$a_n = \begin{cases} \frac{8}{T} \int_0^{T/4} f(t) \cos n\omega_0 t \, dt & n \text{ odd} \\ 0 & n \text{ even} \end{cases}$ $b_n = 0$ all $n$
Half-Wave and Odd	$f(t) = -f\left(t - \frac{T}{2}\right)$ and $f(t) = -f(-t)$ or $f(t) = -f\left(t + \frac{T}{2}\right)$ and $f(t) = -f(-t)$	$a_n = 0$ all $n$ $b_n = \begin{cases} \frac{8}{T} \int_0^{T/4} f(t) \sin n\omega_0 t \, dt & n \text{ odd} \\ 0 & n \text{ even} \end{cases}$

## PRACTICE

18.4 Sketch each of the functions described; state whether or not even symmetry, odd symmetry, and half-wave symmetry are present; and give the period: (a)  $v = 0$ ,  $-2 < t < 0$  and  $2 < t < 4$ ;  $v = 5$ ,  $0 < t < 2$ ;  $v = -5$ ,  $4 < t < 6$ ; repeats; (b)  $v = 10$ ,  $1 < t < 3$ ;  $v = 0$ ,  $3 < t < 7$ ;  $v = -10$ ,  $7 < t < 9$ ; repeats; (c)  $v = 8t$ ,  $-1 < t < 1$ ;  $v = 0$ ,  $1 < t < 3$ ; repeats.

18.5 Determine the Fourier series for the waveforms of Practice Problem 18.4a and b.

Ans: 18.4: No, no, yes, 8; no, no, no, 8; no, yes, no, 4.

$$18.5: \sum_{n=1(\text{odd})}^{\infty} \frac{10}{n\pi} \left( \sin \frac{n\pi}{2} \cos \frac{n\pi}{4} + \sin \frac{n\pi}{4} \right);$$

$$\sum_{n=1}^{\infty} \frac{10}{n\pi} \left[ \left( \sin \frac{3n\pi}{4} - 3 \sin \frac{n\pi}{4} \right) \cos \frac{n\pi}{4} + \left( \cos \frac{n\pi}{4} - \cos \frac{3n\pi}{4} \right) \sin \frac{n\pi}{4} \right].$$

### 18.3 COMPLETE RESPONSE TO PERIODIC FORCING FUNCTIONS

Through the use of the Fourier series, we may now express an arbitrary periodic forcing function as the sum of an infinite number of sinusoidal forcing functions. The forced response to each of these functions may be determined by conventional steady-state analysis, and the form of the natural response may be determined from the poles of an appropriate network transfer function. The initial conditions existing throughout the network, including the initial value of the forced response, enable the amplitude of the natural response to be selected; the complete response is then obtained as the sum of the forced and natural responses.

#### EXAMPLE 18.2

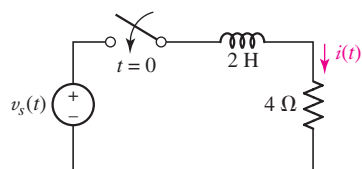

(a)

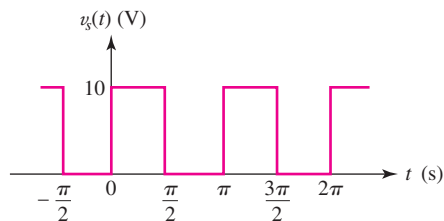

(b)

■ FIGURE 18.8 (a) A simple series  $RL$  circuit subjected to a periodic forcing function  $v_s(t)$ . (b) The form of the forcing function.

Recall that  $V_m \sin \omega t$  is equal to  $V_m \cos(\omega t - 90^\circ)$ , corresponding to  $V_m \angle -90^\circ = -jV_m$ .

For the circuit of Fig. 18.8a, determine the periodic response  $i(t)$  corresponding to the forcing function shown in Fig. 18.8b if  $i(0) = 0$ .

The forcing function has a fundamental frequency  $\omega_0 = 2$  rad/s, and its Fourier series may be written down by comparison with the Fourier series developed for the waveform of Fig. 18.4b in the solution of Practice Problem 18.3,

$$v_s(t) = 5 + \frac{20}{\pi} \sum_{n=1(\text{odd})}^{\infty} \frac{\sin 2nt}{n}$$

We will find the forced response for the  $n$ th harmonic by working in the frequency domain. Thus,

$$v_{sn}(t) = \frac{20}{n\pi} \sin 2nt$$

and

$$\mathbf{V}_{sn} = \frac{20}{n\pi} \angle -90^\circ = -j \frac{20}{n\pi}$$

The impedance offered by the  $RL$  circuit at this frequency is

$$\mathbf{Z}_n = 4 + j(2n)2 = 4 + j4n$$

and thus the component of the forced response at this frequency is

$$\mathbf{I}_{fn} = \frac{\mathbf{V}_{sn}}{\mathbf{Z}_n} = \frac{-j5}{n\pi(1 + jn)}$$

Transforming to the time domain, we have

$$\begin{aligned} i_{fn} &= \frac{5}{n\pi} \frac{1}{\sqrt{1+n^2}} \cos(2nt - 90^\circ - \tan^{-1} n) \\ &= \frac{5}{\pi(1+n^2)} \left( \frac{\sin 2nt}{n} - \cos 2nt \right) \end{aligned}$$

Since the response to the dc component is simply  $5 \text{ V}/4 \Omega = 1.25 \text{ A}$ , the forced response may be expressed as the summation

$$i_f(t) = 1.25 + \frac{5}{\pi} \sum_{n=1(\text{odd})}^{\infty} \left[ \frac{\sin 2nt}{n(1+n^2)} - \frac{\cos 2nt}{1+n^2} \right]$$

The familiar natural response of this simple circuit is the single exponential term [characterizing the single pole of the transfer function,  $\mathbf{I}_f/\mathbf{V}_s = 1/(4 + 2s)$ ]

$$i_n(t) = Ae^{-2t}$$

The *complete* response is therefore the sum

$$i(t) = i_f(t) + i_n(t)$$

Letting  $t = 0$ , we find  $A$  using  $i(0) = 0$ :

$$A = -1.25 + \frac{5}{\pi} \sum_{n=1(\text{odd})}^{\infty} \frac{1}{1+n^2}$$

Although correct, it is more convenient to use the numerical value of the summation. The sum of the first 5 terms of  $\sum 1/(1+n^2)$  is 0.671, the sum of the first 10 terms is 0.695, the sum of the first 20 terms is 0.708, and the exact sum is 0.720 to three significant figures. Thus

$$A = -1.25 + \frac{5}{\pi}(0.720) = -0.104$$

and

$$i(t) = -0.104e^{-2t} + 1.25 + \frac{5}{\pi} \sum_{n=1(\text{odd})}^{\infty} \left[ \frac{\sin 2nt}{n(1+n^2)} - \frac{\cos 2nt}{1+n^2} \right] \text{ amperes}$$

In obtaining this solution, we have had to use many of the most general concepts introduced in this and the preceding 17 chapters. Some we did not have to use because of the simple nature of this particular circuit, but their places in the general analysis were indicated. In this sense, we may look upon the solution of this problem as a significant achievement in our introductory study of circuit analysis. In spite of this glorious feeling of accomplishment, however, it must be pointed out that the complete response, as obtained in Example 18.2 in analytical form, is not of much value as it stands; it furnishes no clear picture of the nature of the response. What we really need is a sketch of  $i(t)$  as a function of time. This may be obtained by a laborious calculation at a sufficient number of instants of time; a desktop computer or a programmable calculator can be of great assistance here. The sketch may be approximated by the graphical addition of the natural response, the dc term, and the first few harmonics; this is an unrewarding task.

When all is said and done, the most informative solution of this problem is probably obtained by making a repeated transient analysis. That is, the form of the response can certainly be calculated in the interval from  $t = 0$  to  $t = \pi/2 \text{ s}$ ; it is an exponential rising toward 2.5 A. After determining the

value at the end of this first interval, we have an initial condition for the next  $(\pi/2)$ -second interval. The process is repeated until the response assumes a generally periodic nature. The method is eminently suitable to this example, for there is negligible change in the current waveform in the successive periods  $\pi/2 < t < 3\pi/2$  and  $3\pi/2 < t < 5\pi/2$ . The complete current response is sketched in Fig. 18.9.

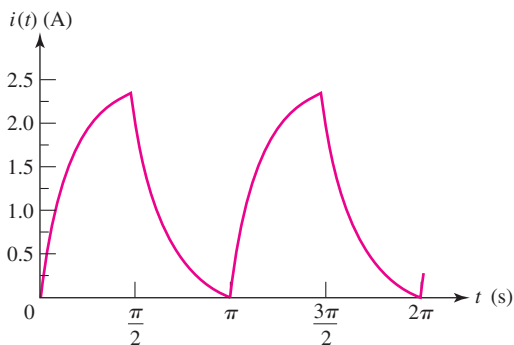

■ FIGURE 18.9 The initial portion of the complete response of the circuit of Fig. 18.8a to the forcing function of Fig. 18.8b.

### PRACTICE

18.6 Use the methods of Chap. 8 to determine the value of the current sketched in Fig. 18.9 at  $t$  equal to (a)  $\pi/2$ ; (b)  $\pi$ ; (c)  $3\pi/2$ .

Ans: 2.392 A; 0.1034 A; 2.396 A.

## 18.4 COMPLEX FORM OF THE FOURIER SERIES

In obtaining a frequency spectrum, we have seen that the amplitude of each frequency component depends on both  $a_n$  and  $b_n$ ; that is, the sine term and the cosine term both contribute to the amplitude. The exact expression for this amplitude is  $\sqrt{a_n^2 + b_n^2}$ . It is also possible to obtain the amplitude directly by using a form of Fourier series in which each term is a cosine function with a phase angle; the amplitude and phase angle are functions of  $f(t)$  and  $n$ . An even more convenient and concise form of the Fourier series is obtained if the sines and cosines are expressed as exponential functions with complex multiplying constants.

Let us first take the trigonometric form of the Fourier series:

$$f(t) = a_0 + \sum_{n=1}^{\infty} (a_n \cos n\omega_0 t + b_n \sin n\omega_0 t)$$

and then substitute the exponential forms for the sine and cosine. After rearranging,

$$f(t) = a_0 + \sum_{n=1}^{\infty} \left( e^{jn\omega_0 t} \frac{a_n - jb_n}{2} + e^{-jn\omega_0 t} \frac{a_n + jb_n}{2} \right)$$

The reader may recall the identities

$$\sin \alpha = \frac{e^{j\alpha} - e^{-j\alpha}}{j2}$$

and

$$\cos \alpha = \frac{e^{j\alpha} + e^{-j\alpha}}{2}$$



We now define a complex constant  $\mathbf{c}_n$ :

$$\mathbf{c}_n = \frac{1}{2}(a_n - jb_n) \quad (n = 1, 2, 3, \dots) \quad [27]$$

The values of  $a_n$ ,  $b_n$ , and  $\mathbf{c}_n$  all depend on  $n$  and  $f(t)$ . Suppose we now replace  $n$  with  $(-n)$ ; how do the values of the constants change? The coefficients  $a_n$  and  $b_n$  are defined by Eqs. [10] and [11], and it is evident that

$$a_{-n} = a_n$$

but

$$b_{-n} = -b_n$$

From Eq. [27], then,

$$\mathbf{c}_{-n} = \frac{1}{2}(a_n + jb_n) \quad (n = 1, 2, 3, \dots) \quad [28]$$

Thus,

$$\mathbf{c}_n = \mathbf{c}_{-n}^*$$

We also let

$$\mathbf{c}_0 = a_0$$

We may therefore express  $f(t)$  as

$$f(t) = \mathbf{c}_0 + \sum_{n=1}^{\infty} \mathbf{c}_n e^{jn\omega_0 t} + \sum_{n=1}^{\infty} \mathbf{c}_{-n} e^{-jn\omega_0 t}$$

or

$$f(t) = \sum_{n=0}^{\infty} \mathbf{c}_n e^{jn\omega_0 t} + \sum_{n=1}^{\infty} \mathbf{c}_{-n} e^{-jn\omega_0 t}$$

Finally, instead of summing the second series over the positive integers from 1 to  $\infty$ , let us sum over the negative integers from  $-1$  to  $-\infty$ :

$$f(t) = \sum_{n=0}^{\infty} \mathbf{c}_n e^{jn\omega_0 t} + \sum_{n=-1}^{-\infty} \mathbf{c}_n e^{jn\omega_0 t}$$

or

$$f(t) = \sum_{n=-\infty}^{\infty} \mathbf{c}_n e^{jn\omega_0 t} \quad [29]$$

By agreement, a summation from  $-\infty$  to  $\infty$  is understood to include a term for  $n = 0$ .

Equation [29] is the *complex form* of the Fourier series for  $f(t)$ ; its conciseness is one of the most important reasons for its use. In order to obtain the expression by which a particular complex coefficient  $\mathbf{c}_n$  may be evaluated, we substitute Eqs. [10] and [11] in Eq. [27]:

$$\mathbf{c}_n = \frac{1}{T} \int_{-T/2}^{T/2} f(t) \cos n\omega_0 t \, dt - j \frac{1}{T} \int_{-T/2}^{T/2} f(t) \sin n\omega_0 t \, dt$$



and then we use the exponential equivalents of the sine and cosine and simplify:

$$\mathbf{c}_n = \frac{1}{T} \int_{-T/2}^{T/2} f(t) e^{-jn\omega_0 t} dt \quad [30]$$

Thus, a single concise equation serves to replace the two equations required for the trigonometric form of the Fourier series. Instead of evaluating two integrals to find the Fourier coefficients, only one integration is required; moreover, it is almost always a simpler integration. It should be noted that the integral of Eq. [30] contains the multiplying factor  $1/T$ , whereas the integrals for  $a_n$  and  $b_n$  both contain the factor  $2/T$ .

Collecting the two basic relationships for the exponential form of the Fourier series, we have

$$f(t) = \sum_{n=-\infty}^{\infty} \mathbf{c}_n e^{jn\omega_0 t} \quad [29]$$

$$\mathbf{c}_n = \frac{1}{T} \int_{-T/2}^{T/2} f(t) e^{-jn\omega_0 t} dt \quad [30]$$

where  $\omega_0 = 2\pi/T$  as usual.

The amplitude of the component of the exponential Fourier series at  $\omega = n\omega_0$ , where  $n = 0, \pm 1, \pm 2, \dots$ , is  $|\mathbf{c}_n|$ . We may plot a discrete frequency spectrum giving  $|\mathbf{c}_n|$  versus  $n\omega_0$  or  $nf_0$ , using an abscissa that shows both positive and negative values; and when we do this, the graph is symmetrical about the origin, since Eqs. [27] and [28] show that  $|\mathbf{c}_n| = |\mathbf{c}_{-n}|$ .

We note also from Eqs. [29] and [30] that the amplitude of the sinusoidal component at  $\omega = n\omega_0$ , where  $n = 1, 2, 3, \dots$ , is  $\sqrt{a_n^2 + b_n^2} = 2|\mathbf{c}_n| = 2|\mathbf{c}_{-n}| = |\mathbf{c}_n| + |\mathbf{c}_{-n}|$ . For the dc component,  $a_0 = \mathbf{c}_0$ .

The exponential Fourier coefficients, given by Eq. [30], are also affected by the presence of certain symmetries in  $f(t)$ . Thus, appropriate expressions for  $\mathbf{c}_n$  are

$$\mathbf{c}_n = \frac{2}{T} \int_0^{T/2} f(t) \cos n\omega_0 t dt \quad (\text{even sym.}) \quad [31]$$

$$\mathbf{c}_n = \frac{-j2}{T} \int_0^{T/2} f(t) \sin n\omega_0 t dt \quad (\text{odd sym.}) \quad [32]$$

$$\mathbf{c}_n = \begin{cases} \frac{2}{T} \int_0^{T/2} f(t) e^{-jn\omega_0 t} dt & (n \text{ odd, } \frac{1}{2}\text{-wave sym.}) \\ 0 & (n \text{ even, } \frac{1}{2}\text{-wave sym.}) \end{cases} \quad [33a]$$

$$\mathbf{c}_n = \begin{cases} \frac{4}{T} \int_0^{T/4} f(t) \cos n\omega_0 t dt & (n \text{ odd, } \frac{1}{2}\text{-wave and even sym.}) \\ 0 & (n \text{ even, } \frac{1}{2}\text{-wave and even sym.}) \end{cases} \quad [34a]$$

$$\mathbf{c}_n = \begin{cases} \frac{-j4}{T} \int_0^{T/4} f(t) \sin n\omega_0 t dt & (n \text{ odd, } \frac{1}{2}\text{-wave and odd sym.}) \\ 0 & (n \text{ even, } \frac{1}{2}\text{-wave and odd sym.}) \end{cases} \quad [35a]$$

$$[35b]$$

## EXAMPLE 18.3

Determine  $c_n$  for the square wave of Fig. 18.10.

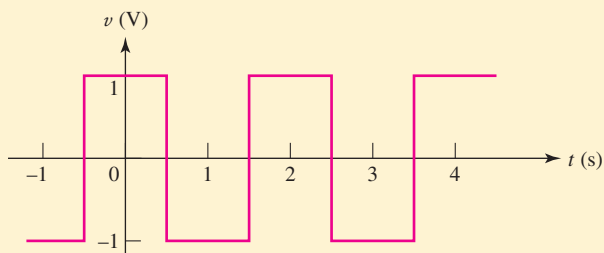

FIGURE 18.10 A square wave function possessing both even and half-wave symmetry.

This square wave possesses both even and half-wave symmetry. If we ignore the symmetry and use our general equation [30], with  $T = 2$  and  $\omega_0 = 2\pi/2 = \pi$ , we have

$$\begin{aligned} c_n &= \frac{1}{T} \int_{-T/2}^{T/2} f(t) e^{-jn\omega_0 t} dt \\ &= \frac{1}{2} \left[ \int_{-1}^{-0.5} -e^{-jn\pi t} dt + \int_{-0.5}^{0.5} e^{-jn\pi t} dt - \int_{0.5}^1 e^{-jn\pi t} dt \right] \\ &= \frac{1}{2} \left[ \frac{-1}{-jn\pi} (e^{-jn\pi t}) \Big|_{-1}^{-0.5} + \frac{1}{-jn\pi} (e^{-jn\pi t}) \Big|_{-0.5}^{0.5} + \frac{-1}{-jn\pi} (e^{-jn\pi t}) \Big|_{0.5}^1 \right] \\ &= \frac{1}{j2n\pi} (e^{jn\pi/2} - e^{jn\pi} - e^{-jn\pi/2} + e^{jn\pi/2} + e^{-jn\pi} - e^{-jn\pi/2}) \\ &= 2 \frac{e^{jn\pi/2} - e^{-jn\pi/2}}{j2n\pi} - \frac{e^{jn\pi} - e^{-jn\pi}}{j2n\pi} \\ &= \frac{1}{n\pi} \left[ 2 \sin \frac{n\pi}{2} - \sin n\pi \right] \end{aligned}$$

We thus find that  $c_0 = 0$ ,  $c_1 = 2/\pi$ ,  $c_2 = 0$ ,  $c_3 = -2/3\pi$ ,  $c_4 = 0$ ,  $c_5 = 2/5\pi$ , and so forth. These values agree with the trigonometric Fourier series given as the answer we obtained in Practice Problem 18.3 for the same waveform shown in Fig. 18.4b if we remember that  $a_n = 2c_n$  when  $b_n = 0$ .

Utilizing the symmetry of the waveform (even and half-wave), there is less work when we apply Eqs. [34a] and [34b], leading to

$$\begin{aligned} c_n &= \frac{4}{T} \int_0^{T/4} f(t) \cos n\omega_0 t dt \\ &= \frac{4}{2} \int_0^{0.5} \cos n\pi t dt = \frac{2}{n\pi} (\sin n\pi t) \Big|_0^{0.5} \\ &= \begin{cases} \frac{2}{n\pi} \sin \frac{n\pi}{2} & (n \text{ odd}) \\ 0 & (n \text{ even}) \end{cases} \end{aligned}$$

These results are the same as those we just obtained when we did not take the symmetry of the waveform into account.

Now let us consider a more difficult, more interesting example.

### EXAMPLE 18.4

A certain function  $f(t)$  is a train of rectangular pulses of amplitude  $V_0$  and duration  $\tau$ , recurring periodically every  $T$  seconds, as shown in Fig. 18.11. Find the exponential Fourier series for  $f(t)$ .

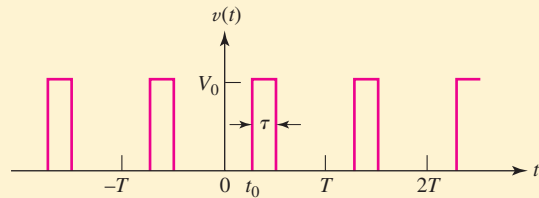

■ FIGURE 18.11 A periodic sequence of rectangular pulses.

The fundamental frequency is  $f_0 = 1/T$ . No symmetry is present, and the value of a general complex coefficient is found from Eq. [30]:

$$\begin{aligned} \mathbf{c}_n &= \frac{1}{T} \int_{-T/2}^{T/2} f(t) e^{-jn\omega_0 t} dt = \frac{V_0}{T} \int_{t_0}^{t_0+\tau} e^{-jn\omega_0 t} dt \\ &= \frac{V_0}{-jn\omega_0 T} (e^{-jn\omega_0(t_0+\tau)} - e^{-jn\omega_0 t_0}) \\ &= \frac{2V_0}{n\omega_0 T} e^{-jn\omega_0(t_0+\tau/2)} \sin\left(\frac{1}{2}n\omega_0\tau\right) \\ &= \frac{V_0\tau}{T} \frac{\sin\left(\frac{1}{2}n\omega_0\tau\right)}{\frac{1}{2}n\omega_0\tau} e^{-jn\omega_0(t_0+\tau/2)} \end{aligned}$$

The magnitude of  $\mathbf{c}_n$  is therefore

$$|\mathbf{c}_n| = \frac{V_0\tau}{T} \left| \frac{\sin\left(\frac{1}{2}n\omega_0\tau\right)}{\frac{1}{2}n\omega_0\tau} \right| \quad [36]$$

and the angle of  $\mathbf{c}_n$  is

$$\text{ang } \mathbf{c}_n = -n\omega_0 \left( t_0 + \frac{\tau}{2} \right) \quad (\text{possibly plus } 180^\circ) \quad [37]$$

Equations [36] and [37] represent our solution to this exponential Fourier series problem.

## The Sampling Function

The trigonometric factor in Eq. [36] occurs frequently in modern communication theory, and it is called the *sampling function*. The “sampling” refers to the time function of Fig. 18.11 from which the sampling function is derived. The product of this sequence of pulses and any other function  $f(t)$

represents *samples* of  $f(t)$  every  $T$  seconds if  $\tau$  is small and  $V_0 = 1$ . We define

$$\text{Sa}(x) = \frac{\sin x}{x}$$

Because of the way in which it helps to determine the amplitude of the various frequency components in  $f(t)$ , it is worth our while to discover the important characteristics of this function. First, we note that  $\text{Sa}(x)$  is zero whenever  $x$  is an integral multiple of  $\pi$ ; that is,

$$\text{Sa}(n\pi) = 0 \quad n = 1, 2, 3, \dots$$

When  $x$  is zero, the function is indeterminate, but it is easy to show that its value is unity:

$$\text{Sa}(0) = 1$$

The magnitude of  $\text{Sa}(x)$  therefore decreases from unity at  $x = 0$  to zero at  $x = \pi$ . As  $x$  increases from  $\pi$  to  $2\pi$ ,  $|\text{Sa}(x)|$  increases from zero to a maximum less than unity, and then decreases to zero once again. As  $x$  continues to increase, the successive maxima continually become smaller because the numerator of  $\text{Sa}(x)$  cannot exceed unity and the denominator is continually increasing. Also,  $\text{Sa}(x)$  shows even symmetry.

Now let us construct the line spectrum. We first consider  $|\mathbf{c}_n|$ , writing Eq. [36] in terms of the fundamental cyclic frequency  $f_0$ :

$$|\mathbf{c}_n| = \frac{V_0\tau}{T} \left| \frac{\sin(n\pi f_0\tau)}{n\pi f_0\tau} \right| \quad [38]$$

The amplitude of any  $\mathbf{c}_n$  is obtained from Eq. [38] by using the known values  $\tau$  and  $T = 1/f_0$  and selecting the desired value of  $n$ ,  $n = 0, \pm 1, \pm 2, \dots$ . Instead of evaluating Eq. [38] at these discrete frequencies, let us sketch the *envelope* of  $|\mathbf{c}_n|$  by considering the frequency  $nf_0$  to be a continuous variable. That is,  $f$ , which is  $nf_0$ , can actually take on only the discrete values of the harmonic frequencies  $0, \pm f_0, \pm 2f_0, \pm 3f_0$ , and so forth, but we may think of  $n$  for the moment as a continuous variable. When  $f$  is zero,  $|\mathbf{c}_n|$  is evidently  $V_0\tau/T$ , and when  $f$  has increased to  $1/\tau$ ,  $|\mathbf{c}_n|$  is zero. The resultant envelope is first sketched as in Fig. 18.12a. The line spectrum is then obtained by simply erecting a vertical line at each harmonic frequency, as shown in the sketch. The amplitudes shown are those of the  $\mathbf{c}_n$ . The particular case sketched applies to the case where  $\tau/T = 1/(1.5\pi) = 0.212$ . In this example, it happens that there is no harmonic exactly at that frequency at which the envelope amplitude is zero; another choice of  $\tau$  or  $T$  could produce such an occurrence, however.

In Fig. 18.12b, the amplitude of the sinusoidal component is plotted as a function of frequency. Note again that  $a_0 = \mathbf{c}_0$  and  $\sqrt{a_n^2 + b_n^2} = |\mathbf{c}_n| + |\mathbf{c}_{-n}|$ .

There are several observations and conclusions which we may make about the line spectrum of a periodic sequence of rectangular pulses, as given in Fig. 18.12b. With respect to the envelope of the discrete spectrum, it is evident that the “width” of the envelope depends upon  $\tau$ , and not upon  $T$ . As a matter of fact, the shape of the envelope is not a function of  $T$ . It follows that the bandwidth of a filter which is designed to pass the periodic pulses is a function of the pulse width  $\tau$ , but not of the pulse period  $T$ ; an



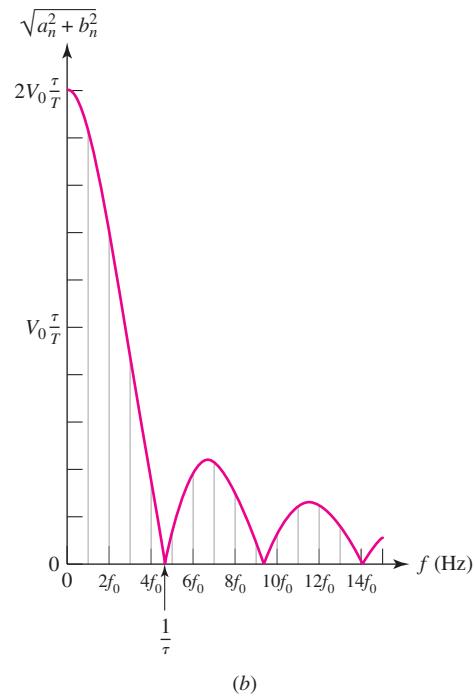
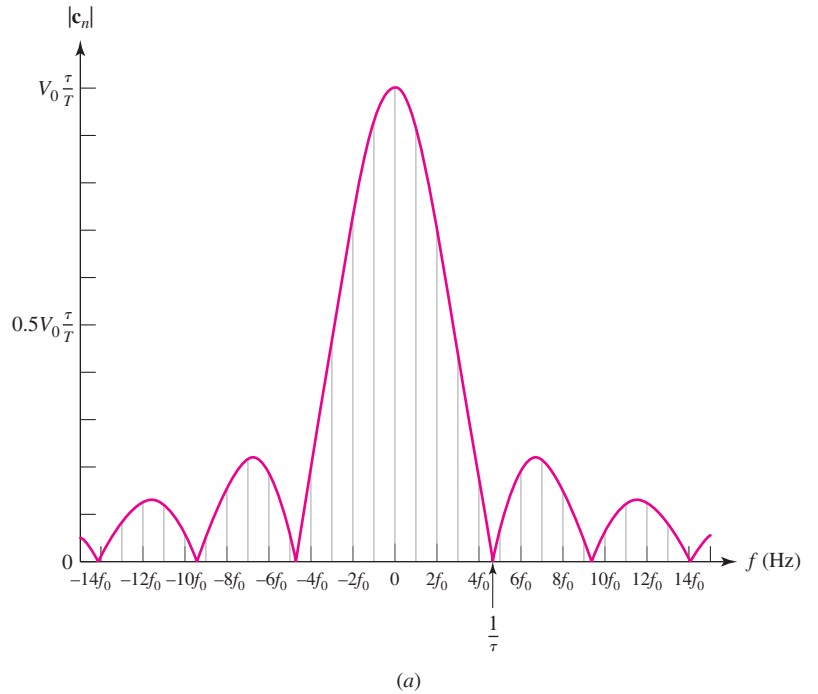

■ FIGURE 18.12 (a) The discrete line spectrum of  $|c_n|$  versus  $f = nf_0, n = 0, \pm 1, \pm 2, \dots$ , corresponding to the pulse train shown in Fig. 18.11. (b)  $\sqrt{a_n^2 + b_n^2}$  versus  $f = nf_0, n = 0, 1, 2, \dots$ , for the same pulse train.

inspection of Fig. 18.12*b* indicates that the required bandwidth is about  $1/\tau$  Hz. If the pulse period  $T$  is increased (or the pulse repetition frequency  $f_0$  is decreased), the bandwidth  $1/\tau$  does not change, but the number of spectral lines between zero frequency and  $1/\tau$  Hz increases, albeit discontinuously; the amplitude of each line is inversely proportional to  $T$ . Finally, a shift in the time origin does not change the line spectrum; that is,  $|\mathbf{c}_n|$  is not a function of  $t_0$ . The relative phases of the frequency components do change with the choice of  $t_0$ .

### PRACTICE

18.7 Determine the general coefficient  $\mathbf{c}_n$  in the complex Fourier series for the waveform shown in (a) Fig. 18.4*a*; (b) Fig. 18.4*c*.

Ans:  $-j2/(n\pi)$  for  $n$  odd, 0 for  $n$  even;  $-j[4/(n^2\pi^2)] \sin n\pi/2$  for all  $n$ .

## 18.5 DEFINITION OF THE FOURIER TRANSFORM

Now that we are familiar with the basic concepts of the Fourier series representation of periodic functions, let us proceed to define the Fourier transform by first recalling the spectrum of the periodic train of rectangular pulses we obtained in Sec. 18.4. That was a *discrete* line spectrum, which is the type that we must always obtain for periodic functions of time. The spectrum was discrete in the sense that it was not a smooth or continuous function of frequency; instead, it had nonzero values only at specific frequencies.

There are many important forcing functions, however, that are not periodic functions of time, such as a single rectangular pulse, a step function, a ramp function, or the somewhat strange type of function called the *impulse function* defined in Chap. 14. Frequency spectra may be obtained for such nonperiodic functions, but they will be *continuous* spectra in which some energy, in general, may be found in any nonzero frequency interval, no matter how small.



We will develop this concept by beginning with a periodic function and then letting the period become infinite. Our experience with periodic rectangular pulses should indicate that the envelope will decrease in amplitude without otherwise changing shape, and that more and more frequency components will be found in any given frequency interval. In the limit, we should expect an envelope of vanishingly small amplitude, filled with an infinite number of frequency components separated by vanishingly small frequency intervals. The number of frequency components between 0 and 100 Hz, for example, becomes infinite, but the amplitude of each one approaches zero. At first thought, a spectrum of zero amplitude is a puzzling concept. We know that the line spectrum of a periodic forcing function shows the amplitude of each frequency component. But what does the zero-amplitude continuous spectrum of a nonperiodic forcing function signify? That question will be answered in the following section; now we proceed to carry out the limiting procedure just suggested.

We begin with the exponential form of the Fourier series:

$$f(t) = \sum_{n=-\infty}^{\infty} \mathbf{c}_n e^{jn\omega_0 t} \quad [39]$$

where

$$\mathbf{c}_n = \frac{1}{T} \int_{-T/2}^{T/2} f(t) e^{-jn\omega_0 t} dt \quad [40]$$

and

$$\omega_0 = \frac{2\pi}{T} \quad [41]$$

We now let

$$T \rightarrow \infty$$

and thus, from Eq. [41],  $\omega_0$  must become vanishingly small. We represent this limit by a differential:

$$\omega_0 \rightarrow d\omega$$

Thus

$$\frac{1}{T} = \frac{\omega_0}{2\pi} \rightarrow \frac{d\omega}{2\pi} \quad [42]$$

Finally, the frequency of any “harmonic”  $n\omega_0$  must now correspond to the general frequency variable which describes the continuous spectrum. In other words,  $n$  must tend to infinity as  $\omega_0$  approaches zero, so that the product is finite:

$$n\omega_0 \rightarrow \omega \quad [43]$$

When these four limiting operations are applied to Eq. [40], we find that  $\mathbf{c}_n$  must approach zero, as we had previously presumed. If we multiply each side of Eq. [40] by the period  $T$  and then undertake the limiting process, a nontrivial result is obtained:

$$\mathbf{c}_n T \rightarrow \int_{-\infty}^{\infty} f(t) e^{-j\omega t} dt$$

The right-hand side of this expression is a function of  $\omega$  (and *not* of  $t$ ), and we represent it by  $\mathbf{F}(j\omega)$ :

$$\mathbf{F}(j\omega) = \int_{-\infty}^{\infty} f(t) e^{-j\omega t} dt \quad [44]$$

Now let us apply the limiting process to Eq. [39]. We begin by multiplying and dividing the summation by  $T$ ,

$$f(t) = \sum_{n=-\infty}^{\infty} \mathbf{c}_n T e^{jn\omega_0 t} \frac{1}{T}$$

next replacing  $\mathbf{c}_n T$  with the new quantity  $\mathbf{F}(j\omega)$ , and then making use of expressions [42] and [43]. In the limit, the summation becomes an integral, and

$$f(t) = \frac{1}{2\pi} \int_{-\infty}^{\infty} \mathbf{F}(j\omega) e^{j\omega t} d\omega \quad [45]$$



Equations [44] and [45] are collectively called the *Fourier transform pair*. The function  $\mathbf{F}(j\omega)$  is the *Fourier transform* of  $f(t)$ , and  $f(t)$  is the *inverse* Fourier transform of  $\mathbf{F}(j\omega)$ .

This transform-pair relationship is very important! We should memorize it, draw arrows pointing to it, and mentally keep it on the conscious level. We emphasize the importance of these relations by repeating them in boxed form:

$$\mathbf{F}(j\omega) = \int_{-\infty}^{\infty} e^{-j\omega t} f(t) dt \quad [46a]$$

$$f(t) = \frac{1}{2\pi} \int_{-\infty}^{\infty} e^{j\omega t} \mathbf{F}(j\omega) d\omega \quad [46b]$$

The exponential terms in these two equations carry opposite signs for the exponents. To keep them straight, it may help to note that the positive sign is associated with the expression for  $f(t)$ , as it is with the complex Fourier series, Eq. [39].

It is appropriate to raise one question at this time. For the Fourier transform relationships of Eq. [46], can we obtain the Fourier transform of *any* arbitrarily chosen  $f(t)$ ? It turns out that the answer is affirmative for almost any voltage or current that we can actually produce. A sufficient condition for the existence of  $\mathbf{F}(j\omega)$  is that

$$\int_{-\infty}^{\infty} |f(t)| dt < \infty$$

This condition is not *necessary*, however, because some functions that do not meet it still have a Fourier transform; the step function is one such example. Furthermore, we will see later that  $f(t)$  does not even need to be nonperiodic in order to have a Fourier transform; the Fourier series representation for a periodic time function is just a special case of the more general Fourier transform representation.

As we indicated earlier, the Fourier transform-pair relationship is unique. For a given  $f(t)$  there is one specific  $\mathbf{F}(j\omega)$ ; and for a given  $\mathbf{F}(j\omega)$  there is one specific  $f(t)$ .

The reader may have already noticed a few similarities between the Fourier transform and the Laplace transform. Key differences between the two include the fact that initial energy storage is not easily incorporated in circuit analysis using Fourier transforms while it is very easily incorporated in the case of Laplace transforms. Also, there are several time functions (e.g., the *increasing* exponential) for which a Fourier transform does not exist. However, if it is spectral information as opposed to transient response in which we are primarily concerned, the Fourier transform is the ticket.

## EXAMPLE 18.5

**Use the Fourier transform to obtain the continuous spectrum of the single rectangular pulse Fig. 18.13a.**

The pulse is a truncated version of the sequence considered previously in Fig. 18.11, and is described by

$$f(t) = \begin{cases} V_0 & t_0 < t < t_0 + \tau \\ 0 & t < t_0 \text{ and } t > t_0 + \tau \end{cases}$$

(Continued on next page)

The Fourier transform of  $f(t)$  is found from Eq. [46a]:

$$\mathbf{F}(j\omega) = \int_{t_0}^{t_0+\tau} V_0 e^{-j\omega t} dt$$

and this may be easily integrated and simplified:

$$\mathbf{F}(j\omega) = V_0 \tau \frac{\sin \frac{1}{2}\omega\tau}{\frac{1}{2}\omega\tau} e^{-j\omega(t_0+\tau/2)}$$

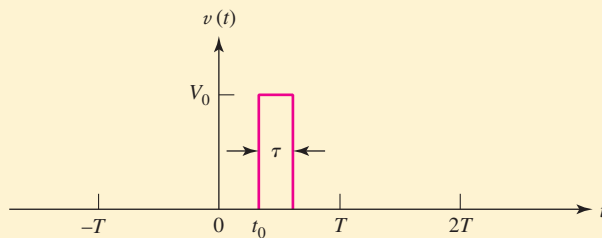

(a)

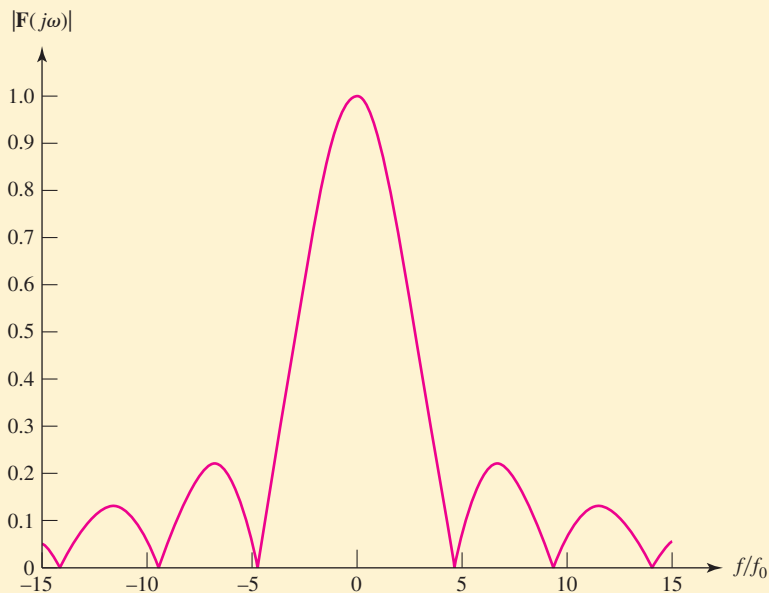

(b)

■ FIGURE 18.13 (a) A single rectangular pulse identical to those of the sequence in Fig. 18.11. (b) A plot of  $|\mathbf{F}(j\omega)|$  corresponding to the pulse, with  $V_0 = 1$ ,  $\tau = 1$ , and  $t_0 = 0$ . The frequency axis has been normalized to the value of  $f_0 = 1/1.5\pi$  corresponding to Fig. 18.12a to allow comparison; note that  $f_0$  has no meaning or relevance in the context of  $\mathbf{F}(j\omega)$ .

The magnitude of  $\mathbf{F}(j\omega)$  yields the continuous frequency spectrum, and it is of the form of the sampling function. The value of  $\mathbf{F}(0)$  is  $V_0\tau$ . The shape of the spectrum is identical with the envelope in Fig. 18.12b. A plot of  $|\mathbf{F}(j\omega)|$  as a function of  $\omega$  does *not* indicate the magnitude of the voltage present at any given frequency. What is it, then? Examination of

Eq. [45] shows that, if  $f(t)$  is a voltage waveform, then  $\mathbf{F}(j\omega)$  is dimensionally “volts per unit frequency,” a concept that was introduced in Sec. 15.1.

### PRACTICE

18.8 If  $f(t) = -10$  V,  $-0.2 < t < -0.1$  s,  $f(t) = 10$  V,  $0.1 < t < 0.2$  s, and  $f(t) = 0$  for all other  $t$ , evaluate  $\mathbf{F}(j\omega)$  for  $\omega$  equal to (a) 0;

(b)  $10\pi$  rad/s; (c)  $-10\pi$  rad/s; (d)  $15\pi$  rad/s; (e)  $-20\pi$  rad/s.

18.9 If  $\mathbf{F}(j\omega) = -10$  V/(rad/s) for  $-4 < \omega < -2$  rad/s,  $+10$  V/(rad/s) for  $2 < \omega < 4$  rad/s, and 0 for all other  $\omega$ , find the numerical value of  $f(t)$  at  $t$  equal to (a)  $10^{-4}$  s; (b)  $10^{-2}$  s; (c)  $\pi/4$  s; (d)  $\pi/2$  s; (e)  $\pi$  s.

Ans: 18.8: 0;  $j1.273$  V/(rad/s);  $-j1.273$  V/(rad/s);  $-j0.424$  V/(rad/s); 0.

18.9:  $j1.9099 \times 10^{-3}$  V;  $j0.1910$  V;  $j4.05$  V;  $-j4.05$  V; 0.

## 18.6 SOME PROPERTIES OF THE FOURIER TRANSFORM

Our object in this section is to establish several of the mathematical properties of the Fourier transform and, even more important, to understand its physical significance. We begin by using Euler's identity to replace  $e^{-j\omega t}$  in Eq. [46a]:

$$\mathbf{F}(j\omega) = \int_{-\infty}^{\infty} f(t) \cos \omega t dt - j \int_{-\infty}^{\infty} f(t) \sin \omega t dt \quad [47]$$

Since  $f(t)$ ,  $\cos \omega t$ , and  $\sin \omega t$  are all real functions of time, both the integrals in Eq. [47] are real functions of  $\omega$ . Thus, by letting

$$\mathbf{F}(j\omega) = A(\omega) + jB(\omega) = |\mathbf{F}(j\omega)|e^{j\phi(\omega)} \quad [48]$$

we have

$$A(\omega) = \int_{-\infty}^{\infty} f(t) \cos \omega t dt \quad [49]$$

$$B(\omega) = - \int_{-\infty}^{\infty} f(t) \sin \omega t dt \quad [50]$$

$$|\mathbf{F}(j\omega)| = \sqrt{A^2(\omega) + B^2(\omega)} \quad [51]$$

and

$$\phi(\omega) = \tan^{-1} \frac{B(\omega)}{A(\omega)} \quad [52]$$

Replacing  $\omega$  by  $-\omega$  shows that  $A(\omega)$  and  $|\mathbf{F}(j\omega)|$  are both even functions of  $\omega$ , while  $B(\omega)$  and  $\phi(\omega)$  are both odd functions of  $\omega$ .

Now, if  $f(t)$  is an even function of  $t$ , then the integrand of Eq. [50] is an odd function of  $t$ , and the symmetrical limits force  $B(\omega)$  to be zero; thus, if  $f(t)$  is even, its Fourier transform  $\mathbf{F}(j\omega)$  is a real, even function of  $\omega$ , and the phase function  $\phi(\omega)$  is zero or  $\pi$  for all  $\omega$ . However, if  $f(t)$  is an

odd function of  $t$ , then  $A(\omega) = 0$  and  $\mathbf{F}(j\omega)$  is both odd and a pure imaginary function of  $\omega$ ;  $\phi(\omega)$  is  $\pm\pi/2$ . In general, however,  $\mathbf{F}(j\omega)$  is a complex function of  $\omega$ .

Finally, we note that the replacement of  $\omega$  by  $-\omega$  in Eq. [47] forms the *conjugate* of  $\mathbf{F}(j\omega)$ . Thus,

$$\mathbf{F}(-j\omega) = A(\omega) - jB(\omega) = \mathbf{F}^*(j\omega)$$

and we have

$$\mathbf{F}(j\omega)\mathbf{F}(-j\omega) = \mathbf{F}(j\omega)\mathbf{F}^*(j\omega) = A^2(\omega) + B^2(\omega) = |\mathbf{F}(j\omega)|^2$$

## Physical Significance of the Fourier Transform

With these basic mathematical properties of the Fourier transform in mind, we are now ready to consider its physical significance. Let us suppose that  $f(t)$  is either the voltage across or the current through a  $1\ \Omega$  resistor, so that  $f^2(t)$  is the instantaneous power delivered to the  $1\ \Omega$  resistor by  $f(t)$ . Integrating this power over all time, we obtain the total energy delivered by  $f(t)$  to the  $1\ \Omega$  resistor,

$$W_{1\Omega} = \int_{-\infty}^{\infty} f^2(t) dt \quad [53]$$

Now let us resort to a little trickery. Thinking of the integrand in Eq. [53] as  $f(t)$  times itself, we replace one of those functions with Eq. [46b]:

$$W_{1\Omega} = \int_{-\infty}^{\infty} f(t) \left[ \frac{1}{2\pi} \int_{-\infty}^{\infty} e^{j\omega t} \mathbf{F}(j\omega) d\omega \right] dt$$

Since  $f(t)$  is not a function of the variable of integration  $\omega$ , we may move it inside the bracketed integral and then interchange the order of integration:

$$W_{1\Omega} = \frac{1}{2\pi} \int_{-\infty}^{\infty} \left[ \int_{-\infty}^{\infty} \mathbf{F}(j\omega) e^{j\omega t} f(t) dt \right] d\omega$$

Next we shift  $\mathbf{F}(j\omega)$  outside the inner integral, causing that integral to become  $\mathbf{F}(-j\omega)$ :

$$W_{1\Omega} = \frac{1}{2\pi} \int_{-\infty}^{\infty} \mathbf{F}(j\omega)\mathbf{F}(-j\omega) d\omega = \frac{1}{2\pi} \int_{-\infty}^{\infty} |\mathbf{F}(j\omega)|^2 d\omega$$

Collecting these results,

$$\int_{-\infty}^{\infty} f^2(t) dt = \frac{1}{2\pi} \int_{-\infty}^{\infty} |\mathbf{F}(j\omega)|^2 d\omega \quad [54]$$

Equation [54] is a very useful expression known as Parseval's theorem. This theorem, along with Eq. [53], tells us that the energy associated with  $f(t)$  can be obtained either from an integration over all time in the time domain or by  $1/(2\pi)$  times an integration over all (radian) frequency in the frequency domain.

Parseval's theorem also leads us to a greater understanding and interpretation of the meaning of the Fourier transform. Consider a voltage  $v(t)$  with Fourier transform  $\mathbf{F}_v(j\omega)$  and  $1\ \Omega$  energy  $W_{1\Omega}$ :

$$W_{1\Omega} = \frac{1}{2\pi} \int_{-\infty}^{\infty} |\mathbf{F}_v(j\omega)|^2 d\omega = \frac{1}{\pi} \int_0^{\infty} |\mathbf{F}_v(j\omega)|^2 d\omega$$

Marc Antoine Parseval-Deschenes was a rather obscure French mathematician, geographer, and occasional poet who published these results in 1805, seventeen years before Fourier published his theorem.

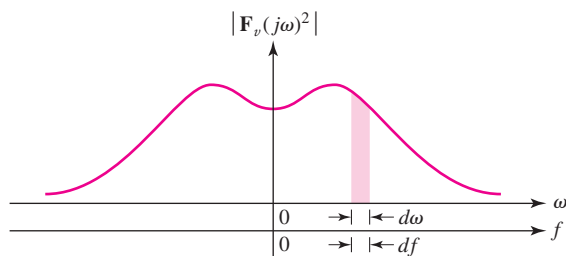

■ FIGURE 18.14 The area of the slice  $|\mathbf{F}_v(j\omega)|^2$  is the  $1 \Omega$  energy associated with  $v(t)$  lying in the bandwidth  $df$ .

where the rightmost equality follows from the fact that  $|\mathbf{F}_v(j\omega)|^2$  is an even function of  $\omega$ . Then, since  $\omega = 2\pi f$ , we can write

$$W_{1\Omega} = \int_{-\infty}^{\infty} |\mathbf{F}_v(j\omega)|^2 df = 2 \int_0^{\infty} |\mathbf{F}_v(j\omega)|^2 df \quad [55]$$

Figure 18.14 illustrates a typical plot of  $|\mathbf{F}_v(j\omega)|^2$  as a function of both  $\omega$  and  $f$ . If we divide the frequency scale up into vanishingly small increments  $df$ , Eq. [55] shows us that the area of a differential slice under the  $|\mathbf{F}_v(j\omega)|^2$  curve, having a width  $df$ , is  $|\mathbf{F}_v(j\omega)|^2 df$ . This area is shown shaded. The sum of all such areas, as  $f$  ranges from minus to plus infinity, is the total  $1 \Omega$  energy contained in  $v(t)$ . Thus,  $|\mathbf{F}_v(j\omega)|^2$  is the  $(1 \Omega)$  **energy density** or energy per unit bandwidth (J/Hz) of  $v(t)$ , and this energy density is always a real, even, non-negative function of  $\omega$ . By integrating  $|\mathbf{F}_v(j\omega)|^2$  over an appropriate frequency interval, we are able to calculate that portion of the total energy lying within the chosen interval. Note that the energy density is not a function of the phase of  $\mathbf{F}_v(j\omega)$ , and thus there are an infinite number of time functions and Fourier transforms that possess identical energy-density functions.



## EXAMPLE 18.6

**The one-sided [i.e.,  $v(t) = 0$  for  $t < 0$ ] exponential pulse**

$$v(t) = 4e^{-3t}u(t) \quad \text{V}$$

**is applied to the input of an ideal bandpass filter. If the filter pass-band is defined by  $1 < |f| < 2$  Hz, calculate the total output energy.**

We call the filter output voltage  $v_o(t)$ . The energy in  $v_o(t)$  will therefore be equal to the energy of that part of  $v(t)$  having frequency components in the intervals  $1 < f < 2$  and  $-2 < f < -1$ . We determine the Fourier transform of  $v(t)$ ,

$$\begin{aligned} \mathbf{F}_v(j\omega) &= 4 \int_{-\infty}^{\infty} e^{-j\omega t} e^{-3t} u(t) dt \\ &= 4 \int_0^{\infty} e^{-(3+j\omega)t} dt = \frac{4}{3+j\omega} \end{aligned}$$

(Continued on next page)

and then we may calculate the total  $1\ \Omega$  energy in the input signal by either

$$\begin{aligned} W_{1\Omega} &= \frac{1}{2\pi} \int_{-\infty}^{\infty} |\mathbf{F}_v(j\omega)|^2 d\omega \\ &= \frac{8}{\pi} \int_{-\infty}^{\infty} \frac{d\omega}{9 + \omega^2} = \frac{16}{\pi} \int_0^{\infty} \frac{d\omega}{9 + \omega^2} = \frac{8}{3} \text{ J} \end{aligned}$$

or

$$W_{1\Omega} = \int_{-\infty}^{\infty} v^2(t) dt = 16 \int_0^{\infty} e^{-6t} dt = \frac{8}{3} \text{ J}$$

The total energy in  $v_o(t)$ , however, is smaller:

$$\begin{aligned} W_{o1} &= \frac{1}{2\pi} \int_{-4\pi}^{-2\pi} \frac{16 d\omega}{9 + \omega^2} + \frac{1}{2\pi} \int_{2\pi}^{4\pi} \frac{16 d\omega}{9 + \omega^2} \\ &= \frac{16}{\pi} \int_{2\pi}^{4\pi} \frac{d\omega}{9 + \omega^2} = \frac{16}{3\pi} \left( \tan^{-1} \frac{4\pi}{3} - \tan^{-1} \frac{2\pi}{3} \right) = 358 \text{ mJ} \end{aligned}$$

In general, we see that an ideal bandpass filter enables us to remove energy from prescribed frequency ranges while still retaining the energy contained in other frequency ranges. The Fourier transform helps us to describe the filtering action quantitatively without actually evaluating  $v_o(t)$ , although we will see later that the Fourier transform can also be used to obtain the expression for  $v_o(t)$  if we wish to do so.

### PRACTICE

18.10 If  $i(t) = 10e^{20t}[u(t + 0.1) - u(t - 0.1)]$  A, find (a)  $\mathbf{F}_i(j0)$ ; (b)  $\mathbf{F}_i(j10)$ ; (c)  $A_i(10)$ ; (d)  $B_i(10)$ ; (e)  $\phi_i(10)$ .

18.11 Find the  $1\ \Omega$  energy associated with the current  $i(t) = 20e^{-10t}u(t)$  A in the interval (a)  $-0.1 < t < 0.1$  s; (b)  $-10 < \omega < 10$  rad/s; (c)  $10 < \omega < \infty$  rad/s.

Ans: 18.10: 3.63 A/(rad/s);  $3.33/-31.7^\circ$  A/(rad/s); 2.83 A/(rad/s);  $-1.749$  A/(rad/s);  $-31.7^\circ$ . 18.11: 17.29 J; 10 J; 5 J.

## 18.7 FOURIER TRANSFORM PAIRS FOR SOME SIMPLE TIME FUNCTIONS

### The Unit-Impulse Function

We now seek the Fourier transform of the unit impulse  $\delta(t - t_0)$ , a function we introduced in Sec. 14.4. That is, we are interested in the spectral properties or frequency-domain description of this singularity function. If we use the notation  $\mathcal{F}\{\}$  to symbolize “Fourier transform of  $\{\}$ ,” then

$$\mathcal{F}\{\delta(t - t_0)\} = \int_{-\infty}^{\infty} e^{-j\omega t} \delta(t - t_0) dt$$

From our earlier discussion of this type of integral, we have

$$\mathcal{F}\{\delta(t - t_0)\} = e^{-j\omega t_0} = \cos \omega t_0 - j \sin \omega t_0$$

This complex function of  $\omega$  leads to the  $1 \Omega$  energy-density function,

$$|\mathcal{F}\{\delta(t - t_0)\}|^2 = \cos^2 \omega t_0 + \sin^2 \omega t_0 = 1$$

This remarkable result says that the  $(1 \Omega)$  energy per unit bandwidth is unity *at all frequencies*, and that the total energy in the unit impulse is infinitely large. No wonder, then, that we must conclude that the unit impulse is “impractical” in the sense that it cannot be generated in the laboratory. Moreover, even if one were available to us, it must appear distorted after being subjected to the finite bandwidth of any practical laboratory instrument.

Since there is a unique one-to-one correspondence between a time function and its Fourier transform, we can say that the inverse Fourier transform of  $e^{-j\omega t_0}$  is  $\delta(t - t_0)$ . Utilizing the symbol  $\mathcal{F}^{-1}\{\}$  for the inverse transform, we have

$$\mathcal{F}^{-1}\{e^{-j\omega t_0}\} = \delta(t - t_0)$$

Thus, we now know that

$$\frac{1}{2\pi} \int_{-\infty}^{\infty} e^{j\omega t} e^{-j\omega t_0} d\omega = \delta(t - t_0)$$

even though we would fail in an attempt at the direct evaluation of this improper integral. Symbolically, we may write

$$\delta(t - t_0) \Leftrightarrow e^{-j\omega t_0} \quad [56]$$

where  $\Leftrightarrow$  indicates that the two functions constitute a Fourier transform pair.

Continuing with our consideration of the unit-impulse function, let us consider a Fourier transform in that form,

$$\mathbf{F}(j\omega) = \delta(\omega - \omega_0)$$

which is a unit impulse *in the frequency domain* located at  $\omega = \omega_0$ . Then  $f(t)$  must be

$$f(t) = \mathcal{F}^{-1}\{\mathbf{F}(j\omega)\} = \frac{1}{2\pi} \int_{-\infty}^{\infty} e^{j\omega t} \delta(\omega - \omega_0) d\omega = \frac{1}{2\pi} e^{j\omega_0 t}$$

where we have used the sifting property of the unit impulse. Thus we may now write

$$\frac{1}{2\pi} e^{j\omega_0 t} \Leftrightarrow \delta(\omega - \omega_0)$$

or

$$e^{j\omega_0 t} \Leftrightarrow 2\pi\delta(\omega - \omega_0) \quad [57]$$

Also, by a simple sign change we obtain

$$e^{-j\omega_0 t} \Leftrightarrow 2\pi\delta(\omega + \omega_0) \quad [58]$$

Clearly, the time function is complex in both expressions [57] and [58], and does not exist in the real world of the laboratory.

However, we know that

$$\cos \omega_0 t = \frac{1}{2} e^{j\omega_0 t} + \frac{1}{2} e^{-j\omega_0 t}$$

and it is easily seen from the definition of the Fourier transform that

$$\mathcal{F}\{f_1(t)\} + \mathcal{F}\{f_2(t)\} = \mathcal{F}\{f_1(t) + f_2(t)\} \quad [59]$$

Therefore,

$$\begin{aligned} \mathcal{F}\{\cos \omega_0 t\} &= \mathcal{F}\left\{\frac{1}{2}e^{j\omega_0 t}\right\} + \mathcal{F}\left\{\frac{1}{2}e^{-j\omega_0 t}\right\} \\ &= \pi\delta(\omega - \omega_0) + \pi\delta(\omega + \omega_0) \end{aligned}$$

which indicates that the frequency-domain description of  $\cos \omega_0 t$  shows a *pair* of impulses, located at  $\omega = \pm\omega_0$ . This should not be a great surprise, for in our first discussion of complex frequency in Chap. 14, we noted that a sinusoidal function of time was always represented by a pair of imaginary frequencies located at  $s = \pm j\omega_0$ . We have, therefore,

$$\cos \omega_0 t \Leftrightarrow \pi[\delta(\omega + \omega_0) + \delta(\omega - \omega_0)] \quad [60]$$

### The Constant Forcing Function

To find the Fourier transform of a constant function of time,  $f(t) = K$ , our first inclination might be to substitute this constant in the defining equation for the Fourier transform and evaluate the resulting integral. If we did, we would find ourselves with an indeterminate expression on our hands. Fortunately, however, we have already solved this problem, for from expression [58],

$$e^{-j\omega_0 t} \Leftrightarrow 2\pi\delta(\omega + \omega_0)$$

We see that if we simply let  $\omega_0 = 0$ , then the resulting transform pair is

$$1 \Leftrightarrow 2\pi\delta(\omega) \quad [61]$$

from which it follows that

$$K \Leftrightarrow 2\pi K\delta(\omega) \quad [62]$$

and our problem is solved. The frequency spectrum of a constant function of time consists only of a component at  $\omega = 0$ , which we knew all along.

### The Signum Function

As another example, let us obtain the Fourier transform of a singularity function known as the *signum function*,  $\text{sgn}(t)$ , defined by

$$\text{sgn}(t) = \begin{cases} -1 & t < 0 \\ 1 & t > 0 \end{cases} \quad [63]$$

or

$$\text{sgn}(t) = u(t) - u(-t)$$

Again, if we should try to substitute this time function in the defining equation for the Fourier transform, we would face an indeterminate expression upon substitution of the limits of integration. This same problem will arise every time we attempt to obtain the Fourier transform of a time function that does not approach zero as  $|t|$  approaches infinity. Fortunately, we can avoid this situation by using the *Laplace transform*, as it contains a built-in convergence factor that cures many of the inconvenient ills associated with the evaluation of certain Fourier transforms.





Along those lines, the signum function under consideration can be written as

$$\operatorname{sgn}(t) = \lim_{a \rightarrow 0} [e^{-at}u(t) - e^{at}u(-t)]$$

Notice that the expression within the brackets *does* approach zero as  $|t|$  gets very large. Using the definition of the Fourier transform, we obtain

$$\begin{aligned} \mathcal{F}\{\operatorname{sgn}(t)\} &= \lim_{a \rightarrow 0} \left[ \int_0^{\infty} e^{-j\omega t} e^{-at} dt - \int_{-\infty}^0 e^{-j\omega t} e^{at} dt \right] \\ &= \lim_{a \rightarrow 0} \frac{-j2\omega}{\omega^2 + a^2} = \frac{2}{j\omega} \end{aligned}$$

The real component is zero, since  $\operatorname{sgn}(t)$  is an odd function of  $t$ . Thus,

$$\operatorname{sgn}(t) \Leftrightarrow \frac{2}{j\omega} \quad [64]$$

## The Unit-Step Function

As a final example in this section, let us look at the familiar unit-step function,  $u(t)$ . Making use of our work on the signum function in the preceding paragraphs, we represent the unit step by

$$u(t) = \frac{1}{2} + \frac{1}{2}\operatorname{sgn}(t)$$

and obtain the Fourier transform pair

$$u(t) \Leftrightarrow \left[ \pi\delta(\omega) + \frac{1}{j\omega} \right] \quad [65]$$

Table 18.2 presents the conclusions drawn from the examples discussed in this section, along with a few others that have not been detailed here.

## EXAMPLE 18.7

Use Table 18.2 to find the Fourier transform of the time function  $3e^{-t} \cos 4t u(t)$ .

From the next to the last entry in the table, we have

$$e^{-\alpha t} \cos \omega_d t u(t) \Leftrightarrow \frac{\alpha + j\omega}{(\alpha + j\omega)^2 + \omega_d^2}$$

We therefore identify  $\alpha$  as 1 and  $\omega_d$  as 4, and have

$$\mathbf{F}(j\omega) = 3 \frac{1 + j\omega}{(1 + j\omega)^2 + 16}$$









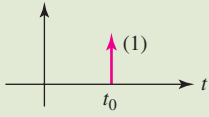
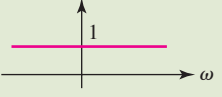

## PRACTICE

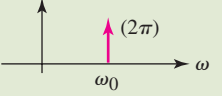
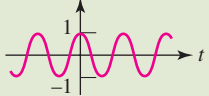
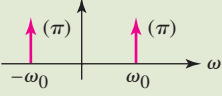
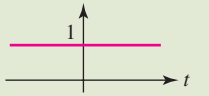
18.12 Evaluate the Fourier transform at  $\omega = 12$  for the time function (a)  $4u(t) - 10\delta(t)$ ; (b)  $5e^{-8t}u(t)$ ; (c)  $4 \cos 8tu(t)$ ; (d)  $-4 \operatorname{sgn}(t)$ .

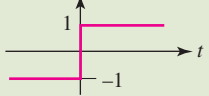
18.13 Find  $f(t)$  at  $t = 2$  if  $\mathbf{F}(j\omega)$  is equal to (a)  $5e^{-j3\omega} - j(4/\omega)$ ; (b)  $8[\delta(\omega - 3) + \delta(\omega + 3)]$ ; (c)  $(8/\omega) \sin 5\omega$ .

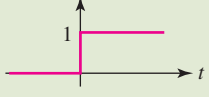
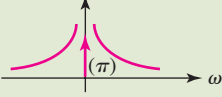
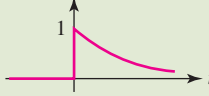
Ans: 18.12:  $10.01/\underline{-178.1^\circ}$ ;  $0.347/\underline{-56.3^\circ}$ ;  $-j0.6$ ;  $j0.667$ . 18.13: 2.00; 2.45; 4.00.

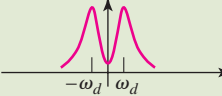
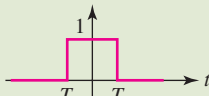
TABLE 18.2 A Summary of Some Fourier Transform Pairs

$f(t)$	$f(t)$	$\mathcal{F}\{f(t)\} = F(j\omega)$	$ F(j\omega) $
	$\delta(t - t_0)$	$e^{-j\omega t_0}$	
	$e^{j\omega_0 t}$	$2\pi\delta(\omega - \omega_0)$	
	$\cos \omega_0 t$	$\pi[\delta(\omega + \omega_0) + \delta(\omega - \omega_0)]$	
	1	$2\pi\delta(\omega)$	
	$\text{sgn}(t)$	$\frac{2}{j\omega}$	
	$u(t)$	$\pi\delta(\omega) + \frac{1}{j\omega}$	
	$e^{-\alpha t} u(t)$	$\frac{1}{\alpha + j\omega}$	
	$[e^{-\alpha t} \cos \omega_d t] u(t)$	$\frac{\alpha + j\omega}{(\alpha + j\omega)^2 + \omega_d^2}$	
	$u(t + \frac{1}{2}T) - u(t - \frac{1}{2}T)$	$T \frac{\sin \frac{\omega T}{2}}{\frac{\omega T}{2}}$	

## 18.8 THE FOURIER TRANSFORM OF A GENERAL PERIODIC TIME FUNCTION

In Sec. 18.5 we remarked that we would be able to show that periodic time functions, as well as nonperiodic functions, possess Fourier transforms. Let us now establish this fact on a rigorous basis. Consider a periodic time function  $f(t)$  with period  $T$  and Fourier series expansion, as outlined by Eqs. [39], [40], and [41], repeated here for convenience:

$$f(t) = \sum_{n=-\infty}^{\infty} \mathbf{c}_n e^{jn\omega_0 t} \quad [39]$$

$$\mathbf{c}_n = \frac{1}{T} \int_{-T/2}^{T/2} f(t) e^{-jn\omega_0 t} dt \quad [40]$$

and

$$\omega_0 = \frac{2\pi}{T} \quad [41]$$

Bearing in mind that the Fourier transform of a sum is just the sum of the transforms of the terms in the sum, and that  $\mathbf{c}_n$  is not a function of time, we can write

$$\mathcal{F}\{f(t)\} = \mathcal{F}\left\{\sum_{n=-\infty}^{\infty} \mathbf{c}_n e^{jn\omega_0 t}\right\} = \sum_{n=-\infty}^{\infty} \mathbf{c}_n \mathcal{F}\{e^{jn\omega_0 t}\}$$

After obtaining the transform of  $e^{jn\omega_0 t}$  from expression [57], we have

$$f(t) \Leftrightarrow 2\pi \sum_{n=-\infty}^{\infty} \mathbf{c}_n \delta(\omega - n\omega_0) \quad [66]$$

This shows that  $f(t)$  has a discrete spectrum consisting of impulses located at points on the  $\omega$  axis given by  $\omega = n\omega_0$ ,  $n = \dots, -2, -1, 0, 1, \dots$ . The strength of each impulse is  $2\pi$  times the value of the corresponding Fourier coefficient appearing in the complex form of the Fourier series expansion for  $f(t)$ .

As a check on our work, let us see whether the inverse Fourier transform of the right side of expression [66] is once again  $f(t)$ . This inverse transform can be written as

$$\mathcal{F}^{-1}\{\mathbf{F}(j\omega)\} = \frac{1}{2\pi} \int_{-\infty}^{\infty} e^{j\omega t} \left[ 2\pi \sum_{n=-\infty}^{\infty} \mathbf{c}_n \delta(\omega - n\omega_0) \right] d\omega \stackrel{?}{=} f(t)$$

Since the exponential term does not contain the index of summation  $n$ , we can interchange the order of the integration and summation operations:

$$\mathcal{F}^{-1}\{\mathbf{F}(j\omega)\} = \sum_{n=-\infty}^{\infty} \int_{-\infty}^{\infty} \mathbf{c}_n e^{j\omega t} \delta(\omega - n\omega_0) d\omega \stackrel{?}{=} f(t)$$

Because it is not a function of the variable of integration,  $\mathbf{c}_n$  can be treated as a constant. Then, using the sifting property of the impulse, we obtain

$$\mathcal{F}^{-1}\{\mathbf{F}(j\omega)\} = \sum_{n=-\infty}^{\infty} \mathbf{c}_n e^{jn\omega_0 t} \stackrel{?}{=} f(t)$$

which is exactly the same as Eq. [39], the complex Fourier series expansion for  $f(t)$ . The question marks in the preceding equations can now be removed, and the existence of the Fourier transform for a periodic time function is established. This should come as no great surprise, however. In the last section we evaluated the Fourier transform of a cosine function, which is certainly periodic, although we made no direct reference to its periodicity. However, we did use a backhanded approach in getting the transform. But now we have a mathematical tool by which the transform can be obtained more directly. To demonstrate this procedure, consider  $f(t) = \cos \omega_0 t$  once more. First we evaluate the Fourier coefficients  $\mathbf{c}_n$ :

$$\mathbf{c}_n = \frac{1}{T} \int_{-T/2}^{T/2} \cos \omega_0 t e^{-jn\omega_0 t} dt = \begin{cases} \frac{1}{2} & n = \pm 1 \\ 0 & \text{otherwise} \end{cases}$$

Then

$$\mathcal{F}\{f(t)\} = 2\pi \sum_{n=-\infty}^{\infty} \mathbf{c}_n \delta(\omega - n\omega_0)$$

This expression has values that are nonzero only when  $n = \pm 1$ , and it follows, therefore, that the entire summation reduces to

$$\mathcal{F}\{\cos \omega_0 t\} = \pi[\delta(\omega - \omega_0) + \delta(\omega + \omega_0)]$$

which is precisely the expression that we obtained before. What a relief!

### PRACTICE

18.14 Find (a)  $\mathcal{F}\{5 \sin^2 3t\}$ ; (b)  $\mathcal{F}\{A \sin \omega_0 t\}$ ; (c)  $\mathcal{F}\{6 \cos(8t + 0.1\pi)\}$ .

Ans:  $2.5\pi[2\delta(\omega) - \delta(\omega + 6) - \delta(\omega - 6)]$ ;  $j\pi A[\delta(\omega + \omega_0) - \delta(\omega - \omega_0)]$ ;  
 $[18.85/\underline{18^\circ}] \delta(\omega - 8) + [18.85/\underline{-18^\circ}] \delta(\omega + 8)$ .

## 18.9 THE SYSTEM FUNCTION AND RESPONSE IN THE FREQUENCY DOMAIN

In Sec. 15.5, the problem of determining the output of a physical system in terms of the input and the impulse response was solved by using the convolution integral and initially working in the time domain. The input, the output, and the impulse response are all time functions. Subsequently, we found that it was often more convenient to perform such operations in the frequency domain, as the Laplace transform of the convolution of two functions is simply the product of each function in the frequency domain. Along the same lines, we find the same is true when working with Fourier transforms.

To do this we examine the Fourier transform of the system output. Assuming arbitrarily that the input and output are voltages, we apply the basic

definition of the Fourier transform and express the output by the convolution integral:

$$\mathcal{F}\{v_0(t)\} = \mathbf{F}_0(j\omega) = \int_{-\infty}^{\infty} e^{-j\omega t} \left[ \int_{-\infty}^{\infty} v_i(t-z)h(z) dz \right] dt$$

where we again assume no initial energy storage. At first glance this expression may seem rather formidable, but it can be reduced to a result that is surprisingly simple. We may move the exponential term inside the inner integral because it does not contain the variable of integration  $z$ . Next we reverse the order of integration, obtaining

$$\mathbf{F}_0(j\omega) = \int_{-\infty}^{\infty} \left[ \int_{-\infty}^{\infty} e^{-j\omega t} v_i(t-z)h(z) dt \right] dz$$

Since it is not a function of  $t$ , we can extract  $h(z)$  from the inner integral and simplify the integration with respect to  $t$  by a change of variable,  $t - z = x$ :

$$\begin{aligned} \mathbf{F}_0(j\omega) &= \int_{-\infty}^{\infty} h(z) \left[ \int_{-\infty}^{\infty} e^{-j\omega(x+z)} v_i(x) dx \right] dz \\ &= \int_{-\infty}^{\infty} e^{-j\omega z} h(z) \left[ \int_{-\infty}^{\infty} e^{-j\omega x} v_i(x) dx \right] dz \end{aligned}$$

But now the sun is starting to break through, for the inner integral is merely the Fourier transform of  $v_i(t)$ . Furthermore, it contains no  $z$  terms and can be treated as a constant in any integration involving  $z$ . Thus, we can move this transform,  $\mathbf{F}_i(j\omega)$ , completely outside all the integral signs:

$$\mathbf{F}_0(j\omega) = \mathbf{F}_i(j\omega) \int_{-\infty}^{\infty} e^{-j\omega z} h(z) dz$$

Finally, the remaining integral exhibits our old friend once more, another Fourier transform! This one is the Fourier transform of the impulse response, which we will designate by the notation  $\mathbf{H}(j\omega)$ . Therefore, all our work has boiled down to the simple result:

$$\mathbf{F}_0(j\omega) = \mathbf{F}_i(j\omega)\mathbf{H}(j\omega) = \mathbf{F}_i(j\omega)\mathcal{F}\{h(t)\}$$

This is another important result: it defines the *system function*  $\mathbf{H}(j\omega)$  as the ratio of the Fourier transform of the response function to the Fourier transform of the forcing function. Moreover, the system function and the impulse response constitute a Fourier transform pair:

$$h(t) \Leftrightarrow \mathbf{H}(j\omega) \quad [67]$$

The development in the preceding paragraph also serves to prove the general statement that the Fourier transform of the convolution of two time functions is the product of their Fourier transforms,

$$\mathcal{F}\{f(t) * g(t)\} = \mathbf{F}_f(j\omega)\mathbf{F}_g(j\omega) \quad [68]$$

To recapitulate, if we know the Fourier transforms of the forcing function and the impulse response, then the Fourier transform of the response function can be obtained as their product. The result is a description of the response function in the frequency domain; the time-domain description of the response function is obtained by simply taking the inverse Fourier transform. Thus we see that the process of convolution in the time domain is equivalent to the relatively simple operation of multiplication in the frequency domain.

The foregoing comments might make us wonder once again why we would ever choose to work in the time domain at all, but we must always remember that we seldom get something for nothing. A poet once said, “*Our sincerest laughter/with some pain is fraught.*”<sup>2</sup> The pain herein is the occasional difficulty in obtaining the inverse Fourier transform of a response function, for reasons of mathematical complexity. On the other hand, a simple desktop computer can convolve two time functions with magnificent celerity. For that matter, it can also obtain an FFT (fast Fourier transform) quite rapidly. Consequently there is no clear-cut advantage between working in the time domain and in the frequency domain. A decision must be made each time a new problem arises; it should be based on the information available and on the computational facilities at hand.

Consider a forcing function of the form

$$v_i(t) = u(t) - u(t - 1)$$

and a unit-impulse response defined by

$$h(t) = 2e^{-t}u(t)$$

We first obtain the corresponding Fourier transforms. The forcing function is the difference between two unit-step functions. These two functions are identical, except that one is initiated 1 s after the other. We will evaluate the response due to  $u(t)$ ; the response due to  $u(t - 1)$  is the same, but delayed in time by 1 s. The difference between these two partial responses will be the total response due to  $v_i(t)$ .

The Fourier transform of  $u(t)$  was obtained in Sec. 18.7:

$$\mathcal{F}\{u(t)\} = \pi\delta(\omega) + \frac{1}{j\omega}$$

The system function is obtained by taking the Fourier transform of  $h(t)$ , listed in Table 18.2,

$$\mathcal{F}\{h(t)\} = \mathbf{H}(j\omega) = \mathcal{F}\{2e^{-t}u(t)\} = \frac{2}{1 + j\omega}$$

The inverse transform of the product of these two functions yields that component of  $v_o(t)$  caused by  $u(t)$ ,

$$v_{o1}(t) = \mathcal{F}^{-1} \left\{ \frac{2\pi\delta(\omega)}{1 + j\omega} + \frac{2}{j\omega(1 + j\omega)} \right\}$$

Using the sifting property of the unit impulse, the inverse transform of the first term is just a constant equal to unity. Thus,

$$v_{o1}(t) = 1 + \mathcal{F}^{-1} \left\{ \frac{2}{j\omega(1 + j\omega)} \right\}$$

The second term contains a product of terms in the denominator, each of the form  $(\alpha + j\omega)$ , and its inverse transform is found most easily by making use of the partial-fraction expansion that we developed in Sec. 14.5. Let us

(2) P. B. Shelley, “To a Skylark,” 1821.

select a technique for obtaining a partial-fraction expansion that has one big advantage—it always works, although faster methods are usually available for most situations. We assign an unknown quantity in the numerator of each fraction, here two in number,

$$\frac{2}{j\omega(1+j\omega)} = \frac{A}{j\omega} + \frac{B}{1+j\omega}$$

and then substitute a corresponding number of simple values for  $j\omega$ . Here we let  $j\omega = 1$ :

$$1 = A + \frac{B}{2}$$

and then let  $j\omega = -2$ :

$$1 = -\frac{A}{2} - B$$

This leads to  $A = 2$  and  $B = -2$ . Thus,

$$\mathcal{F}^{-1} \left\{ \frac{2}{j\omega(1+j\omega)} \right\} = \mathcal{F}^{-1} \left\{ \frac{2}{j\omega} - \frac{2}{1+j\omega} \right\} = \text{sgn}(t) - 2e^{-t}u(t)$$

so that

$$\begin{aligned} v_{o1}(t) &= 1 + \text{sgn}(t) - 2e^{-t}u(t) \\ &= 2u(t) - 2e^{-t}u(t) \\ &= 2(1 - e^{-t})u(t) \end{aligned}$$

It follows that  $v_{o2}(t)$ , the component of  $v_o(t)$  produced by  $u(t-1)$ , is

$$v_{o2}(t) = 2(1 - e^{-(t-1)})u(t-1)$$

Therefore,

$$\begin{aligned} v_o(t) &= v_{o1}(t) - v_{o2}(t) \\ &= 2(1 - e^{-t})u(t) - 2(1 - e^{-t+1})u(t-1) \end{aligned}$$

The discontinuities at  $t = 0$  and  $t = 1$  dictate a separation into three time intervals:

$$v_o(t) = \begin{cases} 0 & t < 0 \\ 2(1 - e^{-t}) & 0 < t < 1 \\ 2(e-1)e^{-t} & t > 1 \end{cases}$$

### PRACTICE

18.15 The impulse response of a certain linear network is  $h(t) = 6e^{-20t}u(t)$ . The input signal is  $3e^{-6t}u(t)$  V. Find (a)  $\mathbf{H}(j\omega)$ ; (b)  $\mathbf{V}_i(j\omega)$ ; (c)  $\mathbf{V}_o(j\omega)$ ; (d)  $v_o(0.1)$ ; (e)  $v_o(0.3)$ ; (f)  $v_{o,\max}$ .

Ans:  $6/(20 + j\omega)$ ;  $3/(6 + j\omega)$ ;  $18/[(20 + j\omega)(6 + j\omega)]$ ; 0.532 V; 0.209 V; 0.5372.

## COMPUTER-AIDED ANALYSIS

The material presented in this chapter forms the foundation for many advanced fields of study, including signal processing, communications, and controls. We are only able to introduce some of the more fundamental concepts within the context of an introductory circuits text, but even at this point some of the power of Fourier-based analysis can be brought to bear. As a first example, consider the op amp circuit of Fig. 18.15, constructed in PSpice using a  $\mu A741$  operational amplifier.

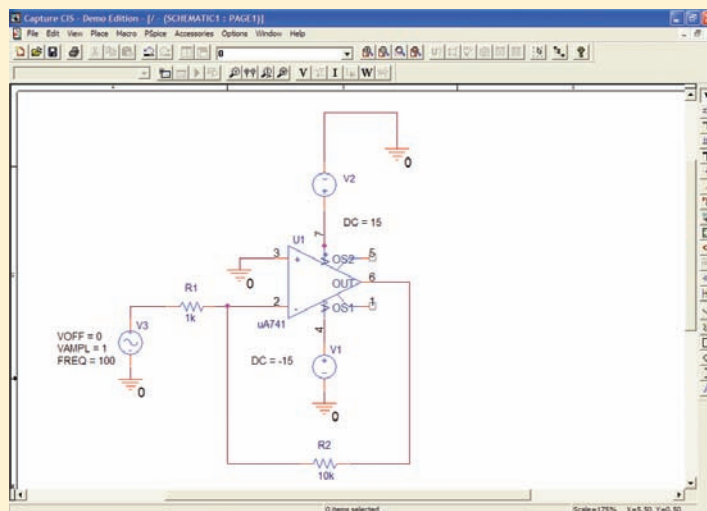

■ FIGURE 18.15 An inverting amplifier circuit with a voltage gain of  $-10$ , driven by a sinusoidal input operating at 100 Hz.

The circuit has a voltage gain of  $-10$ , and so we would expect a sinusoidal output of 10 V amplitude. This is indeed what we obtain from a transient analysis of the circuit, as shown in Fig. 18.16.

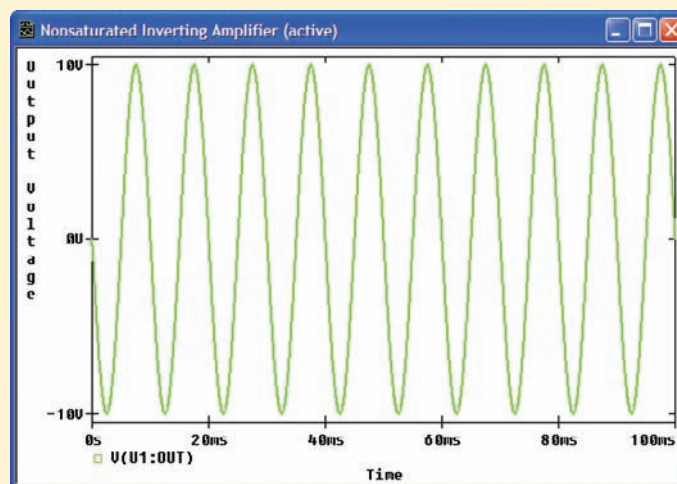

■ FIGURE 18.16 Simulated output voltage of the amplifier circuit shown in Fig. 18.15.



PSpice allows us to determine the frequency spectrum of the output voltage through what is known as a fast Fourier transform (FFT), a discrete-time approximation to the exact Fourier transform of the signal. From within Probe, we select **Fourier** under the **Trace** menu; the result is the plot shown in Fig. 18.17. As expected, the line spectrum for the output voltage of this amplifier circuit consists of a single feature at a frequency of 100 Hz.

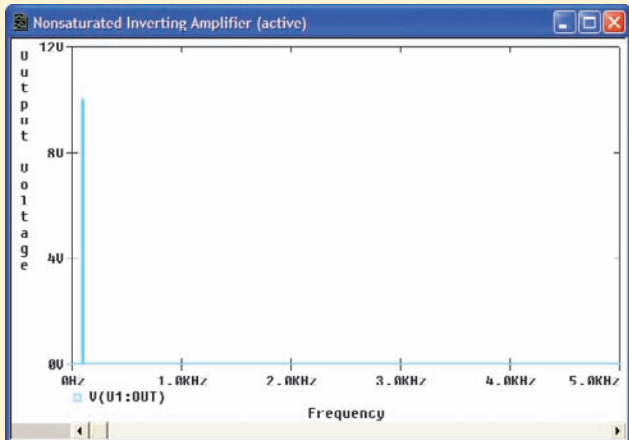

■ FIGURE 18.17 Discrete approximation to the Fourier transform of Fig. 18.16.

As the input voltage magnitude is increased, the output of the amplifier approaches the saturation condition determined by the positive and negative dc supply voltages ( $\pm 15$  V in this example). This behavior is evident in the simulation result of Fig. 18.18, which corresponds to an input voltage magnitude of 1.8 V. A key feature of interest is that the output voltage waveform is no longer a pure sinusoid. As a result, we expect nonzero values at harmonic frequencies to appear in the

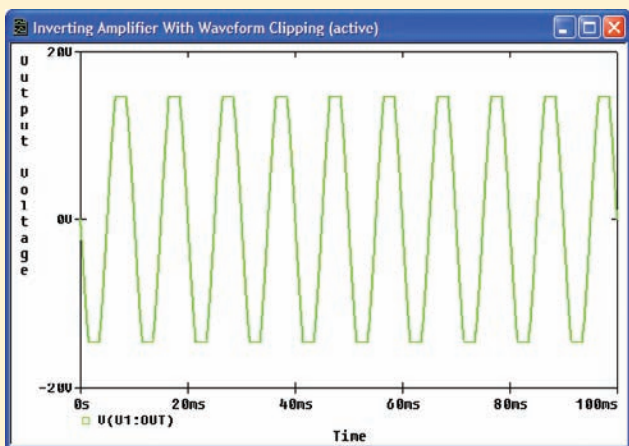

■ FIGURE 18.18 Transient analysis simulation results for the amplifier circuit when the input voltage magnitude is increased to 1.8 V. Saturation effects manifest themselves in the plot as clipped waveform extrema.

(Continued on next page)

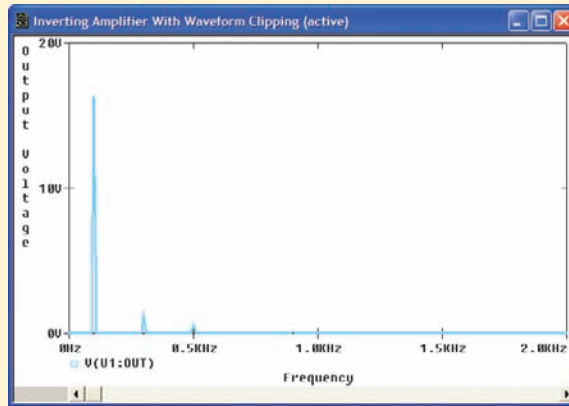

■ FIGURE 18.19 Frequency spectrum of the waveform depicted in Fig. 18.18, showing the presence of several harmonic components in addition to the fundamental frequency. The finite width of the features is an artifact of the numerical discretization (a set of discrete time values was used).

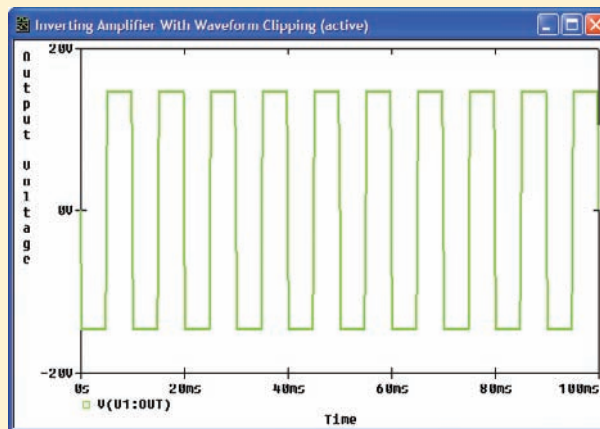

(a)

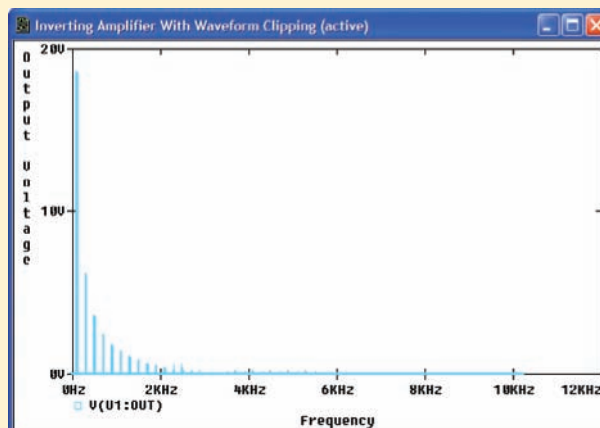

(b)

■ FIGURE 18.20 (a) Severe effects of amplifier saturation are observed in the simulated response to a 15 V sinusoidal input. (b) An FFT of the waveform shows a significant increase in the fraction of energy present in harmonics as opposed to the fundamental frequency of 100 Hz.

frequency spectrum of the function, as is the case in Fig. 18.19. The effect of reaching saturation in the amplifier circuit is a distortion of the signal; if connected to a speaker, we do not hear a “clean” 100 Hz waveform. Instead, we now hear a superposition of waveforms which include not only the 100 Hz fundamental frequency, but significant harmonic components at 300 and 500 Hz as well. Further distortion of the waveform would increase the amount of energy in harmonic frequencies, so that contributions from higher-frequency harmonics would become more significant. This is evident in the simulation results of Fig. 18.20*a* and *b*, which show the output voltage in the time and frequency domains, respectively.

## 18.10 THE PHYSICAL SIGNIFICANCE OF THE SYSTEM FUNCTION

In this section we will try to connect several aspects of the Fourier transform with work we completed in earlier chapters.

Given a general linear two-port network  $N$  without any initial energy storage, we assume sinusoidal forcing and response functions, arbitrarily taken to be voltages, as shown in Fig. 18.21. We let the input voltage be simply  $A \cos(\omega_x t + \theta)$ , and the output can be described in general terms as  $v_o(t) = B \cos(\omega_x t + \phi)$ , where the amplitude  $B$  and phase angle  $\phi$  are functions of  $\omega_x$ . In phasor form, we can write the forcing and response functions as  $\mathbf{V}_i = A e^{j\theta}$  and  $\mathbf{V}_o = B e^{j\phi}$ . The ratio of the phasor response to the phasor forcing function is a complex number that is a function of  $\omega_x$ :

$$\frac{\mathbf{V}_o}{\mathbf{V}_i} = \mathbf{G}(\omega_x) = \frac{B}{A} e^{j(\phi - \theta)}$$

where  $B/A$  is the amplitude of  $\mathbf{G}$  and  $\phi - \theta$  is its phase angle. This transfer function  $\mathbf{G}(\omega_x)$  could be obtained in the laboratory by varying  $\omega_x$  over a large range of values and measuring the amplitude  $B/A$  and phase  $\phi - \theta$  for each value of  $\omega_x$ . If we then plotted each of these parameters as a function of frequency, the resultant pair of curves would completely describe the transfer function.

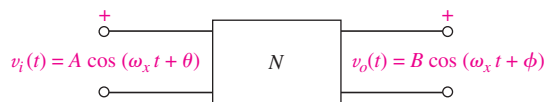

■ FIGURE 18.21 Sinusoidal analysis can be used to determine the transfer function  $\mathbf{H}(j\omega_x) = (B/A)e^{j(\phi - \theta)}$ , where  $B$  and  $\phi$  are functions of  $\omega_x$ .

Now let us hold these comments in the backs of our minds for a moment as we consider a slightly different aspect of the same analysis problem.

For the circuit with sinusoidal input and output shown in Fig. 18.21, what is the system function  $\mathbf{H}(j\omega)$ ? To answer this question, we begin with the definition of  $\mathbf{H}(j\omega)$  as the ratio of the Fourier transforms of the output and the input. Both of these time functions involve the functional form

$\cos(\omega_x t + \beta)$ , whose Fourier transform we have not evaluated as yet, although we can handle  $\cos \omega_x t$ . The transform we need is

$$\mathcal{F}\{\cos(\omega_x t + \beta)\} = \int_{-\infty}^{\infty} e^{-j\omega t} \cos(\omega_x t + \beta) dt$$

If we make the substitution  $\omega_x t + \beta = \omega_x \tau$ , then

$$\begin{aligned} \mathcal{F}\{\cos(\omega_x t + \beta)\} &= \int_{-\infty}^{\infty} e^{-j\omega\tau + j\omega\beta/\omega_x} \cos \omega_x \tau d\tau \\ &= e^{j\omega\beta/\omega_x} \mathcal{F}\{\cos \omega_x t\} \\ &= \pi e^{j\omega\beta/\omega_x} [\delta(\omega - \omega_x) + \delta(\omega + \omega_x)] \end{aligned}$$

This is a new Fourier transform pair,

$$\cos(\omega_x t + \beta) \Leftrightarrow \pi e^{j\omega\beta/\omega_x} [\delta(\omega - \omega_x) + \delta(\omega + \omega_x)] \quad [69]$$

which we can now use to evaluate the desired system function,

$$\begin{aligned} \mathbf{H}(j\omega) &= \frac{\mathcal{F}\{B \cos(\omega_x t + \phi)\}}{\mathcal{F}\{A \cos(\omega_x t + \theta)\}} \\ &= \frac{\pi B e^{j\omega\phi/\omega_x} [\delta(\omega - \omega_x) + \delta(\omega + \omega_x)]}{\pi A e^{j\omega\theta/\omega_x} [\delta(\omega - \omega_x) + \delta(\omega + \omega_x)]} \\ &= \frac{B}{A} e^{j\omega(\phi-\theta)/\omega_x} \end{aligned}$$

Now we recall the expression for  $\mathbf{G}(\omega_x)$ ,

$$\mathbf{G}(\omega_x) = \frac{B}{A} e^{j(\phi-\theta)}$$

where  $B$  and  $\phi$  were evaluated at  $\omega = \omega_x$ , and we see that evaluating  $\mathbf{H}(j\omega)$  at  $\omega = \omega_x$  gives

$$\mathbf{H}(\omega_x) = \mathbf{G}(\omega_x) = \frac{B}{A} e^{j(\phi-\theta)}$$

Since there is nothing special about the  $x$  subscript, we conclude that the system function and the transfer function are identical:

$$\mathbf{H}(j\omega) = \mathbf{G}(\omega) \quad [70]$$

The fact that one argument is  $\omega$  while the other is indicated by  $j\omega$  is immaterial and arbitrary; the  $j$  merely makes possible a more direct comparison between the Fourier and Laplace transforms.

Equation [70] represents a direct connection between Fourier transform techniques and sinusoidal steady-state analysis. Our previous work on steady-state sinusoidal analysis using phasors was but a special case of the more general techniques of Fourier transform analysis. It was “special” in the sense that the inputs and outputs were sinusoids, whereas the use of Fourier transforms and system functions enables us to handle nonsinusoidal forcing functions and responses.

Thus, to find the system function  $\mathbf{H}(j\omega)$  for a network, all we need to do is to determine the corresponding sinusoidal transfer function as a function of  $\omega$  (or  $j\omega$ ).

## EXAMPLE 18.8

Find the voltage across the inductor of the circuit shown in Fig. 18.22a when the input voltage is a simple exponentially decaying pulse, as indicated.

We need the system function; but it is not necessary to apply an impulse, find the impulse response, and then determine its inverse transform. Instead we use Eq. [70] to obtain the system function  $\mathbf{H}(j\omega)$  by assuming that the input and output voltages are both sinusoids described by their corresponding phasors, as shown in Fig. 18.22b. Using voltage division, we have

$$\mathbf{H}(j\omega) = \frac{\mathbf{V}_o}{\mathbf{V}_i} = \frac{j2\omega}{4 + j2\omega}$$

The transform of the forcing function is

$$\mathcal{F}\{v_i(t)\} = \frac{5}{3 + j\omega}$$

and thus the transform of  $v_o(t)$  is given as

$$\begin{aligned} \mathcal{F}\{v_o(t)\} &= \mathbf{H}(j\omega)\mathcal{F}\{v_i(t)\} \\ &= \frac{j2\omega}{4 + j2\omega} \frac{5}{3 + j\omega} \\ &= \frac{15}{3 + j\omega} - \frac{10}{2 + j\omega} \end{aligned}$$

where the partial fractions appearing in the last step help to determine the inverse Fourier transform

$$\begin{aligned} v_o(t) &= \mathcal{F}^{-1} \left\{ \frac{15}{3 + j\omega} - \frac{10}{2 + j\omega} \right\} \\ &= 15e^{-3t}u(t) - 10e^{-2t}u(t) \\ &= 5(3e^{-3t} - 2e^{-2t})u(t) \end{aligned}$$

Our problem is completed without fuss, convolution, or differential equations.

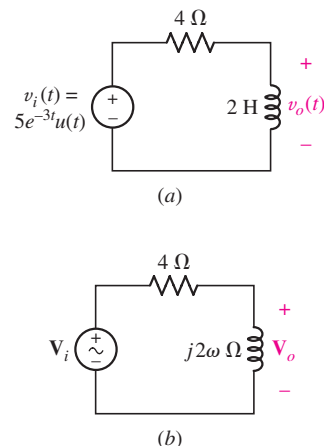

FIGURE 18.22 (a) The response  $v_o(t)$  caused by  $v_i(t)$  is desired. (b) The system function  $\mathbf{H}(j\omega)$  may be determined by sinusoidal steady-state analysis:  $\mathbf{H}(j\omega) = \mathbf{V}_o/\mathbf{V}_i$ .

## PRACTICE

18.16 Use Fourier transform techniques on the circuit of Fig. 18.23 to find  $i_1(t)$  at  $t = 1.5$  ms if  $i_s$  equals (a)  $\delta(t)$  A; (b)  $u(t)$  A; (c)  $\cos 500t$  A.

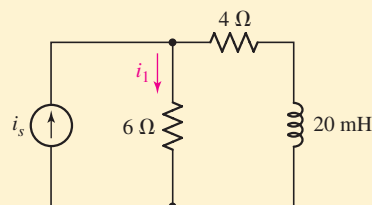

FIGURE 18.23

Ans:  $-141.7$  A;  $0.683$  A;  $0.308$  A.

# PRACTICAL APPLICATION

## Image Processing

Although a great deal of progress has been made toward developing a complete understanding of the function of muscle, there remain many open questions. A great deal of research in this field has been carried out using vertebrate skeletal muscle, in particular the *sartorius* or leg muscle of the frog (Fig. 18.24).



■ FIGURE 18.24 Close-up of a frog against an orange background.  
© IT Stock/PunchStock/RF.

Of the many analytical techniques scientists use, one of the most common is electron microscopy. Figure 18.25

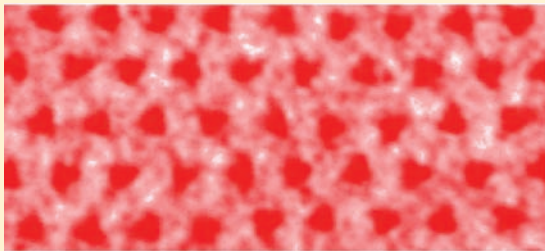

■ FIGURE 18.25 Electron micrograph of a region of frog sartorius muscle tissue. False color has been employed for clarity.  
Courtesy Professor John M. Squire, Imperial College, London.

shows an electron micrograph of frog sartorius muscle tissue, sectioned in such a fashion as to highlight the regular arrangement of *myosin*, a filamentary type of contractile protein. Of interest to structural biologists are the periodicity and disorder of these proteins over a large area of muscle tissue. In order to develop a model for these characteristics, a numerical approach is preferable, where the analysis of such images can be automated. As can be seen in the figure, however, the image produced by the electron microscope can be contaminated by a high level of background noise, making automated identification of the myosin filaments prone to error.

Introduced with the intent of ultimately assisting us in the analysis of time-varying linear circuits, the Fourier-based techniques of this chapter are in fact very powerful general methods which find application in many other situations. Among these, the field of *image processing* makes frequent use of Fourier techniques, especially through the fast Fourier transform and related numerical methods. The image of Fig. 18.25 can be described by a spatial function  $f(x, y)$  where  $f(x, y) = 0$  corresponds to white,  $f(x, y) = 1$  corresponds to red, and  $(x, y)$  denotes a pixel location in the image. Defining a filter function  $h(x, y)$  that has the appearance of Fig. 18.26a, the convolution operation

$$g(x, y) = f(x, y) * h(x, y)$$

results in the image of Fig. 18.26b in which the myosin filaments (viewed on end) are more clearly identifiable.

In practice, this image processing is performed in the frequency domain, where the FFT of both  $f$  and  $h$  are calculated, and the resulting matrices multiplied together.

## Epilogue

Returning again to Eq. [70], the identity between the system function  $\mathbf{H}(j\omega)$  and the sinusoidal steady-state transfer function  $\mathbf{G}(\omega)$ , we may now consider the system function as the ratio of the output phasor to the input phasor. Suppose that we hold the input-phasor amplitude at unity and the phase angle at zero. Then the output phasor is  $\mathbf{H}(j\omega)$ . Under these conditions, if we record the output amplitude and phase as functions of  $\omega$ , for all  $\omega$ , we have recorded the system function  $\mathbf{H}(j\omega)$  as a function of  $\omega$ , for all  $\omega$ . We thus have examined the system response under the condition that an infinite number of sinusoids, all with unity amplitude and zero phase, were successively applied at the input. Now suppose that our input is a single unit impulse, and look at the

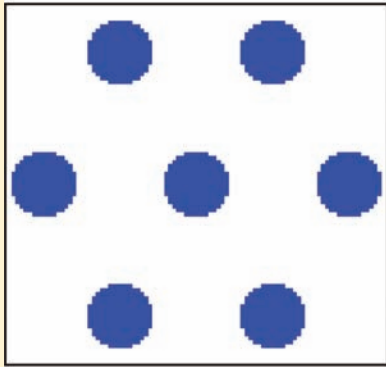

(a)



(b)

■ FIGURE 18.26 (a) Spatial filter having hexagonal symmetry. (b) Image after convolution and inverse discrete Fourier transform are performed, showing a reduction in background noise. Courtesy Professor John M. Squire, Imperial College, London.

An inverse FFT operation then produces the filtered image of Fig. 18.26b. Why does this convolution equate to a filtering operation? The myosin filament arrangement possesses hexagonal symmetry, as does the filter function  $h(x, y)$ —in a sense, both the myosin filament arrangement and the filter function possess the same

spatial frequencies. The convolution of  $f$  with  $h$  results in a reinforcement of the hexagonal pattern within the original image, and the removal of noise pixels (which do not possess hexagonal symmetry). This can be understood qualitatively if we model a horizontal row of Fig. 18.25 as a sinusoidal function  $f(x) = \cos \omega_0 t$ , which has the Fourier transform shown in Fig. 18.27a—a matched pair of impulse functions separated by  $2\omega_0$ . If we convolve this function with a filter function  $h(x) = \cos \omega_1 t$ , the Fourier transform of which is depicted in Fig. 18.27b, we get zero if  $\omega_1 \neq \omega_0$ ; the frequencies (periodicities) of the two functions do not match. If, instead, we choose a filter function with the same frequency as  $f(x)$ , the convolution has a nonzero value at  $\omega = \pm\omega_0$ .

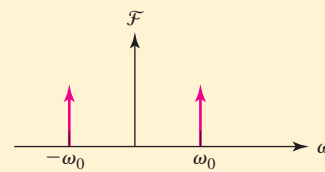

(a)

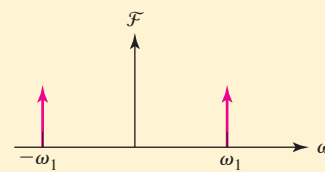

(b)

■ FIGURE 18.27 (a) Fourier transform of  $f(x) = \cos \omega_0 t$ . (b) Fourier transform of  $h(x) = \cos \omega_1 t$ .

impulse response  $h(t)$ . Is the information we examine really any different from what we just obtained? The Fourier transform of the unit impulse is a constant equal to unity, indicating that all frequency components are present, all with the same magnitude, and all with zero phase. Our system response is the sum of the responses to all these components. The result might be viewed at the output on a cathode-ray oscilloscope. It is evident that the system function and the impulse-response function contain equivalent information regarding the response of the system.

We therefore have two different methods of describing the response of a system to a general forcing function; one is a time-domain description, and the other a frequency-domain description. Working in the time domain, we

convolve the forcing function with the impulse response of the system to obtain the response function. As we saw when we first considered convolution, this procedure may be interpreted by thinking of the input as a continuum of impulses of different strengths and times of application; the output which results is a continuum of impulse responses.

In the frequency domain, however, we determine the response by multiplying the Fourier transform of the forcing function by the system function. In this case we interpret the transform of the forcing function as a frequency spectrum, or a continuum of sinusoids. Multiplying this by the system function, we obtain the response function, also as a continuum of sinusoids.

## SUMMARY AND REVIEW

---

Whether we choose to think of the output as a continuum of impulse responses or as a continuum of sinusoidal responses, the linearity of the network and the superposition principle enable us to determine the total output as a time function by summing over all frequencies (the inverse Fourier transform), or as a frequency function by summing over all time (the Fourier transform).

Unfortunately, both of these techniques have some difficulties or limitations associated with their use. In using convolution, the integral itself can often be rather difficult to evaluate when complicated forcing functions or impulse response functions are present. Furthermore, from the experimental point of view, we cannot really measure the impulse response of a system because we cannot actually generate an impulse. Even if we approximated the impulse by a narrow high-amplitude pulse, we would probably drive our system into saturation and out of its linear operating range.

With regard to the frequency domain, we encounter one absolute limitation in that we may easily hypothesize forcing functions that we would like to apply theoretically that do not possess Fourier transforms. Moreover, if we wish to find the time-domain description of the response function, we must evaluate an inverse Fourier transform, and some of these inversions can be extremely difficult.

Finally, neither of these techniques offers a very convenient method of handling initial conditions. For this, the Laplace transform is clearly superior.

The greatest benefits derived from the use of the Fourier transform arise through the abundance of useful information it provides about the spectral properties of a signal, particularly the energy or power per unit bandwidth. Some of this information is also easily obtained through the Laplace transform; we must leave a detailed discussion of the relative merits of each to more advanced signals and systems courses.

So, why has this all been withheld until now? The best answer is probably that these powerful techniques can overcomplicate the solution of simple problems and tend to obscure the physical interpretation of the performance of the simpler networks. For example, if we are interested only in the forced response, then there is little point in using the Laplace transform



and obtaining both the forced and natural response after laboring through a difficult inverse transform operation.

Well, we could go on, but all good things must come to an end. Best of luck to you in your future studies.

- The harmonic frequencies of a sinusoid having the fundamental frequency  $\omega_0$  are  $n\omega_0$ , where  $n$  is an integer. (Examples 18.1, 18.2)
- The Fourier theorem states that provided a function  $f(t)$  satisfies certain key properties, it may be represented by the infinite series  $a_0 + \sum_{n=1}^{\infty} (a_n \cos n\omega_0 t + b_n \sin n\omega_0 t)$ , where  $a_0 = (1/T) \int_0^T f(t) dt$ ,  $a_n = (2/T) \int_0^T f(t) \cos n\omega_0 t dt$ , and  $b_n = (2/T) \int_0^T f(t) \sin n\omega_0 t dt$ . (Example 18.1)
- A function  $f(t)$  possesses *even* symmetry if  $f(t) = f(-t)$ .
- A function  $f(t)$  possesses *odd* symmetry if  $f(t) = -f(-t)$ .
- A function  $f(t)$  possesses *half-wave* symmetry if  $f(t) = -f(t - \frac{1}{2}T)$ .
- The Fourier series of an even function is composed of only a constant and cosine functions.
- The Fourier series of an odd function is composed of only sine functions.
- The Fourier series of any function possessing half-wave symmetry contains only odd harmonics.
- The Fourier series of a function may also be expressed in complex or exponential form, where  $f(t) = \sum_{n=-\infty}^{\infty} c_n e^{jn\omega_0 t}$  and  $c_n = (1/T) \int_{-T/2}^{T/2} f(t) e^{-jn\omega_0 t} dt$ . (Examples 18.3, 18.4)
- The Fourier transform allows us to represent time-varying functions in the frequency domain, in a manner similar to that of the Laplace transform. The defining equations are  $\mathbf{F}(j\omega) = \int_{-\infty}^{\infty} e^{-j\omega t} f(t) dt$  and  $f(t) = (1/2\pi) \int_{-\infty}^{\infty} e^{j\omega t} \mathbf{F}(j\omega) d\omega$ . (Examples 18.5, 18.6, 18.7)
- Fourier transform analysis can be implemented to analyze circuits containing resistors, inductors, and/or capacitors in a manner similar to what is done using Laplace transforms. (Example 18.8)

## READING FURTHER

A very readable treatment of Fourier analysis can be found in:

A. Pinkus and S. Zafrany, *Fourier Series and Integral Transforms*. Cambridge: Cambridge University Press, 1997.

Finally, for those interested in learning more about muscle research, including electron microscopy of tissue, an excellent treatment can be found in:

J. Squire, *The Structural Basis of Muscular Contraction*. New York: Plenum Press, 1981.

## EXERCISES

### 18.1 Trigonometric Form of the Fourier Series

1. Determine the fundamental frequency, fundamental radian frequency, and period of the following: (a)  $5 \sin 9t$ ; (b)  $200 \cos 70t$ ; (c)  $4 \sin(4t - 10^\circ)$ ; (d)  $4 \sin(4t + 10^\circ)$ .
2. Plot multiple periods of the first, third, and fifth harmonics on the same graph of each of the following periodic waveforms (three separate graphs in total are desired): (a)  $3 \sin t$ ; (b)  $40 \cos 100t$ ; (c)  $2 \cos(10t - 90^\circ)$ .

3. Calculate  $a_0$  for the following: (a)  $4 \sin 4t$ ; (b)  $4 \cos 4t$ ; (c)  $4 + \cos 4t$ ; (d)  $4 \cos(4t + 40^\circ)$ .
4. Compute  $a_0$ ,  $a_1$ , and  $b_1$  for the following functions: (a)  $2 \cos 3t$ ; (b)  $3 - \cos 3t$ ; (c)  $4 \sin(4t - 35^\circ)$ .
5. (a) Calculate the Fourier coefficients  $a_0$ ,  $a_1$ ,  $a_2$ ,  $a_3$ ,  $b_1$ ,  $b_2$ , and  $b_3$  for the periodic function  $f(t) = 2u(t) - 2u(t + 1) + 2u(t + 2) - 2u(t + 3) + \dots$ . (b) Sketch  $f(t)$  and the Fourier series truncated after  $n = 3$  over 3 periods.
6. (a) Compute the Fourier coefficients  $a_0$ ,  $a_1$ ,  $a_2$ ,  $a_3$ ,  $a_4$ ,  $b_1$ ,  $b_2$ ,  $b_3$ , and  $b_4$  for the periodic function  $g(t)$  partially sketched in Fig. 18.28. (b) Plot  $g(t)$  along with the Fourier series representation truncated after  $n = 4$ .

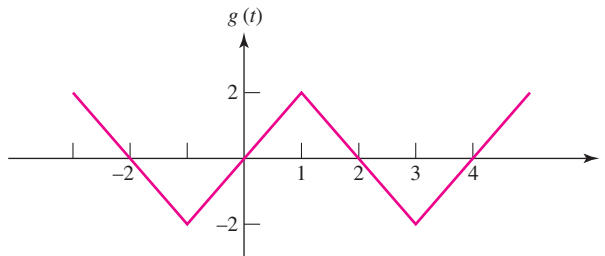

■ FIGURE 18.28

7. For the periodic waveform  $f(t)$  represented in Fig. 18.29, calculate  $a_1$ ,  $a_2$ ,  $a_3$  and  $b_1$ ,  $b_2$ ,  $b_3$ .

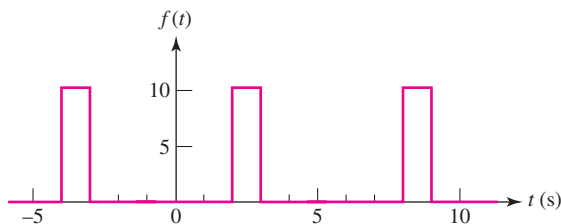

■ FIGURE 18.29

8. With respect to the periodic waveform sketched in Fig. 18.29, let  $g_n(t)$  represent the Fourier series representation of  $f(t)$  truncated at  $n$ . [For example, if  $n = 1$ ,  $g_1(t)$  has three terms, defined through  $a_0$ ,  $a_1$  and  $b_1$ .] (a) Sketch  $g_2(t)$ ,  $g_3(t)$ , and  $g_5(t)$ , along with  $f(t)$ . (b) Calculate  $f(2.5)$ ,  $g_2(2.5)$ ,  $g_3(2.5)$ , and  $g_5(2.5)$ .
9. With respect to the periodic waveform  $g(t)$  sketched in Fig. 18.28, define  $y_n(t)$  which represents the Fourier series representation truncated at  $n$ . (For example,  $y_2(t)$  has five terms, defined through  $a_0$ ,  $a_1$ ,  $a_2$ ,  $b_1$ , and  $b_2$ .) (a) Sketch  $y_3(t)$  and  $y_5(t)$  along with  $g(t)$ . (b) Compute  $y_1(0.5)$ ,  $y_2(0.5)$ ,  $y_3(0.5)$ , and  $g(0.5)$ .
10. Determine expressions for  $a_n$  and  $b_n$  for  $g(t - 1)$  if the periodic waveform  $g(t)$  is defined as sketched in Fig. 18.28.
11. Plot the line spectrum (limited to the six largest terms) for the waveform shown in Fig. 18.4a.
12. Plot the line spectrum (limited to the five largest terms) for the waveform of Fig. 18.4b.
13. Plot the line spectrum (limited to the five largest terms) for the waveform represented by the graph of Fig. 18.4c.

## 18.2 The Use of Symmetry

14. State whether the following exhibit odd symmetry, even symmetry, and/or half-wave symmetry: (a)  $4 \sin 100t$ ; (b)  $4 \cos 100t$ ; (c)  $4 \cos(4t + 70^\circ)$ ; (d)  $4 \cos 100t + 4$ ; (e) each waveform in Fig. 18.4.
15. Determine whether the following exhibit odd symmetry, even symmetry, and/or half-wave symmetry: (a) the waveform in Fig. 18.28; (b)  $g(t - 1)$ , if  $g(t)$  is represented in Fig. 18.28; (c)  $g(t + 1)$ , if  $g(t)$  is represented in Fig. 18.28; (d) the waveform of Fig. 18.29.
16. The nonperiodic waveform  $g(t)$  is defined in Fig. 18.30. Use it to create a new function  $y(t)$  such that  $y(t)$  is identical to  $g(t)$  over the range of  $0 < t < 4$  and also is characterized by a period  $T = 8$  and has (a) odd symmetry; (b) even symmetry; (c) both even and half-wave symmetry; (d) both odd and half-wave symmetry.

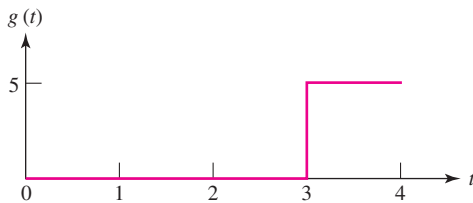

■ FIGURE 18.30

17. Calculate  $a_0, a_1, a_2, a_3$  and  $b_1, b_2, b_3$  for the periodic waveform  $v(t)$  represented in Fig. 18.31.

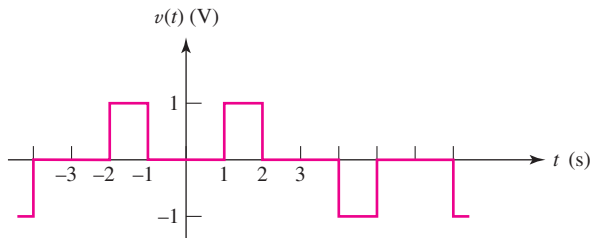

■ FIGURE 18.31

18. The waveform of Fig. 18.31 is shifted to create a new waveform such that  $v_{\text{new}}(t) = v(t + 1)$ . Calculate  $a_0, a_1, a_2, a_3$  and  $b_1, b_2, b_3$ .
19. Design a triangular waveform having a peak magnitude of 3, a period of 2 s, and characterized by (a) half-wave and even symmetry; (b) half-wave and odd symmetry.
20. Make use of symmetry as much as possible to obtain numerical values for  $a_0, a_n,$  and  $b_n, 1 \leq n \leq 10,$  for the waveform shown in Fig. 18.32.

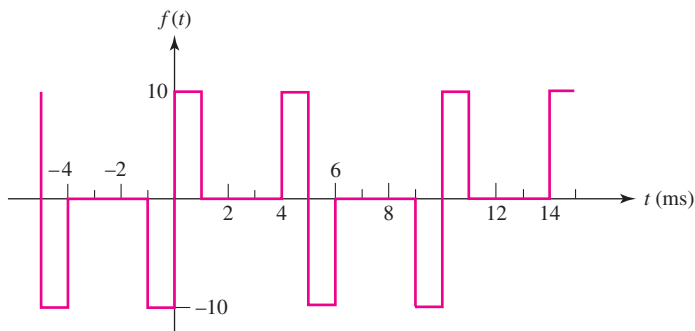

■ FIGURE 18.32

### 18.3 Complete Response to Periodic Forcing Functions

21. For the circuit of Fig. 18.33a, calculate  $v(t)$  if  $i_s(t)$  is given by Fig. 18.33b and  $v(0) = 0$ .

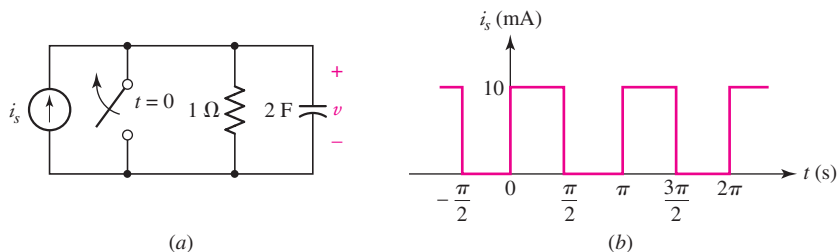

■ FIGURE 18.33

22. If the waveform shown in Fig. 18.34 is applied to the circuit of Fig. 18.8a, calculate  $i(t)$ .

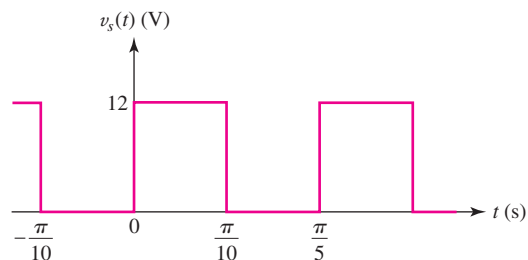

■ FIGURE 18.34

23. The circuit of Fig. 18.35a is subjected to the waveform depicted in Fig. 18.35b. Determine the steady-state voltage  $v(t)$ .

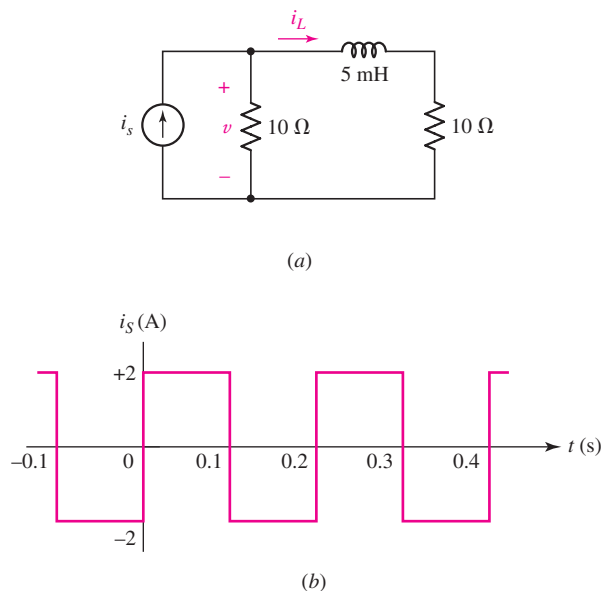

■ FIGURE 18.35

24. Apply the waveform of Fig. 18.36 to the circuit of Fig. 18.35*b*, and calculate the steady-state current  $i_L(t)$ .

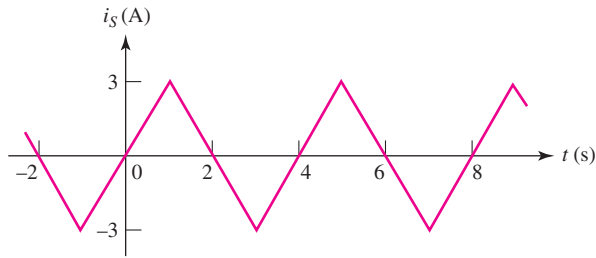

■ FIGURE 18.36

25. If the current waveform of Fig. 18.36 is applied to the circuit of Fig. 18.33*a*, calculate the steady-state voltage  $v(t)$ .

### 18.4 Complex Form of the Fourier Series

26. Let the function  $v(t)$  be defined as indicated in Fig. 18.10. Determine  $c_n$  for (a)  $v(t + 0.5)$ ; (b)  $v(t - 0.5)$ .
27. Calculate  $c_0$ ,  $c_{\pm 1}$ , and  $c_{\pm 2}$  for the waveform of Fig. 18.36.
28. Determine the first five terms of the exponential Fourier series representation of the waveform graphed in Fig. 18.33*b*.
29. For the periodic waveform shown in Fig. 18.37, determine (a) the period  $T$ ; (b)  $c_0$ ,  $c_{\pm 1}$ ,  $c_{\pm 2}$ , and  $c_{\pm 3}$ .

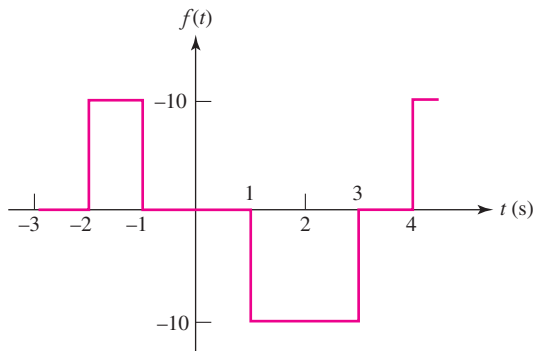

■ FIGURE 18.37

30. For the periodic waveform represented in Fig. 18.38, calculate (a) the period  $T$ ; (b)  $c_0$ ,  $c_{\pm 1}$ ,  $c_{\pm 2}$ , and  $c_{\pm 3}$ .

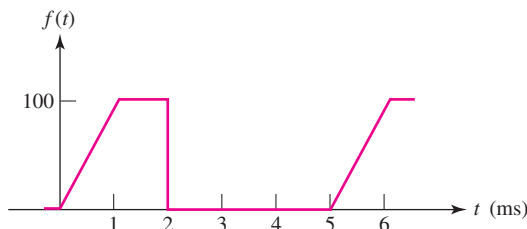

■ FIGURE 18.38

31. A pulse sequence has a period of  $5 \mu\text{s}$ , an amplitude of unity for  $-0.6 < t < -0.4 \mu\text{s}$  and for  $0.4 < t < 0.6 \mu\text{s}$ , and zero amplitude elsewhere in the period interval. This series of pulses might represent the decimal number 3 being transmitted in binary form by a digital computer. (a) Find  $\mathbf{c}_n$ . (b) Evaluate  $\mathbf{c}_4$ . (c) Evaluate  $\mathbf{c}_0$ . (d) Find  $|\mathbf{c}_n|_{\max}$ . (e) Find  $N$  so that  $|\mathbf{c}_n| \leq 0.1|\mathbf{c}_n|_{\max}$  for all  $n > N$ . (f) What bandwidth is required to transmit this portion of the spectrum?
32. Let a periodic voltage  $v_s(t)$  is equal to  $40 \text{ V}$  for  $0 < t < \frac{1}{96} \text{ s}$ , and to  $0$  for  $\frac{1}{96} < t < \frac{1}{16} \text{ s}$ . If  $T = \frac{1}{16} \text{ s}$ , find (a)  $\mathbf{c}_3$ ; (b) the power delivered to the load in the circuit of Fig. 18.39.

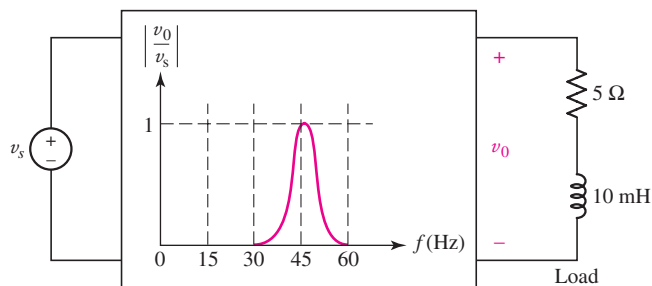

■ FIGURE 18.39

### 18.5 Definition of the Fourier Transform

33. Given

$$g(t) = \begin{cases} 5 & -1 < t < 1 \\ 0 & \text{elsewhere} \end{cases}$$

sketch (a)  $g(t)$ ; (b)  $\mathbf{G}(j\omega)$ .

34. For the function  $v(t) = 2u(t) - 2u(t+2) + 2u(t+4) - 2u(t+6) \text{ V}$ , sketch (a)  $v(t)$ ; (b)  $\mathbf{V}(j\omega)$ .

35. Employ Eq. [46a] to calculate  $\mathbf{G}(j\omega)$  if  $g(t)$  is (a)  $5e^{-t}u(t)$ ; (b)  $5te^{-t}u(t)$ .

36. Obtain the Fourier transform  $\mathbf{F}(j\omega)$  of the single triangle pulse plotted in Fig. 18.40.

37. Determine the Fourier transform  $\mathbf{F}(j\omega)$  of the single sinusoidal pulse waveform shown in Fig. 18.41.

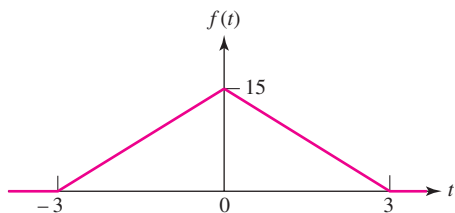

■ FIGURE 18.40

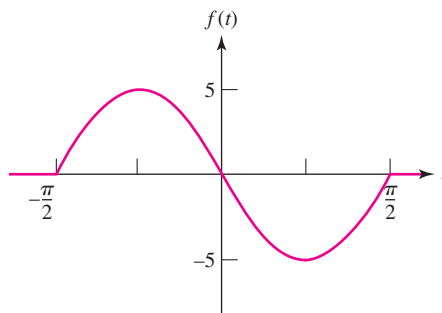

■ FIGURE 18.41

### 18.6 Some Properties of the Fourier Transform

38. For  $g(t) = 3e^{-t}u(t)$ , calculate (a)  $\mathbf{G}(j\omega)$ ; (b)  $\mathbf{A}_g(1)$ ; (c)  $\mathbf{B}_g(1)$ ; (d)  $\phi(\omega)$ .

39. The voltage pulse  $2e^{-t}u(t) \text{ V}$  is applied to the input of an ideal bandpass filter. The passband of the filter is defined by  $100 < |f| < 500 \text{ Hz}$ . Calculate the total output energy.

40. Given that  $v(t) = 4e^{-|t|}$  V, calculate the frequency range in which 85% of the  $1 \Omega$  energy lies.
41. Calculate the  $1 \Omega$  energy associated with the function  $f(t) = 4te^{-3t}u(t)$ .
42. Use the definition of the Fourier transform to prove the following results, where  $\mathcal{F}\{f(t)\} = \mathbf{F}(j\omega)$ : (a)  $\mathcal{F}\{f(t - t_0)\} = e^{-j\omega t_0} \mathcal{F}\{f(t)\}$ ; (b)  $\mathcal{F}\{df(t)/dt\} = j\omega \mathcal{F}\{f(t)\}$ ; (c)  $\mathcal{F}\{f(kt)\} = (1/|k|)\mathbf{F}(j\omega/k)$ ; (d)  $\mathcal{F}\{f(-t)\} = \mathbf{F}(-j\omega)$ ; (e)  $\mathcal{F}\{tf(t)\} = j d[\mathbf{F}(j\omega)]/d\omega$ .

### 18.7 Fourier Transform Pairs for Some Simple Time Functions

43. Determine the Fourier transform of the following: (a)  $5u(t) - 2 \operatorname{sgn}(t)$ ; (b)  $2 \cos 3t - 2$ ; (c)  $4e^{-j3t} + 4e^{j3t} + 5u(t)$ .
44. Find the Fourier transform of each of the following: (a)  $85u(t + 2) - 50u(t - 2)$ ; (b)  $5\delta(t) - 2 \cos 4t$ .
45. Sketch  $f(t)$  and  $|\mathbf{F}(j\omega)|$  if  $f(t)$  is given by (a)  $2 \cos 10t$ ; (b)  $e^{-4t}u(t)$ ; (c)  $5 \operatorname{sgn}(t)$ .
46. Determine  $f(t)$  if  $\mathbf{F}(j\omega)$  is given by (a)  $4\delta(\omega)$ ; (b)  $2/(5000 + j\omega)$ ; (c)  $e^{-j120\omega}$ .
47. Obtain an expression for  $f(t)$  if  $\mathbf{F}(j\omega)$  is given by  
 (a)  $-j \frac{231}{\omega}$ ; (b)  $\frac{1 + j2}{1 + j4}$ ; (c)  $5\delta(\omega) + \frac{1}{2 + j10}$ .

### 18.8 The Fourier Transform of a General Periodic Time Function

48. Calculate the Fourier transform of the following functions: (a)  $2 \cos^2 5t$ ; (b)  $7 \sin 4t \cos 3t$ ; (c)  $3 \sin(4t - 40^\circ)$ .
49. Determine the Fourier transform of the periodic function  $g(t)$ , which is defined over the range  $0 < t < 10$  s by  $g(t) = 2u(t) - 3u(t - 4) + 2u(t - 8)$ .
50. If  $\mathbf{F}(j\omega) = 20 \sum_{n=1}^{\infty} [1/(|n|! + 1)]\delta(\omega - 20n)$ , find the value of  $f(0.05)$ .
51. Given the periodic waveform shown in Fig. 18.42, determine its Fourier transform.

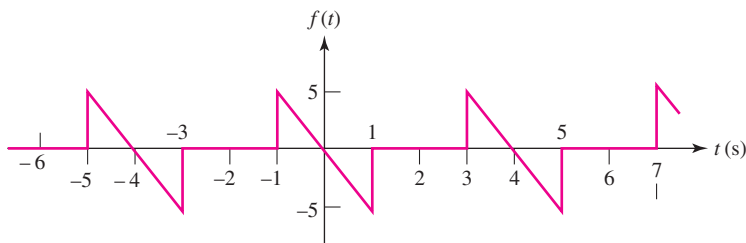

■ FIGURE 18.42

### 18.9 The System Function and Response in the Frequency Domain

52. If a system is described by transfer function  $h(t) = 2u(t) + 2u(t - 1)$ , use convolution to calculate the output (time domain) if the input is (a)  $2u(t)$ ; (b)  $2te^{-2t}u(t)$ .
53. Given the input function  $x(t) = 5e^{-5t}u(t)$ , employ convolution to obtain a time-domain output if the system transfer function  $h(t)$  is given by (a)  $3u(t + 1)$ ; (b)  $10te^{-t}u(t)$ .
54. (a) Design a noninverting amplifier having a gain of 10. If the circuit is constructed using a  $\mu\text{A}741$  op amp powered by  $\pm 15$  V supplies, determine the FFT of the output through appropriate simulations if the input voltage operates at 1 kHz and has magnitude (b) 10 mV; (c) 1 V; (d) 2 V.





55. (a) Design an inverting amplifier having a gain of 5. If the circuit is constructed using a  $\mu\text{A}741$  op amp powered by  $\pm 10$  V supplies, perform appropriate simulations to determine the FFT of the output voltage if the input voltage has a frequency of 10 kHz and magnitude (b) 500 mV; (c) 1.8 V; (d) 3 V.

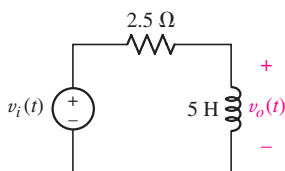

■ FIGURE 18.43

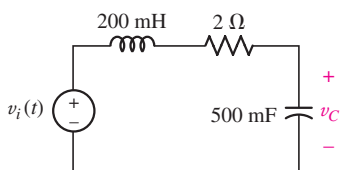

■ FIGURE 18.44

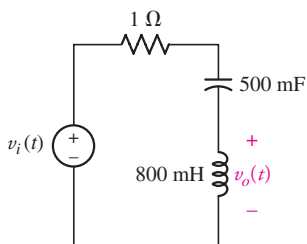

■ FIGURE 18.45

### 18.10 The Physical Significance of the System Function

56. With respect to the circuit of Fig. 18.43, calculate  $v_o(t)$  using Fourier techniques if  $v_i(t) = 2te^{-4t}u(t)$  V.
57. After the inductor of Fig. 18.43 is surreptitiously replaced with a 2 F capacitor, calculate  $v_o(t)$  using Fourier techniques if  $v_i(t)$  is equal to (a)  $5u(t)$  V; (b)  $3e^{-4t}u(t)$  V.
58. Employ Fourier-based techniques to calculate  $v_C(t)$  as labeled in Fig. 18.44 if  $v_i(t)$  is equal to (a)  $2u(t)$  V; (b)  $2\delta(t)$  V.
59. Employ Fourier-based techniques to calculate  $v_o(t)$  as labeled in Fig. 18.45 if  $v_i(t)$  is equal to (a)  $5u(t)$  V; (b)  $3\delta(t)$  V.
60. Employ Fourier-based techniques to calculate  $v_o(t)$  as labeled in Fig. 18.45 if  $v_i(t)$  is equal to (a)  $5u(t-1)$  V; (b)  $2 + 8e^{-4t}u(t)$  V.

### Chapter-Integrating Exercises

61. Apply the pulse waveform of Fig. 18.46a as the voltage input  $v_i(t)$  to the circuit shown in Fig. 18.44, and calculate  $v_C(t)$ .

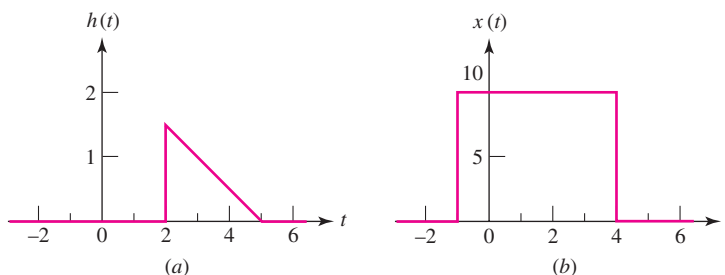

■ FIGURE 18.46

62. Apply the pulse waveform of Fig. 18.46b as the voltage input  $v_i(t)$  to the circuit shown in Fig. 18.44, and calculate  $v_C(t)$ .
63. Apply the pulse waveform of Fig. 18.46a as the voltage input  $v_i(t)$  to the circuit shown in Fig. 18.44, and calculate  $i_C(t)$ , defined consistent with the passive sign convention.
64. Apply the pulse waveform of Fig. 18.46b as the voltage input  $v_i(t)$  to the circuit shown in Fig. 18.45, and calculate  $v_o(t)$ .
65. Apply the pulse waveform of Fig. 18.46b as the voltage input  $v_i(t)$  to the circuit shown in Fig. 18.45, and calculate  $v_o(t)$ .



## AN INTRODUCTION TO NETWORK TOPOLOGY

After working many circuits problems, it slowly becomes evident that many of the circuits we see have quite a bit in common, at least in terms of the arrangement of components. From this realization, it is possible to create a more abstract view of circuits which we call *network topology*, a subject we introduce in this appendix.

### A1.1 TREES AND GENERAL NODAL ANALYSIS

We now plan to generalize the method of nodal analysis that we have come to know and love. Since nodal analysis is applicable to any network, we cannot promise that we will be able to solve a wider class of circuit problems. We can, however, look forward to being able to select a general nodal analysis method for any particular problem that may result in fewer equations and less work.

We must first extend our list of definitions relating to network topology. We begin by defining *topology* itself as a branch of geometry which is concerned with those properties of a geometrical figure which are unchanged when the figure is twisted, bent, folded, stretched, squeezed, or tied in knots, with the provision that no parts of the figure are to be cut apart or to be joined together. A sphere and a tetrahedron are topologically identical, as are a square and a circle. In terms of electric circuits, then, we are not now concerned with the particular types of elements appearing in the circuit, but only with the way in which branches and nodes are arranged. As a matter of fact, we usually suppress the nature of the elements and simplify the drawing of the circuit by showing the elements as lines. The resultant drawing is called a linear graph, or simply a graph. A circuit and its graph are shown in Fig. A1.1. Note that all nodes are identified by heavy dots in the graph.

Since the topological properties of the circuit or its graph are unchanged when it is distorted, the three graphs shown in Fig. A1.2 are all topologically identical with the circuit and graph of Fig. A1.1.

Topological terms that we already know and have been using correctly are

*Node:* A point at which two or more elements have a common connection.

*Path:* A set of elements that may be traversed in order without passing through the same node twice.

*Branch:* A single path, containing one simple element, which connects one node to any other node.

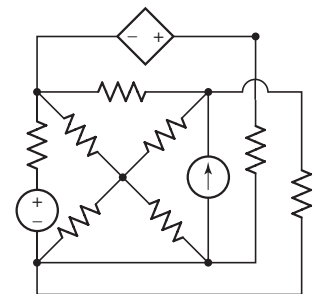

(a)

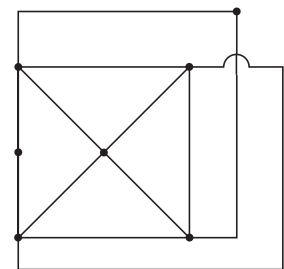

(b)

■ FIGURE A1.1 (a) A given circuit. (b) The linear graph of this circuit.

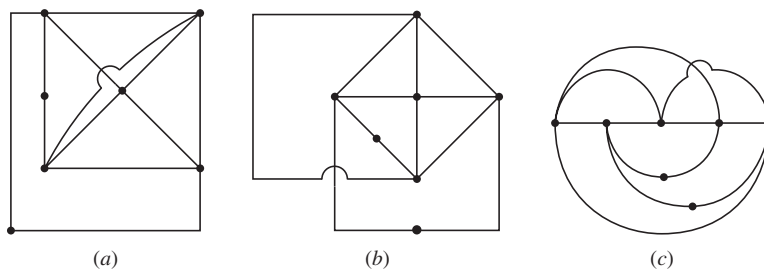

■ FIGURE A1.2 (a, b, c) Alternative linear graphs of the circuit of Fig. A1.1.

*Loop:* A closed path.

*Mesh:* A loop which does not contain any other loops within it.

*Planar circuit:* A circuit which may be drawn on a plane surface in such a way that no branch passes over or under any other branch.

*Nonplanar circuit:* Any circuit which is not planar.

The graphs of Fig. A1.2 each contain 12 branches and 7 nodes.

Three new properties of a linear graph must now be defined—a *tree*, a *cotree*, and a *link*. We define a *tree* as any set of branches which does not contain any loops and yet connects every node to every other node, not necessarily directly. There are usually a number of different trees which may be drawn for a network, and the number increases rapidly as the complexity of the network increases. The simple graph shown in Fig. A1.3a has eight possible trees, four of which are shown by heavy lines in Fig. A1.3b, c, d, and e.

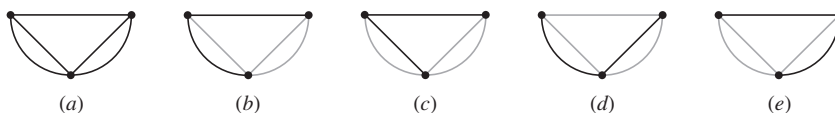

■ FIGURE A1.3 (a) The linear graph of a three-node network. (b, c, d, e) Four of the eight different trees which may be drawn for this graph are shown by the black lines.

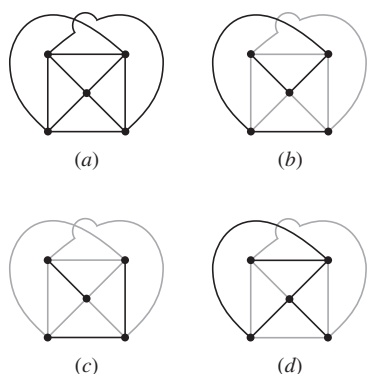

■ FIGURE A1.4 (a) A linear graph. (b) A possible tree for this graph. (c, d) These sets of branches do not satisfy the definition of a tree.

In Fig. A1.4a a more complex graph is shown. Figure A1.4b shows one possible tree, and Fig. A1.4c and d show sets of branches which are not trees because neither set satisfies the definition.

After a tree has been specified, those branches that are not part of the tree form the *cotree*, or complement of the tree. The lightly drawn branches in Fig. A1.3b to e show the cotrees that correspond to the heavier trees.

Once we understand the construction of a tree and its cotree, the concept of the *link* is very simple, for a link is any branch belonging to the cotree. It is evident that any particular branch may or may not be a link, depending on the particular tree which is selected.

The number of links in a graph may easily be related to the number of branches and nodes. If the graph has  $N$  nodes, then exactly  $(N - 1)$  branches are required to construct a tree because the first branch chosen connects two nodes and each additional branch includes one more node.

Thus, given  $B$  branches, the number of links  $L$  must be

$$L = B - (N - 1)$$

or

$$L = B - N + 1 \quad [1]$$

There are  $L$  branches in the cotree and  $(N - 1)$  branches in the tree.

In any of the graphs shown in Fig. A1.3, we note that  $3 = 5 - 3 + 1$ , and in the graph of Fig. A1.4b,  $6 = 10 - 5 + 1$ . A network may be in several disconnected parts, and Eq. [1] may be made more general by replacing  $+1$  with  $+S$ , where  $S$  is the number of separate parts. However, it is also possible to connect two separate parts by a single conductor, thus causing two nodes to form one node; no current can flow through this single conductor. This process may be used to join any number of separate parts, and thus we will not suffer any loss of generality if we restrict our attention to circuits for which  $S = 1$ .

We are now ready to discuss a method by which we may write a set of nodal equations that are independent and sufficient. The method will enable us to obtain many different sets of equations for the same network, and all the sets will be valid. However, the method does not provide us with every possible set of equations. Let us first describe the procedure, illustrate it by three examples, and then point out the reason that the equations are independent and sufficient.

Given a network, we should:

- 
1. Draw a graph and then identify a tree.
  2. Place all voltage sources in the tree.
  3. Place all current sources in the cotree.
  4. Place all control-voltage branches for voltage-controlled dependent sources in the tree, if possible.
  5. Place all control-current branches for current-controlled dependent sources in the cotree, if possible.
- 

These last four steps effectively associate voltages with the tree and currents with the cotree.

We now assign a voltage variable (with its plus-minus pair) across each of the  $(N - 1)$  branches in the tree. A branch containing a voltage source (dependent or independent) should be assigned that source voltage, and a branch containing a controlling voltage should be assigned that controlling voltage. The number of new variables that we have introduced is therefore equal to the number of branches in the tree  $(N - 1)$ , reduced by the number of voltage sources in the tree, and reduced also by the number of control voltages we were able to locate in the tree. In Example A1.3, we will find that the number of new variables required may be zero.

Having a set of variables, we now need to write a set of equations that are sufficient to determine these variables. The equations are obtained through the application of KCL. Voltage sources are handled in the same way that they were in our earlier attack on nodal analysis; each voltage

source and the two nodes at its terminals constitute a supernode or a part of a supernode. Kirchhoff's current law is then applied at all but one of the remaining nodes and supernodes. We set the sum of the currents leaving the node in all of the branches connected to it equal to zero. Each current is expressed in terms of the voltage variables we just assigned. One node may be ignored, just as was the case earlier for the reference node. Finally, in case there are current-controlled dependent sources, we must write an equation for each control current that relates it to the voltage variables; this also is no different from the procedure used before with nodal analysis.

Let us try out this process on the circuit shown in Fig. A1.5a. It contains four nodes and five branches, and its graph is shown in Fig. A1.5b.

### EXAMPLE A1.1

Find the value of  $v_x$  in the circuit of Fig. A1.5a.

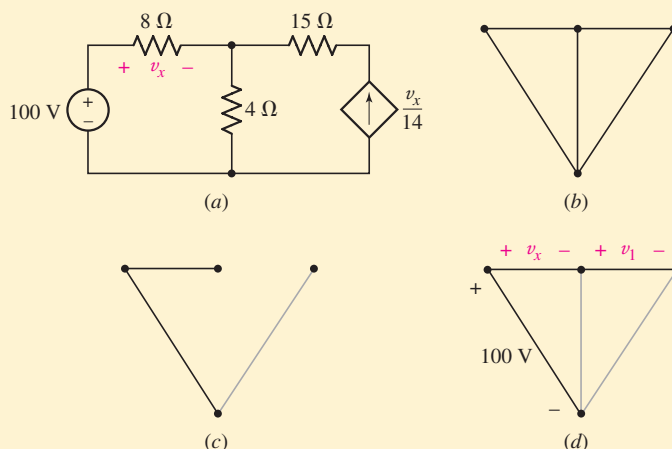

■ FIGURE A1.5 (a) A circuit used as an example for general nodal analysis. (b) The graph of the given circuit. (c) The voltage source and the control voltage are placed in the tree, while the current source goes in the cotree. (d) The tree is completed and a voltage is assigned across each tree branch.

In accordance with steps 2 and 3 of the tree-drawing procedure, we place the voltage source in the tree and the current source in the cotree. Following step 4, we see that the  $v_x$  branch may also be placed in the tree, since it does not form any loop which would violate the definition of a tree. We have now arrived at the two tree branches and the single link shown in Fig. A1.5c, and we see that we do not yet have a tree, since the right node is not connected to the others by a path through tree branches. The only possible way to complete the tree is shown in Fig. A1.5d. The 100 V source voltage, the control voltage  $v_x$ , and a new voltage variable  $v_1$  are next assigned to the three tree branches as shown.

We therefore have two unknowns,  $v_x$  and  $v_1$ , and we need to obtain two equations in terms of them. There are four nodes, but the presence

of the voltage source causes two of them to form a single supernode. Kirchoff's current law may be applied at any two of the three remaining nodes or supernodes. Let's attack the right node first. The current leaving to the left is  $-v_1/15$ , while that leaving downward is  $-v_x/14$ . Thus, our first equation is

$$-\frac{v_1}{15} + \frac{-v_x}{14} = 0$$

The central node at the top looks easier than the supernode, and so we set the sum of the current to the left ( $-v_x/8$ ), the current to the right ( $v_1/15$ ), and the downward current through the  $4\text{-}\Omega$  resistor equal to zero. This latter current is given by the voltage across the resistor divided by  $4\ \Omega$ , but there is no voltage labeled on that link. However, when a tree is constructed according to the definition, there is a path through it from any node to any other node. Then, since every branch in the tree is assigned a voltage, we may express the voltage across any link in terms of the tree-branch voltages. This downward current is therefore  $(-v_x + 100)/4$ , and we have the second equation,

$$-\frac{v_x}{8} + \frac{v_1}{15} + \frac{-v_x + 100}{4} = 0$$

The simultaneous solution of these two nodal equations gives

$$v_1 = -60\text{ V} \quad v_x = 56\text{ V}$$

## EXAMPLE A1.2

Find the values of  $v_x$  and  $v_y$  in the circuit of Fig. A1.6a.

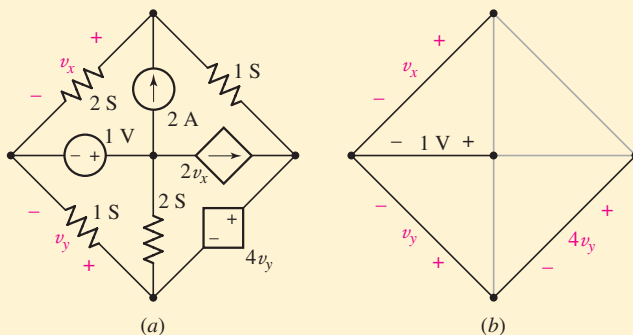

■ FIGURE A1.6 (a) A circuit with five nodes. (b) A tree is chosen such that both voltage sources and both control voltages are tree branches.

We draw a tree so that both voltage sources and both control voltages appear as tree-branch voltages and, hence, as assigned variables. As it happens, these four branches constitute a tree, Fig. A1.6b, and tree-branch voltages  $v_x$ ,  $1$ ,  $v_y$ , and  $4v_y$  are chosen, as shown.

(Continued on next page)

Both voltage sources define supernodes, and we apply KCL twice, once to the top node,

$$2v_x + 1(v_x - v_y - 4v_y) = 2$$

and once to the supernode consisting of the right node, the bottom node, and the dependent voltage source,

$$1v_y + 2(v_y - 1) + 1(4v_y + v_y - v_x) = 2v_x$$

Instead of the four equations we would expect using previously studied techniques, we have only two, and we find easily that  $v_x = \frac{26}{9}$  V and  $v_y = \frac{4}{3}$  V.

### EXAMPLE A1.3

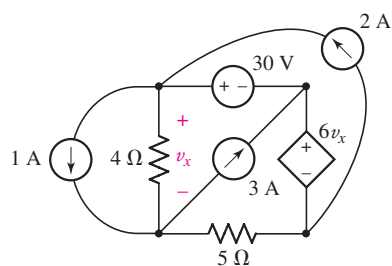

(a)

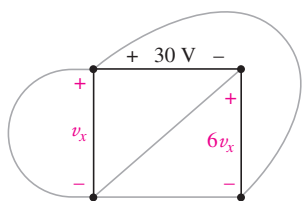

(b)

■ FIGURE A1.7 (a) A circuit for which only one general nodal equation need be written. (b) The tree and the tree-branch voltages used.

### Find the value of $v_x$ in the circuit of Fig. A1.7a.

The two voltage sources and the control voltage establish the three-branch tree shown in Fig. A1.7b. Since the two upper nodes and the lower right node all join to form one supernode, we need write only one KCL equation. Selecting the lower left node, we have

$$-1 - \frac{v_x}{4} + 3 + \frac{-v_x + 30 + 6v_x}{5} = 0$$

and it follows that  $v_x = -\frac{32}{3}$  V. In spite of the apparent complexity of this circuit, the use of general nodal analysis has led to an easy solution. Employing mesh currents or node-to-reference voltages would require more equations and more effort.

We will discuss the problem of finding the best analysis scheme in the following section.

If we needed to know some other voltage, current, or power in the previous example, one additional step would give the answer. For example, the power provided by the 3 A source is

$$3(-30 - \frac{32}{3}) = -122 \text{ W}$$

Let us conclude by discussing the sufficiency of the assumed set of tree-branch voltages and the independence of the nodal equations. If these tree-branch voltages are sufficient, then the voltage of every branch in either the tree or the cotree must be obtainable from a knowledge of the values of all the tree-branch voltages. This is certainly true for those branches in the tree. For the links we know that each link extends between two nodes, and, by definition, the tree must also connect those two nodes. Hence, every link voltage may also be established in terms of the tree-branch voltages.

Once the voltage across every branch in the circuit is known, then all the currents may be found by using either the given value of the current if the branch consists of a current source, by using Ohm's law if it is a resistive branch, or by using KCL and these current values if the branch happens to be a voltage source. Thus, all the voltages and currents are determined and sufficiency is demonstrated.

To demonstrate independency, let us satisfy ourselves by assuming the situation where the only sources in the network are independent current sources. As we have noticed earlier, independent voltage sources in the circuit result in fewer equations, while dependent sources usually necessitate a greater number of equations. With independent current sources only, there will then be precisely  $(N - 1)$  nodal equations written in terms of  $(N - 1)$  tree-branch voltages. To show that these  $(N - 1)$  equations are independent, visualize the application of KCL to the  $(N - 1)$  different nodes. Each time we write the KCL equation, there is a new tree branch involved—the one which connects that node to the remainder of the tree. Since that circuit element has not appeared in any previous equation, we must obtain an independent equation. This is true for each of the  $(N - 1)$  nodes in turn, and hence we have  $(N - 1)$  independent equations.

### PRACTICE

A1.1 (a) How many trees may be constructed for the circuit of Fig. A1.8 that follow all five of the tree-drawing suggestions listed earlier? (b) Draw a suitable tree, write two equations in two unknowns, and find  $i_3$ . (c) What power is supplied by the dependent source?

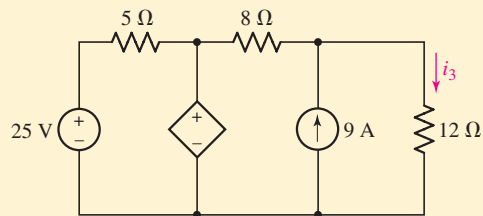

FIGURE A1.8

Ans: 1; 7.2 A; 547 W.

## A1.2 LINKS AND LOOP ANALYSIS

Now we will consider the use of a tree to obtain a suitable set of loop equations. In some respects this is the *dual* of the method of writing nodal equations. Again it should be pointed out that, although we are able to guarantee that any set of equations we write will be both sufficient and independent, we should not expect that the method will lead directly to every possible set of equations.

We again begin by constructing a tree, and we use the same set of rules as we did for general nodal analysis. The objective for either nodal or loop analysis is to place voltages in the tree and currents in the cotree; this is a mandatory rule for sources and a desirable rule for controlling quantities.

Now, however, instead of assigning a voltage to each branch in the tree, we assign a current (including reference arrow, of course) to each element in the cotree or to each link. If there were 10 links, we would assign exactly 10 link currents. Any link that contains a current source is assigned that source current as the link current. Note that each link current may also be

thought of as a loop current, for the link must extend between two specific nodes, and there must also be a path between those same two nodes through the tree. Thus, with each link there is associated a single specific loop that includes that one link and a unique path through the tree. It is evident that the assigned current may be thought of either as a loop current or as a link current. The link connotation is most helpful at the time the currents are being defined, for one must be established for each link; the loop interpretation is more convenient at equation-writing time, because we will apply KVL around each loop.

Let us try out this process of defining link currents by considering the circuit shown in Fig. A1.9a. The tree selected is one of several that might be constructed for which the voltage source is in a tree branch and the current source is in a link. Let us first consider the link containing the current source. The loop associated with this link is the left-hand mesh, and so we show our link current flowing about the perimeter of this mesh (Fig. A1.9b). An obvious choice for the symbol for this link current is “7 A.” Remember that no other current can flow through this particular link, and thus its value must be exactly the strength of the current source.

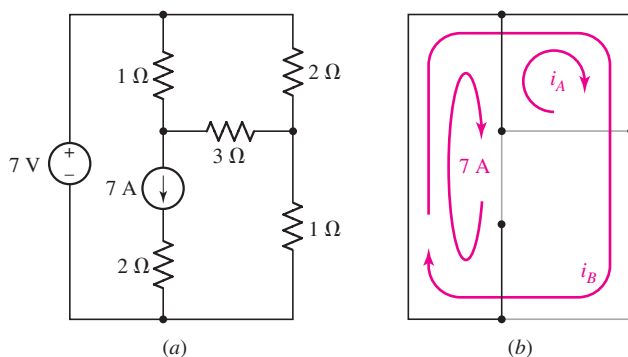

■ FIGURE A1.9 (a) A simple circuit. (b) A tree is chosen such that the current source is in a link and the voltage source is in a tree branch.

We next turn our attention to the  $3\ \Omega$  resistor link. The loop associated with it is the upper right-hand mesh, and this loop (or mesh) current is defined as  $i_A$  and also shown in Fig. A1.9b. The last link is the lower  $1\ \Omega$  resistor, and the only path between its terminals through the tree is around the perimeter of the circuit. That link current is called  $i_B$ , and the arrow indicating its path and reference direction appears in Fig. A1.9b. It is not a mesh current.

Note that each link has only one current present in it, but a tree branch may have any number from 1 to the total number of link currents assigned. The use of long, almost closed, arrows to indicate the loops helps to indicate which loop currents flow through which tree branch and what their reference directions are.

A KVL equation must now be written around each of these loops. The variables used are the assigned link currents. Since the voltage across a current source cannot be expressed in terms of the source current, and since we have already used the value of the source current as the link current, we discard any loop containing a current source.



## EXAMPLE A1.4

For the example of Fig. A1.9, find the values of  $i_A$  and  $i_B$ .

We first traverse the  $i_A$  loop, proceeding clockwise from its lower left corner. The current going our way in the  $1\ \Omega$  resistor is  $(i_A - 7)$ , in the  $2\ \Omega$  element it is  $(i_A + i_B)$ , and in the link it is simply  $i_B$ . Thus

$$1(i_A - 7) + 2(i_A + i_B) + 3i_A = 0$$

For the  $i_B$  link, clockwise travel from the lower left corner leads to

$$-7 + 2(i_A + i_B) + 1i_B = 0$$

Traversal of the loop defined by the 7 A link is not required. Solving, we have  $i_A = 0.5\ \text{A}$ ,  $i_B = 2\ \text{A}$ , once again. The solution has been achieved with one less equation than before!

## EXAMPLE A1.5

Evaluate  $i_1$  in the circuit shown in Fig. A1.10a.

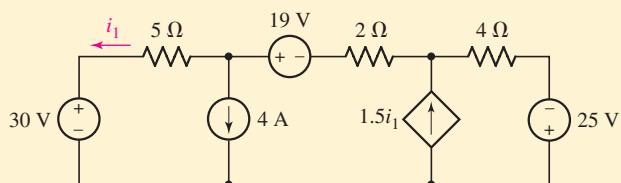

(a)

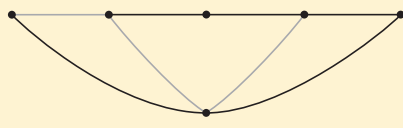

(b)

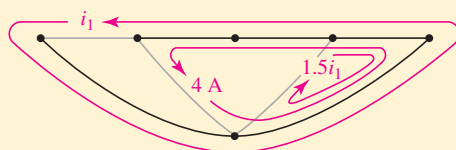

(c)

■ FIGURE A1.10 (a) A circuit for which  $i_1$  may be found with one equation using general loop analysis. (b) The only tree that satisfies the rules outlined in Sec. A1.1. (c) The three link currents are shown with their loops.

This circuit contains six nodes, and its tree therefore must have five branches. Since there are eight elements in the network, there are three links in the cotree. If we place the three voltage sources in the tree and the two current sources and the current control in the cotree, we are led to the tree shown in Fig. A1.10b. The source current of 4 A defines a

(Continued on next page)

loop as shown in Fig. A1.10c. The dependent source establishes the loop current  $1.5i_1$  around the right mesh, and the control current  $i_1$  gives us the remaining loop current about the perimeter of the circuit. Note that all three currents flow through the  $4\ \Omega$  resistor.

We have only one unknown quantity,  $i_1$ , and after discarding the loops defined by the two current sources, we apply KVL around the outside of the circuit:

$$-30 + 5(-i_1) + 19 + 2(-i_1 - 4) + 4(-i_1 - 4 + 1.5i_1) - 25 = 0$$

Besides the three voltage sources, there are three resistors in this loop. The  $5\ \Omega$  resistor has one loop current in it, since it is also a link; the  $2\ \Omega$  resistor contains two loop currents; and the  $4\ \Omega$  resistor has three. A carefully drawn set of loop currents is a necessity if errors in skipping currents, utilizing extra ones, or erring in choosing the correct direction are to be avoided. The foregoing equation is guaranteed, however, and it leads to  $i_1 = -12\ \text{A}$ .

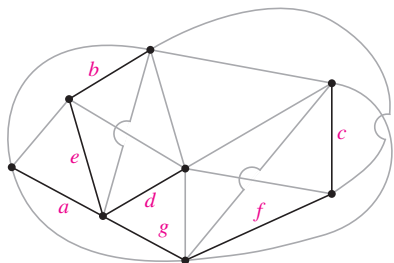

■ FIGURE A1.11 A tree that is used as an example to illustrate the sufficiency of the link currents.

How may we demonstrate sufficiency? Let us visualize a tree. It contains no loops and therefore contains at least two nodes to each of which only one tree branch is connected. The current in each of these two branches is easily found from the known link currents by applying KCL. If there are other nodes at which only one tree branch is connected, these tree-branch currents may also be immediately obtained. In the tree shown in Fig. A1.11, we thus have found the currents in branches **a**, **b**, **c**, and **d**. Now we move along the branches of the tree, finding the currents in tree branches **e** and **f**; the process may be continued until all the branch currents are determined. The link currents are therefore sufficient to determine all branch currents. It is helpful to look at the situation where an incorrect “tree” has been drawn which contains a loop. Even if all the link currents were zero, a current might still circulate about this “tree loop.” Hence, the link currents could not determine this current, and they would not represent a sufficient set. Such a “tree” is by definition impossible.

To demonstrate independence, let us satisfy ourselves by assuming the situation where the only sources in the network are independent voltage sources. As we have noticed earlier, independent current sources in the circuit result in fewer equations, while dependent sources usually necessitate a greater number of equations. If only independent voltage sources are present, there will then be precisely  $(B - N + 1)$  loop equations written in terms of the  $(B - N + 1)$  link currents. To show that these  $(B - N + 1)$  loop equations are independent, it is necessary only to point out that each represents the application of KVL around a loop which contains one link not appearing in any other equation. We might visualize a different resistance  $R_1, R_2, \dots, R_{B-N+1}$  in each of these links, and it is then apparent that one equation can never be obtained from the others, since each contains one coefficient not appearing in any other equation.

Hence, the link currents are sufficient to enable a complete solution to be obtained, and the set of loop equations which we use to find the link currents is a set of independent equations.

Having looked at both general nodal analysis and loop analysis, we should now consider the advantages and disadvantages of each method so that an intelligent choice of a plan of attack can be made on a given analysis problem.

The nodal method in general requires  $(N - 1)$  equations, but this number is reduced by 1 for each independent or dependent voltage source in a tree branch, and increased by 1 for each dependent source that is voltage-controlled by a link voltage, or current-controlled.

The loop method basically involves  $(B - N + 1)$  equations. However, each independent or dependent current source in a link reduces this number by 1, while each dependent source that is current-controlled by a tree-branch current, or is voltage-controlled, increases the number by 1.

As a grand finale for this discussion, let us inspect the T-equivalent circuit model for a transistor shown in Fig. A1.12, to which is connected a sinusoidal source,  $4 \sin 1000t$  mV, and a  $10 \text{ k}\Omega$  load.

## EXAMPLE A1.6

Find the input (emitter) current  $i_e$  and the load voltage  $v_L$  in the circuit of Fig. A1.12, assuming typical values for the emitter resistance  $r_e = 50 \text{ }\Omega$ ; the base resistance  $r_b = 500 \text{ }\Omega$ ; the collector resistance  $r_c = 20 \text{ k}\Omega$ ; and the common-base forward-current-transfer ratio  $\alpha = 0.99$ .

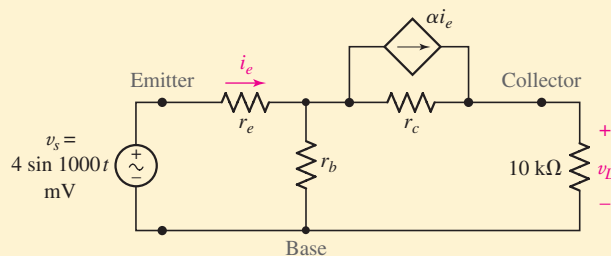

■ FIGURE A1.12 A sinusoidal voltage source and a  $10 \text{ k}\Omega$  load are connected to the T-equivalent circuit of a transistor. The common connection between the input and output is at the base terminal of the transistor, and the arrangement is called the *common-base* configuration.

Although the details are requested in the practice problems that follow, we should see readily that the analysis of this circuit might be accomplished by drawing trees requiring three general nodal equations  $(N - 1 - 1 + 1)$  or two loop equations  $(B - N + 1 - 1)$ . We might also note that three equations are required in terms of node-to-reference voltages, as are three mesh equations.

No matter which method we choose, these results are obtained for this specific circuit:

$$\begin{aligned} i_e &= 18.42 \sin 1000t & \mu\text{A} \\ v_L &= 122.6 \sin 1000t & \text{mV} \end{aligned}$$

(Continued on next page)

and we therefore find that this transistor circuit provides a voltage gain ( $v_L/v_s$ ) of 30.6, a current gain ( $v_L/10,000i_e$ ) of 0.666, and a power gain equal to the product  $30.6(0.666) = 20.4$ . Higher gains could be secured by operating this transistor in a common-emitter configuration.

### PRACTICE

A1.2 Draw a suitable tree and use general loop analysis to find  $i_{10}$  in the circuit of (a) Fig. A1.13a by writing just one equation with  $i_{10}$  as the variable; (b) Fig. A1.13b by writing just two equations with  $i_{10}$  and  $i_3$  as the variables.

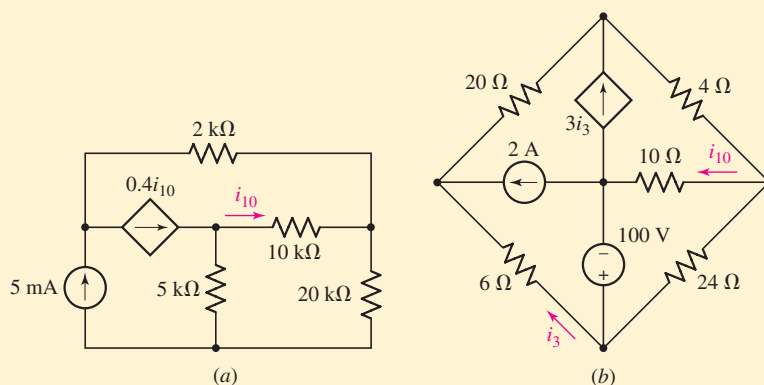

■ FIGURE A1.13

A1.3 For the transistor amplifier equivalent circuit shown in Fig. A1.12, let  $r_e = 50 \Omega$ ,  $r_b = 500 \Omega$ ,  $r_c = 20 \text{ k}\Omega$ , and  $\alpha = 0.99$ , and find both  $i_e$  and  $v_L$  by drawing a suitable tree and using (a) two loop equations; (b) three nodal equations with a common reference node for the voltage; (c) three nodal equations without a common reference node.

A1.4 Determine the Thévenin and Norton equivalent circuits presented to the  $10 \text{ k}\Omega$  load in Fig. A1.12 by finding (a) the open-circuit value of  $v_L$ ; (b) the (downward) short-circuit current; (c) the Thévenin equivalent resistance. All circuit values are given in Practice Problem A1.3.

Ans: A1.2:  $-4.00 \text{ mA}$ ;  $4.69 \text{ A}$ . A1.3:  $18.42 \sin 1000t \mu\text{A}$ ;  $122.6 \sin 1000t \text{ mV}$ .  
A1.4:  $147.6 \sin 1000t \text{ mV}$ ;  $72.2 \sin 1000t \mu\text{A}$ ;  $2.05 \text{ k}\Omega$ .

## SOLUTION OF SIMULTANEOUS EQUATIONS

Consider the simple system of equations

$$7v_1 - 3v_2 - 4v_3 = -11 \quad [1]$$

$$-3v_1 + 6v_2 - 2v_3 = 3 \quad [2]$$

$$-4v_1 - 2v_2 + 11v_3 = 25 \quad [3]$$

This set of equations *could* be solved by a systematic elimination of the variables. Such a procedure is lengthy, however, and may never yield answers if done unsystematically for a greater number of simultaneous equations. Fortunately, there are many more options available to us, some of which we will explore in this appendix.

### The Scientific Calculator

Perhaps the most straightforward approach when faced with a system of equations such as Eqs. [1] to [3], in which we have numerical coefficients and are only interested in the specific values of our unknowns (as opposed to algebraic relationships), is to employ any of the various scientific calculators presently on the market. For example, on a Texas Instruments TI-84, we can employ the Polynomial Root Finder and Simultaneous Equation Solver (you may need to install the application using TI Connect™). Pressing the **APPS** key and scrolling down, find the application named **PLYSmlt2**. Running and continuing past the welcome screen shows the Main Menu of Fig. A2.1a. Selecting the second menu item results in the screen shown in Fig. A2.1b, where we have chosen three equations in three unknowns. After

```

MAIN MENU
1: POLY ROOT FINDER
2: SIMULT EQN SOLVER
3: ABOUT
4: POLY HELP
5: SIMULT HELP
6: QUIT POLYSMLT
  
```

(a)

```

SIMULT EQN SOLVER MODE
EQUATIONS: 2 3 4 5 6 7 8 9 10
UNKNOWN: 2 3 4 5 6 7 8 9 10
FRAC
NORMAL SCI ENG
FLOAT 0 1 2 3 4 5 6 7 8 9
RADIAN DEGREE
(MAIN) (HELP) (NEXT)
  
```

(b)

```

SYSTEM MATRIX (3x4)
[ 7  -3  -4  | -11 ]
[ -3  6   0  |  3  ]
[ -4  -2  11 |  25 ]
  
```

```

SOLUTION
x1 = 1
x2 = 2
x3 = 3
  
```

```

(2,2) = 0
(MAIN) (MODE) (CLR) (LOAD) (SOLVE)
  
```

(c)

```

(MAIN) (MODE) (SYSTEM) (STO) (IF) (FND)
  
```

(d)

■ FIGURE A2.1 Screen sequence for solving Eqs. [1] to [3] as seen on a TI-84 running the Simultaneous Equation Solver application.

pressing **NEXT**, we are presented with a screen similar to that shown in Fig. A2.1c. After we have finished entering all coefficients, pressing the **SOLVE** button yields the Solution screen depicted in Fig. A2.1d. Since we did not name the variables, a slight mental conversion is required to realize  $X_1 = v_1$ ,  $X_2 = v_2$ , etc.

It should be noted that each calculator capable of solving simultaneous equations has its own procedure for entering the required information—therefore, it is a good idea not to throw away anything marked “Owner’s Manual” or “Instructions,” no matter how tempting such an action might be.

## Matrices

Another powerful approach to the solution of a system of equations is based on the concept of matrices. Consider Eqs. [1], [2], and [3]. The array of the constant coefficients of the equations,

$$\mathbf{G} = \begin{bmatrix} 7 & -3 & -4 \\ -3 & 6 & -2 \\ -4 & -2 & 11 \end{bmatrix}$$

is called a **matrix**; the symbol **G** has been selected since each element of the matrix is a conductance value. A matrix itself has no “value”; it is merely an ordered array of elements. We use a letter in boldface type to represent a matrix, and we enclose the array itself by square brackets.

A matrix having  $m$  rows and  $n$  columns is called an  $(m \times n)$  (pronounced “ $m$  by  $n$ ”) matrix. Thus,

$$\mathbf{A} = \begin{bmatrix} 2 & 0 & 5 \\ -1 & 6 & 3 \end{bmatrix}$$

is a  $(2 \times 3)$  matrix, and the **G** matrix of our example is a  $(3 \times 3)$  matrix. An  $(n \times n)$  matrix is a **square matrix** of order  $n$ .

An  $(m \times 1)$  matrix is called a **column matrix**, or a **vector**. Thus,

$$\mathbf{V} = \begin{bmatrix} \mathbf{V}_1 \\ \mathbf{V}_2 \end{bmatrix}$$

is a  $(2 \times 1)$  column matrix of phasor voltages, and

$$\mathbf{I} = \begin{bmatrix} \mathbf{I}_1 \\ \mathbf{I}_2 \end{bmatrix}$$

is a  $(2 \times 1)$  phasor-current vector. A  $(1 \times n)$  matrix is known as a **row vector**.

Two  $(m \times n)$  matrices are equal if their corresponding elements are equal. Thus, if  $a_{jk}$  is that element of **A** located in row  $j$  and column  $k$  and  $b_{jk}$  is the element at row  $j$  and column  $k$  in matrix **B**, then  $\mathbf{A} = \mathbf{B}$  if and only if  $a_{jk} = b_{jk}$  for all  $1 \leq j \leq m$  and  $1 \leq k \leq n$ . Thus, if

$$\begin{bmatrix} \mathbf{V}_1 \\ \mathbf{V}_2 \end{bmatrix} = \begin{bmatrix} \mathbf{z}_{11}\mathbf{I}_1 + \mathbf{z}_{12}\mathbf{I}_2 \\ \mathbf{z}_{21}\mathbf{I}_1 + \mathbf{z}_{22}\mathbf{I}_2 \end{bmatrix}$$

then  $\mathbf{V}_1 = \mathbf{z}_{11}\mathbf{I}_1 + \mathbf{z}_{12}\mathbf{I}_2$  and  $\mathbf{V}_2 = \mathbf{z}_{21}\mathbf{I}_1 + \mathbf{z}_{22}\mathbf{I}_2$ .

Two  $(m \times n)$  matrices may be added by adding corresponding elements. Thus,

$$\begin{bmatrix} 2 & 0 & 5 \\ -1 & 6 & 3 \end{bmatrix} + \begin{bmatrix} 1 & 2 & 3 \\ -3 & -2 & -1 \end{bmatrix} = \begin{bmatrix} 3 & 2 & 8 \\ -4 & 4 & 2 \end{bmatrix}$$

Next let us consider the matrix product  $\mathbf{AB}$ , where  $\mathbf{A}$  is an  $(m \times n)$  matrix and  $\mathbf{B}$  is a  $(p \times q)$  matrix. If  $n = p$ , the matrices are said to be *conformal*, and their product exists. That is, matrix multiplication is defined only for the case where the number of columns of the first matrix in the product is equal to the number of rows in the second matrix.

The formal definition of matrix multiplication states that the product of the  $(m \times n)$  matrix  $\mathbf{A}$  and the  $(n \times q)$  matrix  $\mathbf{B}$  is an  $(m \times q)$  matrix having elements  $c_{jk}$ ,  $1 \leq j \leq m$  and  $1 \leq k \leq q$ , where

$$c_{jk} = a_{j1}b_{1k} + a_{j2}b_{2k} + \cdots + a_{jn}b_{nk}$$

That is, to find the element in the second row and third column of the product, we multiply each of the elements in the second row of  $\mathbf{A}$  by the corresponding element in the third column of  $\mathbf{B}$  and then add the  $n$  results. For example, given the  $(2 \times 3)$  matrix  $\mathbf{A}$  and the  $(3 \times 2)$  matrix  $\mathbf{B}$ ,

$$\begin{bmatrix} a_{11} & a_{12} & a_{13} \\ a_{21} & a_{22} & a_{23} \end{bmatrix} \begin{bmatrix} b_{11} & b_{12} \\ b_{21} & b_{22} \\ b_{31} & b_{32} \end{bmatrix} = \begin{bmatrix} (a_{11}b_{11} + a_{12}b_{21} + a_{13}b_{31}) & (a_{11}b_{12} + a_{12}b_{22} + a_{13}b_{32}) \\ (a_{21}b_{11} + a_{22}b_{21} + a_{23}b_{31}) & (a_{21}b_{12} + a_{22}b_{22} + a_{23}b_{32}) \end{bmatrix}$$

The result is a  $(2 \times 2)$  matrix.

As a numerical example of matrix multiplication, we take

$$\begin{bmatrix} 3 & 2 & 1 \\ -2 & -2 & 4 \end{bmatrix} \begin{bmatrix} 2 & 3 \\ -2 & -1 \\ 4 & -3 \end{bmatrix} = \begin{bmatrix} 6 & 4 \\ 16 & -16 \end{bmatrix}$$

where  $6 = (3)(2) + (2)(-2) + (1)(4)$ ,  $4 = (3)(3) + (2)(-1) + (1)(-3)$ , and so forth.

Matrix multiplication is not commutative. For example, given the  $(3 \times 2)$  matrix  $\mathbf{C}$  and the  $(2 \times 1)$  matrix  $\mathbf{D}$ , it is evident that the product  $\mathbf{CD}$  may be calculated, but the product  $\mathbf{DC}$  is not even defined.

As a final example, let

$$\mathbf{t}_A = \begin{bmatrix} 2 & 3 \\ -1 & 4 \end{bmatrix}$$

and

$$\mathbf{t}_B = \begin{bmatrix} 3 & 1 \\ 5 & 0 \end{bmatrix}$$

so that both  $\mathbf{t}_A\mathbf{t}_B$  and  $\mathbf{t}_B\mathbf{t}_A$  are defined. However,

$$\mathbf{t}_A\mathbf{t}_B = \begin{bmatrix} 21 & 2 \\ 17 & -1 \end{bmatrix}$$

while

$$\mathbf{t}_B \mathbf{t}_A = \begin{bmatrix} 5 & 13 \\ 10 & 15 \end{bmatrix}$$

### PRACTICE

A2.1 Given  $\mathbf{A} = \begin{bmatrix} 1 & -3 \\ 3 & 5 \end{bmatrix}$ ,  $\mathbf{B} = \begin{bmatrix} 4 & -1 \\ -2 & 3 \end{bmatrix}$ ,  $\mathbf{C} = \begin{bmatrix} 50 \\ 30 \end{bmatrix}$ , and  $\mathbf{V} = \begin{bmatrix} \mathbf{V}_1 \\ \mathbf{V}_2 \end{bmatrix}$ , find (a)  $\mathbf{A} + \mathbf{B}$ ; (b)  $\mathbf{AB}$ ; (c)  $\mathbf{BA}$ ; (d)  $\mathbf{AV} + \mathbf{BC}$ ; (e)  $\mathbf{A}^2 = \mathbf{AA}$ .

Ans:  $\begin{bmatrix} 5 & -4 \\ 1 & 8 \end{bmatrix}$ ;  $\begin{bmatrix} 10 & -10 \\ 2 & 12 \end{bmatrix}$ ;  $\begin{bmatrix} 1 & -17 \\ 7 & 21 \end{bmatrix}$ ;  $\begin{bmatrix} \mathbf{V}_1 - 3\mathbf{V}_2 + 170 \\ 3\mathbf{V}_1 + 5\mathbf{V}_2 - 10 \end{bmatrix}$ ;  $\begin{bmatrix} -8 & -18 \\ 18 & 16 \end{bmatrix}$ .

## Matrix Inversion

If we write our system of equations using matrix notation,

$$\begin{bmatrix} 7 & -3 & -4 \\ -3 & 6 & -2 \\ -4 & -2 & 11 \end{bmatrix} \begin{bmatrix} v_1 \\ v_2 \\ v_3 \end{bmatrix} = \begin{bmatrix} -11 \\ 3 \\ 25 \end{bmatrix} \quad [4]$$

we may solve for the voltage vector by multiplying both sides of Eq. [4] by the inverse of our matrix  $\mathbf{G}$ :

$$\mathbf{G}^{-1} \begin{bmatrix} 7 & -3 & -4 \\ -3 & 6 & -2 \\ -4 & -2 & 11 \end{bmatrix} \begin{bmatrix} v_1 \\ v_2 \\ v_3 \end{bmatrix} = \mathbf{G}^{-1} \begin{bmatrix} -11 \\ 3 \\ 25 \end{bmatrix} \quad [5]$$

This procedure makes use of the identity  $\mathbf{G}^{-1}\mathbf{G} = \mathbf{I}$ , where  $\mathbf{I}$  is the identity matrix, a square matrix of the same size as  $\mathbf{G}$ , with zeros everywhere except on the diagonal. Each element on the diagonal of an identity matrix is unity. Thus, Eq. [5] becomes

$$\begin{bmatrix} 1 & 0 & 0 \\ 0 & 1 & 0 \\ 0 & 0 & 1 \end{bmatrix} \begin{bmatrix} v_1 \\ v_2 \\ v_3 \end{bmatrix} = \mathbf{G}^{-1} \begin{bmatrix} -11 \\ 3 \\ 25 \end{bmatrix}$$

which may be simplified to

$$\begin{bmatrix} v_1 \\ v_2 \\ v_3 \end{bmatrix} = \mathbf{G}^{-1} \begin{bmatrix} -11 \\ 3 \\ 25 \end{bmatrix}$$

since the identity matrix times any vector is simply equal to that vector (the proof is left to the reader as a 30-second exercise). The solution of our system of equations has therefore been transformed into the problem of obtaining the inverse matrix of  $\mathbf{G}$ . Many scientific calculators provide the means of performing matrix algebra.



Returning to the TI-84, we press **2ND** and **MATRIX** to obtain the screen shown in Fig. A2.2a. Scrolling horizontally to **EDIT**, we press the **ENTER** key, and select a  $3 \times 3$  matrix, resulting in a screen similar to that shown in Fig. A2.2b. Once we have finished entering the matrix, we press **2ND** and **QUIT**. Returning to the **MATRIX** editor, we create a  $3 \times 1$  vector named **B**, as shown in Fig. A2.2c. We are now (finally) ready to solve for the solution vector. Pressing **2ND** and **MATRIX**, under **NAMES** we select **[A]** and press **ENTER**, followed by the  $x^{-1}$  key. Next, we select **[B]** the same way (we could have pressed the multiplication key in between but it is not necessary). The result of our calculation is shown in Fig. A2.2d, and agrees with our earlier exercise.

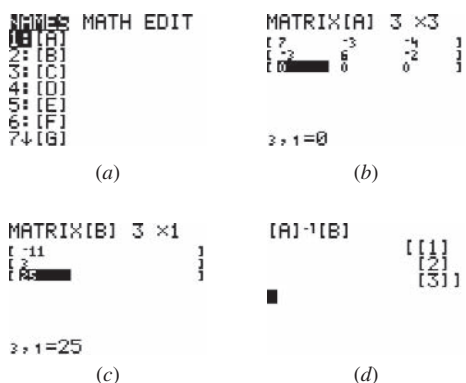

■ FIGURE A2.2 Sequence of screens for matrix solution. (a) Matrix editor screen; (b) entering terms; (c) creating right-hand side vector; (d) solving matrix equation.

## Determinants

Although a matrix *itself* has no “value,” the *determinant* of a square matrix *does* have a value. To be precise, we should say that the determinant of a matrix is a value, but common usage enables us to speak of both the array itself and its value as the determinant. We shall symbolize a determinant by  $\Delta$ , and employ a suitable subscript to denote the matrix to which the determinant refers. Thus,

$$\Delta_G = \begin{vmatrix} 7 & -3 & -4 \\ -3 & 6 & -2 \\ -4 & -2 & 11 \end{vmatrix}$$

Note that simple vertical lines are used to enclose the determinant.

The value of any determinant is obtained by expanding it in terms of its minors. To do this, we select any row  $j$  or any column  $k$ , multiply each element in that row or column by its minor and by  $(-1)^{j+k}$ , and then add the products. The minor of the element appearing in both row  $j$  and column  $k$

is the determinant obtained when row  $j$  and column  $k$  are removed; it is indicated by  $\Delta_{jk}$ .

As an example, let us expand the determinant  $\Delta_G$  along column 3. We first multiply the  $(-4)$  at the top of this column by  $(-1)^{1+3} = 1$  and then by its minor:

$$(-4)(-1)^{1+3} \begin{vmatrix} -3 & 6 \\ -4 & -2 \end{vmatrix}$$

and then repeat for the other two elements in column 3, adding the results:

$$-4 \begin{vmatrix} -3 & 6 \\ -4 & -2 \end{vmatrix} + 2 \begin{vmatrix} 7 & -3 \\ -4 & -2 \end{vmatrix} + 11 \begin{vmatrix} 7 & -3 \\ -3 & 6 \end{vmatrix}$$

The minors contain only two rows and two columns. They are of order 2, and their values are easily determined by expanding in terms of minors again, here a trivial operation. Thus, for the first determinant, we expand along the first column by multiplying  $(-3)$  by  $(-1)^{1+1}$  and its minor, which is merely the element  $(-2)$ , and then multiplying  $(-4)$  by  $(-1)^{2+1}$  and by 6. Thus,

$$\begin{vmatrix} -3 & 6 \\ -4 & -2 \end{vmatrix} = (-3)(-2) - 4(-6) = 30$$

It is usually easier to remember the result for a second-order determinant as “upper left times lower right minus upper right times lower left.” Finally,

$$\begin{aligned} \Delta_G &= -4[(-3)(-2) - 6(-4)] \\ &\quad + 2[(7)(-2) - (-3)(-4)] \\ &\quad + 11[(7)(6) - (-3)(-3)] \\ &= -4(30) + 2(-26) + 11(33) \\ &= 191 \end{aligned}$$

For practice, let us expand this same determinant along the first row:

$$\begin{aligned} \Delta_G &= 7 \begin{vmatrix} 6 & -2 \\ -2 & 11 \end{vmatrix} - (-3) \begin{vmatrix} -3 & -2 \\ -4 & 11 \end{vmatrix} + (-4) \begin{vmatrix} -3 & 6 \\ -4 & -2 \end{vmatrix} \\ &= 7(62) + 3(-41) - 4(30) \\ &= 191 \end{aligned}$$

The expansion by minors is valid for a determinant of any order.

Repeating these rules for evaluating a determinant in more general terms, we would say, given a matrix  $\mathbf{a}$ ,

$$\mathbf{a} = \begin{bmatrix} a_{11} & a_{12} & \dots & a_{1N} \\ a_{21} & a_{22} & \dots & a_{2N} \\ \dots & \dots & \dots & \dots \\ a_{N1} & a_{N2} & \dots & a_{NN} \end{bmatrix}$$

that  $\Delta_a$  may be obtained by expansion in terms of minors along any row  $j$ :

$$\begin{aligned} \Delta_a &= a_{j1}(-1)^{j+1} \Delta_{j1} + a_{j2}(-1)^{j+2} \Delta_{j2} + \dots + a_{jN}(-1)^{j+N} \Delta_{jN} \\ &= \sum_{n=1}^N a_{jn}(-1)^{j+n} \Delta_{jn} \end{aligned}$$

or along any column  $k$ :

$$\begin{aligned}\Delta_a &= a_{1k}(-1)^{1+k} \Delta_{1k} + a_{2k}(-1)^{2+k} \Delta_{2k} + \cdots + a_{Nk}(-1)^{N+k} \Delta_{Nk} \\ &= \sum_{n=1}^N a_{nk}(-1)^{n+k} \Delta_{nk}\end{aligned}$$

The cofactor  $C_{jk}$  of the element appearing in both row  $j$  and column  $k$  is simply  $(-1)^{j+k}$  times the minor  $\Delta_{jk}$ . Thus,  $C_{11} = \Delta_{11}$ , but  $C_{12} = -\Delta_{12}$ . We may now write

$$\Delta_a = \sum_{n=1}^N a_{jn} C_{jn} = \sum_{n=1}^N a_{nk} C_{nk}$$

As an example, let us consider this fourth-order determinant:

$$\Delta = \begin{vmatrix} 2 & -1 & -2 & 0 \\ -1 & 4 & 2 & -3 \\ -2 & -1 & 5 & -1 \\ 0 & -3 & 3 & 2 \end{vmatrix}$$

We find

$$\Delta_{11} = \begin{vmatrix} 4 & 2 & -3 \\ -1 & 5 & -1 \\ -3 & 3 & 2 \end{vmatrix} = 4(10 + 3) + 1(4 + 9) - 3(-2 + 15) = 26$$

$$\Delta_{12} = \begin{vmatrix} -1 & 2 & -3 \\ -2 & 5 & -1 \\ 0 & 3 & 2 \end{vmatrix} = -1(10 + 3) + 2(4 + 9) + 0 = 13$$

and  $C_{11} = 26$ , whereas  $C_{12} = -13$ . Finding the value of  $\Delta$  for practice, we have

$$\begin{aligned}\Delta &= 2C_{11} + (-1)C_{12} + (-2)C_{13} + 0 \\ &= 2(26) + (-1)(-13) + (-2)(3) + 0 = 59\end{aligned}$$

## Cramer's Rule

We next consider Cramer's rule, which enables us to find the values of the unknown variables. It is also useful in solving systems of equations where numerical coefficients have not yet been specified, thus confounding our calculators. Let us again consider Eqs. [1], [2], and [3]; we define the determinant  $\Delta_1$  as that determinant which is obtained when the first column of  $\Delta_G$  is replaced by the three constants on the right-hand sides of the three equations. Thus,

$$\Delta_1 = \begin{vmatrix} -11 & -3 & -4 \\ 3 & 6 & -2 \\ 25 & -2 & 11 \end{vmatrix}$$

We expand along the first column:

$$\begin{aligned}\Delta_1 &= -11 \begin{vmatrix} 6 & -2 \\ -2 & 11 \end{vmatrix} - 3 \begin{vmatrix} -3 & -4 \\ -2 & 11 \end{vmatrix} + 25 \begin{vmatrix} -3 & -4 \\ 6 & -2 \end{vmatrix} \\ &= -682 + 123 + 750 = 191\end{aligned}$$

Cramer's rule then states that

$$v_1 = \frac{\Delta_1}{\Delta_G} = \frac{191}{191} = 1 \text{ V}$$

and

$$v_2 = \frac{\Delta_2}{\Delta_G} = \frac{\begin{vmatrix} 7 & -11 & -4 \\ -3 & 3 & -2 \\ -4 & 25 & 11 \end{vmatrix}}{191} = \frac{581 - 63 - 136}{191} = 2 \text{ V}$$

and finally,

$$v_3 = \frac{\Delta_3}{\Delta_G} = \frac{\begin{vmatrix} 7 & -3 & -11 \\ -3 & 6 & 3 \\ -4 & -2 & 25 \end{vmatrix}}{191} = \frac{1092 - 291 - 228}{191} = 3 \text{ V}$$

Cramer's rule is applicable to a system of  $N$  simultaneous linear equations in  $N$  unknowns; for the  $i$ th variable  $v_i$ :

$$v_i = \frac{\Delta_i}{\Delta_G}$$

### PRACTICE

A2.2 Evaluate

$$(a) \begin{vmatrix} 2 & -3 \\ -2 & 5 \end{vmatrix}; (b) \begin{vmatrix} 1 & -1 & 0 \\ 4 & 2 & -3 \\ 3 & -2 & 5 \end{vmatrix}; (c) \begin{vmatrix} 2 & -3 & 1 & 5 \\ -3 & 1 & -1 & 0 \\ 0 & 4 & 2 & -3 \\ 6 & 3 & -2 & 5 \end{vmatrix};$$

(d) Find  $i_2$  if  $5i_1 - 2i_2 - i_3 = 100$ ,  $-2i_1 + 6i_2 - 3i_3 - i_4 = 0$ ,  $-i_1 - 3i_2 + 4i_3 - i_4 = 0$ , and  $-i_2 - i_3 = 0$ .

Ans: 4; 33; -411; 1.266.

## A PROOF OF THÉVENIN'S THEOREM

Here we prove Thévenin's theorem in the same form in which it is stated in Sec. 5.4 of Chap. 5:

Given any linear circuit, rearrange it in the form of two networks  $A$  and  $B$  connected by two wires. Define a voltage  $v_{oc}$  as the open-circuit voltage which appears across the terminals of  $A$  when  $B$  is disconnected. Then all currents and voltages in  $B$  will remain unchanged if all *independent* voltage and current sources in  $A$  are “killed” or “zeroed out,” and an independent voltage source  $v_{oc}$  is connected, with proper polarity, in series with the dead (inactive)  $A$  network.

We will effect our proof by showing that the original  $A$  network and the Thévenin equivalent of the  $A$  network both cause the same current to flow into the terminals of the  $B$  network. If the currents are the same, then the voltages must be the same; in other words, if we apply a certain current, which we might think of as a current source, to the  $B$  network, then the current source and the  $B$  network constitute a circuit that has a specific input voltage as a response. Thus, the current determines the voltage. Alternatively we could, if we wished, show that the terminal voltage at  $B$  is unchanged, because the voltage also determines the current uniquely. If the input voltage and current to the  $B$  network are unchanged, then it follows that the currents and voltages *throughout* the  $B$  network are also unchanged.

Let us first prove the theorem for the case where the  $B$  network is inactive (no independent sources). After this step has been accomplished, we may then use the superposition principle to extend the theorem to include  $B$  networks that contain independent sources. Each network may contain dependent sources, provided that their control variables are in the same network.

The current  $i$ , flowing in the upper conductor from the  $A$  network to the  $B$  network in Fig. A3.1a, is therefore caused entirely by the independent

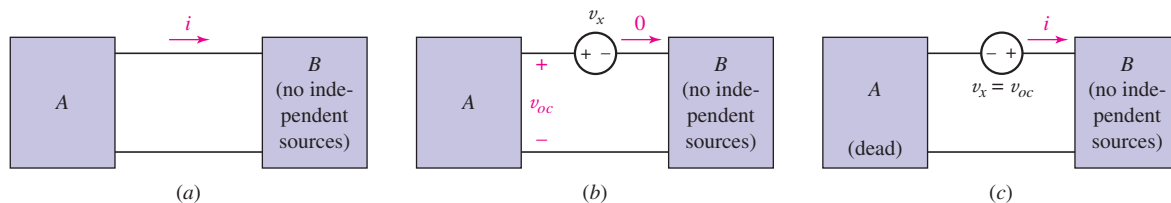

■ FIGURE A3.1 (a) A general linear network  $A$  and a network  $B$  that contains no independent sources. Controls for dependent sources must appear in the same part of the network. (b) The Thévenin source is inserted in the circuit and adjusted until  $i = 0$ . No voltage appears across network  $B$  and thus  $v_x = v_{oc}$ . The Thévenin source thus produces a current  $-i$  while network  $A$  provides  $i$ . (c) The Thévenin source is reversed and network  $A$  is killed. The current is therefore  $i$ .

sources present in the  $A$  network. Suppose now that we add an additional voltage source  $v_x$ , which we shall call the Thévenin source, in the conductor in which  $i$  is measured, as shown in Fig. A3.1*b*, and then adjust the magnitude and time variation of  $v_x$  until the current is reduced to zero. By our definition of  $v_{oc}$ , then, the voltage across the terminals of  $A$  must be  $v_{oc}$ , since  $i = 0$ . Network  $B$  contains no independent sources, and no current is entering its terminals; therefore, there is no voltage across the terminals of the  $B$  network, and by Kirchhoff's voltage law the voltage of the Thévenin source is  $v_{oc}$  volts,  $v_x = v_{oc}$ . Moreover, since the Thévenin source and the  $A$  network jointly deliver no current to  $B$ , and since the  $A$  network by itself delivers a current  $i$ , superposition requires that the Thévenin source acting by itself must deliver a current of  $-i$  to  $B$ . The source acting alone in a reversed direction, as shown in Fig. A3.1*c*, therefore produces a current  $i$  in the upper lead. This situation, however, is the same as the conclusion reached by Thévenin's theorem: the Thévenin source  $v_{oc}$  acting in series with the inactive  $A$  network is equivalent to the given network.

Now let us consider the case where the  $B$  network may be an active network. We now think of the current  $i$ , flowing from the  $A$  network to the  $B$  network in the upper conductor, as being composed of two parts,  $i_A$  and  $i_B$ , where  $i_A$  is the current produced by  $A$  acting alone and the current  $i_B$  is due to  $B$  acting alone. Our ability to divide the current into these two components is a direct consequence of the applicability of the superposition principle to these two *linear* networks; the complete response and the two partial responses are indicated by the diagrams of Fig. A3.2.

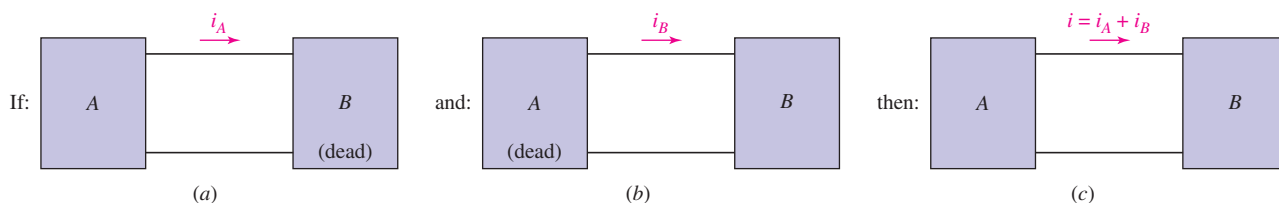

■ FIGURE A3.2 Superposition enables the current  $i$  to be considered as the sum of two partial responses.

The partial response  $i_A$  has already been considered; if network  $B$  is inactive, we know that network  $A$  may be replaced by the Thévenin source and the inactive  $A$  network. In other words, of the three sources which we must keep in mind—those in  $A$ , those in  $B$ , and the Thévenin source—the partial response  $i_A$  occurs when  $A$  and  $B$  are dead and the Thévenin source is active. Preparing for the use of superposition, we now let  $A$  remain inactive, but turn on  $B$  and turn off the Thévenin source; by definition, the partial response  $i_B$  is obtained. Superimposing the results, the response when  $A$  is dead and both the Thévenin source and  $B$  are active is  $i_A + i_B$ . This sum is the original current  $i$ , and the situation wherein the Thévenin source and  $B$  are active but  $A$  is dead is the desired Thévenin equivalent circuit. Thus the active network  $A$  may be replaced by its Thévenin source, the open-circuit voltage, in series with the inactive  $A$  network, regardless of the status of the  $B$  network; it may be either active or inactive.

## A PSpice® TUTORIAL

SPICE is an acronym for Simulation Program with Integrated Circuit Emphasis. A powerful program, it is an industry standard and used throughout the world for a variety of circuit analysis applications. SPICE was originally developed in the early 1970s by Donald O. Peterson and coworkers at the University of California at Berkeley. Interestingly, Peterson advocated free and unhindered distribution of knowledge created in university labs, choosing to make an impact as opposed to profiting financially. In 1984, MicroSim Corporation introduced a PC version of SPICE called PSpice®, which built intuitive graphical interfaces around the core SPICE software routines. There are now several variations of SPICE available commercially, as well as competing software products.

The goal of this appendix is to simply introduce the basics of computer-aided circuit analysis; more details are presented in the main text as well as in the references listed under Reading Further. Advanced topics covered in the references include how to determine the sensitivity of an output variable to changes in a specific component value; how to obtain plots of the output versus a source value; determining ac output as a function of source frequency; methods for performing noise and distortion analyses; nonlinear component models; and how to model temperature effects on specific types of circuits.

The acquisition of MicroSim by OrCAD, and the subsequent acquisition of OrCAD by Cadence, has led to quite a few changes in this popular circuit simulation package. At the time of this writing, OrCAD Capture CIS-Demo 16.3, is the current professional release; a scaled-back version is available for free download ([www.cadence.com](http://www.cadence.com)). This new version replaces the popular PSpice Student Release 9.1, and although slightly different, particularly in terms of the schematic editing, should seem generally familiar to users of previous PSpice releases.

The documentation which accompanies the demo version of OrCAD 16.3 lists several restrictions that do not apply to the professional (commercially available) version. The most significant is that only circuits having 60 or fewer parts may be saved and simulated; larger circuits can be drawn and viewed, however. We have chosen to work with the OrCAD Capture schematics editor, as the current version is very similar fundamentally to the PSpice A/D Schematic Capture editor. Although at present Cadence also provides PSpice A/D for download, it is no longer supported.

### Getting Started

A computer-aided circuit analysis consists of three separate steps: (1) drawing the schematic, (2) simulating the circuit, and (3) extracting the desired information from the simulation output. The OrCAD Capture schematic

editor is launched through the Windows programs list found under the  menu; upon selecting OrCAD Capture CIS-Demo, the schematics editor opens, as shown in Fig. A4.1.

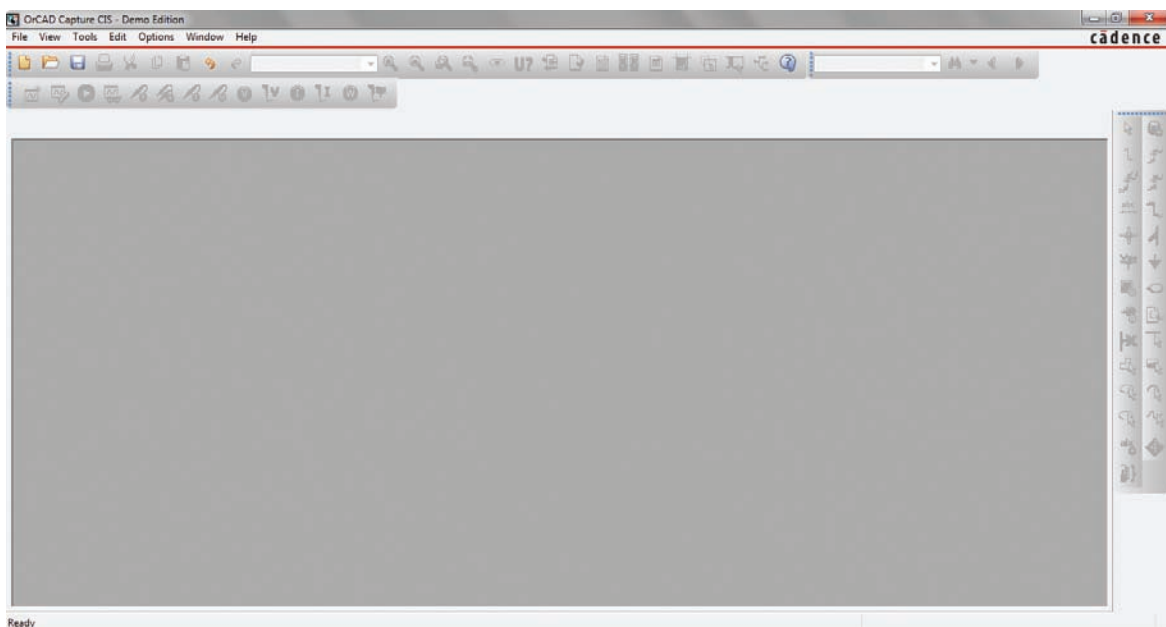

■ FIGURE A4.1 Capture CIS-Demo window.

Under the **File** menu, select **New**, then **Project**; the window of Fig. A4.2a appears. After providing a simulation filename and a directory path, the window of Fig. A4.2b appears (simply select the “blank project” option). We are now presented with the main schematics editor window, as in Fig. A4.3.

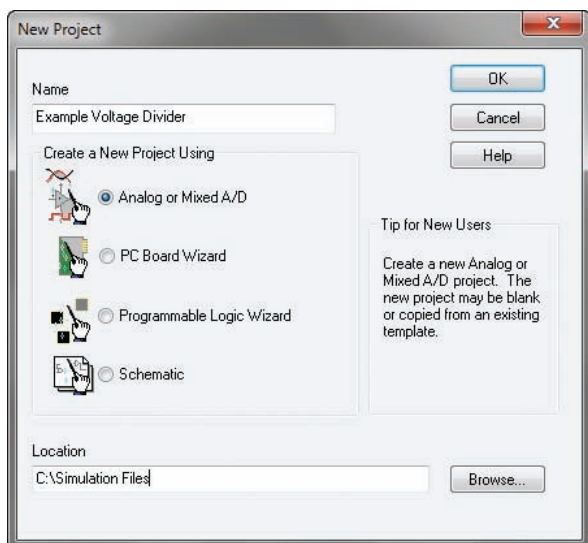

(a)

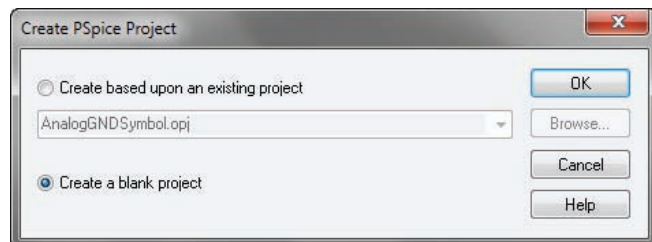

(b)

■ FIGURE A4.2 (a) New Project window. (b) Create PSpice Project window.



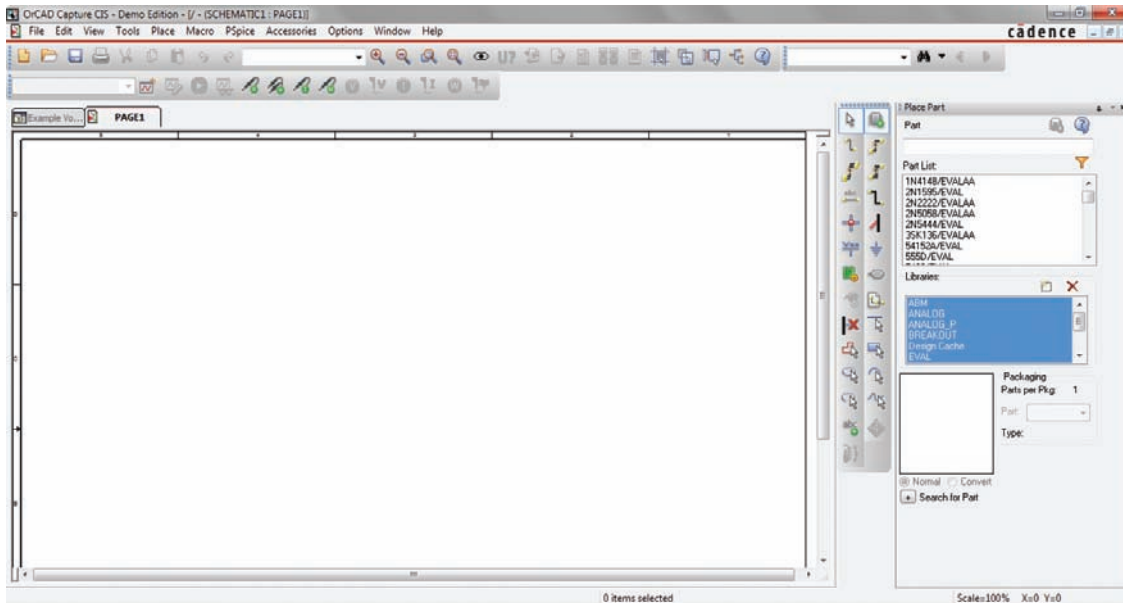

■ FIGURE A4.3 Main Capture CIS-Demo schematics page.

At this point, we're ready to draw a circuit, so let's try a simple voltage divider for purposes of illustration. We will first place the necessary components on the grid, and then wire them together.

Pulling down the **Place** menu, we choose **Part**. Typing a lowercase “r” as shown, we click OK and are now able to move a resistor symbol around the schematic window using the mouse. A single left click places a resistor (named R1) at the mouse location; a second left click places a second resistor on our schematic (named R2). A single right click and selecting **End Mode** cancel further resistor placements. The second resistor does not have the appropriate orientation, but is easily manipulated by highlighting it with a single right click, then selecting **Rotate**. If we do not know the name of the desired part, we can browse through the library of parts provided. If 1 k $\Omega$  resistors are not desired—for example, perhaps two 500  $\Omega$  resistors were called for—we change the default values simply by double-clicking the “1k” next to the appropriate symbol.

No voltage divider circuit is complete of course without a voltage source (**vsrc**). Double-clicking **DC=**, we choose a value of 9 V for our source. One further component is required: SPICE requires a reference (or ground) node to be specified. Clicking the GND symbol to the far right of the schematic window, we choose 0/Source from the options. Our progress so far is shown in Fig. A4.4a; all that remains is to wire the components together. This is accomplished by selecting the **Place wire (W)** icon. The left and right mouse keys control each wire (some experimenting is called for here—afterward, select any unwanted wire segments and hit the Delete key). Our final circuit is shown in Fig. A4.4b. It is worth noting that the editor will allow the user to wire through a resistor (thus shorting it out), which can be difficult to see. Generally a warning symbol appears before wiring to an inappropriate location.

Prior to simulating our circuit, we save it by clicking the save icon or selecting **Save** from the **File** menu. From the **PSpice** menu, we select **New Simulation Profile**, and type Voltage Divider in the dialog box that appears.

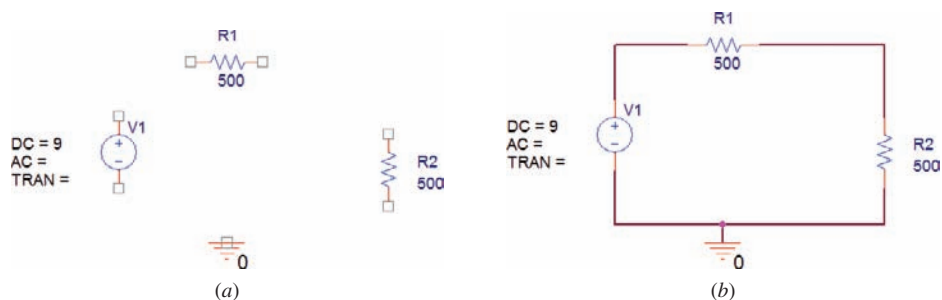

■ FIGURE A4.4 (a) Parts placed on the grid. (b) Fully wired circuit, ready to simulate.

The Simulation Settings dialog box that appears allows us to set parameters for a variety of types of simulations; for the present example we need to select **Bias Point** under the **Analysis type** menu. Once again pulling down the **PSpice** menu, we select **Run**. The simulation results are shown in Fig. A4.5.

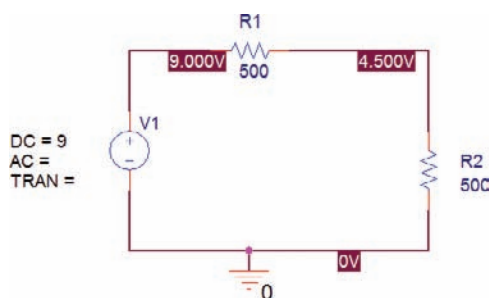

■ FIGURE A4.5 Simulation results.

Fortunately, our simulation yields the expected result—an even split of our source voltage across the two equal-valued resistors. We can also view the simulation results by selecting **View Output File** under the **PSpice** menu. Scrolling down to the end of this file, we see the following lines:

NODE	VOLTAGE	NODE	VOLTAGE
(N00109)	9.0000	(N00116)	4.5000

where node 109 is the positive reference of our voltage source, and node 116 is the junction between the two resistors. This information is available at the top of the file.

## READING FURTHER

Two very good books devoted to SPICE and PSpice simulation are:

P. W. Tuinenga, *SPICE: A Guide to Circuit Simulation and Analysis Using PSpice*. Englewood Cliffs, N.J.: Prentice-Hall, 1995.

R. W. Goody, *OrCAD PSpice for Windows Volume 1: DC and AC Circuits*, 3rd ed. Englewood Cliffs, N.J.: Prentice-Hall, 2001.

An interesting history of circuit simulators, as well as Donald Peterson's contributions to the field, can be found in:

T. Perry, "Donald O. Peterson [electronic engineering biography]," *IEEE Spectrum* **35** (1998) 22–27.

## COMPLEX NUMBERS

This appendix includes sections covering the definition of a complex number, the basic arithmetic operations for complex numbers, Euler's identity, and the exponential and polar forms of the complex number. We first introduce the concept of a complex number.

### A5.1 THE COMPLEX NUMBER

Our early training in mathematics dealt exclusively with real numbers, such as 4,  $-\frac{2}{7}$ , and  $\pi$ . Soon, however, we began to encounter algebraic equations, such as  $x^2 = -3$ , which could not be satisfied by any real number. Such an equation can be solved only through the introduction of the *imaginary unit*, or the *imaginary operator*, which we shall designate by the symbol  $j$ . By definition,  $j^2 = -1$ , and thus  $j = \sqrt{-1}$ ,  $j^3 = -j$ ,  $j^4 = 1$ , and so forth. The product of a real number and the imaginary operator is called an *imaginary number*; and the sum of a real number and an imaginary number is called a *complex number*. Thus, a number having the form  $a + jb$ , where  $a$  and  $b$  are real numbers, is a complex number.

We shall designate a complex number by means of a special single symbol; thus,  $\mathbf{A} = a + jb$ . The complex nature of the number is indicated by the use of boldface type; in handwritten material, a bar over the letter is customary. The complex number  $\mathbf{A}$  just shown is described as having a *real component* or *real part*  $a$  and an *imaginary component* or *imaginary part*  $b$ . This is also expressed as

$$\operatorname{Re}\{\mathbf{A}\} = a \quad \operatorname{Im}\{\mathbf{A}\} = b$$

The imaginary component of  $\mathbf{A}$  is *not*  $jb$ . By definition, the imaginary component is a real number.

It should be noted that all real numbers may be regarded as complex numbers having imaginary parts equal to zero. The real numbers are therefore included in the system of complex numbers, and we may now consider them as a special case. When we define the fundamental arithmetic operations for complex numbers, we should therefore expect them to reduce to the corresponding definitions for real numbers if the imaginary part of every complex number is set equal to zero.

Since any complex number is completely characterized by a pair of real numbers, such as  $a$  and  $b$  in the previous example, we can obtain some visual assistance by representing a complex number graphically on a rectangular, or Cartesian, coordinate system. By providing ourselves with a real axis and an imaginary axis, as shown in Fig. A5.1, we form a *complex plane*, or *Argand diagram*, on which any complex number can be represented as a single point. The complex numbers  $\mathbf{M} = 3 + j1$  and  $\mathbf{N} = 2 - j2$

Mathematicians designate the imaginary operator by the symbol  $i$ , but it is customary to use  $j$  in electrical engineering in order to avoid confusion with the symbol for current.

The choice of the words *imaginary* and *complex* is unfortunate. They are used here and in the mathematical literature as technical terms to designate a class of numbers. To interpret imaginary as "not pertaining to the physical world" or complex as "complicated" is neither justified nor intended.

are indicated. It is important to understand that this complex plane is only a visual aid; it is not at all essential to the mathematical statements which follow.

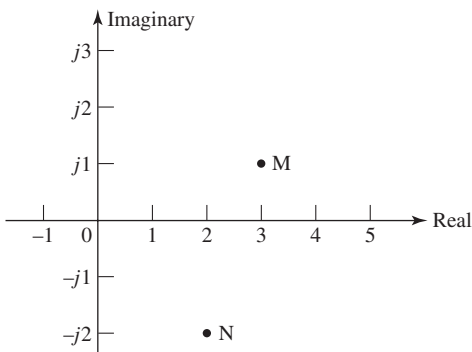

■ FIGURE A5.1 The complex numbers  $\mathbf{M} = 3 + j1$  and  $\mathbf{N} = 2 - j2$  are shown on the complex plane.

We define two complex numbers as being equal if, and only if, their real parts are equal and their imaginary parts are equal. Graphically, then, to each point in the complex plane there corresponds only one complex number, and conversely, to each complex number there corresponds only one point in the complex plane. Thus, suppose we are given the two complex numbers

$$\mathbf{A} = a + jb \quad \text{and} \quad \mathbf{B} = c + jd$$

Then, if

$$\mathbf{A} = \mathbf{B}$$

it is necessary that

$$a = c \quad \text{and} \quad b = d$$

A complex number expressed as the sum of a real number and an imaginary number, such as  $\mathbf{A} = a + jb$ , is said to be in *rectangular* or *cartesian* form. Other forms for a complex number will appear shortly.

Let us now define the fundamental operations of addition, subtraction, multiplication, and division for complex numbers. The sum of two complex numbers is defined as the complex number whose real part is the sum of the real parts of the two complex numbers and whose imaginary part is the sum of the imaginary parts of the two complex numbers. Thus,

$$(a + jb) + (c + jd) = (a + c) + j(b + d)$$

For example,

$$(3 + j4) + (4 - j2) = 7 + j2$$

The difference of two complex numbers is taken in a similar manner; for example,

$$(3 + j4) - (4 - j2) = -1 + j6$$

Addition and subtraction of complex numbers may also be accomplished graphically on the complex plane. Each complex number is represented as a vector, or directed line segment, and the sum is obtained by completing the parallelogram, illustrated by Fig. A5.2a, or by connecting the vectors in a head-to-tail manner, as shown in Fig. A5.2b. A graphical sketch is often useful as a check for a more exact numerical solution.

The product of two complex numbers is defined by

$$(a + jb)(c + jd) = (ac - bd) + j(bc + ad)$$

This result may be easily obtained by a direct multiplication of the two binomial terms, using the rules of the algebra of real numbers, and then simplifying the result by letting  $j^2 = -1$ . For example,

$$\begin{aligned}(3 + j4)(4 - j2) &= 12 - j6 + j16 - 8j^2 \\ &= 12 + j10 + 8 \\ &= 20 + j10\end{aligned}$$

It is easier to multiply the complex numbers by this method, particularly if we immediately replace  $j^2$  by  $-1$ , than it is to substitute in the general formula that defines the multiplication.

Before defining the operation of division for complex numbers, we should define the conjugate of a complex number. The *conjugate* of the complex number  $\mathbf{A} = a + jb$  is  $a - jb$  and is represented as  $\mathbf{A}^*$ . The conjugate of any complex number is therefore easily obtained by merely changing the sign of the imaginary part of the complex number. Thus, if

$$\mathbf{A} = 5 + j3$$

then

$$\mathbf{A}^* = 5 - j3$$

It is evident that the conjugate of any complicated complex expression may be found by replacing every complex term in the expression by its conjugate, which may be obtained by replacing every  $j$  in the expression by  $-j$ .

The definitions of addition, subtraction, and multiplication show that the following statements are true: the sum of a complex number and its conjugate is a real number; the difference of a complex number and its conjugate is an imaginary number; and the product of a complex number and its conjugate is a real number. It is also evident that if  $\mathbf{A}^*$  is the conjugate of  $\mathbf{A}$ , then  $\mathbf{A}$  is the conjugate of  $\mathbf{A}^*$ ; in other words,  $\mathbf{A} = (\mathbf{A}^*)^*$ . A complex number and its conjugate are said to form a *conjugate complex pair* of numbers.

We now define the quotient of two complex numbers:

$$\frac{\mathbf{A}}{\mathbf{B}} = \frac{(\mathbf{A})(\mathbf{B}^*)}{(\mathbf{B})(\mathbf{B}^*)}$$

and thus

$$\frac{a + jb}{c + jd} = \frac{(ac + bd) + j(bc - ad)}{c^2 + d^2}$$

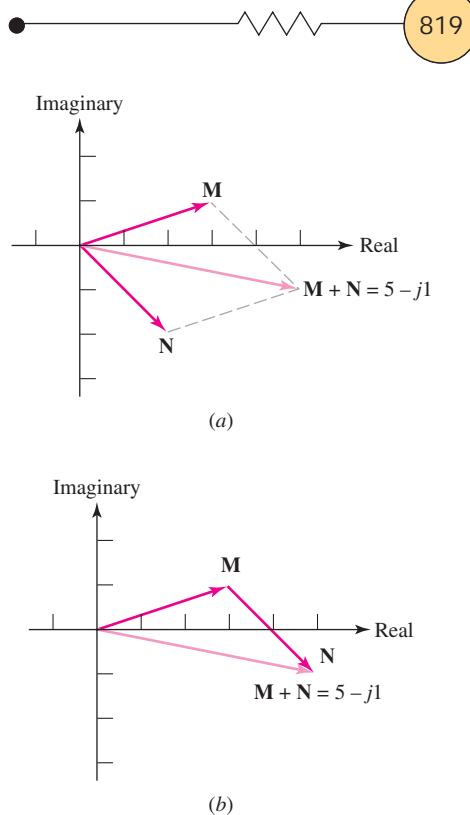

FIGURE A5.2 (a) The sum of the complex numbers  $\mathbf{M} = 3 + j1$  and  $\mathbf{N} = 2 - j2$  is obtained by constructing a parallelogram. (b) The sum of the same two complex numbers is found by a head-to-tail combination.

Inevitably in a physical problem a complex number is somehow accompanied by its conjugate.

We multiply numerator and denominator by the conjugate of the denominator in order to obtain a denominator which is real; this process is called *rationalizing the denominator*. As a numerical example,

$$\begin{aligned}\frac{3 + j4}{4 - j2} &= \frac{(3 + j4)(4 + j2)}{(4 - j2)(4 + j2)} \\ &= \frac{4 + j22}{16 + 4} = 0.2 + j1.1\end{aligned}$$

The addition or subtraction of two complex numbers which are each expressed in rectangular form is a relatively simple operation; multiplication or division of two complex numbers in rectangular form, however, is a rather unwieldy process. These latter two operations will be found to be much simpler when the complex numbers are given in either exponential or polar form. These forms will be introduced in Secs. A5.3 and A5.4.

### PRACTICE

- A5.1 Let  $\mathbf{A} = -4 + j5$ ,  $\mathbf{B} = 3 - j2$ , and  $\mathbf{C} = -6 - j5$ , and find (a)  $\mathbf{C} - \mathbf{B}$ ; (b)  $2\mathbf{A} - 3\mathbf{B} + 5\mathbf{C}$ ; (c)  $j^5\mathbf{C}^2(\mathbf{A} + \mathbf{B})$ ; (d)  $\mathbf{B} \operatorname{Re}\{\mathbf{A}\} + \mathbf{A} \operatorname{Re}\{\mathbf{B}\}$ .  
A5.2 Using the same values for  $\mathbf{A}$ ,  $\mathbf{B}$ , and  $\mathbf{C}$  as in the previous problem, find (a)  $[(\mathbf{A} - \mathbf{A}^*)(\mathbf{B} + \mathbf{B}^*)]^*$ ; (b)  $(1/\mathbf{C}) - (1/\mathbf{B})^*$ ; (c)  $(\mathbf{B} + \mathbf{C})/(2\mathbf{B}\mathbf{C})$ .

Ans: A5.1:  $-9 - j3$ ;  $-47 - j9$ ;  $27 - j191$ ;  $-24 + j23$ . A5.2:  $-j60$ ;  $-0.329 + j0.236$ ;  $0.0662 + j0.1179$ .

## A5.2 EULER'S IDENTITY

In Chap. 9 we encounter functions of time which contain complex numbers, and we are concerned with the differentiation and integration of these functions with respect to the real variable  $t$ . We differentiate and integrate such functions with respect to  $t$  by exactly the same procedures we use for real functions of time. That is, the complex constants are treated just as though they were real constants when performing the operations of differentiation or integration. If  $\mathbf{f}(t)$  is a complex function of time, such as

$$\mathbf{f}(t) = a \cos ct + jb \sin ct$$

then

$$\frac{d\mathbf{f}(t)}{dt} = -ac \sin ct + jbc \cos ct$$

and

$$\int \mathbf{f}(t) dt = \frac{a}{c} \sin ct - j \frac{b}{c} \cos ct + \mathbf{C}$$

where the constant of integration  $\mathbf{C}$  is a complex number in general.

It is sometimes necessary to differentiate or integrate a function of a complex variable with respect to that complex variable. In general, the successful accomplishment of either of these operations requires that the

function which is to be differentiated or integrated satisfy certain conditions. All our functions do meet these conditions, and integration or differentiation with respect to a complex variable is achieved by using methods identical to those used for real variables.

At this time we must make use of a very important fundamental relationship known as Euler's identity (pronounced "oilers"). We shall prove this identity, for it is extremely useful in representing a complex number in a form other than rectangular form.

The proof is based on the power series expansions of  $\cos \theta$ ,  $\sin \theta$ , and  $e^z$ , given toward the back of your favorite college calculus text:

$$\cos \theta = 1 - \frac{\theta^2}{2!} + \frac{\theta^4}{4!} - \frac{\theta^6}{6!} + \dots$$

$$\sin \theta = \theta - \frac{\theta^3}{3!} + \frac{\theta^5}{5!} - \frac{\theta^7}{7!} + \dots$$

or

$$\cos \theta + j \sin \theta = 1 + j\theta - \frac{\theta^2}{2!} - j \frac{\theta^3}{3!} + \frac{\theta^4}{4!} + j \frac{\theta^5}{5!} - \dots$$

and

$$e^z = 1 + z + \frac{z^2}{2!} + \frac{z^3}{3!} + \frac{z^4}{4!} + \frac{z^5}{5!} + \dots$$

so that

$$e^{j\theta} = 1 + j\theta - \frac{\theta^2}{2!} - j \frac{\theta^3}{3!} + \frac{\theta^4}{4!} + \dots$$

We conclude that

$$e^{j\theta} = \cos \theta + j \sin \theta \quad [1]$$

or, if we let  $z = -j\theta$ , we find that

$$e^{-j\theta} = \cos \theta - j \sin \theta \quad [2]$$

By adding and subtracting Eqs. [1] and [2], we obtain the two expressions which we use without proof in our study of the underdamped natural response of the parallel and series *RLC* circuits,

$$\cos \theta = \frac{1}{2}(e^{j\theta} + e^{-j\theta}) \quad [3]$$

$$\sin \theta = -j \frac{1}{2}(e^{j\theta} - e^{-j\theta}) \quad [4]$$

## PRACTICE

A5.3 Use Eqs. [1] through [4] to evaluate (a)  $e^{-j1}$ ; (b)  $e^{1-j1}$ ; (c)  $\cos(-j1)$ ; (d)  $\sin(-j1)$ .

A5.4 Evaluate at  $t = 0.5$ : (a)  $(d/dt)(3 \cos 2t - j2 \sin 2t)$ ; (b)  $\int_0^t (3 \cos 2t - j2 \sin 2t) dt$ ; Evaluate at  $\mathbf{s} = 1 + j2$ : (c)  $\int_s^\infty \mathbf{s}^{-3} ds$ ; (d)  $(d/ds)[3/(s+2)]$ .

Ans: A5.3:  $0.540 - j0.841$ ;  $1.469 - j2.29$ ;  $1.543$ ;  $-j1.175$ . A5.4:  $-5.05 - j2.16$ ;  $1.262 - j0.460$ ;  $-0.06 - j0.08$ ;  $-0.0888 + j0.213$ .

### A5.3 THE EXPONENTIAL FORM

Let us now take Euler's identity

$$e^{j\theta} = \cos \theta + j \sin \theta$$

and multiply each side by the real positive number  $C$ :

$$Ce^{j\theta} = C \cos \theta + jC \sin \theta \quad [5]$$

The right-hand side of Eq. [5] consists of the sum of a real number and an imaginary number and thus represents a complex number in rectangular form; let us call this complex number  $\mathbf{A}$ , where  $\mathbf{A} = a + jb$ . By equating the real parts

$$a = C \cos \theta \quad [6]$$

and the imaginary parts

$$b = C \sin \theta \quad [7]$$

then squaring and adding Eqs. [6] and [7],

$$a^2 + b^2 = C^2$$

or

$$C = +\sqrt{a^2 + b^2} \quad [8]$$

and dividing Eq. [7] by Eq. [6]:

$$\frac{b}{a} = \tan \theta$$

or

$$\theta = \tan^{-1} \frac{b}{a} \quad [9]$$

we obtain the relationships of Eqs. [8] and [9], which enable us to determine  $C$  and  $\theta$  from a knowledge of  $a$  and  $b$ . For example, if  $\mathbf{A} = 4 + j2$ , then we identify  $a$  as 4 and  $b$  as 2 and find  $C$  and  $\theta$ :

$$C = \sqrt{4^2 + 2^2} = 4.47$$

$$\theta = \tan^{-1} \frac{2}{4} = 26.6^\circ$$

We could use this new information to write  $\mathbf{A}$  in the form

$$\mathbf{A} = 4.47 \cos 26.6^\circ + j4.47 \sin 26.6^\circ$$

but it is the form of the left-hand side of Eq. [5] which will prove to be the more useful:

$$\mathbf{A} = Ce^{j\theta} = 4.47e^{j26.6^\circ}$$

A complex number expressed in this manner is said to be in *exponential form*. The real positive multiplying factor  $C$  is known as the *amplitude* or *magnitude*, and the real quantity  $\theta$  appearing in the exponent is called the *argument* or *angle*. A mathematician would always express  $\theta$  in radians and would write

$$\mathbf{A} = 4.47e^{j0.464}$$



but engineers customarily work in terms of degrees. The use of the degree symbol ( $^\circ$ ) in the exponent should make confusion impossible.

To recapitulate, if we have a complex number which is given in rectangular form,

$$\mathbf{A} = a + jb$$

and wish to express it in exponential form,

$$\mathbf{A} = Ce^{j\theta}$$

we may find  $C$  and  $\theta$  by Eqs. [8] and [9]. If we are given the complex number in exponential form, then we may find  $a$  and  $b$  by Eqs. [6] and [7].

When  $\mathbf{A}$  is expressed in terms of numerical values, the transformation between exponential (or polar) and rectangular forms is available as a built-in operation on most handheld scientific calculators.

One question will be found to arise in the determination of the angle  $\theta$  by using the arctangent relationship of Eq. [9]. This function is multivalued, and an appropriate angle must be selected from various possibilities. One method by which the choice may be made is to select an angle for which the sine and cosine have the proper signs to produce the required values of  $a$  and  $b$  from Eqs. [6] and [7]. For example, let us convert

$$\mathbf{V} = 4 - j3$$

to exponential form. The amplitude is

$$C = \sqrt{4^2 + (-3)^2} = 5$$

and the angle is

$$\theta = \tan^{-1} \frac{-3}{4} \quad [10]$$

A value of  $\theta$  has to be selected which leads to a positive value for  $\cos \theta$ , since  $4 = 5 \cos \theta$ , and a negative value for  $\sin \theta$ , since  $-3 = 5 \sin \theta$ . We therefore obtain  $\theta = -36.9^\circ, 323.1^\circ, -396.9^\circ$ , and so forth. Any of these angles is correct, and we usually select that one which is the simplest, here,  $-36.9^\circ$ . We should note that the alternative solution of Eq. [10],  $\theta = 143.1^\circ$ , is not correct, because  $\cos \theta$  is negative and  $\sin \theta$  is positive.

A simpler method of selecting the correct angle is available if we represent the complex number graphically in the complex plane. Let us first select a complex number, given in rectangular form,  $\mathbf{A} = a + jb$ , which lies in the first quadrant of the complex plane, as illustrated in Fig. A5.3. If we draw a line from the origin to the point which represents the complex number, we shall have constructed a right triangle whose hypotenuse is evidently the amplitude of the exponential representation of the complex number. In other words,  $C = \sqrt{a^2 + b^2}$ . Moreover, the counterclockwise angle which the line makes with the positive real axis is seen to be the angle  $\theta$  of the exponential representation, because  $a = C \cos \theta$  and  $b = C \sin \theta$ . Now if we are given the rectangular form of a complex number which lies in another quadrant, such as  $\mathbf{V} = 4 - j3$ , which is depicted in Fig. A5.4, the correct angle is graphically evident, either  $-36.9^\circ$  or  $323.1^\circ$  for this example. The sketch may often be visualized and need not be drawn.

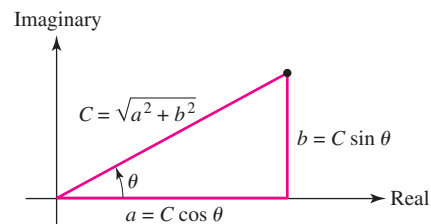

FIGURE A5.3 A complex number may be represented by a point in the complex plane through choosing the correct real and imaginary parts from the rectangular form, or by selecting the magnitude and angle from the exponential form.

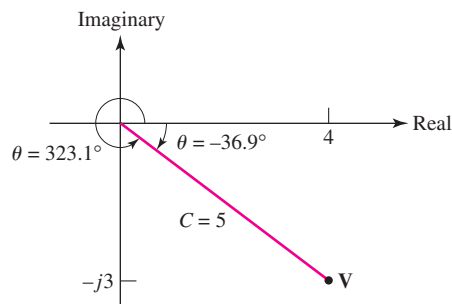

FIGURE A5.4 The complex number  $\mathbf{V} = 4 - j3 = 5e^{-j36.9^\circ}$  is represented in the complex plane.

If the rectangular form of the complex number has a negative real part, it is often easier to work with the negative of the complex number, thus avoiding angles greater than  $90^\circ$  in magnitude. For example, given

$$\mathbf{I} = -5 + j2$$

we write

$$\mathbf{I} = -(5 - j2)$$

and then transform  $(5 - j2)$  to exponential form:

$$\mathbf{I} = -Ce^{j\theta}$$

where

$$C = \sqrt{29} = 5.39 \quad \text{and} \quad \theta = \tan^{-1} \frac{-2}{5} = -21.8^\circ$$

We therefore have

$$\mathbf{I} = -5.39e^{-j21.8^\circ}$$

The negative sign may be removed from the complex number by increasing or decreasing the angle by  $180^\circ$ , as shown by reference to a sketch in the complex plane. Thus, the result may be expressed in exponential form as

$$\mathbf{I} = 5.39e^{j158.2^\circ} \quad \text{or} \quad \mathbf{I} = 5.39e^{-j201.8^\circ}$$

Note that use of an electronic calculator in the inverse tangent mode always yields angles having magnitudes less than  $90^\circ$ . Thus, both  $\tan^{-1}[(-3)/4]$  and  $\tan^{-1}[3/(-4)]$  come out as  $-36.9^\circ$ . Calculators that provide rectangular-to-polar conversion, however, give the correct angle in all cases.

One last remark about the exponential representation of a complex number should be made. Two complex numbers, both written in exponential form, are equal if, and only if, their amplitudes are equal and their angles are equivalent. Equivalent angles are those which differ by multiples of  $360^\circ$ . For example, if  $\mathbf{A} = Ce^{j\theta}$  and  $\mathbf{B} = De^{j\phi}$ , then if  $\mathbf{A} = \mathbf{B}$ , it is necessary that  $C = D$  and  $\theta = \phi \pm (360^\circ)n$ , where  $n = 0, 1, 2, 3, \dots$

## PRACTICE

A5.5 Express each of the following complex numbers in exponential form, using an angle lying in the range  $-180^\circ < \theta \leq 180^\circ$ :

(a)  $-18.5 - j26.1$ ; (b)  $17.9 - j12.2$ ; (c)  $-21.6 + j31.2$ .

A5.6 Express each of these complex numbers in rectangular form:

(a)  $61.2e^{-j111.1^\circ}$ ; (b)  $-36.2e^{j108^\circ}$ ; (c)  $5e^{-j2.5}$ .

Ans: A5.5:  $32.0e^{-j125.3^\circ}$ ;  $21.7e^{-j34.3^\circ}$ ;  $37.9e^{j124.7^\circ}$ . A5.6:  $-22.0 - j57.1$ ;  $11.19 - j34.4$ ;  $-4.01 - j2.99$ .

## A5.4 THE POLAR FORM

The third (and last) form in which we may represent a complex number is essentially the same as the exponential form, except for a slight difference in symbolism. We use an angle sign ( $\angle$ ) to replace the combination  $e^{j\theta}$ . Thus,

the exponential representation of a complex number  $\mathbf{A}$ ,

$$\mathbf{A} = Ce^{j\theta}$$

may be written somewhat more concisely as

$$\mathbf{A} = C/\underline{\theta}$$

The complex number is now said to be expressed in *polar* form, a name which suggests the representation of a point in a (complex) plane through the use of polar coordinates.

It is apparent that transformation from rectangular to polar form or from polar form to rectangular form is basically the same as transformation between rectangular and exponential form. The same relationships exist between  $C$ ,  $\theta$ ,  $a$ , and  $b$ .

The complex number

$$\mathbf{A} = -2 + j5$$

is thus written in exponential form as

$$\mathbf{A} = 5.39e^{j111.8^\circ}$$

and in polar form as

$$\mathbf{A} = 5.39/\underline{111.8^\circ}$$

In order to appreciate the utility of the exponential and polar forms, let us consider the multiplication and division of two complex numbers represented in exponential or polar form. If we are given

$$\mathbf{A} = 5/\underline{53.1^\circ} \quad \text{and} \quad \mathbf{B} = 15/\underline{-36.9^\circ}$$

then the expression of these two complex numbers in exponential form

$$\mathbf{A} = 5e^{j53.1^\circ} \quad \text{and} \quad \mathbf{B} = 15e^{-j36.9^\circ}$$

enables us to write the product as a complex number in exponential form whose amplitude is the product of the amplitudes and whose angle is the algebraic sum of the angles, in accordance with the normal rules for multiplying two exponential quantities:

$$(\mathbf{A})(\mathbf{B}) = (5)(15)e^{j(53.1^\circ - 36.9^\circ)}$$

or

$$\mathbf{AB} = 75e^{j16.2^\circ} = 75/\underline{16.2^\circ}$$

From the definition of the polar form, it is evident that

$$\frac{\mathbf{A}}{\mathbf{B}} = 0.333/\underline{90^\circ}$$

Addition and subtraction of complex numbers are accomplished most easily by operating on complex numbers in rectangular form, and the addition or subtraction of two complex numbers given in exponential or polar form should begin with the conversion of the two complex numbers to rectangular form. The reverse situation applies to multiplication and division; two

numbers given in rectangular form should be transformed to polar form, unless the numbers happen to be small integers. For example, if we wish to multiply  $(1 - j3)$  by  $(2 + j1)$ , it is easier to multiply them directly as they stand and obtain  $(5 - j5)$ . If the numbers can be multiplied mentally, then time is wasted in transforming them to polar form.

We should now endeavor to become familiar with the three different forms in which complex numbers may be expressed and with the rapid conversion from one form to another. The relationships among the three forms seem almost endless, and the following lengthy equation summarizes the various interrelationships

$$\begin{aligned} \mathbf{A} &= a + jb = \operatorname{Re}\{\mathbf{A}\} + j\operatorname{Im}\{\mathbf{A}\} = Ce^{j\theta} = \sqrt{a^2 + b^2}e^{j \tan^{-1}(b/a)} \\ &= \sqrt{a^2 + b^2} \angle \tan^{-1}(b/a) \end{aligned}$$

Most of the conversions from one form to another can be done quickly with the help of a calculator, and many calculators are equipped to solve linear equations with complex numbers.

We shall find that complex numbers are a convenient mathematical artifice which facilitates the analysis of real physical situations.

### PRACTICE

A5.7 Express the result of each of these complex-number manipulations in polar form, using six significant figures just for the pure joy of calculating (a)  $[2 - (1 \angle -41^\circ)] / (0.3 \angle 41^\circ)$ ; (b)  $50 / (2.87 \angle 83.6^\circ + 5.16 \angle 63.2^\circ)$ ; (c)  $4 \angle 18^\circ - 6 \angle -75^\circ + 5 \angle 28^\circ$ .

A5.8 Find  $\mathbf{Z}$  in rectangular form if (a)  $\mathbf{Z} + j2 = 3/\mathbf{Z}$ ; (b)  $\mathbf{Z} = 2 \ln(2 - j3)$ ; (c)  $\sin \mathbf{Z} = 3$ .

Ans: A5.7:  $4.69179 \angle -13.2183^\circ$ ;  $6.31833 \angle -70.4626^\circ$ ;  $11.5066 \angle 54.5969^\circ$ .

A5.8:  $\pm 1.414 - j1$ ;  $2.56 - j1.966$ ;  $1.571 \pm j1.763$ .

## A BRIEF MATLAB<sup>®</sup> TUTORIAL

The intention of this tutorial is to provide a very brief introduction to some basic concepts required to use a powerful software package known as MATLAB. The use of MATLAB is a completely optional part of the material in this textbook, but as it is becoming an increasingly common tool in all areas of electrical engineering, we felt that it was worthwhile to provide students with the opportunity to begin exploring some of its features, particularly in plotting 2D and 3D functions, performing matrix operations, solving simultaneous equations, and manipulating algebraic expressions. Many institutions now provide the full version of MATLAB for their students, but at the time of this writing, a student version is available at reduced cost from The MathWorks, Inc. ([http://www.mathworks.com/academia/student\\_version/](http://www.mathworks.com/academia/student_version/)).

### Getting Started

MATLAB is launched by clicking on the program icon; the typical opening window is shown in Fig. A6.1. Programs may be run from files or by directly entering commands in the window. MATLAB also has extensive online help resources, useful for both beginners and advanced users alike. Typical MATLAB programs very much resemble programs written in C, although familiarity with this language is by no means required.

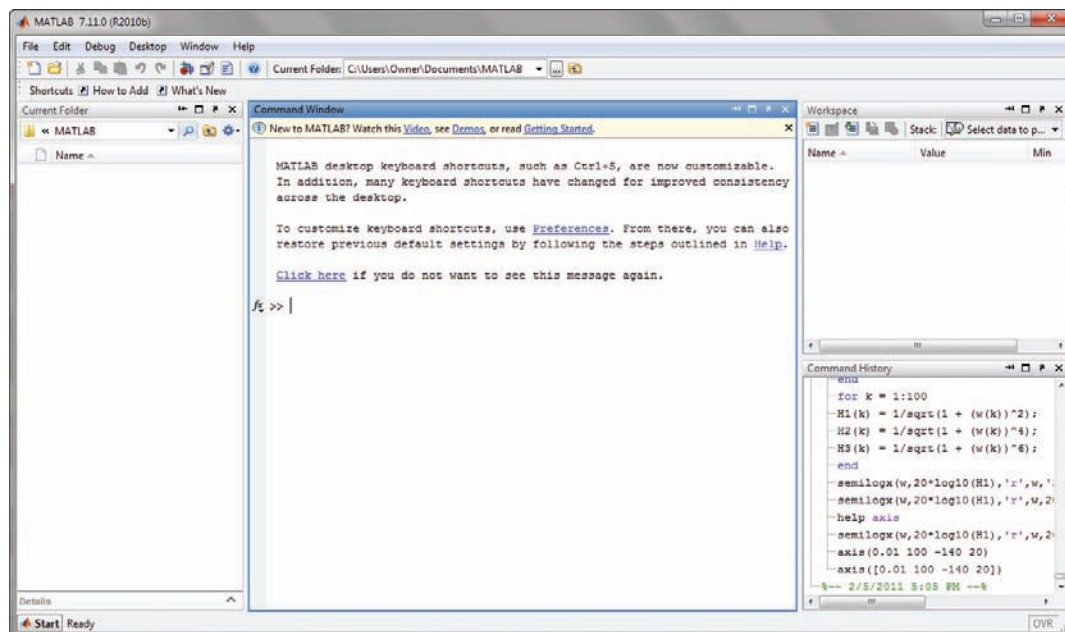

FIGURE A6.1 MATLAB command window upon start-up.

## Variables and Mathematical Operations

MATLAB makes a great deal more sense once the user realizes that all variables are matrices, even if simply  $1 \times 1$  matrices. Variable names can be up to 19 characters in length, which is extremely useful in constructing programs with adequate readability. The first character must be a letter, but all remaining characters can be any letter or number; the underscore (`_`) character may also be used. Variable names in MATLAB are case-sensitive. MATLAB includes several predefined variables. Relevant predefined variables for the material presented in this text include:

---

<i>eps</i>	The machine accuracy
<i>realmin</i>	The smallest (positive) floating-point number handled by the computer
<i>realmax</i>	The largest floating-point number handled by the computer
<i>inf</i>	Infinity (defined as $1/0$ )
<i>NaN</i>	Literally, “Not a Number.” This includes situations such as $0/0$
<i>pi</i>	$\pi$ (3.14159 . . .)
<i>i, j</i>	Both are initially defined as $\sqrt{-1}$ . They may be assigned other values by the user

---

A complete list of currently defined variables can be obtained with the command *who*. Variables are assigned by using an equal sign (`=`). If the statement is terminated with a semicolon (`;`), then another prompt appears. If the statement is simply terminated by a carriage return (i.e., by pressing the Enter key), then the variable is repeated. For example,

```
EDU> input_voltage = 5;
EDU> input_current = 1e-3
input_current =
1.0000e-003
EDU>
```

Complex variables are easy to define in MATLAB: for example,

```
EDU> s = 9 + j*5;
```

creates a complex variable *s* with value  $9 + j5$ .

A matrix other than a  $1 \times 1$  matrix is defined using brackets. For example, we would express the matrix  $\mathbf{t} = \begin{bmatrix} 2 & -1 \\ 3 & 0 \end{bmatrix}$  in MATLAB as

```
EDU> t = [2 -1; 3 0];
```

Note that the matrix elements are entered a row at a time; row elements are separated by a space, and rows are separated by a semicolon (`;`). The same arithmetic operations are available for matrices; so, for example, we may find  $t + t$  as

```
EDU> t + t
ans =
4 -2
6 0
```

Second color has been used to differentiate program-generated text from user-generated text for the convenience of the reader only. We should note that the most recent versions of MATLAB use color to separate different types of text (functions, variables, etc.) and to highlight potential typographical errors.

Arithmetic operators include:

$\wedge$	power	$\backslash$	left division
$*$	multiplication	$+$	addition
$/$	right (ordinary) division	$-$	subtraction

The order of operations is important. The order of precedence is power, then multiplication and division, then addition and subtraction.

```
EDU» x = 1 + 5 ^ 2 * 3
```

```
x =
```

```
76
```

The concept of left division may seem strange at first, but is very useful in matrix algebra. For example,

```
EDU» 1/5
```

```
ans =
```

```
0.2000
```

```
EDU» 1\5
```

```
ans =
```

```
5
```

```
EDU» 5\1
```

```
ans =
```

```
0.2000
```

And, in the case of the matrix equation  $\mathbf{Ax} = \mathbf{B}$ , where

$$\mathbf{A} = \begin{bmatrix} 2 & 4 \\ 1 & 6 \end{bmatrix} \quad \text{and} \quad \mathbf{B} = \begin{bmatrix} -1 \\ 2 \end{bmatrix}$$

we find  $\mathbf{x}$  with

```
EDU» A = [2 4; 1 6];
```

```
EDU» B = [-1; 2];
```

```
EDU» x = A\B
```

```
x =
```

```
-1.7500
```

```
0.6250
```

Alternatively, we can also write

```
EDU» x = A^-1*B
```

```
x =
```

```
-1.7500
```

```
0.6250
```

or

```
EDU» inv(A)*B
```

```
ans =
```

```
-1.7500
```

```
0.6250
```



When in doubt, parentheses can help a great deal.

## Some Useful Functions

Space requirements prevent us from listing every function contained in MATLAB. Some of the more basic ones include:

abs(x)	x	log <sub>10</sub> (x)	log <sub>10</sub> x		
exp(x)	e <sup>x</sup>	sin(x)	sin x	asin(x)	sin <sup>-1</sup> x
sqrt(x)	√x	cos(x)	cos x	acos(x)	cos <sup>-1</sup> x
log(x)	ln x	tan(x)	tan x	atan(x)	tan <sup>-1</sup> x

Functions useful for manipulating complex variables include:

real(s)	Re{s}
imag(s)	Im{s}
abs(s)	√(a <sup>2</sup> + b <sup>2</sup> ), where s ≡ a + jb
angle(s)	tan <sup>-1</sup> (b/a), where s ≡ a + jb
conj(s)	complex conjugate of s

Another extremely useful command, often forgotten, is simply *help*.

Occasionally we require a vector, such as when we plan to create a plot. The command *linspace*(min, max, number of points) is invaluable in such instances:

```
EDU» frequency = linspace(0,10,5)
```

```
frequency =
```

```
0 2.5000 5.0000 7.5000 10.0000
```

A useful cousin is the command *logspace*().

## Generating Plots

Plotting with MATLAB is extremely easy. For example, Fig. A6.2 shows the result of executing the following MATLAB program:

```
EDU» x = linspace(0,2*pi,100);
```

```
EDU» y = sin(x);
```

```
EDU» plot(x,y);
```

```
EDU» xlabel('Angle (radians)');
```

```
EDU» ylabel('f(x)');
```



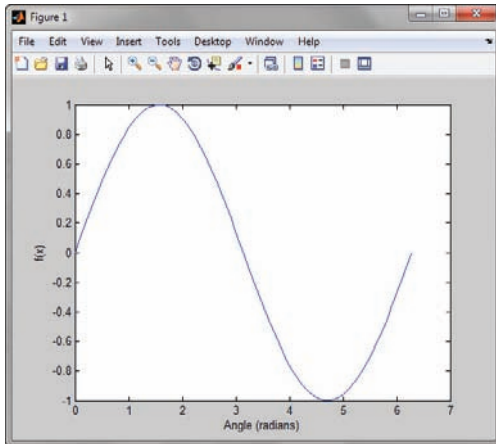

■ FIGURE A6.2 An example plot of  $\sin(x)$ ,  $0 < x < 2\pi$ , generated using MATLAB. The variable  $x$  is a vector comprised of 100 equally spaced elements.

## Writing Programs

Although the MATLAB examples in this text are presented as lines typed into the Command Window, it is possible (and often prudent, if repetition is an issue) to write a program so that calculations are more convenient. This is accomplished in MATLAB by writing what is termed an m-file. This is simply a text file saved with a “.m” extension (for example, first\_program.m). In a nod to Kernighan and Ritchie, we pull down **New Script** under the **File** menu, which opens up the editor. (Note that you can use another editor, for example, WordPad, if you prefer.)

We type in

```
r = input('Hello, World')
```

as shown in Fig. A6.3.

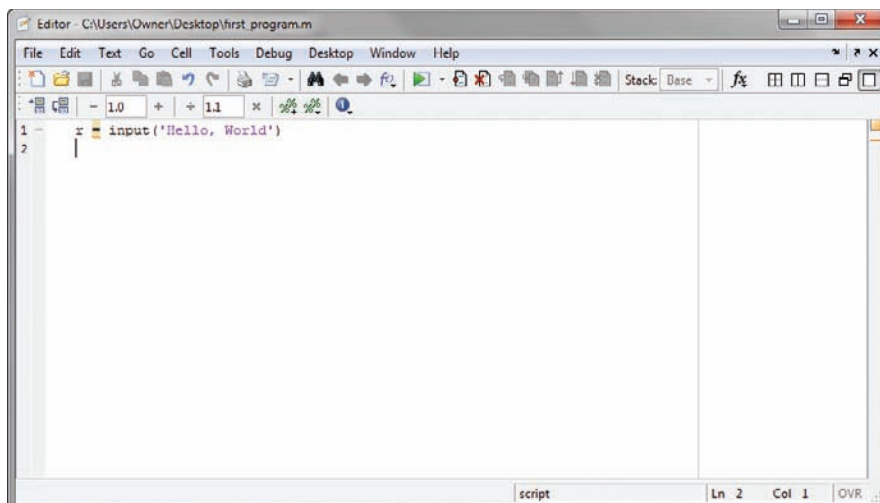

■ FIGURE A6.3 Example m-file created in m-file editor.

We next save it as `first_program` in a convenient directory, taking care to select MATLAB Files (\*.m) under **File Type**. Under the **File** menu, we select **Open**, and find `first_program.m`. This reopens the editor (so we could have skipped closing it earlier). We run our program by hitting `f5` or selecting **Run** under the **Debug** menu. In the Command Window, we see our greeting; MATLAB is waiting for a keyboard response, so just hit the Enter key.

Let's expand a previous example to allow the magnitude to be user-selected as in Fig. A6.4. We are now allowed to enter an arbitrary amplitude for our plot.

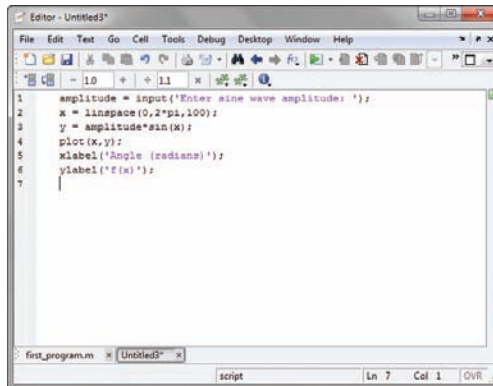

```
1 amplitude = input('Enter sine wave amplitude: ');
2 x = linspace(0,2*pi,100);
3 y = amplitude*sin(x);
4 plot(x,y);
5 xlabel('Angle (radians)');
6 ylabel('f(x)');
7
```

■ FIGURE A6.4 Example m-file named `example1.m` for generating sine wave plot.

We leave it to the reader to choose when to write a program/m-file and when to simply use the Command Window directly.

## READING FURTHER

There are a large number of excellent MATLAB references available, with new titles appearing regularly. Two worth looking at are:

D. C. Hanselman and B. L. Littlefield, *Mastering MATLAB 7*. Upper Saddle River, N.J.: Prentice-Hall, 2005.

W. J. Palm, III, *Introduction to MATLAB 7 for Engineers*, 2nd ed. New York: McGraw-Hill, 2005.

## ADDITIONAL LAPLACE TRANSFORM THEOREMS

In this appendix, we briefly present several Laplace transform theorems typically used in more advanced situations in addition to those described in Chap. 14.

### Transforms of Periodic Time Functions

The time-shift theorem is very useful in evaluating the transform of periodic time functions. Suppose that  $f(t)$  is periodic with a period  $T$  for positive values of  $t$ . The behavior of  $f(t)$  for  $t < 0$  has no effect on the (one-sided) Laplace transform, as we know. Thus,  $f(t)$  can be written as

$$f(t) = f(t - nT) \quad n = 0, 1, 2, \dots$$

If we now define a new time function which is nonzero only in the first period of  $f(t)$ ,

$$f_1(t) = [u(t) - u(t - T)]f(t)$$

then the original  $f(t)$  can be represented as the sum of an infinite number of such functions, delayed by integral multiples of  $T$ . That is,

$$\begin{aligned} f(t) &= [u(t) - u(t - T)]f(t) + [u(t - T) - u(t - 2T)]f(t) \\ &\quad + [u(t - 2T) - u(t - 3T)]f(t) + \dots \\ &= f_1(t) + f_1(t - T) + f_1(t - 2T) + \dots \end{aligned}$$

or

$$f(t) = \sum_{n=0}^{\infty} f_1(t - nT)$$

The Laplace transform of this sum is just the sum of the transforms,

$$\mathbf{F}(s) = \sum_{n=0}^{\infty} \mathcal{L}\{f_1(t - nT)\}$$

so that the time-shift theorem leads to

$$\mathbf{F}(s) = \sum_{n=0}^{\infty} e^{-nTs} \mathbf{F}_1(s)$$

where

$$\mathbf{F}_1(s) = \mathcal{L}\{f_1(t)\} = \int_{0^-}^T e^{-st} f(t) dt$$

Since  $\mathbf{F}_1(\mathbf{s})$  is not a function of  $n$ , it can be removed from the summation, and  $\mathbf{F}(\mathbf{s})$  becomes

$$\mathbf{F}(\mathbf{s}) = \mathbf{F}_1(\mathbf{s})[1 + e^{-Ts} + e^{-2Ts} + \dots]$$

When we apply the binomial theorem to the bracketed expression, it simplifies to  $1/(1 - e^{-Ts})$ . Thus, we conclude that the periodic function  $f(t)$ , with period  $T$ , has a Laplace transform expressed by

$$\mathbf{F}(\mathbf{s}) = \frac{\mathbf{F}_1(\mathbf{s})}{1 - e^{-Ts}} \quad [1]$$

where

$$\mathbf{F}_1(\mathbf{s}) = \mathcal{L}\{[u(t) - u(t - T)]f(t)\} \quad [2]$$

is the transform of the first period of the time function.

To illustrate the use of this transform theorem for periodic functions, let us apply it to the familiar rectangular pulse train, Fig. A7.1. We may describe this periodic function analytically:

$$v(t) = \sum_{n=0}^{\infty} V_0[u(t - nT) - u(t - nT - \tau)] \quad t > 0$$

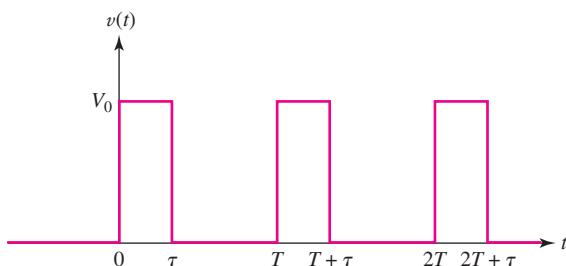

■ FIGURE A7.1 A periodic train of rectangular pulses for which  $\mathbf{F}(\mathbf{s}) = (V_0/\mathbf{s})(1 - e^{-s\tau})/(1 - e^{-sT})$ .

The function  $\mathbf{V}_1(\mathbf{s})$  is simple to calculate:

$$\mathbf{V}_1(\mathbf{s}) = V_0 \int_{0^-}^{\tau} e^{-st} dt = \frac{V_0}{\mathbf{s}}(1 - e^{-s\tau})$$

Now, to obtain the desired transform, we just divide by  $(1 - e^{-sT})$ :

$$\mathbf{V}(\mathbf{s}) = \frac{V_0(1 - e^{-s\tau})}{\mathbf{s}(1 - e^{-sT})} \quad [3]$$

We should note how several different theorems show up in the transform in Eq. [3]. The  $(1 - e^{-sT})$  factor in the denominator accounts for the periodicity of the function, the  $e^{-s\tau}$  term in the numerator arises from the time delay of the negative square wave that turns off the pulse, and the  $V_0/\mathbf{s}$  factor is, of course, the transform of the step functions involved in  $v(t)$ .

EXAMPLE A7.1

Determine the transform of the periodic function of Fig. A7.2.

We begin by writing an equation which describes  $f(t)$ , a function composed of alternating positive and negative impulse functions.

$$f(t) = 2\delta(t - 1) - 2\delta(t - 3) + 2\delta(t - 5) - 2\delta(t - 7) + \dots$$

Defining a new function  $f_1$  and recognizing a period  $T = 4$  s,

$$f_1(t) = 2[\delta(t - 1) - \delta(t - 3)]$$

we can make use of the time periodicity operation as listed in Table 14.2 to find  $\mathbf{F}(s)$

$$\mathbf{F}(s) = \frac{1}{1 - e^{-Ts}} \mathbf{F}_1(s) \tag{4}$$

where

$$\mathbf{F}_1(s) = \int_{0^-}^T f(t)e^{-st} dt = \int_{0^-}^4 f_1(t)e^{-st} dt$$

There are several ways to evaluate this integral. The easiest is to recognize that its value will remain the same if the upper limit is increased to  $\infty$ , allowing us to make use of the time-shift theorem. Thus,

$$\mathbf{F}_1(s) = 2[e^{-s} - e^{-3s}] \tag{5}$$

Our example is completed by multiplying Eq. [5] by the factor indicated in Eq. [4], so that

$$\mathbf{F}(s) = \frac{2}{1 - e^{-4s}} (e^{-s} - e^{-3s}) = \frac{2e^{-s}}{1 + e^{-2s}}$$

PRACTICE

A7.1 Determine the Laplace transform of the periodic function shown in Fig. A7.3.

Ans:  $\left(\frac{8}{s^2 + \pi^2/4}\right) \frac{s + (\pi/2)e^{-s} + (\pi/2)e^{-3s} - se^{-4s}}{1 - e^{-4s}}$ .

Frequency Shifting

The next new theorem establishes a relationship between  $\mathbf{F}(s) = \mathcal{L}\{f(t)\}$  and  $\mathbf{F}(s + a)$ . We consider the Laplace transform of  $e^{-at} f(t)$ ,

$$\mathcal{L}\{e^{-at} f(t)\} = \int_{0^-}^{\infty} e^{-st} e^{-at} f(t) dt = \int_{0^-}^{\infty} e^{-(s+a)t} f(t) dt$$

Looking carefully at this result, we note that the integral on the right is identical to that defining  $\mathbf{F}(s)$  with one exception:  $(s + a)$  appears in place of  $s$ . Thus,

$$e^{-at} f(t) \Leftrightarrow \mathbf{F}(s + a) \tag{6}$$

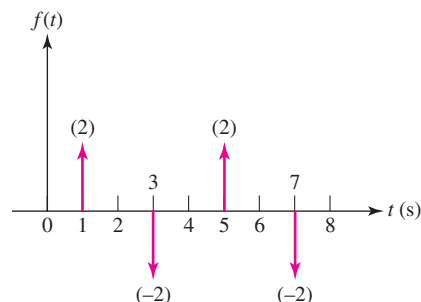

FIGURE A7.2 A periodic function based on unit-impulse functions.

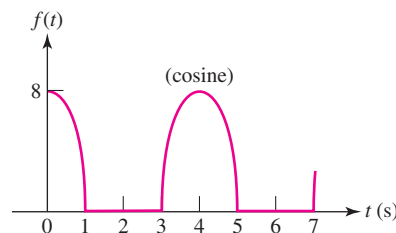

FIGURE A7.3

We conclude that replacing  $s$  by  $(s + a)$  in the frequency domain corresponds to multiplication by  $e^{-at}$  in the time domain. This is known as the **frequency-shift** theorem. It can be put to immediate use in evaluating the transform of the exponentially damped cosine function that we used extensively in previous work. Beginning with the known transform of the cosine function,

$$\mathcal{L}\{\cos \omega_0 t\} = \mathbf{F}(s) = \frac{s}{s^2 + \omega_0^2}$$

then the transform of  $e^{-at} \cos \omega_0 t$  must be  $\mathbf{F}(s + a)$ :

$$\mathcal{L}\{e^{-at} \cos \omega_0 t\} = \mathbf{F}(s + a) = \frac{s + a}{(s + a)^2 + \omega_0^2} \quad [7]$$

### PRACTICE

A7.2 Find  $\mathcal{L}\{e^{-2t} \sin(5t + 0.2\pi)u(t)\}$ .

Ans:  $(0.588s + 4.05)/(s^2 + 4s + 29)$ .

## Differentiation in the Frequency Domain

Next let us examine the consequences of differentiating  $\mathbf{F}(s)$  with respect to  $s$ . The result is

$$\begin{aligned} \frac{d}{ds} \mathbf{F}(s) &= \frac{d}{ds} \int_{0^-}^{\infty} e^{-st} f(t) dt \\ &= \int_{0^-}^{\infty} -t e^{-st} f(t) dt = \int_{0^-}^{\infty} e^{-st} [-t f(t)] dt \end{aligned}$$

which is simply the Laplace transform of  $[-t f(t)]$ . We therefore conclude that differentiation with respect to  $s$  in the frequency domain results in multiplication by  $-t$  in the time domain, or

$$-t f(t) \Leftrightarrow \frac{d}{ds} \mathbf{F}(s) \quad [8]$$

Suppose now that  $f(t)$  is the unit-ramp function  $tu(t)$ , whose transform we know is  $1/s^2$ . We can use our newly acquired frequency-differentiation theorem to determine the inverse transform of  $1/s^3$  as follows:

$$\frac{d}{ds} \left( \frac{1}{s^2} \right) = -\frac{2}{s^3} \Leftrightarrow -t \mathcal{L}^{-1} \left\{ \frac{1}{s^2} \right\} = -t^2 u(t)$$

and

$$\frac{t^2 u(t)}{2} \Leftrightarrow \frac{1}{s^3} \quad [9]$$

Continuing with the same procedure, we find

$$\frac{t^3 u(t)}{3!} \Leftrightarrow \frac{1}{s^4} \quad [10]$$

and in general

$$\frac{t^{(n-1)} u(t)}{(n-1)!} \Leftrightarrow \frac{1}{s^n} \quad [11]$$

**PRACTICE**A7.3 Find  $\mathcal{L}\{t \sin(5t + 0.2\pi)u(t)\}$ .Ans:  $(0.588s^2 + 8.09s - 14.69)/(s^2 + 25)^2$ .**Integration in the Frequency Domain**

The effect on  $f(t)$  of integrating  $\mathbf{F}(s)$  with respect to  $s$  may be shown by beginning with the definition once more,

$$\mathbf{F}(s) = \int_{0^-}^{\infty} e^{-st} f(t) dt$$

performing the frequency integration from  $s$  to  $\infty$ ,

$$\int_s^{\infty} \mathbf{F}(s) ds = \int_s^{\infty} \left[ \int_{0^-}^{\infty} e^{-st} f(t) dt \right] ds$$

interchanging the order of integration,

$$\int_s^{\infty} \mathbf{F}(s) ds = \int_{0^-}^{\infty} \left[ \int_s^{\infty} e^{-st} ds \right] f(t) dt$$

and performing the inner integration,

$$\int_s^{\infty} \mathbf{F}(s) ds = \int_{0^-}^{\infty} \left[ -\frac{1}{t} e^{-st} \right]_s^{\infty} f(t) dt = \int_{0^-}^{\infty} \frac{f(t)}{t} e^{-st} dt$$

Thus,

$$\frac{f(t)}{t} \Leftrightarrow \int_s^{\infty} \mathbf{F}(s) ds \quad [12]$$

For example, we have already established the transform pair

$$\sin \omega_0 t u(t) \Leftrightarrow \frac{\omega_0}{s^2 + \omega_0^2}$$

Therefore,

$$\mathcal{L} \left\{ \frac{\sin \omega_0 t u(t)}{t} \right\} = \int_s^{\infty} \frac{\omega_0 ds}{s^2 + \omega_0^2} = \tan^{-1} \frac{s}{\omega_0} \Big|_s^{\infty}$$

and we have

$$\frac{\sin \omega_0 t u(t)}{t} \Leftrightarrow \frac{\pi}{2} - \tan^{-1} \frac{s}{\omega_0} \quad [13]$$

**PRACTICE**A7.4 Find  $\mathcal{L}\{\sin^2 5tu(t)/t\}$ .Ans:  $\frac{1}{4} \ln[(s^2 + 100)/s^2]$ .

## The Time-Scaling Theorem

We next develop the time-scaling theorem of Laplace transform theory by evaluating the transform of  $f(at)$ , assuming that  $\mathcal{L}\{f(t)\}$  is known. The procedure is very simple:

$$\mathcal{L}\{f(at)\} = \int_{0^-}^{\infty} e^{-st} f(at) dt = \frac{1}{a} \int_{0^-}^{\infty} e^{-(s/a)\lambda} f(\lambda) d\lambda$$

where the change of variable  $at = \lambda$  has been employed. The last integral is recognizable as  $1/a$  times the Laplace transform of  $f(t)$ , except that  $s$  is replaced by  $s/a$  in the transform. It follows that

$$f(at) \Leftrightarrow \frac{1}{a} \mathbf{F}\left(\frac{s}{a}\right) \quad [14]$$

As an elementary example of the use of this time-scaling theorem, consider the determination of the transform of a 1 kHz cosine wave. Assuming we know the transform of a 1 rad/s cosine wave,

$$\cos t u(t) \Leftrightarrow \frac{s}{s^2 + 1}$$

the result is

$$\mathcal{L}\{\cos 2000\pi t u(t)\} = \frac{1}{2000\pi} \frac{s/2000\pi}{(s/2000\pi)^2 + 1} = \frac{s}{s^2 + (2000\pi)^2}$$

### PRACTICE

A7.5 Find  $\mathcal{L}\{\sin^2 5t u(t)\}$ .

Ans:  $50/[s(s^2 + 100)]$ .



*Note:* Page numbers followed by an “n” refer to footnotes.

- A**
- $A_1$  and  $A_2$  values
    - critical damping and, 335
    - overdamped parallel *RLC* circuit, 326–327
  - $\mu$ A741 op amp, 193–194, 195, 198
  - ABCD parameters, two-port networks, 716–720, 730–731
  - abc phase sequence, 464–465
  - Absorbed power, 16, 19, 48–49
    - by element, 48–49
    - in resistors, 23–27
  - ac circuit analysis. *See* ac circuit power analysis; Circuit analysis
  - ac circuit power analysis, 421–456.
    - See also* Complex power
    - apparent power/power factor, 438–441, 453–454
    - average power. *See* Average power
    - instantaneous power, 422–424, 447, 450–451
    - maximum average power, 431
    - RMS values of current/voltage, 433–438, 447
      - average power computations, 435
      - multiple-frequency circuits, 435–436
      - periodic waveform values, 433–434
      - sinusoidal waveform values, 434–435
    - sinusoidal excitation, instantaneous power, 423, 450–451
    - sinusoidal steady state theorem, 430–431
  - Active element, 217
  - Active filters, 669–670
  - Active network, 21
  - AD549K op amp, 193, 195
  - AD622 op amp, 206
  - Addition, Laplace transform operation, 561
  - Additive fluxes, 497
  - Additive property, of the Laplace transform, 546
  - Admittance, 239, 572
    - parameters. *See* Two-port networks
    - in sinusoidal steady-state, 394
  - Algebraic alternatives, complex forcing functions, 380–381
  - American Wire Gauge (AWG), 26
  - Ampère, A.M., 12
  - Ampères, 10, 11, 12
  - Amplifiers, equivalent networks and, 704–706
  - Amplitude
    - exponential form of complex number, 822–824
    - of response, proportional forcing function, 376
    - of sinusoids, 371
  - Amprobe, 443
  - Analysis
    - of circuits. *See* Circuit analysis
    - computer-aided. *See* Computer-aided analysis
    - defined, 5–6
    - Fourier circuit. *See* Fourier circuit analysis
    - mesh. *See* Nodal and mesh analysis
    - nodal. *See* Nodal and mesh analysis
    - power. *See* ac circuit power analysis
    - PSpice Type command, 105
    - sinusoidal steady-state. *See* Sinusoidal steady-state analysis
    - transient, 3, 4, 270–272
  - Analytical Engine, 6
  - Angles, exponential complex numbers, 822–824
  - Angular frequency, of sinusoids, 371
  - Anode, 189
  - Apparent power, 439, 443, 447
    - power factor and, 438–441, 453–454
  - Argand diagram, 817–818
  - Argument
    - exponential form of complex number, 822–824
    - of sinusoids, 371
  - Arrows, for current, 9, 13
  - Asymptotes, Bode diagrams and, 650–651
  - Attenuator, 178, 609
  - Automotive suspensions, modeling, 358
  - Auxiliary equation, 323
  - Average power, 443, 447
    - ac circuits, 424–433, 447, 450–452
    - ideal resistor absorption of, 428
    - maximum, 431
    - maximum transfer of, 430–432
    - nonperiodic functions, 431–433
    - periodic waveforms, 425–426
    - reactive element absorption of, 428–429
    - RMS value and, 435
    - in the sinusoidal steady state, 426–427
    - superposition and, 433
  - 12AX7A vacuum tube, 176
- B**
- $B_1$  and  $B_2$  values, 339–340
  - Babbage, Charles, 6
  - Balanced load, 458
  - Balanced three-phase system, 458
  - Bandpass filters, 665, 667–669
  - Band-reject filters, 673
  - Bandstop filters, 665
  - Bandwidth, and high- $Q$  circuits, 628–633, 680–681
  - Base, of transistors, 715
  - Basic components and electric circuits, 9–38
    - charge, 11–12, 30–33
    - current. *See* Current
    - Ohm’s law. *See* Ohm’s law
    - power. *See* Power
    - units and scales, 9–11, 29–30
    - voltage. *See* Voltage

- Bass, treble, and midrange filters, 671–672
- Beaty, H. Wayne, 29
- Bias Point command (PSPice), 105
- Bilateral circuit, 698
- Bilateral element, 698
- Bode, Hendrik W., 649
- Bode diagrams/plots, 648–664, 683–684
  - additional considerations, 653–657
  - asymptotes, determining, 650–651
  - complex conjugate pairs, 658–661
  - computer-aided analysis for, 661–664
  - decibel (dB) scale, 649
  - higher-order terms and, 657
  - multiple terms in, 651
  - phase response and, 652–653
  - smoothing of, 651
- Bossanyi, E., 486
- Boyce, W.E., 308
- Branch current, 94
- Branches, defined, 791
- Break frequency, 651
- Buffer design, 180
- Burton, T., 486
- Butterworth filters, 673–674
- Butterworth polynomials, 673
- C**
- Candela, 10
- Capacitors, 217–225
  - defined, 218
  - duality. *See* Duality
  - energy storage, 222–224
  - ideal, 217–220, 225
  - integral voltage-current relationships, 220–222, 249–252
  - linearity, consequences of, 238–240, 254–257
  - modeling
    - of ideal capacitors, 217–220
    - with PSPice, 245–247, 259–260
    - in the  $s$ -domain, 575–576
  - op amp circuits with, 240–241, 257–258
  - in parallel, 237–238
  - phasor relationships for, 387–388
  - $s$ -domain circuits and, 575–577
  - in series, 236–237
- Cartesian form, complex numbers, 818
- Cascaded op amps, 184–187, 210–212, 609
- Cathode, 189
- Cavendish, Henry, 22
- cba phase sequence, 464–465
- Characteristic equation, 265–267, 323
- Charge, 11–12, 30–33
  - conservation of, 11, 157
  - distance and, 5
- Chassis ground, 65–66
- Chebyshev filters, 673–674
- Chebyshev polynomials, 673
- Chua, L.O., 234
- Circuit analysis. *See also* Circuit analysis techniques
  - engineering and, 4–5
  - linear. *See* Linear circuits
  - nonlinear. *See* Nonlinear circuit analysis
  - in the  $s$ -domain. *See*  $s$ -domain circuit analysis
  - software, 7. *See also* Computer-aided analysis
- Circuit analysis techniques, 123–174
  - delta-wye conversion, 154–156, 170–172
  - linearity and superposition, 123–133, 159–162
  - maximum power transfer, 152–154, 168–170
  - Norton equivalent circuits. *See* Thévenin/Norton equivalent circuits
  - selection process for, 157–158, 172–173
  - source transformations. *See* Source transformations
  - superposition. *See* Superposition
  - Thévenin equivalent circuits. *See* Thévenin/Norton equivalent circuits
- Circuits
  - analysis of. *See* Circuit analysis
  - components of. *See* Basic components and electric circuits
  - elements of, 17–18, 21
  - networks and, 21–22
  - response résumé, source-free series  $RLC$ , 346–347
  - transfer functions for, 499
- Clayton, G., 612
- Closed-loop operation, op amps, 203
- Closed-loop voltage gain, 193
- Closed paths, 43, 92
- Coefficient of mutual inductance, 494
- Coils, in wattmeters, 476–477
- Collectors, 715
- Column matrix, 804
- Common-emitter configuration, 715
- Common mode rejection ratio (CMRR), op amps, 195–196
- Comparators, 203–204, 214–215
- Complementary function, source-free  $RL$  circuits, 262
- Complementary solution. *See* Natural responses
- Complete response, 733–734
  - driven  $RL$  circuits, 291–295, 317–319
  - to periodic forcing functions, 748–750
  - of  $RLC$  circuits. *See*  $RLC$  circuits
- Complex conjugate pairs, Bode diagrams and, 658–661
- Complex forcing function. *See* Sinusoidal steady-state analysis
- Complex form, of Fourier series, 750–757
- Complex frequency, 324
  - dc case, 535
  - defined, 533–537
  - exponential case, 535
  - exponentially damped sinusoids, 536
  - general form, 534–535, 565–566
  - neper frequency, 534, 537
  - radian frequency, 537
  - $s$ -domain circuit analysis and, 598–606
    - at complex frequencies, 603
    - graphing and, 599, 617–618
    - natural response and, 602–606, 618
    - general perspective, 604
    - special case, 605
  - operating at complex frequencies, 603
  - pole-zero constellations, 600–602
  - response as a function of  $\sigma$ , 598–599
  - $s$  in relation to reality, 536–537
  - sinusoidal case, 535
- Complex numbers, 819–828
  - arithmetic operations for, 818–820
  - described, 817–818
  - Euler's identity, 820–821
  - exponential form of, 822–824

- imaginary unit (operator), 817
- polar form of, 824–826
- rectangular (cartesian) form of, 818
- Complex plane, 817–818
  - s-domain circuit analysis and.
    - See* Complex frequency
- Complex power, 441–447, 454–455
  - apparent power, 439, 443, 447
    - and power factor, 438–441, 453–454
  - average power, 443
  - complex power, 441, 443
  - formula, 441–442
  - measuring, 443–444
  - power factor, 438–441, 453–454
    - correction, 444–445
  - power factor (PF)
    - lagging, 439
    - leading, 439
  - power triangle, 442–443
  - quadrature component, 443
  - quadrature power, 443
  - reactive power, 441, 442–443, 447
  - terminology, 447
  - volt-ampere (VA), 439
  - volt-ampere-reactive (VAR) units, 442
  - watt (W), 447
- Complex representation, phasor as
  - abbreviation for, 383
- Components. *See* Basic components and electric circuits
- Computer-aided analysis, 6–7, 130–133.
  - See also* MATLAB; PSpice
  - Bode diagrams and, 661–664
  - fast Fourier Transform, 774–777
  - Laplace transforms and, 551–553
  - magnetically coupled circuits, 510–512
  - nodal and mesh analysis, 103–107, 120–121, 578–580
  - op amps, 200–203
  - s-domain nodal and mesh analysis, 578–580
  - sinusoidal steady-state analysis, 404–405
  - source-free parallel *RLC* circuits, 344–345
  - source-free *RL* circuits, 270–272
  - system function, 774–777
  - for two port networks, 719–720
- Conductance, 27–28, 394
- Conformal matrices, 805
- Conservation of charge, 11, 157
- Conservation of energy, 14, 48, 157
- Constant charge, 12
- Controlled sources, of voltage/current, 18, 19–21
- Convolution
  - Laplace transform operation, 561, 595–596
  - s-domain circuit analysis and, 589–598
    - convolution integral, 591
    - four-step process for analysis, 589
    - graphical methods of, 592–593
    - impulse response, 589–590, 617
    - Laplace transform and, 595–596
    - realizable systems and, 591–592
    - transfer function comments, 597
- Cooper, George R., 544n
- Corner frequency, 651
- Cosines, sines converted to, 373
- Cotree, 792–793
- Coulomb, 11
- Coupling coefficient, 504
- Cramer's rule, 84, 809–810
- Create command (PSpice), 105
- Critical frequencies, s-domain circuit analysis, 589
- Critically damped response, *RLC* circuits
  - form of, 334–335
  - graphical representation, 336–337
  - source-free circuits
    - parallel, 325, 347
    - series, 346–347
- Current, 9, 11, 12–13, 30–33
  - actual direction vs. convention, 13
  - branch current, 94
  - capacitor voltage-current relationships, 220–222, 249–252
  - coil, 476
  - current-controlled current source, 18, 19–21
  - current-controlled voltage source, 18, 19–21
  - effective values of, 433–438, 452–453
  - gain, amplifiers, 704
  - graphical symbols for, 13
  - laws. *See* Voltage and current laws
  - mesh, 92, 93–95, 505
  - response, resonance and, 622
  - sources
    - controlled, 18, 19–21
    - practical, 135, 139–140
    - reliable, op amps, 190–192, 212–213
    - series/parallel connections, 51–55, 74
    - and voltage. *See* Voltage superposition applicable to, 433
    - types of, 13
    - and voltage division, 61–64, 76–77
- Current level adjustment, ideal transformers for, 517
- Cutoff frequency, transistor amplifier, 398–399
- D**
- Damped sinusoidal forcing function, 537–540, 566
- Damped sinusoidal response, 338
- Damping factor, parallel resonance and, 625–627
- Damping out, of transients, 332
- Davies, B., 565
- 3 dB frequency, 651
- dc (direct current)
  - analysis, 3
  - case, complex frequency, 535
  - current source, 19
  - parameter sweep, 130–133
  - short circuits to, 226
  - sources, 19, 175
- Dead network, 144, 147
- Decade (of frequencies), 650
- DeCarlo, R.A., 109, 159, 410, 721
- Decibel (dB) scale, Bode diagrams, 649
- Delivered power, 19
- Delta ( $\Delta$ ) connection, 470–476, 489–490
  - connected sources, 473–476
  - Y-connected loads vs., 473
- Delta ( $\Delta$ ) of impedances, equivalent networks, 700–702
- Delta-wye conversion, 154–156, 170–172
- Dependent sources
  - linear, 124
  - Thévenin/Norton equivalent circuits, 147–149
  - of voltage/current, 18, 19–21

- Derivative of the current voltage, 18
  - Design, defined, 5–6
  - Determinants, 807–809
  - Difference amplifier, 181–184, 195–196
    - summary, 182
  - Difference Engine, 6
  - Differential equations
    - algebraic alternative, sinusoidal steady-state, 380–381
    - for source-free parallel *RLC* circuits, 322–324
  - Differential input voltage, 195
  - Digital integrated circuits, frequency limits in, 306–307
  - Digital multimeter (DMM), 150–151
  - DiPrima, R.C., 308
  - Direct approach, source-free *RL* circuits, 262–263
  - Direction of travel, current, 12
  - Direct procedure, driven *RL* circuits, 287–289
  - Discrete spectrum, 742
  - Dissipation of power, 49
  - Distance, charge and, 5
  - Distinct poles, method of residues and, 548–549
  - Distributed-parameter networks, 39
  - Dot convention
    - circuit transfer function, 499
    - mutual inductance, 495–499, 523–527
    - physical basis of, 497–500
    - power gain, 499
  - Double-subscript notation, polyphase circuits, 459–460
  - Drexler, H.B., 249
  - Driven *RC* circuits, 295–300
  - Driven *RL* circuits, 286–289, 315–316
    - complete response determination, 291–295, 317–319
    - direct procedure, 287–289
    - intuitive understanding of, 289
    - natural and forced response, 288, 289–295, 316–317
  - Duality, 233, 242–245, 258–259
- E**
- Earth ground, 65–66
  - Edison, Thomas, 457
  - Effective (RMS) value. *See* RMS value
  - Electric circuits. *See* Circuits
  - Emitters, 715
  - Energy, 14
    - accounting, source-free *RL* circuits, 267
    - conservation of, 14, 48, 157
    - density, 763
    - instantaneous, stored, 624
    - magnetically coupled circuits. *See* Magnetically coupled circuits
    - storage capacitors, 222–224
    - storage inductors, 231–233
    - work units, 10
  - Engineering, circuit analysis and, 4–5
  - Engineering units, 11
  - ENIAC, 6
  - Equivalent circuits, ideal transformers, 519–521
  - Equivalent combinations, frequency response and, 639–644
  - Equivalent networks, two-port. *See* Two-port networks
  - Equivalent practical sources, 135–138
  - Equivalent resistance, 56, 144
  - Equivalent voltage sources, 133
  - Euler's identity, 380, 383, 441
  - Even functions, 745n
  - Even harmonics, 745, 745n
  - Even symmetry, Fourier series analysis, 743, 747
  - Exponential case, complex frequency, 535
  - Exponential damping coefficient, 324, 621
  - Exponential form, complex numbers, 822–824
  - Exponential function  $e^{-at}$ , 545
  - Exponentially damped sinusoids, 536
  - Exponential response, *RL* circuits, 268–272, 310
- F**
- Fairchild Corp., 175, 193
  - Fall time, of wave forms, 300
  - farad (F), 218
  - Faraday, Michael, 218n, 225, 226
  - Fast Fourier transform (FFT), 772, 774–777
    - image processing example, 780
  - Feedback control, 5
  - Feynman, R., 67
  - Fiber optic intercom, 183–184
  - Filters (frequency), 664–672, 684–685
    - active, 669–670
    - bandpass, 665, 667–669
    - band-reject, 673
    - bandstop, 665
    - bass/treble/midrange adjustment, 671–672
    - Butterworth, 673–674
    - Chebyshev, 673–674
    - higher order, 672–677, 685
    - high-pass, 665–666, 676
    - low-pass, 665–666, 674
    - multiband, 665
    - notch, 665
    - passive
      - defined, 669
      - low-pass and high-pass, 665–666
      - practical application, 671–672
  - Final-value, Laplace transforms, 562–563
  - Finite resistance, underdamped source-free parallel *RLC*, 340–342
  - Finite wire impedance, 461
  - Fink, Donald G., 29
  - Flowchart, for problem-solving, 8
  - Force, voltage and, 5
  - Forced responses, 371, 733–734
    - driven *RL* circuits, 288, 316–317
    - to sinusoids. *See* Sinusoidal steady-state analysis
    - source-free *RL* circuits, 262
  - Forcing functions, 124
    - sinusoidal waveform as, 371
    - source-free *RL* circuits, 262
  - Forms of responses
    - critically damped *RLC* circuits, 334–335
    - underdamped source-free parallel *RLC* circuits, 338–339
  - Fourier circuit analysis, 4, 733–790. *See also* Fourier series; Fourier transform
    - complete response to periodic forcing functions, 748–750
    - image processing, 780–781
    - practical application, 780–781
  - Fourier series
    - coefficients, 737–738
    - complex form, 750–757
    - sampling function, 754–757
    - symmetry, use of, 743–747

- even and odd symmetry, 743, 747
- Fourier terms and, 743–745
- half-wave symmetry, 745–746, 747
- for simplification purposes, 747
- trigonometric form of, 733–743
  - coefficients, evaluating, 737–738
  - derived, 735–736
  - equation for, 736
  - harmonics, 734–735
  - integrals, useful, 736–737
  - line spectra, 741–742
  - phase spectra, 742–743
- Fourier transform. *See also* Fourier transform pairs
  - defined, 757–761
  - fast Fourier transform (FFT), 772, 774–777
  - image processing example, 780
  - of general periodic time function, 769–770
  - physical significance of, 762–763
  - properties of, 761–764
  - system function, frequency domain. *See* System function
- Fourier transform pairs, 759
  - for constant forcing function, 766
  - for signum function, 766–767
  - summary of, 768
  - for unit-impulse function, 764–766
  - for unit step function, 767
- Free response, source-free *RL* circuits, 262
- Frequency
  - angular, of sinusoids, 371
  - complex. *See* Complex frequency
  - cutoff, transistor amplifier, 398–399
  - differentiation, Laplace transforms, 561, 836–837
  - domain. *See* Frequency domain
  - fundamental frequency, 734
  - integration, Laplace transforms, 561, 837
  - limits, digital integrated circuits, 306–307
  - multiple, RMS value with, 435–436
  - natural resonant, 338–339
  - op amps and, 199–200
  - radian, of sinusoids, 371
  - response. *See* Frequency response
  - scaling, 644–648, 682–683
  - selectivity, parallel resonance and, 629
  - shift, Laplace transforms, 561, 835–836
  - of sinusoids, 372–373
  - source-free parallel *RLC* circuits, 324–325
  - unit definitions for, 324
- Frequency domain
  - phasor representation, 384
  - system function and, 770–777
  - time domain converted to, 539
  - V-I expressions, phasor relationships and, 387
- Frequency response, 3, 4, 619–686
  - Bode diagrams. *See* Bode diagram/plots
  - equivalent series/parallel combinations, 639–644
  - filters. *See* Filters (frequency)
  - parallel resonance. *See* Parallel resonance
  - resonant forms, other, 637–644, 682
  - scaling, 644–648, 682–683
  - series resonance, 633–636, 681
- Friction coefficient, 5
- Fundamental frequency, 734
- G**
- Gain, of op amps, 607
- General Conference on Weights and Measures, 9–10
- General form, complex frequency, 534–535, 565–566
- General practical voltage source, 134
- General *RC* circuits, 279–282
- General *RL* circuits, 275–276, 312–315
- General solution, source-free *RL* circuits, 264–265
- George A. Philbrick Researches, Inc., 208
- Global positioning systems (GPS), 607
- Goody, R.W., 363, 816
- Graphics/Graphical
  - on complex-frequency (*s*) plane, 599, 617–618
  - of convolution, *s*-domain analysis, 592–593
  - of critically damped response, *RLC* circuits, 336–337
  - of current, symbols for, 13
  - overdamped response, *RLC* circuits, 331–332
- underdamped response, *RLC* circuits, 340
- Ground (neutral) connection, 65–66, 458
- Groups, of independent sources, 125
- H**
- Half-power frequency, 651
- Half-wave symmetry, Fourier, 745–746, 747
- Hanselman, D.C., 832
- Harmonics, Fourier, 734–735
- Harper, C.A., 249
- Hartwell, F.P., 67
- Hayt, W.H., Jr., 207, 410, 721
- Heathcote, M., 523
- henry (H), 225
- Henry, Joseph, 225
- Higher order filters, 672–677, 685
- Higher-order terms, Bode diagrams, 657
- High-pass filters, 665, 676
  - passive, 665–666
- High-*Q* circuits
  - approximations for, 629–633
  - bandwidth and, 629–633, 680–681
- Hilburn, J.L., 679
- Homogeneity property, Laplace transforms, 546
- Homogeneous linear differential equations, 261–262
- $\mathbf{H}(s) = \mathbf{V}_{\text{out}}/\mathbf{V}_{\text{in}}$ , synthesizing, 606–610, 618
- Huang, Q., 679
- Huelsman, L.P., 679
- Hybrid parameters, two-port networks, 713–716, 729–730
- I**
- Ideal capacitor model, 217–220
- Ideal inductor model, 225–229
- Ideal operational amplifiers. *See* Operational amplifiers
- Ideal resistor, average power, absorption, 428
- Ideal sources, of voltage, 18
- Ideal transformers, 512–522
  - for current level adjustment, 517
  - equivalent circuits, 519–521
  - for impedance matching, 514
  - step-down transformers, 516
  - step-up transformers, 516

- turns ratio of, 512–514
  - for voltage level adjustment, 515–516
  - voltage relationship in the time domain, 517–521, 530–532
  - Ideal voltage sources, 133–135
  - Image processing, Fourier analysis and, 780–781
  - Imaginary sources → imaginary responses, 379–380
  - Imaginary unit (operator)/component, 817
    - of complex forcing function, 378
    - of complex power, 441
    - imaginary sources → imaginary responses, 379–380
  - Immittance, 394
  - Impedance, 239, 571–572
    - input, 587
    - matching, 514
    - sinusoidal steady-state, 389–394, 414–415
      - defined, 389
      - parallel impedance combinations, 388
      - reactance and, 357
      - resistance and, 390
      - series impedance combinations, 389
  - Impulse response, convolution and, 589–590, 617
  - Inactive network, 147
  - Independent current sources, 18, 19
  - Independent voltage sources, 18–19
  - Inductors/Inductance, 225–234, 252–254, 493
    - characteristics, ideal, 233
    - defined, 225
    - duality. *See* Duality
    - energy storage, 231–233
    - in the frequency domain, 572, 577
    - ideal inductor model, 225–229
    - inductive reactance, 376
    - infinite voltage spikes, 229
    - integral voltage-current relationships, 229–231
    - linearity, consequences of, 238–240, 254–257
    - modeled, 245–247, 259–260, 572–575
    - in parallel, 236
    - phasor relationships for, 386, 413–414
    - in series, 235–236
    - in the time domain, 577
  - Infinite voltage spikes, inductors and, 229
  - Initial value, Laplace transforms, 561–562
  - In-phase sinusoids, 372–373
  - Input bias, 195
  - Input impedance, 587
    - amplifiers, 704–706
    - one-port networks, 688–692
  - Input offset voltage, op amps, 198
  - Instantaneous charge, 12
  - Instantaneous power, 422–424, 447, 450–451
  - Instantaneous stored energy, parallel resonance and, 624
  - Instrumentation amplifier, 204–206, 214–215
  - Integral of the current voltage, 18
  - Integral voltage-current relationships
    - capacitors, 220–222, 249–252
    - inductors, 229–231
  - Internal generated voltage, 474
  - Internal resistance, 134
  - International System of Units (SI), 9–10
  - Intuitive understanding, driven *RL* circuits, 289
  - Inverse transforms. *See* Laplace transform(s)
  - Inversion, of matrices, 806–807
  - Inverting amplifier, 177, 182
  - Inverting input, 176
- J**
- Jenkins, N., 486
  - Johnson, D.E., 679
  - Joules, 10
  - Jung, W.G., 207, 249
- K**
- K2-W op amp, 176
  - Kaiser, C.J., 249
  - kelvin, 10
  - Kennedy, B.K., 523
  - Kilograms, 10
  - kilowatthour (kWh), 438
  - Kirchhoff, Gustav Robert, 40
  - Kirchhoff's laws
    - current law (KCL), 39, 40–42, 68–70
      - nodal analysis and, 80, 157
    - phasors and, 387–388
    - voltage law (KVL), 39, 42–46, 70–72
      - circuit analysis and, 157
      - in mesh analysis, 98
      - order of elements and, 55
  - Korn, G.A., 679
- L**
- Lagging power factor, 439
  - Lagging sinusoids, 372–373
  - Lancaster, D., 679
  - Laplace analysis, 4
  - Laplace transform(s), 533–570
    - computer-aided analysis, 551–553
    - convolution and, 595–596
    - damped sinusoidal forcing function, 537–540, 566
    - defined, 540–543, 567
    - for exponential function  $e^{-\alpha t}$ , 545
    - frequency-differentiation theorem, 836–837
    - frequency-integration theorem, 837
    - frequency-shift theorem, 835–836
    - initial-value/final-value theorems, 561–563, 569–570
    - inverse transform techniques, 546–551, 568
      - distinct poles/method of residues, 548–549
      - linearity theorem, 546–547
      - for rational functions, 547–548
      - repeated poles, 550
    - one-sided, 542–543
    - operations, table of, 561
    - pairs, 559
    - of periodic time functions, 833–835
    - for ramp function  $tu(t)$ , 545
    - sifting property, 545
    - of simple time functions, 543–546, 567
    - sinusoid theorem, 558
    - system stability theorem, 560
    - theorems for, 553–561, 568–569
    - time differentiation theorem, 553–554
    - time-integration theorem, 555–556
    - time-scaling theorem, 838
    - time-shift theorem, 558, 833–835
    - two-sided inverse Laplace transform, 542
    - two-sided Laplace transform, 541
      - for unit-impulse function  $\alpha(t - t_0)$ , 544–545
      - for unit-step function  $u(t)$ , 544
  - LC* circuit, lossless, 359–361, 369–370

- Leading sinusoids, 372–373
- Leighton, R.B., 67
- LF411 op amp, 193, 200
- Lin, P.M., 109, 159, 410, 721
- Linden, D., 159
- Linear circuits, 2–4
  - complex forcing functions, 379–380
  - conservation laws, 157
  - dc analysis, 3
  - frequency response analysis, 3, 4
  - linear voltage-current relationships, 123–124
  - transient analysis, 3, 4
- Linear dependent source, 124
- Linear elements, 123–124
- Linear homogeneous differential equations, 261–262
- Linearity, 123–124
  - consequences, capacitors/inductors, 238–240, 254–257
  - inverse transform theorem, 546–547
- Linear resistor, 23
- Linear transformers, 505–512, 528–530
  - primary mesh current, 505
  - reflected impedance, 505–506
  - secondary mesh current, 505
  - T and  $\Pi$  equivalent networks, 507–510
- Linear voltage-current relationship, 123–124
- Line spectra, Fourier series analysis, 741–742
- Line terminals, 464
- Line-to-line voltages, three-phase Y-Y connection, 465–466
- Links, 792–793
  - loop analysis and, 797–802
- Littlefield, B.L., 832
- LM324 op amp, 193
- LM741 op amp, 200
- LMC6035 op amp, 176
- LMV321 dual op amp, 176
- Loop
  - analysis, links and, 797–802
  - defined, 792
  - mesh analysis and, 92
- Lossless LC circuit, 359–361, 369–370
- Lower half-power frequency, 628
- Low-pass filters, 665, 674
  - passive, 665–666
- Lumped-parameter networks, 39
  - of ideal capacitors, 217–220
  - of inductors
    - ideal inductors, 225–229
    - with PSpice, 245–247, 259–260
    - in the s-domain, 572–575
  - of op amps, detailed, 192–194
- Moles, 10
- MOSFET, 22
- Multiband filters, 665
- Multiple-frequency circuits, RMS value with, 435–436
- Multiple terms, in Bode diagrams, 651
- Multiport network, 687. *See also* Two-port networks
- Mutual inductance, 493–501
  - additive fluxes, 497
  - coefficient of, 494
  - dot convention, 495–499, 523–527
  - circuit transfer function, 499
  - physical basis of, 497–500
  - power gain, 499
  - magnetic flux, 493, 494, 497
  - self-inductance added to, 496
- M**
- $M$ , upper limit for, 503
- $M_{12}/M_{21}$  equality, magnetically coupled circuits, 502–503
- Magnetically coupled circuits, 493–532. *See also* Transformers
  - computer-aided analysis, 510–512
  - coupling coefficient, 504
  - energy considerations, 501–504, 527–528
  - equality of  $M_{12}$  and  $M_{21}$ , 502–503
  - ideal transformers. *See* Ideal transformers
  - linear transformers, 505–512, 528–530
  - magnetic flux, 493, 494, 497
  - mutual inductance. *See* Mutual inductance
  - upper limit for  $M$ , establishing, 503
- Magnetic flux, 493, 494, 497
- Magnitude
  - exponential form of complex number, 822–824
  - scaling, 644–648, 682–683
- Mancini, R., 207, 249, 612
- MATLAB, 85, 551–553
  - tutorial, 827–832
- Matrices
  - determinants of, 807–809
  - inversion of, 806–807
  - matrix form of equations, 85
  - simultaneous equations, solving, 804–810
- Maximum average power, 431
- Maximum power transfer, 152–154, 168–170, 430–432
- Maxwell, James Clerk, 218
- McGillem, Clare D., 544n
- McLyman, W.T., 523
- McPartland, B.J., 67
- McPartland, J.P., 67
- Memristor, 234
- Mesh. *See* Nodal and mesh analysis
- Meters, 10
- Method of residues, 548–549
- Metric system of units, 10
- microfarads ( $\mu\text{F}$ ), 219
- MicroSim Corporation, 103
- Midrange filters, 671–672
- Models/Modeling, 3
  - of automotive suspension systems, 358
- N**
- 1N750 Zener diode, 189–190
- 2N3904, ac parameters, 716
- Nanotechnology, 234
- Napier, John, 534
- NASA Dryden Space Flight Center, 6
- National Bureau of Standards, 9
- National Semiconductor Corp., 176, 200
- Natural resonant frequency, 338–339, 622
- Natural responses, 282, 371, 374, 733–734
  - and the complex-frequency (s) plane, 602–606, 618
  - driven RL circuits, 288, 289–295, 316–317
  - source-free RL circuits, 262
- Negative charge, 11
- Negative feedback
  - op amps, 196–197
  - path, 607
- Negative phase sequence, 464–465
- Negative (absorbed) power, 16, 19
- Negative resistances, 692
- Neper frequency, 537
  - defined, 324
- Nepers (Np), 534

- Networks, 21–22
  - active, 21
  - passive, 21
  - topology. *See* Network topology
  - two-port. *See* Two-port networks
- Network topology, 791–802
  - links and loop analysis, 797–802
  - trees and general nodal analysis, 791–797
- Neudeck, G.W., 207, 410, 721
- Neutral (ground) connection, 458, 464
- New Simulation Profile command (PSpice), 105
- Nodal and mesh analysis, 3, 79–122
  - compared, 101–103, 119–120
  - computer-aided, 103–107, 120–121, 578–580
  - location of sources and, 101
  - mesh analysis, 92–98, 114–117, 157
    - Kirchhoff's voltage law applied to, 98
  - mesh current, 92, 93–95, 505
  - mesh defined, 792
  - procedure, summarized, 98
  - supermesh, 98, 100–101, 117–118
- nodal analysis, 3, 80–89, 109–112, 157
  - basic procedure, summary, 88–89
  - Kirchhoff's current law and, 80
  - nodes defined, 40, 791
  - procedure, summarized, 98
  - reference node, 80
  - sinusoidal steady-state analysis, 394–397, 415–417
  - supermesh, 98, 100–101, 117–118
  - supernodes, 89–91, 112–114
  - trees and, 791–797
  - voltage source effects, 89–91, 112–114
- node-base PSpice schematics, 106–107
- s-domain circuit analysis and, 578–584, 613–615
  - computer-aided, 578–580
- of sinusoidal steady-states, 394–397, 415–417
- Noninverting amplifier circuit, 182
  - output waveform, 178–179
- Noninverting input, 176
- Nonlinear circuit analysis, 2
- Nonperiodic functions, average power for, 431–433
- Nonplanar circuit, defined, 792
- Norton, E.L., 141
- Norton equivalents. *See* Thévenin/Norton equivalent circuits
- Notch filters, 665
- Number systems, units and scales, 9
- Numerical value, of current, 12
- O**
- Octave (of frequencies), 650
- Odd functions, 745n
- Odd harmonics, 745n
- Odd symmetry, Fourier series analysis, 743, 747
- Ørsted, Hans Christian, 225
- Ogata, K., 565, 612
- Ohm, Georg Simon, 22
- Ohms ( $\Omega$ ), 22
- Ohm's law, 22–28, 34–36
  - conductance, 27–28
  - defined, 22
  - power absorption in resistors, 23–27
  - practical application, 25–26
  - resistance units defined, 22
- One-port networks, 687–692, 722–723
  - input impedance calculations for, 688–692
- One-sided Laplace transform, 542–543
- OPA690 op amp, 193, 199
- Op amps. *See* Operational amplifiers
- Open circuit, 27–28
  - to dc, 219
  - impedance parameters, 708–709
- Open-loop
  - configuration, op amps, 203
  - voltage gain, 192–193
- Operating at complex frequencies, 603
- Operational amplifiers, 175–216
  - $\mu$ A741 op amp, 193–194, 195, 198
  - AD549K op amp, 193, 195
  - AD622 op amp, 206
  - capacitors with, 240–241, 257–258
  - cascaded stages, 184–187, 210–212
  - common mode rejection, 195–196
  - comparators, 203–204, 214–215
  - computer-aided analysis, 200–203
  - frequency and, 199–200
  - ideal, 176–184, 208–210
    - derivation of, 194–195
    - difference amplifier, 181–184, 195–196
  - inverting amplifier, 177, 182
  - noninverting amplifier circuit, 178–179, 182
  - rules, 176
  - summary, 182
  - summing amplifier, 180–181, 182
  - voltage follower circuit, 179, 182
- input offset voltage, 198
- instrumentation amplifier, 204–206, 214–215
- LF411 op amp, 193, 200
- LM324 op amp, 193
- LM741 op amp, 200
- LMC6035 op amp, 176
- LMV321 dual op amp, 176
- modeling, 192–194
- negative feedback, 196–197
- OPA690 op amp, 193, 199
- outputs depending on inputs, 176
- packaging, 200
- parameter values, typical, 193
- Philbrick K2-W op amp, 176
- positive feedback, 197
- practical considerations, 192–203, 213
- reliable current sources, 190–192, 212–213
- reliable voltage sources, 188–190, 212–213
- saturation, 197–198
- slew rate, 199–200
- tank pressure monitoring system, 186–187
- Operations, Laplace transform, table of, 561
- Order of elements, KVL and, 55
- Oscillator, 607
  - circuit design, 607–608
  - function, 340
- Out-of-phase sinusoids, 372–373
- Output impedance, amplifiers, 705
- Output resistance, 134
- Overdamped response
  - source-free parallel *RLC* circuits, 325, 326–333, 347, 363–365
  - $A_1$  and  $A_2$  values, finding, 326–327
  - graphical representation of, 331–332
  - source-free series *RLC* circuits, 346–347



- P**
- Packages, op amp, 200
- Pairs, Laplace transform, 559
- Palm, W.J., III, 832
- $\Pi$  and T equivalent networks, 507–510
- Parallel element combinations, 49
  - capacitors, 237–238
  - impedance combinations, 389–390
  - inductors, 236
  - series/parallel combination
    - equivalents, 639–644
- Parallel resonance, 619–627, 636, 679–680
  - bandwidth and high- $Q$  circuits, 628–633, 680–681
- current response and, 622
- damping
  - exponential coefficient, 621
  - factor, 625–627
- defined, 620–622
- frequency selectivity, 629
- instantaneous stored energy, 624
- key conclusions on, 633
- natural resonant frequency, 622
- quality factor ( $Q$ ), 623–627
  - bandwidth and, 628–633, 680–681
  - damping factor and, 625–627
  - other interpretations of  $Q$ , 625
- summary of, 636
- voltage response and, 622–623
- Parameter values, op amps, 193
- Parseval-Deschenes, Marc Antione, 762
- Particular integral, 291
- Particular solution, 291
  - source-free RL circuits, 262
- Passband, 665
- Passive element, 217
- Passive filters
  - defined, 669
  - low-pass and high-pass, 665–666
- Passive network, 21
- Passive sign convention, 16
- Path
  - defined, 791
  - mesh analysis, 92
  - voltage, 14
- Periodic functions/waveforms, 432.
  - See also* Sinusoidal steady-state analysis; Sinusoidal waveforms
- ac average power of, 425–426
- complete response to, 748–750
- fall time of, 300
- as forcing functions, 371
- Laplace transforms of, 833–835
- as output, noninverting amplifiers, 178–179
- period  $T$  of, 300, 372
- pulse width of, 300
- rise time of, 300
- RMS values for, 433–434
- time delay of, 300
- Perry, T., 816
- Peterson, Donald O., 813
- Phase angle  $\theta$ , 372
- Phase comparison, sinusoidal
  - waves, 373
- Phase response, Bode diagrams and, 652–653
- Phase spectra, Fourier series analysis, 742–743
- Phase voltages, 464
- Phasor(s), 4, 384, 413–414, 571. *See also* Phasor relationships for  $R$ ,  $L$ , and  $C$ 
  - diagrams, sinusoidal steady-states, 406–408, 419
- Phasor relationships for  $R$ ,  $L$ , and  $C$ 
  - as abbreviated complex representation, 383
  - capacitors, 387–388
  - frequency-domain representation, 384
  - frequency-domain V-I expressions, 387
  - impedance defined from. *See* Sinusoidal steady-state analysis
  - inductors, 386, 413–414
  - Kirchhoff's laws using, 387–388
  - phasor representation, 384
  - resistors, 385–386
  - time-domain representation, 384
  - time-domain V-I expressions, 387
- Philbrick, George A., 208
- Philbrick K2-W op amp, 176
- Philbrick Researches, Inc., 175
- Physically realizable systems, 591–592
- Physical significance, of Fourier transforms, 762–763
- Physical sources, unit-step function and, 284–285
- Pinkus, A., 565, 783
- Planar circuit, 92, 101
  - defined, 792
- Polar form, of complex numbers, 824–826
- Poles, 547
  - method of residues and, 548–549
  - pole-zero constellations, 600–602
  - repeated, inverse transforms, 550
  - zeros, and transfer functions, 588–589, 616–617
- Polya, G., 8
- Polyphase circuits, 457–492
  - delta ( $\Delta$ ) connection, 470–476, 489–490
  - of sources, 473–476
  - Y-connected loads vs., 473
  - double-subscript notation, 459–460
  - polyphase systems, 458–460, 486–487
  - single-phase three-wire systems, 460–464, 487
  - three-phase Y-Y connection. *See* Three-phase Y-Y connection
- Port, 687
- Positive charge, 11
- Positive feedback, 197, 607
- Positive phase sequence, 464–465
- Positive power, 16, 18
- Potential coil, 476
- Potential difference, 14
- Potentiometer, 671
- Power, 9, 15–17, 30–33. *See also* ac circuit power analysis
  - absorbed. *See* Absorbed power
  - average. *See* Average power
  - dissipation, 49
  - expression for, 15
  - factor. *See* Power factor
  - gain, 499, 704
  - generating systems, 474–475
  - maximum transfer of, 152–154, 168–170
  - measuring. *See* Power measurement
  - negative. *See* Absorbed power
  - positive, 16, 18
  - reactive, 442, 447
  - superposition applicable to, 433
  - terminology recap, 447
  - triangle, 442–443
  - units, 10

- Power factor (PF), 447  
 apparent power and, 438–441, 453–454  
 complex power, 438–441, 453–454  
 correction, 444–445  
 lagging, 439  
 leading, 439
- Power factor (PF) angle, 439
- Power measurement, 443–444  
 three-phase systems, 476–484,  
 490–491  
 two-wattmeter method, 481–483  
 wattmeters, use of, 476–478  
 wattmeter theory and formulas,  
 478–481
- Practical current sources, 135, 139–140
- Practical voltage sources, 133–135,  
 139–140
- Prefixes, SI, 10–11
- Primary mesh current, 505
- Prime mover, 474
- Probe software, 344–345
- Problem-solving strategies, 1, 7–8
- PSpice, 103, 105–107, 130–133  
 Bias Point command, 105  
 capacitors modeled with, 245–247,  
 259–260  
 Create command, 105  
 inductors modeled with, 245–247,  
 259–260  
 New Simulation Profile command, 105  
 node-base schematics, 106–107  
 Run command, 105  
 for sinusoidal steady-state analysis,  
 404–405  
 for transient analysis, 270–272  
 tutorial, 813–816  
 Type command, 105
- Pulse width ( $PW$ ), of waveforms, 300
- Purely reactive elements, average power  
 absorption, 428–429
- Q**
- Quadrature power, 443
- Quality factor ( $Q$ ). *See* Parallel resonance
- R**
- Radian frequency, 371, 537
- Ragazzini, J.R., 207
- Ramp function  $tu(t)$ , Laplace transform  
 for, 545
- Randall, R.M., 207
- Rational functions, inverse transforms for,  
 547–548
- Rawlins, C.B., 25n, 26n
- $RC$  circuits  
 driven, 295–300  
 general, 279–282  
 sequentially switched, 300–305, 319  
 I: time to fully charge/fully  
 discharge, 302–303, 304  
 II: time to fully charge but not fully  
 discharge, 303, 304  
 III: no time to fully charge but time  
 to fully discharge, 303, 304  
 IV: no time to fully charge or fully  
 discharge, 304–305  
 source-free, 272–275, 311–312  
 time constant ( $\tau$ ), 274  
 unit-step function, 282–286, 315
- Reactance  
 impedance and, 390  
 inductive, 376  
 synchronous, 474
- Reactive elements, average power  
 absorption, 428–429
- Reactive power, 442–443, 447
- Realizable systems, s-domain analysis,  
 591–592
- Real portion, of complex forcing  
 function, 378
- Real sources  $\rightarrow$  real responses, complex  
 forcing functions, 379–380
- Reciprocity theorem, 698
- Rectangular form, complex numbers, 818
- Rectangular pulse function, 285–286
- Rectifiers/Rectification, 459, 493
- Reference node, 80
- Reflected impedance, 505–506
- Reliable current sources, op amps,  
 190–192, 212–213
- Reliable voltage sources, op amps,  
 188–190, 212–213
- Repeated poles, inverse transform  
 techniques, 550
- Resistance/Resistors/Resistivity, 9, 25.  
*See also* Ohm's law  
 equivalent, 56  
 in the frequency domain, 571–572  
 ideal, average power absorption, 428  
 impedance and, 390, 391
- internal, 134  
 linear, 23  
 output, 134  
 phasor relationships for, 385–386  
 in s-domain circuit analysis,  
 571–572, 577  
 in series and parallel, 55–61, 75–76  
 in the time domain, 577  
 variable. *See* Potentiometer
- Resonance, 324  
 current response and, 622  
 parallel. *See* Parallel resonance  
 series, 633–636, 681  
 summary table for, 636  
 voltage response and, 622–623
- Resonant frequency, 324
- Response, 123  
 in the frequency domain, 770–777  
 as a function of the  $\sigma$  s-domain,  
 598–599  
 functions, 124  
 source-free series  $RLC$  circuits,  
 346–347
- Ripple factor, 673, 677
- Rise time ( $TR$ ), of waveforms, 300
- $RLC$  circuits, 321–370  
 automotive suspensions modeled, 358  
 complete response of, 351–359,  
 368–369  
 complicated part, 352–357  
 uncomplicated part, 351–352  
 lossless  $LC$  circuit, 359–361, 369–370  
 phasor relationships for. *See* Phasor  
 relationships for  $R$ ,  $L$ , and  $C$   
 solution process summary, 357–359  
 source-free critical damping, 334–338,  
 365–366  
 $A_1$  and  $A_2$  values, 335  
 form of critically damped response,  
 334–335  
 graphical representation of,  
 336–337  
 source-free parallel circuits,  
 321–325, 363  
 computer-aided analysis, 344–345  
 critically damped response,  
 325, 347  
 differential equation for, 322–324  
 equations summary, 347  
 frequency terms defined, 324–325

- overdamped response, 325, 326–333, 347, 363–365
  - $A_1$  and  $A_2$  values, 326–327
  - graphical representation, 331–332
- underdamped response, 325, 338–345, 347, 366–367
  - $B_1$  and  $B_2$  values, 339–340
  - finite resistance, role of, 340–342
  - form of, 338–339
  - graphical representation, 340
- source-free series circuits, 345–351, 367–368
  - circuit response résumé, 346–347
  - critically damped response, 346–347
  - equations summary, 347
  - overdamped response, 346–347
  - underdamped response, 346–347
- RL* circuits
  - driven. *See* Driven *RL* circuits
  - exponential response properties, 268–272, 310
  - exponential response time constant ( $\tau$ ), 268–269
  - general, 275–276, 312–315
  - natural response. *See* Natural responses
  - sequentially switched, 300–305, 319
    - I: time to fully charge/fully discharge, 302–303, 304
    - II: time to fully charge but not fully discharge, 303, 304
    - III: no time to fully charge but time to fully discharge, 303, 304
    - IV: no time to fully charge or fully discharge, 304–305
  - slicing thinly:  $0^+$  vs.  $0^-$ , 276–279
  - source-free, 261–268, 309–310
    - alternative approach, 264
    - complementary function, 262
    - computer-aided analysis, 270–272
    - direct approach, 262–263
    - energy, accounting for, 267
    - forced response, 262
    - forcing function, 262
    - free response, 262
    - general solution approach, 264–265
    - natural response, 262
    - the particular solution, 262
    - the steady-state response, 262
    - transient response, 262
  - unit-step function, 282–286, 315
- RMS value
  - for average power, 435
  - for current and voltage, 433–438, 447
  - with multiple-frequency circuits, 435–436
  - for periodic waveforms, 433–434
  - for sinusoidal waveforms, 434–435
- Robotic manipulator, 5
- Root-mean-square (RMS) value. *See* RMS value
- Rotor, 474
- Row vector, 804
- Run command (PSpice), 105
- Russell, F.A., 207
- S**
- $s$ , defined, 536–537
- Sallen-key amplifier, 673–677
- Sampling function, Fourier series, 754–757
- Sands, M.L., 67
- Saturation, op amp, 197–198
- Scalar multiplication, 561
- Scales, units and, 9–11, 29–30
- Scaling
  - and frequency response, 644–648, 682–683
  - Laplace transform operation, 561
- Scientific calculators, 803–804
- $s$ -domain circuit analysis, 571–618
  - additional techniques, 585–589, 615–616
  - complex frequency and. *See* Complex frequency
  - convolution and. *See* Convolution
  - $\mathbf{H}(s) = \mathbf{V}_{out}/\mathbf{V}_{in}$  voltage ratio, synthesized, 606–610, 618
  - nodal and mesh analysis in, 578–584, 613–615
    - computer-aided analysis, 578–580
  - poles, zeros, and transfer functions, 588–589, 616–617
  - Thévenin equivalent technique, 587–588
  - $Z(s)$  and  $Y(s)$ , 571–577, 612–613
- capacitors
  - in frequency domain, 577
  - modeled in the  $s$  domain, 575–576
  - in time domain, 577
- inductors
  - in frequency domain, 572, 577
  - modeled in the  $s$  domain, 572–575
  - in time domain, 577
- resistors
  - in frequency domain, 571–572, 577
  - in time domain, 577
- summary of element representations, 577
- Secondary mesh current, 505
- Seconds, 10
- Self-inductance, 493
  - added to mutual inductance, 496
- Sequentially switched *RL* or *RC* circuits. *See* *RC* circuits; *RL* circuits
- Series connections, 46
  - capacitors, 236–237
  - impedance combinations, 389
  - inductors in, 235–236
  - and parallel combinations. *See also* Source transformations
    - connected sources, 51–55, 74, 139–140
    - other resonant forms, 639–644
- Series resonance, 633–636, 681
- Settling time, 332
- Sharpe, D., 486
- Short circuit(s), 27–28
  - admittance and, 708–709
    - for equivalent networks, 699–700
  - input admittance, 693–694
  - output admittance, 694
  - transfer admittance, 694
  - two-port networks, 694
  - to dc, 226
- SI base units, 10
- siemen (S), 572
- Sifting property, 545
- Signal ground, 65–66
- Signs
  - passive convention, 16
  - for voltages, 9, 14
- Simon, Paul-René, 29

- Simple time functions, Laplace transforms of, 543–546, 567
- Simulation Program with Integrated Circuit Emphasis, 103
- Simultaneous equations, solving, 803–810
  - Cramer's rule, 809–810
  - determinants and, 807–809
  - matrices, 804–810
  - scientific calculators and, 803–804
- Sines, converted to cosines, 373
- Single-loop circuit, 46–49, 72–73
- Single-node-pair circuit, 49–51, 73
- Single-phase three-wire systems, 460–464, 487
- Singularity functions, 283
- Sinusoids
  - complex frequency case, 535
  - as forcing functions, 619–620
  - Laplace transforms of, 558
- Sinusoidal steady-state analysis, 3, 371–420
  - ac circuit average power, 426–427
  - admittance, 394
  - amplitude, 371
  - angular frequency, 371
  - argument, 371
  - characteristics of sinusoids, 371–374, 410–411
  - complex forcing function, 378–382, 412–413
    - algebraic alternative to differential equations, 380–381
    - applying, 379–380
    - imaginary part, 378
    - imaginary sources → imaginary responses, 379–380
    - real part, 378
    - real sources → real responses, 379–380
    - superposition theorem, 379–380
  - computer-aided analysis, 404–405
  - conductance, 394
  - cutoff frequency, transistor amplifier, 398–399
  - forced responses to sinusoids, 371, 374–377, 411–412
    - alternative form of, 375–376
    - amplitude, response vs. forcing function, 376
    - steady-state, 374–375
  - frequency, 372–373
  - immittance, 394
  - impedance. *See* Impedance
  - lagging and leading, 372–373
  - natural response, 371
  - nodal and mesh analysis, 394–397, 415–417
  - out-of-phase, 372–373
  - period, 372
  - in phase, 372–373
  - phase comparison requirements, 373
  - phasor diagrams, 406–408, 419
  - phasor relationships and. *See* Phasor relationships for  $R$ ,  $L$  and  $C$
  - radian frequency, 371
  - sines converted to cosines, 373
  - sinusoidal waveform forcing function, 371
  - superposition, source transformations, and, 397–405, 417–418
  - susceptance, 394
- Sinusoidal waveforms
  - as forcing functions, 371
  - oscillator circuit design and, 607–608
  - phase comparison, 373
  - RMS values of current/voltage, 434–435
- SI prefixes, 10–11
- Slew rate, op amps, 199–200
- Slicing thinly:  $0^+$  vs.  $0^-$ ,  $RL$  circuits, 276–279
- Smoothing, of Bode diagrams, 651
- Snider, G.S., 234n
- Solve() routine, 86
- Source-free  $RC$  circuits, 272–275, 311–312
- Source-free  $RLC$  circuits. *See*  $RLC$  circuits
- Source-free  $RL$  circuits. *See*  $RL$  circuits
- Source transformations, 3, 133–140, 157, 162–165
  - equivalent practical sources, 135–138
  - key concept requirements, 139–140
  - practical current sources, 135, 139–140
  - practical voltage sources, 133–135, 139–140
- and sinusoidal steady-state analysis, 397–405, 417–418
- summary, 140
- SPICE, 6, 103. *See also* PSpice
- Square matrix, 804
- Squire, J., 783
- Stability, of a system, 560
- Stator, 474
- Steady-state analysis/response, 291. *See also* Sinusoidal steady-state analysis
  - source-free  $RL$  circuits, 262
- Step-down transformers, 516
- Step-up transformers, 516
- Stewart, D.R., 234n
- Stopband, 665
- Structure (programming), 86
- Strukov, D.B., 234n
- Summing amplifier, 180–181, 182
- Superconducting transformers, 518–519
- Supermesh, 98, 100–101, 117–118
- Supernodes, 89–91, 112–114
- Superposition, 3, 123–133, 158, 159–162, 379–380
  - applicable to current, 433
  - applicable to power, 433
  - basic procedure, 130
  - limitations of, 133
  - sinusoidal steady-state analysis, 397–405, 417–418
  - superposition theorem, 125
- Supplied power, 16
  - equaling absorbed power, 49
- Susceptance, 394
- Suspension systems, automotive, modeling of, 358
- Symmetrical components, 470
- Symmetry, use of, Fourier series analysis, 743–747
- Synchronous generator, 474
- Synchronous reactance, 474
- System function, 589
  - computer-aided analysis, 774–777
  - fast Fourier transform (FFT), 772, 774–777
  - image processing example, 780
  - physical significance of, 777–779
  - response, in frequency domain, 770–777
- Systems, stability of, 560
- Szwarc, Joseph, 29

- T**
- T and  $\Pi$  equivalent networks, 507–510
- Tank pressure monitoring system., 186–187
- Taylor, Barry N., 29
- Taylor, J.T., 679
- Tesla, Nikola, 457
- Thévenin, L.C., 141
- Thévenin/Norton equivalent circuits, 3–4, 141–151, 157–158, 165–168, 172–173
- Norton's theorem, 3–4, 145–147, 157–158, 172–173
- linearity for capacitors/inductors, 240
- resistance, 144, 157–158, 172–173
- s-domain circuit analysis, 587–588
- Thévenin's theorem, 3, 141, 143–145, 157–158, 172–173
- linearity for capacitors/inductors, 240
- proof of, 811–812
- and sinusoidal steady-state analysis, 397–405, 417–418
- two-port networks, 705–706
- when dependent sources are present, 147–149
- Thompson, Ambler, 29
- Three-phase system, balanced, 458
- Three-phase Y-Y connection, 464–470, 488–489
- abc phase sequence, 464–465
- cba phase sequence, 464–465
- Delta ( $\Delta$ ) connection vs., 473
- line-to-line voltages, 465–466
- negative phase sequence, 464–465
- positive phase sequence, 464–465
- power measurement in. *See* Power measurement
- total instantaneous power, 467–468
- with unbalanced load, 470
- Tightly coupled coils, 504
- Time constant ( $\tau$ )
- exponential response of *RL* circuits, 268–269
- RC* circuits, 274
- Time delay (TD) of waveforms, 300
- Time differentiation, Laplace transforms and, 553–554, 561
- Time domain
- capacitors in, 577
- converted to frequency domain, 539
- ideal transformer voltage relationships in, 517–521, 530–532
- inductors in, 577
- representation, phasors, 384
- resistors in, 577
- V-I expressions, phasor relationships and, 387
- Time functions, simple, Laplace transforms of, 543–546, 567
- Time integration, Laplace transforms and, 555–556, 561
- Time periodicity, Laplace transforms and, 561, 833–835
- Time-scaling theorem, Laplace transforms and, 838
- Time shift, Laplace transforms and, 558, 561, 833–835
- Topology, 791. *See also* Network topology
- Total instantaneous power, three-phase, 458, 467–468
- T parameters, two-port networks, 716–720, 730–731
- Transconductance, 21
- Transfer functions, 499, 588, 597
- Transfer of charge, 12
- Transformations
- source. *See* Source transformations
- between y, z, h, and t parameters, 709
- Transformers, 493. *See also* Magnetically coupled circuits
- ideal. *See* Ideal transformers
- linear. *See* Linear transformers
- superconducting, 518–519
- Transient analysis, 3, 4
- PSpice capability for, 270–272
- Transient response, 289
- source-free *RL* circuits, 262
- Transistors, 22, 398–399, 715–716
- Transmission parameters, two-port networks, 716–720, 730–731
- Treble filters, 671–672
- Trees, 791–797
- Trigonometric form, of Fourier series. *See* Fourier series
- Trigonometric integrals, Fourier series analysis, 736–737
- Tuinenga, P., 109, 816
- Turns ratio, ideal transformers, 512–514
- Two-port networks, 687–732
- ABCD parameters, 716–720, 730–731
- admittance parameters, 692–699, 723–725
- bilateral circuit, 698
- bilateral element, 698
- reciprocity theorem, 698
- short-circuit admittance parameters, 694
- short-circuit input admittance, 693–694
- short-circuit output admittance, 694
- short-circuit transfer admittance, 694
- y parameters, 694–695, 706–707
- computer-aided analysis for, 719–720
- equivalent networks, 699–707, 725–727
- amplifiers, 704–706
- $\Delta$  of impedances method, 700–702
- Norton equivalent method, 705–706
- short-circuit admittance method, 699–700
- Thevenin equivalent method, 705–706
- Y- $\Delta$  not applicable, 702
- yV subtraction/addition method, 699
- hybrid parameters, 713–716, 729–730
- impedance parameters, 708–712, 727–728
- one-port networks. *See* One-port networks
- t parameters, 716–720, 730–731
- transistors, characterizing, 715–716
- transmission parameters, 716–720, 730–731
- Two-sided inverse Laplace transform, 542
- Two-sided Laplace transform, 541
- U**
- Unbalanced Y-connected loads, 470
- Underdamped response
- source-free parallel *RLC* circuits. *See* *RLC* circuits
- source-free series *RLC* circuits, 346–347

- Unit-impulse function, 283
    - Laplace transform for, 544–545
  - Units and scales, 9–11, 29–30
  - Unit-step function  $u(t)$ , 282–286, 315
    - Fourier transform pairs for, 767
    - Laplace transforms for, 544
    - and physical sources, 284–285
    - $RC$  circuits, 282–286, 315
    - rectangular, 285–286
    - $RL$  circuits, 282–286, 315
  - Unity gain amplifier, 182
  - Upper half-power frequency, 628
  - V**
  - Vectors, 85, 804
  - Volta, Alessandro Giuseppe Antonio
    - Anastasio, 14n
  - Voltage, 9, 14–15, 30–33
    - actual polarity vs. convention, 14
    - current sources and, 17–22, 33–34, 51–55, 74
    - active elements, 21
    - circuit element, 21
    - dependent sources of
      - voltage/current, 18, 19–21
    - derivative of the current voltage, 18
    - independent current sources, 19
    - independent voltage sources, 18–19
    - integral of the current voltage, 18
    - networks and circuits, 21–22
    - passive elements, 21
  - effective values of, 433–438, 452–453
  - force and, 5
  - input offset, op amps, 198
  - integral voltage-current relationships,
    - for capacitors, 220–222, 249–252
  - internally generated, 474
  - laws. *See* Voltage and current laws
  - sources. *See* Voltage sources
  - voltage and current division, 61–64, 76–77
- Voltage amplifier, 178
  - Voltage and current division, 61–64, 76–77
  - Voltage and current laws, 39–78
    - branches, 39–40, 67–68
    - equivalent resistance, 55
    - Kirchhoff's current law (KCL), 39, 40–42, 68–70
    - Kirchhoff's voltage law (KVL), 39, 42–46, 70–72
    - order of elements and, 55
    - loops, 39–40, 67–68
    - nodes, 39–40, 67–68
    - paths, 39–40, 67–68
    - resistors in series and parallel, 55–61, 75–76
    - series and parallel connected sources, 51–55, 74
    - single-loop circuit, 46–49, 72–73
    - single-node-pair circuit, 49–51, 73
    - voltage and current division, 61–64, 76–77
  - Voltage coil, 476
  - Voltage-controlled current source, 19
  - Voltage-controlled voltage source, 19–20
  - Voltage follower circuit, 179, 182
  - Voltage gain, amplifiers, 704
  - Voltage level adjustment, ideal
    - transformers for, 515–516
  - Voltage ratio  $\mathbf{H}(s) = \mathbf{V}_{\text{out}}/\mathbf{V}_{\text{in}}$ ,
    - synthesizing, 606–610, 618
  - Voltage regulation, 475
  - Voltage relationship, ideal transformers,
    - time domain, 517–521, 530–532
  - Voltage response, resonance and, 622–623
  - Voltage sources
    - ideal, 133–135
    - practical, 133–135
    - reliable, op amps, 188–190, 212–213
    - series and parallel connected sources, 51–55, 74
    - source effects, nodal and mesh
      - analysis, 89–91, 112–114
  - Volt-ampere-reactive (VAR) units, 442
    - complex power, 441
  - Volt-amperes (VA), 439
  - W**
  - Wait, J.V., 679
  - Wattmeters, for three-phase systems
    - theory and formulas, 478–481
    - two wattmeter method, 481–483
    - use, 476–478
  - Watts (W), 10, 447
  - Weber, E., 308, 363
  - Weedy, B.M., 449, 486
  - Westinghouse, George, 457
  - Wheeler, H.A., 534
  - Wien-bridge oscillator, 607
  - Williams, R.S., 234n
  - Winder, S., 612
  - Wire gauges, 25–26
  - Work (energy) units, 10
  - Y**
  - Y parameters, two-port networks, 694–695, 706–707
  - Y(s) and Z(s). *See* s-domain circuit analysis
  - YV method, for equivalent networks, 699
  - Z**
  - Zafrany, S., 565, 783
  - Zandman, Felix, 29
  - Zener diode, 188–190, 212–213
  - Zener voltage, 189
  - Zeros, 547
    - s-domain circuit analysis
      - pole-zero constellations, 600–602
      - zeros, poles, and transfer functions, 588–589
  - Zero<sup>+</sup> vs. Zero<sup>-</sup>, slicing thinly:  $RL$ 
    - circuits, 276–279
  - Zeta ( $\zeta$ ) damping factor, 626
  - Z parameters, 708–712, 727–728
  - Z(s), Y(s) and. *See* s-domain circuit analysis

## A Short Table of Integrals

$$\int \sin^2 ax \, dx = \frac{x}{2} - \frac{\sin 2ax}{4a}$$

$$\int \cos^2 ax \, dx = \frac{x}{2} + \frac{\sin 2ax}{4a}$$

$$\int x \sin ax \, dx = \frac{1}{a^2}(\sin ax - ax \cos ax)$$

$$\int x^2 \sin ax \, dx = \frac{1}{a^3}(2ax \sin ax + 2 \cos ax - a^2 x^2 \cos ax)$$

$$\int x \cos ax \, dx = \frac{1}{a^2}(\cos ax + ax \sin ax)$$

$$\int x^2 \cos ax \, dx = \frac{1}{a^3}(2ax \cos ax - 2 \sin ax + a^2 x^2 \sin ax)$$

$$\int \sin ax \sin bx \, dx = \frac{\sin(a-b)x}{2(a-b)} - \frac{\sin(a+b)x}{2(a+b)}; a^2 \neq b^2$$

$$\int \sin ax \cos bx \, dx = -\frac{\cos(a-b)x}{2(a-b)} - \frac{\cos(a+b)x}{2(a+b)}; a^2 \neq b^2$$

$$\int \cos ax \cos bx \, dx = \frac{\sin(a-b)x}{2(a-b)} + \frac{\sin(a+b)x}{2(a+b)}; a^2 \neq b^2$$

$$\int x e^{ax} \, dx = \frac{e^{ax}}{a^2}(ax - 1)$$

$$\int x^2 e^{ax} \, dx = \frac{e^{ax}}{a^3}(a^2 x^2 - 2ax + 2)$$

$$\int e^{ax} \sin bx \, dx = \frac{e^{ax}}{a^2 + b^2}(a \sin bx - b \cos bx)$$

$$\int e^{ax} \cos bx \, dx = \frac{e^{ax}}{a^2 + b^2}(a \cos bx + b \sin bx)$$

$$\int \frac{dx}{a^2 + x^2} = \frac{1}{a} \tan^{-1} \frac{x}{a}$$

$$\int_0^{\infty} \frac{\sin ax}{x} dx = \begin{cases} \frac{1}{2}\pi & a > 0 \\ 0 & a = 0 \\ -\frac{1}{2}\pi & a < 0 \end{cases}$$

$$\int_0^{\pi} \sin^2 x dx = \int_0^{\pi} \cos^2 x dx = \frac{\pi}{2}$$

$$\int_0^{\pi} \sin mx \sin nx dx = \int_0^{\pi} \cos mx \cos nx dx = 0; m \neq n, m \text{ and } n \text{ integers}$$

$$\int_0^{\pi} \sin mx \cos nx dx = \begin{cases} 0 & m - n \text{ even} \\ \frac{2m}{m^2 - n^2} & m - n \text{ odd} \end{cases}$$

### **A Short Table of Trigonometric Identities**

$$\sin(\alpha \pm \beta) = \sin \alpha \cos \beta \pm \cos \alpha \sin \beta$$

$$\cos(\alpha \pm \beta) = \cos \alpha \cos \beta \mp \sin \alpha \sin \beta$$

$$\cos(\alpha \pm 90^\circ) = \mp \sin \alpha$$

$$\sin(\alpha \pm 90^\circ) = \pm \cos \alpha$$

$$\cos \alpha \cos \beta = \frac{1}{2} \cos(\alpha + \beta) + \frac{1}{2} \cos(\alpha - \beta)$$

$$\sin \alpha \sin \beta = \frac{1}{2} \cos(\alpha - \beta) - \frac{1}{2} \cos(\alpha + \beta)$$

$$\sin \alpha \cos \beta = \frac{1}{2} \sin(\alpha + \beta) + \frac{1}{2} \sin(\alpha - \beta)$$

$$\sin 2\alpha = 2 \sin \alpha \cos \alpha$$

$$\cos 2\alpha = 2 \cos^2 \alpha - 1 = 1 - 2 \sin^2 \alpha = \cos^2 \alpha - \sin^2 \alpha$$

$$\sin^2 \alpha = \frac{1}{2}(1 - \cos 2\alpha)$$

$$\cos^2 \alpha = \frac{1}{2}(1 + \cos 2\alpha)$$

$$\sin \alpha = \frac{e^{j\alpha} - e^{-j\alpha}}{j2}$$

$$\cos \alpha = \frac{e^{j\alpha} + e^{-j\alpha}}{2}$$

$$e^{\pm j\alpha} = \cos \alpha \pm j \sin \alpha$$

$$A \cos \alpha + B \sin \alpha = \sqrt{A^2 + B^2} \cos \left( \alpha + \tan^{-1} \frac{-B}{A} \right)$$