

SPRINGER BRIEFS IN ENVIRONMENTAL SCIENCE

Tasneem Abbasi · S.M. Tauseef
S.A. Abbasi

Biogas Energy

 Springer

SpringerBriefs in Environmental Science

For further volumes:
<http://www.springer.com/series/8868>

Tasneem Abbasi • S.M. Tauseef • S.A. Abbasi

Biogas Energy

 Springer

Tasneem Abbasi
Centre for Pollution Control
and Environmental Engineering
Pondicherry University, Kalapet
Puducherry 605 014, India

S.M. Tauseef
Centre for Pollution Control
and Environmental Engineering
Pondicherry University, Kalapet
Puducherry 605 014, India

S.A. Abbasi
Centre for Pollution Control
and Environmental Engineering
Pondicherry University, Kalapet
Puducherry 605 014, India
prof.s.a.abbasi@gmail.com

ISBN 978-1-4614-1039-3 e-ISBN 978-1-4614-1040-9
DOI 10.1007/978-1-4614-1040-9
Springer New York Dordrecht Heidelberg London

Library of Congress Control Number: 2011939062

© Tasneem Abbasi 2012

All rights reserved. This work may not be translated or copied in whole or in part without the written permission of the publisher (Springer Science+Business Media, LLC, 233 Spring Street, New York, NY 10013, USA), except for brief excerpts in connection with reviews or scholarly analysis. Use in connection with any form of information storage and retrieval, electronic adaptation, computer software, or by similar or dissimilar methodology now known or hereafter developed is forbidden.

The use in this publication of trade names, trademarks, service marks, and similar terms, even if they are not identified as such, is not to be taken as an expression of opinion as to whether or not they are subject to proprietary rights.

Printed on acid-free paper

Springer is part of Springer Science+Business Media (www.springer.com)

Dedicated to

*Aunties Neelu, Sophia, and Rubi
–Tasneem Abbasi*

*Papa (Abid Hussain Saheb),
Ammi (Tasneem Fatima Sahiba),
and my beloved wife Rabab
–S.M. Tauseef*

*Didi (Nilofer Changi),
Aapa (Sophia Kapasi), and Rubi behn
–S.A. Abbasi*

Foreword

For most of the twentieth century “biogas” was perceived as a poor man’s fuel. India and China led the initiative of the developing countries in extracting biogas from animal manure to meet the much needed source of energy for farmers in villages. To developed countries, however, biogas was too lean and too inconvenient a fuel compared to the then abundantly available and cheaper petroleum-based fuels. Hence they either released the biogas that got generated in to atmosphere during manure management or from sanitary landfills, or flared it off when there was a danger of it forming a flammable cloud upon release.

For a short while developed countries did look at biogas as a potential fuel during 1973 and 1979 when “oil shocks” crisis hit them. But when the crisis passed off and oil prices dipped through the 1980s, the biogas again went out of contention in the developed world just as other non-conventional energy sources did.

The perceptions saw a sea change at the beginning of twenty-first century in the wake of an imminent threat to the existence of life on the planet earth due to global warming.

The world has realized that methane – which is the major component of “biogas” – is the second biggest contributor to global warming, next only to carbon dioxide. It is a fact that each molecule of methane potentially causes several times more global warming compared to a molecule of carbon dioxide, it is also a fact that the same methane, if captured and used as fuel, provides one of the cleanest sources of energy. This has brought methane capture to the forefront of global R&D thrust.

Interestingly, the status of biogas has also changed from a “poor man’s fuel” to a “global priority” in such a short time that a large part of the world was not adequately prepared for it. I also understand there are hardly any dedicated books related to this emerging important clean fuel source. Hence I feel that the work presented in this book would be a trail-blazer and contribute to the R&D efforts in biogas generation and use.

Professor S.A. Abbasi has been associated with R&D on biogas since the 1970s and has pioneered the use of aquatic weeds in biogas generation, reporting research findings regularly since 1979. He has produced this book jointly with his two junior associates who also have substantial exposure in this area. I congratulate Springer for their foresight in commissioning this book and wish it critical, as well as commercial, success.

Pondicherry University, Puducherry 605 014, India

Prof. J.A.K. Tareen
Vice Chancellor

Preface

Like carbon dioxide, methane is also generated in nature through a number of different routes and plays a crucial role in keeping the earth warm enough to be habitable. But during the last two centuries, and more so in the last few decades, anthropogenic activities have been contributing more *extra* methane to the earth's atmosphere than is good for the health of the Earth.

Each methane molecule contributes about 25 times as much to global warming as a molecule of carbon dioxide but methane has one major attribute which carbon dioxide does not have – methane can be used as a fuel. These twin aspects makes it doubly gainful to “capture” anthropogenic methane.

In developing countries, especially India and China, the importance of capturing methane that is generated from animal manure was recognized from the early twentieth century and major programmes were launched to popularize the “biogas digesters” that made this methane capture possible. Then the advent of several “high-rate” digesters during the late 1960s and early 1970s dramatically enhanced the reach of anaerobic digestion to wastewaters which were, till then, considered to be too “dilute” to be profitably handled by anaerobic digestion. Now a third, and perhaps the most important, phase of the evolution of biogas technology is underway wherein treatment of municipal solid waste, crop waste, and other forms of “high-solids” biowaste is being increasingly brought under its preview.

We deem it a privilege to have been asked by Springer to articulate this book at a time when there is a great resurgence of interest in methane capture – hence biogas technology – all over the world.

TA and SAA thank the Department of Biotechnology, Government of India for support in the form of an R&D project. SMT thanks the Council of Scientific and Industrial Research (CSIR), New Delhi, for Senior Research Fellowship. We also thank Ms M. Premaltha, Senior Research Fellow, for her help in locating and organizing on lot of material that has gone in the making of this book. Above all we thank Professor J.A.K. Tareen, Vice Chancellor, Pondicherry University, for his perceptive *Foreword* and the all-important moral support.

Pondicherry University, Puducherry 605 014, India

Tasneem Abbasi
S.M. Tauseef
S.A. Abbasi

Contents

1 Biogas and Biogas Energy: An Introduction	1
1.1 What is Biogas?	1
1.2 How is Biogas Generated?.....	2
1.3 Factors Which Influence Anaerobic Digestion of an Organic Substrate	5
1.3.1 C/N Ratio	5
1.3.2 Dilution	6
1.3.3 pH.....	6
1.3.4 Temperature.....	7
1.3.5 Loading Rate	7
1.3.6 Retention Time.....	7
1.3.7 Toxicity.....	9
1.3.8 Mixing/Agitation.....	9
1.3.9 Pathogens	9
1.3.10 Solid Residue/Slurry	9
References.....	10
2 A Brief History of Anaerobic Digestion and “Biogas”	11
2.1 Introduction: Discovery of Biogas.....	11
2.2 Development of Anaerobic Digestion as a Wastewater Treatment Process	12
2.3 Biogas and Developing Countries.....	12
2.3.1 India.....	12
2.3.2 China	14
2.3.3 Nepal	15
2.3.4 Vietnam	16
2.3.5 Bangladesh	16
2.3.6 Sri Lanka	16
2.3.7 Other Developing Countries.....	18
2.4 Use of Anaerobic Digestion Elsewhere	18
References.....	22

3	Biogas and Global Warming	25
3.1	Introduction.....	25
3.2	Sources of Methane: General.....	27
3.2.1	Human-Related Sources.....	27
3.2.2	Natural Sources.....	29
3.3	Sources of Methane in the Form of Biogas Produced Due to Anthropogenic Causes.....	33
	References.....	33
4	Low-Rate and High-Rate Anaerobic Reactors/ Digesters/Fermenters	35
4.1	General.....	35
4.2	“Low-Rate” and “High-Rate” Anaerobic Reactors.....	36
	References.....	39
5	Biogas Capture from Animal Manure	41
5.1	Introduction.....	41
5.2	Some Well-Known Low-Rate Digesters.....	42
5.2.1	Floating-Dome Biogas Plant: The Khadi and Village Industry Commission Model.....	42
5.2.2	Floating-Dome Biogas Plant: The Indian Agricultural Research Institute Model.....	44
5.2.3	Fixed-Dome Biogas Plants: The “Chinese”/“Janata”/“Deenbandhu” Models.....	45
5.2.4	“Balloon Digester”.....	48
5.2.5	The Basic Limitation of the Low-Rate “Biogas Digesters” Described in the Preceding Sections.....	49
5.3	Large-Scale Manure Digesters Used in Developed Countries and, Now Increasingly, in Some Developing Countries Too.....	50
5.3.1	The Rising Trend of Methane Capture.....	50
5.3.2	Technology Employed.....	52
	References.....	62
6	Biogas Capture from Wastewaters: The High-Rate Anaerobic Digesters	63
6.1	Introduction.....	63
6.2	Emission of Methane from Wastewater as a Component of Biogas.....	64
6.3	The High-Rate Digesters.....	66
6.3.1	First Generation of High-Rate Digesters.....	67
6.3.2	Second Generation of High-Rate Digesters.....	72
6.3.3	Third Generation of High-Rate Digesters.....	81
	References.....	97

7 Biogas Capture from Solid Waste..... 105

7.1 Introduction..... 105

7.2 Multi-phase Digestion..... 107

7.3 Solid-Feed Anaerobic Digestion..... 110

7.4 High-Solids Anaerobic Digestion..... 113

7.5 Present Status of MSW Treatment by Anaerobic Digestion..... 115

7.5.1 Advantages and Challenges 115

7.5.2 Anaerobic Digestion of MSW in Europe 118

7.5.3 Anaerobic Digestion Systems for Treating MSW..... 122

7.5.4 Economics of MSW Digestion..... 136

References..... 142

8 Capture of Biogas from Landfills 145

8.1 Introduction..... 145

8.2 Landfill: Originated Methane Emissions 147

8.3 How Are Sanitary Landfills Laid Out..... 149

8.3.1 Making of Sanitary Landfills 150

8.3.2 Methane Biogas Capture 152

8.3.3 Utilization Options 158

8.4 LFG Capture in Developing Countries 160

8.5 Risks Associated with Landfills..... 161

8.5.1 Flammability 162

8.5.2 Toxicity..... 163

8.5.3 Reducing the Health Effects of Landfill Gas 165

8.5.4 Risk of Leachate Pollution 166

8.5.5 Methods of Leachate Disposal..... 166

8.6 “Bioreactor” Landfills..... 167

References..... 169

Chapter 1

Biogas and Biogas Energy: An Introduction

Abstract “Biogas” is the name popularly used to denote the flammable mixture of gases that are generated when organic material undergoes anaerobic decomposition. The mixture contains 40–70% (usually 55–65%) methane, carbon dioxide, and traces of other gases. “Biogas” has good calorific value and can be directly used as fuel or indirectly used to generate electricity.

In this chapter a general introduction to “biogas” is provided, and steps involved in its formation are described. The factors which influence the sustainability and efficiency of anaerobic digestion – hence biogas production – are also briefly discussed.

1.1 What is Biogas?

When organic matter – such as food, plant debris, animal manure, sewage sludge, biodegradable portions of municipal solid waste, etc. – undergoes decomposition in the absence of free oxygen, it normally generates a gas which consists of 40–70% methane, the rest being mostly carbon dioxide with traces of other gases. If ignited, this gas burns cleanly (i.e., gives off no soot or foul smell) similar to liquefied petroleum gas (LPG) or compressed natural gas (CNG). This gas is commonly called “biogas” which is an inexact and imprecise term because the gas which is produced by aerobic decomposition (carbon dioxide) is also “biogas” in the sense that it is also a result of biodegradation just as the other biogas is. But the word “biogas” has come to be used exclusively to denote the combustible CH_4 – CO_2 mixture (besides traces of other gases) that is generated by the anaerobic decomposition of organic matter. Biogas has good calorific value, though lesser than LPG and CNG (Table 1.1).

It must be mentioned that a mixture of CH_4 and CO_2 is not the only gas possible by anaerobic degradation of organic matter. Of the two, methane is produced only if methanogenic bacteria are involved in the anaerobic decomposition. Under different conditions, and with other species of anaerobic micro-organisms, gases such as hydrogen

Table 1.1 Comparison of the calorific values of various fuels (MNRE 2011)

Fuel	Calorific value (approximate)
Natural gas	8,600 kcal m ⁻³
Liquefied petroleum gas	10,800 kcal kg ⁻¹
Kerosene	10,300 kcal kg ⁻¹
Diesel	10,700 kcal kg ⁻¹
Biogas	5,000 kcal m ⁻³

and hydrogen sulphide may be generated instead of methane. But methanogenic bacteria occur very commonly in nature and in most instances anaerobic digestion does result in the generation of the predominantly CH₄-CO₂ mixture which is widely referred as “biogas.”

Since the early years of the twentieth century, developing countries, notably China and India, had recognized the value of obtaining biogas from animal dung as a source of energy for the rural poor. From 1950s onwards these countries have made particularly strong efforts to popularize the use of “biogas plants.” But till the start of the 1970s, developed countries had paid little attention towards utilizing the biogas that was generated in the course of anaerobic treatment carried out by them of sewage sludge, animal manure, high-strength wastes, etc., because in developed countries at that time energy from fossil fuel and other conventional sources was abundant as well as cheap. Quite often the biogas generated from anaerobic digesters was simply flared off! Also, wastewater treatment was predominantly based on aerobic processes which consume a great deal of energy but do not generate any. This situation began to change slowly after the “oil shocks” of 1969 and 1973. More attempts were made than before to shift to anaerobic processes as far as possible as also to use the methane that was generated. As detailed later, several “high-rate” anaerobic reactors were developed to circumvent the major short-coming – the slowness – of conventional anaerobic digesters, in an endeavour to treat larger quantities of wastewaters with anaerobic processes.

1.2 How is Biogas Generated?

Anaerobic digestion involves bacterial fermentation of organic wastes in the absence of free oxygen. The fermentation leads to the breakdown of complex biodegradable organics in a four-stage process (Fig. 1.1):

1. Large protein macromolecules, fats, and carbohydrate polymers (such as cellulose and starch) are broken down through hydrolysis to amino acids, long-chain fatty acids, and sugars.
2. These products are then fermented during acidogenesis to form volatile fatty acids, principally lactic, propionic, butyric, and valeric acid.
3. In acetogenesis, bacteria consume these fermentation products and generate acetic acid, carbon dioxide, and hydrogen.

Fig. 1.1 The steps involved in anaerobic digestion (adopted from Rapport et al. 2008)

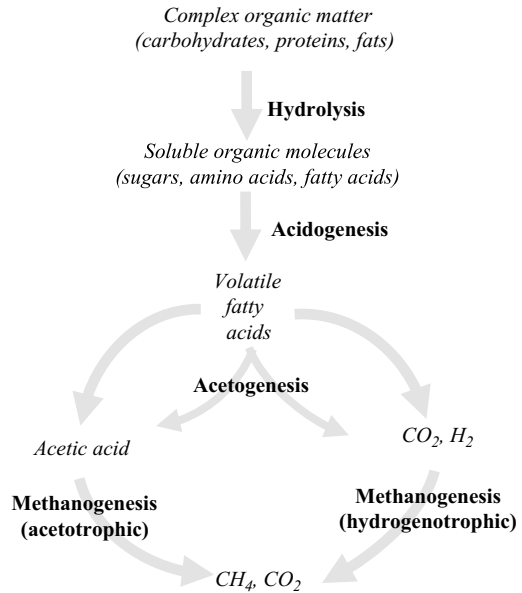

4. Methanogenic organisms consume the acetate, hydrogen, and some of the carbon dioxide to produce methane. Three biochemical pathways are used by methanogens to achieve this: (a) acetotrophic pathway ($4\text{CH}_3\text{COOH} \rightarrow 4\text{CO}_2 + 4\text{CH}_4$), (b) hydrogenotrophic pathway ($\text{CO}_2 + 4\text{H}_2 \rightarrow \text{CH}_4 + 2\text{H}_2\text{O}$), and (c) methylotrophic pathway ($4\text{CH}_3\text{OH} + 6\text{H}_2 \rightarrow 3\text{CH}_4 + 2\text{H}_2\text{O}$).

Methylated substrates other than methanol can also be converted. Acetotrophic pathway is the primary one; hence, theoretical yield calculations are often made using this pathway.

Theoretically, biogas should contain equal volumes (50–50) of methane and carbon dioxide. However, acetogenesis typically produces some hydrogen, and for every four moles of hydrogen consumed by hydrogenotrophic methanogens a mole of carbon dioxide is converted to methane. Fats and proteins can yield larger amounts of hydrogen leading to higher typical methane content for these substrates. In certain conditions, these molecules can also get converted to products other than methane. Therefore, the overall biogas yield and methane content varies for different substrates, biological consortia and digester conditions. The methane content of biogas can range from 40–70% (by volume) but more often than not it is in 55–65% range.

Wherever biogas is generated – be it from organic matter decomposing under anaerobic conditions in the open, or in captive anaerobic digesters, or in the guts of large ruminant animals, or by termites and some other smaller organisms – these four steps are principally involved. If the process is properly controlled in reactors so that it proceeds optimally as per these stages, the principal end product, the biogas, contains 40–70% (by volume) of methane gas, the rest being carbon dioxide

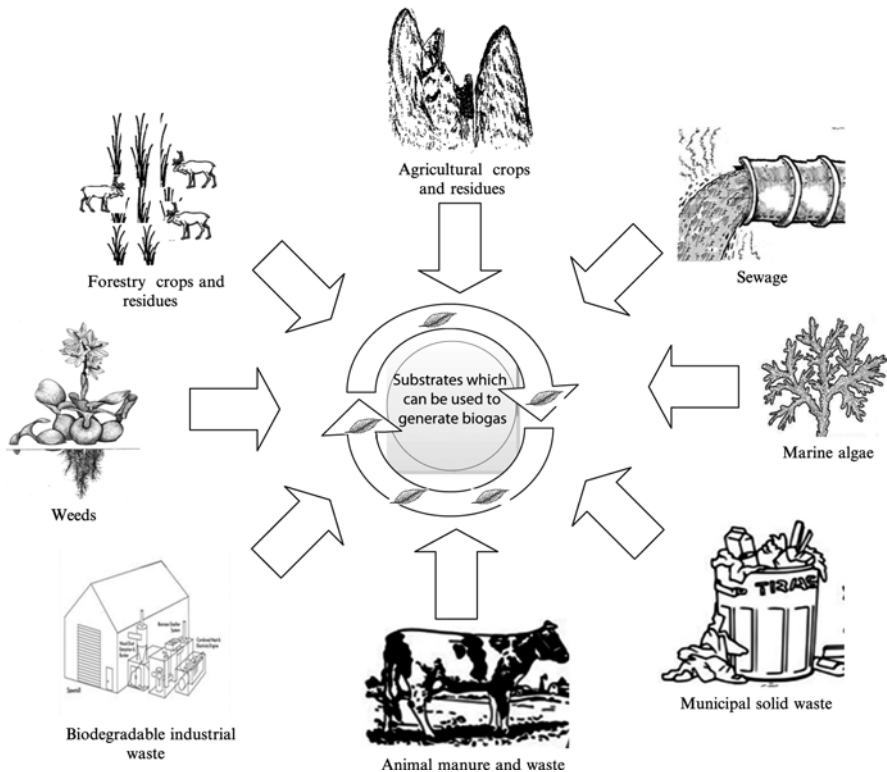

Fig. 1.2 Examples of substrates which can be anaerobically digested to generate biogas

and traces of ammonia, hydrogen sulphide, and hydrogen. This “biogas,” which is a convenient and clean fuel, can either be used directly with or without the removal of carbon dioxide or can be converted into electricity with the help of suitable generators. A wide variety of substrates can be used to generate biogas (Fig. 1.2).

Three physiological groups of bacteria are involved in the anaerobic conversion of organic materials. As illustrated in Fig. 1.1, the first group of hydrolysing and fermenting bacteria convert complex organic materials such as carbohydrates, proteins and lipids to fatty acids, alcohols, carbon dioxide, ammonia, and hydrogen. The second group of hydrogen-producing acetogenic bacteria convert the product of the first group into hydrogen, carbon dioxide, and acetic acid. The third group, in turn, consists of two physiologically different groups of methane-forming bacteria, one converting hydrogen and carbon dioxide to methane, and the other forming methane from decarboxylation of acetate (Balch et al. 1979; Boone and Bryant 1980; Bryant et al. 1967; Mah et al. 1977; McInerney et al. 1979; Mosey 1983; Hansson 1981; Nagar and Tietjen 1978; Abbasi and Abbasi 2011). The reactions and the bacteria generally involved in the anaerobic processes are presented in Table 1.2.

Table 1.2 Micro-organisms involved in anaerobic digestion

Stage	Bacteria
<i>Stage I</i>	
$(C_6H_{10}O_5)_n + nH_2O = n(C_6H_{12}O_6)$	
<i>Stage II</i>	
$C_6H_{12}O_6 + 2H_2O = 2CH_3COOH + 4H_2 + CO_2$	<i>Bacteriodes, clostridium</i>
$C_6H_{12}O_6 + 2H_2 = 2CH_3CH_2COOH + 2H_2O$	<i>Butyrivibrie, eubacterium</i>
$C_6H_{12}O_6 = CH_3CH_2CH_2COOH + 2CO_2 + 2H_2$	<i>Bifidobacterium, lactobacillus</i>
$C_6H_{12}O_6 = 2CH_3CHOHCOOH$	
$C_6H_{12}O_6 = 2CH_3CH_2OH + 2CO_2$	
<i>Stage III</i>	
$CH_3CHOHCOOH + H_2O = CH_3COOH + CO_2 + 2H_2$	<i>Desulfovibrio, syntrophobacter</i>
$CH_3CH_2OH + H_2O = CH_3COOH + 2H_2$	<i>Wolinii, syntrophomonas</i>
$CH_3CH_2CH_2COOH + 2H_2O = 2CH_3COOH + 2H_2$	
$CH_3CH_2COOH + 2H_2O = CH_3COOH + CO_2 + 3H_2$	
<i>Stage IV</i>	
$4H_2 + CO_2 = CH_4 + 2H_2O$	<i>Methanobacterium formicicum</i>
$2CH_3CH_2OH + CO_2 = 2CH_3COOH + CH_4$	<i>Methanobacterium bryantii,</i> <i>Methanobrevibacter</i>
$2CH_3(CH_2)_2COOH + 2H_2O + CO_2 = 4CH_3COOH + CH_4$	<i>Ruminantium, Methanobrevibacter</i> <i>arboriphilus</i>
$CH_3COOH = CH_4 + CO_2$	<i>Methanospirillum hungatei</i> <i>Methanosarcina barkeri</i>

1.3 Factors Which Influence Anaerobic Digestion of an Organic Substrate

Presence of adequate quantities of nitrogen, micro-nutrients, and water is essential if an organic substrate is to undergo anaerobic digestion and generate methane-rich biogas. These are essentially the requirements of micro-organisms named in Table 1.2, especially methanogenic bacteria. Because these micro-organisms are the “workers” who take the fermentation along the desired route and at optimum pace, generating conditions which help these micro-organisms ensures success of the process.

Some of the aspects which have to be kept in view for successful operation of an anaerobic digestion process for obtaining biogas are recounted below.

1.3.1 C/N Ratio

The relative proportions of carbon and nitrogen present in an organic material is expressed in terms of the carbon/nitrogen (C/N) ratio. C/N ratio in the range of 20–30 is considered to be optimum for anaerobic digestion.

If the C/N ratio is too high, the nitrogen is consumed rapidly by the methanogens to meet their protein requirement and is no longer available to react on the left-over carbon content in the material. As a result the biogas production gets depressed.

Table 1.3 C/N ratio of some biodegradable materials

Raw material	C/N ratio
Duck dung	8
Human excreta	8
Chicken dung	10
Goat dung	12
Pig dung	18
Sheep dung	19
Cow dung	24
Water hyacinth	25
Municipal solid waste	40
Elephant dung	43
Maize straw	60
Rice straw	70
Wheat straw	90
Saw dust	>200

If the C/N ratio is too low, nitrogen is liberated and accumulates in the form of ammonia. This increases the pH of the material. When pH value rises higher than 8.5 it begins to exert a toxic effect on the methanogenic bacteria.

Animal waste, such as cow dung, which has been the most preferred feed in low-rate biogas systems (Chap. 5), has an average C/N ratio of 24. Plant materials contain a high percentage of carbon and so the C/N ratio is high; for example, rice straw and sawdust have C/N ratios of 70 and 7,200 respectively (Table 1.3). Human excreta has a C/N ratio of about 8.

To maintain the C/N level of the digester material at optimum levels, materials of high C/N ratio can be mixed with materials of low C/N ratio.

1.3.2 Dilution

Water should be added, if necessary, to the raw material to generate a slurry which is neither too thick nor too thin. If a material is diluted too much, the solid particles may settle down in the digester and may not get degraded properly. If the slurry is too thick, it may be difficult to stir and may impede the flow of gas to the upper part of the digester. Different systems can handle different levels of slurry density, generally in the range of 10–25% of solids.

1.3.3 pH

Optimum biogas production is achieved when the pH value of the input mixture is between 6 and 7. During the initial period of digestion, large amounts of organic acids are produced and the pH of the mixture decreases. As digestion continues and the concentration of ammonia increases, due to the digestion of nitrogen, the pH

value increases. When the methane gas production stabilizes, the pH remains between 7.2 and 8.2.

When plant material is fermented in a batch system, the acetogenesis/fermentation stage is rapid, producing organic acids which reduce the pH and inhibit further digestion. In such situations, reduction in pH can usually be controlled with the addition of lime.

1.3.4 Temperature

Different species of methanogenic bacteria function optimally in three different temperature ranges: 50–65, 20–40, and <10°C. The concerned bacteria are called thermophilic, mesophilic, and psychrophilic, respectively. Outside these narrow ranges of temperature the concerned microbial consortia is not able to survive. Large-scale anaerobic digestion is generally carried out in the mesophilic mode with lesser number of digesters operating in thermophilic mode and much lesser in the psychrophilic mode.

The mesophilic temperature range is between 20 and 40°C but the mesophilic temperature considered to be most suitable for anaerobic digestion is 35°C. In thermophilic digestion 55°C is considered to be ideal.

Although thermophilic anaerobic digestion process is generally more efficient than the mesophilic process, it is more difficult to control and also needs extra energy inputs.

1.3.5 Loading Rate

This is an important process control parameter especially when the digestion is carried out in continuous mode – which is how it usually is. Overloading can easily lead to system failure. This can happen if there is inadequate mixing of the waste with slurry. It may cause a significant rise in volatile fatty acids concentration, leading to sharp drop in pH. When this happens feed rate to the system has to be reduced for a while till the process re-stabilizes.

1.3.6 Retention Time

“Retention time” is the duration for which organic material (substrate) and micro-organisms (“solids”) must remain together in a digester to achieve the desired extent of degradation. Shorter the “substrate retention time” required to achieve this objective in an anaerobic reactor, more efficient the reactor. But to achieve low “substrate retention times” it is necessary to simultaneously achieve high micro-organism (“solids”) retention times as explained in the following sub-sections.

1.3.6.1 Hydraulic Retention Time

The term commonly used to denote substrate retention time is “hydraulic retention time.” This is the time which an organic material, sought to be aerobically degraded, spends in a digester from the instant of its entry into the digester to its exit.

1.3.6.2 Solids Retention Time

“Solids” is the term commonly used to denote micro-organisms in a digester. It is not a precise term because most digester feeds contain suspended solids which are not necessarily made up of live biomass. So those solids are also present along with micro-organisms. Moreover, it is the “volatile solids” content in any substrate which participates in anaerobic digestion (non-volatile or “refractory” organics do not). Hence terms such as “high solids digestion” or “solid-feed digestion” are also commonly used in the biogas field (Chap. 7) wherein “solids” is not meant to denote micro-organisms. So the use of the term “solid” instead of “micro-organisms” in the context of micro-organisms retention time can be a source of confusion.

Nevertheless it is a part of the established jargon and hence we will also use it. Solids retention time (ST) is the duration for which active micro-organisms reside in a digester.

1.3.6.3 The Relationship Between HRT and SRT, and the Importance of “Food-to-Micro-organism Ratio”

At any given temperature, the micro-organisms present in a digester can only consume a limited amount of food each day. Hence in order to digest a given quantity of substrate one must supply adequate number of micro-organisms. The ratio of the quantity of substrate and to the quantity of bacteria available to consume that substrate is called the “food-to-micro-organism ratio” (F/M). This ratio is the controlling factor in all biological treatment processes. A lower than adequate F/M ratio will result in a greater percentage of the substrate being converted to biogas.

The only way in which F/M ratio can be kept adequately low even as we aim to reduce HRT (to enhance digester efficiency) is to find a way by which SRT is kept high. In other words, to find ways by which the substrate passes through the digester quickly but micro-organisms pass through much more slowly. This situation can ensure that at any given time more quantities of micro-organisms are present in a digester than substrate (hence low F/M ratio).

In conventional low-rate digesters (Chap. 5) and in the continuously stirred tank reactors (CSTRs), there is no provision to retain “solids” (micro-organisms). Hence the solids pass out of the digesters at the same rate as the substrate-to-be-degraded does. In other words, in those systems $HRT = SRT$. On the other hand, in high-rate digesters (Chap. 6), retention of micro-organisms by way of attached growth or

suspended growth systems, enables $SRT > HRT$. In a typical high-rate anaerobic digester, SRT is about three times higher than the HRT.

1.3.7 Toxicity

Mineral ions, especially of heavy metals, and detergents are among the materials that inhibit the normal growth of bacteria in a digester. Small quantities of minerals (sodium, potassium, calcium, magnesium, ammonium, and sulphur) stimulate the bacterial growth, but higher concentrations have a toxic effect.

Heavy metals such as copper, nickel, cobalt, chromium, zinc, and lead are essential for bacterial growth in very small quantities, but higher quantities have a toxic effect. Detergents such as soap, antibiotics, and organic solvents also inhibit the bacteria. Recovery of digesters following inhibition by toxic substances can only be achieved by cessation of feeding and flushing the contents or diluting the contents to push the concentration of inhibitory substances to below the toxic level.

1.3.8 Mixing/Agitation

Mixing is required to maintain fluid homogeneity, hence process stability, within a digester. The objectives of mixing are to combine the incoming material with the bacteria, to stop the formation of scum, and to avoid pronounced temperature gradients within the digester.

Very rapid mixing can disrupt the bacterial community while too slow a stirring can cause inadequate mixing and short-circuiting. The extent of mixing required is also dependent on the content of the digestion mixture.

1.3.9 Pathogens

Certain pathogenic bacteria and viruses present in municipal solid waste can pose risk of infection to the workers handling the waste for its anaerobic digestion. For sewage sludge and household wastes, which are regarded as having a higher infectivity risk than animal manure, pre-treatment processing at 70°C for at least 1 h is required.

1.3.10 Solid Residue/Slurry

After the anaerobic degradation is nearly complete, the solid residue or digestate is removed and is normally cured aerobically and screened for items such as glass shards, plastic pieces, etc., before being disposed on land.

The purity of the material fed into the system dictates the quality of the slurry that is produced.

References

- Abbasi T, Abbasi SA (2011) Formation and impact of granules in fostering clean energy production and wastewater treatment in upflow anaerobic sludge blanket (UASB) reactors. *Renew Sustain Energy Rev* (in press)
- Abbasi SA, Nipanay PC (1984) The catalytic effect of copper (II), zinc (II), and nickel (II) on the anaerobic digestion of *Salvinia molesta* (Mitchell). *Energy development: new forms, renewable, conservation* Pergamon, Oxford:237–247
- Abbasi SA, Nipanay PC (1985) Wastewater treatment using aquatic plants. Survivability and growth of *Salvinia molesta* (Mitchell) over waters treated with zinc (II) and the subsequent utilization of the harvested weeds for energy (biogas) production. *Resour Conserv* 12(1):47–55
- Abbasi SA, Nipanay PC, Schaumberg G (1990) Bioenergy potential of eight common aquatic weeds. *Biol Wastes* 34(4):359–366
- Abbasi SA, Nipanay PC, Soni R (1991) Occurrence, essentiality and toxicity of chromium. *J Inst Public Health Eng, India* 65:113–117
- Abbasi SA, Nipanay PC (1994) Potential of aquatic weed *Salvinia-Molesta* (Mitchell) for water-treatment and energy recovery. *Indian J Chem Technol* 1(4):204–213
- Abbasi SA, Krishnakumary P (1996) Biowaste treatment with anaerobic digestion- the dual role of heavy metals. In: 12th International Conference on Solid Waste Technology and Management, Philadelphia, USA, p 8
- Balch WE, Fox GE, Magrum LJ, Woese CR, Wolfe RS (1979) Methanogens: reevaluation of a unique biological group. *Microbiol Mol Biol Rev* 43(2):260
- Boone DR, Bryant MP (1980) Propionate-degrading bacterium, *Syntrophobacter wolinii* sp. nov. gen. nov., from methanogenic ecosystems. *Appl Environ Microbiol* 40(3):626
- Bryant M, Wolin E, Wolin M, Wolfe R (1967) *Methanobacillus omelianskii*, a symbiotic association of two species of bacteria. *Arch Microbiol* 59(1):20–31. doi:10.1007/BF00406313
- Hansson G (1981) Methane production and product inhibition, thermophilic methane fermentation and production of methane from algae. PhD Thesis, University of Lurd.
- Mah R, Ward D, Baresi L, Glass T (1977) Biogenesis of methane. *Annu Rev Microbiol* 31(1):309–341. doi:10.1146/annurev.mi.31.100177.001521
- McInerney MJ, Bryant MP, Pfennig N (1979) Anaerobic bacterium that degrades fatty acids in syntrophic association with methanogens. *Arch Microbiol* 122(2):129–135. doi:10.1007/BF00411351
- Ministry of new and renewable energy (2011) Booklets on renewable energy. MNRE. <http://mnre.gov.in/re-booklets.htm>. Accessed 4 May 2011
- Mosey F (1983) Mathematical modelling of the anaerobic digestion process: regulatory mechanisms for the formation of short-chain volatile acids from glucose. *Water Sci Technol* 15(8–9):209–232
- Nagar BRT, Tietjen C (1978) A status report on the use of biogas technology for increasing fuel and soil productivity. *J Sci Ind Res* 37:445–448
- Rapport J, Zhang R, Jenkins BM, Williams RB (2008) Current anaerobic digestion technologies used for treatment of municipal organic solid waste. Contractor Report to the California Integrated Waste Management Board, Department of Biological and Agricultural Engineering, University of California, Davis, CA

Chapter 2

A Brief History of Anaerobic Digestion and “Biogas”

Abstract This chapter briefly traces the history of anaerobic digestion from the time the existence of this phenomenon was first recorded four centuries ago to its rapidly increasing popularity at present. The extent of adaptation of biogas technology across the world is also briefly reviewed. Whereas China and India lead the initiative from among developing countries, the thrust of the developed world is mainly coming from Western Europe.

2.1 Introduction: Discovery of Biogas

It has been known from several centuries that combustible gas is generated when organic waste is allowed to rot in huge piles. For example in the seventeenth century, Van Helmont recorded that decaying organic material produced flammable gases. In 1776, Volta resolved that there was a direct connection between how much organic material was used and how much gas the material produced. That this combustible gas is methane was established by the work conducted independently by John Dalton and Humphrey Davy during 1804–1808 (Tietjen 1975).

Bechamp, in 1868, reported that the formation of methane during the decomposition of organic matter was through a microbiological process. Omelianski, in the 1890s, isolated microbes responsible for the release of hydrogen, acetic acid, and butyric acid during methane fermentation of cellulose. He also reported that methane perhaps formed due to micro-organism-mediated reaction between hydrogen and carbon dioxide (McCarty et al. 1982). Later, in 1910, Sohngen seconded Omelianski’s findings. He also reported that fermentation of complex materials occurs through oxidation-reduction reactions to form hydrogen, carbon dioxide, and acetic acid. He demonstrated that hydrogen then reacts with carbon dioxide to form methane. He also assumed that acetic acid through decarboxylation forms methane. This assumption remained highly controversial for decades but is now known to be essentially correct (McCarty et al. 1982).

2.2 Development of Anaerobic Digestion as a Wastewater Treatment Process

A Frenchman, Mouras, applied anaerobic digestion for the first time to treat wastewater, in his invention of a crude version of a septic tank in 1881, named by him “automatic scavenger” (McCarty et al. 1982). Subsequently an Englishman, Cameron, constructed a tank in 1895 which was similar to Mouras’s “automatic scavenger” but had better treatment efficiency, and termed it “septic tank.” Because of the successful results achieved in using these tanks, the local government of Exeter in 1897 approved the treatment of the entire city’s wastewater by these septic tanks. Moreover, the value of the methane gas which was generated during sludge decomposition in the septic tanks was recognized by Cameron and some of the gas was used for heating and lighting purposes at the disposal works (Chawla 1986).

During most of the following century, the development of anaerobic digestion technology remained exclusively linked to the stabilization of the putrescible solids from domestic wastewaters. This led to the design of heated, fully mixed, reactors of the type widely used even today for the digestion of sewage sludges and animal manures. Application of anaerobic digestion systems to industrial wastewater depollution was stimulated by the sharp rise in fossil fuel prices in the early 1970s and by the increasingly stringent pollution control regulations. The unsuitability of the conventional mixed digester for the treatment of industrial wastewaters of low-strength and of largely soluble organic composition, led to the concept of biological solids recycling and to the retention of active biomass within the digester. These developments in reactor designs, described in Chap. 6, have considerably enhanced the use of anaerobic digestion as a wastewater treatment process.

2.3 Biogas and Developing Countries

In developing countries, where energy is in short supply and expensive (on *per capita* and purchasing power basis, respectively), unlike the West, anaerobic digestion has a far greater relevance than it has to developed countries. Thus, anaerobic digestion in these countries has been primarily focused on energy production via biogas plants (Figs. 2.1 and 2.2). The thrust has been particularly strong in India and China; these two countries have, in a way, provided the lead for several other countries, especially in South-east Asia.

2.3.1 India

India is credited for having built the first-ever anaerobic digester, in 1897, when the Matunga Leper Asylum in Bombay (Mumbai) utilized human waste to generate gas to meet its lighting needs (Khanal 2008).



Fig. 2.1 Biogas use in Nepal (picture courtesy: SNV, Netherland Development Organization)



Fig. 2.2 Biogas use in Rwanda (photo courtesy: SNV, Netherland Development Organization)

The first-ever attempt to build a plant to produce biogas from manure was also made in India, at Bombay, in 1900, but it was not very successful. The first successful attempt came in 1937, when S.V. Desai – a microbiologist of the Indian Agricultural Research Institute (IARI), (then the Imperial Agricultural Research

Institute) – conducted studies leading to the commissioning of a plant which worked satisfactorily for several years.

Intensive research into the technology began only in the 1950s when several plant designs were developed. The most noteworthy of these, known as “Grama Laxmi III” was developed by Joshbai Patel (a Gandhian worker from Gujarat). It became the prototype for the later day’s Khadi and Village Industry Commission (KVIC) floating-dome model (Venkata Ramana 1991). After a lull, interest in biogas was renewed in the early 1960s when KVIC implemented and developed standard biogas plant designs for capacities varying from 3 to 14 m³d⁻¹ of gas output. During the same period, the government of Uttar Pradesh, India, established a “Gobar Gas Research Station” at Ajitmel. This station has introduced the “Chinese” design under the name “Janata biogas plant,” which is dome-shaped and is drumless. The Structural Engineering Research Centre, Roorkee, has developed and introduced ferro-cement gas holders instead of steel drums. This type of gas holder is believed to be cheaper, and with a longer life. It is also claimed to have lesser maintenance costs.

KVIC has also adopted the ferro-cement gas holders in some of its installations (Venkata Ramana 1991). In addition to the household biogas plants, community level biogas installations have been established to supply gas to families who did not own cattle. Encouraged by the promise of the technology, the Government of India had envisaged setting up one million family-sized plants and hundreds of community plants during the sixth five year plan. The thrust has continued through to the present (eleventh five year plan) and to-date close to four million biogas plants have been installed in India (MNRE 2011). The National Biogas and Manure Management Programme (NBMMP) had planned to set up 150,000 “family-type” biogas plants during 2009–2010. Several grass-root level voluntary agencies and self-employed trained workers are being involved in promoting and constructing these biogas plants, as well as providing maintenance services.

Public toilets incorporating biogas units has been an attractive option, especially in semi-urban areas and small towns in India which are not covered by proper waste treatment facilities and where extra energy in the form of biogas is welcome. But only about 150 community toilet complexes exist which have a biogas digester. This is mainly because the civic bodies that provide funding are either not aware of the importance of biogas systems or opt for the supposedly more “tried and tasted” septic tank alternative.

2.3.2 *China*

China has the largest biogas programme in the world. Over twenty five million households in China are using biogas by now, which accounts for over 10% of all rural households. By the end of 2005 there were 2,492 medium and large-scale biogas digesters in livestock and poultry farms, while 137,000 biogas digesters had been constructed for the purification of household wastewater.

In Sichuan Province alone, close to five million domestic biogas plants have been constructed by 2010. There is substantial government subsidy on biogas plants.

In order to help the growth of renewable energy sources, the Chinese government has established by law five systems to support the development of renewable energy resources – market fostering and protection, resource exploitation and planning, technical and industrial support, price support and cost sharing, and financial support and economic stimulation. These systems have been extended to support biogas energy as well, and various steps are being taken to industrialize the construction of biogas plants. For example the Shenzhen Puxin Science and Technology Company has developed a plant which is equipped with a glass-fibre-reinforced plastic gas holder to shorten the construction period and to avoid possible gas leakages through brick or concrete domes. Another private sector player, the Anhui Chizhou Xingye Natural Energy Developmental Company in Anhui Province, is producing a pre-fabricated fibreglass biogas plant in six pieces. It began production in 2002 and now claims to have a manufacturing capacity of 35,000 units per year.

Several stories of spectacular success have been reported. A few are recapitulated below.

Tianguan Alcohol Factory uses the dregs of the distiller to produce biogas in a 30,000 m³ digester, supplying more than 20,000 households or 20% of the population.

Meili village of Zhejiang Province produces 28,000 pigs, 10,000 ducks, one million ducklings and 100,000 chickens each year. In 2001, it installed digesters to treat 30 tonne of livestock and poultry wastes and night soil. This produces enough biogas for more than 300 households plus 7,200 tonne of organic fertilizer each year.

Hongzhi Alcohol Corporation Limited, which is the largest alcohol factory in south-western China, runs a service using industrial organic wastewater, sewage, and dregs to produce biogas. The service is paid for by the industry and the residents in cities, but is provided free to the farmers. The company has also built a biogas power plant generating seven million kilowatts per hour.

The city of Mianzhu treats 98% of municipal sewage including wastewater from hospitals through digesters with a total capacity of 10,000 m³. The treated water reaches national discharge standards, greatly improving the environment.

2.3.3 Nepal

In Nepal during 2004–2005, 17,803 domestic biogas plants were installed, bringing the total number installed since 1992 to over 140,000.

In recent years, as many as 62 biogas construction companies have been established in Nepal, along with 15 workshops for the manufacturing of biogas appliances. About 140 micro-finance institutes are involved in financing biogas plants in rural areas. These units have improved the social and environmental conditions of about 800,000 people.

The annual benefits for the average biogas household in Nepal have been estimated as savings of the use of firewood (2 tonne), agricultural residues (1 tonne), dried dung (250 kg), kerosene (70 kg), and chemical fertilizer (39 kg of nitrogen, 19 kg of phosphorous, and 39 kg of potassium). In addition, health benefits are realized through reduced indoor air pollution and attachment of a toilet to the biogas plant in

72% of all biogas households. The biogas support programme is generating direct employment for 11,000 persons and is believed to be particularly beneficial to women as it reduces drudgery (average of 3 h per day per household work) besides reducing deforestation and greenhouse gas emissions.

2.3.4 Vietnam

Vietnam has a large and expanding animal husbandry sector with high potential of biogas generation.

In Vietnam, as in other developing countries Colombia, Ethiopia, Tanzania, Cambodia, and Bangladesh the polyethylene tubular digester was promoted to reduce production cost by using local materials and simplifying installation and operation. The resulting low-cost digester has been well received by poor farmers, especially when farmers participate fully in the necessary maintenance and repair work. Within 10 years, more than 20,000 polyethylene digesters were installed and mainly paid by the farmers themselves. However, the digesters are still not fully integrated into the farming system, as there is only limited use of the effluent as fertilizer for fish and crops. There is also potential for improving the digester efficiency, ease of maintenance, and durability.

From 2003, the Vietnamese and the Netherlands governments are jointly implementing a domestic biogas dissemination project in 10 of Vietnam's 64 provinces. The project combines Vietnam's technical knowledge on plant design and construction with the Dutch experience with large-scale dissemination of domestic biogas. By the end of January 2006, 18,000 biogas plants had been installed.

The project is currently supporting construction of 180,000 domestic biogas plants in 58 provinces of Vietnam (Fig. 2.3).

2.3.5 Bangladesh

Dissemination of biogas technology in Bangladesh has been done mainly by the Bangladesh Council of Scientific and Industrial Research (BCSIR) and the Local Government Engineering Department (LGED). About 24,000 domestic biogas plants of different designs have been installed throughout the country. The fixed dome model has become the most popular of the models. Over 36,000 plants are expected to have been installed by 2010. About 75% of the existing plants are said to be functioning well while about 10% are defunct.

2.3.6 Sri Lanka

Although biogas digesters have been introduced in Sri Lanka in the 1970s, poor design, lack of maintenance skills and insufficient capacity to deal with the problems



Fig. 2.3 Biogas plants being put up in Vietnam (photo courtesy: SNV, Netherland Development Organization)

meant that only a third of the 5,000 installed units have functioned properly. The Intermediate Technology Development Group (ITDG) started a project in 1996 to improve the success rate of the units on a national level by setting up demonstration units to help spread information, restore abandoned units and train users to operate and maintain them. In addition, individual farmers get help to install biogas units on their farms to make use of the manure from their cows.

2.3.7 *Other Developing Countries*

All other developing countries are striving to enhance methane capture and use via biogas plants. Livestock rearing and manure generation is always plentiful in developing countries but is also, almost always, highly dispersed unlike in developed countries. This facet generates major challenges and impediments.

2.4 Use of Anaerobic Digestion Elsewhere

Elsewhere in the world anaerobic digestion was used but primarily as a process for treating high-COD waste rather than as a means of generating energy (biogas). By the mid-1950s, France had over 1,000 anaerobic installations in various farm operations, which varied from simple covered tanks to complex digestion systems (Lesage and Abiet 1952). In West Germany, this technology reached its peak in 1944–1945; the press gave wide coverage to the idea of using agricultural wastes in this process as feed and also about the development of different types of anaerobic plants. According to Van Brakel (1980), a large number of digesters began to be installed in countries such as Nepal, Pakistan, Bangladesh, Thailand, Malaysia, Indonesia, Papua New Guinea, the Philippines, Fiji Islands, Egypt, Uganda, Tanzania, Ethiopia, Zambia, Nigeria, Mexico, Brazil, and many others. Since 1975, a number of these countries, in particular South-east Asian countries, have begun to give a thrust at the government level to exploit the potential of anaerobic digestion.

In Japan, anaerobic digestion has received considerable attention during the last few years from the point of view of pollution control, and for the treatment of livestock, industrial, and urban waste. Japan is the only country in the region which has adopted thermophilic (high temperature; see Chap. 1) digestion of some wastes.

In the USA, Canada, and Western Europe anaerobic digestion has been used mainly for processing animal manure till the mid-1970s. The advancements in high-rate anaerobic digesters began with the introduction of anaerobic filter in 1967. It was followed by the introduction, one after another, of several other forms of anaerobic digesters capable of treating a wide variety of biodegradable wastewaters. These aspects have been detailed in Chap. 6. Developed countries have given the initial thrust towards waste water treatment using anaerobic digesters and it is being increasingly followed all over the world. These reactors do not, normally, generate *net* energy; in other words the biogas they generate does not provide more energy than is invested in running the digesters but they do significantly reduce net energy *consumption* relative to aerobic processes. Anaerobic digesters also generate lesser quantities of sludge which is easier to dispose than aerobic sludge.

Anaerobic digestion and aerobic composting of waste originating from kitchens, food processing units, and gardens is well established in Europe. By the end of 2006, there were some 124 anaerobic digestion plants with capacity greater than 3,000 tonne/year treating feedstock composed of at least 10% MSW. The combined capacity was about four million tonne per year which is 4 times and 15 times the

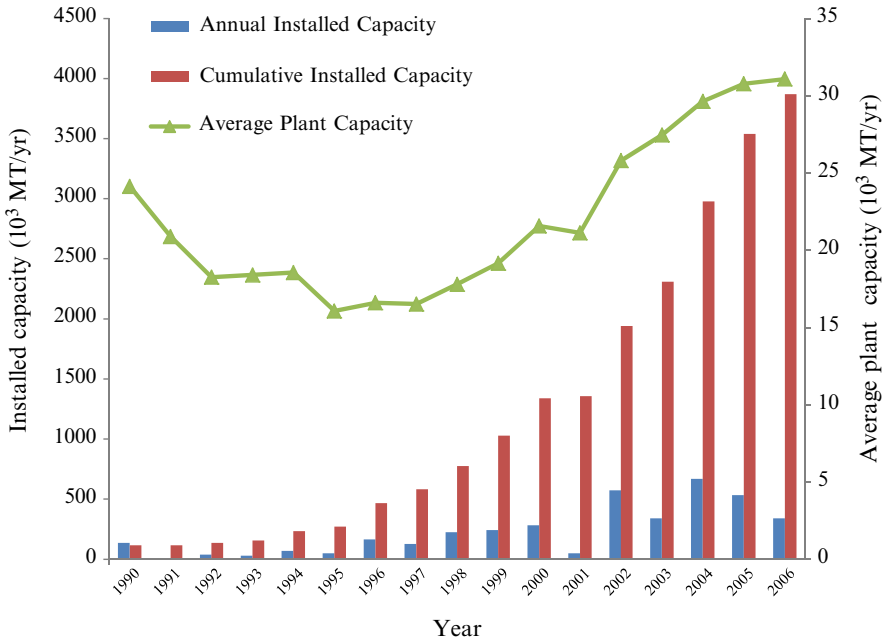

Fig. 2.4 Growth of anaerobic digestion capacity in Europe (adopted from De Baere 2006)

capacity that existed in 2000 and 1990, respectively (Fig. 2.4). This reflects the sharply rising trend in the use of anaerobic digestion in Europe.

Yet, despite the dramatically increased use of anaerobic digestion, only about 3% of biodegradable solid waste in Europe is being treated anaerobically. This points to the enormous potential that is lying untapped. Spain, Belgium, Holland, Switzerland, and Germany have the largest *per capita* anaerobic digestion capacities among the larger European countries. Spain treats about 10% of its organic waste using anaerobic digesters (Fig. 2.5). It must be clarified that whereas Germany has the largest anaerobic digestion plant installed capacity, Spain leads in terms of capacity:population ratio.

At present, Germany has over 4,000 biogas plants with about 1.5 GW of biogas-based electricity production (Fig. 2.6). Most of the new biogas plants have an electrical capacity between 400–800 kW. The first industrial biogas energy park, Klarsee, with 40 biogas plants (total capacity 20 MW) has come into operation. Maize, corn, and wheat are the main substrates (Fig. 2.7); manure constitutes less than 50%. This has given rise to the criticism that food crops are being diverted to energy production in developed countries even as millions in the developing world do not have adequate food to eat.

Currently, there are quite a few large biogas digesters at wastewater treatment plants, MSW treatment plants, landfill gas installations, and industrial bio-waste processing facilities throughout Europe, and more are under construction. Biogas is being increasingly used to generate electricity (Fig. 2.8) or in space heating

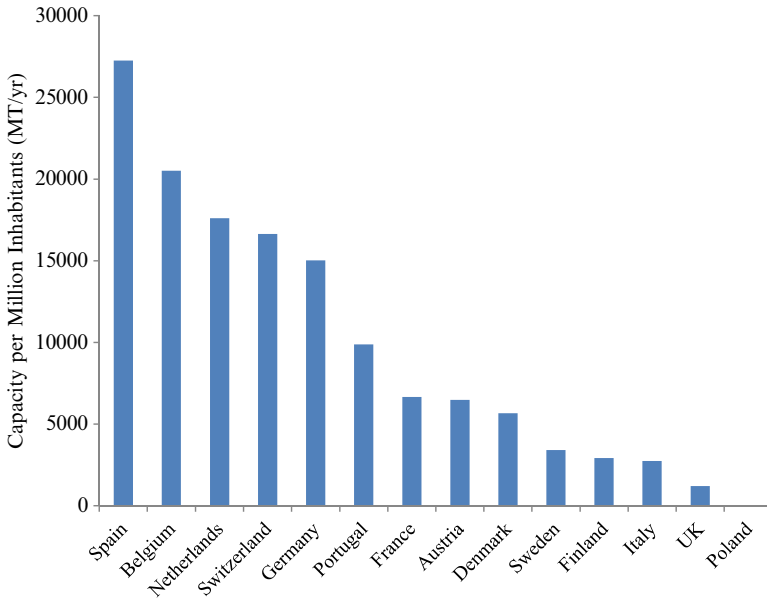

Fig. 2.5 Use of anaerobic digestion per million inhabitants in European countries (adopted from De Baere 2006)

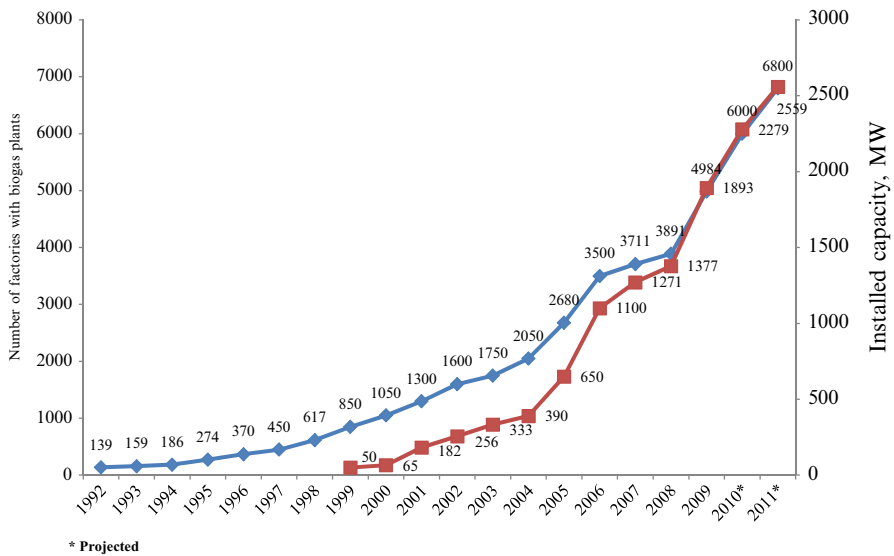

Fig. 2.6 Biogas plants in Germany (dx) and the rise in biogas-based power generation (dx) (adopted from Stolpp 2010)

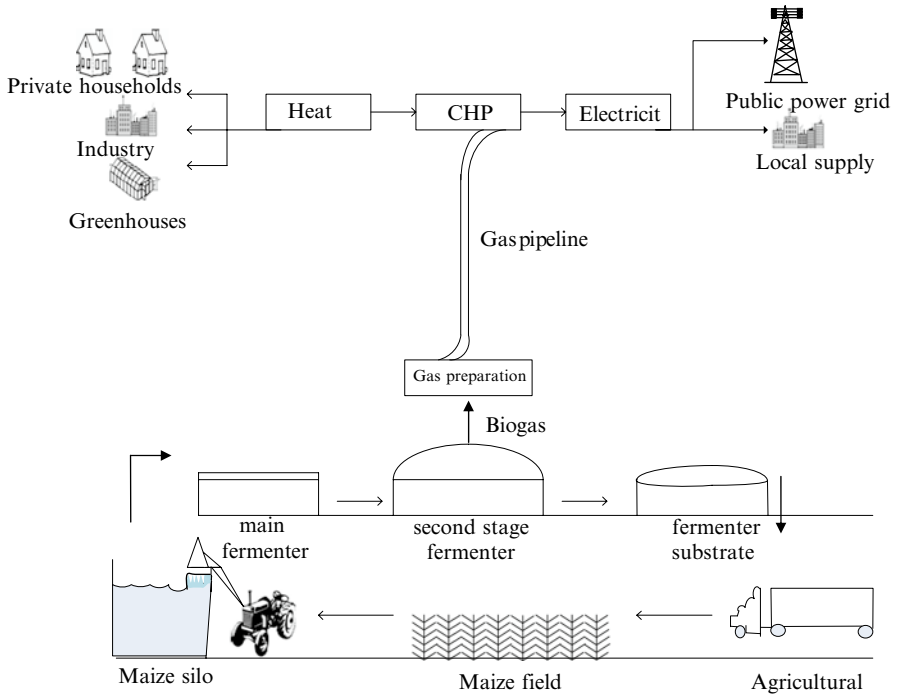

Fig. 2.7 A typical maize-based biogas plant in Germany



Fig. 2.8 Generator set utilizes biogas, for generating electricity (photo courtesy: AgSTAR)



Fig. 2.9 A heat exchanger working with a biogas-fed engine-generator set to utilize heat for space and water heating (photo courtesy: AgSTAR)

(Fig. 2.9). It has been predicted that by 2020, the largest volume of produced biogas will come from farms and large co-digestion biogas plants, integrated into the farming and food-processing structures. These aspects have been covered in greater detail in Chaps. 5–8.

References

- AgSTAR (2011) AD 101 Biogas recovery systems. US EPA. <http://www.epa.gov/agstar/anaerobic/ad101/index.html>. Accessed 1 May 2011
- Chawla OP (1986) Advances in biogas technology. Publications and Information Division, Indian Council of Agricultural Research, New Delhi
- De Baere L (2006) Will anaerobic digestion of solid waste survive in the future? *Water Sci Technol* 53(8):187–194. doi:10.2166/wst.2006.249
- Khanal SK (2008) Anaerobic biotechnology for bioenergy production: principles and applications. Wiley-Blackwell, Ames
- Lesage E, Abiet P (1952) Gaz de fumier: dernières techniques de production et d’utilisation (Gas from manure – the latest production techniques and use) (in French). Diffusion nouvelle du livre (The diffusion of new books), Soissons, France
- McCarty PL (1982) One hundred years of anaerobic treatment. In: Hughes DE, Stafford DA, Wheatley BI et al (eds) Anaerobic digestion, 1981: proceedings of the second international symposium on anaerobic digestion. Elsevier Biomedical, Amsterdam, pp 3–22

- Ministry of New and Renewable Energy (2011) Booklets on renewable energy. MNRE. <http://mnre.gov.in/re-booklets.htm>. Accessed 4 May 2011
- SNV (Personal communication) (2009) Seeking permission to publish. SNV Netherland Development Organization, Netherlands
- Stolpp S (2010) Biogas market in Germany. German Biogas Association. http://www.crossborder-bioenergy.eu/fileadmin/user_upload/Stolpp.pdf. Accessed 1 May 2011
- Tietjen C (1975) From biodung to biogas-a historical review of the European experience. In: Jewell WJ (ed) Energy, agriculture, and waste management: proceedings of the 1975 Cornell Agricultural Waste Management Conference. Ann Arbor Science, Ann Arbor, pp 207–260
- van Brakel J (1980) The ignis fatuus of biogas: small-scale anaerobic digesters (“ biogas plants”): a critical review of the pre-1970 literature. Delft University Press, Delft, The Netherlands
- Venkata Ramana P (1991) Biogas programme in India. TIDE 1(3):1–18

Chapter 3

Biogas and Global Warming

Abstract The virtues of biogas as a clean fuel have been known since the late nineteenth century but the great resurgence of interest in biogas capture – hence methane capture – is due to the rapidly growing spectre of global warming (GW). Anthropogenic causes, which directly or indirectly release methane into the atmosphere, are responsible for as much as a third of the overall *additional* GW that is occurring at present. Hence the dual advantage of methane capture – generating energy while controlling GW – have come to the fore.

This chapter presents an overview of the natural and the anthropogenic sources that contribute methane to the atmosphere. In this context, it underscores the urgency with which the world must develop and implement methods and practices to enhance methane capture.

3.1 Introduction

An entirely new dimension to the implications of anaerobic digestion has been added in recent years. This has occurred after the impacts of global warming (GW) have become apparent and after the world has arrived at an almost complete consensus that GW is neither a figment of some people's imagination, nor an hyped-up possibility (as a lot of people believed till a few years back), but a very real and a very serious threat to the entire world.

It is also now a well-accepted fact that methane is a powerful greenhouse gas, each molecule of methane causes about 25 times more GW than a molecule of CO₂ (IPCC 2007). If we do not process organic waste and recover methane from it but, instead, allow the waste to rot in the open we will let the methane escape into atmosphere to cause GW. The dung of rumen lying in the open, the biodegradable part of municipal solid waste which is dumped here and there, the dead plants decaying at the bottom of lakes and ponds, the human excreta or sewage disposed on land, the wastewaters high in COD of food processing, tanneries, distilleries and other industries discharged in public swears, etc. – all of these emit methane. Consequently

Table 3.1 Top five methane-emitting countries: 2005 estimates^a (World Resources Institute, Washington 2009)

Country	Million MT (Tg) CO ₂ e	% of world total
China	853	13
India	548	9
USA	521	8
European Union	449	7
Brazil	389	6

^aExcludes land use change

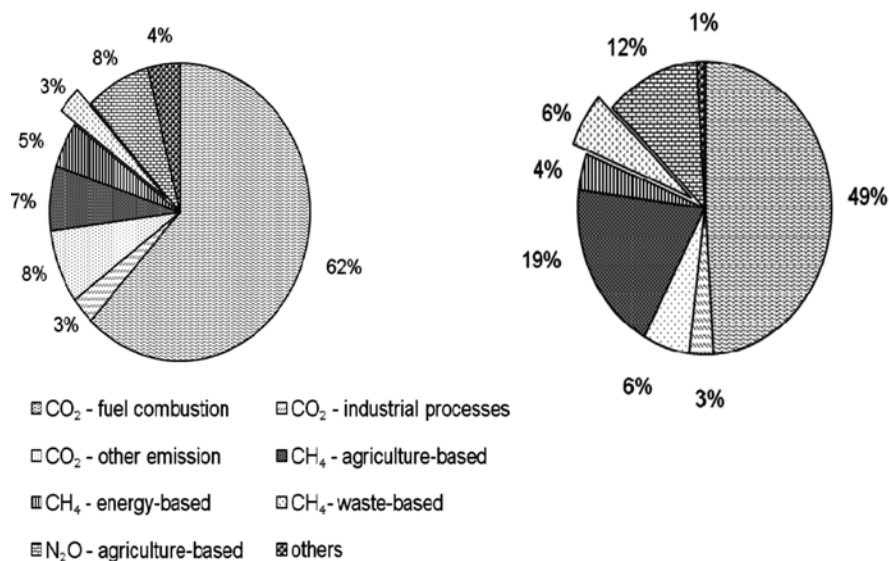

Fig. 3.1 Relative contributions of different sources of greenhouse gas emissions in the world (left) and in Asia

they all contribute to GW. Methane is anyway generated in nature as a result of the decay of plant and animal matter but there are also natural sinks which remove excess methane. Due to this natural balance between the sources and the sinks of methane, the tropospheric methane levels have hovered around 700 parts per billion for thousands of years. But the extra methane generated due to anthropogenic activities over the last 200 years has contributed to the rise of tropospheric methane levels by 150% (Blasing 2008). As each molecule of methane has GW potential 25 times greater than the GW potential of a molecule of CO₂, the “radiative forcing” by methane has contributed nearly a third to the GW that has occurred. According to an estimate (Table 3.1), China leads the world in methane emissions, followed by India and the USA. The contribution of different sources of methane to GW, in comparison to sources of CO₂ and N₂O, is represented in Fig. 3.1.

To put it in other words, if the “biogas” potential of organic matter, especially organic waste, is not harnessed and utilized by us, it becomes a major source of GW. This realization has generated new impetus for the recovery of biogas wherever possible and the development of “methane capture technologies” in general.

3.2 Sources of Methane: General

Methane is emitted from a variety of both anthropogenic (human-related) and natural sources. Anthropogenic activities include fossil fuel production, animal husbandry (enteric fermentation in livestock and handling of manure), agriculture (especially rice cultivation), biomass burning, and treatment/disposal systems for biodegradable liquid/solid wastes.

It is estimated that more than 60% of global methane emissions are related to these anthropogenic activities (IPCC 2007).

Methane is also released in nature from wetlands, gas hydrates, permafrost, termites and other rumens, oceans, freshwater bodies, non-wetland soils, and other sources such as degrading vegetation and wildfires.

The extent of methane emission from a source can vary significantly from one country or region to another, depending on factors such as climate, manner of industrial, agricultural, and waste management practices, and extent of provision available for methane capture. Temperature and moisture have a particularly significant effect on the anaerobic digestion process, which is one of the key biological processes that cause methane emissions in both human-related and natural sources. Also, the implementation of technologies to capture and utilize methane from sources such as landfills, coal mines, and manure management systems affects the emission levels from these sources.

3.2.1 Human-Related Sources

3.2.1.1 Landfills

Methane is generated in landfills and open dumps as biodegradable component of the waste contained in them decomposes under anaerobic conditions (i.e., in absence of free oxygen, as explained in Chap. 1). The amount of methane evolved depends on the quantity and moisture content of the waste and the design and management practices at the site. Landfills are among the largest human-related sources of methane in developed countries. In some of the developed countries, for example the USA, landfill also happens to be the biggest anthropogenic source of methane, accounting for 34% of all methane emissions.

3.2.1.2 Natural Gas and Petroleum Systems

Natural gas is largely made up of methane. Hence methane losses occur during the production, processing, storage, transmission, and distribution of natural gas. Because gas is often found in conjunction with oil, the production, refinement, transportation, and storage of crude oil also leads to similar fugitive methane emissions.

3.2.1.3 Coal Mining

Methane lies trapped in coal deposits and in the surrounding strata. Mining operations, in both underground and surface mines, “unlock” this methane, leading to its release. In addition, handling of the coal after mining results in methane emissions.

3.2.1.4 Livestock Enteric Fermentation

Ruminant animals (cattle, buffalo, sheep, goat, and camel) produce significant amounts of methane as part of their normal digestive processes. In the rumen (large fore-stomach) of these animals, microbial fermentation converts feed into products that can be digested and utilized by the animal. This microbial fermentation process (enteric fermentation) produces methane as a by-product, which is exhaled by the animal. Methane is also produced in smaller quantities by the digestive processes of other animals, including humans, but emissions from these sources are insignificant.

3.2.1.5 Handling Manure Management

Livestock manure keeps releasing methane due to the anaerobic decomposition of organic material contained in the manure by bacteria excreted along with the manure by the animal. Manure deposited on fields and pastures, or otherwise handled in a dry form, produces significant amounts of methane. Manure lagoons and holding tanks, which are commonly used at larger dairy and swine operations, also release significant quantities of methane.

3.2.1.6 Wastewater Treatment

In the course of treatment of biodegradable wastewater from domestic and industrial sources for removing soluble organic matter, suspended solids, pathogenic organisms, and chemical contaminants, methane is produced and is released to atmosphere whenever anaerobic conditions develop. This may happen often with the sludge that separates during sedimentation due to the high BOD of the sludge; this rapidly leads to the total depletion of dissolved oxygen in the sludge and development of anaerobic conditions, resulting in methane emissions. These emissions can be avoided by treating the wastewater and the associated sludge under aerobic conditions or by capturing methane that is released under anaerobic conditions.

3.2.1.7 Agriculture

Methane is produced during agriculture whenever anaerobic conditions develop. This happens most significantly in the paddy fields flooded for rice cultivation. Flooded soils are ideal environments for methane production because of their high levels of organic substrates, oxygen-depleted conditions, and moisture. The level of

emissions varies with soil conditions, type of cultivar, agricultural practices, and climate. Tables 3.2 and 3.3, which summarize data pertaining to rice paddies of India, provide an indication of the very wide variation in methane emissions that is possible between one paddy field and the other. By suitably modifying the agricultural practices, methane emissions from rice cultivation can be significantly reduced.

3.2.2 Natural Sources

Emissions of methane from natural sources arise largely due to organic matter undergoing anaerobic fermentation in soils, wetlands, oceans, and animal gut. The estimates of the total methane emissions range from 135 Tg (135×10^{12} g) per year to 300 Tg per year (IPCC 2007). The wide span indicates the uncertainty involved, which stems from the variability of environmental factors that influence methane production.

3.2.2.1 Wetlands

Natural wetlands generate by far the largest quantity of methane from among natural sources, accounting for 100–231 Tg per year. The bacteria associated with methanogenesis require environments with no free oxygen and abundant organic matter, both of which are present in most wetlands, especially in the hypolimnic zone.

3.2.2.2 Termites

Termites are known – alongside ants and earthworms – as one of the three classes of “soil engineers” which have been crucial to the maintenance of soil productivity and facilitating plant growth on earth. All the three groups of animals, especially ants and termites, exist in very large numbers (estimated to be over a trillion each). Of these, termites harbour the most diverse microflora in their guts, enabling many species to even fix nitrogen. Termites also harbour methanogens.

Global emission of methane due to termites is estimated to be between 20 and 29 Tg per year, making termites the second largest natural source of methane emissions. The amount generated varies among different species. Also, the contribution of termites in different regions depends largely on the population of these animals, which also varies significantly among different regions of the world.

3.2.2.3 Oceans

Oceans are estimated to emit approximately 10 Tg (range 4–15 Tg) of methane per year. The source of methane from oceans is not entirely clear, but two identified sources include the anaerobic digestion in marine zooplankton and fish, and methanogenesis in sediments and drainage areas along coastal regions.

Table 3.2 A summary of report on methane emissions from paddy fields in India, indicating wide variations between site to site

State/region	Specific site	Period; frequency of observations	Methane emissions (mg/m ² h)	References
New Delhi	Indian Agricultural Research Institute, New Delhi	July–Nov 2004; interval of 15 min for 1 h	8,040 to 20,920 (IARI soil) 1,047 to 10,910 (Raipur soil)	Singh (1997)
Orissa	Central Rice Research Institute, Cuttaack	June–Oct 1994; 9,00 to 9,30 h and 15.00 to 15.30 h	13,16	Adhya (1998)
New Delhi	Indian Agricultural Research Institute, New Delhi	105 days; every 20 min for 40 min	2,450 to 3,720	Ghosh (2003)
Assam	Kahikuchi, Guwahati	4 months; every 15 min for 45 min	9,740 to 11,310	Gogoi (2005)
Assam	–	–	8,830 to 18,630	Gogoi (2008)
New Delhi	National Physical Laboratory	Every 15 min for 30 min	41.73	Parashar (1996)
Orissa	Central Rice Research Institute, Cuttaack	Every 15 min for 60 min, twice a day	17.59	Datta (2009)
New Delhi	Indian Agricultural Research Institute	4 years; every 10 min for 20 min	0.59	Jain (2000)

Table 3.3 Seasonal integrated flux (E_{site}) of methane as estimated at various sites; this again reflects very high inter-site variation

State/region	Specific site	Period; frequency of observations	Methane emission, E_{site} (mg m^{-2})	References
Assam	Amalopam, Tezpur Central University	2 years; sampling was done for once in 7 days, twice a day (at 9 am and 2 pm) and regular interval of 15 min for an hour	6,435	Das and Baruah (2008)
Assam	Amalopam, Tezpur Central University	2 years; sampling was done for once in 7 days, twice a day (at 9 am and 2 pm) and regular interval of 15 min for an hour	1,170	Das and Baruah (2008)
Assam	Amalopam, Tezpur Central University	2 years; sampling was done for once in 7 days, twice a day (at 9 am and 2 pm) and regular interval of 15 min for an hour	10,600	Das and Baruah (2008)
Assam	Tezpur	6 months; sampling was done for once in 7 days, twice a day (at 9 am and 2 pm) and regular interval of 15 min for an 45 min	10,565	Baruah (2010)
Assam	Titabar Farms-AAU, Jorhat (upper Brahmaputra valley zone)	1 year	8,160	Gupta et al. (2009)
Andhra Pradesh	NRSA, Hyderabad	Not stated	5,020	Gupta et al. (2009)
Delhi	National Physical Laboratory	1 year	1,080	Gupta et al. (2009)
Kerala	RRL, Trivandrum	Not stated	3,027	Gupta et al. (2009)
Orissa	Baliaanta, near Bhubaneswar	Not stated	5,090	Gupta et al. (2009)
Orissa	CRRF farms, Cuttaack	1 year	30,175	Rath (1999)
Uttar Pradesh	Banaras Hindu University, Varanasi	Not stated	20,775	Singh (1998)
West Bengal	IRPE, Gabbertia, Lakshmikantapur	Not stated	18,010	Gupta et al. (2009)

3.2.2.4 Methane Hydrates

Methane hydrates are solid deposits composed of cages of water molecules that contain molecules of methane. The solids can be found deep underground in Polar Regions and in ocean sediments of the outer continental margin throughout the world. Methane can be released from the hydrates with changes in temperature, pressure, salt concentrations, and other factors. Overall, the amount of methane stored in these hydrates globally is estimated to be very large. Hence there is a potential for very large releases of methane from this source if something happens to cause a breakdown in the stability of the deposits.

Global emissions from methane hydrates are estimated to be around 4–10 Tg of methane per year. But due to much larger potential for emissions from hydrates, there is much ongoing scientific research related to analyzing and predicting how changes in the ocean environment may affect the stability of the hydrates.

3.2.2.5 Geologic Sources

One of the dominant sources of geologic methane is mud volcanoes. These structures can be up to 10 km in diameter, though most are much smaller, and often form on tectonic plate boundaries or near fossil fuel deposits. Over 1,000 such structures have been located on land or in shallow water. Mud volcanoes release methane from within the earth, as well as smaller amounts of carbon dioxide, nitrogen, and helium. Other structures which emit methane that would qualify as geologic sources include gryphons, steam vents, and bubbling pools. About 4–14 Tg of methane is emitted from geologic sources.

3.2.2.6 Wildfires

Wildfires are estimated to release between 2 and 5 Tg of methane per year. Methane is released during fires due to incomplete combustion of organic material. Fires also lead to the release of large amounts of methane from soil, especially in high-latitude regions, where fires melt permafrost to release methane that was trapped in the soil below. Moreover, warmer soil temperatures after fire events lead to greater microbial activity, which increases the diffusion of methane from soils to the atmosphere.

3.2.2.7 Wild Animals

Aside termites several other species of animals release methane in the wild, for example bison. It has been suggested that methane emissions from wild animals could be up to 15 Tg per year.

3.3 Sources of Methane in the Form of Biogas Produced Due to Anthropogenic Causes

Whereas coal mining and production of natural gas/oil generates nearly pure methane, the other five anthropogenic activities listed in Sect. 3.2.1 produce the methane–CO₂ mixture that is usually called “biogas.” Of these five activities, the quantities of biogas exhaled by livestock are difficult to control and there is little that can be done about it. Of the remaining four activities agriculture can be made a lesser emitter of methane by proper soil and water management, and proper choice of cultivar, to minimize development of conditions favourable for anaerobic digestion. It is the remaining three activities – landfills, handling of manure, and wastewater treatment, which provide opportunities to not only reduce fugitive biogas emissions but also capture much of the generated biogas for use as energy source.

Well-established technology exists for generating biogas from animal manure. The details are presented in Chap. 5. Likewise several types of reactors are available to anaerobically digest different types of biodegradable wastewaters to obtain biogas (Chap. 6). By using these technologies, and by careful management of manure and wastewater to reduce fugitive biogas emissions, a major portion of methane generated in the biogas can be captured. Capture of biogas is also possible from landfills but to a maximum extent of 60%. This aspect is covered in Chap. 8. Municipal solid waste (MSW), phytomass, and other forms of biodegradable solid waste have enormous potential of supplying biogas but there are technological problems yet to be overcome. These aspects are discussed in Chap. 7.

References

- Adhya TK, Pattnaik P, Satpathy SN, Kumaraswamy S, Sethunathan N (1998) Influence of phosphorus application on methane emission and production in flooded paddy soils. *Soil Biology and Biochemistry* 30(2):177–181
- Baruah K, Gogoi B, Gogoi P (2010) Plant physiological and soil characteristics associated with methane and nitrous oxide emission from rice paddy. *Physiology and Molecular Biology of Plants* 16(1):79–91
- Blasing T (2008) Recent greenhouse gas concentrations. US Department of Energy, Carbon Dioxide Information Analysis Center (CDIAC). http://cdiac.ornl.gov/pns/current_ghg.html. Accessed 4 May 2011
- Das K, Baruah K (2008) A comparison of growth and photosynthetic characteristics of two improved rice cultivars on methane emission from rainfed agroecosystem of northeast India. *Agriculture, Ecosystems & Environment* 124(1–2):105–113
- Datta A, Nayak D, Sinhababu D, Adhya T (2009) Methane and nitrous oxide emissions from an integrated rainfed rice-fish farming system of Eastern India. *Agriculture, Ecosystems & Environment* 129(1–3):228–237
- Ghosh S, Majumdar D, Jain MC (2003) Methane and nitrous oxide emissions from an irrigated rice of North India. *Chemosphere* 51(3):181–195
- Gogoi N, Baruah K, Gogoi B, Gupta PK (2005) Methane emission characteristics and its relations with plant and soil parameters under irrigated rice ecosystem of northeast India. *Chemosphere* 59(11):1677–1684

- Gogoi N, Baruah K, Gupta PK (2008) Selection of rice genotypes for lower methane emission. *Agronomy for Sustainable Development* 28(2):181–186
- Gupta PK, Gupta V, Sharma C, Das SN, Purkait N, Adhya TK, Pathak H, Ramesh R, Baruah KK, Venkatratnam L, Singh G, Iyer CSP (2009) Development of methane emission factors for Indian paddy fields and estimation of national methane budget. *Chemosphere* 74(4):590–598
- Intergovernmental Panel on Climate Change (2007) *Climate change 2007: working group III: mitigation of climate change. IPCC fourth assessment report (AR4)*. IPCC, Paris
- Jain M, Kumar S, Wassmann R, Mitra S, Singh S, Singh J, Singh R, Yadav A, Gupta S (2000) Methane emissions from irrigated rice fields in northern India (New Delhi). *Nutrient Cycling in Agroecosystems* 58(1):75–83
- Parashar DC, Mitra AP, Gupta PK, Rai J, Sharma RC, Singh N, Koul S, Ray HS, Das SN, Parida KM, Rao SB, Kanungo SP, Ramasami T, Nair BU, Swamy M, Singh G, Gupta SK, Singh AR, Saikia BK, Batua AKS, Pathak MG, Iyer CSP, Gopalakrishnan M, Sane PV, Singh SN, Banerjee R, Sethunathan N, Adhya TK, Rao VR, Palit P, Saha AK, Purkait NN, Chaturvedi GS, Sen SP, Sen M, Sarkar B, Banik A, Subbaraya BH, Lal S, Venkatramani S, Lal G, Chaudhary A, Sinha SK (1996) Methane budget from paddy fields in India. *Chemosphere* 33(4):737–757
- Rath A, Mohanty S, Mishra S, Kumaraswamy S, Ramakrishnan B, Sethunathan N (1999) Methane production in unamended and rice-straw-amended soil at different moisture levels. *Biology and Fertility of Soils* 28(2):145–149
- Singh J, Raghubanshi A, Reddy V, Singh S, Kashyap A (1998) Methane flux from irrigated paddy and dryland rice fields, and from seasonally dry tropical forest and savanna soils of India. *Soil Biology and Biochemistry* 30(2):135–139
- Singh S, Kumar S, Jain MC (1997) Methane emission from two Indian soils planted with different rice cultivars. *Biology and Fertility of Soils* 25(3):285–289. doi:10.1007/s003740050316
- World Resources Institute (2009) *Climate Analysis Indicators Tool (CAIT) Version 6.0*. Washington, DC

Chapter 4

Low-Rate and High-Rate Anaerobic Reactors/ Digesters/Fermenters

Abstract The aim of this chapter is to explain the difference between the so-called “biogas digesters” popular in the developing countries and the broader terms of “anaerobic digesters/reactors/fermenters.” The chapter also deals with the difference between “low-rate” and “high-rate” anaerobic systems, and describes the techniques with which the former can be converted to the latter.

4.1 General

Before proceeding with a description of anaerobic digesters/reactors/fermenters it must be clarified that all the three terms basically mean the same thing and can be used interchangeably. In the anaerobic process the bacteria eat the substrate and digest it, releasing methane, CO₂, etc. The term “digestion” is based on this fact. The anaerobic process releases gases due to microbial action as happens in fermentation. Hence it is also called “anaerobic fermentation” or just “fermentation.” And since what happens is essentially a biological process with associated chemical/biochemical reactions, it can be rightly called a “reaction.” Hence the vessel in which anaerobic digestion is carried out can be called an “anaerobic reactor.”

A “biogas digester” is also an essentially anaerobic digester/fermenter/reactor. This term is used for systems which are employed primarily for biogas production as distinct from other terms which are applied to systems which are *primarily* used for waste treatment and in which biogas is but a major byproduct.

It is also necessary to stress upon one more aspect. The step in organic matter degradation which leads to methane is purely anaerobic and is controlled by a consortium of methanogenic bacteria. But, as described in Chap. 1, there are other steps of organic matter degradation which must occur before the methanogenesis step. Those steps do *not* involve strict anaerobes but, rather, several species of cellulolytic, acidogenic, and acitogenic bacteria which are aerobic or facultative. In the so-called anaerobic digester/fermenter/reactor all degradation is, therefore, not truly anaerobic. Only the decisive step, of methane generation, is strictly anaerobic.

4.2 “Low-Rate” and “High-Rate” Anaerobic Reactors

The biogas digesters used by farmers in India, China, and other developing countries basically contain a large chamber of volume, of 1,000 L (1 m³) or more. In it animal dung mixed with water is fed from one side each day and the overflow of partially digested slurry is collected in a sump at the other side each day. The volume of the daily dung-water slurry feed is about 1/40–1/50 of the reactor volume. The biogas is generated continuously and is temporarily stored in a fixed or a floating dome (see Chap. 5, Figs. 5.2 and 5.3) from where it is drawn for use through a pipe fitted with an on-off control.

In chemical engineering parlance these are “semi-batch” and “poorly mixed” reactors with a hydraulic retention time (HRT) of 40–50 days. The HRT value is derived from:

$$\text{HRT} = \frac{V_R}{q}, \quad (4.1)$$

where V_R is reactor volume and q is volumetric flow rate of the reactants.

For a digester of 2,000 L volume, fed at the rate of 40 L of cow dung-water slurry per day (d):

$$\text{HRT} = \frac{2,000\text{L}}{40(\text{Ld}^{-1})} = 50\text{d}.$$

If the same digester is fed 50 L of cow dung-water slurry,

$$\text{HRT} = \frac{2,000\text{L}}{50(\text{Ld}^{-1})} = 40\text{d}.$$

It has been established (Abbasi and Nipanay 1993) that 70–80% of the total cost of most processes is made up of the cost of the concerned reactors; the operational cost is only of the order of 20–30%. Hence if the cost of any process is to be reduced then, other things being equal, the HRT of its reactants must be reduced because lower the HRT, smaller would be the size of the reactor that would be needed.

A very high HRT of 40–50 days is needed in the “low-rate” digesters mentioned above to accomplish significant extent of anaerobic digestion. But this requirement of HRT is too high compared to the aerobic activated sludge process and other “high-rate” aerobic processes which have been commonly employed all over the world. In the 1950s (see also Chap. 6) the “anaerobic-activated sludge process” was developed as a parallel to the aerobic-activated sludge process. It is now referred as a “first generation high-rate process” (Chap. 6). But even that anaerobic-activated sludge reactor, which was continuously stirred and also heated to maintain it at temperatures of ~35°C (so that anaerobic digestion could occur at a faster rate) needed HRTs of the order of 10–15 days.

This “slowness” of anaerobic digestion process was the major impediment in the widespread use of the process in spite of the advantage that the process generated a useful byproduct in the form of a clean fuel.

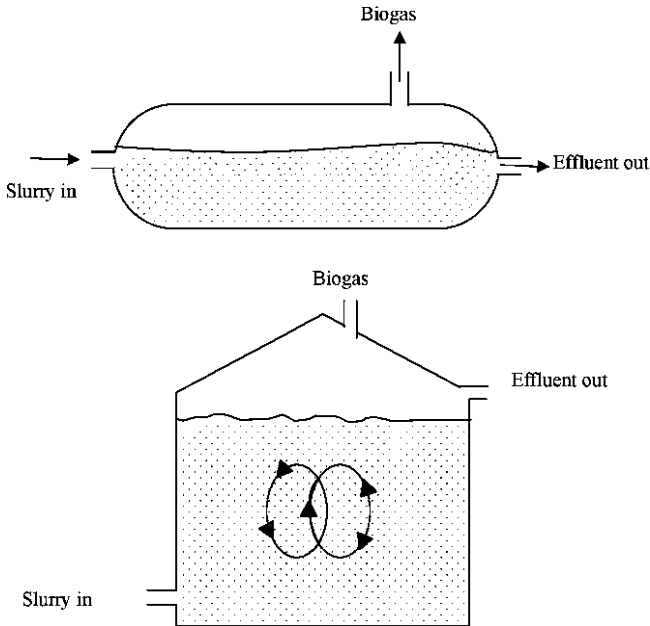

Fig. 4.1 Un-mixed (*top*) and mixed anaerobic digesters with $HRT = SRT$ because microorganisms keep moving out as the digester feed passes out

Then one after another breakthroughs occurred in anaerobic reactor design beginning with the introduction of anaerobic filter by Young and McCarty (1969). Upflow anaerobic sludge blanket (UASB) reactor, downflow fixed film reactors, expanded/fluidized bed reactor, and diphasic/triphasic reactor were introduced one after another by different scientists within a decade of the introduction of the anaerobic filter. The common feature of all these reactors is that they utilize one or the other means to retain active mass of anaerobic micro-organisms in the reactor even as the waste-to-be-treated is made to travel through the reactor at much faster rate than in the “low-rate” anaerobic digesters. This enables low HRTs to be maintained while at the same time achieving high solid retention times (SRTs); “solids” here implying microorganisms. In contrast, in “low-rate” digesters, the microorganisms are mixed with the dung-water slurry and keep getting moved out of the digester along with the digested slurry: in such digesters HRT and SRT are identical (Fig. 4.1). This aspect has also been covered in some detail in Sect. 1.3.6. In essence the endeavour has been to:

- *Minimize HRT*: This can be achieved by minimizing V_R and maximizing q as in (1)
- *Maximize SRT*: This can be accomplished by finding ways and means by which microorganisms are retained much longer in the digester (Fig. 4.2). This is achieved in “attached growth systems” by providing anchors to micro-organisms in the form of solid support systems as in “anaerobic filters.” It is achieved in

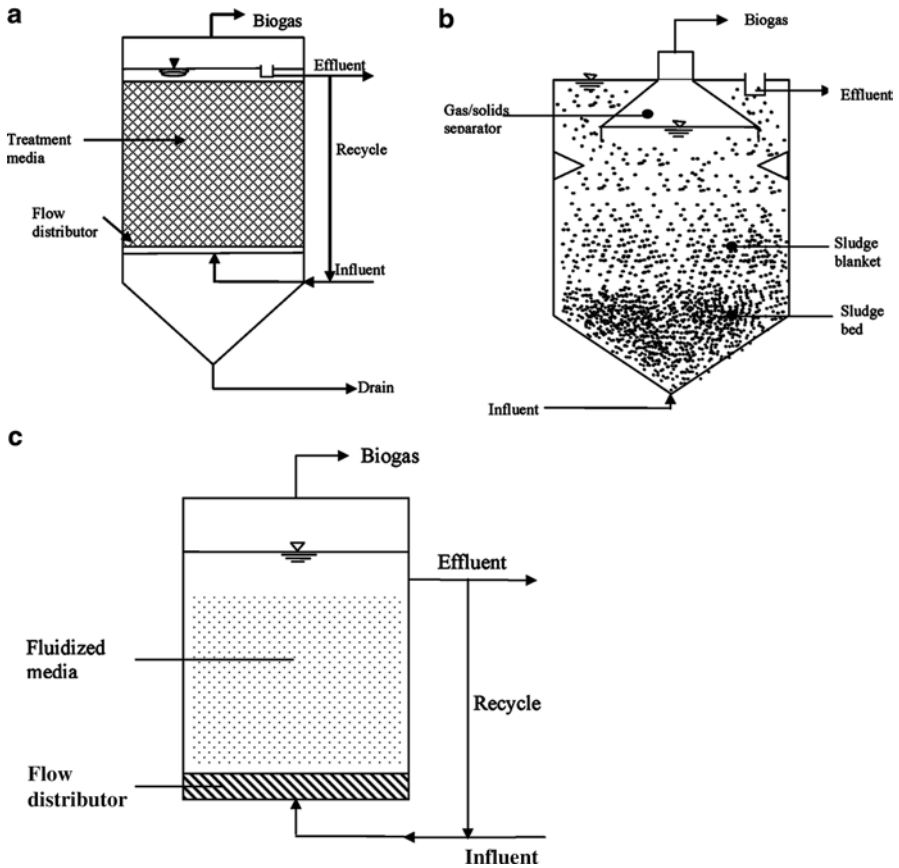

Fig. 4.2 Examples of “retained biomass digesters” in which microorganisms are retained for long times even as digester feed keeps passing out; hence, $SRT \gg HRT$: (a) Anaerobic fixed reactor, (b) UASB, and (c) fluidized bed reactor

“suspended growth systems” like “upflow anaerobic sludge blanket reactors” by developing a highly active sludge of good settling quality and providing other means so that the micro-organism-bearing sludge does not get washed out along with exiting treated influent.

- *Minimize food-to-micro-organism (F/M) ratio*: This is achieved by enhancing SRT/HRT ratio, as above.
- *Enhance the digester loading*: Whereas HRT represents “volumetric loading”, the so-called digester loading represents “mass loading.” This aspect is important because different digester feeds (substrates) may contain different *concentrations* of digestible organics. Hence at identical HRTs a more concentrated substrate will engage more microorganisms and produce more biogas than a less-concentrated substrate. This aspect is brought to the fore in high-solids or “dry” anaerobic digesters described in Chap. 7.

The mass loading rate, normally expressed in $\text{kg m}^{-3}\text{d}^{-1}$ is given by:

$$L = \frac{C_1}{\text{HRT}},$$

where C_1 is the concentration (usually expressed as kg m^{-3}).

Further improvements in the design and operation of high-rate digesters over the years have enabled the anaerobic digestion process to be used for wastewaters of widely different strengths and compositions. The problems associated with process stability and range of applicability have also been solved to a large extent (Chap. 6).

A logical question may be asked at this stage: If high-rate digesters have so many virtues why are low-rate digesters used at all?

The answer is that in their context, for conversion of animal waste energy at a small-scale and in a dispersed manner required in rural and suburban settings, low-rate digesters have a useful role. They are economically viable and are net energy producers even at the small scale at which they are operated. High-rate digesters would not be economically viable at the small scales at which low-rate digesters are successfully utilized. This is because high-rate digesters need much more rigorous, and higher, level of technical supervision than low-rate “biogas plants.” Hence “low-rate” digesters will continue to serve a useful purpose even as ever greater advancements occur in high-rate digester technology.

References

- Abbasi SA, Nipanay PC (1993) Modelling and simulation of biogas systems economics. Ashish Publishing House, New Delhi
- Young JC, McCarty PL (1969) The anaerobic filter for waste treatment. J Water Pollut Contr Fed 41(5):160–173

Chapter 5

Biogas Capture from Animal Manure

Abstract Prior to the 1970s, the principle use of anaerobic digestion across the world was in manure management. Whereas developing countries – principally India and China – used “biogas technology” to extract fuel from manure, developed countries used anaerobic digestion mainly to stabilize the manure, with little concern for the methane that was generated in the bargain.

This chapter recapitulates this background and describes the low-rate and the high-rate anaerobic digesters currently in use to capture biogas from animal manure.

5.1 Introduction

In developing countries, notably India and China, animal manure is utilized by farmers and by the dairy industry for extracting biogas before subjecting the digested manure to other uses – principally as fertilizer. Much of it is done at the level of farming households or small farming communities by utilizing “biogas digesters” or “biogas plants.” These are “low-rate digesters” (Chap. 4) which typically take 40–45 days for the digestion to occur. These are particularly suited for use in the rural setting and by lay persons as they require little technical knowledge or finesse in their operation and maintenance. Larger meat-producing units and dairies employ more sophisticated digesters operated in continuously stirred tank reactor (CSTR) or plug-flow reactor (PFR) modes for manure management. In developed countries biogas recovery from manure is done predominantly with CSTR and PFR systems, but covered lagoons, and other types of anaerobic reactors are also employed.

It is noteworthy that whereas CSTR and other types of digesters employed in developing countries can be used for processing manure as well as a wide variety of other biodegradable wastewaters, low-rate “biogas digesters” function well only with animal manure as feed, that too, ideally, with the manure of cows and buffalos. There have been several attempts to use feed other than manure slurry (MSW, weeds, etc.) in “biogas digesters” but such attempts have all been unsuccessful due to the problems of mass transport, explained in Chap. 7.

Hence the so-called biogas digesters – which are low-rate, partially mixed, semi-batch reactors are the only manure-specific biogas generation systems. CSTR, PFR, and other digesters described later in this chapter are well-suited to the digestion of not only manure but a wide range of other biowastes as well. Indeed these are basic reactor types in chemical engineering, extensively used for numerous different forms of chemical and biochemical reactions.

This chapter focuses on manure-specific digesters used in developing countries. An overview of large manure-based biogas plants operational or planned in developed countries is also presented. All other forms of anaerobic digesters, which can run on wastewaters or solid feed, are described in Chaps. 6 and 7, respectively.

5.2 Some Well-Known Low-Rate Digesters

The “biogas digesters” or “biogas plants” used in India, China, and other developing countries for obtaining biogas from animal manure generally have the following features:

- *Mixing tank*: The feed material (dung) is collected in the mixing tank. Sufficient water is added and the material is thoroughly mixed till a homogeneous slurry is formed.
- *Inlet pipe*: The substrate is discharged into the digester through the inlet pipe/tank.
- *Digester*: The slurry is fermented inside the digester and biogas is produced through bacterial action.
- *Gas holder or gas storage dome*: The biogas gets collected in the gas holder, which holds the gas until the time of consumption.
- *Outlet pipe*: The digested slurry is discharged into the outlet tank either through the outlet pipe or the opening provided in the digester.
- *Gas pipeline*: The gas pipeline carries the gas to the point of utilization, such as a stove or a lamp.

Cow dung is the most common feed for biogas digesters in India but appreciable quantities of utilizable manure is produced by buffalos and pigs, too (Table 5.1). Cow dung can be, and is, directly burnt as fuel after drying it. But the conversion efficiency to heat is only 8% (Fig. 5.1). Much better (25%) energy efficiency is achieved in the conversion of biogas to electricity. The most energy-efficient utilization of cow dung, however, is as heat via combustion of biogas (efficiency 55%).

5.2.1 *Floating-Dome Biogas Plant: The Khadi and Village Industry Commission Model*

This model consists of two major parts – the digester and the gas holder (Fig. 5.2). The gas holder is fabricated from mild steel sheets. In recent years, as the cost of steel has increased and also since it is prone to corrosion, a few alternative materials

Table 5.1 Animal waste for biogas digesters and the utilizability of the biogas (MNRE 2011)

Aspect	Status
Cattle population in the country	289 million (Livestock census: 1997)
Availability of cow dung	200 million tonnes
<i>Availability of animal wastes</i>	
Cow	10 kg ⁻¹ d ⁻¹
Calf	5 kg ⁻¹ d ⁻¹
Buffalo	15 kg ⁻¹ d ⁻¹
Pig	2 kg ⁻¹ d ⁻¹
Gas production per kg of wet dung	0.04 m ³ d ⁻¹
<i>Biogas requirement for various applications</i>	
For cooking	0.3–0.4 m ³ d ⁻¹ per person
For lighting	0.12 m ³ h ⁻¹ per 100 candle power light
For electricity generation	0.6 m ³ kW ⁻¹ h ⁻¹ (dual-fuel engine) 0.75 m ³ kW ⁻¹ h ⁻¹ (biogas fuelled engine)

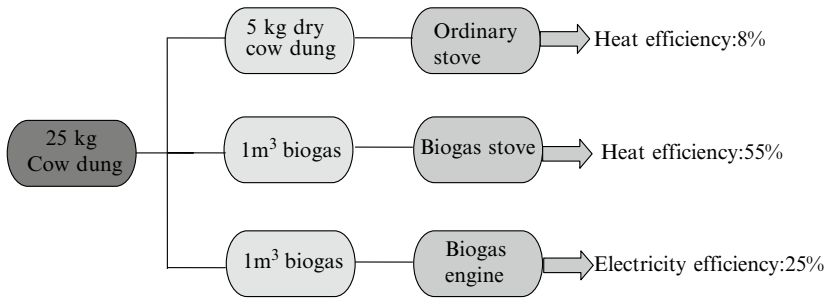

Fig. 5.1 Efficiency of energy conversion from cattle dung (MNRE 2011)

have been tried. Materials like ferro-cement, high-density polyethylene and poly vinyl chloride (PVC) have shown encouraging results. The present system used in India for easy operation of gas holders consists of centrally guided pipes, one fixed to the gas holder and the other to the digester. Since the gas holder is centrally supported, it can be rotated to break the scum and it also helps in providing some sort of agitation in the digester through its upward and downward movements.

There is no need to provide any safety valve as the holder is free to rise and excessive pressure does not develop as in the case of fixed-dome digesters.

The digester portion of the plant is constructed below the ground level with brick masonry. The digesters are provided with an inlet pipe for feeding the cow dung slurry and an outlet pipe through which the digested slurry comes out. If the gas plant has more than 1.5 m diameter, a partition wall is provided vertically to divide the digester into two chambers. This partition is meant for preventing short-circuiting of the fresh feed, as well as the washout of the partially digested slurry through the outlet. On the other hand, it retains the feed within the digester for the entire retention period and thereby facilitates the complete digestion. Thus only the

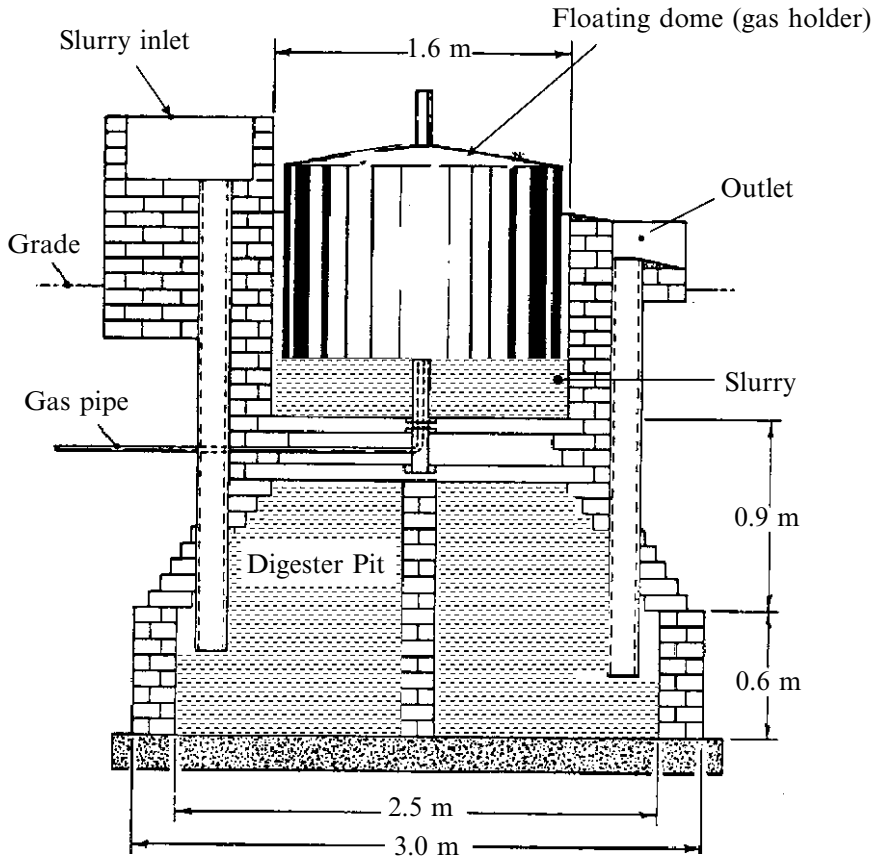

Fig. 5.2 A floating-dome biogas digester

well-digested slurry comes out from the bottom of the second chamber (Chawla 1986). The capacities available with this model range from 1 to 8 m³. The more commonly used ones are of 3 m³ capacity with 55 day HRT.

5.2.2 Floating-Dome Biogas Plant: The Indian Agricultural Research Institute Model

This design is similar to the KVIC model with the following differences:

- There exists no partition wall in the digester.
- The gas holder, made out of mild steel is supported on four sides by counterpoised weights and remains fully balanced without tilting even when the holder is full of gas.
- The supporting weights balance about 50% of the total weight of the gas holder.

Table 5.2 Advantages and limitations of floating-dome type digesters

Advantages	Limitations
<ul style="list-style-type: none"> • Simple and easy to operate • Volume of the stored gas is directly visible • The gas pressure is constant as it is regulated by the weight of the gas holder • Relatively easy to construct 	<ul style="list-style-type: none"> • Steel dome entails substantial cost • Steel part is susceptible to corrosion and due to this, floating drum plants have a shorter life span than fixed-dome plants • Painting of the drum entails regular maintenance costs • If the feed contains floating material (such as fibres or hay) the gas holder may get stuck in the resultant scum

The smallest economic model of this design is of 3 m³ capacity with an HRT of 40 days. The rate of gas production is about 0.056 m³ kg⁻¹ of fresh dung (Chawla 1986).

The advantages and limitations of floating-dome type digesters are presented in Table 5.2.

5.2.3 *Fixed-Dome Biogas Plants: The “Chinese”/“Janata”/“Deenbandhu” Models*

These are based on the Chinese drumless model, which, litre to litre, are cheaper than the floating-dome plants. A typical unit (Fig. 5.3) consists of an underground well-like digester made of bricks and cement with a dome-shaped roof which remains below the ground level. Almost at the middle of the digester, there are two rectangular openings facing each other and coming up a little above the ground level, which act as the inlet and outlet of the plant. The dome-shaped roof is fitted with a pipe at its top which is the gas outlet of the plant. The gas accumulating in the dome exerts pressure on the slurry, thus displacing it from the digester to the inlet and outlet tanks. To make sure that the fresh slurry stays in the digester for a minimum of the required HRT of 50 days, the upper level of fresh slurry remains a few inches below the upper ends of inlet and outlet gates. The slurry which is older (digested) than 50 days and of course lighter than fresh slurry, remains a few inches above the fresh slurry layers in the inlet and outlet pipes. Thus, the older slurry is displaced out of the digester to the inlet and outlet tanks as and when the produced gas accumulates in the dome and presses the slurry. The more commonly used plant is of 2 m³ capacity, with an HRT of 50–66 days. Numerous variants of this basic design have been developed, in China and elsewhere. They differ from each other in minor design details but essentially in the materials employed in the digester construction. A digester currently marketed by China’s Sheuzhen Puxin Science and Technology Company, which has a gas holder made up of glass-fibre-reinforced plastic is shown in Fig. 5.4. Another offering of the same company, which uses toilet flush to generate biogas, is presented in Fig. 5.5.

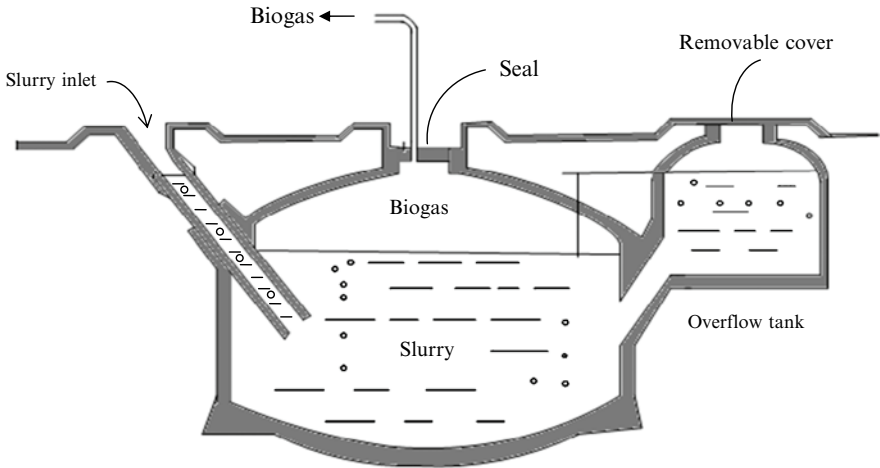

Fig. 5.3 A typical “fixed-dome” digester; it is believed that the Chinese were the first to use this concept. As the digestion proceeds further, biogas is generated which collects under the fixed dome and pushes some of the slurry to the overflow tank. When the gas is taken out for use, its pressure inside the dome ceases and some of the slurry returns from the overflow tank

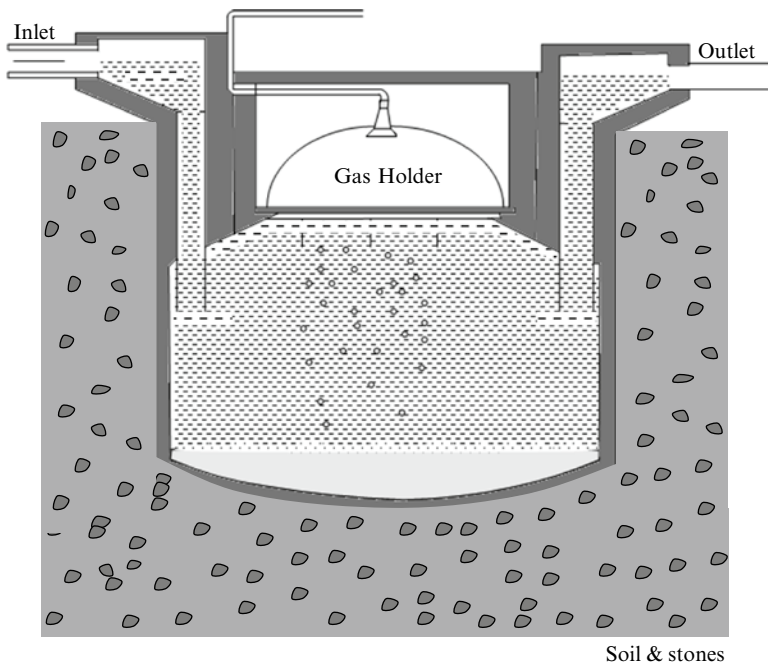

Fig. 5.4 The underground digester marketed by the Sheuzhen Puxin Company, China

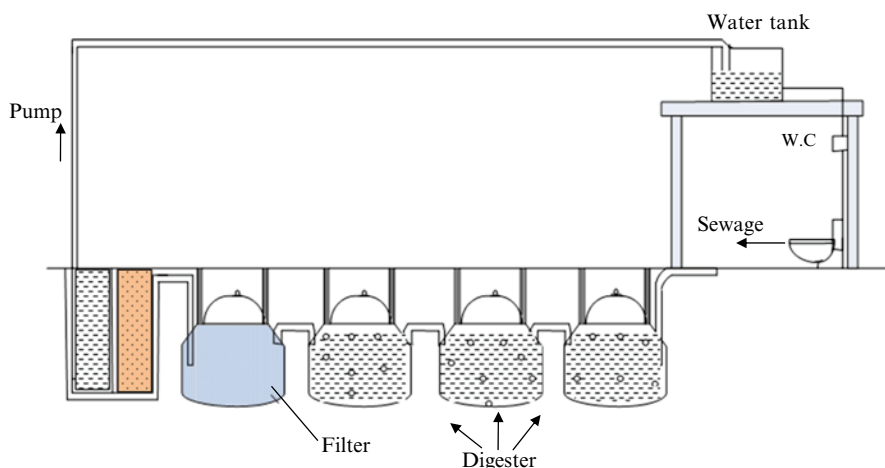

Fig. 5.5 One of the systems marketed by the Scheuzhen Puxin Company, China

Table 5.3 The average estimated cost of the most popular *Deenbandhu* model (MNRE 2011)

Plant capacity (m ³)	Cost per plant (Rs)
1	5,500
2	9,000
3	10,500
4	13,500

Table 5.4 National Biogas Programme (India): subsidy for different categories and areas for setting up biogas plants (MNRE 2011)

Category/area	Central subsidy per plant
North-eastern states and Sikkim	Rs 11,700
Plain areas of Assam	Rs 9,000
Jammu and Kashmir, Himachal Pradesh, Uttaranchal (excluding Terai region), Nilgiris of Tamil Nadu, Sadar Kurseong and Kalimpong sub-divisions of Darjeeling, Sunderbans, Andaman and Nicobar Islands	Rs 4,500 (restricted to Rs 3,500 for 1 m ³ fixed-dome type)
Scheduled caste, scheduled tribe, desert districts, small and marginal farmers, landless labourers, Terai region of Uttaranchal, Western Ghats and other notified hilly areas	Rs 3,500 (restricted to Rs 2,800 for 1 m ³ fixed-dome type)
All others	Rs 2,700 (restricted to Rs 2,100 for 1 m ³ fixed-dome type)

The average estimated cost of the Indian *Deenbandhu* model, which is a variant of the fixed-dome digester, of different capacities is given in Table 5.3. India's Ministry of New and Renewable Energy (MNRE 2011) provides subsidies of various kinds to promote biogas plants (Table 5.4).

The advantages and disadvantages of fixed-dome type biogas digesters are summarized in Table 5.5.

Table 5.5 Advantages and limitations of fixed-dome type digesters

Advantages	Limitations
<ul style="list-style-type: none">• Lower construction costs than floating dome systems• Absence of moving parts and rust-prone steel parts• Have long life span if well constructed• Underground construction saves space and protects the digester from temperature changes	<ul style="list-style-type: none">• Due to development of gas pressure, even a small crack in the upper brickwork can cause heavy losses of biogas• Gas pressure fluctuates substantially depending on the volume of the stored gas• Even though the underground construction buffers temperature extremes, digester temperatures are generally low

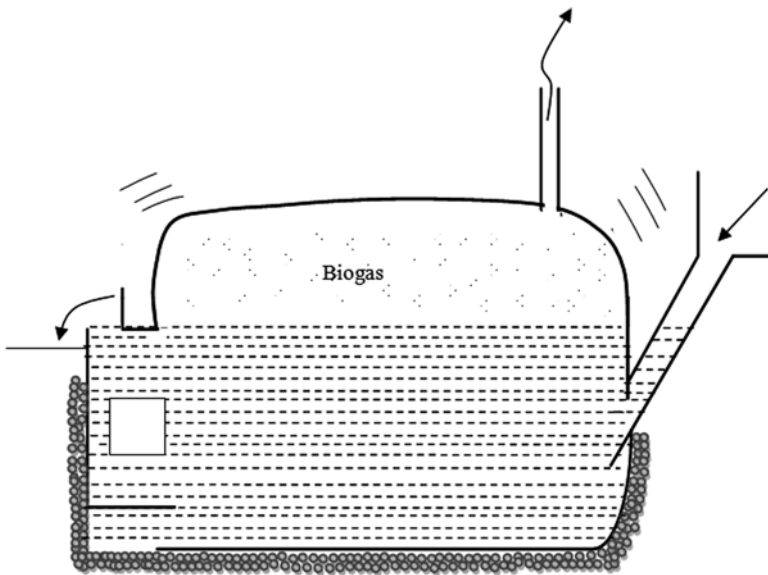

Fig. 5.6 A “balloon” digester: the upper portion inflates as biogas collect in it

5.2.4 “Balloon Digester”

These digesters are made of inflatable plastic material and are especially popular in China. Two of the common designs are presented in Figs. 5.6 and 5.7. The positive and negative attributes of these systems are enumerated in Table 5.6.

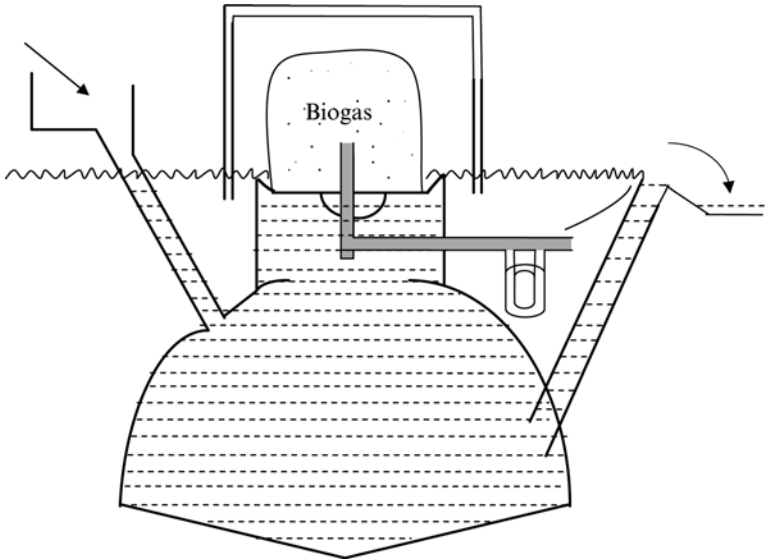

Fig. 5.7 Another design of “balloon” digester

Table 5.6 Advantages and limitations of balloon digesters

Advantages	Limitations
<ul style="list-style-type: none"> • Lowest cost among manure digesters • Easy to transport • Easy to construct • Easily attain high digester temperature • Uncomplicated cleaning, emptying, and maintenance 	<ul style="list-style-type: none"> • Relatively shorter life (about 5 years) • Susceptible to damage • Have limited self-help potential • Little possibility of effective repairs

5.2.5 The Basic Limitation of the Low-Rate “Biogas Digesters” Described in the Preceding Sections

As partly explained earlier, the reasons attributed to the slowness of the biogas plants are as follows:

- No provision exists for proper stirring/mixing of the digester contents.
- As the digested slurry flows out of the exit pipe of these digesters, the microbial population entrapped in the slurry also gets removed. The exit of the slurry thus causes a “washout” of some of the active microbial population, thereby hampering the digester performance. There is no provision to retain the microbes within the digester.

Another major reason is that anaerobic digestion involves not one but three phases viz. hydrolytic, acid, and methane phase. The consortia of bacteria involved in the last two phases are very dissimilar, having different physiological and nutritional requirements. The optimal environmental conditions, such as temperature and pH, for each phase are also different. Kinetically also, the three phases are different; the first and the second phases are faster than the third. Lastly, while methanogenic bacteria (which are strict anaerobes) are very sensitive to fluctuations in process parameters such as pH, temperature, and organic loading rate thus requiring rigid process control, the bacteria involved in the other two phases (which are aerobic/facultative) are hardier. In the conventional anaerobic digestion processes, the three phases are operated in the same tank under a single process regime. As the slower and more delicate methanogenic phase dictates limiting conditions, such conventional processes operate at the rate, pH, temperature, and organic loading conditions suitable for methanogenesis, possibly at the expense of the efficiency of the previous two phases. As the first phase leads to the second which in turn leads to the third, inefficiency in the operation of the first two phases necessarily tells upon the ultimate product, that is methane.

But, as mentioned earlier, despite these disadvantages, the biogas plants are still widely used in India and other developing countries due to their relative inexpensiveness, operational ease, and appropriateness to the rural milieu.

5.3 Large-Scale Manure Digesters Used in Developed Countries and, Now Increasingly, in Some Developing Countries Too

5.3.1 The Rising Trend of Methane Capture

All over the world, especially so in developed countries, more and more large-scale digesters are being installed to recover methane from livestock manure. Whereas in developing countries livestock production has been generally dispersed, with only a few large-scale dairies and other livestock production facilities, the systems are much more centralized in the developed countries. As a result massive quantities of manure are generated as point sources in the former in contrast to equally vast but relatively much more non-point manure generation in the latter.

Whereas, in the past, recovery of energy used to be a low priority in the developed world – in fact flaring off the biogas instead of collecting and using it was fairly common – the trend is rapidly changing towards methane capture.

This is illustrated in the example of the USA (Fig. 5.8). Elsewhere, too, ever greater numbers and capacities of manure-based energy-generation plants are being installed as reflected in the following examples:

- Installation of manure-based digesters is increasing in Canada due to rising electricity costs, and advantages associated with environment-friendly technologies. It is

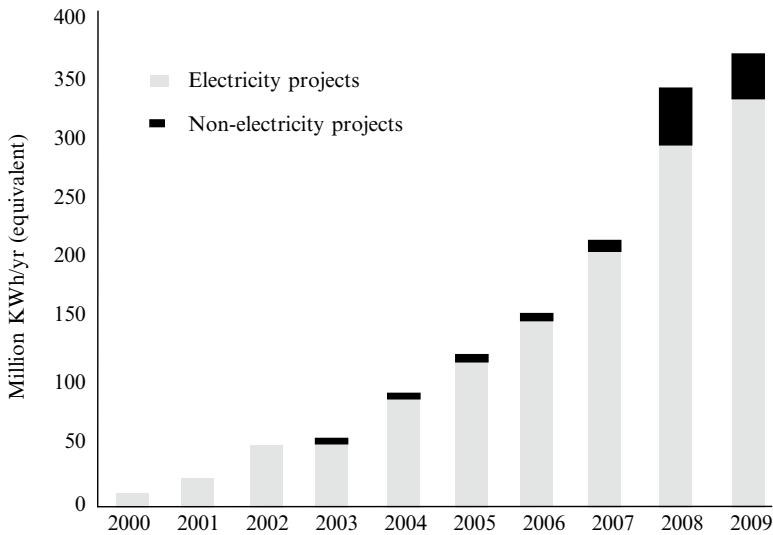

Fig. 5.8 Energy production by anaerobic digesters in the USA (adopted from AgSTAR 2010)

predicted that once digester cost-returns are achieved and electricity production provides much-needed farm income, a new rural “green” economic boom will result.

- The world’s largest biomass power plant running exclusively on chicken manure has opened in the Netherlands. The plant will deliver renewable electricity to 90,000 households. It has a capacity of 36.5 MW.
- Maabjerg Bioenergy, one of the largest biogas plants in the world, is set to convert 500,000 tonnes of biomass into heat and electricity at Denmark. It will generate 18.4 million m³ of biogas per year.
- This plant follows in the heels of the Morsø Bioenergi, started in April 2009, which treats 390,000 tonnes of manure per year. In this plant 4.3 million m³ of biogas is generated per year, corresponding to three million m³ of natural gas.
- HTN Biogas in Caparosso, Navarra, is the largest co-digestion biogas plant in Spain. It has a treatment capacity of 219,000 tonnes per year taking in manure and organic industrial waste from the local area. The biogas translates to 24,000 MW h of electricity.
- At Beijing, China, the Dequingyuan Chicken Farm treats 220 tonnes of manure and 170 tonnes of wastewater produced per day by three million chickens to generate biogas which will be converted into 14,600 MW h of electricity a year and help reduce electricity shortages in the region. It is estimated that \$ 1.2 million in electricity costs will be reduced per year due to input from this plant.
- At China, again, the Liaoning Huishan Cow Farm is set to convert the manure from 60,000 cows into biogas with an expected production of 38,000 MW h, the equivalent of the electricity consumption of 45,000 Chinese households a year.

Table 5.7 Indicative tally of biogas plants and their output in India (Shukla 2010)

Type of biogas plant	Plants installed	Estimated biogas production capacity	
		Million m ³ d ⁻¹	MW of electricity generated
Family-size biogas plants	4,274,831	8.5072	Not available as the gas is used directly as fuel
Biogas plants for small-scale electricity generation	73	0.0042	0.44 MW
Larger-size plants based on urban and industrial waste for electricity generation	70	0.5644	91.11 MW
Total (rounded)	4,275,000	9.1	92

Table 5.8 Growth in the number of biogas-based power projects in India

Year	>5 MW	1–5 MW	<1–0.5 MW	<0.5 MW	Total MW
2000 and earlier		4	3	1	11.15
2001–2005		5	2	3	13.875
2006–2010	2	15	5	5	43.425
Total	2	24	10	9	68.45

In India, too, where “family-size” (i.e., single household) biogas plants outnumber larger plants by several orders of magnitude (Table 5.7), there is a sharp rise in the installation of larger-size plants in recent years (Table 5.8). The range of wastes processed by anaerobic digestion in India is illustrated by Table 5.9.

An indicative list of anaerobic digestion-based plants of 2,500 tonnes per year or higher capacity, given in Table 5.10, reveals the popularity of this process in Europe. It also reveals the strong Asian presence ahead of other continents.

5.3.2 Technology Employed

Six types of digesters are commonly used to recover biogas from animal manure.

5.3.2.1 Covered Lagoon Digester

The simplest form of anaerobic digester with provision of biogas capture is the “covered lagoon digester” (Fig. 5.9). A traditional anaerobic pond containing manure when covered with an impermeable cover becomes a “covered lagoon digester.” The cover enables trapping of biogas that is produced during decomposition of the manure. Covered lagoon digesters work best for liquid manure with less than 2% solids. The rate of methane production in these digesters is dependent on ambient temperature; hence, these are not efficient biogas producers in cold climates. They are, however, less expensive than other types of digesters and are effective in reducing odours, even in cold climates. Requirement of large land area and poor process control are the major drawbacks of these digesters.

Table 5.9 An illustrative list of industries treating manure and other wastes by AD

Aspect	The Brihan			Rampur			The Anil					
	Kanoria Chemicals	Sugar Syndicate	K.M. Sugar Mills	Varalakshmi Company	Andhra Sugars	Distillery and Chemicals	Vasundhara Dairy	Universal Starch	Starch Products Ltd.	Vensa Biotech	AI Kabeer Exports	AI Kabeer Exports
Technology	Degremont and Bacardi	UASB	UASB	UASB	Bacardi	Thermophilic	UASB	UASB	UASB	UASB	BIMA	UASB
Capacity (m ³ d ⁻¹)	NA	525	500	500	225	100	400	1,700	1,600	1,600	60 TPD	2,000
Hydraulic retention time (days)	NA	NA	NA	NA	14	9	Na	NA	NA	NA	NA	NA
Organic loading (kg COD d ⁻¹)	NA	NA	NA	3,000	6,750	100,000	NA	28,679	6,816	19,200	9,000	14,000
COD removal efficiency	NA	NA	NA	80%	70%	50%	80%	70%	80%	70%	NA	80%
Biogas production (m ³ d ⁻¹)	21,000	10,800	12,000	4,700	6,800	20,000	40	10,000	4,800	8,000	2,500	4,000
Specific biogas production (m ³ kg ⁻¹ of COD removed)	0.5	0.5	0.5	0.5	0.5	0.4	0.1	0.5	0.5	0.6	0.59*	0.36
Mode of energy utilization	Generation of electricity	Generation of electricity	Generation of electricity	Generation of electricity	As fuel	As fuel	None: the gas is flared	As fuel	As fuel	As fuel	As fuel	As fuel

* m³ kg⁻¹ of VS

Table 5.10 An indicative list of large-scale ($\geq 2,500$ tonnes per annum) anaerobic digestion plants (adopted from IEA 2008)

Type of waste	Plants of >2,500 TPA capacity		
	In Europe	In Asia	Rest of the world
Catering waste	4	–	–
Catering waste, other biowaste	7	–	–
Fat-scrubber, other biowaste	1	–	–
Fish waste, other biowaste	1	–	–
Food waste	1	–	–
Grey waste	11	–	–
Grey waste, sludge	1	–	–
Ley crop, other biowaste	1	–	–
Manure, other biowaste	58	4	4
Municipal solid waste	25	4	–
Municipal solid waste, other biowaste	10	–	–
Organic industrial waste	4	–	–
Organic industrial waste, other biowaste	13	–	–
Paper, other biowaste	3	–	–
Septic sludge, other biowaste	3	–	–
Sewage, organic industrial waste, other biowaste	1	–	–
Sludge, other biowaste	3	–	–
Unspecified biowaste	74	6	1
Whey	1	–	–
Yard	1	–	–
Total	223	14	5

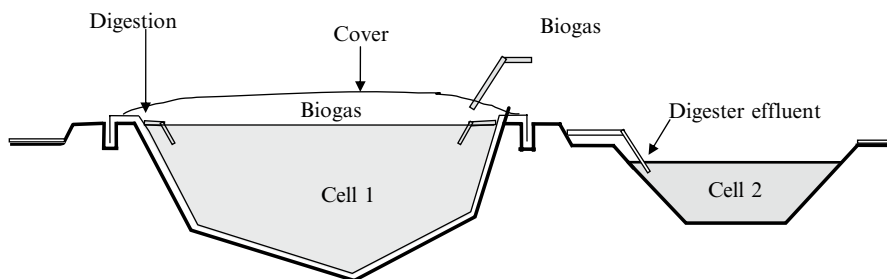
**Fig. 5.9** Schematic of a “covered lagoon digester” (adapted from AgSTAR 2011)

5.3.2.2 Plug-Flow Digester

Plug-flow reactors used in manure management are long tunnel-like or rectangular concrete tanks with air-tight covers where manure flows in at one end of the reactor and flows out at the other. Sometimes the tank is U-shaped, with the entrance and exit at the same end. Influent manure first enters a mixing pit, allowing solids to be adjusted by adding water. Then as manure is fed to the reactor, the “plug” of new

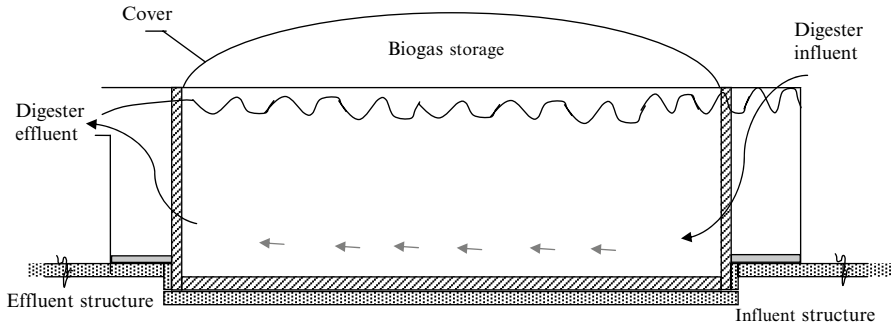

Fig. 5.10 Schematic of a plug-flow digester (adapted from AgSTAR 2011)



Fig. 5.11 Plug-flow digester (Photo courtesy: AgSTAR)

manure slowly pushes the older manure down the tank. The tanks may be heated to maintain a mesophilic or thermophilic environment, often using recovered heat from the biogas burner. The impermeable cover, which is generally flexible, traps the biogas as the manure is digested. For optimal digestion, it takes 15–20 days for a “plug” to pass completely through the digester; in other words the hydraulic retention time is 15–20 days. A plug-flow digester (Figs. 5.10 and 5.11) is most suitable



Fig. 5.12 Chain drag alley for scraping manure (Photo courtesy: AgSTAR)

for manure with a solid content of 11–14%, such as cow manure collected by scraping (Fig. 5.12).

5.3.2.3 Stirred/Mixed Digesters

These digesters have provision for the mixing of reactor contents (Fig. 5.13) and are referred as “completely mixed” or “CSTR.” Provision of heating is also there. These types of reactors are as widely used as PFRs to handle large quantities of manure (Fig. 5.14). These are described in more detail in Sect. 6.3.1.1.

5.3.2.4 Fixed Film Digester

A fixed film digester (Fig. 5.15) is essentially a column packed with media, such as wood chips or small plastic rings on which methane-forming micro-organisms grow, and remain anchored. As the manure liquids pass through the media the slimy growth of micro-organisms act upon the substrate and digest it. The digested substrate exits from the digester even as the micro-organisms are retained. This enables operation of these digesters at retention times of less than 5 days, making for relatively small digesters. Usually, effluent is recycled to maintain a constant upward flow.

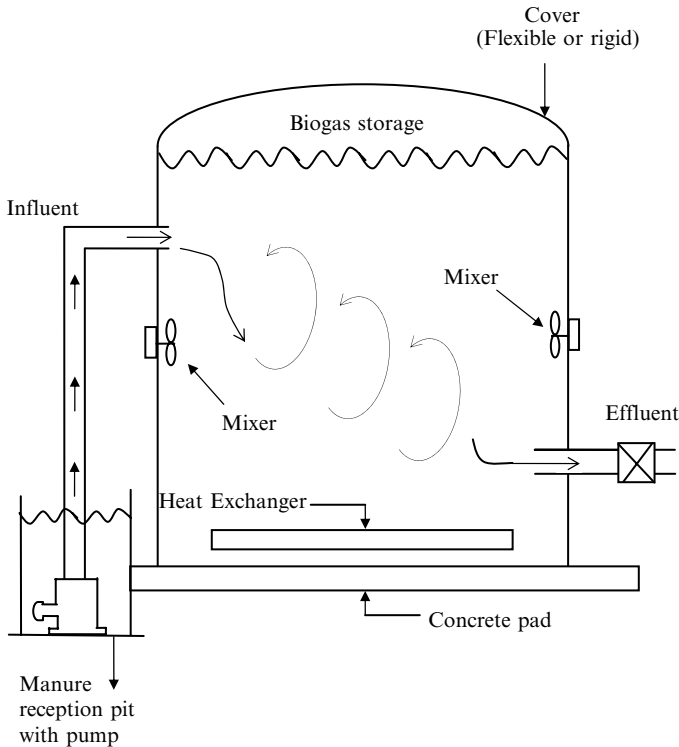

Fig. 5.13 A typical continuously mixed digester (a continuously stirred tank reactor, or CSTR) (adapted from AgSTAR 2011)

A drawback of fixed film digesters is that manure solids can plug the media. Hence a solid separator is needed to remove particles from the manure before feeding the digester. Efficiency of the system depends on the efficiency of the solid separator; therefore, influent manure concentration should be adjusted to maximize separator performance (usually 1 to 5% total solids). Some potential biogas is lost due to this removing of manure solids.

5.3.2.5 Suspended Media Digesters

Suspended media digesters rely on manure particles (or “granules” derived from them) to provide attachment surfaces for micro-organisms. Two common types of suspended media digesters are the upflow anaerobic sludge blanket (UASB) digester and the induced blanket reactor (IBR; Fig. 5.16). The main difference between these two systems is that UASB digesters are better suited for dilute waste streams (<3% total suspended solids); whereas the IBR digesters are suitable for more concentrated wastes (6–12% TS).



Fig. 5.14 Completely mixed digester (Photo courtesy: AgSTAR)

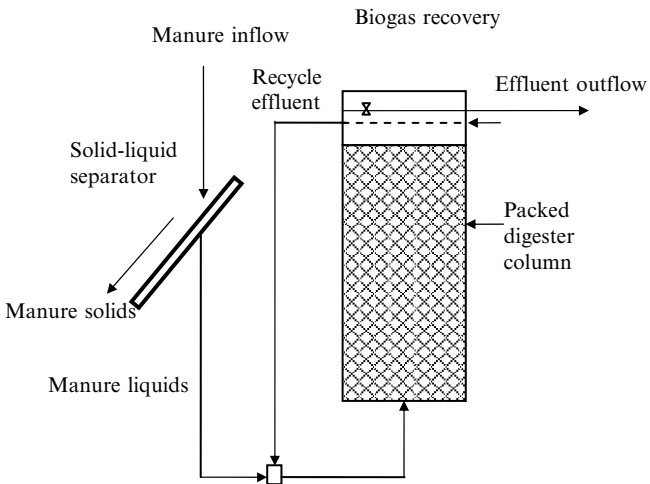

Fig. 5.15 Schematic of a fixed film digester

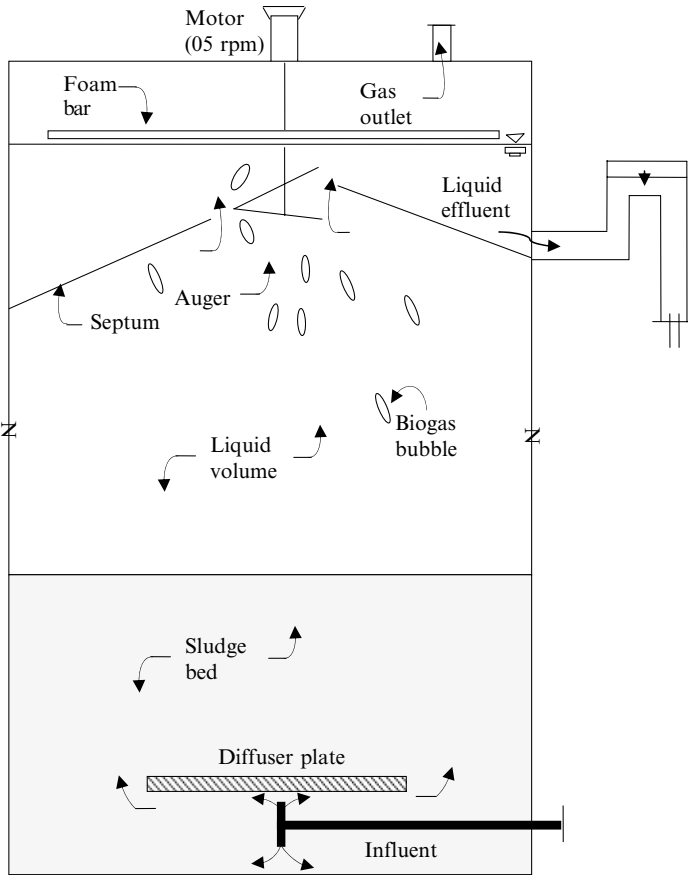

Fig. 5.16 An induced blanket reactor

5.3.2.6 Anaerobic Sequencing Batch Reactor

An anaerobic sequencing batch reactor (ASBR) operates in a cycle of four phases (Fig. 5.17). The digester is fed during the fill stage, manure and microbes are mixed during the react phase, solids are settled during the settle stage, and effluent is drawn off during the decant stage. The cycle is repeated up to four times a day for nearly constant gas production. Liquid retention times can be as short as 5 days. Although ASBR digesters work well with manure in a wide range of solids concentrations (Fig. 5.18), they are particularly well suited for very dilute manures (< 1% TS), and if filled with active microbes during startup, can even produce biogas with completely soluble organic liquids. Sludge must be removed from the ASBR digester periodically; nutrients contained in the sludge also get harvested during sludge removal.

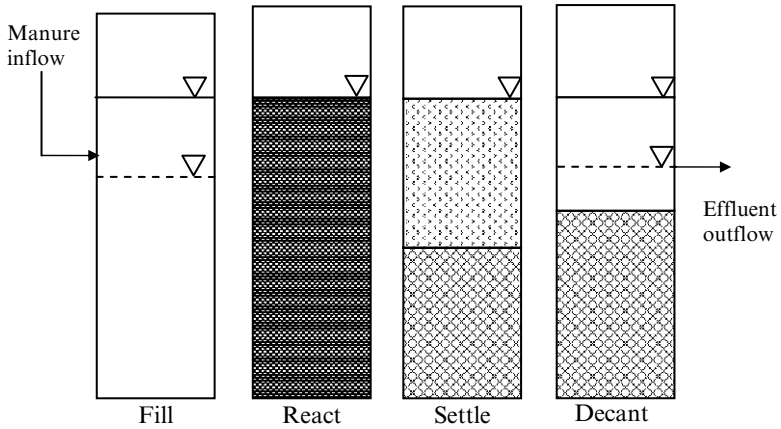

Fig. 5.17 Schematic of a sequential batch reactor



Fig. 5.18 Receiving pit for flush dairy dry lot (Photo courtesy: AgSTAR)

The extent of use of different types of digesters for manure management in the USA is depicted in Fig. 5.19. Methane is still flared off at some places (Fig. 5.20) but capture is being increasingly practiced.

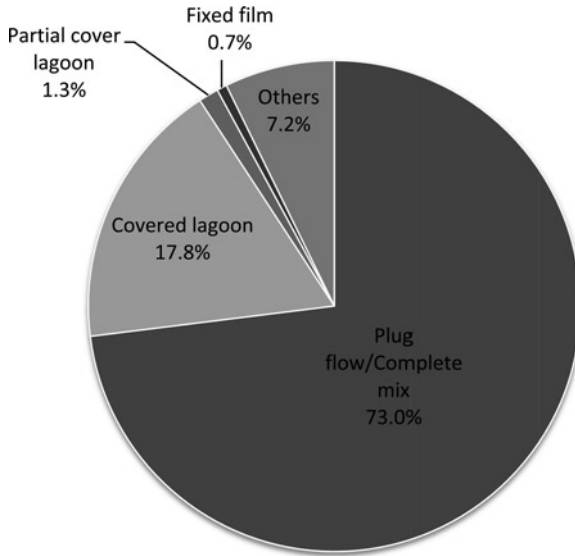

Fig. 5.19 Types of digesters used in the USA for manure processing (percent of total)



Fig. 5.20 Biogas being flared off (Photo courtesy: AgSTAR)

References

- AgSTAR (2010) U.S. anaerobic digester: Status report. US EPA. http://www.epa.gov/agstar/documents/digester_status_report2010.pdf. Accessed May 1 2011
- AgSTAR (2011) AD 101 Biogas recovery systems. US EPA. <http://www.epa.gov/agstar/anaerobic/ad101/index.html>. Accessed May 1 2011
- Chawla OP (1986) Advances in biogas technology. Publications and Information Division, Indian Council of Agricultural Research, New Delhi
- IEA (2008) Operating Anaerobic Digestion Plants of Commercial Scale. International Energy Agency. http://www.iea-biogas.net/_download/Plantlist_08.pdf. Accessed 4 May 2011
- Ministry of new and renewable energy (2011) Booklets on Renewable Energy. MNRE. <http://mnre.gov.in/re-booklets.htm>. Accessed 4 May 2011
- Shukla AR. 2010. Policy development requirements for biogas upscaling in India. In: Delhi International Renewable Energy Conference (DIREC) | Workshop on bio-methanation – Upscaling challenges and opportunities, New Delhi

Chapter 6

Biogas Capture from Wastewaters: The High-Rate Anaerobic Digesters

Abstract Starting with the introduction of anaerobic filter in 1967, a string of breakthroughs in anaerobic reactor design occurred during the late 1960s and early 1970s. These breakthroughs made it possible to extend the reach of anaerobic digestion from highly concentrated (in volatile organics content) manure slurry or sewage-sludge to much less concentrated industrial wastewaters. Later the reach was further extended to dilute wastewaters like domestic sewage and wash-waters.

The anaerobic digestion technology for handling wastewaters has by now advanced to such an extent that it is now possible to treat nearly all types of biodegradable wastewaters by employing one or the other type of high-rate anaerobic digester.

This chapter presents a state-of-the-art, bring out the sweep and the influence of anaerobic digestion *vis a vis* methane capture from wastewaters.

6.1 Introduction

In contrast to the “low-rate” biogas digesters, which have been developed and popularized in India, China, and other developing countries, all the forms of high-rate anaerobic digesters have been developed in the economically advanced countries. Till the late 1970s the focus of the efforts was on enhancing the efficiency and range of applicability of anaerobic digesters in treating biodegradable wastewaters. Recovery of biogas was of little concern. In fact the fairly common practice was to flare off the biogas that was produced.

In 1973 and 1979 came the two “oil shocks” which rattled the world. The shocks were caused by sudden hikes in the prices of petroleum crude by the oil producing and exporting countries (OPEC). It made the world look for ways and means to conserve energy and to find alternative ways to generate energy. Anaerobic digestion was one of the options that promised to fulfil both the needs. First is a process which needs much lesser energy for its operation than aerobic processes. Second, it in fact generates energy in the form of a clean fuel-biogas! These realizations provided a

major impetus for greater use of anaerobic digestion as a waste treatment process. It greatly stimulated research and development in the field.

In recent years, anaerobic digesters have acquired another major significance: being the means by which methane can be captured from wastewater, and used, thereby reducing its emissions to the atmosphere.

6.2 Emission of Methane from Wastewater as a Component of Biogas

Wastewater is the fifth largest source of anthropogenic CH₄ emissions, contributing over 9% of total global CH₄ emissions. Four countries – India, China, the USA, and Indonesia – account for nearly half of the global CH₄ emissions from wastewater (Fig. 6.1). These emissions are expected to grow by approximately 20% between 2005 and 2020.

Systems for the treatment of biodegradable wastewater typically involve screening, grit removal, sedimentation, biological treatment, secondary sedimentation, sludge handling/disposal, and disinfection. Depending on the nature, characteristics, and strength of the wastewater, lesser or larger number of unit operations and processes are employed. Anaerobic zones of varying thickness tend to develop in most of the stages of the treatment train, leading to biogas emissions. Especially during the process of stabilization and disposal of sludge, appreciable quantities of biogas can be produced because, theoretically, 40–45% of the sludges are convertible to biogas. By taking care to maintain aerobic conditions at various stages of the wastewater treatment system, biogas emissions during wastewater treatment can be reduced, but cannot be totally eliminated.

Industries producing large volumes of wastewater and industries with high organic COD wastewater have the potential to generate significant CH₄ emissions. The meat and poultry, pulp and paper, and fruits and vegetable industries are among the largest

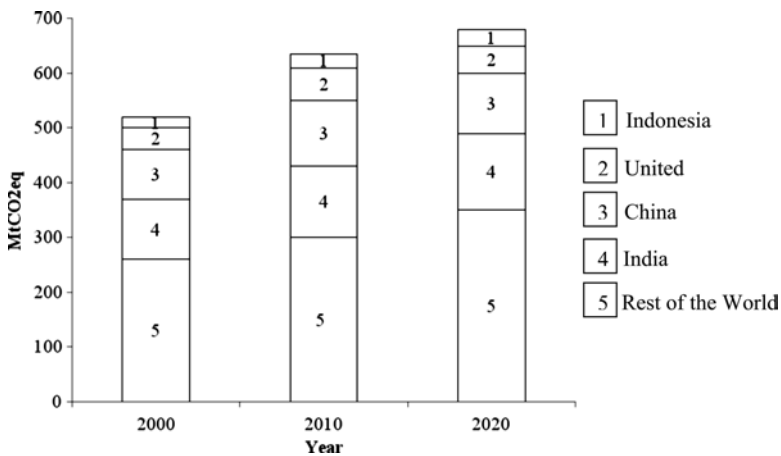

Fig. 6.1 Past, and projected, methane emissions from wastewaters (adopted from USEPA 2006)

Table 6.1 Country-wise emissions of CH₄ from wastewater (as million tonnes of CO₂ equivalent) as per USEPA (2006)

Country	1990	1995	2000
India	81.8	89.7	97.6
China	94.4	99.7	104.2
USA	24.9	29.9	34.3
Indonesia	18.0	19.5	20.9
Brazil	18.0	19.3	20.7
Pakistan	10.9	12.2	14.0
Bangladesh	10.4	11.7	13.0
Mexico	10.0	11.0	11.9
Nigeria	6.8	7.9	9.0
Philippines	6.2	7.0	7.7
Vietnam	6.7	7.4	8.0
Iran	6.0	6.6	7.2
Turkey	5.7	6.3	6.8
Russian federation	9.4	9.4	9.3
Ethiopia	3.9	4.5	5.1
Rest of the world	132.8	141.7	152.7
World total (rounded)	446	484	523

sources of industrial wastewater and contain high organic COD. These industries typically employ either shallow lagoons or settling ponds in their treatment of wastewater, which promotes methane emissions to atmosphere via anaerobic degradation.

The meat and poultry industry in the USA has been identified as a major source of CH₄ emissions because of its extensive use of anaerobic lagoons in sequence to screening, fat traps, and dissolved air flotation. It is estimated that 77% of all wastewater from the meat and poultry industry degrades anaerobically (USEPA 1997a).

Treatment of industrial wastewater from the pulp and paper industry is similar to the treatment of municipal wastewater, and includes neutralization, screening, sedimentation, and flotation/hydrocycloning to remove solids. Anaerobic conditions are most likely to occur during lagooning for storage, settling, and biological treatment (secondary treatment). During the primary treatment phase, lagoons are aerated to reduce anaerobic activity but due to the large size of the lagoons, zones of anaerobic degradation get developed. In the next, secondary treatment phase unintended anaerobic degradation occurs even more frequently. The US Environmental Protection Agency (USEPA) estimates that 25% of COD in secondary treatment lagoons degrades anaerobically (USEPA 1997b).

The fruit, vegetable, and juice-processing industries similarly generate large volumes of high COD wastewater which contribute to biogas emission.

In addition, significant quantities of domestic sewage, night soil, and industrial wastewaters are let off untreated on land, in sewers, or in water bodies, especially in developing countries. These undergo anaerobic decomposition – partially or fully, depending on conditions – and contribute to non-point emissions of methane as a constituent of the resulting biogas.

USEPA (2006) has estimated country-wide increase in CH₄ emissions from wastewaters for the 1990–2000 period (Table 6.1) and have developed forecasts which indicate that by the year 2020, the emissions would have increased by 50% over the 1990 levels (Table 6.2).

Table 6.2 Forecasts of CH₄ emissions from wastewater (as million tonnes of CO₂ equivalent) by USEPA (2006)

Country	2005	2010	2015	2020
India	105.4	112.7	119.1	125.0
China	108.0	111.7	115.3	118.3
USA	35.2	36.1	37.0	37.8
Indonesia	22.2	23.5	24.7	25.9
Brazil	22.0	23.2	24.4	25.5
Pakistan	15.9	18.0	20.2	22.6
Bangladesh	14.5	15.9	17.4	18.8
Mexico	12.8	13.6	14.4	15.1
Nigeria	10.3	11.6	13.1	14.6
Philippines	8.5	9.2	9.8	10.3
Vietnam	8.5	9.0	9.6	10.2
Iran	7.7	8.2	8.9	9.5
Turkey	7.3	7.7	8.1	8.5
Russian federation	9.0	8.7	8.5	8.3
Ethiopia	5.8	6.5	7.3	8.2
Rest of the world	165.2	178.3	192.2	206.4
World total (rounded)	558	594	630	665

6.3 The High-Rate Digesters

Even though anaerobic digestion had begun to be formally used in the 1880s (McCarty 1982), it had enjoyed only limited application as a process for stabilizing high-strength biodegradable wastes, while the bulk of biowaste treatment was done by aerobic digestion (Kirby 1980; Van den Berg 1984). Unlike the processes based on aerobic digestion, anaerobic digestion consumes lesser energy, in fact, as mentioned earlier, produces energy in the form of methane-rich biogas, and also generates easily disposable sludges. But two factors severely limited the application of anaerobic digestion slow rate and process instability. Slow rate meant large digester volumes and, consequently, higher costs and space requirements, while process instability meant lack of assurance of steady energy supply (Abbasi and Nipanay 1993).

As we have explained in Chap. 4, this situation changed dramatically as a result of a string of breakthroughs which occurred from 1967 onwards. Introduction of the anaerobic filter, upflow anaerobic sludge blanket reactor (UASB), expanded- or fluidised-bed anaerobic reactor, and phase-separated reactors brought down the HRT of anaerobic digesters from 35–40 days of typical unstirred reactors (like conventional biogas digesters) and 15–20 days of typical continuously stirred (and heated) tank reactors (CSTR), to a few hours or even a few minutes (as in fluidised-bed anaerobic reactors). This was achieved while maintaining high SRTs and high micro-organism-to-food ratio (Sect. 1.3.6 and Sect. 4.2). The drastic reduction in the HRT (without compromising SRT) enabled much smaller digesters to be deployed to treat the same volume of waste for which several times larger low-rate digesters would be needed. This helped in lowering of digester costs when compared

with conventional low-rate digesters. More importantly, it enabled the treatment of high volume, low-strength, wastes such as sewage by anaerobic processes. In earlier times, such wastes could be speedily treated only by aerobic processes.

As the two conventional disadvantages of anaerobic digestion, namely the slow rate and process instability, were largely overcome, the major advantages of ability to generate energy and stable sludges came to the fore.

It must be emphasized that the main objective of these high-rate digesters is to treat biodegradable wastewaters efficiently and economically, and *not* energy production (which is the prime objective of the “biogas” digesters). Energy does get produced in the form of biogas but it is a byproduct. Also these digesters rarely have positive energy balance – for example, more energy is consumed in the erection and operation of these digesters than is recovered as biogas. This aspect notwithstanding, these digesters do serve the cause of energy conservation to a great extent because the biogas they generate is a source of energy. Hence the *net* energy consumed by these digesters is much lesser than the processes based on aerobic digestion. Much more importantly, these digesters enable capture of biogas, hence methane, which would otherwise, have escaped and contributed to global warming.

6.3.1 First Generation of High-Rate Digesters

Prior to 1950, most of the conventional anaerobic digesters treating municipal wastewater sludges did not employ mechanical mixing. This resulted in separation of solids, from the liquid, forming a thick sludge at the bottom of the tank, and a floating layer of scum at the top. To overcome this, various mechanical methods were tried. Among them, it was found that mixing the reactor contents resulted not only in removal of the scum, but also enhanced the rate of digestion by bringing bacteria and wastes close together (McCarty 1982). The value of this high-rate digestion with mixing was demonstrated in studies by Morgan and Blodgett (1954) and Torpey et al. (1955). Consequent to these findings, most of the modern digesters employ some form of mixing (McCarty 1982). The best example of mixed-type digesters is the anaerobic CSTR.

6.3.1.1 The Anaerobic Continuously Stirred Tank Reactor

This type of a digester is characterised by the provision for mixing the digester contents either continuously or periodically (Fig. 6.2). Mixing can be mechanical, hydraulic or pneumatic, with the latter being effected by compression and sparging of biogas. Gas mixing is preferred in large digesters. The treatment efficiency of a CSTR is further enhanced by heating the digester content with a proper temperature control system. The CSTRs are operated semi-continuously or continuously; that is, the wastewater is fed either periodically (semi-continuously) or continuously to the digester. By insulating the digester and mixing the contents, it is possible to install

Fig. 6.2 Schematic diagram of a continuously stirred tank reactor (CSTR)

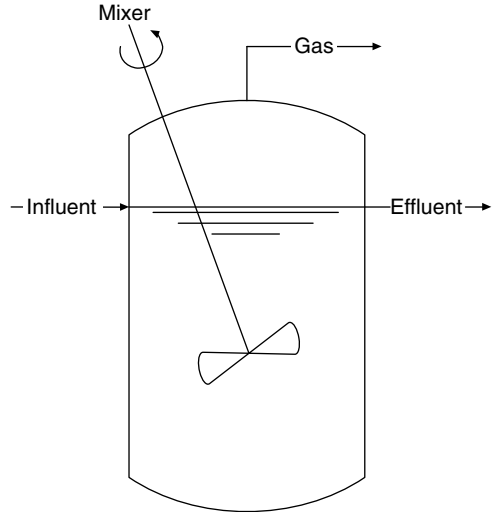

digesters of very large capacities, for example, up to 5,000 m³ (Walfer 2008). CSTRs based on anaerobic process have HRTs in the range of 15–20 days. They are particularly suited to animal wastes such as piggery waste, dairy cattle manure, and silage waste (Table 6.3).

During the 1950s, apart from the use of CSTRs for anaerobic digestion, another significant development occurred – the anaerobic contact process.

6.3.1.2 Anaerobic Contact Reactor

In CSTRs (as in the low-rate digesters described in Chap. 5) the microbial population gets washed away from the reactor along with the effluent. It was felt that if the microbial wash out can be prevented, in other words SRT is enhanced even as HRT is lowered (Sect. 1.3.6), it will lead to the presence of greater concentration of micro-organisms in the reactor, thereby making the digestion much more efficient. To achieve this, microbial population from the effluent stream is separated and is recycled back into the reactor. This concept is actually borrowed from the aerobic activated sludge process in which part of the active sludge is separated from the reactor effluent and is recycled. In the anaerobic contact process also a similar type of settling tank as in the aerobic activated sludge process is constructed and the effluent is passed through it. The settled sludge along with bacterial floc is recycled to the reactor and is mixed thoroughly with the feed (Fig. 6.3). The reactor's performance depends mainly on the efficiency with which the micro-organisms and SS settle. The process is suitable for dairy wastes, sugar-beet wastes, etc., (Table 6.4). Difficulty is encountered in obtaining good settling (Steffen 1961; van den Berg and Lentz 1979) and, in the case of large reactors, it is difficult to achieve adequate mixing.

Table 6.3 Illustrative examples of the use of anaerobic CSTR

Type of feed	Volume of digester (m ³)	HRT (days)	Temperature (°C)	Loading rate (kg VS m ³ d ⁻¹)	Volatile solids (VS), utilization (%)	Biogas production (m ³ kg ⁻¹ of VS)	Methane (%)	References	Remarks
Piggery wastes	-	10	35	1.4-4.5	-	0.43	-	(van Velsen 1979)	-
	-	15	35	4.0	-	0.55	-	(van Velsen 1979)	-
	-	10-15	33	1.9-3.9	-	0.26-0.45	-	(van Velsen 1979)	-
	-	20	35	2.4-3.0	-	0.37-0.54	-	(van Velsen 1979)	-
	-	15	30	3.5	-	0.33-0.49	-	(van Velsen 1979)	-
	-	10-15	30	2.0-3.0	-	0.24-0.33	-	(van Velsen 1979)	-
	-	10-20	30	2.3-4.5	-	0.28-0.39	-	(van Velsen 1979)	-
	-	15-20	30	3.4-4.5	-	0.32-0.33	-	(van Velsen 1979)	-
	-	15	27-40	2.8	-	0.35-0.40	-	(van Velsen 1979)	-
	-	22	33-38	5.0	-	0.49	60	(van Velsen 1979)	Heating: internal serpentine coils stirring: horizontal mechanical axle-motor
Dairy cattle manure + silage waste	32	15.3	34-40	5.6	33	0.14	56	(van Velsen 1979)	Heating: external heat exchanger stirring: gas recirculation
	-	10	35	2.7	55	0.55	65	(van Velsen 1979)	Heating: not necessary since temperature of feed was about 400°C
Distillery wastes	-	10	35	2.7	55	0.55	65	(van Velsen 1979)	Heating: not necessary since temperature of feed was about 400°C
	100	10.25	30.50	2.0-5.0	35-40	0.38-0.42	59-62	(van Velsen 1979)	Heating: two external heat exchangers stirring: internal propeller, installed in the central tube acting downwards
Liquid manure from cows, heifers, calves, (partly straw mixed) vegetable material	18.6	10-15	-	6.0	-	0.47	70-71	(Kirby 1980)	Heating: two external heat exchangers stirring: internal propeller, installed in the central tube acting downwards
	-	-	-	-	-	-	-	-	centrifugal pump

(continued)

Table 6.3 (continued)

Type of feed	Volume of digester (m ³)	HRT (days)	Temperature (°C)	Loading rate (kg VS m ³ d ⁻¹)	Volatile solids (VS), utilization (%)	Biogas production (m ³ kg ⁻¹ of VS)	Methane (%)	References	Remarks
Dairy manure + barley straw	0.13	25	35	5.2	29	0.84	65	(Hills 1980)	Heating: circulation of hot water in a jacket surrounding the unit
	0.13	20	35	6.5	28	0.93	64	(Hills 1980)	
	0.13	15	35	8.7	26	0.96	61	(Hills 1980)	
	0.13	10	35	12.5	24	0.83	58	(Hills 1980)	
Primary sludge	–	17	35	1.4	–	0.37	68	(Chynoweth and Srivastava 1980)	–
<i>Macrocystis pyrifera</i> (raw kelp)	2 ^a	18	35	1.6	50.8	0.478	58.2	(Chynoweth and Srivastava 1980)	Heating: keeping the digester at constant temperature
	2 ^a	10	35	1.6	38.6	0.37	58.8	(Chynoweth and Srivastava 1980)	
Baseline treated kelp	2 ^a	10	35	1.6	35.6	0.35	59.3	(Chynoweth and Srivastava 1980)	stirring: intermittently (15 min h ⁻¹) by a magnetic stirrer at 130 rpm
	2 ^a	18	35	1.6	36.2	0.35	59.8	(Chynoweth and Srivastava 1980)	
Baseline treated kelp juice (4:1)	2 ^a	18	35	1.6	35.6	0.40	58.7	(Chynoweth and Srivastava 1980)	
	2 ^a	10	35	1.6	24.0	0.32	64.1	(Chynoweth and Srivastava 1980)	
(3:2)	2 ^a	18	35	1.6	42.0	0.35	60.3	(Chynoweth and Srivastava 1980)	
	2 ^a	10	35	1.6	23.3	0.18	66.1	(Chynoweth and Srivastava 1980)	
Raw kelp (without nutrient)	2 ^a	12	35	1.6	45.1	0.14	57.8	(Chynoweth and Srivastava 1980)	
(with nutrient)	2 ^a	12	35	1.6	42.6	0.39	59.8	(Chynoweth and Srivastava 1980)	

Cow manure	35	15	-	-	-	0.28 ^b	55	(Jewell et al. 1981)	-
	35	10	-	-	-	0.21 ^b	60	(Jewell et al. 1981)	-
Cattle manure	10	24	35	2.5-2.8	-	0.20-0.25	60	(Hanssen 1983)	-
Screened dairy manure	0.003	16	22	2.1	12.2(3.3) ^c	1.124	63.5	(Lo et al. 1985)	-
	0.003	15	22	1.9	13.8(2.9) ^c	0.149	64.6	(Lo et al. 1985)	-
	0.003	12	22	2.9	11.8(3.4) ^c	0.112	63.5	(Lo et al. 1985)	-
	0.003	10	22	2.8	14.3(2.8) ^c	0.102	64.6	(Lo et al. 1985)	-
	0.003	10	22	2.9	13.8(2.9) ^c	0.115	62.7	(Lo et al. 1985)	-
Water hyacinth + sewage sludge	-	8-31	-	1.6-6.4	-	-	0.25	(Hayes et al. 1985)	-
Brown algae	10	24	35	1.7	-	0.53	52.8	(Hanssen et al. 1987)	Heating: fitted with an automatic temperature control stirring;
<i>Laminaria hyperborea</i>									agitation system with continuously adjustable
<i>Laminaria saccharina</i>	10	24	35	1.7	-	0.45	51.1	(Hanssen et al. 1987)	speed, stirring for 10 min. every 2 h
<i>Ascophyllum nodosum</i>	10	24	35	1.8	-	0.22	50.0	(Hanssen et al. 1987)	process: semi-continuous, feeding once a day
POME	0.015	14	32	3.2 ^d	50.8 ^d	0.19	53	(Ng et al. 1987)	-
	0.015	21	32	2.1 ^d	50.6 ^d	0.25	56	(Ng et al. 1987)	-
Petro chemical industry wastewater (DMT)	2.51	10	35	3.3 ^e	-	-	-	(Sharma et al. 1994)	-

^aVolume of digester 2 dm³, semi-continuous

^bAt standard conditions, 20°C and 1 atm

^cValue given in the parenthesis are VS (%) in the feed

^dAs COD

^eCOD g/L

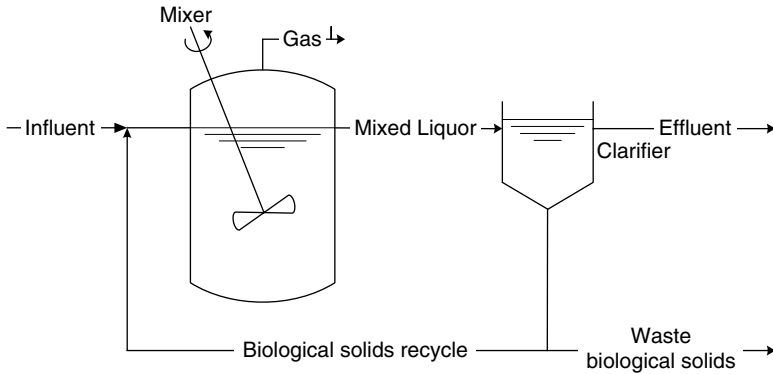

Fig. 6.3 The anaerobic contact reactor

6.3.2 Second Generation of High-Rate Digesters

Later developments in the anaerobic digester design have concentrated on the retention of the active microflora within the digester, independent of the hydraulic flow, and without the use of recycling procedures (Colleran et al. 1983). These “retained biomass” reactors include the upflow anaerobic filter (UAF), the UASB reactor, the downflow stationary fixed film (DFSFF) reactor, and the fluidized-bed/expanded-bed (FB/EB) reactors. The UAF, DFSFF, and FB/EB reactors rely on the propensity of bacteria, especially the methanogens, to attach themselves to the surface of inert support materials which ensure their retention within the reactor (Evans et al. 2009). The UASB design depends on the aggregation of the active flora into dense granules which are retained in the reactor for extremely long periods by the operation of an efficient gas–liquid separator-device (Lettinga et al. 1980).

6.3.2.1 Anaerobic Filters

An AF consists of a vertical column packed in random fashion, with an inert support material such as stone, plastic, ceramic, or fired clay (Fig. 6.4). The distribution header for feed introduction to the matrix-bed is located at the bottom of the column, thereby creating an upward flow through the submerged support material. Dispersion rings are placed at intervals along the column to prevent liquid short-circuiting at the matrix column boundary. Once wastewater is introduced into the reactor, an active microbial flora gradually develops and becomes attached as a biofilm to the surface of the support material. It is also retained in flocculent form in the interstitial spaces between the matrix particles. The process is particularly suitable for dilute soluble wastes, or wastes with easily degradable suspended materials (Table 6.4).

Table 6.4 Example of waste treatment by anaerobic contact reactors^a

Type of waste	Waste strength (g L ⁻¹)	Suspended solids (g L ⁻¹)	Reactor volume (L)	Reactor temperature (°C)	Loading rate (g L ⁻¹ d ⁻¹)	Conversion (%)	References
Meat-packing waste	1.5 (TVS)	0.8	22 × 10 ⁶	35	1.4–3.6	92–98	(Schroepfer et al. 1955)
	1.4 (TVS)		6–60	35	5–2	68–80	(Schroepfer and Ziemke 1959a, b)
Bean-blanching waste	1.7 (TVS)	0.8	2.6 × 10 ⁶	35	3	64	(Steffen 1961)
	20 (COD)	<5	30	35	6.6	80	(van den Berg and Lentz 1977)
Potato-peeling waste	38.4 (COD)	<8	30	35	2.4	70	(van den Berg and Lentz 1977)
Synthetic sewage sludge	55 (COD)	47	30	35	10	78	(van den Berg and Lentz 1977)
Dairy waste	3 (COD)	–	14 × 10 ³	35	1–2.5	55–70	(Vandamme and Waes 1980)
Cannery waste	20 (COD)	<5	5 × 10 ⁶	36–38	3	95	(Chambarliac et al. 1982)
Sugar-beet waste	4.7 (COD)	<0.5	40	35–37	12–24	86–89	(Martenson and Frostell 1982)
Edible oil refinery waste	–	–	3 × 10 ⁻³	–	–	–	(Hoeks et al. 1984)
Acid water from edible oil refiner	–	–	0.5 m ³	–	–	–	(Donnelly et al. 1986)
Ice cream wastewater	–	5.8	–	–	1.7	63	(Ripley et al. 1988)

^aResults are based on COD, BOD, or total volatile solids (TVS). Loading rates are typically the highest reported or achievable. Loading rates and conversions are given in COD, BOD or TVS depending on units for waste strength

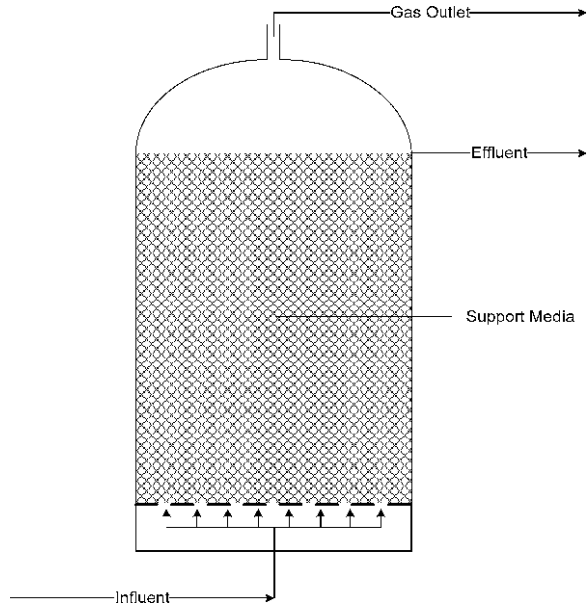
Fig. 6.4 The anaerobic filter

The main limitation of this process is the accumulation of solids in the packing material, which may plug the reactor (Young and Dahab 1983). The solids can be from the material precipitated from the waste (e.g., calcium carbonate) or suspended growth. In addition, hard-to-digest suspended solids that settle readily interfere with the operation of the reactor. In large reactors, inadequate liquid distribution system may cause channelling and short-circuiting (Saravanan and Sreekrishnan 2006; Mudliar et al. 2010).

6.3.2.2 The Downflow Stationary Fixed Film Reactors

This reactor was developed to avoid the problems faced with the AF due to the accumulation of solids in the packing material and consequent plugging. The reactor contains solid packing similar to AFs but is operated in the downflow mode the waste enters from the top and flows downwards (Fig. 6.5). Another advantage is the dispersion of the downflowing waste by the gas produced in the reactor which is flowing upwards (Duff and Kennedy 1983). The formation and stability of an active biomass film on the surface of the support material of the reactor is important (Murray and Van Den Berg 1981; van den Berg and Kennedy 1981). The DFSFF reactors are capable of treating a wide variety of wastes from reasonably diluted to concentrated ones (Kennedy and Van den Berg 1982a, b; Sharma et al. 2009). The performance data for DFSFF reactors collected from the literature is summarized in Table 6.5.

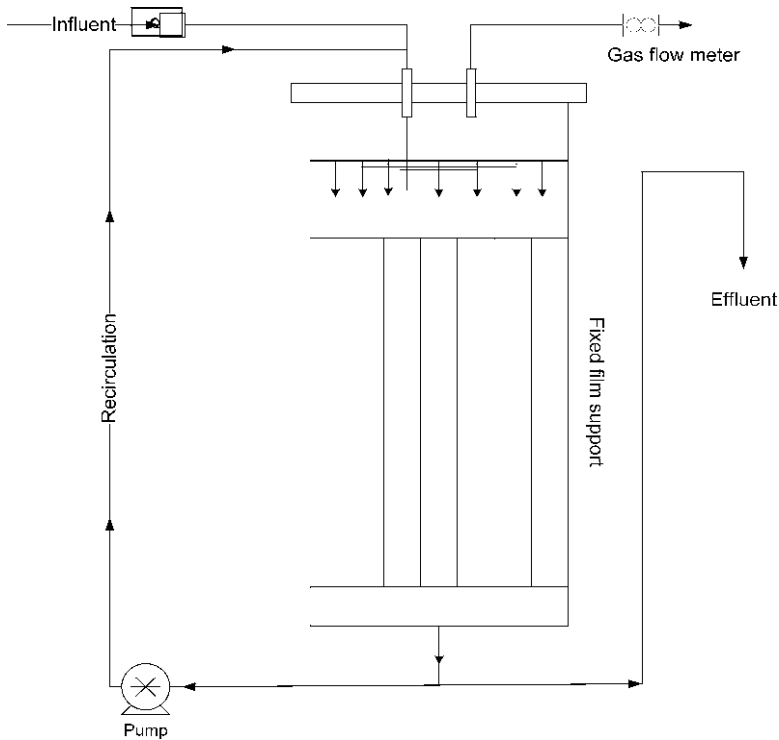

Fig. 6.5 The downflow stationary fixed film (DFSFF) reactor

6.3.2.3 Upflow Anaerobic Sludge Blanket Reactor

The main problem associated with AFs, which is the plugging of the filters by the suspended bacterial growth, was sought to be overcome in the development of UASB. The discoverer of UASB, Gaetze Lettinga, replaced the solid packing media of the AF by a simple gas collection device (Fig. 6.6) to avoid the kind of plugging of the packing by the suspended growth of bacteria, which occurs in AFs (Lettinga et al. 1983).

In UASB reactors, the active microbial biomass forms dense granules, which are highly settleable (Abbasi and Abbasi 2011). As a result, very high concentration of active biomass is achievable per unit working volume of the digester. UASBs are operable at high COD loading rates and provide adequate treatment at lesser HRTs than is possible with the AFs (Table 6.6).

The feed enters through the bottom of the reactor and flows upward. After passing through the active granular sludge the treated wastewater passes through a gas–liquid–solid separation device. This device separates solids (granules) from the liquid effluent and also separates gas bubbles from the effluent. Only the liquid effluent flows out of the reactor while the solid sludge settles back in the reactor and the gas is collected in the gas collector.

Table 6.5 Illustrative examples of treatment of different types of wastewaters achievable by anaerobic filter

Type of feed	Volume of digester (L)	Filter media	HRT	Temperature (°C)	Loading rate kg COD (m ³ d ⁻¹)	COD reduction (%)	Biogas production (m ³ kg ⁻¹ COD)	Methane (%)	References
Piggery waste	200	-	2-8.5 days	26-30	3.74-15.65	-	-	-	(Chavadej 1980)
Silage effluent	8.4	Lime stone chips	3 days	28-30	4.7	76	0.49 ^a	84	(Barry and Colleran 1982)
Water hyacinth + bermuda grass + MSW	6.4	Plastic raschig rings	5.2 days	35	6.1	94	0.60 ^b	68	(Ghosh and Henry 1982)
Cane molasses stillage	8.1	-	9 days	-	7.0	50-70	-	-	(Szendrey 1983b)
	-	-	1-10 days	-	1-10	80-95	-	-	(van den Berg and Kennedy 1983)
Sows and weaness manure	3,500	Plastic matrix	5.5 days	25	3.7-4.7	66	0.26	86	(Demuyneck and Nyns 1984)
Pig slurry	18	Clay, coral, mussel shells, plastic	6 days	33±2	5	69-73.3	0.39-0.46 ^b	85-87	(Wilkie and Colleran 1984)
Sulfite pulp mills	10	-	6.2 days	-	0.44	69	-	-	(Geller and Gottsching 1985)
	10	-	4.5 days	-	0.63	79	-	-	(Geller and Gottsching 1985)
	10	-	2.1 days	-	1.3	90	-	-	(Geller and Gottsching 1985)
Pig slurry super-natant	3,500	Poly-propylene cascade minirings	6 days	25	2.2	66	0.26	86	(Wilkie and Colleran 1986)
	3,500	Poly-propylene cascade minirings	6 days	25	4.3	66	0.26	86	(Wilkie and Colleran 1986)
	3,500	Poly-propylene cascade minirings	3 days	25	8.4	52	0.2	87	(Wilkie and Colleran 1986)

3,500	Poly-propylene cascade minirings	3 days	35	9.9	60	0.25	87	(Wilkie and Colleran 1986)
9	Distillery water + water (1:1)	30 days	24.5–31.0	2.05	77	–	72	(Cadre and Godbole 1986)
9		20 days	24.5–31.0	3.02	74	–	65	(Cadre and Godbole 1986)
9		15 days	24.5–31.0	3.46	62	–	60	(Cadre and Godbole 1986)
9	Raw distillery water	30 days	24.5–31.0	3.56	72	–	65	(Cadre and Godbole 1986)
9		20 days	24.5–31.0	5.74	60	–	63	(Cadre and Godbole 1986)
9		15 days	24.5–31.0	6.81	55	–	59	(Cadre and Godbole 1986)
1.0	Mining wastewater	20 h	3.3	–	–	–	–	(Marce et al. 1987)
20	Cattle slurry	5–14 days	35	–	–	0.26	–	(Peck and Hawkes 1987)
1.0	Molasses wastewater	35 days	10.0	15	–	–	–	(Hilton and Archer 1988)
115	Olive mill wastewater	2 days	–	6	65–70	–	–	(Rozzi et al. 1989)
15	Swine slurry	4.5 days	30	1.9	–	212	72	(Sorlini et al. 1990)
		4.5 days	30	3.1	–	144	77	(Sorlini et al. 1990)
		4.5 days	30	1.4	–	32	68	(Sorlini et al. 1990)
73.63	Water hyacinth	10 days	28–30	–	–	130	64	(Delgado et al. 1992)
–	Olive mill effluent	2.1 days	–	40	70–80	–	–	(Andreoni et al. 1993)
–	Date-processing industry waste	–	–	1.6–25	90	0.4–0.53	–	(Boller 1993)

(continued)

Table 6.5 (continued)

Type of feed	Volume of digester (L)	Filter media	HRT	Temperature (°C)	Loading rate kg COD (m ³ d ⁻¹)	COD reduction (%)	Biogas production (m ³ kg ⁻¹ COD)	Methane (%)	References
Palm oil mill effluent	230	-	15–6 days	-	1.2–11.4	90	20–165 ^c	60	(Borja and Banks 1994)
Tuna-processing waste	1	PVC raschig rings	4–1 days	37	11–13	75	-	-	(Veiga et al. 1994)
Sea food processing wastewater	-	-	6.6 days	-	1.3	65	-1.3	-	(Prasertsan et al. 1994)
Dairy waste	4,300	Poly-propylene raschig rings	24–40 h	35–37	9	70	-	-	(Monroy et al. 1994)
Synthetic wastewater	0.9	Plastic tubes	3–9 days	20	0.27–0.82	81–90	54–78	-	(Hanaki et al. 1994)
	-	Fire expanded clay pellets	1.1 days	-	-	92.8	6.4 ^d	-	(Chua and Fung 1996)
	-	Fire expanded clay pellets	2 days	-	-	74.1	2.13 ^d	-	(Chua and Fung 1996)

^aGas yield per kg COD degradation

^bGas yield calculated for STP

^cGas yield in terms of dm³ d⁻¹

^dGas yield in terms of L d⁻¹

Fig. 6.6 The upflow anaerobic sludge blanket (UASB) reactor

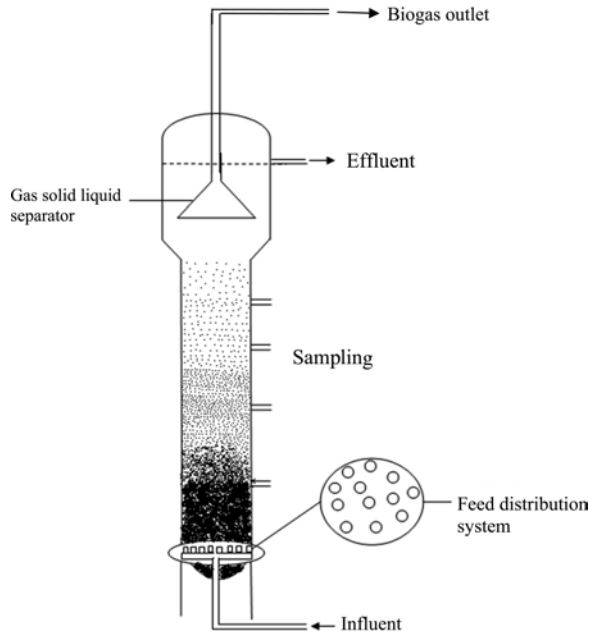

Since both the UASB and the AFs are dependent on suspended growth for high performance, the same types of wastes are suitable to both (Tables 6.4 and 6.6).

The key to UASBs performance is the quality of granules of its sludge (Hulshoff Pol et al. 2004; Aiyuk et al. 2006; Durai and Rajasimman 2011). While certain wastes result in a granular sludge quite readily (sugar-processing waste and wastes containing mainly volatile acids), other wastes develop this granular sludge very slowly and some not at all. Hence this constitutes the major challenge in the success of UASB technology. Inoculation with a large amount of granular sludge from a well-functioning UASB often helps. The sludge retains its characteristics most of the time with a given type of waste, but not always when changing from one waste to another (O’Flaherty et al. 2006; Ward et al. 2008).

6.3.2.4 Anaerobic Fluidized-Bed and Expanded-Bed Reactors

These reactors are similar to suspended growth reactors, but in them the active biomass is grown on small, inert particles such as fine sand or alumina, which are kept in suspension by a rapid but even upward flow of the liquid (Van Haandel et al. 2006). The rate of liquid flow and the resulting expansion of the bed determine whether the reactor is called a fluidized-bed reactor (10–25% expansion) or an expanded-bed reactor (10–15% expansion) (Fig. 6.7).

The preferred waste substrates for these reactors should be soluble, or at least the suspended material should be easily degradable in nature like whey, whey permeate, black liquor condensate, etc. (Switzenbaum 1983).

Table 6.6 Wastewater treatment with downflow fixed film reactors

Type of waste	Waste strength (g L ⁻¹)	Suspended solids (g L ⁻¹)	Reactor size (L)	Reactor temperature (°C)	Loading rate (g L ⁻¹ d ⁻¹)	Conversion (%)	References
Bean-blanching waste	5.5–22.0 (TVS) 10 (COD)	<1 1–3	110 0.7	35 10	9.4 4.2	75 88	(Stevens and van den Berg 1982) (Kennedy and Van den Berg 1981)
Synthetic sewage sludge	55 (COD)	47	35	35	7.4–13.8	71–77	(van Den Berg et al. 1981)
Chemical industry waste	14 (COD)	–	0.7	25	14	81	(Kennedy and Van den Berg 1981)
Piggery waste	27–51 (COD)	–	35	35	6.1–39.2	27–70	(Kennedy and Van den Berg 1982a)
Pear-peeling waste	110–140 (COD)	43–55	35	35	6.4–18.9	58–54	(van den Berg and Kennedy 1982)
Bean-blanching waste	–	–	–	35	18.2	88	(van den Berg and Kennedy 1982)
Rum stillage waste	50–70 (COD)	4.5–6.5	35	35	13.3	57	(Kennedy and Van den Berg 1982c)
Liquor from heat-treated sewage digester sludge	10.5 (COD) II (COD)	<1 1	0.8–1.2 950	35 35	29.2 0–25	70 60	(Kennedy and Van den Berg 1982c) (Hall 1982)
Rum stillage waste	70 (COD)	–	–	37–40	8–10	65–70	(Szendrey 1983a)
Fish-processing waste	6.20 (COD)	3–10	1.2	35	2.5–13	70–92	(Duff and van den Berg 1982)
Sucrose waste	–	–	1.41	–	2–12 ^a	88–96	(Kennedy and Droste 1985)
Sucrose-based synthetic waste	–	–	22.4	35	5.33 ^a	86.7	(Droste and Kennedy 1987)
Synthetic medium	56–62 ^b	–	1.4	37	10.5 ^a	90–94	(Canovas-Diaz and Howell 1988)
Dairy waste	–	–	–	–	5–15 ^a	70–80	(Kennedy and Droste 1991)
Tuna-processing waste	–	–	–	–	3 ^a	70	(Veiga et al. 1994)
Tuna processing wastewater	–	–	1	–	2–5 ^a	70	(Veiga et al. 1994)

Results are based on COD, BOD, or TVS. Loading rates given are typically the highest reported or achievable. Loading rates and conversions are given in COD, BOD, or TVS depending on units used for waste strength

^aLoading rate in terms of kg m⁻³ d⁻¹

^bCOD in kg m⁻³

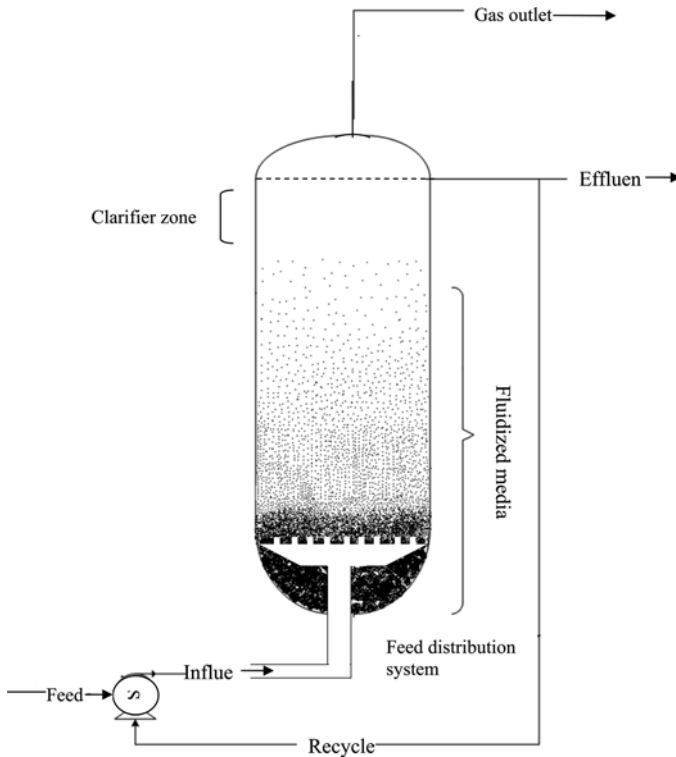

Fig. 6.7 Schematic of expanded-bed/fluidized-bed reactors

These reactors can also treat raw sewage at a fairly high loading rate with high COD removal (Jewell et al. 1981). More details regarding the various capacities of the digesters, types of wastes used, loading rates, HRTs maintained, etc., are summarized in Table 6.7.

6.3.3 *Third Generation of High-Rate Digesters*

To overcome the problems of clogging and wash-out of microbes from the digesters, to enhance the mixing and settle ability of the microbial granules within the reactor, and to treat a larger variety of wastewaters, attempts to modify the reactor designs have been carried out worldwide. As a result, a large number of new digester models have evolved which are often hybrids of the second generation anaerobic reactors – some with added features.

Table 6.7 Illustrative examples of the applications of USAB reactors

Type of feed	Volume of digester (m ³)	HRT	Temperature (°C)	Loading rate (kg COD m ³ d ⁻¹)	COD destruction (%)	Biogas yield (m ³ kg ⁻¹ COD)	Methane yield (%)	References
Sugar-beet sap unsoured	0.064	1–2 days	30	4–5	95	–	–	(Lettinga and Van Velsen 1974)
Sugar-beet sap soured (closed circuit)	0.018	0.5–1 days	30	8–10	84–95	–	–	(Lettinga and Van Velsen 1974)
Sugar-beet sap soured (two-step)	0.018	1 days	30	8–9	97	–	–	(Lettinga and Van Velsen 1974)
Sugar-beet waste	–	0.7–2.1 days	25	5–8	95	0.47	83	(Ghosh and Henry 1982)
Thermal sludge conditioning liquor	–	2 days	35	5.9	71	0.18 ^a	–	(Hall and Jovanovic 1983)
Raw sewage	6	1–0.3 days	20	0.04	70–75	0.12–0.16	–	(Grin et al. 1983)
	–	0.5–6 days	–	5–30	85–95	–	–	(van den Berg and Kennedy 1983)
Paper mill effluent	70	2.5 days	–	9–9.5	70	0.41	70–80	(Habets and Knelissen 1985)
Maize starch	800	0.8 days	40.15	15	90–95	180–200	–	(Hulshoff Pol and Lettinga 1986)
Acid water from edible oil refinery	20	0.25 days	–	–	–	–	–	(Rinzema and Schultz 1987)
Sewage	3.7	10–18 h	24–26	660 mg L ⁻¹	73	140	–	(Nobre and Guimaraes 1987)
Row domestic sewage	35	5.2 h	23–24	0.43–0.52 ^b	66	–	–	(Schellinkhout et al. 1988)
	1,20 ^l	4 h	19–28	0.627 ^b	74	–	–	(Barbosa and Sant'Anna 1989)
Domestic sewage	6	0.3 days	9.5–10	–	–	0.17–0.24	30–55	(Lettinga et al. 1980)
Glucose	3 ^l	–	–	166.44 g d ⁻¹	99.7	8.5 L d ⁻¹	–	(Palms et al. 1990)

Cheese production wastewater	4	46 h	35	31 ^b	90	-	-	(Gutiérrez et al. 1991)
Thermo-mechanical pulping	-	0.9 h	55	81	61	-	-	(Rintala and Lepistö 1992)
Methanolic waste	-	120 days	-	32 ^b	70	-	-	(Bhatti et al. 1993)
Synthetic waste	5.5 ¹	-	55	81	91	-	-	(Uemura and Harada 1993)
Slaughter-house waste	-	4-1.5 h	30	15	80-95	-	-	(Sayed et al. 1993)
Domestic wastewater	1.2	-	>12	-	60	300 ^c	78	(Bogte et al. 1993)
Synthetic coffee waste	-	24 h	>55	4	>75	-	-	(Daoming and Forster 1993)
Synthetic waste	1.7 ¹	-	30	0.18-2	98	-	-	(Visser et al. 1993)
Synthetic waste	1.2 ¹	-	-	13.8-39.6 ^b	57.8-96.7	-	-	(Shen et al. 1993)
Sewage	67.5	-	-	-	80	-	-	(Vieira et al. 1994)
Synthetic starch/sucrose waste	-	-	-	0.5 ^b	75	-	-	(Harada et al. 1994)
Synthetic resin production wastewater	-	-	-	4.5	71	2.94 ^d	-	(Peng et al. 1994)
Low-strength wastewater with ethanol/whey	-	-	-	4.5	78	3.5 ^d	-	(Peng et al. 1994)
Wastewater with formate	-	-	30	0.3-6.8 ^b	95	-	-	(Kato et al. 1994)
Malt whiskey wastewater	-	2.1 days	-	15	90	-	-	(Goodwin and Stuart 1994)
Tannery effluent	10 ¹	12 h	-	-	70	0.15-0.25	80	(Rajamani et al. 1995)
Domestic wastewater	2 ¹	4.6 h	20	3	53-76	-	-	(Soto et al. 1995)
Tannery wastewater	4 ¹	5-7 days	29-34	1.5	39-50	0.1-0.3 ^c L d ⁻¹	-	(Van Groenestijn et al. 2004)

(continued)

Table 6.7 (continued)

Type of feed	Volume of digester (m ³)	HRT	Temperature (°C)	Loading rate (kg COD m ³ d ⁻¹)	COD destruction (%)	Biogas yield (m ³ kg ⁻¹ COD)	Methane (%)	References
Dairy wastewater	–	3h	30±2	13.5	83–86	–	–	(Ramasamy et al. 2004)
shampoo industry wastewaters	0.2 ^l	6.24 h	–	–	95	–	–	(Sanjeevi et al. 2011)
Wheatstraw pulp black liquor	–	–	–	10	40–46	510 ^e	–	(He et al. 1995)
Domestic wastewater	5 ml	–	–	–	75.3	0.15	75–80	(Khan 1995)

^aAs methane yield

^bLoading rate in terms of g COD L⁻¹ d⁻¹

^cBiogas yield in terms of L d⁻¹

^dBiogas yield in terms of dm³ per dm³ of wastewater per day

^eBiogas yield in terms of L kg⁻¹ COD removed

^l Volume of the reactor expressed as litres

Fig. 6.8 A UASB-AF hybrid reactor

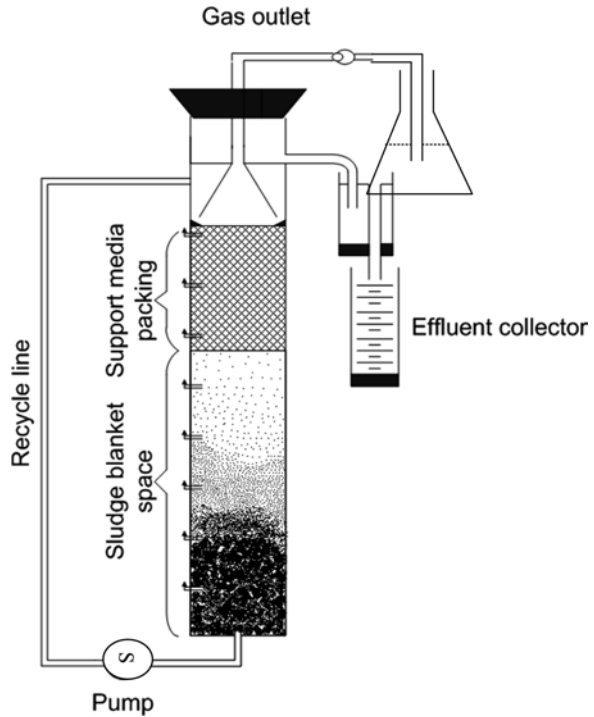

6.3.3.1 AF-UASB Hybrids

For a desired level of treatment performance, the waste loading capacity of any anaerobic digester/wastewater treatment system (hence its overall efficiency) is essentially dictated by the amount of active biomass that can be retained in the reactor, while at the same time providing a sufficient contact between the active biomass and the waste organics (Guiot and van den Berg 1985). Keeping these requirements in mind, one type of hybrid reactors which have a combination of the features of AF (which can retain more biomass within the reactor) and UASB (which ensures good contact between biomass and substrate) designs have been developed (Guiot and van den Berg 1985; Borja et al. 1995). These hybrid reactors named as upflow sludge-bed and filter (UBF) reactors generally perform more efficiently than their parent components (UASB and AF).

The general configuration of UBF reactors (Fig. 6.8) consists of two compartments. The upper compartment is designed as an AF which occupies one-third of the volume of the reactor. The rest of the lower portion is designed as a UASB reactor. The upper filter section is usually packed with plastic, PVC rings, pumice stone or with other inert materials. Besides retaining the biomass independently of the sludge-bed, the filter portion also functions as a gas–solid–liquid separator.

Table 6.8 Wastewater treatment by expanded-bed and fluidized-bed reactors: illustrative examples

Type of waste	Waste strength ($\text{g L}^{-1\text{a}}$)	Suspended solids (g L^{-1})	Reactor size (L)	Reactor temperature ($^{\circ}\text{C}$)	Loading rate (g d^{-1})	Conversion (%)	References
Liquor from heat-treated sewage digester sludge	4–9	–	7	35	4.2–26.5	48–75	(Bell et al. 1980)
Whey	10	–	0.5	35	10–20	87	(Switzenbaum 1980)
Raw sewage	0.15–0.3	<0.1	1	20	0.65–35	0–85	(Jewell et al. 1981)
Synthetic waste with cellulose	0.3–1.8	–	0.5	30	2	74–83	(Morris and Jewell 1981)
	0.3–1.8	–	0.5	30	5	75–83	(Morris and Jewell 1981)
	0.3–1.8	–	0.5	30	8	40–83	(Morris and Jewell 1981)
Thermal sludge conditioning liquor	11	<0.5	29	35	0–30	52	(Hall 1982)
Whey	55 ^a	–	50	35	17–37	65–84	(Hickey 1982)
Whey permeate	10–30	–	60	30–35	8–24	80–90	(Li et al. 1982)
Black liquor condensate	1.4	–	1	22	10	80	(Norrman 1982)
Synthetic refining wastewater	9.7	–	–	36	19.7 ^b	72	(Sutton and Huss 1984)
Synthetic wastewater	1.1	–	–	35	4.5 (VS)	25–93	(Toldrá et al. 1986)
Synthetic waste with glucose liquor	–	18.6 mg	–	35	2.4–3.6 ^b	–	(Yoda et al. 1987)
Wine industry waste	7.8 ^c	–	–	35	6.20 ^b	91.1	(Converti et al. 1990)
Brewery wastewater	–	–	–	25	27–30 ^b	85	(Liang et al. 1993)
Brewery wastewater	40	–	1	37	–	95	(Borja et al. 1993)
Synthetic wastewater	–	–	–	–	30	83–91	(Rinzema et al. 1993)
Pickled-plum effluent	–	–	–	–	11.1	84.6	(Tanemura and Kida 1994)
Ice cream wastewater	–	–	–	35	15.6	94.4	(Borja et al. 1995)

Results are based on COD, BOD, or TVS. Loading rates given are mostly the highest reported or achievable. Loading rates and conversions are given in COD, BOD or TVS depending on units used for waste strength

^aMeasured as COD

^bLoading rate expressed in $\text{kg COD m}^{-3} \text{d}^{-1}$

^c kg COD m^{-3}

Recycling of the effluent for better performance is also adopted in most cases (Table 6.8). The hybrid's use has been extended to CO₂ sequestration employing algae and cyanobacteria (Kumar et al. 2011).

6.3.3.2 Ultrafiltration Membrane Reactors

The membrane-based wastewater treatment system has attracted worldwide attention in recent years. Various membrane technologies such as reverse osmosis (RO), microfiltration (MF), and ultrafiltration (UF) have been successfully used for a variety of water and wastewater treatment applications.

A combination of membrane technology and anaerobic reactors to retain active biomass, thereby increasing the efficiency of treatment process, has emerged as a new technology. High-strength brewery wastewater, when treated using membrane technology coupled with an anaerobic reactor results in methane yield of 0.27 L g⁻¹ COD with 96% COD removal, at a loading rate of 19.7 kg COD m⁻³ d⁻¹ (Fakhru'l-Razi 1994). Up to 98% COD removal in treating high-strength wastewater of 5,000 mg L⁻¹ COD, consisting both soluble and particulate COD (cellulose) in a 1:1 ratio have also been achieved (Harada et al. 1994).

6.3.3.3 Modified UASB Reactors

Over the years UASB has achieved increasing popularity across the world and is the most widely used of all high-rate anaerobic reactors. Several modifications in its design and operation have been done to suit different types and strengths of wastes.

Among the modifications in UASB reactors, some are aimed at breaking the continuous upflow of the feed either by compartmentalisation or by installing more intermediary gas-liquid separators. These modifications lead to better performance than the normal UASB reactors by providing the system with a better substrate for biomass distribution (El-Mamouni et al. 1995). Two of the modified UASB reactor designs are discussed below.

Multiplate anaerobic reactor (MPAR): MPAR consists of three or more superimposed compartments. Each compartment is separated from the other by two plates taped with several apertures and covered by bubble caps (Fig. 6.9). The MPAR is equipped with a gas-solid-liquid separator. The biogas exits at the top and at the two side outlets of the MPAR. The feed is usually pumped into the bottom of the first and second compartments. The performance of MPAR is compared with other high-rate anaerobic reactors in Table 6.9.

Biopaq UASB reactor: Here the number of gas-liquid separators is large and each one of it has individual gas outlets, which are connected together at the rear side by a common gas collector. The common outlet for the total gas collection exists at the top of the reactor (Brinkman and Hack 1996). Apart from this, the usual gas-solid-

Fig. 6.9 Multiplate plate anaerobic reactor (MPAR) (adopted from El-Mamouni et al. 1995)

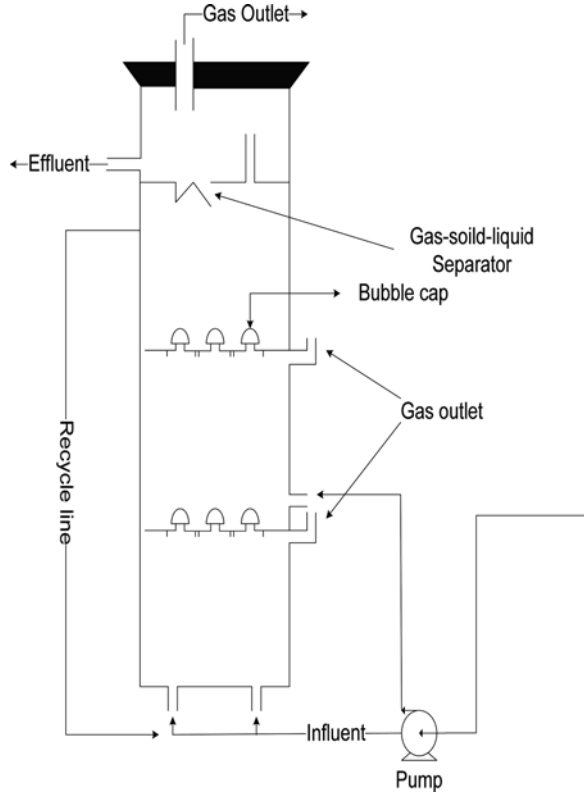

liquid (three phase) separator is also present at the top. The unique feature of Biopaq UASB is its influent distribution system, which is simple and efficient (Fig. 6.10). This flow-distribution network is designed in such a way that the flow is distributed evenly throughout the bottom of the reactor. This eliminates short-circuiting and promotes proper settling of the sludge. The network also facilitates easy cleaning, thereby eliminating plugging problems.

The extent of R&D that has gone in developing modified UASB reactor and the operational success in large-scale applications achieved by many is indicated in Table 6.10. Schematic diagrams of a few other variants are given in Figs. 6.11–6.13.

Table 6.9 Performance of hybrid reactors

Feed	Position of UASB	Position of AF	AF Packing medium	Vol. of Reactor (L)	HRT (days)	Temperature (°C)	Loading rate (kg COD m ⁻³ d ⁻¹)	COD reduction (%)	References
Soluble sugar waste	Bottom	Top	Plastic rings	4.25	–	27	5–51 ^a	93	(Guiot and van den Berg 1985)
Piggery wastewater	Bottom	Top	–	15 m ³	–	–	5	96	(Tilche et al. 1994)
Swine wastewater	–	Middle	Rope matrix	–	–	–	57	0.71 ^b	(Lo et al. 1994)
Slaughter-house waste	Bottom	Top	Clay rings	–	–	35	5–45 ^a	96	(Borja et al. 1995)

^a Gram, per liter per day^b As methane yield

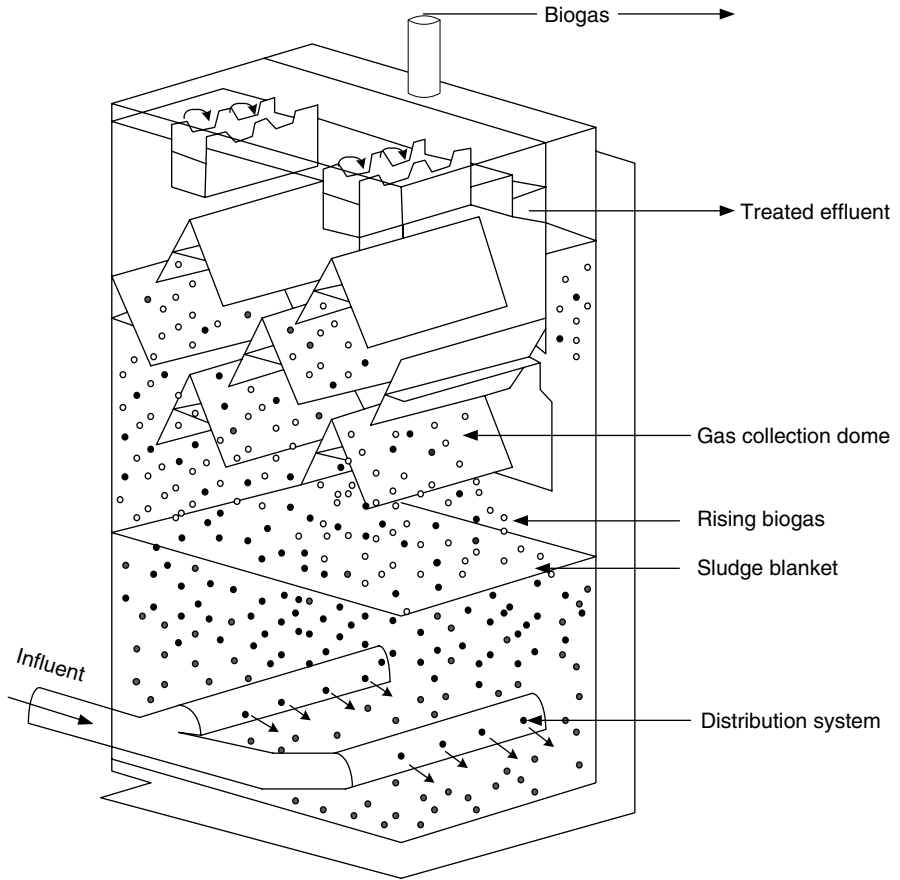

Fig. 6.10 Biopaq UASB reactor (adopted from PAQUES 2011)

Table 6.10 Variants of UASB developed to address specific shortcomings of UASB, and the extent of their success

Name of the UASB variant	Distinguishing feature	Shortcomings of UASB	Typical performance range			Disadvantages
			Input range	HRT	Treatment efficiency	
Upflow Sludge Blanket Filter (UBF) reactor (Ramakrishnan and Gupta 2006, 2008; Araujo et al. 2008; Ozurk et al. 1993)	Incorporates the benefits of UASB as well as anaerobic filter	(1) Long start up period up to 2 months (2) Biomass washout (3) Very low flow rate may cause channelling of wastewater and water sludge contact (4) For the proper functioning of UASB, suspended solids level in the wastewater is to be limited below 1,000 gm ⁻³	1,000–25,000 mg L ⁻¹	12–24 h	85–95%	(1) Amount of biomass washed out increases with loading rates (2) Scum formation (3) Sludge bulking
Expanded granular sludge bed reactor (EGSB) (Dries et al. 1998; Kato et al. 1994)	(1) Granular anaerobic sludge is used as active biomass in EGSB (2) Effluent recirculation is possible (3) Granules are partially fluidizes by effluent recycle, at an up flow velocity of 5–6 m	(1) No effluent recirculation (2) UASB is mostly applied on medium strength industrial effluents having a COD concentration in the range of 3,000–7,000 mg L ⁻¹	Low-strength wastewater (<2,000 mg L ⁻¹)	5 h	85%	(1) Effective COD removal at high loading rates upto 40 kg COD m ⁻³ d ⁻¹ (2) Can be used as a pretreatment step for industrial wastes
				Up to 2008, more than 200 full-scale EGSB reactors are constructed throughout the world in the range of 30–5,000 m ³ volume		(1) High rate conversion of sulphate containing wastewater with a treatment efficiency of 30–5,000 m ³ volume (2) Effective in treating slaughter house wastewater up to an OLR of 15 kg COD m ⁻³ d ⁻¹ with an efficiency of 65–80% (3) Improved mass transfer and biomass activity (4) Higher COD loading rates up to 25 kg COD m ⁻³ d ⁻¹

(continued)

Table 6.10 (continued)

Name of the UASB variant	Distinguishing feature	Shortcomings of UASB	Typical performance range			Disadvantages		
			Input range	HRT	Treatment efficiency			
Internal circulation reactor (IC) reactor (Habets and de Boerstraat 1999; Habets et al. 1997; Habets and Knelissen 1985; Mutombo 2004)	(1) Riser and down streamer arrangement (2) It uses an internal circulation based on airlift principle, generated by the biogas produced inside the reactor	(1) Long HRT (2) Long startup period	1,200–23,000 mg L ⁻¹	(1) 8–24 h for high-strength wastewater (2) Treatment of low-strength wastewater is feasible at low HRT of 2.6 h	80–90%	Up to 2003, 161 IC reactors were constructed throughout the world, of which 89 are in brewery and soft drink industry, 33 in pulp and paper, 39 in food, 9 in distillery industry and 8 in varied chemical industries	(1) High-strength wastewater can be treated (2) No clogging (3) High quality effluent reduces efficiency (4) Medium- and high-strength wastewaters can be treated at volumetric loading rates up to 35 kg COD m ⁻³ d ⁻¹	(1) Sludge addition is not flexible, which reduces efficiency (2) Problems related to startup
Internal circulating-sequencing batch reactor (Deng et al. 2006)	IIC reactor followed by a post treatment step using SBR	Low treatability for low-strength wastewater	Medium and high-strength wastewater	5–6 days	95%	ADI and biopaq constructs it in large scale	High treatment efficiency, when a part of the raw wastewater is bypassed into SBR to mix with digested wastewater	Performance of direct post treatment of swine wastewater was very poor
UASB without internal settlers. (Van Haandel et al. 2006)	No settlers are there inside the reactor					Manufactured by SANEPAR, a local sanitary authority in Brazil and it is used commonly in Brazil for treating domestic sewage	(1) Cost-effective (2) Low cost of construction	Clogging due to suspended particles

<p>UMAR (Up flow multi-stage anaerobic reactor) http://www.Freshpatents.com.</p>	<p>(1) Forced internal circulation (2) Improved 3-phase separation (3) Modification of IC reactor with multi-stages of operation</p>	<p>Medium- and high-strength wastewater</p>	<p>Only lab scale and pilot scale</p>	<p>(1) Improved three-phase separation (2) Improved gas-liquid separation (3) Flexible sludge addition (4) High loading rates up to 30 kg COD m⁻³ d⁻¹ can be applied for medium/high-strength wastewaters</p>	<p>This is the modest member of UASB and requires further study</p>
<p>UASB-DIGESTER (Mahmoud et al. 2004)</p>	<p>UASB reactor followed by a post treatment using digester</p>	<p>Low-strength wastewater</p>	<p>65–75%</p>	<p>(1) No sludge recirculation system (2) Inadequate solids removal (3) Performance of one stage UASB at low temperature (5–20°C) is highly limited</p> <p>2–4 days</p>	<p>(1) Excess sludge produced is very low (2) Suited for low temperature conditions. (15°C)</p>
<p>UASB-septic tank (Elmitwalli et al. 2003; Ali et al. 2007; Al-Shayyah and Mahmood 2008; Al-Jamal and Mahmood 2009)</p>	<p>The standard UASB reactor is combined with the conventional septic tank</p>	<p>High-strength wastewater, mostly sewage</p>	<p>65–75%</p>	<p>(1) Better efficiency (2) Reduced cost of sludge handling due to low sludge production</p>	<p>(1) Post treatment is needed (2) No pathogen removal (3) No nutrient removal (4) Higher concentration Of the orthophosphate in the effluent the observed is some times</p>

(continued)

Table 6.10 (continued)

Typical performance range								
Name of the UASB variant	Distinguishing feature	Shortcomings of UASB	Input range	HRT	Treatment efficiency	Extent of application	Advantages	Disadvantages
Hydrolytic up flow sludge bed-UASB system. (Alvarez et al. 2008)	Can be used for the treatment of low-strength wastewater at low temperature conditions (<20°C)	Low treatability for low-strength wastewater	Low-strength wastewater, but greater than 250 mg L ⁻¹	9.3–17.3 h	89%	Only pilot scale and lab scale	Can be used for low-strength wastewater	Reactor failed at influent concentration below 200 mg/L
Packed bed reactor-UASB system (Jeganathan et al. 2007)	PBR hydrolyses oil and grease into free long chain fatty acids (LCFA)	High rate reactors are hampered by inhibition of LCFA	High COD, oily wastewater	For PBR (0.25–0.5) days and for UASB (1.25–2.5 days)	90% for COD, 88% for oil and gas	No full-scale reactors are in operation. Only lab scale and pilot scale	Able to treat high-strength oily wastewater	Sludge floatation resulted at high OLR of 6.6 kg oil and gas m ⁻³ d ⁻¹
UASB-down flow hanging sponge system (Tandukar et al. 2007)	(1) It has down flow hanging sponge reactor as post treatment	Usually UASB is followed by a sedimentation tank and it costs much area	Sewage wastewater	8 h, i.e. 6 h for UASB and 2 h for DHS	94%	No full-scale reactors Only pilot-scale working in India and Japan Demonstration-scale DHS plant was constructed in India under Yamuna action plan in 2002	(1) Low cost (2) Simple and compact (3) Less land requirement (4) Easy organization and management (5) No need of external aeration, so less energy is needed (6) Less amount of excess sludge (7) High performance (8) Clarified effluent	Less consistent when compared to ASP

<p>Compartmented UASB (Van Haandel et al. 2006)</p>	<p>Conventional type UASB is designed as compartments to treat wastewater of different characteristics</p>	<p>Low-strength wastewater</p>	<p>0.5 days</p>	<p>59%</p>	<p>Can be used in areas with frequent changes in influent flow rate</p>	<p>Same as UASB</p>
<p>Anaerobic migrating blanket reactor (Angenent et al. 2001)</p>	<p>Continuously fed compartmented reactor in which flow is reversed. It can treat low-strength wastewater at low temperature conditions</p>	<p>(1) Loss of biomass with the effluent due to excessive bed expansion (2) Low treatability for low-strength wastewater</p>	<p>0.5 days</p>	<p>59%</p>	<p>(1) No elaborate gas-solid separation and feed distribution system (2) No accumulation of biomass in the reactor. In terms of maximum COD loading rates and specific methane production rate, AMBR is superior to UASB</p>	<p>Mixing is needed and hence energy consuming</p>

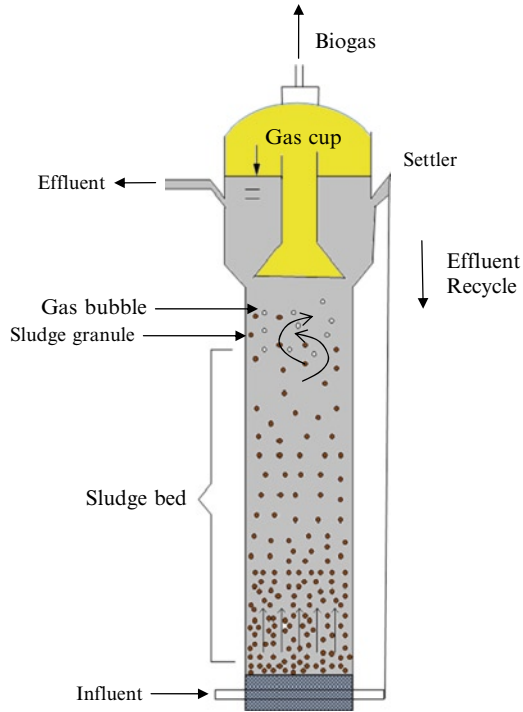

Fig. 6.11 The expanded granular sludge bed (EGSB) reactor

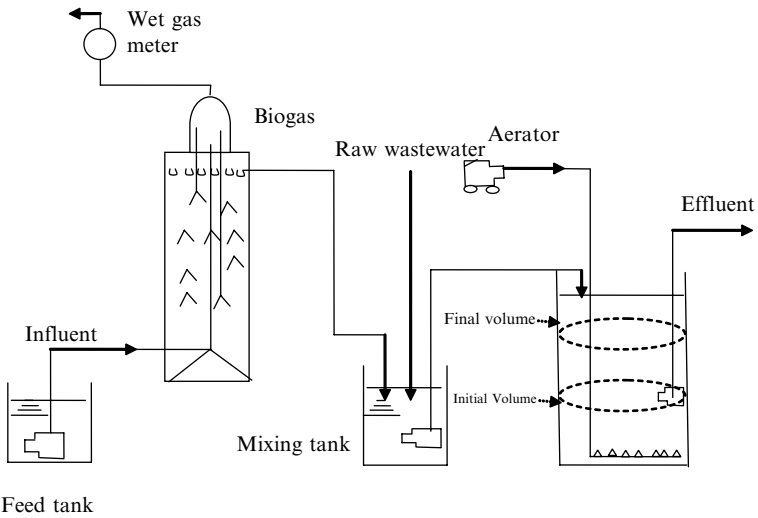

Fig. 6.12 The internal circulation sludge blanket reactor (IC-SBR) (adopted from Deng et al. 2006)

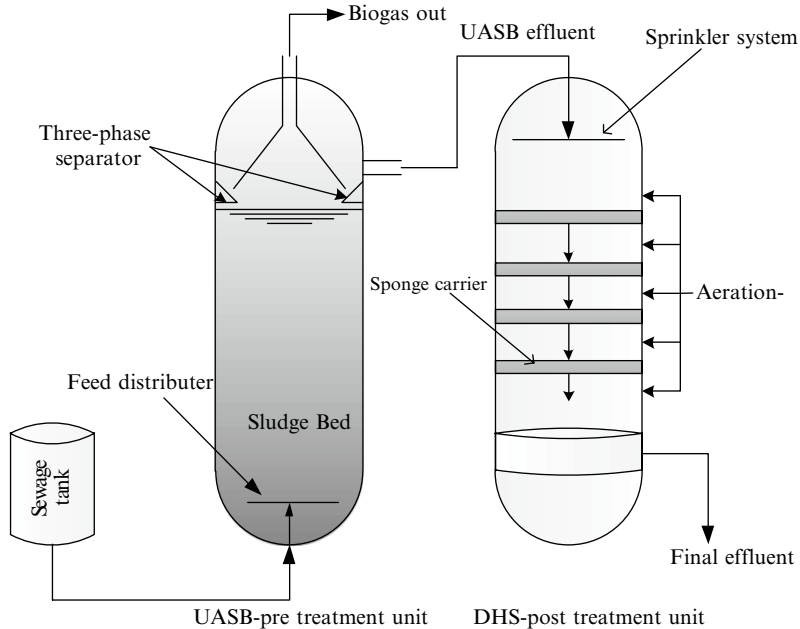

Fig. 6.13 Downflow hanging sponge (DHS) UASB (adopted from Tawfik et al. 2006)

References

- Abbasi T, Abbasi SA (2011) Formation and impact of granulation in fostering clean energy production and wastewater treatment in upflow sludge blanket (UASB) reactors. *Renew Sustain Energy Rev* (in press)
- Abbasi SA, Nipanay PC (1993) Modelling and simulation of biogas systems economics. Ashish Publishing House, New Delhi
- AgSTAR (2011) AD 101 Biogas recovery systems. US EPA. <http://www.epa.gov/agstar/anaerobic/ad101/index.html>. Accessed 1 May 2011
- Aiyuk S, Forrez I, Lieven DK, van Haandel A, Verstraete W (2006) Anaerobic and complementary treatment of domestic sewage in regions with hot climates – a review. *Bioresour Technol* 97(17):2225–2241. doi:10.1016/j.biortech.2005.05.015
- Ali M, Al-Sa ed R, Mahmoud N (2007) Start-up phase assessment of a UASB-septic tank system treating domestic septage. *Arab J Sci Eng* 32(1C):65–76
- Al-Jamal W, Mahmoud N (2009) Community onsite treatment of cold strong sewage in a UASB-septic tank. *Bioresour Technol* 100(3):1061–1068
- Al-Shayah M, Mahmoud N (2008) Start-up of an UASB-septic tank for community on-site treatment of strong domestic sewage. *Bioresour Technol* 99(16):7758–7766
- Álvarez JA, Armstrong E, Gómez M, Soto M (2008) Anaerobic treatment of low-strength municipal wastewater by a two-stage pilot plant under psychrophilic conditions. *Bioresour Technol* 99(15):7051–7062. doi:10.1016/j.biortech.2008.01.013
- Andreoni V, Bonfanti P, Daffonchio D, Sorlini C, Villa M (1993) Anaerobic digestion of olive mill effluents: microbiological and processing aspects. *J Environ Sci Health A* 28(9):2041–2059
- Angenent LT, Banik GC, Sung S (2001) Anaerobic migrating blanket reactor treatment of low-strength wastewater at low temperatures. *Water Environ Res* 73(5):567–574

- Araujo DJ, Rocha SMS, Cammarota MC, Xavier AMF, Cardoso VL (2008) Anaerobic treatment of wastewater from the household and personal products industry in a hybrid bioreactor. *Braz J Chem Eng* 25(3):443–451
- Barbosa R, Sant'Anna G Jr (1989) Treatment of raw domestic sewage in an UASB reactor. *Water Res* 23(12):1483–1490
- Barry M, Colleran E (1982) Anaerobic digestion of silage effluent using an upflow fixed bed reactor. *Agric Wastes* 4(3):231–239
- Bell BA, Jeris J, Welday JM, Carrol R (1980) Anaerobic fluidised-bed treatment of thermal sludge conditioning decant liquor. In: U.S. Department of Energy Workshop/Seminar on Anaerobic Filters, Howey-In-The-Hills, FL
- Bhatti Z, Furukawa K, Fujita M (1993) Treatment performance and microbial structure of a granular consortium handling methanolic waste. *J Ferment Bioeng* 76(3):218–223
- Bogte J, Breure A, Van Andel J, Lettinga G (1993) Anaerobic treatment of domestic wastewater in small scale UASB reactors. *Water Sci Technol* 27:75–75
- Boller M (1993) Upflow anaerobic filtration of a sugar containing wastewater. Waste management problems in agro-industries 1992 28(2):125–134
- Borja R, Banks CJ (1994) Treatment of palm oil mill effluent by upflow anaerobic filtration. *J Chem Technol Biotechnol* 61(2):103–109
- Borja R, Martín A, Maestro R, Luque M, Durán MM (1993) Enhancement of the anaerobic digestion of wine distillery wastewater by the removal of phenolic inhibitors. *Bioresour Technol* 45(2):99–104. doi:10.1016/0960-8524(93)90097-U
- Borja R, Banks CJ, Wang Z (1995) Performance of a hybrid anaerobic reactor, combining a sludge blanket and a filter, treating slaughterhouse wastewater. *Appl Microbiol Biotechnol* 43(2):351–357. doi:10.1007/BF00172838
- Brinkman J, Hack PJFM (1996) The paques anaerobic digestion process: a feasible and flexible treatment for solid organic waste. In: Hansen JA (ed) Management of urban biodegradable wastes: collection, occupational health, biological treatment, product quality criteria and end user demand. James and James (Science Publishers), Ltd, London, pp 181–192
- Canovas-Diaz M, Howell JA (1988) Downflow fixed-film anaerobic reactors stability studies under organic and hydraulic overloading at different working volume. *Water Res* 22(5):529–536
- Chambarlhac B, Bebin J, Albagnac G (1982) Stabilization and methane production by commercial scale digestion of green vegetable cannery wastes [Biogas], Energy from biomass and wastes VI: symposium. The Institute, Lake Buena Vista, Florida, pp 483–507
- Chavadej S (1980) Anaerobic filter for biogas production. *Reg J Energy Heat Mass Transfer* 2:31–44
- Chua H, Fung JPC (1996) Hydrodynamics in the packed bed of the anaerobic fixed film reactor. *Water Sci Technol* 33(8):1–6
- Chui HK, Fang HHP, Li YY (1994) Removal of formate from wastewater by anaerobic process. *J Environ Eng* 120(5):1308–1321
- Chynoweth DP, Srivastava VJ (1980) Methane production from marine biomass. In: International symposium on biogas, microalgae, and livestock wastes, Chicago, IL, pp 1–25
- Colleran E, Wilkie A, Barry M, Faherty G, O'Kelly N, Reynolds PJ (1983) One and two stage anaerobic filter digestion of agricultural wastes. In: Third international symposium on anaerobic digestion, Boston, MA
- Converti A, Zilli M, Borghi M, Ferraiolo G (1990) The fluidized bed reactor in the anaerobic treatment of wine wastewater. *Bioprocess Biosyst Eng* 5(2):49–55
- Daoming S, Forster CF (1993) An examination of the start-up of a thermophilic upflow sludge blanket reactor treating a synthetic coffee waste. *Environ Technol* 14(10):965–972
- Delgado M, Guariola E, Bigeriego M (1992) Methane generation from water hyacinth biomass. *J Environ Sci Health A* 27(2):347–367
- Demuyneck M, Nyns E (1984) Biogas plants in Europe. *Int J Sustain Energy* 2(6):477–485
- Deng L-W, Zheng P, Chen Z-A (2006) Anaerobic digestion and post-treatment of swine wastewater using IC-SBR process with bypass of raw wastewater. *Process Biochem* 41(4):965–969. doi:10.1016/j.procbio.2005.10.022

- Donnelly T, Sanderson JA, Anderson GK, Saw CB (1986) Anaerobe biologische Behandlung von fett- und sulfathaltigen Abwässern der Speisefettraffinerien. *Gwf-Wasser/Abwasser* 126(2):81–87
- Dries J, De Smul A, Goethals L, Grootaerd H, Verstraete W (1998) High rate biological treatment of sulfate-rich wastewater in an acetate-fed EGSB reactor. *Biodegradation* 9(2):103–111
- Droste RL, Kennedy KJ (1987) Steady state kinetics of anaerobic downflow stationary fixed film reactors. *Water Sci Technol* 19(1–2):275–285
- Duff SJB, Kennedy KJ (1983) Effect of effluent recirculation on start-up and steady state operation of the downflow stationary fixed film (DSFF) reactor. *Biotechnol Lett* 5(5):317–320. doi:10.1007/bf01141132
- Duff SJB, van den Berg L (1982) Treatment of fish processing waste using the downflow stationary fixed film (DSFF) reactor. *Biotechnol Lett* 4(12):821–826
- Durai G, Rajasimman M (2011) Biological treatment of tannery wastewater – a review. *J Environ Sci Technol* 4(1):1–17. doi:10.3923/jest.2011.1.17
- El-Mamouni R, Guiot SR, Mercier P, Safi B, Samson R (1995) Liming impact on granules activity of the multiplate anaerobic reactor (MPAR) treating whey permeate. *Bioprocess Biosyst Eng* 12(1):47–53. doi:10.1007/bf01112993
- Elmitwalli T, El-mashad H, Mels A, Zeeman G (2003) Sustainable treatment of waste (water) in rural areas of Egypt. In: 2nd international symposium on ecological sanitation “Ecosan-Closing Loop”, Lubeck, Baltic Sea, Germany
- Evans EA, Evans KM, Ulrich A, Ellsworth S, Abbasnezhad H (2009) Anaerobic processes. *Water Environ Res* 81(10):1293–1345. doi:10.2175/106143009X12445568399613
- Fakhru'l-Razi A (1994) Ultrafiltration membrane separation for anaerobic wastewater treatment. *Water Sci Technol* 30(12):321–327
- Godre R, Godbole S (1986) Treatment of distillery waste by upflow anaerobic filter. *Indian J Environ Health* 28(1):54–59
- Geller A, Gottsching L (1985) Anaerobic fermentation of sulfite pulp mill effluents. *Water Sci Technol* 17(1):157
- Ghosh S, Henry MP (1982) Application of packed-bed upflow towers in two-phase anaerobic digestion. In: International conference on fixed-film biological processes, Kings Island, OH, USA, 1982. CONF-820485-1, Institute of Gas Technology, Chicago, IL (USA), p 23
- Goodwin JA, Stuart JB (1994) Anaerobic digestion of malt whisky distillery pot ale using upflow anaerobic sludge blanket reactors. *Bioresour Technol* 49(1):75–81
- Grin PC, Roersma RE, Lettinga G (1983) Anaerobic treatment of raw sewage at lower temperatures. In: BVC the European symposium on anaerobic wastewater treatment, Noordwijkerhout, The Netherlands, pp 335–347
- Guiot SR, van den Berg L (1985) Performance of an upflow anaerobic reactor combining a sludge blanket and a filter treating sugar waste. *Biotechnol Bioeng* 27(6):800–806. doi:10.1002/bit.260270608
- Gutiérrez JLR, Encina PAG, Fdz-Polanco F (1991) Anaerobic treatment of cheese-production wastewater using a UASB reactor. *Bioresour Technol* 37(3):271–276
- Habets LHA, de Boerstraat T (1999) Introduction of the IC reactor in the paper industry. Technical Report, Paques BV, The Netherlands
- Habets LHA, Knelissen TH (1985) Application of the UASB reactor in anaerobic treatment of paper and board mill effluent. *Water Sci Technol* 17:61–75
- Habets LHA, Engelaar AJHH, Groeneveld N (1997) Anaerobic treatment of inuline effluent in an internal circulation reactor. *Water Sci Technol* 35(10):189–197. doi:10.1016/S0273-1223(97)00203-5
- Hall ER (1982) Biomass retention and mixing characteristics in fixed film and suspended growth anaerobic reactors. In: International association of water pollution. Research seminar on anaerobic treatment of wastewater in fixed film reactors, Copenhagen, pp 371–396
- Hall ER, Jovanovic M (1983) Anaerobic treatment of thermal sludge conditioning liquor with fixed-film and suspended-growth processes. In: Proceedings of the 37th industrial waste conference, Purdue University

- Hanaki K, Chatsanguthai S, Matsuo T (1994) Characterization of accumulated biomass in anaerobic filter treating various types of substrates. *Bioresour Technol* 47(3):275–282
- Hanssen JF (1983) Produksjon av energirik biogass. *Miljøteknikk* 3:14–20
- Hanssen JF, Indergaard M, Østgaard K, Bævre OA, Pedersen TA, Jensen A (1987) Anaerobic digestion of *Laminaria* spp. and *Ascophyllum nodosum* and application of end products. *Biomass* 14(1):1–13
- Harada H, Momonoi K, Yamazaki S, Takizawa S (1994) Application of anaerobic-UF membrane reactor for treatment of a wastewater containing high strength particulate organics. *Water Sci Technol* 30(12):307–319
- Hayes TD, Chynoweth DP, Reddy KR, Schwegler B (1985) Methane from an integrated hyacinth treatment anaerobic digestion facility. In: Twelfth annual energy technology conference and exposition, Washington, pp 1782–1793
- He Y-L, Geng X-L, Yang S-H (1995) Sludge granulation in a UASB reactor for the treatment of soda-anthraquinone chemical wheat-straw pulp black liquor. *Bioresour Technol* 51(2–3): 213–215. doi:10.1016/0960-8524(94)00122-H
- Hickey RF (1982) Anaerobic fluidized bed treatment of whey: effect of organic loading rate, temperature and substrate concentration. In: First international conference on fixed-film biological processes, Kings Island, OH, pp 1456–1476
- Hills DJ (1980) Biogas from a high solids combination of dairy manure and barley straw. *Trans Amer Soc Agric Eng* 23(6):1500–1504
- Hilton MG, Archer DB (1988) Anaerobic digestion of a sulfate-rich molasses wastewater: inhibition of hydrogen sulfide production. *Biotechnol Bioeng* 31(8):885–888
- Hoeks FWJMM, Ten Hoopen HJG, Roels JA, Kuenen JG (1984) Anaerobic treatment of acid water (methane production in sulfate rich environment). *Prog Ind Microbiol* 20:113–119
- Hulshoff Pol L, Lettinga G (1986) New technologies for anaerobic wastewater treatment. *Water Sci Technol* 18(12):41–53
- Hulshoff Pol LW, De Castro Lopes SI, Lettinga G, Lens PNL (2004) Anaerobic sludge granulation. *Water Res* 38(6):1376–1389. doi:10.1016/j.watres.2003.12.002
- Jeganathan J, Nakhla G, Bassi A (2007) Oily wastewater treatment using a novel hybrid PBR-UASB system. *Chemosphere* 67(8):1492–1501. doi:10.1016/j.chemosphere.2006.12.047
- Jewell WJ, Switzenbaum MS, Morris JW (1981) Municipal wastewater treatment with the anaerobic attached microbial film expanded bed process. *J Wat Pollut Control Fed* 53(4): 482–490
- Kato MT, Field JA, Kleerebezem R, Lettinga G (1994) Treatment of low strength soluble wastewaters in UASB reactors. *J Ferment Bioeng* 77(6):679–686
- Kennedy KJ, Droste RL (1985) Startup of anaerobic downflow stationary fixed film (DSFF) reactors. *Biotechnol Bioeng* 27(8):1152–1165
- Kennedy KJ, Droste RL (1991) Anaerobic wastewater treatment in downflow stationary fixed film reactors. *Water Sci Technol* 24(8):157–177
- Kennedy KJ, Van den Berg L (1981) Effects of temperature and overloading on the performance of anaerobic fixed-film reactors. In: Proceedings of the 36th Purdue industrial waste conference, West Lafayette, IN, pp 678–685
- Kennedy K, Van den Berg L (1982a) Anaerobic digestion of piggery waste using a stationary fixed film reactor. *Agric Wastes* 4(2):151–158. doi:10.1016/0141-4607(82)90023-3
- Kennedy K, van den Berg L (1982b) Effect of height on the performance of anaerobic downflow stationary fixed film (DSFF) reactors treating bean blanching waste, Proceedings of the 37th industrial waste conference. Purdue University, West Lafayette, IN, pp 71–76
- Kennedy K, Van den Berg L (1982c) Stability and performance of anaerobic fixed film reactors during hydraulic overloading at 10–35°C. *Water Res* 16(9):1391–1398. doi:10.1016/0043-1354(82)90223-8
- Khan A (1995) Municipal waste water treatment and energy recovery. In: Khanna S, Mohan K (eds) *Wealth from waste*. Tata Energy Research Institute, New Delhi, pp 195–213
- Kirby KD (1980) The design and operation of a pilot scale anaerobic [Digester] for the treatment of piggery waste. Paper presented at the Agricultural Engineering Conference, Geelong

- Kumar K, Dasgupta CN, Nayak B, Lindblad P, Das D (2011) Development of suitable photobioreactors for CO₂ sequestration addressing global warming using green algae and cyanobacteria. *Bioresour Technol* 102(8):4945–4953
- Lettinga G, Van Velsen AFM (1974) Anaerobic treatment of low-strength wastes. H₂O 7:281
- Lettinga G, van Velsen AFM, Hobma SW, de Zeeuw W, Klapwijk A (1980) Use of the upflow sludge blanket (USB) reactor concept for biological wastewater treatment, especially for anaerobic treatment. *Biotechnol Bioeng* 22(4):699–734. doi:10.1002/bit.260220402
- Lettinga G, Hobma SW, Zeeuw WJd, Velsen AFMv, Hulshoff Pol LW, Klapwijk A (1983) Use of the upflow anaerobic sludge blanket process in waste water treatment. In: Wise DL (ed) *Fuel gas system*. CRC-Press, West Palm Beach, FL, pp 61–84
- Li A, Sutton PM, Corrado JJ (1982) Energy recovery from pretreatment of industrial wastes in the anaerobic fluidized bed process, First international conference on fixed film biological processes. University of Pittsburgh, Kings Island, OH, pp 1521–1541
- Liang Y, Qian Y, Hu J (1993) Research on the characteristics of start up and operation of treating brewery wastewater with an AFB reactor at ambient temperatures. *Water Sci Technol* 28(7):187–195
- Lo KV, Liao PH, Whitehead AJ (1985) Methane production at 22°C of laboratory-scale fixed-film reactors receiving screened dairy manure. *Energy Agric* 4:1–13
- Lo KV, Liao PH, Gao YC (1994) Anaerobic treatment of swine wastewater using hybrid UASB reactors. *Bioresour Technol* 47(2):153–157
- Mahmoud N, Zeeman G, Gijzen H, Lettinga G (2004) Anaerobic sewage treatment in a one-stage UASB reactor and a combined UASB-digester system. *Water Res* 38(9):2348–2358
- Maree J, Gerber A, McLaren A, Hill E (1987) Biological treatment of mining effluents. *Environ Technol* 8(1):53–64
- Martenson L, Frostell B (1982) Anaerobic wastewater treatment in a carrier assisted sludge bed reactor. In: *Proceedings of the IAWPRC – specialized seminar on anaerobic treatment, Copenhagen*
- McCarty PL (1982) In: Hughes DE, Stafford DA, Wheatley BI (eds) *One hundred years of anaerobic treatment, Anaerobic digestion, 1981: Proceedings of the 2nd international symposium on anaerobic digestion*. Elsevier Biomedical Press, Amsterdam, pp 3–22
- Monroy O, Johnson K, Wheatley A, Hawkes F, Caine M (1994) The anaerobic filtration of dairy waste: results of a pilot trial. *Bioresour Technol* 50(3):243–251
- Morgan PF, Blodgett JH (1954) Studies of accelerated digestion of sewage sludge. *Sewage Ind Waste* 26(4):462–478
- Morris JW, Jewell WJ (1981) Organic particulate removal with the anaerobic attached film expanded bed process. In: *Proceedings of the 36th annual Purdue industrial waste conference, Lafayette, IN*, pp 621–630
- Mudliar S, Giri B, Padoley K, Satpute D, Dixit R, Bhatt P, Pandey R, Juwarkar A, Vaidya A (2010) Bioreactors for treatment of VOCs and odours – A review. *Journal of Environmental Management* 91(5):1039–1054. doi:10.1016/j.jenvman.2010.01.006
- Murray WD, Van Den Berg L (1981) Effects of nickel, cobalt, and molybdenum on performance of methanogenic fixed-film reactors. *Appl Environ Microbiol* 42(3):502–505
- Mutombo DT (2004) Internal circulation reactor: pushing the limits of anaerobic industrial effluents treatment technologies. In: *2004 water institute of Southern Africa (WISA) biennial conference, Cape Town, South Africa*, pp 608–616
- Ng WJ, Chin KK, Wong KK (1987) Energy yields from anaerobic digestion of palm oil mill effluent. *Biol Wastes* 19(4):257–266
- Nobre CA, Guimaraes MO (1987) Experimentos em digestão anaeróbia de esgotos urbanos. *Revista DAE* 47:75–85
- Norrman J (1982) Treatment of black liquor condensate from a pulp mill in an anaerobic filter and an expanded bed. In: *International association of wastewater pollution. Research seminar on anaerobic treatment of wastewater in fixed film reactors, Copenhagen*, pp 255–264
- O’Flaherty V, Collins G, Mahony T (2006) The microbiology and biochemistry of anaerobic bioreactors with relevance to domestic sewage treatment. *Rev Environ Sci Biotechnol* 5(1):39–55. doi:10.1007/s11157-005-5478-8

- Ozturk I, Eroglu V, Ubay G, Demir I (1993) Hybrid upflow anaerobic sludge blanket reactor (HUASBR) treatment of dairy effluents. *Water Sci Technol* 28(2):77–85
- Palns S, Loewenthal RE, Wentzel M, Marais GR (1990) Growth of biopellets on glucose in upflow anaerobic sludge bed (UASB) systems. *Water SA* 16(3):151–164
- PAQUES (2011) Paques – BIOPAQ® UASB. PAQUES. <http://www.paques.nl/?pid=43>. Accessed 1 May 2011
- Peck MW, Hawkes FR (1987) Anaerobic digestion of cattle slurry in an upflow anaerobic filter. *Biomass* 13(2):125–133
- Peng D, Zhang X, Jin Q, Xiang L, Zhang D (1994) Effects of the seed sludge on the performance of UASB reactors for treatment of toxic wastewater. *J Chem Technol Biotechnol* 60(2):171–176
- Prasertsan P, Jung S, Buckle K (1994) Anaerobic filter treatment of fishery wastewater. *World J Microbiol Biotechnol* 10(1):11–13
- Rajamani S, Suthanthararajan R, Ravindranath E, Mulder A, van Groenestijn JW, Langerwerf JSA (1995) Treatment of tannery wastewater using upflow anaerobic sludge blanket system (UASB). In: 30th LERIG, Chennai, pp 57–66
- Ramakrishnan A, Gupta SK (2006) Anaerobic biogranulation in a hybrid reactor treating phenolic waste. *J Hazard Mater* 137(3):1488–1495
- Ramakrishnan A, Gupta SK (2008) Effect of hydraulic retention time on the biodegradation of complex phenolic mixture from simulated coal wastewater in hybrid UASB reactors. *J Hazard Mater* 153(1–2):843–851
- Ramasamy EV, Gajalakshmi S, Sanjeevi R, Jithesh MN, Abbasi SA (2004) Feasibility studies on the treatment of dairy wastewaters with upflow anaerobic sludge blanket reactors. *Bioresour Technol* 93(2):209–212. doi:10.1016/j.biortech.2003.11.001
- Rintala JA, Lepistö SS (1992) Anaerobic treatment of thermomechanical pulping whitewater at 35–70°C. *Water Res* 26(10):1297–1305
- Rinzema A, Schultz C (1987) Anaerobic treatment of acid water on a semi-technical scale. Department of Environmental Technology, Agricultural University Wageningen, The Netherlands (in Dutch)
- Rinzema A, Alphenaar A, Lettinga G (1993) Anaerobic digestion of long-chain fatty acids in UASB and expanded granular sludge bed reactors. *Process Biochem* 28(8):527–537
- Ripley LE, Totzke DE, Hwang IC (1988) Bench-scale evaluation of the anaerobic contact process for treating ice cream novelty wastewater, Proceedings of the 43rd industrial waste conference. Purdue University, West Lafayette, IN, pp 561–567
- Rozzi A, Passino R, Limoni M (1989) Anaerobic treatment of olive mill effluents in polyurethane foam bed reactors. *Process Biochem* 4:68–74
- Saravanan V, Sreerishnan TR (2006) Modelling anaerobic biofilm reactors—A review. *Journal of Environmental Management* 81(1):1–18. doi:10.1016/j.jenvman.2005.10.002
- Sanjeevi R, Gajalakshmi S, Abbasi T, Abbasi SA, (2011) Treatment of low-strength shampoo industry wash waters with simultaneous recovery of clean energy using a new ‘rapid upflow granular anaerobic sludge’ (RUGAS) reactor, *International Journal of Chemical and Environmental Engineering Systems* 2(1):29–35
- Sayed SKI, Van der Spoel H, Truijten GJP (1993) A complete treatment of slaughterhouse wastewater combined with sludge stabilization using two stage high rate UASB process. *Water Sci Technol* 27(9):83–90
- Schellinkhout A, Jakma FFGM, Forero GE (1988) Sewage treatment: the anaerobic way is advancing in Columbia. In: 5th international symposium on anaerobic digestion, Bologna, Italy, pp 767–770
- Schroepfer GJ, Ziemke NR (1959a) Development of the anaerobic contact process. II. Ancillary Investigations and Specific Experiments. *Sewage Ind Waste* 31(6):697–711
- Schroepfer GJ, Ziemke NR (1959b) Development of the anaerobic contact process: I. Pilot-Plant investigations and economics. *Sewage Ind Waste* 31(2):164–190
- Schroepfer G, Fullen W, Johnson A, Ziemke N, Anderson J (1955) The anaerobic contact process as applied to packinghouse wastes. *Sewage Ind Waste* 27(4):460–486

- Sharma S, Ramakrishna C, Desai J, Bhatt N (1994) Anaerobic biodegradation of a petrochemical waste-water using biomass support particles. *Appl Microbiol Biotechnol* 40(5):768–771
- Sharma K, Liu H, Lau BLT, Li J, Yu T, Liu Y (2009) Biofilm fixed film systems. *Water Environ Res* 81(10):1194–1216. doi:10.2175/106143009X12445568399532
- Shen CF, Kosaric N, Blaszczyk R (1993) Properties of anaerobic granular sludge as affected by yeast extract, cobalt and iron supplements. *Appl Microbiol Biotechnol* 39(1):132–137
- Sorlini C, Ranalli G, Merlo S, Bonfanti P (1990) Microbiological aspects of anaerobic digestion of swine slurry in upflow fixed-bed digesters with different packing materials. *Biol Wastes* 31(3):231–239
- Soto M, Ruiz I, Fereiro MJ, Veiga MC, Vegae R (1995) Blázquez anaerobic treatment of domestic and industrial (Low concentration) wastewaters, Proceedings of the 3rd international conference appropriate waste management technologies for developing countries. NERRI, Nagpur, pp 3–11
- Steffen A (1961) Operation of full-scale anaerobic contact treatment plant for meatpacking wastes, Proceedings of the 16th industrial waste conference. Purdue University, USA, pp 423–437
- Stevens TG, van den Berg L (1982) Anaerobic treatment of food processing wastes using a fixed-film reactor. In: Proceedings of the 36th industrial waste conference, Lafayette, IN, pp 224–232
- Sutton PM, Huss DA (1984) Anaerobic fluidized bed biological treatment: pilot to full-scale demonstration, Water pollution control federation conference. Water Pollution Control Federation, New Orleans, Louisiana
- Switzenbaum MS (1980) Anaerobic expanded-bed treatment of wastewater. In: US Department of Energy Workshop/Seminar of Anaerobic Filters, Howey-In-The-Hills, FL
- Switzenbaum MS (1983) A comparison of the anaerobic filter and the anaerobic expanded/fluidized bed processes. *Water Sci Technol* 15(8–9):345–358
- Szendrey L (1983a) The Bacardi corporation digestion process for stabilizing rum distillery wastes and producing methane, Energy from Biomass and Wastes VII. Institute of Gas Technology, Chicago, IL, pp 767–790
- Szendrey L (1983b) Start-up and operation of the Bacardi Corporation anaerobic filter. In: Proceedings of the 3rd international symposium on anaerobic digestion, Boston, pp 14–19
- Tandukar M, Ohashi A, Harada H (2007) Performance comparison of a pilot-scale UASB and DHS system and activated sludge process for the treatment of municipal wastewater. *Water Res* 41(12):2697–2705. doi:10.1016/j.watres.2007.02.027
- Tanemura K, Kida K (1994) Anaerobic treatment of wastewater with high salt content from a pickled-plum manufacturing process. *J Ferment Bioeng* 77(2):188–193
- Tawfik A, Ohashi A, Harada H (2006) Sewage treatment in a combined up-flow anaerobic sludge blanket (UASB)-down-flow hanging sponge (DHS) system. *Biochem Eng J* 29(3):210–219. doi:10.1016/j.bej.2005.11.018
- Tilche A, Bortone G, Forner G, Indulti M, Stante L, Tesini O (1994) Combination of anaerobic digestion and denitrification in a hybrid upflow anaerobic filter integrated in a nutrient removal treatment plant. *Water Sci Technol* 30(12):405–414
- Toldrá F, Flors A, Lequerica J, Vallés S (1986) Fluidized bed biomethanation of acetic acid. *Appl Microbiol Biotechnol* 23(5):336–341
- Torpey WN, Schlenz HE, Heukelekian H, King HR (1955) Loading to failure of a pilot high-rate digester. *Sewage Ind Waste* 27(2):121–148
- Uemura S, Harada H (1993) The effect of temperature on the performance of thermophilic UASB reactors. *Environ Technol* 14(9):897–900
- USEPA (1997a) Estimate of global greenhouse gas emissions from industrial and domestic wastewater treatment. United States Environmental Protection Agency, Office of Policy Planning and Evaluation, EPA-600/R-97-091, Washington, DC
- USEPA (1997b) Supplemental technical development document for effluent limitations guidelines and standards for the pulp, paper, and paperboard category. United States Environmental Protection Agency, Office of Water. EPA/821-R-97-011, Washington, DC

- USEPA (2006) Global anthropogenic non-CO₂ greenhouse gas emissions: 1990–2020. U.S. Environmental Protection Agency. <http://www.epa.gov/nonco2/econ-inv/international.html>. Accessed 4 May 2011
- Van den Berg L (1984) Developments in methanogenesis from industrial wastewater. *Can J Microbiol* 30:975–990
- van den Berg L, Kennedy KJ (1981) Support materials for stationary fixed film reactors for high-rate methanogenic fermentations. *Biotechnol Lett* 3(4):165–170. doi:10.1007/bf00239656
- van den Berg L, Kennedy K (1982) Comparison of intermittent and continuous loading of stationary fixed-film reactors for methane production from wastes. *J Chem Technol Biotechnol* 32(2):427–432
- van den Berg L, Kennedy K (1983) Comparison of advanced anaerobic reactors. In: Proceedings of the 3rd international symposium on anaerobic digestion, Boston, pp 71–79
- van den Berg L, Lentz CP (1977) Methane production during treatment of food plant wastes by anaerobic digestion. In: Cornell agricultural wastes management conference, pp 381–393
- van den Berg L, Lentz C (1979) Developments in the design and operation of anaerobic fermenters, First Bioenergy R&D Seminar. National Research Council of Canada, Ottawa
- van Den Berg L, Lentz C, Armstrong D (1981) Methane production rates of anaerobic fixed film fermentors as compared to those of anaerobic contact and fully mixed continuous fermentors. In: Moo-Young M, Robinson C (eds) *Advances in biotechnology*. Pergamon Press, NY, USA, pp 251–256
- Van Groenestijn J, Letitre P, Zhongbai G, Lucas M, Van Den Hark S (2004) Reduction of emissions from Chinese tanneries. *Water* 21:27–28
- Van Haandel A, Kato MT, Cavalcanti PFF, Florencio L (2006) Anaerobic reactor design concepts for the treatment of domestic wastewater. *Rev Environ Sci Biotechnol* 5(1):21–38. doi:10.1007/s11157-005-4888-y
- van Velsen AFM (1979) Anaerobic digestion of piggery waste, 2: start-up procedure. *Neth J Agric Sci* 27:142–152
- Vandamme K, Waes G (1980) Anaerobic pretreatment of dairy wastewater. *Antonie Van Leeuwenhoek* 46(1):109–109
- Veiga MC, Mendez R, Lema JM (1994) Anaerobic filter and DSFF reactors in anaerobic treatment of tuna processing wastewater. *Water Sci Technol* 30(12):425–432
- Vieira S, Carvalho J, Barijan F, Rech C (1994) Application of the UASB technology for sewage treatment in a small community at Sumare, Sao Paulo State. *Water Sci Technol* 30(12):203–210
- Visser A, Beeksmas I, Zee F, Stams A, Lettinga G (1993) Anaerobic degradation of volatile fatty acids at different sulphate concentrations. *Appl Microbiol Biotechnol* 40(4):549–556
- Walfer M (2008) Training material on anaerobic wastewater treatment. Ecosan Expert Training Course, Version 3. Seecon gmbh, Switzerland
- Ward AJ, Hobbs PJ, Holliman PJ, Jones DL (2008) Optimisation of the anaerobic digestion of agricultural resources. *Bioresour Technol* 99(17):7928–7940. doi:10.1016/j.biortech.2008.02.044
- Wilkie A, Colleran E (1984) Start-up of anaerobic filters containing different support materials using pig slurry supernatant. *Biotechnol Lett* 6(11):735–740
- Wilkie A, Colleran E (1986) Pilot-scale digestion of pig slurry supernatant using an upflow anaerobic filter. *Environ Technol* 7(1):65–76
- Yoda M, Shin SW, Watanabe A, Watanabe M, Kitagawa M, Miyaji Y (1987) Anaerobic fluidized bed treatment with a steady-state biofilm. *Water Sci Technol* 19:287–298
- Young JC, Dahab MF (1983) Effect of media design on the performance of fixed-bed anaerobic reactors. *Water Sci Technol* 15(8–9):369–383

Chapter 7

Biogas Capture from Solid Waste

Abstract Among the most vexing of environmental problem being faced by the world is that of solid waste, of which a major component is biodegradable solid waste (BSW). When left to rot in the open, or when disposed in sanitary landfills, BSW undergoes anaerobic digestion leading to generation of methane. It translates to lost energy but also to global warming.

This realization, and the failure of other methods, such as incineration and composting, to handle BSW without generating newer problems of pollution, has focused global attention towards the use of anaerobic digestion to treat BSW with concomitant generation of energy in the form of biogas.

But whereas a number of processes have been developed, principally in Europe, to treat large quantities of BSW, and increasingly larger quantities of BSW are being treated by anaerobic digestion all over the world, a number of technological problems still remain to be solved before the processes can become profitable. The present chapter discusses all these aspects and issues alongside presenting latest information on the penetration of anaerobic digestion-based processes in BSW treatment.

7.1 Introduction

Theoretically, enormous quantities of energy as biogas can be generated from biodegradable solid waste (BSW) (Table 7.1). Since solid waste is produced all over the world in quantities several times greater than animal manure, any process which can generate net energy from solid waste as biogas – in other words generate more energy than is spent in operating the process – would be a very great boon. All other existing methods of processing BSW, for example, incineration and composting, are either net energy consumers or hazardous to environmental health. In comparison anaerobic digestion is much more clean and benign.

Table 7.1 Biogas potential of different forms of biodegradable solid waste, at 35°C

Biodegradable solid waste (BSW)	Biogas obtainable on batch digestion (L kg ⁻¹ , dry weight)	Methane in biogas %
Banana (fruit and stem)	940	53
Potato (tuber)	880	54
Sugar beet (root)	620	65
Sugar beet (leaves)	380	66
Grass	450–530	55–57
Maize (whole plant)	350–500	50
Oats (whole plant)	450–480	51–55
Hay	350–460	54–65
Straw (ground)	350–450	54–58
Garbage (organic fraction)	380	48
Water hyacinth	400–420	56
Nymphae	450–480	56
Straw (chapped)	250–350	58
Salvinia	430–480	58
Newspaper	240	52

Unfortunately, several daunting problems are encountered when applying anaerobic digestion process to generate biogas from solid wastes such as weeds, leaf-litter, vegetable and fruit peels, biodegradable portions of municipal solid waste (MSW), and other biomass. Due to these problems more energy has to be invested in the process than is gained in the form of biogas. This has, in turn, limited the use of anaerobic digestion for the treatment of BSW. As for anaerobic digestion of MSW, it is presently restricted to Europe and a few other developing countries because the overall process consumes more energy than it generates and is not “profitable” in that sense.

The engineering problems associated with the use of BSW in conventional biogas digesters are (Abbasi and Abbasi 2010):

- (a) The BSW cannot be fed to the conventional “low-rate” (fixed-dome and floating-dome biogas digesters) of the type which are extensively used in most of the third world countries (Chap. 5) to generate biogas from animal dung-water slurry. This is because the BSW does not flow out of the digester exit along with water, as the animal dung-water slurry does, but, instead, accumulates in the digester to eventually clog it. Even when fed as partial feed supplement along with animal dung slurry, the BSW eventually clogs the digesters (Abbasi and Nipanay 1984, 1986, 1994; Abbasi and Ramasamy 1996; Ramasamy and Abbasi 1999; Bouallagui et al. 2005; Yadvika et al. 2004). Shredding or mincing of the BSW prior to charging does not help either, it makes feeding easy but also leads to equally quick formation of scum which badly clogs the digester. As a result the digesters become non-functional a few weeks after start up with BSW. BSW can be used in continuously stirred tank reactors (CSTR) which are commonly employed in most developed countries for anaerobically digesting

piggery and dairy wastes, but only after shredding it into fine pieces and making slurry with water. This operation, however, consumes energy and contributes to the eventual net energy consumption of the digester.

- (b) When BSW is in the form of food waste, fruit/vegetable pieces, and weeds, another problem has to be confronted with: several of these constituents contain less than 4% volatile solids (VS). Their total solids (TS) content is rarely above 7 and 93–95% of the phytomass is comprised of water (Gajalakshmi et al. 2001a, b, 2002; Sankar Ganesh et al. 2005; Ramasamy et al. 2004). Thus even the whole plants represent a rather lean source of VS and if a BSW-water slurry is made as digester feed it is even leaner in VS than the whole plants. The effective space-VS-loading in digester of such a feed would give a very poor energy yield per unit digester volume. But 75–85% of the cost of any anaerobic digestion process is consumed by the reactor (Abbasi and Nipanay 1993; Sankar Ganesh et al. 2008) and enhancing the methane yield per unit reactor volume is essential to make the process viable. Some of the phytomass has less water but contains 85% or more water nevertheless (Gajalakshmi and Abbasi 2004, 2008). Any attempt at formation of its slurry ends up making it too lean in VS to be economically beneficial as energy source.

These problems have necessitated identifying alternative ways and means of utilizing solid biowastes for methane generation. Out of the new concepts that have emerged, the promising alternatives are multi-phase anaerobic digestion, solid-feed anaerobic digestion, and “high-solids digestion.”

7.2 Multi-phase Digestion

As explained in more detail earlier (Chap. 2), anaerobic digestion involves four steps in three phases:

- “Hydrolysis phase” in which cellulolytic micro-organisms convert complex organic matter (cellulose, hemicellulose) into simpler organics.
- “Acid phase,” which includes the steps of acidogenesis and acitogenesis in which the acidogenic bacteria convert the organics into higher fatty acids (such as propionic acid, butyric acid) followed by conversion of these acids to the simpler acetic acid and hydrogen by acitogenic bacteria.
- “Methane phase” in which methanogenic bacteria convert the substrates produced in the acitogenic step into methane.

The consortia of bacteria involved in the last two phases are very dissimilar, having different physiological and nutritional requirements. The optimal environmental conditions, such as temperature and pH, for each phase are also different. Kinetically also the three phases are different where the first and the second phases are faster than the third. Lastly, while methanogenic bacteria are very sensitive to fluctuations in process parameters, such as pH, temperature, and organic loading rate requiring

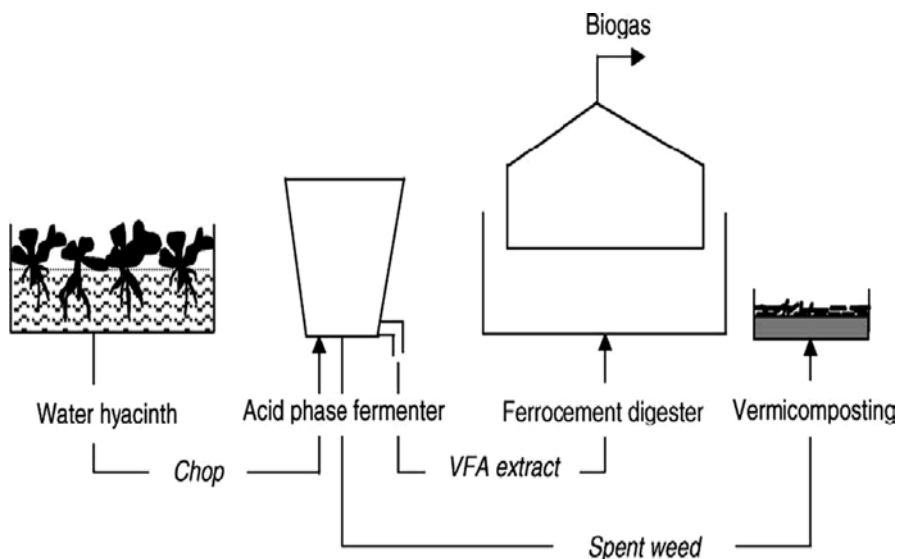

Fig. 7.1 The VFA extraction-biogas-generation-vermicomposting system for water hyacinth utilization

rigid process control, the bacteria involved in the other two phases are much less sensitive to such fluctuations. In the conventional anaerobic digestion processes, the three phases are operated in the same tank under a single process regime. As the slower and more delicate methanogenic phase dictates the boundary conditions, such conventional processes operate at the rate, pH, temperature, and organic loading conditions suitable for methanogenesis, possibly at the expense of the efficiency of the previous two phases. As the first phase leads to the second which in turn leads to the third, any inefficiency in the operation of the first two phases, if there, would tell upon the ultimate product, that is methane.

The concept of “phase separation” involves operating the anaerobic digestion process in distinct phases. When all the three phases are operated separately, the process is termed “three-phase,” “three-stage,” or “triphasic.” In some cases the first and the second phase are operated together while the methane phase is run separately. Such processes come to be known as “two-phase,” “two-stage,” or “diphasic” processes. The product of the first two phases (in the case of triphasic reactors) are the VFAs. These soluble acids are used as feed in the high-rate digesters like UASB and AFs to obtain biogas as the product.

The concept of phase separation becomes very useful when dealing with phyto-mass because VFAs can be extracted in liquid (aqueous solution) form it. Thereafter, it is very easy to convert VFAs into biogas in any conventional low-rate or high-rate anaerobic reactor.

The feasibility of this approach has been demonstrated by Sankar Ganesh et al. (2005) in generating biogas from water hyacinth (*Eichhornia crassipes*). The three-stage process is as depicted in Fig. 7.1. In the first stage, volatile fatty acids

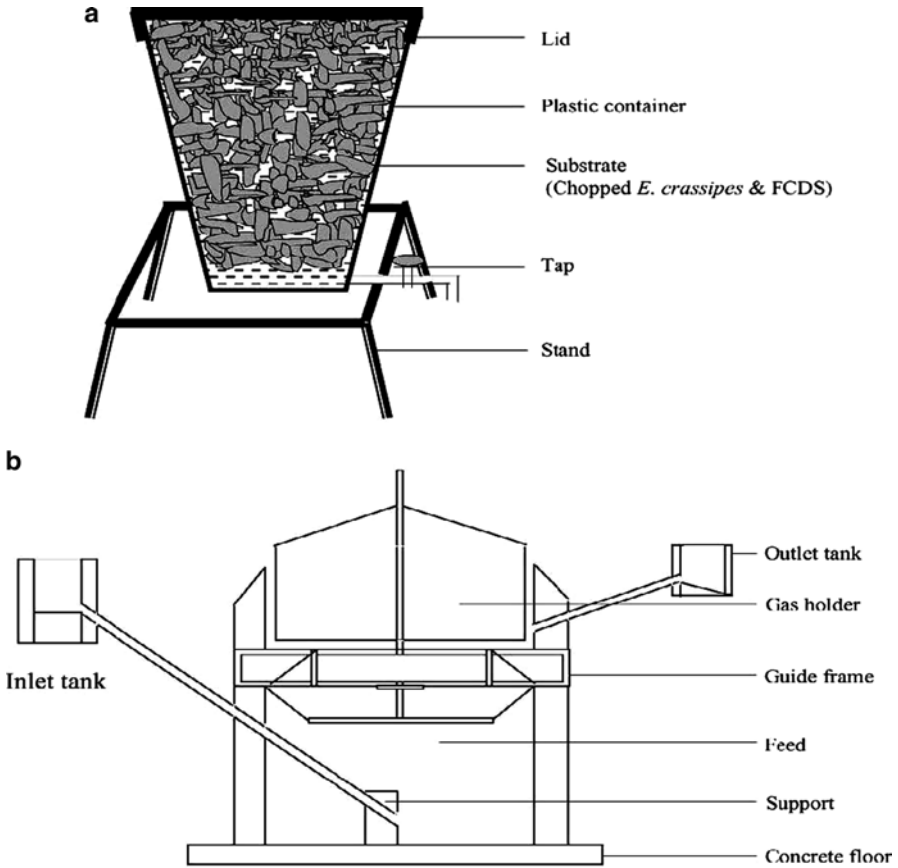

Fig. 7.2 (a) Acid phase reactors. (b) The conventional semi-continuous slug flow biogas digester. It was used to study the efficacy of the fortification of cow dung slurry by VFAs obtained from the $31,271 \text{ L m}^3 \text{ d}^{-1}$

(VFAs) are extracted from aquatic weeds using inexpensive contraptions such as plastic buckets with tap at the bottom, and plastic rod for occasional stirring (Fig. 7.2). The idea is to have a technology so simple that even illiterate farmers can utilize it. In the second stage, the VFAs are used along with cow dung in conventional biogas digesters. This is also a simple step. All it needs is that the slightly murky water coming from the first stage is used to make cow dung slurry instead of any other water. The third stage comprises of composting–vermicomposting the “spent” phytomass after VFAs have been extracted. Once again these are processes which need nothing more sophisticated than boxes and shovels (Sankar Ganesh et al. 2009).

As only carbon is lost from the weeds during the process of VFA formation, the C:N ratio of the “spent” phytomass is lesser (and more favourable) than

the C:N ratio of the unprocessed weed. This facilitates composting as well as vermicomposting (Gajalakshmi and Abbasi 2008). The overall system promises to fully utilize the weeds partly in generating energy (in the form of biogas) and partly in producing fertilizer (in the form of vermicompost). In other words, it is a total disposal process. Moreover, in terms of global warming potential the system is at least carbon neutral but most probably releases less CO₂ than is fixed by the phytomass because a substantial portion of the phytomass carbon gets added to the carbon sink (represented by soil) in the form of compost/vermicompost (Abbasi and Abbasi 2010).

7.3 Solid-Feed Anaerobic Digestion

Another of the attempts involves the use of “solid-feed anaerobic digesters” (SFADs; Fig. 7.3). In these systems BSW is fed in its solid state, either as chopped pieces or in air-dried form in specially designed SFADs (Sankar Ganesh et al. 2008).

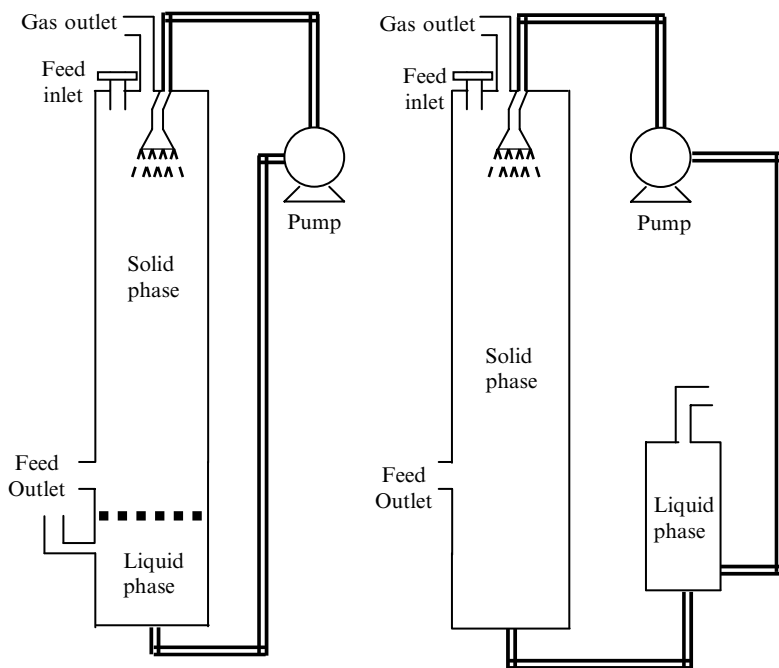

Fig. 7.3 Two types of solid feed anaerobic digesters (SFADs) employed for the anaerobic digestion of ipomoea: SFAD-I (left) and SFAD-II (right)

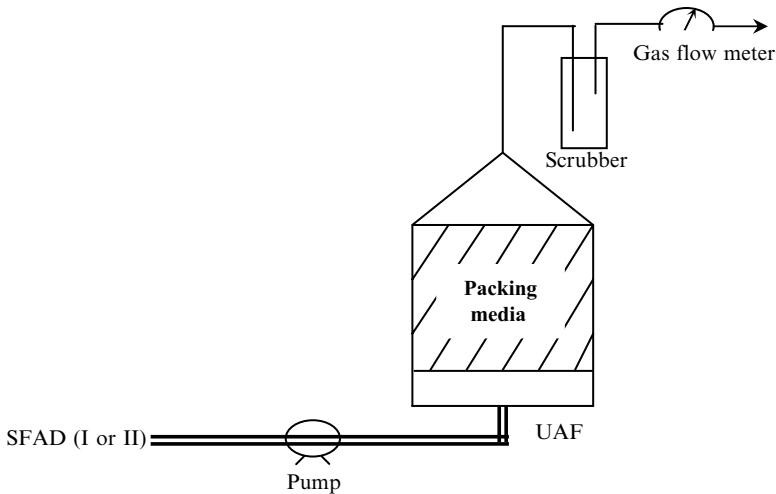

Fig. 7.4 A typical upflow anaerobic filter (UAF) attached to SFAD-I or SFAD-II. SFAD-I (*left*) and SFAD-II (*right*)

Some energy is thus saved which otherwise would have been needed in mincing (shredding) the weed if the feed were to be cow-dung-like slurry. It must be emphasized that whereas in terms like “solids retention time” (Chaps. 1 and 4) the word “solids” denotes mass of active micro-organisms, the word “solids” here refers to the substrate which is sought to be degraded by the micro-organisms.

“Solid-feed anaerobic digestion” should also be distinguished from “high-solids anaerobic digestion.” The latter term is generally used with reference to the feeds which contain more than 15% VS; such feeds may not necessarily be “solid” and are, more often than not, thick slurries. On the other hand, the former term refers to feeds which are “solid” (like weeds and other phytomass); they may not necessarily contain 15% or more VS and, indeed, often do not.

The SFADs developed by Sankar Ganesh et al. (2008) produce VFA-rich leachate which is converted to biogas in anaerobic filters (Fig. 7.4). SFADs generate some biogas themselves but the yield is greatly enhanced if an AF is attached (Fig. 7.5). The AFs, in turn, are also easy to fabricate. The SFADs can generate upto 2 m³ of biogas per m³ of reactor volume (Fig. 7.6) which represents an economically viable rate of energy generation by anaerobic digesters (Abbasi and Nipaney 1993). An special feature of SFAD is their remarkably steady performance (Fig. 7.6) considering that they contain solid feed and are run unstirred. The “spent” phytomass can be then composted/vermicomposted.

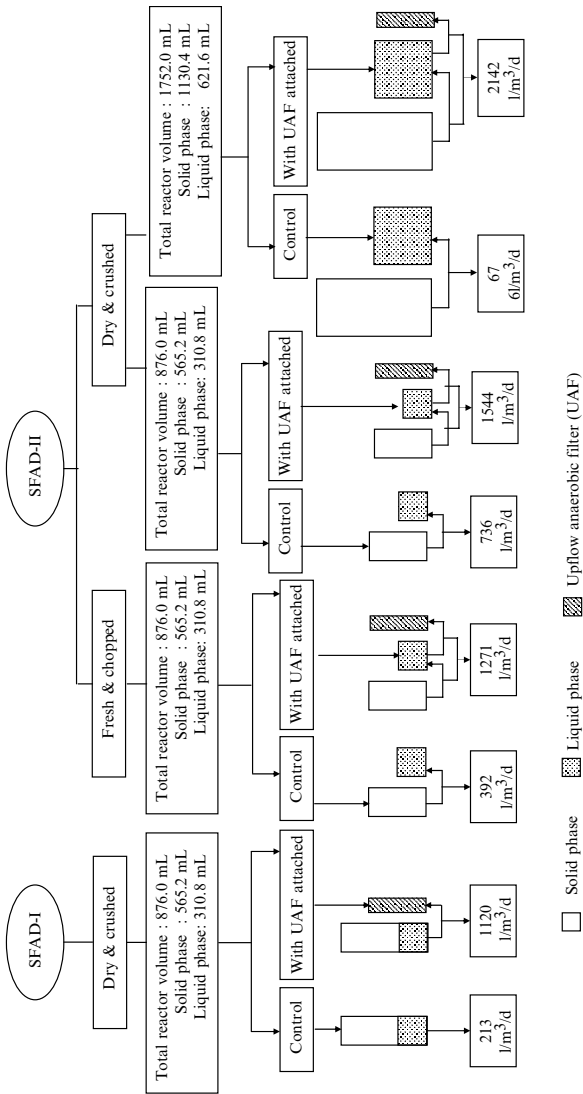

Fig. 7.5 The reactors and their performance in terms of biogas generated per litre of reactor volume per day. Solid phase, liquid phase, upflow anaerobic filter (UAF)

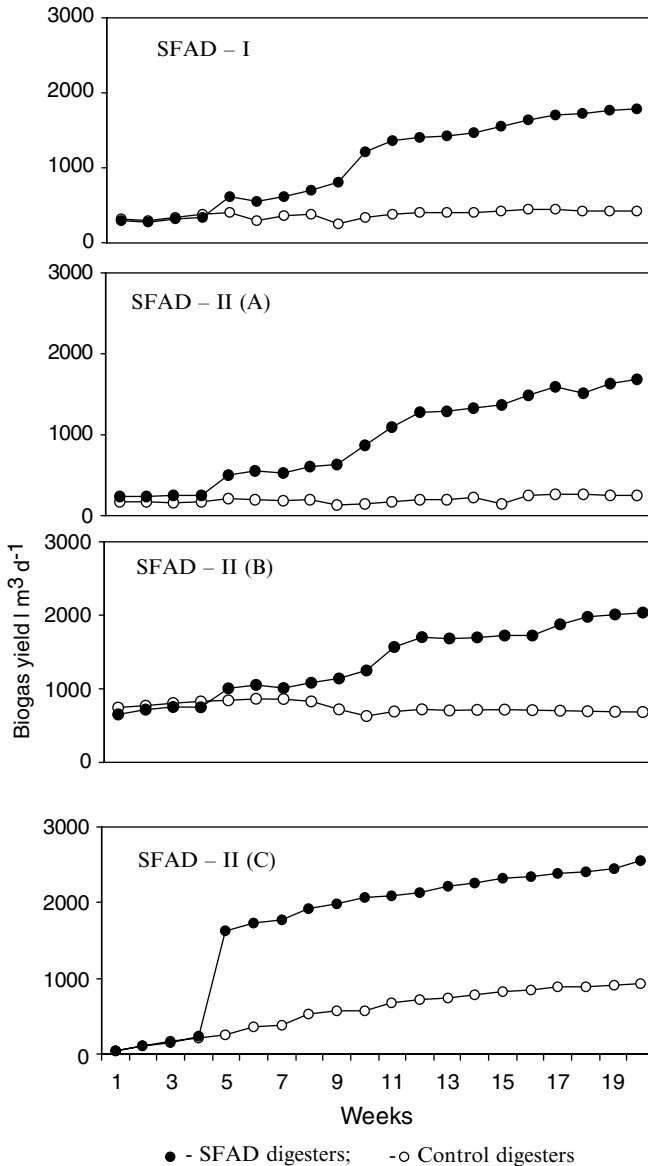

Fig. 7.6 Biogas yield, L m⁻³ d⁻¹, from different types of SFAD digesters

7.4 High-Solids Anaerobic Digestion

The disposal of BSW is becoming more and more problematic throughout the world. The bulk of the billions of tonnes of BSW generated world-wide is either land-filled or burned. Due to the hazardous emissions from combustion processes,

decreasing availability of land-fill sites, and other problems associated with the two – see Chap. 8 for a full discussion on landfills – the interest in alternative waste disposal processes has increased.

Anaerobic digestion of the biodegradable portion of BSW (MSW, and other “waste” biomass), has the potential of producing both considerable energy (methane) and an organic fertilizer-cum-soil conditioner. However, several key problems remain to be overcome before the methane produced from this route becomes economically competitive with conventional sources of natural gas.

Economic evaluations have shown that the reactor’s capital costs are a significant economic burden owing to the large reactor volumes required in current anaerobic processes operated normally at lower solids levels (3–5%). If the reactor volume could be reduced significantly, the economics of anaerobic digestion of BSW would improve. Increased solid loadings are particularly promising in this respect since available kinetic data indicate that gas production rates should increase with the solid concentration in the reactor. Thus, greater reactor efficiency would be achievable if higher solid concentrations can be utilized while maintaining the same volumetric solid loading rate and HRT.

Historically, research on high-solids anaerobic fermentation has focused on the single charge (batch), non-mixed reactor concept, generally with recirculation of effluent (Ghosh 1984; Goebel 1983; Jewell 1980). In these designs, gas production occurs either in a single stage, or leached acids may be circulated to a second methanogenic stage. With non-mixed systems, the rate of gas production is generally much slower than in mixed systems (Gaddy and Clausen 1985; Wujcik and Jewell 1980). The retention time required to effect a near to complete digestion of the substrate in this type of reactors is of the order of months at mesophilic temperatures and several weeks even at thermophilic temperatures.

The main problematic solid wastes, besides MSW, originate from food-processing industries, agro-industrial and in the form of agricultural residues. Over a billion tonnes of these types of wastes are generated per year. As the conventional biogas plants fail to treat such wastes efficiently, the high-solids digestion technology is being tried to solve the solid waste management problems since the early 1980s.

Biogas generation from willow dust (a textile industry solid waste produced at the rate of 33,000 tonnes per annum in India), and water mixture in the ratio of 1:6 using a laboratory-scale plug flow reactor was reported in the early 1980s (Balasubramanya et al. 1981). Further reduction of solid to liquid ratio to 1:1.5 has also been reported for the same waste but with a pre-treatment step using sodium hydroxide, lime, and effluent slurry from an ongoing biogas plant.

In another study (Shyam and Sharma 1994), anaerobic fermentation of agro-residues (paddy straw, tree leaves, parthenium foliage) in combination with cow dung, was carried out using batch reactors. The initial solid content of the reactors was kept at 16–19%. The gas yield was in the range 202–249 L m⁻³ d⁻¹ of digester volume at a HRT of 7 weeks. This is comparable to the gas yield of 204–372 L m⁻³ d⁻¹ in the case of semi-continuous type conventional digesters in which cow dung slurry with 8–9% TS is used as a substrate at 7 weeks retention time. However, the gas yield per kg of TS fed was significantly lower in high-solids fermentation than from a semi-continuous type conventional digester (Shyam and Sharma 1994).

Over the years efforts have continued all over the world but as on date there is no technology with which biodegradable fractions of MSW or phytomass can be anaerobically digested in an economically feasible manner. To summarize, if high-solid dry-digestion technology can be developed to an economically feasible stage, it would have advantages over the conventional anaerobic digesters in the following aspects:

- It would overcome the major problems associated with conventional biogas plants such as difficulties in feeding the phytomass into the reactor, buoyancy of the phytomass inside the reactor resulting in incomplete digestion, scum formation due to the floating solid fraction of the feed, blockage of the outlet pipe, etc. (Abbasi and Abbasi 2010).
- It would achieve freedom from elaborate pre-digestion processing or pre-treatment.
- It may entail saving on water: HSD consumes half or even lesser amount of water than that used in conventional biogas plants. Thus in places where water is scarce, the technology would become much more meaningful and practicable.
- The effluents discharged from conventional biogas plants have to be dewatered (usually by spreading on the ground) before transportation to fields, as manure. This contributes to fugitive methane emissions which add to global warming (Chap. 3). The slurry from high-solid reactor, especially from a batch/plug-flow type, is likely to be dry enough to be directly taken to the field for application.

But all these are, as of now, only possibilities! Efforts are being made all over the world to develop a net-energy-generating BSW treatment process. Claims of success on bench scale are announced every now and then. Some pilot plants have also been set up. But, to date, there is no full-scale BSW processing plant in operation which is a net energy producer, or is operable at no net cost.

7.5 Present Status of MSW Treatment by Anaerobic Digestion

7.5.1 *Advantages and Challenges*

Even as, at present, use of anaerobic digestion to treat MSW is, per tonne of waste, much costlier than the landfill option, it is being increasingly utilized in developing countries, especially Europe (De Baere and Mattheeuws 2010) due to its following attributes:

1. Because anaerobic digesters are enclosed systems, they allow all of the biogas to be collected, unlike the landfill biogas of which only 30–40% is usually captured if at all. Even at the best of times a maximum of 60% of landfill biogas is retrievable.
2. An end product that can be used as a soil conditioner is produced. By mixing the refuse with animal dung, the system efficiency can be improved, allowing for a more simple process design, thereby improving the economic viability of the system. This is due to better C:N ratio that is achieved if MSW is mixed with dung.

3. By diverting easily digestible organic waste material to anaerobic digesters instead of sending it to landfills, better overall methane capture is possible. Also reduction of which otherwise causes gaseous and liquid emissions from landfills, which would otherwise occur.

On the downside, anaerobic digestion of MSW is besieged with some problems:

1. The *nature* of organic waste in MSW may vary according to location and time of the year. In post-harvest seasons, for example, levels of crop waste, leaf-litter, etc., may be higher. This may lead to a variation in the C/N ratio and affect the rate of gas production.
2. Inadequate mixing of refuse and sewage can affect efficiency of the anaerobic digestion system.
3. Blockage of pipes can be caused if large pieces of waste enter the system. This problem is particularly common in continuous systems.

Table 7.2 provides an overview of the problems associated with the use of anaerobic digestion process in handling agricultural crops and other forms of solid waste.

Table 7.2 Problems encountered at different steps when anaerobic digestion process is sought to be utilized for crop and other solid waste (adopted from (Weiland 2005a))

Process step	Problems	Consequences
Storage	Formation of organic acids during storage (pickle-formation effect); partial digestion	Amounts to loss of some utilizable portion of the substrate Increases the risk of inhibition of the subsequent methanogenic process
	Formation of mould during ensiling and storage of energy crops	May cause inhibition of methanogenic activity in the digestion step
Substrate pre-treatment	Portions of the substrate may not get broken into sufficiently small pieces	Would reduce anaerobic degradation rate Risk of scum formation in fermenter Difficulty in the handling of the substrate
Solids feeding	Nature of feed makes it impossible to achieve exactly continuous flow	Reduces process stability Reduces biogas yield Can cause H ₂ S-surges occur in the biogas
	Mixing of silage and process water in an external open tank	Digestion occurs to some extent causing losses of methane to the atmosphere Mixing consumes a lot of energy
	Direct solids feeding by screw conveyor, piston, and flushing systems	Risk of blockage in screw conveyors of diameter <300 mm Piston systems cause compacting of long fibre crops Flushing systems cannot be applied for crops of low density

(continued)

Table 7.2 (continued)

Process step	Problems	Consequences
Fermenter and storage tank	Scum formation	Reduces biogas yield Causes clogging of the overflow pipe The entire process can break down
	Accumulation of biogas in the fermenter digestate	Reduction of the gas storage capacity in the top of the fermenter Fermenter can be operated only at reduced loading Gas pipe way get clogged
	Short circuiting during the flow of substrate	Reduces biogas yield Incomplete degradation of the substrate
	Long hydraulic retention time	Large reactor volumes are needed thereby adversely effecting process economics Low specific methane productivity High energy input per tonne of substrate for heating and mixing
	Formation of biogenic heat by mono-fermentation of energy crops	Stable mesophilic temperature conditions cannot be achieved Process failure occurs due to the reduced microbial activity above 42°C
	Open digestate storage tanks	Uncontrolled methane emissions occur
	Biogas upgrading	Insufficient biological desulphurization
Entry of surplus air to the fermenter for biological desulphurization		Reduction of the ignitability of the gas due to the resultant lowering of the CH ₄ content of biogas
Incomplete drying of biogas		The moisture content poses problems in: The transportation of biogas In the measuring devices in the gas main In the functioning of the CHP
Sizing of equipment	Luck of reliable data on the biogas yield of energy crops	Insufficient adaptation of fermenter and CHP-capacity which result in: Reduced electrical efficiency of CHP Increased pollutant emission from CHP Intermittent operation of CHP
	Luck of reliable data on the degradation capacity of the H ₂ S oxidizing bacteria	The efficiency of H ₂ S reduction cannot be estimated properly resulting in over sized or undersized installations

An illustrative list, giving country-wise distribution of anaerobic digestion-based MSW treatment facilities of capacity $\geq 2,500$ tonnes per year is shown in Table 7.3. As new plants are being planned, licensed, and commissioned, these figures are changing with time but they do provide an overall picture of the regions and the countries where application of anaerobic digestion for MSW treatment is being vigorously pursued. It is clear that European Union (EU) leads the field and the presence of developing countries is highly muted. An overview of the EU situation, culled mainly from De Baere and Mattheeuws (2010), is presented below.

Table 7.3 Anaerobic digestion plants with capacity of 2,500 tonnes per year or larger in operation across the world (adopted from IEA 2008)

Country	Feedstock	Number of plants ^a
Austria	Organic industrial waste, unspecified biowaste	23
Belgium	Unspecified biowaste	4
Canada	Unspecified biowaste	1
Caribbean	Unspecified biowaste	1
China	Unspecified biowaste	2
Korea	Unspecified biowaste	2
Denmark	Unspecified biowaste	22
Estonia	Unspecified biowaste	1
Finland	Unspecified biowaste	4
France	Unspecified biowaste	7
Germany	Fat-scrubber, fish waste, manure, organic industrial waste, sewage, municipal solid waste, paper, sludge, catering waste, food waste, greywaste, corn, ley crop, unspecified biowaste	85
Italy	Manure, organic industrial waste	12
Japan	Manure, organic industrial waste, rye, municipal solid waste	9
Jordan	Municipal solid waste	1
Malta	Municipal solid waste	1
Netherlands	Municipal solid waste	6
Polen	Municipal solid waste	3
Portugal	Municipal solid waste	2
Scotland	Municipal solid waste	1
Spain	Municipal solid waste, septic sludge, food industry waste, organic industrial waste, unspecified biowaste	17
Sweden	Municipal solid waste, septic sludge, organic industrial waste, sewage, slaughterhouse waste, manure, whey, unspecified biowaste	14
Switzerland	Catering waste, manure, organic industrial waste, unspecified biowaste	15
UK	Catering waste, manure	3
Ukraine	Catering waste, manure	1
USA	Catering waste, manure, slaughterhouse waste, vegetable waste	5
Total		242

^aThe capacity adds up to 12 million tonnes per year; substantial extra capacity also exists by way of plants of capacity lesser than 2,500 tonnes per year

7.5.2 Anaerobic Digestion of MSW in Europe

7.5.2.1 The Evolution of MSW-AD During 1990–2010

Use of anaerobic digestion (AD) for treating MSW and other solid biowaste gained momentum in Europe during the beginning of the 1990s. Since then the pace of growth, especially in the first decade of the twenty-first century has been quite brisk.

Table 7.4 Pattern of digester capacity and size across 5-year spans in the European Union (EU)

5-year span	1991–1995	1996–2000	2001–2005	2006–2010
Number of plants installed	15	44	52	73
Plants/year	3	8.8	10.4	14.6
Total capacity installed	194,000	1,117,500	2,077,950	2,246,450
Total capacity installed/year	38,800	223,500	415,590	449,290
Average size of plant	12,933	25,398	39,961	30,773

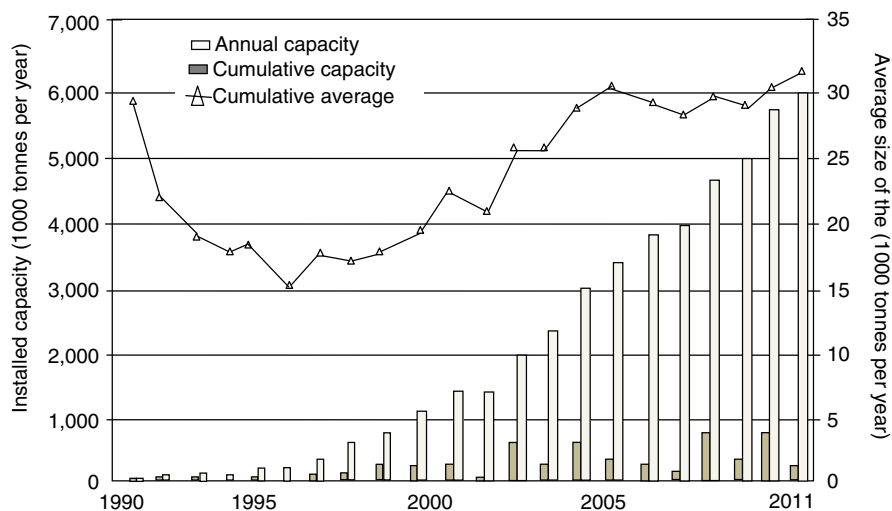
**Fig. 7.7** Evolution of installed capacity (adopted from De Baere and Mattheeuws 2010)

More than 120 plants treating biowaste or MSW have been installed during 2001–2010 in Europe, in contrast to half that number installed during the previous decade. The present installed capacity (of 200 plants in 17 countries) adds upto six million tonnes per year (MTY).

Table 7.4 reveals that the installation of MSW-AD plants received a quantum jump between 1991–1995 and 1996–2000. There has again been a quantum jump during 2006–2010. The manner in which cumulative AD capacity and the cumulative *average* plant capacity has changed over time is reflected in Fig. 7.7. The pattern has been governed by the fact that initially, in the 1990s, smaller plants were built as the technology was not fully matured and AD plants were mainly constructed for digestion of the biowaste portion of the MSW (source-separated organics). Subsequently, more and more mixed waste AD plants were constructed in the first 5 years of 2000; these plants usually handle 0.1–0.2 MTY, of which 30 to 70% is treated by AD.

From 2005 onwards, even as larger number of plants were built, the successful introduction of partial stream digestion also occurred during this period. It reduced the average size of the plants constructed because in partial stream digestion only a

Table 7.5 Mesophilic and thermophilic anaerobic digestion plants installed in EU in the preceding four 5-year spans

5-year period	1991–1995	1996–2000	2001–2005	2006–2010
Mesophilic installed	123,500	717,500	1,655,950	14,187,000
Thermophilic installed	70,500	400,000	422,000	827,750
% Mesophilic	64	64	80	63
% Thermophilic	36	36	20	37

part of the substrates on a site are sent to AD. The remaining portion is made to bypass the digester plant and is mixed with the digested residue for composting. Partial stream digestion is being increasingly used at existing composting sites that want to extend their capacity by adding AD on the front end of their facility. At these sites only the wetter substrates are sent to the ADs while the drier substrates are sent directly for composting. Due to this reason the AD capacity of some of the partial stream plants is smaller even though the quantities of the MSW handled, overall, have increased.

In countries like the UK and France, where source separation of household waste is less actively encouraged, large MSW-based AD plants are more common. In contrast, Switzerland, Austria, Sweden, and Norway tend to install smaller AD units (8,000–15,000 tonnes per year), while countries like Germany, Belgium, and Italy install plants with a medium average size (30,000–50,000 tonnes per year).

Germany is the leader in anaerobic digestion capacity in absolute figures with over 1.7 MTY of installed capacity. Spain is second (1.5 MTY), followed by France (0.8 MTY). However, on a per person basis, smaller countries Malta and Luxemburg, which have very few inhabitants, lead the field followed by Spain (with a capacity of 34,000 tonnes per million inhabitants), Switzerland (33,000 tonnes per million inhabitants), and the Netherlands (29,000 tonnes per million inhabitants).

7.5.2.2 Types of Processes and Substrates used

Mesophilic vs. thermophilic digestion: As may be seen from Table 7.5, about a third of all plants have been operated in the thermophilic range, while mesophilic plants dominate the field as they are believed to consume less energy and are more stable.

Wet vs. dry digestion: Dry digestion is most commonly defined as the process which uses more than 15% TS inside the reactor. In Europe, dry digestion has almost always been predominant, excluding the 2005–2006 periods (Fig. 7.8). During the last 5 years, 63% of the installed capacity has been of dry digestion plants and it currently provides almost 60% of the total capacity while wet fermentation is used in about 40% of the total installed capacity. This steady increase in dry digestion over the past 5 years is due to increasing use of partial stream digestion (mentioned in the preceding section) and by the development of increasingly more efficient dry fermentation systems.

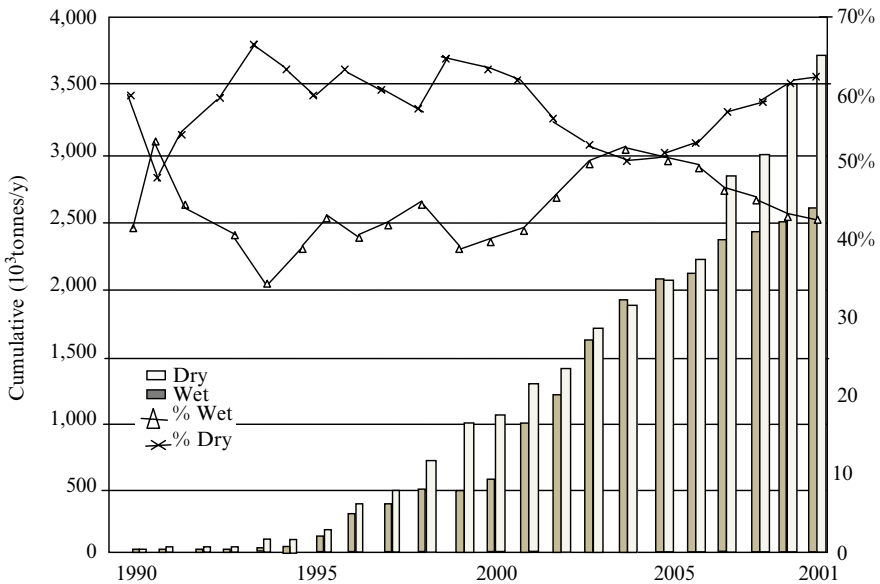

Fig. 7.8 Wet vs. dry digestion (adopted from De Baere and Mattheeuws 2010)

One-phase vs. two-phase digestion: In the 1990s the market share (cumulative installed capacity) of two-phase digesters was 30–40% but it has declined to less than 8% by the end of 2010. During the last 5 years only 5% of the installed capacity has been of two-phase digestion. The reasons are twofold. First, the advantages of phase separation do not measure up to extra costs that are involved and, second, advancements in single-phase dry digestion technology are making the later increasingly more efficient.

Single feedstock vs. co-digestion: Many farm-scale digesters in Europe co-digest manure together with agricultural or industrial biowastes. But in MSW system, co-digestion is an exception. A few facilitates (about 8%) that do accept other substrates, take only a small proportion (e.g., some byproducts of a nearby food processor or industrial facility with an organic waste stream).

Residual/mixed waste vs. biowaste: In the beginning of the 1990s, there was hardly any source separation of MSW, and most AD plants in that period perforce treated mixed waste. When source segregation became popular, most new AD plants were designed to treat only the biowaste portion of the MSW. As a result, the installed capacity for biowaste increased very quickly at the end of the 1990s. Nevertheless, there are many regions where source-separated collection is not common; when these countries (such as Spain and France) provide incentives for AD, mainly mixed waste plants are installed. By now, there is almost as much installed capacity for mixed MSW as there is for the biowaste fraction of the MSW.

7.5.2.3 The Shape of Things to Come

Due to the unique ability of AD to treat MSW with concomitant methane capture, many countries and existing composting facilities are considering (or already implementing) use of anaerobic digestion on the front-end of MSW treatment facilities or for partial stream digestion. Aerobic composting plants are being increasingly replaced by AD plants. Besides energy production (and the related revenue generation), AD enables odour management and better hygiene. Other benefits are avoidance of water addition (to compost), increase in total treatment capacity, and the flexibility and potential this combination offers in terms of biological waste treatment.

The technology is continuing to improve and mature, and many large-scale plants have been operating reliably for over 15 years. Higher efficiencies in the generation of electricity by gas engines, as well as improved gas separation technologies, are expected to render the biogas produced from these plants more and more valuable. Moreover, increasing concerns over greenhouse gas emissions and the thrust towards renewable energy is likely to enhance state support to AD which is expected to make AD exceedingly attractive.

7.5.3 Anaerobic Digestion Systems for Treating MSW

7.5.3.1 Single-Stage Wet Systems

The evolution of AD systems for MSW treatment began with the adaptation of wastewater-based AD technology to MSW.

The Waasa System

The Waasa system, built in 1989 in the city of Waasa, Finland, is one of the first large-scale MSW digesters. There are over ten operational Waasa plants in Europe, of which the largest plant is located in Groningen, Netherlands, where 42,740 m³ tanks treat 92,000 million tonnes per year (MTY) of the organic fraction of MSW out of an initial 250,000 MTY of raw MSW.

The Waasa system (Fig. 7.9) consists of a vertical pulper that homogenizes the incoming MSW and removes floating debris from the surface and sunken grit from the bottom of the pulper. Density-fractionated MSW is then pumped to the pre-chamber of a continuously stirred tank reactor. The pre-chamber helps alleviate short circuiting and an inoculation loop ensures that incoming waste is exposed to micro-organisms in order to minimize acid build-up.

This system produces 100–150 m³ of biogas per tonne of wet source-separated waste, achieving a weight reduction of 50–60%. The relatively high biogas yield indicates high digestibility of the feedstock and good conversion efficiency in the digester.

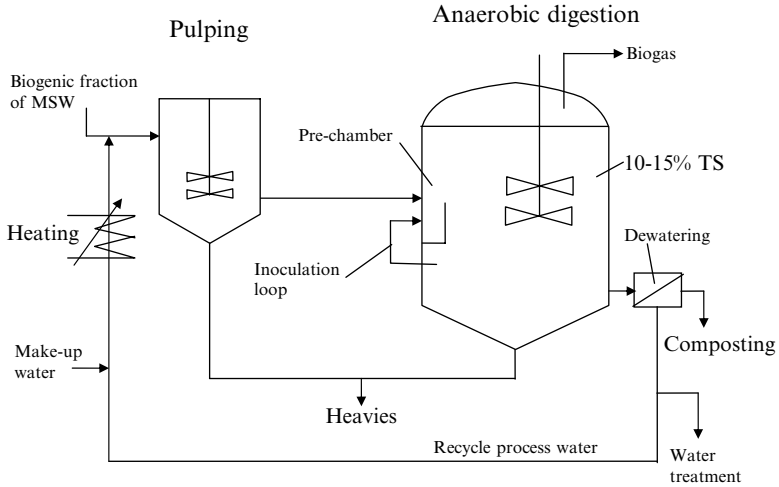

Fig. 7.9 Schematics of the Waasa anaerobic digestion process (adopted from Lissens et al. 2001)



Fig. 7.10 A BIMA digester processing 11,000 tonnes per year of municipal sewage sludge at Tamsweg, Austria (photo courtesy: Entec biogas)

One system, built by Entec Biogas GmbH in Kogel, Germany, which mirrors the Waasa digester is treating food and restaurant waste in 22,600 m³ constantly stirred tank reactors. A 110,000 tonnes per year municipal sewage sludge digestion plant is operational at Tamsweg, Austria, (Fig. 7.10). A 150,000 MTY version of the system was installed in Lucknow, India, in 2004 but is currently not operational due to problems associated with the supply of feedstock (MNRE 2011).

7.5.3.2 Single-Stage Dry Systems

“Dry” or “high solid” systems, which consist of feed with TS content of 15% or higher, employ special devices to enable smooth introduction of feed into the digester (Figs. 7.11–7.13).

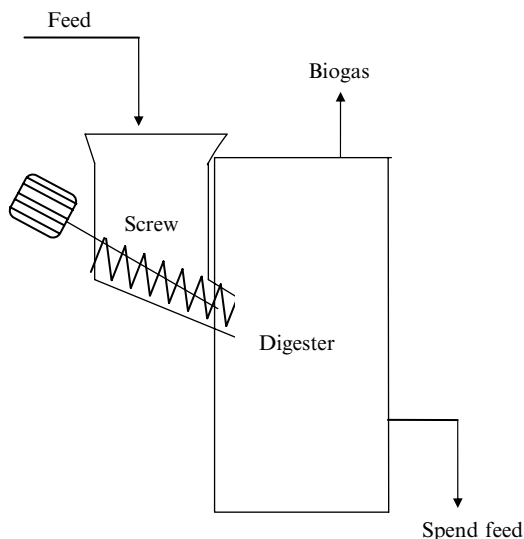

Fig. 7.11 Screw-based feeding in a solid-feed digester (adopted from Weiland 2005b)

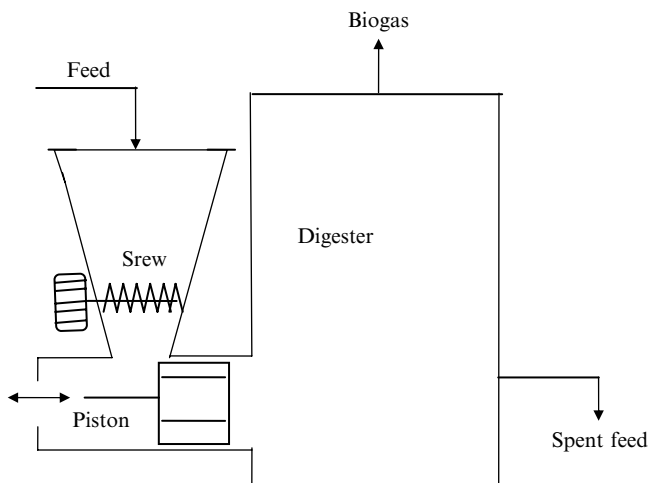
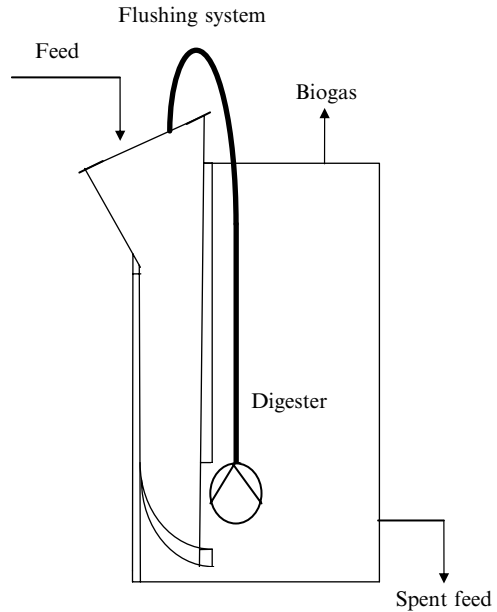

Fig. 7.12 Piston-and-screw system used feeding high-solids or “dry” anaerobic digester (adopted from Weiland 2005b)

Fig. 7.13 A “high solids” or “dry” digester with a flushing system (adopted from Weiland 2005b)



The Dranco Process

Developed in the late 1980s, it is a high-solids, single-stage AD system that normally operates at thermophilic temperatures. Feed is introduced into the top of the reactor and moves downward to the conical bottom where an auger removes the digestate (Fig. 7.14). A fraction of the digestate is transferred to the mixing pump where it is blended with fresh feed to inoculate the material and steam to bring the feed to the working temperature. The rest of the digestate is dewatered to produce process water and press cake. There is no mixing within the reactor, other than that brought about by the downward, plug-flow, movement of the waste and some biogas that moves upwards.

The steps associated with a typical Dranco process, of which steps (i), (ii), and (v) are also associated with most other processes, are

1. The organic fraction is reduced in size to ≤ 40 mm. To achieve this, large components such as plastics and textiles are screened off or reduced in size by means of a shredder. Ferrous and non-ferrous metals are recovered for the purpose of recycling. Stones, glass and hard plastics are removed as much as possible, but efficiencies of 50–80% or even less are sufficient in most cases.
2. The pretreated organic fraction of size ≤ 40 mm is subsequently mixed with a large amount of digested residue coming from the digester. The mixing ratio is usually 1 (feedstock) to 6–8 (digested residue). This takes place in the mixing

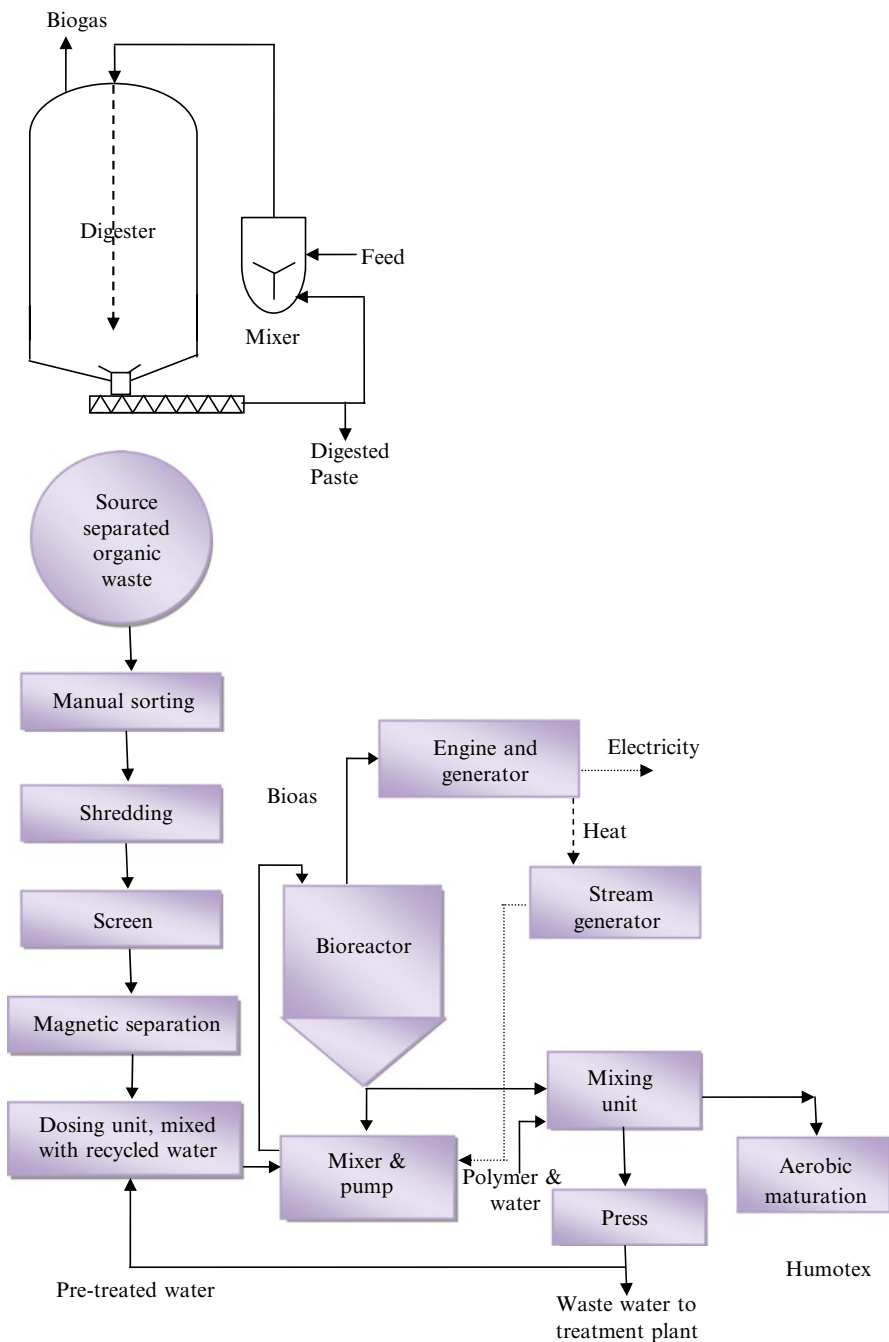

Fig. 7.14 The Dranco process – basic unit (*top*) and a typical flow-sheet of an MSW-based Dranco process

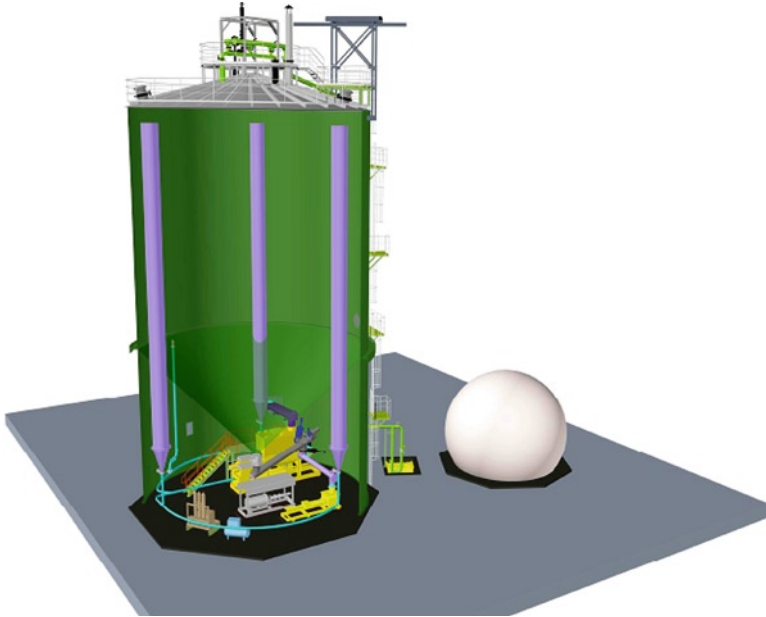

Fig. 7.15 Sectional view of a Dranco digester showing internal feeding tubes and the feeding pump under the digestion tank (photo courtesy: Organic waste systems n.v.)

part of the feeding pump. A small amount of steam is added to the mixture in order to raise the temperature to 35–40°C for mesophilic operation and to 50–55°C for thermophilic operation.

3. The preheated mixture is then pumped to the top of the digester through feeding tubes. These feeding tubes cut through the cone in the bottom of the digester and reach to about a 1 m distance from the roof inside the digester (Fig. 7.15). The material is pushed out of the feeding pipes and flows into the upper part of the digesting mass in the digester. A view of a full-scale Dranco plant is presented in Fig. 7.16.
4. Once the material enters into the main body of the digester, it takes about 2–4 days depending on the feeding rate to reach the bottom of the digester. The digesting mass descends through the digester by gravity only. No mixing equipment or gas injection is needed in the inner part of the digester. Biogas rises and exits the digester through the roof and flows towards the gas storage and treatment.
5. The digested residue is extracted from the bottom of the digester by means of screws hanging underneath the conical outlet. The largest part of the extracted material is recycled in the process and screwed to the mixing part of the pump for mixing it with the fresh incoming feedstock. The remaining part is deviated towards further treatment.

The press cake contains active bacteria, some ammonia and undigested solids and must be aerobically stabilized for use as agricultural compost.

At present 23 plants of this design are functioning in the world (Table 7.6).



Fig. 7.16 A DRANCO plant at Münster (Germany) which treats 24,000 tonnes per year, of MSW (photo courtesy: Organic waste systems n.v.)

Table 7.6 “Dry” MSW-based AD plants based on Dranco technology

Country	Capacity (1,000 tonnes per year)	Indicative biogas yield (nm ³ t ⁻¹ of MSW)	Year of commissioning
Portugal	50	100–200	2011 ^a
France	15 and 90	100–200	2011 ^a
Holland	50	100–200	2011 ^a
Poland	50	100–200	2011 ^a
Seoul	30	100–200	2010
Germany	18	100–200	2009
Belgium	39	100–200	2009
Spain	30	100–200	2008
Japan	3	100–200	2007
Spain	120	100–200	2006
Spain	25	100–200	2006
Germany	24	100–200	2005
Germany	38	100–200	2005
Korea	70	100–200	2005
Germany	30	100–200	2004
Italy	40	100–200	2003
Belgium	50	120	2000
Switzerland	10	100–200	1999
Germany	20	100–200	1999
Switzerland	11	100–200	1998
Germany	13.5	137	1997

(continued)

Table 7.6 (continued)

Country	Capacity (1,000 tonnes per year)	Indicative biogas yield (nm ³ t ⁻¹ of MSW)	Year of commissioning
Austria	20	135	1993
Belgium	20	100–200	1992
Total	866.5		

^aExpected

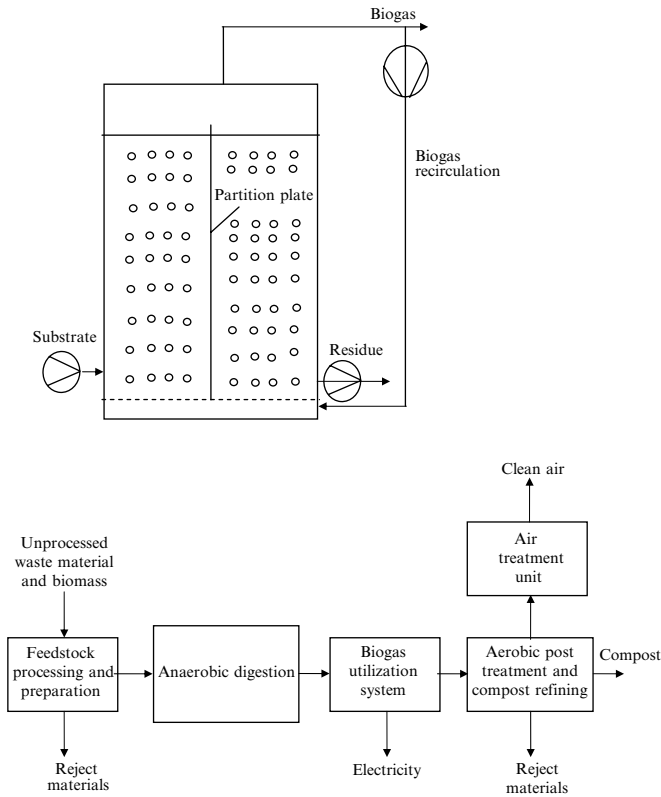

Fig. 7.17 Schematic of a Valorga digester (top) and a typical process flow-sheet

The Valorga Process

The Valorga process is capable of handling the biowaste (organic) portion of MSW at 25–30% solid content. Mesophilic or thermophilic systems are used depending on the MSW composition and economics (Rapport et al. 2008). The system employs a continuously operated single-stage plug-flow reactor. Whereas conventional plug-flow reactors involve only natural mixing, the Valorga digester uses pressurized biogas for mixing. This purportedly eliminates the need for an inoculation loop. The reactor consists of a vertical outer cylinder with an inner wall extending to about two-third of the diameter of the tank (Fig. 7.17).

Table 7.7 AD plants based on Valorga design presently in operation

Location	Capacity (1,000 tonnes per year)	Biogas production ($\text{nm}^3 \text{t}^{-1}$ of MSW)	Year of commissioning
France	100.2	140	2013 ^a
France	412	130–140	2013 ^a
France	140	106	2011 ^a
France	85	130–140	2010
Portugal	200	130–140	2010
Portugal	35	130	2009
France	97	140–160	2008
France	497.6	162	2008
China	105	116	2008
China	268.5	100	2008
Spain	195.2	130	2008
Spain	95	120	2008
Spain	110	127	2008
France	28	110–120	2007
Germany	100	190–200	2005
Spain	240	114	2004
Italy	55.4	129	2003
France	100	154	2002
Belgium	58.7	110–120	2000
Spain	182	130–150	2001
Switzerland	10	110–120	2000
Germany	36	110–120	1999
Germany	35	100–110	1998
Netherlands	52	80–85	1994
France	85	140–160	1988
Total	3322.6		

^aExpected

The material enters at the bottom on one side of the inner wall and flows around the wall before it exits. The retention time is of the order of three weeks. Biogas is injected in the base of the reactor and the bubbles serve as a means for mixing and keeping solids suspended. The digestate is dewatered and composted.

Presently 25 plants based on this technology are in operation (Table 7.7).

The Kompogas Process

In this process a horizontal plug flow digester (Fig. 7.18) with internal rotors is employed to assist in degassing and homogenizing the waste (Lissens et al. 2001). The system is prefabricated at two scales to handle 15,000 or 25,000 MTY. Larger capacities can be acquired by combining the modules. The internal solids concentration has to be carefully maintained in order for the system to flow

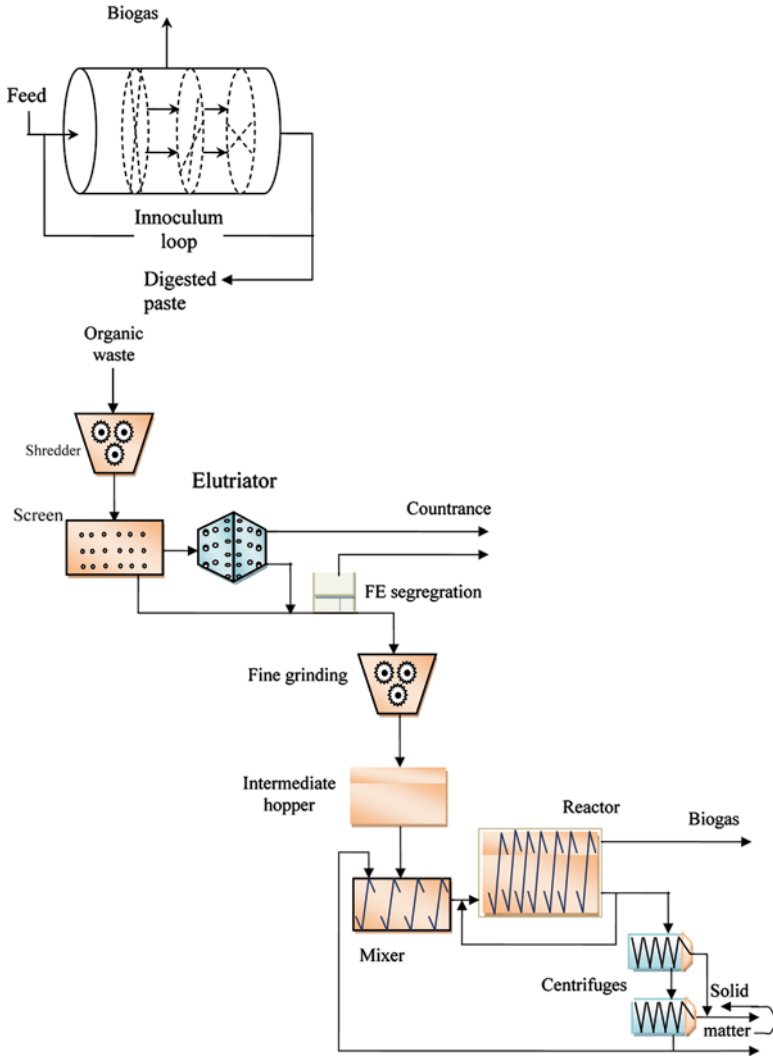

Fig. 7.18 Schematic of a Kompogas digester (top) and a typical process flow-sheet

properly; therefore, some of the process water and/or digestate is mixed with incoming waste. This also ensures that incoming feed is inoculated in order to prevent excessive acid build-up near the front end of the digester.

A much larger number of Kompogas plants are in operations (Table 7.8) than of Dranco or Valorga designs but the average capacity of these plants is much lesser than of the other two designs.

Table 7.8 Kompogas AD systems in operation

Country	Capacity (1,000 tonnes per year)	Indicative biogas yield ($\text{nm}^3 \text{ t}^{-1}$ of MSW)	Year of commissioning
Germany	18.5	100–110	2010
Switzerland	70	100–110	2009
Germany	45	100–110	2008
Germany	40	100–110	2008
France	100	100–110	2008
Spain	54	100–110	2008
Germany	24	100–110	2007
Germany	18.5	100–110	2007
Germany	18.5	100–110	2007
Germany	18.5	100–110	2007
Switzerland	12	100–110	2007
Switzerland	4	100–110	2006
Switzerland	16	100–110	2006
Switzerland	12	100–110	2006
Switzerland	15.5	100–110	2006
Caribbean	20	100–110	2005
Spain	75	100–110	2005
Switzerland	5	100–110	2005
Germany	39	100–110	2004
Japan	20	100–110	2004
Germany	12.5	100–110	2003
Switzerland	12.5	100–110	2003
Switzerland	10	100–110	2001
Austria	10	100–110	2001
Switzerland	5	100–110	2000
Switzerland	5	100–110	2000
Germany	20	100–110	1999
Germany	26	100–110	1999
Japan	1	100–110	1999
Switzerland	13	100–110	1998
Austria	10	100–110	1997
Germany	10	100–110	1997
Germany	27	100–110	1997
Germany	27	100–110	1997
Switzerland	12	100–110	1996
Germany	10	100–110	1996
Switzerland	10	100–110	1995
Switzerland	10	100–110	1994
Switzerland	8.5	100–110	1992
Switzerland	0.5	100–110	1989
Total	865.5		

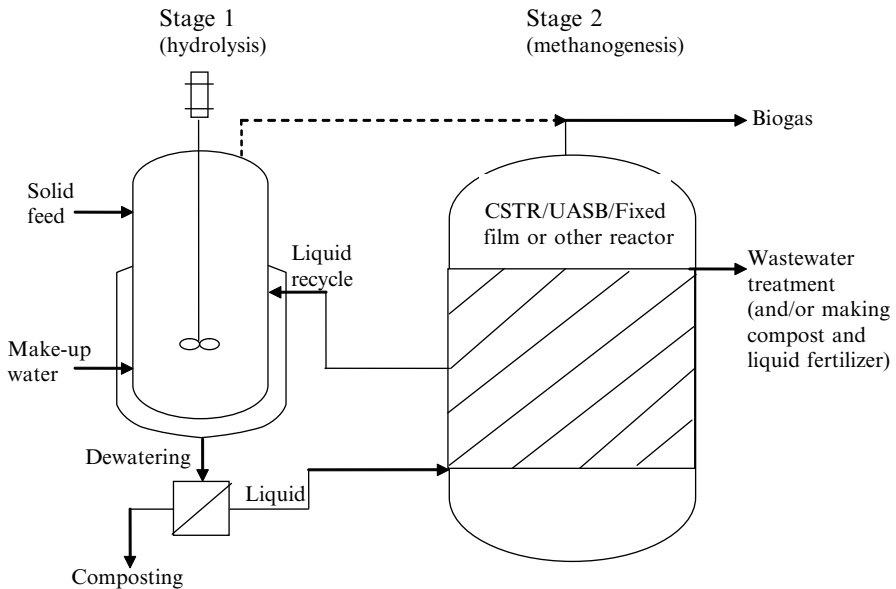

Fig. 7.19 Schematic of a typical two-stage anaerobic digestion system

7.5.3.3 Multi-stage Systems

Figure 7.19 depicts a generic two-stage AD system. The first stage focuses on the hydrolysis of a high-solids feed and the second stage comprises of methanogenesis occurring at lower-solids level; this scheme is called “dry-wet configuration”. In other systems, such as the Scharting-Uhde process, both stages are low-solids and are generally referred as “wet-wet configuration” (Vandevivere et al. 2002).

There are fewer commercial, multi-stage, AD units than single-stage ones. As explained earlier even as multi-stage systems enable higher loading rates, improved process stability, and flexibility, the added complexity and expense of building and operating commercial multi-stage systems have so far outweighed the yield and rate enhancements. Nonetheless, the potential of multi-stage digesters to improve performance has prompted much research, and a few notable commercial multi-stage digesters have been successful, too.

The BTA Process of Biotechnische Abfallverwertung GmbH

This process of Biotechnische Abfallverwertung GmbH is one of the oldest and the most successful in terms of the number of existing operational digesters. Although small units are single-stage, the majority of the BTA digesters are large (>100,000 MTY), multi-stage, wet-wet units (Rapport et al. 2008).

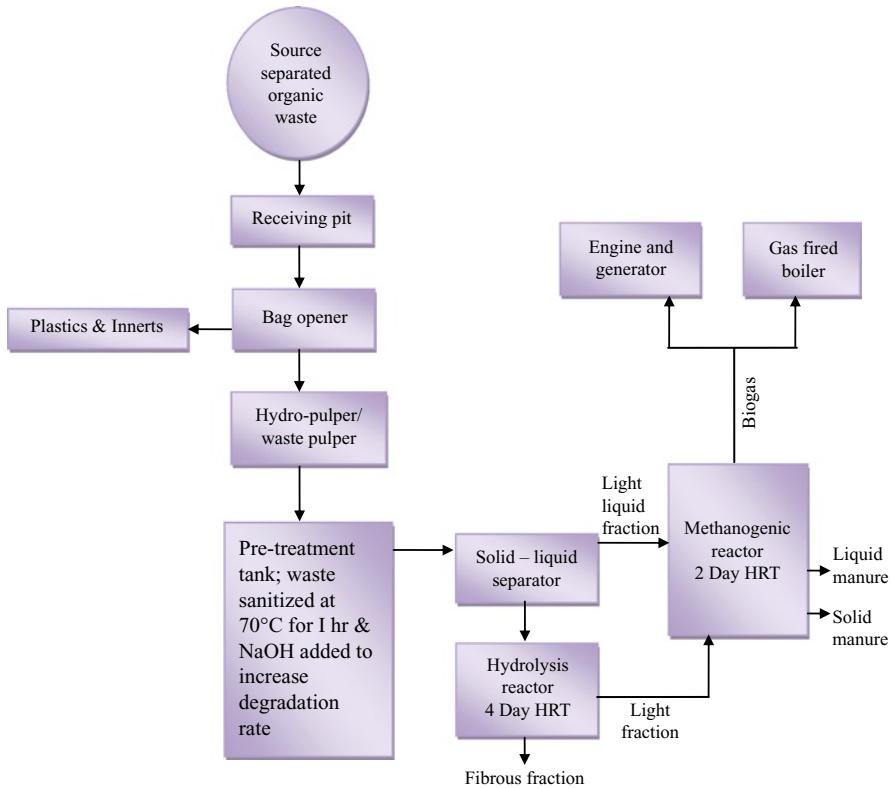

Fig. 7.20 The BTA process (Denmark)

The system utilizes a pulper and hydrocyclone much like those employed by the Waasa single-stage digester (Sect. 7.5.3.1). Pulped and density-fractionated MSW passes through a solid/liquid separation unit and the leachate is passed directly to a methanogenesis reactor (Fig. 7.20). Solid extract is mixed with process water and then pumped into a hydrolysis reactor with a residence time of 4 days. Hydrolysis leachate is then transferred into the methanogenesis reactor which has an HRT of 2 days. Dewatered digestate is then either treated aerobically or directly disposed. Installations with a designed capacity of less than 100,000 MTY often utilize the pulper as the hydrolysis tank, eliminating one of the steps in the process.

The Linde-KCA-Dresden GmbH Process

Linde-KCA has built wet and dry digesters since 1985 (Williams 2005) and currently has eight digesters operating in Germany, Portugal, Spain, and Luxembourg. These include wet and dry, mesophilic, and thermophilic systems. The typical dry

digester is operated in two stages (Fig. 7.21). The first stage is aerobic and the hydrolysis product is transported via conveyor to a horizontal plug-flow digester with internal rotors for mixing and transporting solids to the dewatering unit. Although this is a two-stage system, the first stage could also be considered an aerobic pre-treatment stage apart from the anaerobic digester since it is not anaerobic. The digester is capable of handling 15–45% solids.

7.5.3.4 Overview of Processes on Which Commercial AD Plants are Currently Based for Treating Solid Wastes

The status is summarized in Table 7.9

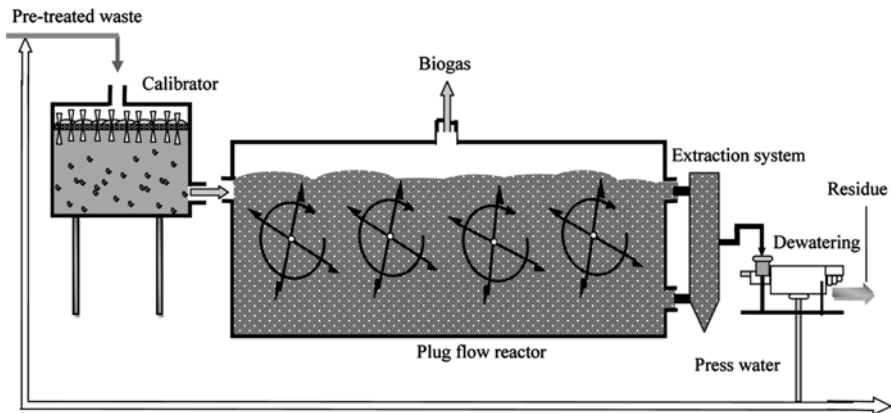

Fig. 7.21 The Linde-KCA two-stage dry digester (adopted from STRABAG 2011)

Table 7.9 Commercial AD processes which handle MSW, kitchen waste, food waste, yard waste, or green waste (adopted from Rapport et al. 2008 and Nichols 2004)

Process system name	Indicative number of plants	Capacity range (MTY)	No. of stages		Total solids content of the feed		Operating temperature	
			1	2	<20%	>20%	Mesophilic	Thermophilic
AAT	8	3,000 to 55,000	✓		✓		✓	
ArrowBio	4	90,000 to 180,000		✓	✓		✓	
BTA	37	1,000 to 150,000	✓	✓	✓		✓	✓
Biocel	1	35,000	✓			✓	✓	
Biopercolat	1	100,000		✓		✓	✓	
Biostab	13	10,000 to 90,000	✓		✓			✓
DBA-wabio	4	6,000 to 60,000	✓				✓	

(continued)

Table 7.9 (continued)

Process system name	Indicative number of plants	Capacity range (MTY)	No. of stages		Total solids content of the feed		Operating temperature	
			1	2	<20%	>20%	Mesophilic	Thermophilic
DRANCO	24	3,000 to 120,000	✓	✓	✓			✓
Entec	17	40,000 to 150,000	✓				✓	✓
Haase	4	50,000 to 200,000		✓	✓		✓	✓
Kompogas	40	1,000 to 110,000	✓			✓		✓
Linde-KCA/ BRV	8	15,000 to 150,000	✓		✓	✓	✓	✓
Preseco	2	24,000 to 30,000		✓				
Schwarting– Uhde	3	25,000 to 87,600		✓	✓			✓
Valorga	25	10,000 to 270,000	✓			✓	✓	✓
Waasa	10+	3,000 to 230,000	✓		✓		✓	✓

An overview of six plants which have been in operation for 15 years or more is presented in Table 7.10. These include plants based on TBW and EcoTechnology processes (Figs. 7.22 and 7.23). The oldest of these units is at Brecht, Belgium (Fig. 7.24).

A summary of advantages and disadvantages of different processes, in terms of technical, biological, and economic attributes, is given in Table 7.11.

7.5.4 Economics of MSW Digestion

The cost–benefit ratio of MSW treatment systems based on anaerobic digestion depends on several factors, which vary from region to region and site to site:

- Energy prices
- Tax concessions, if any
- Land prices
- Labour costs
- Construction and material costs
- Markets for the compost/soil conditioning product and prices
- Quality of the compost produced

Over the years refinement of technology and economics of scale are leading to a reduction in overall treatment costs making anaerobic treatment systems increasingly more competitive. However, economics of scale means that only large systems have to be put up which process many thousands of tonnes of MSW per year to have a reasonable treatment cost per tonne.

Table 7.10 Illustrative examples of municipal solid waste (MSW) processing systems which employ anaerobic digestion (AD) as one of the unit process, and which are in operation since over a dozen years

Company, process and country	Substrate	Pre-treatment done before AD	Name of the AD process	Post-treatment	Digester volume (m ³)	Plant capacity (tonnes per year)	In operation since	Remarks
TBW biocomp process, Germany	Source-separated MSW	Fine organic fraction is separated from coarser organic fraction Coarser material is sent for aerobic decomposition by composting Fine fraction is pulped and mixed with liquid from digested sludge	Two-stage reactors Stage 1: (35°C) is mesophilic Stage 2: (55°C) – thermophilic- retention time is 2 weeks in each reactor	Solid part of sludge is mixed with matured compost	1,000 (for each reactor)	13,000	1996	Separation by hand and mechanical means is used to remove non-organic materials
EcoTechnology, Germany/ Finland	Source-separated household waste	Organic waste is separated from combustible materials (RDF) RDF is sent to fluidized bed boiler	Single stage Temperature 35°C Retention time 15–20 days	Slurry is pasteurized at 70°C for 30 min		5.0	6,500	1995
Rottaler model, Germany	Source-separated organic waste	Hand sorting Chopping	Multi-stage Stage 1 at 37°C for 7 days Stage 2 at 55°C, for 1–15 days	Liquid is pumped from the top, solids are removed from the bottom of the tank	540 (each reactor)	2,000	1994	Some plants of this also use co-digestion with animal manure

(continued)

Table 7.10 (continued)

Company, process and country	Substrate	Pre-treatment done before AD	Name of the AD process	Post-treatment	Digester volume (m ³)	Plant capacity (tonnes per year)	In operation since	Remarks
Anyang city, Korea	Food waste	Sorting	Multi-stage Stage 1: autogenesis Stage 2: methanogenesis		Stage 1: -15 Stage 2: -45	1,000	1993	
BTA, Denmark	Source-separated household waste only	Pulping Plastic removal Sanitization for 1 h at 70°C NaOH addition Material is separated into liquid and slurry; is hydrolyzed	Multi-stage, 38°C Liquid from separation and hydrolysis are digested in the reactor		2.4	20,000	1993	
Organic waste systems – DRANCO Belgium	Source-separated household waste only	Manually sorted Shredded Magnetic separation Mixed with water	Single stage Thermophilic (50–58°C) Retention time is 15 to 30 days	Sludge is dewatered and stabilized aerobically for 2 weeks	808	11,000 to 35,000	1992	

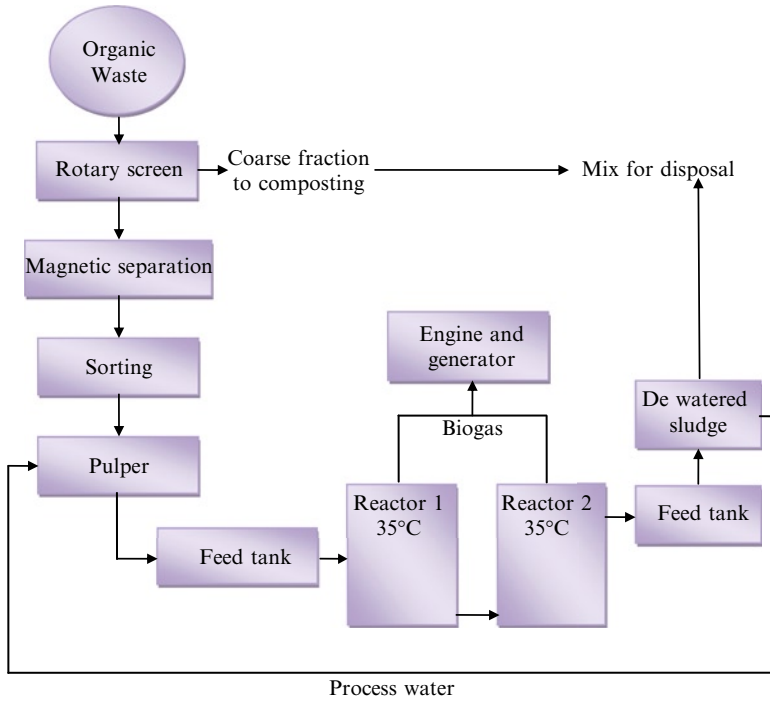

Fig. 7.22 TBW biocomp process (Germany)

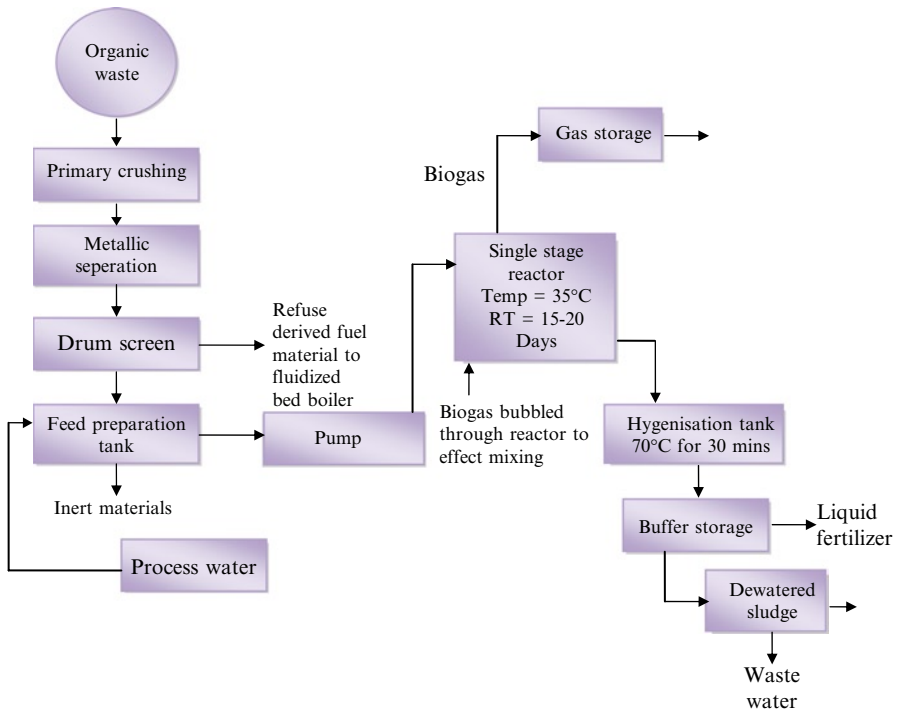

Fig. 7.23 Schematic of the MSW treatment process of EcoTechnology (Finland/Germany)



Fig. 7.24 Front (*top*) and back views of the DRANCO plant at Brecht (Belgium) treating non-recyclable wastepaper, cardboard, disposable diapers, etc., at 70,000 tonnes per year capacity since 1992 (photo courtesy: Organic waste systems n.v.)

Calculations made in Europe indicate that if a plant with a capacity of 100,000 tonnes per year has a treatment cost of less than €30 per tonne, another plant with a capacity of only 20,000 tonnes per year would have a treatment cost of around €60 per tonne.

Data on still smaller scale systems is not available but the treatment costs per tonne are expected to be much higher in smaller systems.

Table 7.11 Advantages and disadvantages associated with different processes

Aspects	Advantages	Disadvantages
<i>Single-stage, wet systems</i>		
Technical	These systems are based on well-developed wastewater treatment technology Material handling and mixing is well standardized	These systems are <ul style="list-style-type: none"> • Prone to short circuiting • Prone to sink and float phases • Prone to abrasion • They involved complicated pre-treatment
Biological	In these systems, the inhibitors get diluted	Inhibitors spread immediately in reactor Some volatile solids (VS) are lost during removal of inert fraction in pre-treatment
Economic and environmental	Material handling equipment dilute	Entail high consumption of water and heat; require larger tanks
<i>Single-stage, dry systems</i>		
Technical	These systems have moving parts inside the reactors Are robust (inert material and plastics need not be removed) No short circuiting occurs	Not appropriate for wet (TS < 5%) waste streams
Biological	Less VS is lost in pre-treatment Enable larger OLR (high biomass) There is limited dispersion of transient peak concentrations of inhibitors	There is lesser dilution of inhibitors with fresh water Inoculation loop needed to enhance contact between micro-organisms and substrate
Economic and environmental	Cheaper pre-treatment, smaller reactors Low water usage Less heat requirement	Require robust and expensive waste handling equipment
<i>Two-stage systems</i>		
Technical	Flexible in operation	Complex design and material handling
Biological	Higher loading rate is possible Can tolerate fluctuation in loading rate and feed composition	Can be difficult to achieve true separation of hydrolysis from methanogenesis
Economic and environmental	Have higher throughput, smaller footprint	Require larger capital investment
<i>Batch systems</i>		
Technical	Simplified material handling Less pre-sorting and treatment	Compaction prevents percolation and leachat recycling
Biological	Separation of hydrolysis and methanogenesis phases	Gas production is highly variable
Economic and environmental	Low cost Appropriate for landfills	Less complete degradation of organics

Notwithstanding the challenges still to be faced in improving the economics of BSW digestion, the quantities of biogas that is potentially obtainable from any and every type of BSW (Table 7.1) is so huge that the importance of this technology as a source of clean energy cannot be overemphasized. This is true in spite of several problems that are engaging attention (Table 7.2)

References

- Abbasi T, Abbasi SA (2010) Production of clean energy by anaerobic digestion of phytomass – new prospects for a global warming amelioration technology. *Renew Sustain Energy Rev* 14(6):1653–1659. doi:10.1016/j.rser.2010.03.003
- Abbasi SA, Nipanay PC (1984) Generation of biogas from *Salvinia molesta* (Mitchell) on a commercial biogas digester. *Environ Technol Lett* 5(2):75–80
- Abbasi S, Nipanay P (1986) Infestation by aquatic weeds of the fern genus *Salvinia*: Its status and control. *Environmental conservation* 13(3):235–242
- Abbasi SA, Nipanay PC (1993) Modelling and simulation of biogas systems economics. Ashish Publishing House, New Delhi
- Abbasi SA, Nipanay PC (1994) Potential of aquatic weed *Salvinia-Molesta* (Mitchell) for water-treatment and energy recovery. *Indian J Chem Technol* 1(4):204–213
- Abbasi SA, Ramasamy EV (1996) Utilization of biowaste solids by extracting volatile fatty acids with subsequent conversion to methane and manure. In: 12th International Conference on Solid Waste Technology and Management, Philadelphia, USA, p 8
- Balasubramanya RH, Khandeparkar VG, Betrabet SM, Sundaram V (1981) Production of biogas from willow-dust by a batch fermentation process. *J Text Assoc (India)* 42(4):145–149
- Bouallagui H, Touhami Y, Ben Cheikh R, Hamdi M (2005) Bioreactor performance in anaerobic digestion of fruit and vegetable wastes. *Process Biochem* 40(3–4):989–995
- De Baere L, Mattheeuws B (2010) Anaerobic digestion of MSW in Europe. *BioCycle* 51(2):24–26
- Entec biogas <http://www.entec-biogas.com/en/references/references.php>, Austria
- Gaddy JL, Clausen EC (1985) SERI Anaerobic Digestion Program 1984 Annual Report. Solar Energy Research Institute
- Gajalakshmi S, Abbasi SA (2004) Neem leaves as a source of fertilizer-cum-pesticide vermicompost. *Bioresour Technol* 92(3):291–296. doi:10.1016/j.biortech.2003.09.012
- Gajalakshmi S, Abbasi SA (2008) Solid waste management by composting: state of the art. *Crit Rev Environ Sci Technol* 38(5):311–400. doi:10.1080/10643380701413633
- Gajalakshmi S, Ramasamy EV, Abbasi SA (2001a) Assessment of sustainable vermicomposition of water hyacinth at different reactor efficiencies employing *Eudrilus eugeniae* Kinberg. *Bioresour Technol* 80(2):131–135. doi:10.1016/S0960-8524(01)00077-3
- Gajalakshmi S, Ramasamy EV, Abbasi SA (2001b) Potential of two epigeic and two anecic earth-worm species in vermicomposting of water hyacinth. *Bioresour Technol* 76(3):177–181. doi:10.1016/S0960-8524(00)00133-4
- Gajalakshmi S, Ramasamy EV, Abbasi SA (2002) High-rate composting-vermicomposting of water hyacinth (*Eichhornia crassipes*, Mart. Solms). *Bioresour Technol* 83(3):235–239. doi:10.1016/S0960-8524(01)00216-4
- Ghosh S (1984) Solid-phase methane fermentation of solid wastes. In: The eleventh American society of mechanical engineers national waste processing conference, Orlando, FL, pp 683–689
- Goebel RP (1983) High solids anaerobic digester for rural use. Final technical report. EnBio, Inc., Fairfield, CA (USA)
- IEA (2008) Operating anaerobic digestion plants of commercial scale. international energy agency. http://www.iea-biogas.net/_download/Plantlist_08.pdf. Accessed 4 May 2011

- Jewell WJ (1980) Anaerobic fermentation of agricultural residue, potential for improvement and implementation, vol 2. US Department of Energy, Springfield, VA
- Lissens G, Vandevivere P, De Baere L, Bley E, Verstraete W (2001) Solid waste digestors: process performance and practice for municipal solid waste digestion. *Water Sci Technol* 44(8):91–102
- Ministry of new and renewable energy (2011) Booklets on Renewable Energy. MNRE. <http://mnre.gov.in/re-booklets.htm>. Accessed 4 May 2011
- Nichols CE (2004) Overview of anaerobic digestion technologies in Europe. *BioCycle* 45(1):47–53
- OWS (organic waste system n.v.) www.ows.be/pages/index.php?menu=69&submenu=193&choose_lang=EN, Belgium
- Ramasamy E, Abbasi S (1999) Utilization of biowaste solids by extracting volatile fatty acids with subsequent conversion to methane and manure. *J Solid Waste Technol Manage* 26(3):133–139
- Ramasamy EV, Gajalakshmi S, Sanjeevi R, Jithesh MN, Abbasi SA (2004) Feasibility studies on the treatment of dairy wastewaters with upflow anaerobic sludge blanket reactors. *Bioresour Technol* 93(2):209–212. doi:10.1016/j.biortech.2003.11.001
- Rapport J, Zhang R, Jenkins BM, Williams RB (2008) Current anaerobic digestion technologies used for treatment of municipal organic solid waste. Contractor report to the California integrated waste management board. Department of Biological and Agricultural Engineering, University of California, Davis, CA
- Sankar Ganesh P, Ramasamy EV, Gajalakshmi S, Abbasi SA (2005) Extraction of volatile fatty acids (VFAs) from water hyacinth using inexpensive contraptions, and the use of the VFAs as feed supplement in conventional biogas digesters with concomitant final disposal of water hyacinth as vermicompost. *Biochem Eng J* 27(1):17–23
- Sankar Ganesh P, Sanjeevi R, Gajalakshmi S, Ramasamy EV, Abbasi SA (2008) Recovery of methane-rich gas from solid-feed anaerobic digestion of ipomoea (*Ipomoea carnea*). *Bioresour Technol* 99(4):812–818. doi:10.1016/j.biortech.2007.01.024
- Sankar Ganesh P, Gajalakshmi S, Abbasi S (2009) Vermicomposting of the leaf litter of acacia (*Acacia auriculiformis*): possible roles of reactor geometry, polyphenols, and lignin. *Bioresour Technol* 100(5):1819–1827
- Shyam M, Sharma PK (1994) Solid-state anaerobic digestion of cattle dung and agro-residues in small-capacity field digesters. *Bioresour Technol* 48(3):203–207. doi:10.1016/0960-8524(94)90147-3
- STRABAG (2011) Dry Digestion. STRABAG Umwelthanlagen GmbH former Linde-KCA Umwelthanlagen GmbH. [http://www.strabag-environmentaltechnology.com/databases/inter-net/_public/files.nsf/SearchView/598B098982D66FC9C12574C1004C2038/\\$File/3_4%20Troeknvergaerung_e%20d.pdf?OpenElement](http://www.strabag-environmentaltechnology.com/databases/inter-net/_public/files.nsf/SearchView/598B098982D66FC9C12574C1004C2038/$File/3_4%20Troeknvergaerung_e%20d.pdf?OpenElement). Accessed May 1 2011
- Vandevivere P, De Baere L, Verstraete W (2002) Types of anaerobic digesters for solid wastes. In: Matal-Alvarez J (ed) Biomethanization of the organic fraction of municipal solid wastes. IWA publishing company, Barcelona, pp 111–140
- Weiland P (2005a) Landwirtschaftliche vergärungsanlagen. In: Bischofsberger W, Dichtl N, Rosenwinkel KH, Seyfried CF, Böhnke B (eds) Anaerobtechnik, 2nd edn. Springer, Berlin, pp 533–564
- Weiland P (2005b) Results and bottle necks of energy crop digestion plants – required process technology innovations. Paper presented at the workshop on energy crops and biogas – pathways to success? Utrecht
- Williams RB (2005) UC Davis technology assessment for advanced biomass power generation. PIER Consultation Report. California Energy Commission, Sacramento, CA
- Wujcik WJ, Jewell WJ (1980) Dry anaerobic fermentation. *Biotechnol Bioeng Symp* 10(10):43–65
- Yadvika S, Sreerkrishnan TR, Kohli S, Rana V (2004) Enhancement of biogas production from solid substrates using different techniques – a review. *Bioresour Technol* 95(1):1–10

Chapter 8

Capture of Biogas from Landfills

Abstract Sanitary landfills begin releasing biogas within a few weeks of being laid out and continue to do so for several decades. It has been estimated that as much as 12% of the total global methane emission is contributed by sanitary landfills. Till recently sanitary landfills were predominantly located in developed countries but as developing countries also begin taking resort to sanitary landfills, the landfill-based methane emissions are expected to rise.

This chapter describes the manner in which sanitary landfills are laid out and the way in which biogas is generated therein. It then describes the methods with which landfill gas is captured and purified for use as an energy source. The environmental and safety issues related to landfill gas generation and capture have also been addressed.

8.1 Introduction

In the piles of municipal solid waste (MSW) dumped on land and in water – sights common in most developing countries (Figs. 8.1 and 8.2) – anaerobic conditions easily develop if the waste is rich in biodegradable organic matter. Even when huge piles of waste are dumped on dry land, anaerobic conditions may develop if any wastewater drain empties near the solid waste dump, or when it rains. Hence unplanned and insanitary disposal of MSW on land or in water is a potential source of methane though it may not always generate significant quantities of methane. On the other hand in sanitary landfills, in which MSW is systematically laid out in layers interspersed with layers of soil, with eventual “sealing” of landfill with a thick layer of compacted soil, anaerobic conditions soon develop and emission of methane persists for several decades.

In the MSW dumps there is movement of foraging animals (Fig. 8.3) and rag-pickers, the latter off-and-on set the piles on fire in order to make recovery of metallic components easier. Such happenings are certainly very unhealthy but they interfere with anaerobic digestion and serve the purpose of reducing methane emissions from such waste dumps.



Fig. 8.1 Indiscriminate dumping of solid waste (Puducherry, India)



Fig. 8.2 Solid waste dumped in a canal (Puducherry, India)



Fig. 8.3 A dog foraging near piles of solid waste

But sanitary landfills not only become copious producers of biogas (also called “landfill gas,” or LFG, to specify its landfill-based origin), but the production is also sustained for several decades. Hence biogas capture from landfill provides a means of reducing the contribution of biodegradable solid waste to global warming.

8.2 Landfill: Originated Methane Emissions

Methane from the MSW landfills represents over 12% of total global CH_4 emissions (USEPA 2006). It amounts to over 730 million metric tonnes of carbon dioxide equivalent (MtCO_2eq). The USA, Africa, Eastern Europe, and China together account for 42% of the world’s CH_4 emissions (Fig. 8.4). These emissions are expected to grow by 9% between 2005 and 2020. In this period, regulations may control and potentially reduce future growth in CH_4 emissions from landfills in developed countries. However, in other areas of the world such as India, Eastern Europe, and China more and more MSW will be landfilled, resulting in a steady growth in landfill CH_4 emissions.

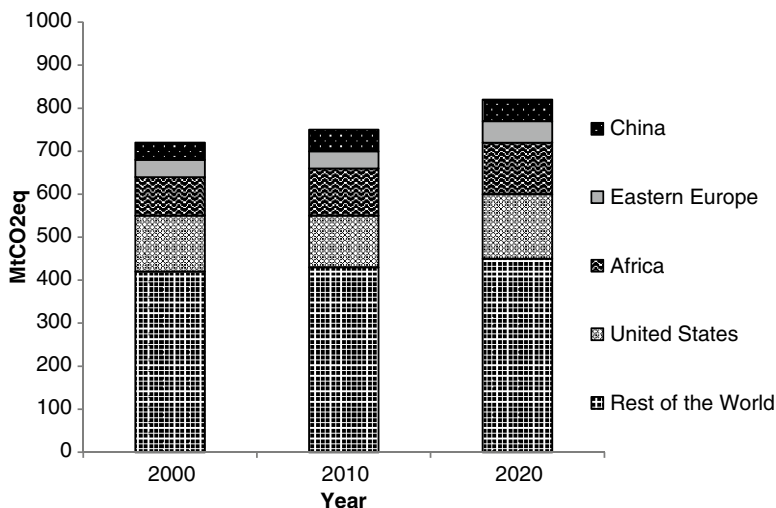

Fig. 8.4 Past and projected, emissions of CH₄ from landfills (adopted from USEPA 2006)

Table 8.1 Emissions of methane from landfills during 1990–2000 (MtCO₂eq) as estimated by USEPA (2006)

Country	1990	1995	2000
USA	172.2	162.4	130.7
China	40.4	42.6	44.6
Mexico	26.0	28.5	31.0
Canada	18.5	20.4	22.9
Russian federation	37.8	37.8	35.1
Saudi Arabia	12.5	14.4	16.8
India	10.7	12.2	13.9
Brazil	13.0	14.5	15.6
Ukraine	14.2	14.5	12.1
Poland	16.1	15.9	17.0
South Africa	14.1	15.2	16.3
Turkey	8.2	8.9	9.7
Israel	6.6	7.8	8.8
Australia	7.5	8.3	8.0
Congo	5.0	5.9	6.4
Rest of the world	358.7	360.4	341.6
World Total (rounded)	761	770	730

The production of biogas in landfills and the proportion of CH₄ in it depend on several factors, including waste composition, local climate, landfill design, and operating practices. Two factors that accelerate the rate of CH₄ generation within a landfill are an increased proportion of organic constituents (paper, kitchen waste, rags, etc.) in the mix of MSW being landfilled and increased levels of moisture in the waste.

It has been estimated (USEPA 2006) that global contributions to landfill methane emissions have slightly reduced over the 1990–2000 span (Table 8.1) mainly due to

Table 8.2 Emissions from landfills (MtCO₂eq) as per projections of USEPA (2006)

Country	2005	2010	2015	2020
USA	130.6	125.4	124.1	123.5
China	46.0	47.5	48.8	49.7
Mexico	33.3	35.5	37.4	39.2
Canada	25.3	27.7	30.7	33.6
Russian federation	34.2	33.2	32.2	31.1
Saudi Arabia	19.4	22.1	24.8	27.5
India	15.9	17.1	18.1	19.1
Brazil	16.6	17.5	18.3	19.0
Ukraine	13.4	14.7	16.4	18.0
Poland	17.0	17.0	17.0	17.0
South Africa	16.8	16.6	16.4	16.2
Turkey	10.4	11.0	11.6	12.1
Israel	9.7	10.6	11.3	11.9
Australia	8.7	9.4	10.6	11.9
Congo	7.4	8.6	9.8	11.2
Rest of the world	342.7	346.7	360.5	375.9
World Total (rounded)	747	761	788	817

Table 8.3 Physical composition of MSW in urban areas (Zhu et al. 2007); note the increased proportion of biodegradables

Type	1996 (% by weight)	2005 (% by weight)
Biodegradables	42.2	47.4
Paper	3.6	8.1
Plastic/rubber	0.6	9.2
Metal	0.5	0.5
Glass	0.6	1.0
Rags	–	4.5
Other	–	4.0
Inerts	45.1	25.1

the reduction in the contributions by USA, and in spite increase by most other countries. But it has been projected (USEPA 2006) that LFG emissions will rise, overall, by about 70 million metric tonnes of CO₂ equivalent by the year 2010 (Table 8.2). Apart from increasing quantities of waste which would be responsible for this increase, the increasing proportion of biodegradable fraction in the MSW (Table 8.3) may also be a likely cause.

8.3 How Are Sanitary Landfills Laid Out

Even though landfills are now acknowledged as major contributors to global warming, besides other risks they pose – of fires, explosion, toxicity. etc. (Sect. 8.5) – they continue to be set up primarily for want of better alternative, and secondly because of their simplicity and versatility. Landfills can handle waste of widely different shapes, sizes, or weights. Since they are constructed of soil, they are rarely affected

by the chemical composition of a particular waste component or by the possible incompatibility of different components. In comparison, other options of solid waste management, for example composting, incineration, and anaerobic digestion require uniformity in the form and chemical properties of the waste for efficient operation of the process.

About 70% of materials that are routinely disposed off in landfills are recyclable. More than 30% of bulk municipal garbage collection consists of paper that could be reused to make other paper products. Other materials like plastic, metal, and glass can also be reused in manufacturing. This can greatly reduce the amount of waste materials disposed in landfills, as well as preserving non-renewable raw materials. But recycling is not often cost-effective which is why a major fraction of potentially recyclable solid waste continues to be put in landfills.

8.3.1 Making of Sanitary Landfills

Landfilling involves three basic operations:

- Spreading the solid waste materials in layers.
- Compacting the wastes as much as possible.
- Covering the material with compacted soil at the end of each day.

This form of landfilling reduces the breeding of rats and insects at the landfill, reduces the threat of spontaneous fires, prevents uncontrolled settling of the materials, and uses the available land efficiently. Although this method does help control some of the pollution generated by the landfill, the fill dirt occupies up to 20% of the landfill space, thereby eating into the landfill's waste-holding capacity.

There are two methods commonly used to set up landfills: the "area method" and the "trench method".

8.3.1.1 Area Method

This method is used when the terrain is unsuitable for the excavation of trenches in which to place the waste. The waste is unloaded and spread in long, narrow, strips on the surface of the land in a series of layers that vary in depth from 16 to 30 in. Each layer is compacted with rollers and the next layer is put over it until the thickness reaches a height varying from 6 to 10 ft. At that time, and at the end of each day's operation, a layer of cover material is placed over the completed fill.

8.3.1.2 Trench Method

In this method, trenches are created by digging into the soil and the refuse is dumped into the trench, compacted, and covered with a layer of soil between 6 and 24 in.

Fig. 8.5 Section of a landfill trench showing layers of compacted refuse

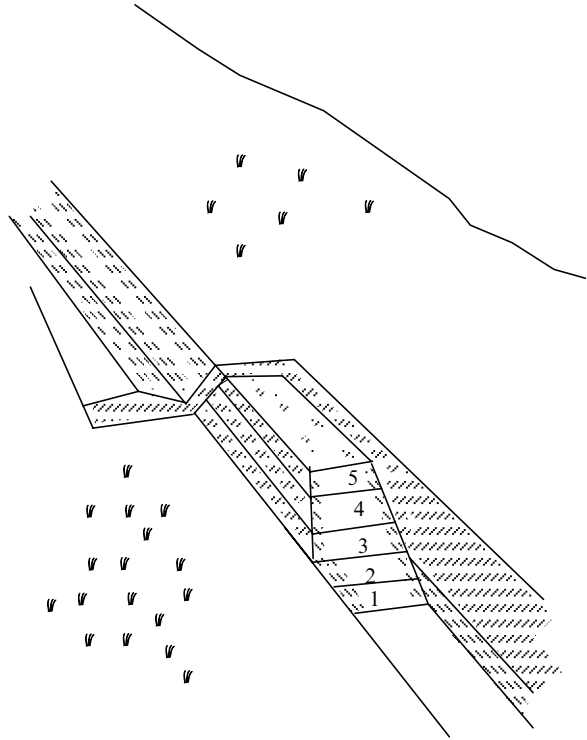

deep (Figs. 8.5 and 8.6). The earth which is dug out to make the trench is sometimes used to construct a ramp on the windward side of the trench, to minimize blowing of refuse. Between loads, the trash is compacted by a bulldozer. This reduces the volume of refuse to one-third or less of its original volume. The compacted trash is covered with a layer of dirt, which is compacted again. This procedure is repeated until alternate layers of compacted trash and dirt fill a section of the trench (Fig. 8.2). At the end of each day, when a section of trench has been filled with compacted refuse and graded, the top, side, and end of the section are covered with earth. Just enough cover on the working face or end is required each day to confine the refuse and to form a seal. The compacted refuse is sealed once a week or more often by covering the working face with about a foot of well-compacted earth. Sealing the refuse into cells controls fires and odours, and prevents rodents from reaching the refuse (Fig. 8.6).

Even as very large quantities of MSW can be disposed in landfills, they do not require a lot of manpower in their making or maintenance. Truck drivers, and a few men with bulldozers and dragline buckets are all that is needed to set up a landfill. No segregation of refuse is required. Most importantly landfills can accommodate large fluctuations in the daily accumulation of refuse without additional personnel or equipment.

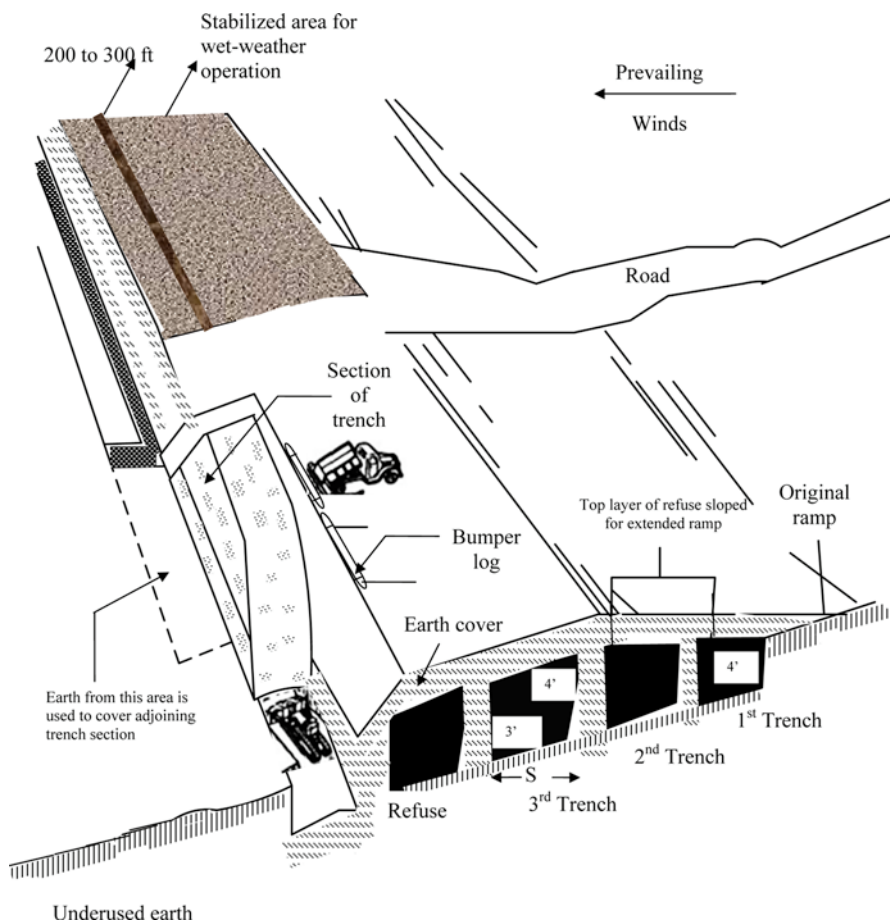

Fig. 8.6 Making of a sanitary landfill by trench method

8.3.2 Methane Biogas Capture

For capturing landfill biogas, perforated plastic pipes of about 15 cm diameter are installed in the landfill. They are packed in gravel and the pipe and the gravel are further enclosed in larger pipes (Figs. 8.7 and 8.8). This is done to prevent refuse from plugging the perforations. A network of such extraction wells are installed across the landfill. In a “passive” gas collection system (Fig. 8.7) no pumps are used, but in an “active” gas collection system they are (Fig. 8.8). Gas extraction can also be done by drilling boreholes in the landfill and installing extraction pipes.

The individual gas wells are connected by a series of pipes leading to larger pipes (Fig. 8.7) that deliver the gas to the processing and conversion stations. The entire piping system is under a partial vacuum created by blowers or fans at the processing station, causing landfill gas to migrate toward the wells.

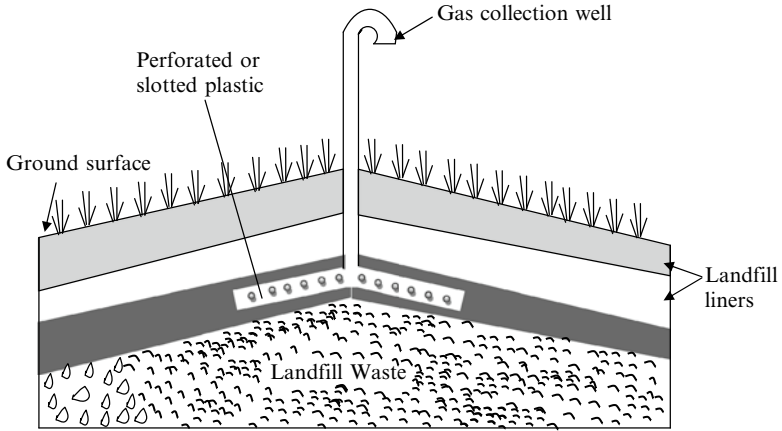

Fig. 8.7 A passive gas collection system in a landfill (adopted from USEPA 1996)

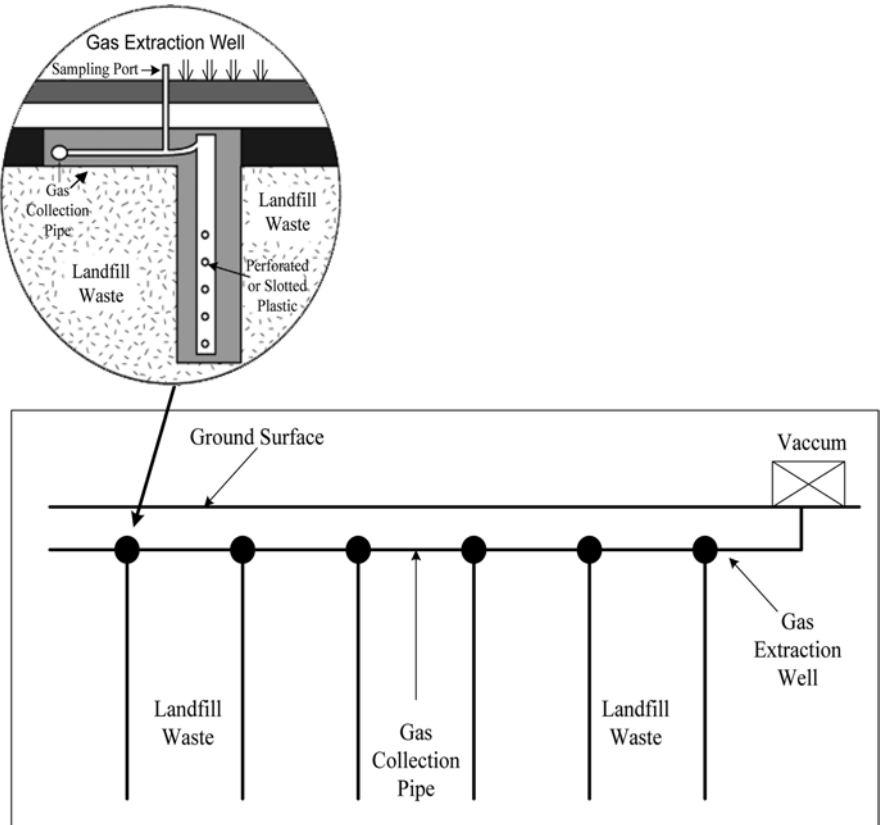

Fig. 8.8 Recovery of biogas from a sanitary landfill by an “active” gas collection system (adopted from USEPA 2011)

Once blowers or fans deliver the gas to a central point, it can be processed or converted to another energy form.

Before it can be put to use, the gas needs to be filtered to remove any particles and condensate that may be suspended in the gas stream. After moisture removal, additional gas processing may be done, including the use of refrigerators or absorbers, such as activated carbon filters, to remove trace contaminants by condensation and absorption, respectively. The steps involved in processing landfill gas typically consist of the following:

8.3.2.1 Removal of Carbon Dioxide

Removal of CO_2 enhances the energy density of the biogas. It also provides a consistent gas quality with respect to energy value. When the gas is to be used as transportation fuel, consistency of gas quality is of particular importance in achieving low emissions of nitrogen oxide.

At present, four different methods are used commercially to remove CO_2 from biogas either to make it utilizable as a vehicle fuel or make it suitable for injection to the natural gas grid. These methods are as follows:

- Water absorption
- Absorption by solvents such as selexol (a formulation of polyethylene glycol)
- Molecular sieves
- Membrane separation

Water scrubbing is used to remove CO_2 and H_2S from biogas since these gases are more soluble in water than is methane. Usually the biogas is pressurized and fed up the bottom of a packed column while water is sent down from the top. Hence the absorption process is operated counter-currently (Fig. 8.9). Water scrubbing can also be used for selective removal of H_2S since H_2S is more soluble than carbon dioxide in water.

Low-quality water, such as the one coming from sewage treatment plants, can be used for the scrubbing of CO_2 and H_2S . If cleaner water is utilized, it can be regenerated and re-circulated back to the absorption column.

Polyethylene glycol scrubbing relies on the same underlying mechanism as water scrubbing, with a physical absorption process that works because both CO_2 and H_2S are more soluble than methane in the solvent. The major difference between water and solvents is that CO_2 and H_2S are more soluble in the latter, which results in a lower solvent demand and reduced pumping. In addition, water and halogenated hydrocarbons (contaminants in biogas from landfills) are also removed when scrubbing biogas with solvents such as Selexol. Such scrubbing is always designed with recirculation.

Processes based on “molecular sieves” use special adsorptive materials such as zeolites and activated carbon which preferentially adsorb the target gas species at high pressure. The process then reverts to low pressure to reclaim the adsorbent material (Fig. 8.10).

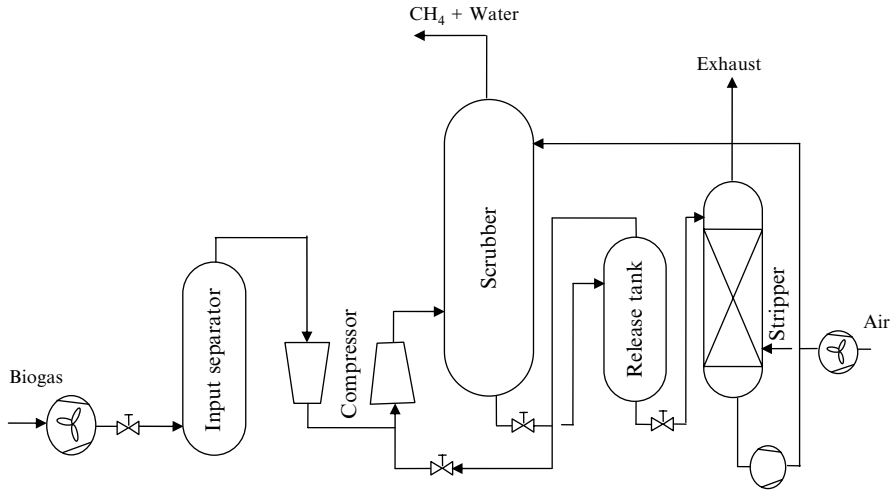

Fig. 8.9 Flow chart of a typical water scrubbing system (adopted from Kruger et al. 2010)

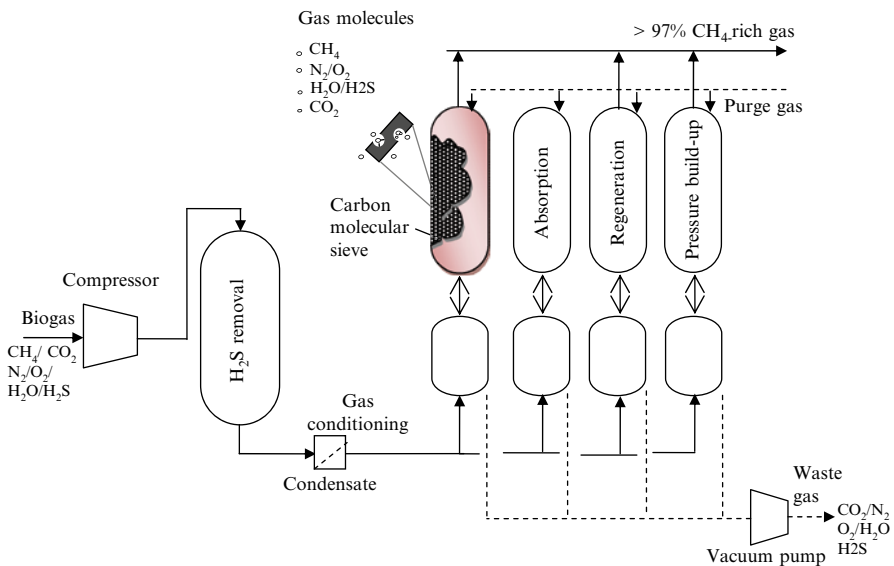

Fig. 8.10 Flow chart of a system based on molecular sieves (adopted from Kruger et al. 2010)

Membrane separation is based on the fact that when the raw gas is transported through a thin membrane some components pass through the membrane while others are retained. The extent of separation is a direct function of the chemical solubility of the target component in the membrane. Solid membranes can be constructed

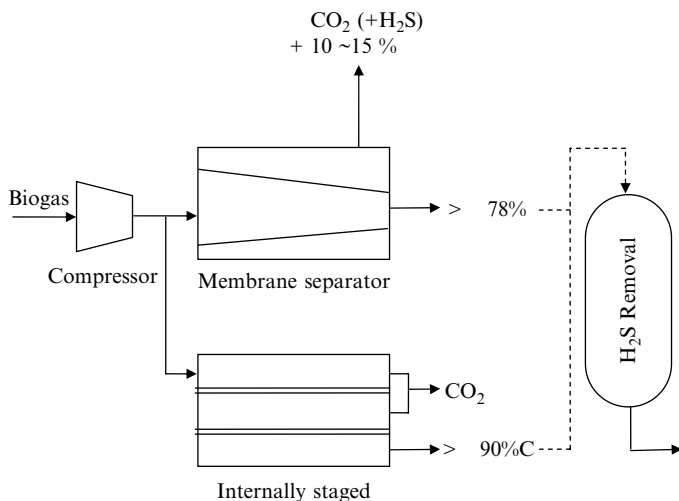

Fig. 8.11 A typical membrane-based biogas purification process (adopted from Kruger et al. 2010)

as hollow fibre modules or other structures which give a large membrane surface per volume and thus very compact units (Fig. 8.11). Typical operating pressures are in the range of 25–40 bars.

8.3.2.2 Removal of Oxygen and Nitrogen

Air may get sucked into biogas, enhancing its O_2 and N_2 content. This occurs quite often in landfills where the gas is collected through permeable tubes by applying a slight underpressure. Very low concentrations of oxygen do not pose a problem, but higher concentrations entail risk of explosion.

Oxygen and nitrogen can be removed by membranes or low temperature PSA but it is expensive. Preventing the introduction of air by carefully monitoring the oxygen concentration is far cheaper and more reliable route to keeping these gases away than the post-contamination clean-up.

8.3.2.3 Removal of Hydrogen Sulphide

Depending on the nature of the feed, varying concentrations of hydrogen sulphide (H_2S) are present in biogas. H_2S has to be removed in order to avoid corrosion in compressors, gas storage tanks, and engines. H_2S reacts with most metals; the reactivity is enhanced by concentration and pressure, the presence of water, and elevated temperatures. Due to the potential problems hydrogen sulphide can cause, it is best to remove it early in the process of biogas upgrading. Two of the most commonly used methods for H_2S removal are internal to the digestion process: (1) air/oxygen

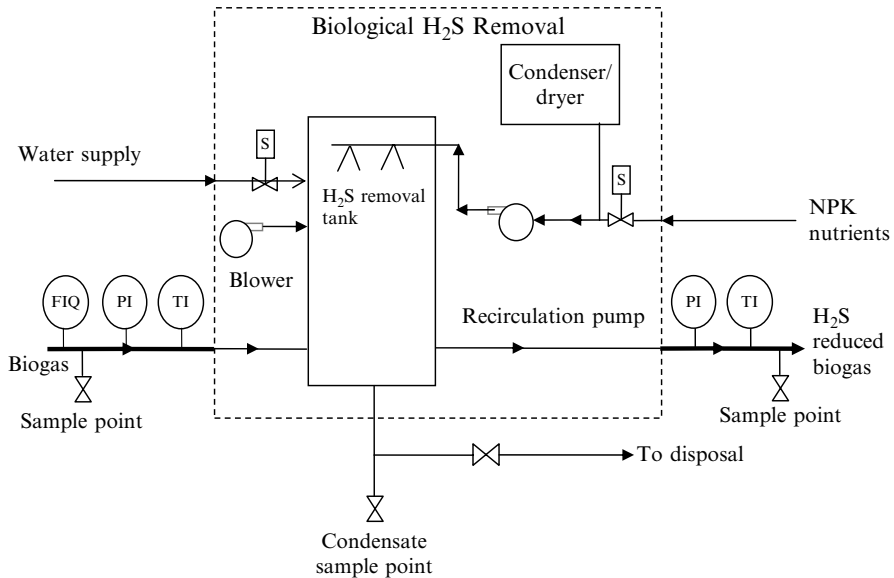

Fig. 8.12 A typical biofilter-based H₂S removal system (adopted from Soroushian et al. 2006)

dosing to digester biogas and (2) iron chloride dosing to digester slurry. The most common commercial methods for hydrogen sulphide removal are as follows:

- Air/oxygen dosing to digester biogas
- Iron chloride dosing to digester slurry
- Iron sponge
- Iron oxide pellets
- Activated carbon
- Water scrubbing
- NaOH scrubbing
- Air stripping and recovery
- Biological removal on a filter bed: the “biofilter”

These processes, except the last named, are similar to the ones described in the preceding sections. As for “biofilters”, they are widely employed for H₂S removal from biogas because in these systems chemical use is limited (Fig. 8.12). This makes them more economical and environment friendly than other options. The use of chemotropic bacterial species of *Thiobacillus* genus in such biofilters is well established. These bacteria have the ability to purify H₂S aerobically, as well as anaerobically. Most thiobacteria are autotrophic, consuming CO₂ and generating chemical energy from the oxidation of reduced inorganic compounds such as H₂S. These processes commonly produce SO₄²⁻ and S⁰ as waste products. On the other hand, some thiobacteria (i.e., *Thiobacillus novellus*, *Thiothrix nivea*) can grow either heterotrophically or autotrophically, having the capability of using available organic material as carbon source. Biogas, which contains in excess of 30% CO₂,

is a good source of inorganic carbon, rendering it suitable for autotrophic bacteria. Anaerobic phototrophic bacteria (*Cholorobium limicola*) has been explored for oxidizing H_2S in the presence of light and CO_2 but there is as yet no known commercial application based on the use of phototrophic bacteria.

8.3.2.4 Removal of Halogenated Hydrocarbons

Higher hydrocarbons as well as halogenated hydrocarbons, particularly chloro- and fluoro-compounds, occur in landfill gas (LFG). They cause corrosion in CHP engines, in the combustion chamber, at spark plugs, valves, cylinder heads, etc. Hence their removal becomes an essential part of LFG treatment.

They can be removed by pressurized tube exchangers filled with specific activated carbon. Small molecules like CH_4 , CO_2 , N_2 , and O_2 pass through while larger molecules are adsorbed. The size of the exchangers are designed to purify the gas during a period of more than 10 h. Usually there are two parallel vessels. One treats the gas while the other is used in desorption. Regeneration is carried out by heating the activated carbon to $200^\circ C$, a temperature at which all the adsorbed compounds are evaporated and removed by a flow of inert gas.

8.3.2.5 Removal of Siloxane

Organic silicon compounds are occasionally present in biogas which can cause severe damage to CHP engines. During incineration they are oxidized to silicon oxide which deposits at spark plugs, valves, and cylinder heads abrading the surfaces and eventually causing serious damage.

Siloxanes are removed by absorption in a liquid medium, a mixture of hydrocarbons with a special ability to absorb the silicon compounds. The absorbent is regenerated by heating and desorption.

8.3.3 Utilization Options

Internal combustion engines or turbines can be used to power on-site generators which convert the gas into electricity.

After the gas is converted to electricity, a dedicated line is used to deliver the electricity to utilities. The system may include metering equipment necessary to monitor sales and system protection equipment with emergency shutdown capability.

There are numerous other landfill gas utilization options (Fig. 8.13), of which space heating, process heating, and household gas utility supply are the most frequently exercised.

The gas yield of a landfill rises slowly till it reaches a peak in about 20 years. Thereafter, the gas production begins to decline (Fig. 8.14), and within a few years it ceases to be economically viable to capture methane from it.

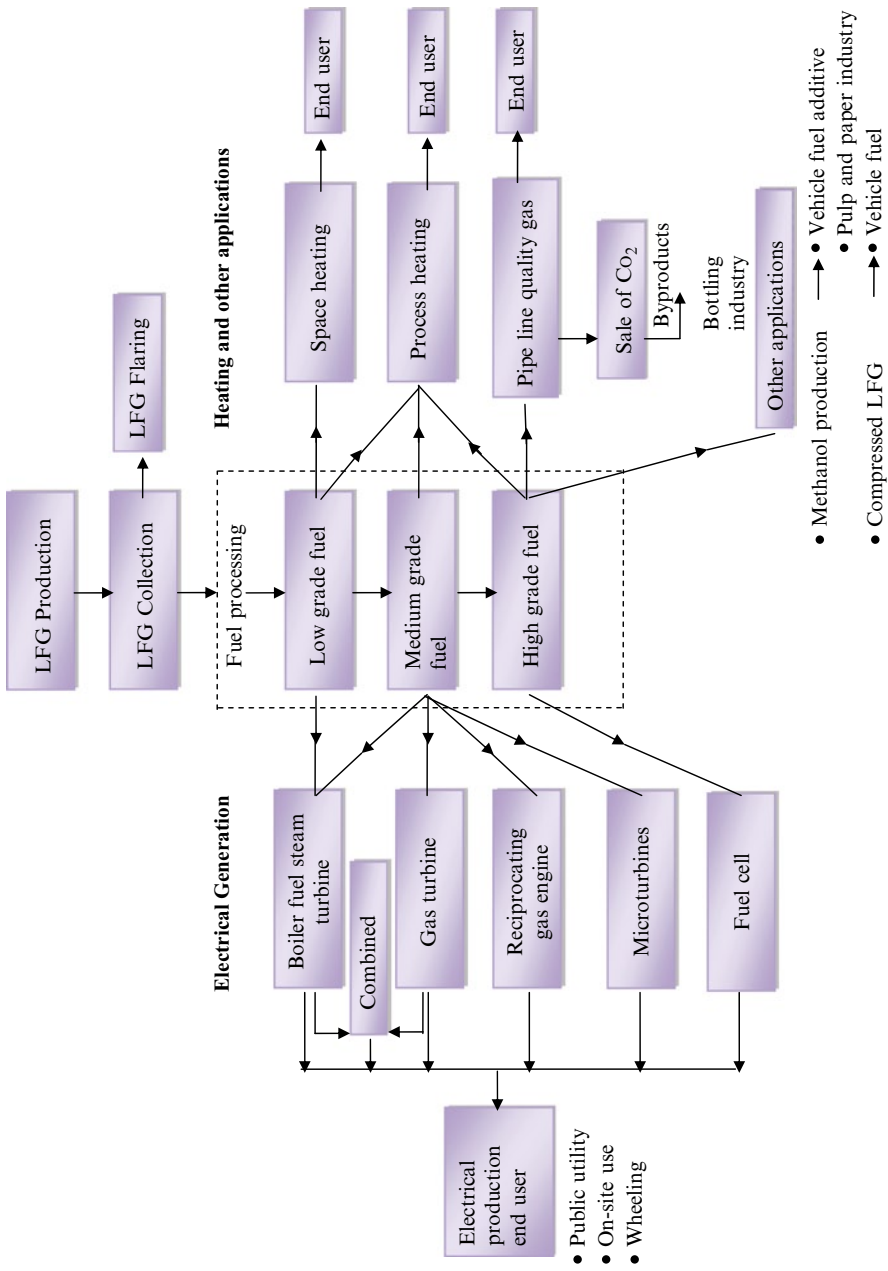

Fig. 8.13 LFG utilization options

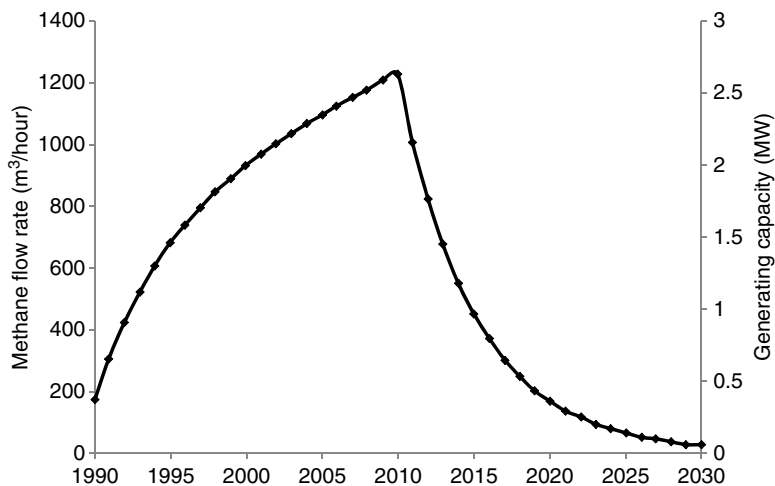

Fig. 8.14 Estimated methane generating capacity in the form of its electrical power equivalent based on a first-order decay model for a city producing 1,000 tonnes of MSW a day (adopted from IEA 2008)

8.4 LFG Capture in Developing Countries

As stated in Sect. 8.2, more and more developing countries are expected to shift to sanitary landfills from the present prevalent practice of unloading MSW in open dumps. Under certain conditions, anaerobic digestion does set in some parts of such dumps, leading to biogas (and methane) emissions but generally open dumps contribute much less to global warming than sanitary landfills do even as open dumps are injurious to environmental health in many other ways.

But once developing countries shift to sanitary landfills it will become a major priority to capture as much LFG as possible to reduce atmospheric discharge of methane.

An important factor determining the viability of LFG recovery projects is the way in which MSW is collected, sorted, and processed. In the rural areas, in developing countries, most of the solid waste is recycled, and the biodegradable material is used as animal feed or fertilizer for farms. But in urban areas the situation is the reverse; most of the MSW is dumped in open spaces. For example between 50–90% of the 42 million tonnes of urban waste produced in India each year is collected and dumped into uncontrolled open landfill sites without sorting, with the remainder left to decompose in streets and drains or dumped illegally in unmanaged sites. Around 50% of this MSW is biodegradable (Table 8.3). With the continued increase in the migration of rural population to urban areas, the volume of MSW in developing countries is likely to increase substantially in future (Zhu et al. 2007).

Due to a high proportion of food scraps, and the generally warm, and humid climate, the rate of MSW decomposition in most developing countries is faster than in landfills in developed countries. The rates of methane flow can therefore be

Table 8.4 Ten largest MSW-producing cities in India: broad estimates (adopted from FICCI 2011)

City	Waste generation (kg/cap/day)	Million tonnes per year	1,000 tonnes per day
Delhi	0.57	2.16	6.0
Greater Mumbai	0.45	1.95	5.4
Chennai	0.62	1.11	3.1
Kolkata	0.58	0.97	2.7
Hyderabad	0.57	0.80	2.2
Bangalore	0.39	0.61	1.7
Ahmedabad	0.37	0.48	1.3
Pune	0.46	0.43	1.2
Kanpur	0.43	0.40	1.1
Surat	0.41	0.37	1.0

expected to peak earlier than it does in developed countries, and afterwards rapidly decrease. Due to the high rate of MSW decomposition, only large landfill sites will be able to produce methane at a high level over a long period of time to be able to support a power generator.

The amount of LFG that will be emitted by a particular landfill is difficult to estimate and depends on many factors, including

- The history of MSW dumping (tonnes per day)
- MSW composition (fractions of fast, medium, and slow biodegradable content)
- The depth of the disposal site
- Climate, including average temperature and precipitation

If the pre-feasibility study estimates suggest that enough LFG will be produced, a pump test should be carried out to confirm the estimates. This involves drilling test wells in a limited area, monitoring the gas flow for a period of time and extrapolating the results for the whole waste disposal site.

Table 8.4 shows the total MSW produced per day from the ten largest cities in India. Recognizing that not all MSW is collected and dumped at landfill sites, a large percentage of all the waste would need to be collected and deposited at one central landfill to make the tenth largest city (Surat, 1,000 tonnes MSW/day) viable for an LFG-to-electricity project. Depending on the distribution of the landfill sites Delhi could potentially support 25 MW of new electrical generation capacity if managed appropriately (IEA 2008).

8.5 Risks Associated with Landfills

Soon after a sanitary landfill is laid out and capped, anaerobic digestion begins inside it. Within a few months biogas begins to form and the methane in it begins to move within the waste and out of landfill along with other component of biogas (mainly CO₂) and much lesser quantities of H₂S, mercaptans, and other volatile

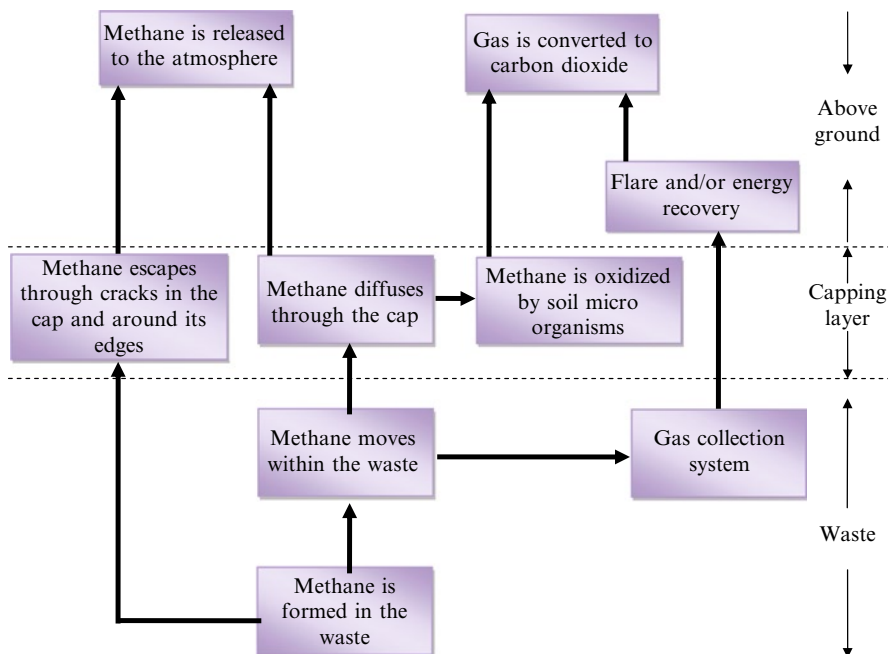

Fig. 8.15 Pathways through which methane is released from sanitary landfills

organic compounds (VOCs). The pathways through which landfill biogas (and methane) traverses are shown in Fig. 8.15.

The landfill gases (LFGs) pose flammability and toxicity hazards as detailed in the following section. Landfills also pose the risk of sudden bursts and pollution due to leachate as discussed in subsequent sections.

8.5.1 Flammability

Biogas is highly flammable; hence, landfills pose a risk of fire and explosion to people who supervise landfills as well as others living nearby.

Although landfill fires and explosions are by no means day-to-day occurrences, several accidents do have taken place as illustrated from the following cases (all pertaining to USA).

1967: A single storey building was destroyed, two people killed and two injured by a methane gas explosion at Atlanta, Georgia. The building had a basement which had been sealed by bricks except for a pipe which connected the basement to the rest of the building. Landfill gas escaping from the pipe was ignited possibly by a cigarette leading to the explosion.

1969: A gas explosion occurred in an armoury built close to a landfill site at Winston-Salem, North Carolina. The building was erected 7 years earlier when the site was operational, but about a week before the explosion extra material was deposited over the site and it is thought this caused the gas migration into the building. The explosion killed 3 people, and 25 were injured.

1975: In Sheridan, Colorado, landfill gas accumulated in a storm drain pipe that ran through a landfill. An explosion occurred when several children playing in the pipe lit a candle, resulting in serious injury to all the children.

1983: An explosion destroyed a residence across the street from a landfill in Cincinnati, Ohio.

1984: Landfill gas migrated to and destroyed one house near a landfill in Akron, Ohio. Ten houses had to be temporarily evacuated.

1987: Off-site gas migration is suspected to have caused a house to explode in Pittsburgh, Pennsylvania.

1994: A woman was seriously burned by a methane explosion while playing soccer in a park built over an old landfill in Charlotte, North Carolina.

1998: The Walt Disney World construction landfill at Orlando, Florida, where asbestos is buried, caught fire. Two nearby golf courses had to be closed because officials feared and that the smoke might be contaminated.

1999: An 8-year-old girl was burned on her arms and legs when playing in an Atlanta playground. The area was reportedly used as an illegal dumping ground many years ago.

2000: A house exploded in the middle of the night at Rochester Hills, Michigan, when gases migrated from the adjacent Six Star Landfill. The residents were able to escape, but their dog died in the explosion. Eleven other homes on the block had to be evacuated after methane gas was measured at high concentrations there.

2006: Spontaneous combustion is believed to have sparked a fire deep in the mountain of waste at Southwest developer's private construction and demolition landfill at Southern Charlotte County, Florida.

8.5.2 Toxicity

Landfill gas (LFG) contains volatile organic compounds (VOCs), of which several are toxic (Table 8.5). LFG also contains several other VOCs which are also toxic but only in very high doses (Table 8.6).

In large concentrations (i.e., above their “no adverse effect level” (NOAEL)) and with persistent exposure, VOCs can be highly damaging to the health of exposed humans and other animals. The extent of toxicity depends on the concentration that is absorbed into the body, and the duration of exposure.

Table 8.5 Potentially toxic VOCs in LFG (adopted from Sullivan et al. 2001)

Compound	No observed adverse-effect level	Possible toxic effects
Benzene	32 mg m ⁻³	Reduced foetal weight Retarded ossification
Tetrachloroethylene	2,000 mg m ⁻³	Embryolethality Foetotoxicity
Trichloroethylene	0.2 mg kg ⁻¹	Cardiac defects
Vinyl chloride	130 mg m ⁻³	Retarded ossification Male testicular effects Reduced male fertility
1,3-Butadiene	88 mg m ⁻³	Reduced foetal weight
Carbon disulphide	–	Uncertain malformations
Chloroform	147 mg m ^{-3a}	Reduced foetal weight; retarded ossification
1,2-Dichloroethylene	0.025 mg kg ^{-1a}	Cardiac defects
Ethylbenzene	430 mg m ^{-3a}	Embryolethal Foetotoxic Teratogenic
Formaldehyde	12 mg m ⁻³	Reduced foetal weight
Methyl chloride	525 mg m ⁻³	Cardiac defects
Alpha-terpinene	30 mg kg ⁻¹	Retarded ossification; skeletal anomalies
Dichlorobenzenes	1,200 mg m ⁻³	Reduced foetal weight; skeletal variants
2-Ethyl-1-hexanol	130 mg kg ⁻¹	Embryolethal; foetotoxic
Hydrogen sulphide	140 mg m ⁻³	Nausea, headaches
Methyl ethyl ketone	1,500 mg m ⁻³	Foetotoxic; teratogenic
Toluene	375 mg m ⁻³	Reduced foetal weight; retarded ossification; extra ribs
Xylenes	150 mg m ^{-3a}	Retarded ossification

^aLowest observed adverse-effect level (LOAEL)

Table 8.6 Other VOCs in LFG which are also toxic but in much higher doses (adopted from Sullivan et al. 2001)

Compound	No observed adverse-effect level	Possible toxic effects
Acetone	5,200 mg m ⁻³	Reduced foetal weight
2-Butanol	10,000 mg m ⁻³	Reduced foetal weight
Carbon tetrachloride	1,923 mg m ⁻³	Reduced foetal weight
Dichloromethane	5,300 mg m ⁻³	No effects observed
Ethanol	40 mg kg ⁻¹	Adverse human reproductive effects
Limonene	1,000 mg kg ^{-1a}	Foetotoxic; rib anomalies
1-Propanol	17,500 mg m ⁻³	Reduced foetal weight skeletal defects reduced male fertility
Styrene	1,147 mg kg ⁻¹	Maternal effects but no embryofoetal effects
Vinyl acetate	700 mg m ⁻³	Reduced foetal weight; retarded ossification

^aLowest observed adverse-effect level (LOAEL)

Table 8.7 Typical characteristics of landfill gas condensates (adopted from Knox 1990)

Component (parameter)	Plant/Flare		Gas field drains	
	Typical upper values	Typical lower values	Typical upper values	Typical lower values
pH	7.6	4.0	3.9	3.1
Conductivity	5,700	76	340	200
Chloride	73	1	4	<1
Ammoniacal N	850	<1	15	3
TOC	4,400	222	9,300	720
COD	14,000	804	4,600	4,600
BOD	8,800	446	2,900	2,900
Phenols	33	3	17	4
Total volatile acids	4,021	141	4,360	730

All values in mg L⁻¹ except pH (dimensionless) and conductivity (μs cm⁻¹)

LFG also gives rise to malodours which are experienced till hundreds of metres away from the site. They cause unpleasant sensations, and may trigger reflexes in the body that may be harmful. The following may result:

- Nausea
- Vomiting
- Headache
- Upsetting of stomach or appetite
- Upsetting of sleep
- Shallow breathing and coughing
- Decreased heart rate and constriction of blood vessels in skin and muscles
- Alteration of cells of the olfactory bulbs of the brain
- Irritation of eyes, nose, and throat
- Annoyance, anger, and depression
- A general decrease in well-being and enjoyment

Even when odours do not cause obvious discomfort, they still indicate that harmful odourless gases may also be present. Asthma attacks can be triggered by odorous conditions, as bronchial asthma has a hypersusceptibility to odours. Odours are also responsible for exacerbating a number of pre-existing medical problems.

8.5.3 Reducing the Health Effects of Landfill Gas

Up to an extent LFG can be captured and treated but it not only enhances the overall LFG costs but cannot eliminate the hazard because a sizeable fraction of LFG manages to evade capture. Moreover, once a landfill has gone past its brisk LFG production phase – which lasts for 15–20 years – LFG capture becomes increasingly uneconomical.

Flaring of landfill gas is a possible way to destroy VOCs but this can lead to the formation of dioxins which are more toxic than any of the VOCs listed in Tables 8.5 and 8.6 in the flare. The landfill gas condensates are also highly polluted (Table 8.7) and pose disposal problems.

From the foregoing it may be seen that sanitary landfills are perhaps environmentally less harmful than open dumps of MSW. But they are by no means an ideal solution for MSW disposal. Moreover, at best up to 60% of methane generated by any landfill can be captured, the rest 40–50% (often more) landfill methane escapes to the atmosphere. This makes landfills among the biggest contributors to anthropogenic global warming.

8.5.4 Risk of Leachate Pollution

Leachate is formed when water passes through the waste in the landfill cells. The water may have come from rain, run-off, or the waste itself. As water moves through the landfill many organic and inorganic compounds get associated with it in the leachate, which eventually reaches the base of the landfill and collects.

Whether the leachate will pollute the soil or groundwater would depend on whether the landfill lining is secure or not. In landfill sites which have been lined properly the leachate would not leak unless the liner tears.

The following factors affect the composition of landfill leachate:

- The type of waste material put into the landfill.
- Landfill conditions including the pH, temperature, moisture, and age.
- Quality of run-off entering the landfill.

Depending on the characteristics of the landfill and the waste it contains, the leachate may be relatively harmless or extremely toxic. Generally, leachate has a high biochemical oxygen demand (BOD) and high concentrations of organic carbon, nitrogen, chloride, iron, manganese, and phenols. Many other chemicals may be present, including pesticides, solvents, and other heavy metals.

The higher the concentration of contaminants in the leachate the higher its potential to pollute groundwater.

If the water-table is low (far below the ground surface), the leachate may get partially filtered in the course of percolation downward through the soil and the contamination may be lesser. If the water-table is high (close to the ground surface), contaminants can enter the groundwater directly, without filtration by soil, causing serious pollution.

Permeability of the ground below the landfill affects the rate of leachate escape. Sand has large pore spaces and so it allows greater groundwater flow. Clay is tightly packed and so prevents the movement of groundwater; it is also more effective at filtering out contaminants.

8.5.5 Methods of Leachate Disposal

8.5.5.1 Collection of Leachate

Leachate is collected from the bottom of modern landfills by a series of collection pipes installed into the base of the landfill. The leachate percolates through the

waste and into the pipes where it collects. The leachate can then be recycled or pumped out of the landfill and placed in storage areas or directly into the leachate treatment plant.

Leachate is a complex mix of refractory organics, metals and other inorganics, and micro-organisms. Leachate treatment is, accordingly, a complex, cumbersome, and costly endeavour.

8.5.5.2 Recycling of Leachate

This aspect has been discussed in more detail in the next section. For recycling the leachate is collected at the base of the landfill and instead of being sent away for treatment it is flushed back through the landfill waste many times. This increases the rate at which the waste material decomposes.

Recycling enhances landfill stabilization because rate of landfill gas production is increased due to the increased waste moisture content. It also provides a means of leachate disposal and reduces the volume of the leachate. But it may increase the rate of groundwater pollution if used in a landfill with single-composite-lining. It also increases the toxicity of the leachate by concentrating it.

The risk of groundwater pollution is low with a double-composite-lined landfill and so recycling is increasingly in practice in some landfill sites.

8.6 “Bioreactor” Landfills

Efforts to enhance the performance of sanitary landfills have led to the exploration of “bioreactor” landfills. In this approach landfills are sought to be operated as if they were fully controllable bioreactors. Microbial degradation is promoted by adding certain elements (nutrients, oxygen, or moisture) and controlling other elements (such as temperature or pH). There is provision for the recirculation of leachate (Fig. 8.16), so that micro-organisms, nutrients and water – all get recirculated. This increases the moisture content of the refuse in the landfill and, also promotes microbial degradation due to better nutrient availability and more brisk microbial action. If leachate recirculation alone cannot raise the moisture content to levels at which microbial growth is enhanced (40% by weight, minimum), water may have to be added to the waste.

It goes without saying that all these provisions and controls would enhance the cost of waste management and may not always be affordable. Nevertheless, if successful on large scale, bioreactor landfills may have the following advantage.

1. In a bioreactor landfill with leachate recirculation (Fig. 8.16), there is much faster degradation of the waste due to the continual flow of the leachate through the waste. The enhanced speed and degree of microbial degradation in a bioreactor landfill results in more of the organic matter in the waste being transformed into water and gases (including methane and carbon dioxide). Once no further degradation of the waste can occur, the refuse is said to be stabilized.

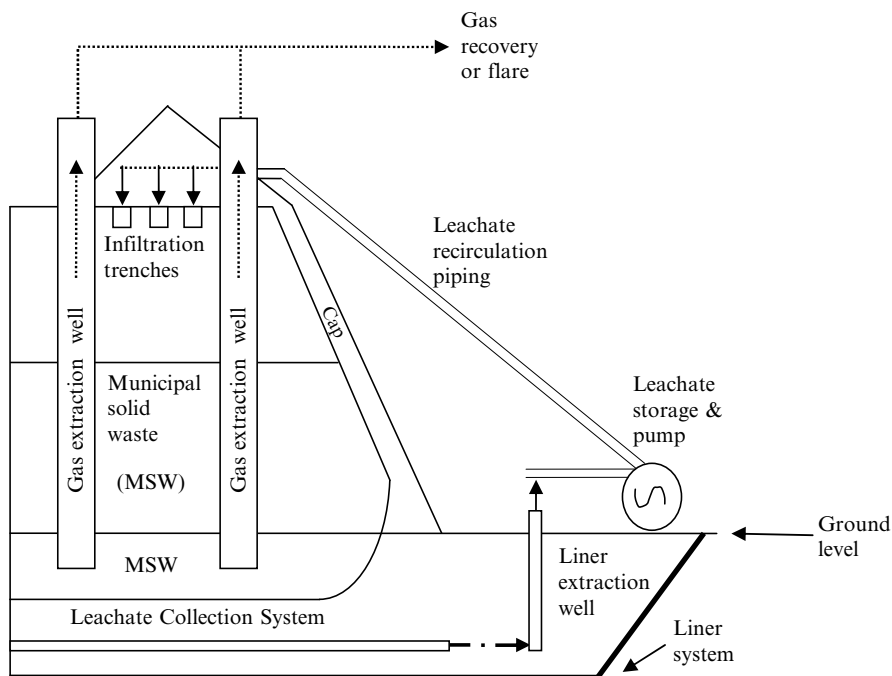

Fig. 8.16 Schematic of a bioreactor landfill using leachate recirculation (adopted from USEPA 1995)

In a sanitary landfill, stabilization may never occur, or it may take up to 100 years by some estimates. In a bioreactor landfill, stabilization should occur within 10 years or less. Because waste degradation results in the settling of the refuse as gas is released from the landfill, space becomes available within the landfill that can then be filled with more solid waste. The opportunity to add more waste extends the working life of the landfill and delays the need to construct new landfills.

2. The enhanced extent of degradation in a bioreactor landfill also speeds up the production of landfill gas and increases the total amount of gas produced. This makes it more economically feasible to use the methane generated within the landfill for heating or electricity generation. The better capture and use of the methane reduces the negative impact otherwise occurring due to emission.
3. Recirculating leachate through the waste partially remediates, or reduces the toxicity of, the leachate. Each time the leachate passes through the waste, compounds within the leachate are transformed by micro-organisms within the landfill, and the toxicity of the leachate is reduced. Once stabilized, the landfill poses less risk to the environment and community.

Laboratory studies had demonstrated the scientific feasibility of bioreactor landfill technology as early as the 1970s. Pilot- and full-scale experiments began to be conducted in the 1980s and 1990s. Research continues, and several full-scale trials are being conducted across the USA, but a full-scale “bioreactor” landfill is yet to come into operation.

References

- FICCI (2011) Current status of landfills in India. The Federation of Indian Chambers of Commerce and Industry (FICCI). <http://www.methanemarketsindia.com/sectors/landfills.htm#5>. Accessed 1 May 2011
- IEA (2008) Turning a liability into an asset: landfill methane utilisation potential in India. International Energy Agency, France
- Knox K (1990) The relationship between leachate and gas. In: International landfill gas conference: Energy and environment '90. Energy Technology Support Unit/Department of the Environment, Harwell, pp 367–386
- Kruger C, Yorgey G, Chen S, Collins H, Feise C, Frear C, Granatstein D, Higgins S, Huggins D, MacConnell C, Painter K, Stöckle C (2010) Climate friendly farming: improving the carbon footprint of agriculture in the Pacific Northwest. Report. CSANR Washington State University
- Soroushian F, Shang Y, Whitman EJ, Garza G, Zhang Z (2006) Development and application of biological H₂S scrubbers for treatment of digester gas. *Proc Water Environ Fed* 2006(9):3541–3547
- Sullivan FM, Barlow SM, McElhatton PR (2001) A review of the potential teratogenicity of substances emanating from landfill sites. Department of Health. <http://www.publications.doh.gov.uk/pdfs/landfillrep.pdf>. Accessed 1 May 2011
- USEPA (1995) Landfill bioreactor design and operation. United States Environmental Protection Agency, Office of Research and Development, Wilmington
- USEPA (1996) Turning a Liability into an asset: a landfill gas-to-energy project development handbook. US Environmental Protection Agency, Washington
- USEPA (2006) Global anthropogenic non-CO₂ greenhouse gas emissions: 1990–2020. U.S. Environmental Protection Agency. <http://www.epa.gov/nonco2/econ-inv/international.html>. Accessed 4 May 2011
- USEPA (2011) LFG collection system – Landfill methane outreach program. Environmental Protection Agency. <http://www.epa.gov/lmop/basic-info/lfg.html#04>. Accessed 1 May 2011
- Zhu D, Asnani PU, Zurbrugg C, Anapolsky S, Mani SK (2007) Improving municipal solid waste management in India: a sourcebook for policymakers and practitioners. The World Bank, Washington, DC, doi:10.1596/978-0-8213-7361-3